

EverFocus EQH5102 Mini Box Camera manual

<http://www.manuallib.com/everfocus/eqh5102-mini-box-camera-manual.html>

The EQH5102 is an HDcctv outdoor mini IR ball camera. Based on a progressive scan CMOS sensor, the camera provides 1080p high resolution images and superior video quality compared to traditional CCTV images. This superior resolution not only captures more critical evidentiary information, but the inherent ability for megapixel video also extends the area of coverage, expedites completion of investigations, resolves complaints and reduces both capital and operational costs.

ManualLib.com collects and classifies the global product instruction manuals to help users access anytime and anywhere, helping users make better use of products.

<http://www.manuallib.com>

HDCCTV

EQH5102 1080p Mini Box Camera

User's Manual



**** Lens not included.**

 **EverFocus**

Copyright © EverFocus Electronics Corp,

Release Date: July, 2012

Precautions

Please read this manual first to ensure correct installation and operation. This manual should be retained for future reference. The information in this manual was current when published. The manufacturer reserves the right to revise and improve its products. All specifications are therefore subject to change without notice.

1. Do not install the camera near electric or magnetic fields.

Install the camera away from TV / radio transmitters, magnets, electric motors, transformers and audio speakers, because the electromagnetic fields generated by these devices may distort the video image or otherwise interfere with camera functions.

2. Never disassemble the camera beyond the recommendations in this manual, nor apply materials to it other than those recommended herein.

Improper disassembly or introduction of corrosive materials may result in equipment failure or other damage.

3. Try to avoid pointing the camera toward the sun.

In some circumstances, direct sunlight may cause permanent damage to the sensor and / or internal circuits. It may also create unbalanced illumination that may be beyond the camera's ability to compensate.

4. Keep the power cable away from water and other liquids. Never touch the power cable with wet hands.

Touching a wet power cable with your hands or touching the power cable with wet hands may result in electric shock.

5. Never install the camera in areas exposed to oil, gas or solvents.

Oil, gas or solvents may cause equipment failure, electric shock or, in extreme cases, fire.

6. Cleaning

For cameras with interchangeable lenses, do not touch the surface of the sensor directly with your hands. Use lens tissue or a cotton tipped applicator and ethanol to clean the sensor and the camera lens. Use a damp soft cloth to remove any dirt from the camera body. Do not use complex solvents, or corrosive or abrasive agents to clean any part of the camera.

7. Do not operate the camera beyond the specified temperature, humidity and power source levels. This camera is suitable for indoor operation only.

Use the camera at temperatures within 0°C ~ 45°C (32°F ~ 113°F) and humidity between 20 ~ 80%; this device is not rated as submersible. The input power source should be 12VDC. **The use of a properly fused or "Class 2 Limited Power Source" power supply is highly recommended.**

8. Mounting

Select a solid mounting surface that will support the weight of the camera and any additional loading from wind, snow, ice or other factors. Securely attach the camera to the mounting surface using screws and anchors that will properly support the camera. If necessary, (e.g. when mounting the camera to a drop ceiling, or unsupported ceiling) use a safety wire to provide additional support for the camera.

Safety Notice

Federal Communication Commission Interference Statement

This equipment has been tested and found to comply with the limits for a Class A digital device, pursuant to Part 15 of the FCC Rules. These limits are designed to provide reasonable protection against harmful interference in a residential installation. This equipment generates uses and can radiate radio frequency energy and, if not installed and used in accordance with the instructions, may cause harmful interference to radio communications. However, there is no guarantee that interference will not occur in a particular installation. If this equipment does cause harmful interference to radio or television reception, which can be determined by turning the equipment off and on, the user is encouraged to try to correct the interference by one of the following measures:

- Reorient or relocate the receiving antenna.
- Increase the separation between the equipment and receiver.
- Connect the equipment into an outlet on a circuit different from that to which the receiver is connected.
- Consult the dealer or an experienced radio/TV technician for help.

FCC Caution: Any changes or modifications not expressly approved by the party responsible for compliance could void the user's authority to operate this equipment.

This device complies with Part 15 of the FCC Rules. Operation is subject to the following two conditions: (1) This device may not cause harmful interference, and (2) this device must accept any interference received, including interference that may cause undesired operation.



ATTENTION! This is a class A product which may cause radio interference in a domestic environment; in this case, the user may be urged to take adequate measures.



This Product is RoHS compliant.



WEEE

Your EverFocus product is designed and manufactured with high quality materials and components which can be recycled and reused. This symbol means that electrical and electronic equipment, at their end-of-life, should be disposed of separately from your household waste. Please, dispose of this equipment at your local community waste collection/recycling centre. In the European Union there are separate collection systems for used electrical and electronic product.

Please, help us to conserve the environment we live in!

Contents

1. INTRODUCTION	1
1.1 PACKING LIST	1
1.2 FEATURES	1
2. OVERVIEW	2
3. INSTALLATION	2
3.1 LENS INSTALLATION AND ADJUSTMENT	2
3.2 TOP / BOTTOM-MOUNT	3
4. BASIC CONNECTION	3
5. CONFIGURATION IN THE OSD MENU	3
5.1.1 EXPOSURE	4
6. SPECIFICATIONS	10
7. APPENDIX	11
7.1 OSD MENU STRUCTURE	11

1. Introduction

The EQH5102 is an HDcctv indoor mini box camera. Based on a progressive scan CMOS sensor for HD 1080p resolution 100% digital images, it delivers vastly superior video quality compared to traditional CCTV images. This superior resolution not only captures more critical evidentiary information, but the inherent ability for megapixel video also extends the area of coverage, expedites completion of investigations, resolves complaints and reduces both capital and operational costs.

No major upgrade to the IT network is required to deploy this powerful technology; HDcctv cameras communicate at digital speeds up to 1.5 Gb/s over existing or new coaxial cable (RG59 or other types for longer distances), using industry standard BNC connectors.

The EQH5102 allows flexible choices of megapixel manual & DC iris control lenses with C / CS mount for outstanding coverage in a wide range of demanding surveillance environments while delivering stunning HD image quality.

1.1 Packing List

- Camera body x 1
- Power Pigtail Cable x 1
- User Manual x 1
- Lens Cover x1
- C-mount lens adapter x 1

1.2 Features

- Real time HDcctv 1080p HD video over coax for superlative image detail
- 1/3" 2.1 megapixel Color Progressive CMOS sensor
- CS/C mount, manual and DC iris control for flexible choice of HD Megapixel lenses
- Provides 3D DNR/ DSS to improve image clarity, particularly in low light scenes
- Electronic Lens Shading Compensation to offset diminished light transmission through lens periphery for uniform image illumination
- CTB [Contrast Boost] to deliver properly exposed images despite bright light sources, deep shadows and/or unbalanced lighting in the same scene
- Supports Digital Zoom/ BLC [Back Light Compensation]/ HSMASK [Highlight Suppression Mask]/ Privacy Zones (up to 32)
- DPC [Defect Pixel Correction] Dead pixel compensation for increased clarity and extended service life
- SD TV Out for aim and focus using a standard hand held test monitor

2. Overview

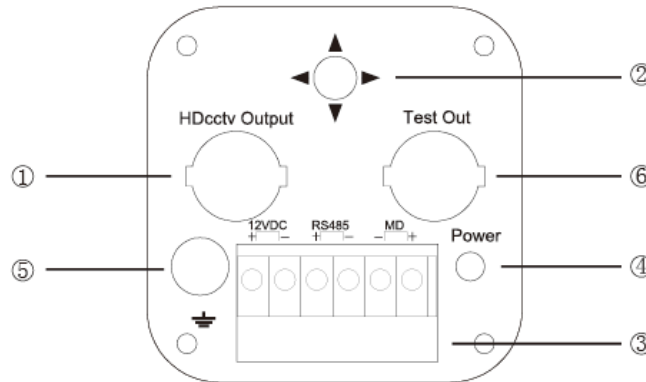

No.	Name	Descriptions
1	HDcctv Output	Connects to a HD device using a 75 Ohm BNC-type coaxial cable.
2	OSD Menu Joystick	Use the joystick to configure the settings in the OSD menu.
3	Screwless Terminal Strip	Connects to a 12VDC power, RS-485 and MD (Motion Detect) source.
4	Power LED	Glows red then power is present.
5	Grounding Stud	Ensuring a good grounding when used.
6	Test-Out	Connects to a SD CVBS monitor for setting image aim and focus.

3. Installation

3.1 Lens Installation and Adjustment

You can install either a CS-mount or a C-mount lens into the camera. It is recommended to use a lens with aperture ratio of F/1.2 or lower. Please refer to the following reference steps.

CS-Mount Lens:

1. Remove the cover cap from the camera body.
2. Install the lens into the camera body.
3. Adjust the lens using the Focus / Zoom Screws.

If you are using a **DC Auto Iris lens**:

1. Remove the cover cap from the camera body.
2. Install the lens into the camera body.
3. Connect the DC cable to the DC Auto Iris Lens Connector.
4. Lock the Focus Screw.

C-Mount Lens:

1. Remove the cover cap from the camera body.
2. Install the lens into the camera body using the supplied C-mount lens adapter.
3. Adjust the lens using the Focus / Zoom Screws.

Warning: Installing a C-mount lens without the C-mount lens adapter may damage the camera sensor.

3.2 Top / Bottom-Mount

You can use a mounting bracket and screw it on the top of the camera body to suspend the camera, or on the bottom of the camera body to support the camera.

4. Basic Connection

1. Connect the camera to an HD device, such as an HDcctv DVR, to display the image.
2. Connect the camera to a 12VDC power source using the supplied Power Cable. You can optionally use the supplied Power Pigtail Cable or a power adapter to connect the Power Cable to the power source. The power LED will be lit in red.
3. Connect the camera to a CVBS portable monitor for setting image aim and focus before mounting the camera.

5. Configuration in the OSD Menu

You can use the Joystick on the rear panel of the camera to configure camera settings in the OSD menu. For details on the OSD menu structure, see *OSD Menu Structure* in *Appendix*.

5.1 OSD Menu

Press the **Enter / Confirm** button on the Joystick. The Setup Menu in the OSD appears.

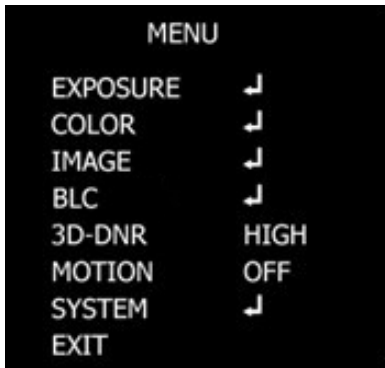

5.1.1 EXPOSURE

Press the **Enter / Confirm** button to enter the submenu.

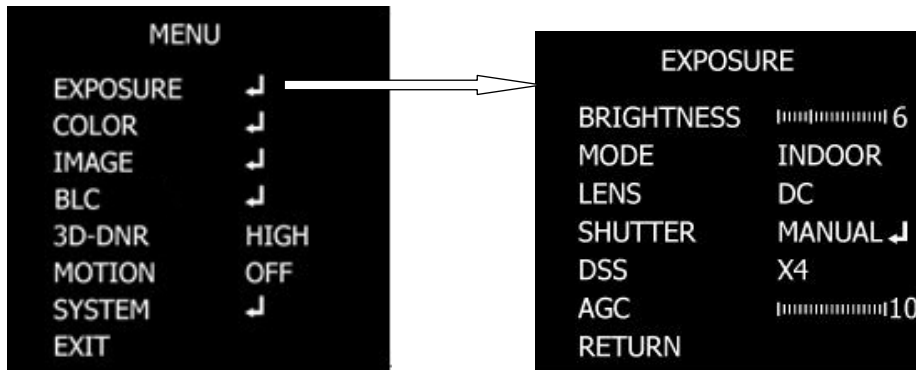

BRIGHTNESS

Use the ◀ and ▶ buttons to increase or decrease the screen brightness from 0 to 20.

MODE

Indoor

Select this mode when the color temperature of the video image is similar to that found in indoor environments (around 5100 to 5300°K).

Outdoor

Select this mode when the color temperature of the video image is similar to that found in outdoor environments (around 3,000°K to 3,200°K)

LENS

You can select the type of the lens. Two types are available: Manual and DC. By default, the DC type lens is selected.

Shutter

Use the ◀ and ▶ buttons to adjust the shutter speed. The options include: 1/25 ~ 1/60000, FLK, and AUTO. Any selection other than AUTO and 1/25 will disable the DSS function.

DSS (Digital Slow Shutter)

DSS is used to maintain a vivid screen image by automatically boosting low light levels. The value is between x2 ~ X4 and OFF.

AGC (Auto Gain Control)

The higher the AGC value, the brighter the screen, but the level of noise will also be increased. The options include: 0~10.

5.1.2 COLOR

Press the **Enter / Confirm** button to enter the submenu.

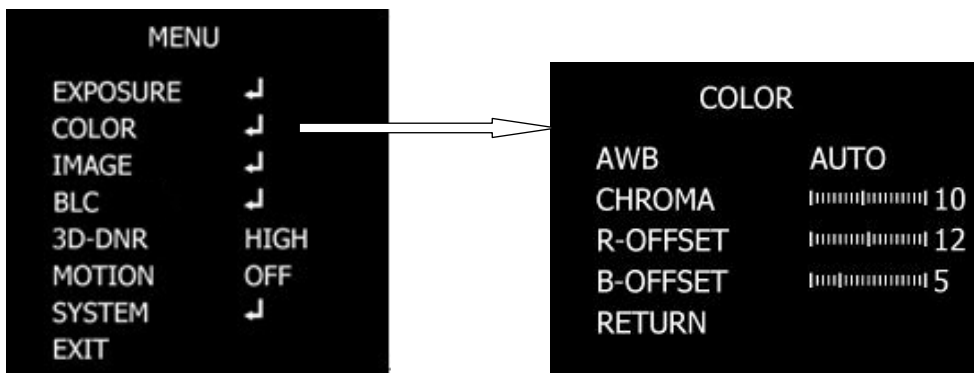

AWB (Auto White Balance)

This mode can be used to view areas with a color temperature range. Use the ◀ and ▶ buttons to select the AWB options. The options include: AUTO, AUTO EXTN, PRESET, MANUAL COLOR TEMP, R-GAIN and B-GAIN.

- AUTO – Around 2500 to 9500°K
- AUTO EXTN (Extension) – Around 2300 to 10800°K
- PRESET – Use a pure white background to preset the white balance value.
- MANUAL COLOR TEMP – Use the ◀ and ▶ buttons to adjust the speed. The options include: LOW, MIDDLE and HIGH
- R-GAIN and B-GAIN –The options include: 0~20.

CHROMA

Use the ◀ and ▶ buttons to increase or decrease the CHROMA from 0 to 20.

R-OFFSET/B-OFFSET

Use the ◀ and ▶ buttons to increase or decrease the Red and Blue offset from 0 to 20.

5.1.3 IMAGE

Press the **Enter / Confirm** button to enter the submenu.

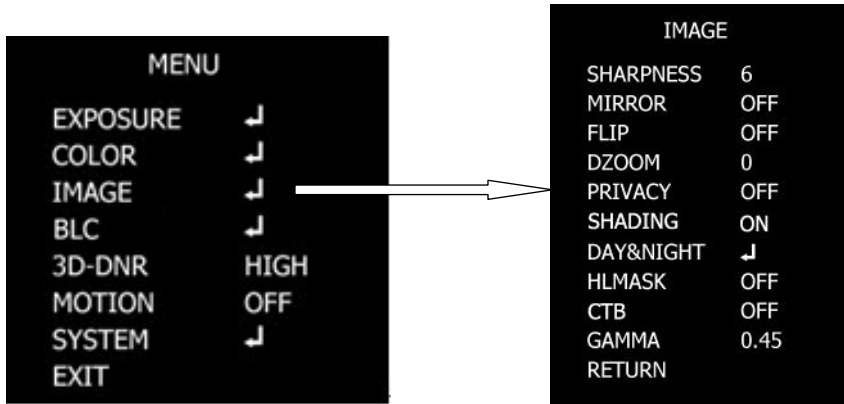

SHARPNESS

Use the ◀ and ▶ buttons to increase or decrease the SHARPNESS from 0 to 10.

MIRROR/FLIP

Turn it on to reverse/ flip the image.

DZOOM

Turn it on to set up the zoom level

PRIVACY

Enter the submenu to set up the privacy masks; up to 31 zones can be created:

ON ZONE NO: Use the ◀ and ▶ buttons to select the zone from 0 to 31.

X, Y-POS, SIZ: Enter the submenu to set up the position or size of the privacy mask zone.

COLOR: Press to select a color for the selected privacy mask zone.

TRANS: Press to select the transparency of mask zone.

SHADING

Turn it on to offset diminished light transmission through lens periphery for uniform image

illumination.

DAY&NIGHT

The options include MODE, AGC THRS, DELAY. A submenu can be entered if you select MODE.

- **MODE** – Use the ◀ and ▶ buttons to select AUTO, COLOR and B&W. Switches to a B&W feed in low light conditions and then switches back to a Color feed in the daytime.
- **AGC THRS** –Use the ◀ and ▶ buttons to select the AGC Threshold from 0 to 20.
- **DELAY** – Set up the delay time in 0,5,10 and 30 seconds for the camera to switch between Day and Night.

HLMASK

Turn it on to select the level and color of the masking effect.

CTB (Contrast Boost)

Turn it on to deliver properly exposed images despite bright light sources, deep shadows and/or unbalanced lighting in the same scene.

GAMMA

Use the ◀ and ▶ buttons to increase or decrease the GAMMA from 0.45 to 0.75.

5.1.4 BLC

Press the **Enter / Confirm** button to enter the submenu.

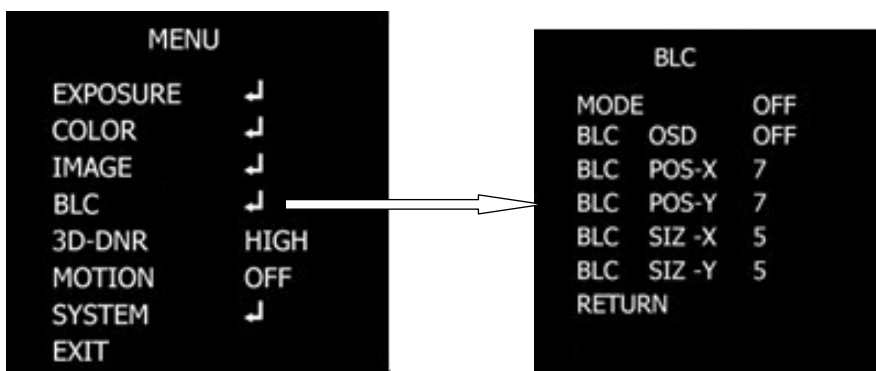

MODE

Use the ◀ and ▶ buttons to select OFF and BLC.

BLC OSD, POS and SIZ

Select OFF to disable the BLC function, or select ON to enable the BLC function and for further setup. After selecting an area block, enter the BLC POS / SIZ and X/ Y setup page, a “POSITION” sign displayed on the screen. Use the direction buttons to move the area to the desired position. Press the **Enter / Confirm** button to confirm the position, a “SIZE” sign displayed on the screen. Use the direction buttons to adjust the size for the area.

5.1.5 3D-DNR

Press the **Enter / Confirm** button to enter the submenu.

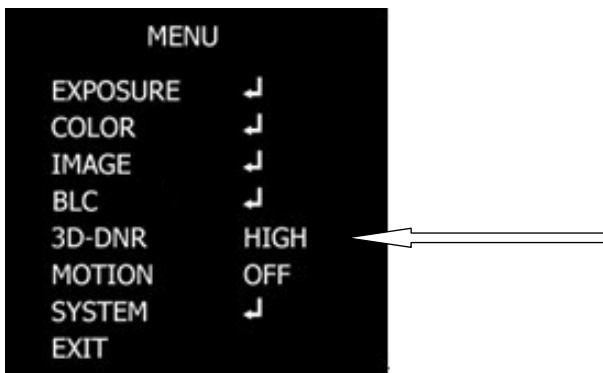

Switch to HIGH, MIDDLE, LOW and OFF to enable or disable noise reduction on dynamic recordings.

5.1.6 MOTION

Press the **Enter / Confirm** button to enter the submenu.

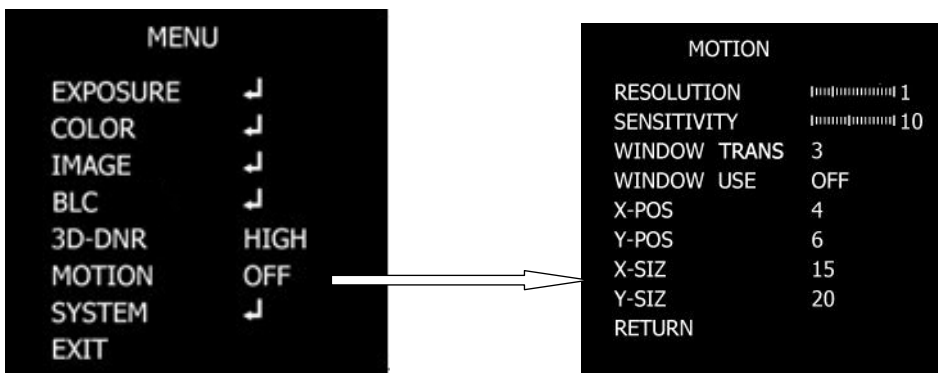

RESOLUTION

Use the ◀ and ▶ buttons to increase or decrease the RESOLUTION level from 0 to 4.

SENSITIVITY

Press to set up the sensitivity for the motion detection function.

WINDOW TRANS

Press to select the transparency of motion detect zone.

WINDOW USE, POS and SIZ

Select OFF to disable this function, or select ON to enable and for further setup. After selecting an area block, enter the BLC POS / SIZ and X/ Y setup page, a “POSITION” sign displayed on the screen. Use the direction buttons to move the area to the desired position. Press the **Enter / Confirm** button to confirm the position, a “SIZE” sign displayed on the screen. Use the direction buttons to adjust the size for the area.

5.1.7 SYSTEM

Press the **Enter / Confirm** button to enter the submenu.

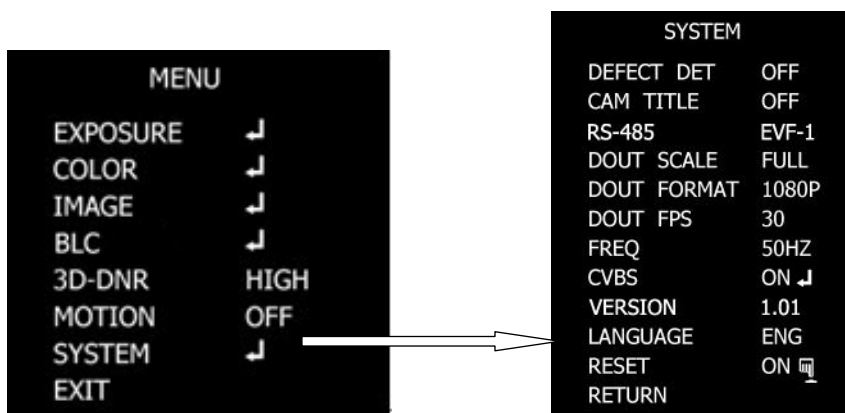

DEFECT DET

Press to select the DPC (Defective Pixel Correction) level of defect detector. Please notice; do not use this function without cover the lens. The camera will automatically correct pixel defects. Misoperation will cause the abnormal image.

CAM TITLE

Switch to On and then enter the submenu to set up a camera name displayed on the screen.

RS-485

Use the ◀ and ▶ buttons to select ID, BAUDRATE, PROTOCOL and ID DISPLAY. The default of protocol is EVF-1 (EverFocus).

Version

Press to display the firmware version of the camera.

DOUT

There are 4 options including 1080p 30FPS NTSC, 1080p 25FPS PAL, 720p 60FPS NTSC and 720p 50FPS PAL

Language

Select a language for the OSD text. Options include English, French, German, Simplified Chinese, Korean and Japanese.

6. Specifications

Camera	
Pickup Device	1/3" Panasonic 2.1 megapixel Color Progressive CMOS sensor
Image Pixels	1920(H) x 1080(V)
Resolution	Digital:1080p(30/25), 720p(60/50)
Sensitivity	Color: 0.4 lux, BW: 0.1 lux, Color DSS: 0.1 lux, BW DSS: 0.025 lux
Video Output	Digital(HDcctv Output): BT.1120, HDcctv/HD-SDI: BNC connector Analogue(Test Out): NTSC/PAL CVBS(w/o WDR): BNC connector
S/N Ratio	More than 50 dB (AGC OFF)
Lens	DC/Manual
AGC	0-20 steps
Shutter Speed	AUTO/MANUAL(1/25(30)~1/60,000sec)

Digital Slow Shutter(DSS)	On/Off(x4)
Brightness	0-20
BLC	On/Off
Contrast Boost(CTB)	On/Off
Day&Night	Auto/Color/B&W
Auto White Balance	Auto/Auto extn/Preset/Manual
Digital Noise Reduction(DNR)	Off/Low/Middle/High
Mirror	On/Off
Flip	On/Off
Sharpness	0 - 10 steps
Lens Shading Compensation	On/Off
Digital Zoom	0 - 96 steps
Privacy Mask	32 Zones, Programmable
Motion Detection	On/Off (Switth Output, Screwless terminal connector)
RS - 485	2400~115200> baud, ID 1~255, Protocols: Pelco-D/P, EverFocus EVF-1; Screwless terminal connector
Language	English /French /German /Chinese /Korean /Japanese /Russian
Power Source	12VDC, Screwless terminal connector
Power Comsumption	12VDC: 220mA max.
Operating Environment	0°C~45°C/32°F~113°F (20%~80% Humidity)
Dimensions(L x W x H)	89 x 46 x 48mm /3.5" x1.8" x1.9"
Weight	0.193kg/0.434lbs
Certifications	FCC / CE

7. Appendix

7.1 OSD Menu Structure

The default value is marked with a star "*".

No	Main	Sub Menu	Sub Menu / Function
1	EXPOSURE	BRIGHTNESS	1~20 (default=6)
		MODE	INDOOR*, OUTDOOR
		LENS	MANUAL, DC*

		SHUTTER	AUTO*			
			MANUAL	1/25~1/60000		
			FLK			
		DSS	OFF, X2, X3, X4*			
		AGC	0~10 (default=10)			
2	COLOR	AWB	AUTO*			
			AUTO extn			
			PRESET			
			MANUAL COLOR TEMP	LOW, MIDDLE, HIGH		
			R-GAIN	0~20		
			B-GAIN	0~20		
		CHROMA	0~20 (default=7)			
		R-OFFSET	0~20 (default=12)			
		B-OFFSET	0~20 (default=5)			
3	IMAGE	SHARPNESS	0~10 (default=6)			
		MIRROR	ON, OFF*			
		FLIP	ON, OFF*			
		D-ZOOM	0~96 (default=0)			
		PRIVACY	OFF*			
			ON ZONE NO	0~31		
			ZONE UP	ON, OFF		
			X-POS	0~60		
			Y-POS	0~40		
			X-SIZ	0~60		
			Y-SIZ	0~40		
			COLOR			
			TRANS	0~4		
		SHADING	ON*, OFF			
		DAY&NIGHT	MODE	AUTO*		
				COLOR		
				B&W		
			AGC THRS	0~20 (default=10)		
			MARGIN	0~20 (default=)		
		DELAY	0, 5*, 10, 30 SEC			
		HLMASK	OFF*			
			ON	LEVEL	0~20 (default=10)	
				COLOR	BLK*/WHT/YEL/CYN/GRN/MAG/RED/BLU	

		CTB	ON, OFF*		
		GAMMA	0.45*, 0.5, 0.55, 0.65, 0.75		
4	BLC	MODE	OFF*, BLC		
		BLC OSD	ON, OFF*		
		BLC POS-X	0~20 (default=7)		
		BLC POS-Y	0~20 (default=7)		
		BLC SIZ-X	0~20 (default=5)		
		BLC SIZ-Y	0~20 (default=5)		
5	3D-DNR	HIGH, MIDDLE*, LOW, OFF			
6	MOTION	OFF*			
		ON	RESOLUTION	0~4 (default=1)	
			SENSITIVITY	0~20 (default=10)	
			WINDOW TRANS	0~6 (default=3)	
			WINDOW USE	ON, OFF*	
			X-POS	0~60 (default=4)	
			Y-POS	0~40 (default=6)	
			X-SIZ	0~60 (default=15)	
Y-SIZ	0~40 (default=20)				
7	SYSTEM	DEFECT DET	DPC LEVEL	000~255 (default=26)	
		CAM TITLE	OFF*		
			ON	STRING SET	
				POSITION	
		RS-485	ID	1~255 (default=1)	
			BAUDRATE	2400, 4800, 9600*, 19200, 38400, 57600, 115200	
			PROTOCOL	PELCO-D, PELCO-P, EVF-1*	
			ID DISPLAY	ON, OFF	
		DOUT SCALE	FULL*, COMP		
		DOUT FORMAT	720P, 1080P*		
		DOUT FPS	50, 60, 25*, 30		
		FREQ	50*, 60 HZ		
		CVB	PAL*, NTSC		
		LANGUAGE	English*, Chinese, Japanese, Korean, French, German, Russian		
RESET	PUSH, PUSHING				

EverFocus Electronics Corp.

EverFocus Taiwan:

12F, No.79, Sec. 1, Shin-Tai Wu Road,
Hsi-Chih, Taipei, Taiwan
TEL: +886 2 2698 2334
FAX: +886 2 2698 2380
www.everfocus.com.tw
marketing@everfocus.com.tw

EverFocus China - Beijing:

Room 609, Technology Trade Building,
Shangdi Information Industry Base,
Haidian District, Beijing 100085, China
TEL: +86 10 6297 3336~39
FAX: +86 10 6297 1423
www.everfocus.com.cn
marketing@everfocus.com.cn

EverFocus USA - California:

1801 Highland Avenue, Unit A, Duarte, CA 91010,
USA
TEL: +1 626 844 8888
FAX: +1 626 844 8838
www.everfocus.com
sales@everfocus.com

EverFocus Japan:

5F, Kinshicho City Building, 2-13-4
Koto-Bashi, Sumida-Ku, Tokyo, 130-0022, Japan
TEL: +81 3 5625 8188
FAX: +81 3 5625 8189
www.everfocus.co.jp
info@everfocus.co.jp

EverFocus India:

Suite 803, Housefin Bhavan, C-21, Bandra Kurla
Complex, Bandra (East), Mumbai 400051, India
TEL: +91 22 6128 8700
FAX: +91 22 6128 8705
www.everfocus.in
sales@everfocus.in

EverFocus Europe - Germany:

Albert-Einstein-Strasse 1, D-46446
Emmerich, Germany
TEL: +49 2822 93940
FAX: +49 2822 939495
www.everfocus.de
info@everfocus.de

EverFocus China - Shenzhen:

4F, No. 2, D4 Building, Wan Yelong
Industrial Park, Tangtou Road, Shiyuan,
Baoan, Shenzhen, Guangdong 518101, China
TEL: +86 755 2765 1313
FAX: +86 755 2765 0337
www.everfocus.com.cn
marketing@everfocus.com.cn

EverFocus USA - New York:

415 Oser Avenue, Unit S, Hauppauge, NY 11788, USA
TEL: +1 631 436 5070
FAX: +1 631 436 5027
www.everfocus.com
sales@everfocus.com

EverFocus Europe - UK:

Unit 12, Spitfire Business Park,
Hawker Road, Croydon Surrey, CR0 4WD, UK
TEL: +44 20 8649 9757 / +44 845 430 9999
FAX: +44 20 8649 9907
www.everfocusuk.co.uk
salesuk@everfocus.com



Your EverFocus product is designed and manufactured with high quality materials and components which can be recycled and reused. This symbol means that electrical and electronic equipment, at their end-of-life, should be disposed of separately from your household waste. Please, dispose of this equipment at your local community waste collection/recycling centre. In the European Union there are separate collection systems for used electrical and electronic product. Please, help us to conserve the environment we live in!

Ihr EverFocus Produkt wurde entwickelt und hergestellt mit qualitativ hochwertigen Materialien und Komponenten, die recycelt und wieder verwendet werden können. Dieses Symbol bedeutet, dass elektrische und elektronische Geräte am Ende ihrer Nutzungsdauer vom Hausmüll getrennt entsorgt werden sollen. Bitte entsorgen Sie dieses Gerät bei Ihrer örtlichen kommunalen Sammelstelle oder im Recycling Centre. Helfen Sie uns bitte, die Umwelt zu erhalten, in der wir leben!



N