

NXP SA58670 audio amplifier Datasheet

<http://www.manuallib.com/nxp/sa58670-audio-amplifier-datasheet.html>

The SA58670 is a stereo, filter-free class-D audio amplifier which is available in an HVQFN20 package with the exposed Die Attach Paddle (DAP).

The SA58670 features independent shutdown controls for each channel. The gain may be set at 6 dB, 12 dB, 18 dB or 24 dB with gain select pins G0 and G1. Improved immunity to noise and RF rectification is increased by high PSRR and differential circuit topology. Fast start-up time and small package makes it an ideal choice for both cellular handsets and PDAs.

ManualLib.com collects and classifies the global product instruction manuals to help users access anytime and anywhere, helping users make better use of products.

<http://www.manuallib.com>

SA58670

2.1 W/channel stereo class-D audio amplifier

Rev. 03 — 11 June 2009

Product data sheet

1. General description

The SA58670 is a stereo, filter-free class-D audio amplifier which is available in an HVQFN20 package with the exposed Die Attach Paddle (DAP).

The SA58670 features independent shutdown controls for each channel. The gain may be set at 6 dB, 12 dB, 18 dB or 24 dB with gain select pins G0 and G1. Improved immunity to noise and RF rectification is increased by high PSRR and differential circuit topology. Fast start-up time and small package makes it an ideal choice for both cellular handsets and PDAs.

The SA58670 delivers 1.4 W/channel at 5.0 V and 720 mW/channel at 3.6 V into 8 Ω . It delivers 2.1 W/channel at 5.0 V into 4 Ω . The maximum power efficiency is excellent at 70 % to 74 % into 4 Ω and 84 % to 88 % into 8 Ω . The SA58670 provides thermal and short-circuit shutdown protection.

2. Features

- Output power:
 - ◆ 2.1 W/channel into 4 Ω at 5.0 V
 - ◆ 1.4 W/channel into 8 Ω at 5.0 V
 - ◆ 720 mW/channel into 8 Ω at 3.6 V
- Supply voltage: 2.5 V to 5.5 V
- Independent shutdown control for each channel
- Selectable gain: 6 dB, 12 dB, 18 dB and 24 dB
- High SVRR: -77 dB at 217 Hz
- Fast start-up time: 3.5 ms
- Low supply current
- Low shutdown current
- Short-circuit and thermal protection
- Space savings with 4 mm \times 4 mm HVQFN20 package
- Low junction to ambient thermal resistance of 24 K/W with exposed DAP

3. Applications

- Wireless and cellular handset and PDA
- Portable DVD player
- USB speaker
- Notebook PC
- Portable radio and gaming



■ Educational toy

4. Ordering information

Table 1. Ordering information

Type number	Package		Version
	Name	Description	
SA58670BS	HVQFN20	plastic thermal enhanced very thin quad flat package; no leads; 20 terminals; body 4 × 4 × 0.85 mm	SOT917-1

5. Block diagram

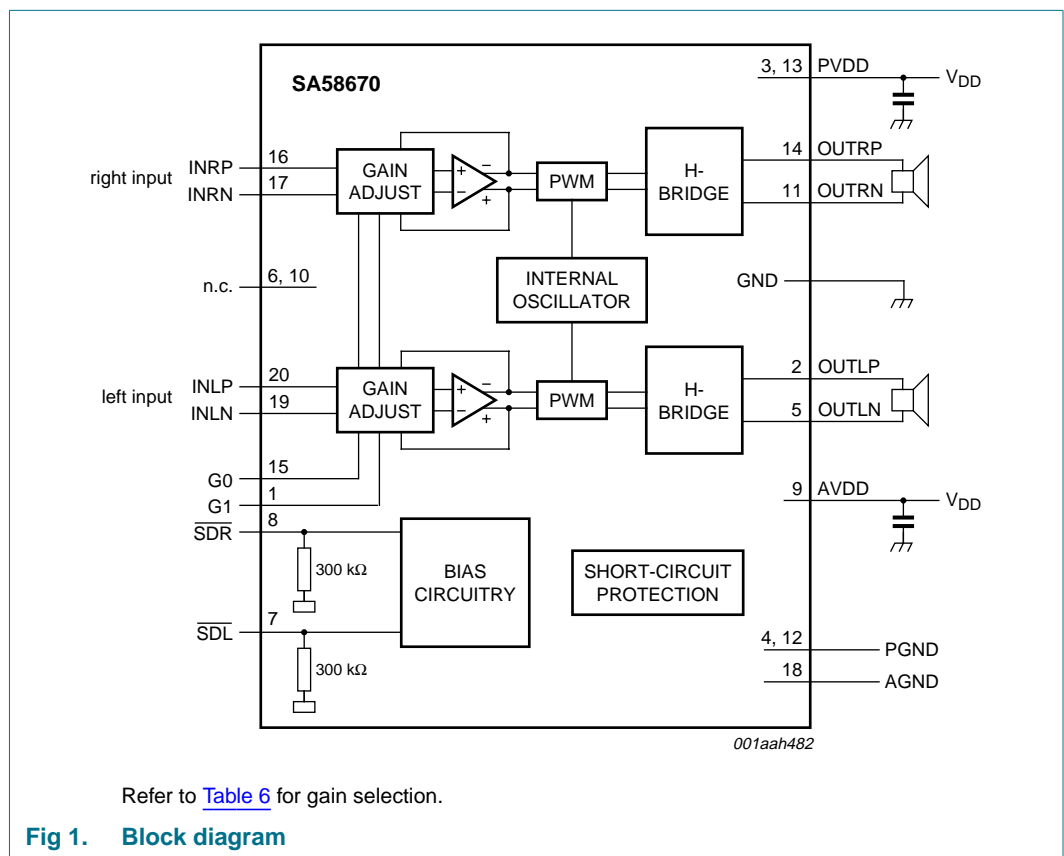

6. Pinning information

6.1 Pinning

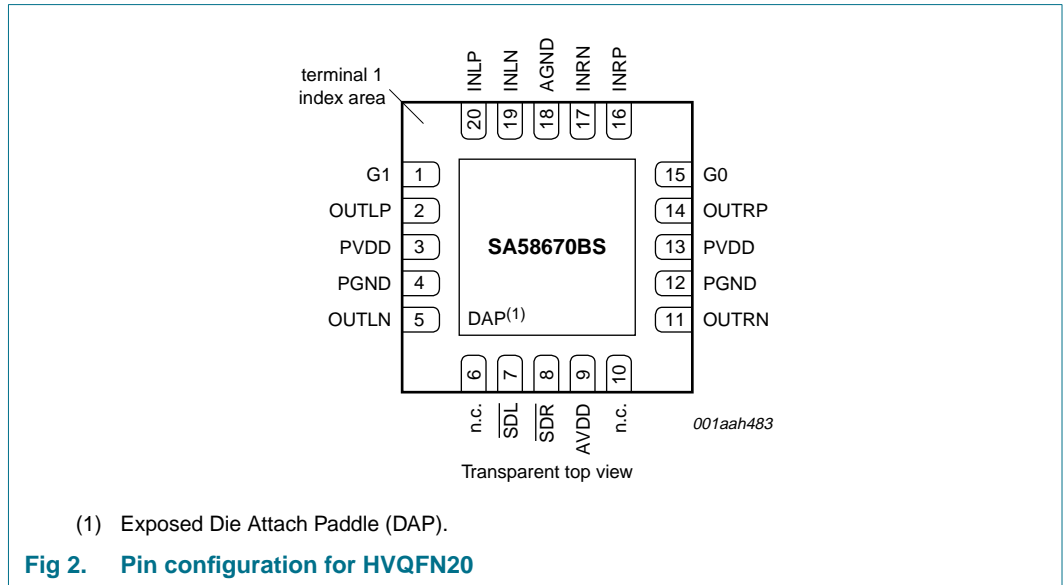

6.2 Pin description

Table 2. Pin description

Symbol	Pin	Description
G1	1	gain select input 1
OUTLP	2	left channel positive output
PVDD	3	power supply voltage (level same as AVDD)
PGND	4	power ground
OUTLN	5	left channel negative output
n.c.	6	not connected
$\overline{\text{SDL}}$	7	left channel shutdown input (active LOW)
$\overline{\text{SDR}}$	8	right channel shutdown input (active LOW)
AVDD	9	analog supply voltage (level same as PVDD)
n.c.	10	not connected
OUTRN	11	right channel negative output
PGND	12	power ground
PVDD	13	power supply voltage (level same as AVDD)
OUTRP	14	right channel positive output
G0	15	gain select input 0
INRP	16	right channel positive input
INRN	17	right channel negative input
AGND	18	analog ground

Table 2. Pin description ...continued

Symbol	Pin	Description
INLN	19	left channel negative input
INLP	20	left channel positive input
-	(DAP)	exposed die attach paddle; connect to ground plane heat spreader

7. Limiting values

Table 3. Limiting values

In accordance with the Absolute Maximum Rating System (IEC 60134).^[1]

Symbol	Parameter	Conditions	Min	Max	Unit
V_{DD}	supply voltage	Active mode	-0.3	+6.0	V
		Shutdown mode	-0.3	+7.0	V
V_I	input voltage	pin \overline{SDL}	GND	V_{DD}	V
		pin \overline{SDR}	GND	V_{DD}	V
		other pins	-0.3	$V_{DD} + 0.3$	V
P	power dissipation	derating factor 41.6 mW/K			
		$T_{amb} = 25\text{ }^{\circ}\text{C}$	-	5.2	W
		$T_{amb} = 75\text{ }^{\circ}\text{C}$	-	3.12	W
		$T_{amb} = 85\text{ }^{\circ}\text{C}$	-	2.7	W
T_{amb}	ambient temperature	operating in free air	-40	+85	$^{\circ}\text{C}$
T_j	junction temperature	operating	-40	+150	$^{\circ}\text{C}$
T_{stg}	storage temperature		-65	+85	$^{\circ}\text{C}$
V_{ESD}	electrostatic discharge voltage	human body model	± 2000	-	V
		machine model	± 200	-	V

- [1] V_{DD} is the supply voltage on pins PVDD and pin AVDD.
GND is the voltage ground on pins PGND and pin AGND.

8. Static characteristics

Table 4. Static characteristics
 $T_{amb} = 25\text{ }^{\circ}\text{C}$; unless otherwise specified^[1].

Symbol	Parameter	Conditions	Min	Typ	Max	Unit
V_{DD}	supply voltage	operating	2.5	-	5.5	V
I_{DD}	supply current	$V_{DD} = 2.5\text{ V}$; no load	-	4	6	mA
		$V_{DD} = 3.6\text{ V}$; no load	-	5	7.5	mA
		$V_{DD} = 5.5\text{ V}$; no load	-	6	9	mA
$I_{DD(sd)}$	shutdown mode supply current	no input signal; $V_{SDR} = V_{SDL} = \text{GND}$	-	10	1000	nA
PSRR	power supply rejection ratio	$V_{DD} = 2.5\text{ V to } 5.5\text{ V}$	-	-75	-55	dB
$V_{i(cm)}$	common-mode input voltage		0.5	-	$V_{DD} - 0.8$	V
CMRR	common mode rejection ratio	inputs are shorted together; $V_{DD} = 2.5\text{ V to } 5.5\text{ V}$	-	-69	-50	dB
V_{IH}	HIGH-level input voltage	$V_{DD} = 2.5\text{ V to } 5.5\text{ V}$; pins SDL , SDR , $G0$, $G1$	$0.7 \times V_{DD}$	-	V_{DD}	V
V_{IL}	LOW-level input voltage	$V_{DD} = 2.5\text{ V to } 5.5\text{ V}$; pins SDL , SDR , $G0$, $G1$	0	-	$0.3 \times V_{DD}$	V
I_{IH}	HIGH-level input current	$V_{DD} = 5.5\text{ V}$; $V_I = V_{DD}$	-	-	50	μA
I_{IL}	LOW-level input current	$V_{DD} = 5.5\text{ V}$; $V_I = 0\text{ V}$	-	-	5	μA
f_{sw}	switching frequency	$V_{DD} = 2.5\text{ V to } 5.5\text{ V}$	250	300	350	kHz
$G_{v(cl)}$	closed-loop voltage gain	$V_{G0} = V_{G1} = 0.35\text{ V}$	5.5	6	6.5	dB
		$V_{G0} = V_{DD}$; $V_{G1} = 0.35\text{ V}$	11.5	12	12.5	dB
		$V_{G0} = 0.35\text{ V}$; $V_{G1} = V_{DD}$	17.5	18	18.5	dB
		$V_{G0} = V_{G1} = V_{DD}$	23.5	24	24.5	dB
Pins OUTLP, OUTLN, OUTRP and OUTRN						
R_{DSon}	drain-source on-state resistance	$V_{DD} = 2.5\text{ V}$	-	700	-	$\text{m}\Omega$
		$V_{DD} = 3.6\text{ V}$	-	570	-	$\text{m}\Omega$
		$V_{DD} = 5.5\text{ V}$	-	500	-	$\text{m}\Omega$
$ V_{O(offset)} $	output offset voltage	measured differentially; inputs AC grounded; $G_{v(cl)} = 6\text{ dB}$; $V_{DD} = 2.5\text{ V to } 5.5\text{ V}$	-	5	10	mV
$Z_{o(sd)}$	shutdown mode output impedance	$V_{SDR} = V_{SDL} = 0.35\text{ V}$	-	2	-	$\text{k}\Omega$

[1] V_{DD} is the supply voltage on pins PVDD and pin AVDD.
GND is the ground supply voltage on pins PGND and pin AGND.

9. Dynamic characteristics

Table 5. Dynamic characteristics

$T_{amb} = 25\text{ }^{\circ}\text{C}$; $R_L = 8\ \Omega$; unless otherwise specified^[1].

Symbol	Parameter	Conditions	Min	Typ	Max	Unit
P_o	output power	per channel; $f = 1\text{ kHz}$; THD+N = 10 %				
		$R_L = 8\ \Omega$; $V_{DD} = 3.6\text{ V}$	-	0.72	-	W
		$R_L = 8\ \Omega$; $V_{DD} = 5.0\text{ V}$	-	1.4	-	W
		$R_L = 4\ \Omega$; $V_{DD} = 5.0\text{ V}$	-	2.1	-	W
THD+N	total harmonic distortion-plus-noise	$V_{DD} = 5.0\text{ V}$; $G_{v(cl)} = 6\text{ dB}$; $f = 1\text{ kHz}$				
		$P_o = 0.5\text{ W}$	-	0.11	-	%
		$P_o = 1.0\text{ W}$	-	0.14	-	%
SVRR	supply voltage ripple rejection	$G_{v(cl)} = 6\text{ dB}$; $f = 217\text{ Hz}$				
		$V_{DD} = 3.6\text{ V}$	-	-73	-	dB
		$V_{DD} = 5.0\text{ V}$	-	-77	-	dB
CMRR	common mode rejection ratio	$V_{DD} = 5.0\text{ V}$; $G_{v(cl)} = 6\text{ dB}$; $f = 217\text{ Hz}$	-	-69	-	dB
Z_i	input impedance	$G_{v(cl)} = 6\text{ dB}$	-	28.1	-	k Ω
		$G_{v(cl)} = 12\text{ dB}$	-	17.3	-	k Ω
		$G_{v(cl)} = 18\text{ dB}$	-	9.8	-	k Ω
		$G_{v(cl)} = 24\text{ dB}$	-	5.2	-	k Ω
$t_{d(sd\text{-}startup)}$	delay time from shutdown to start-up	$V_{DD} = 3.6\text{ V}$	-	3.5	-	ms
$V_{n(o)}$	output noise voltage	$V_{DD} = 3.6\text{ V}$; $f = 20\text{ Hz}$ to 20 kHz ; inputs are AC grounded				
		no weighting	-	35	-	μV
		A weighting	-	27	-	μV

[1] V_{DD} is the supply voltage on pins PVDD and pin AVDD.

10. Typical performance curves

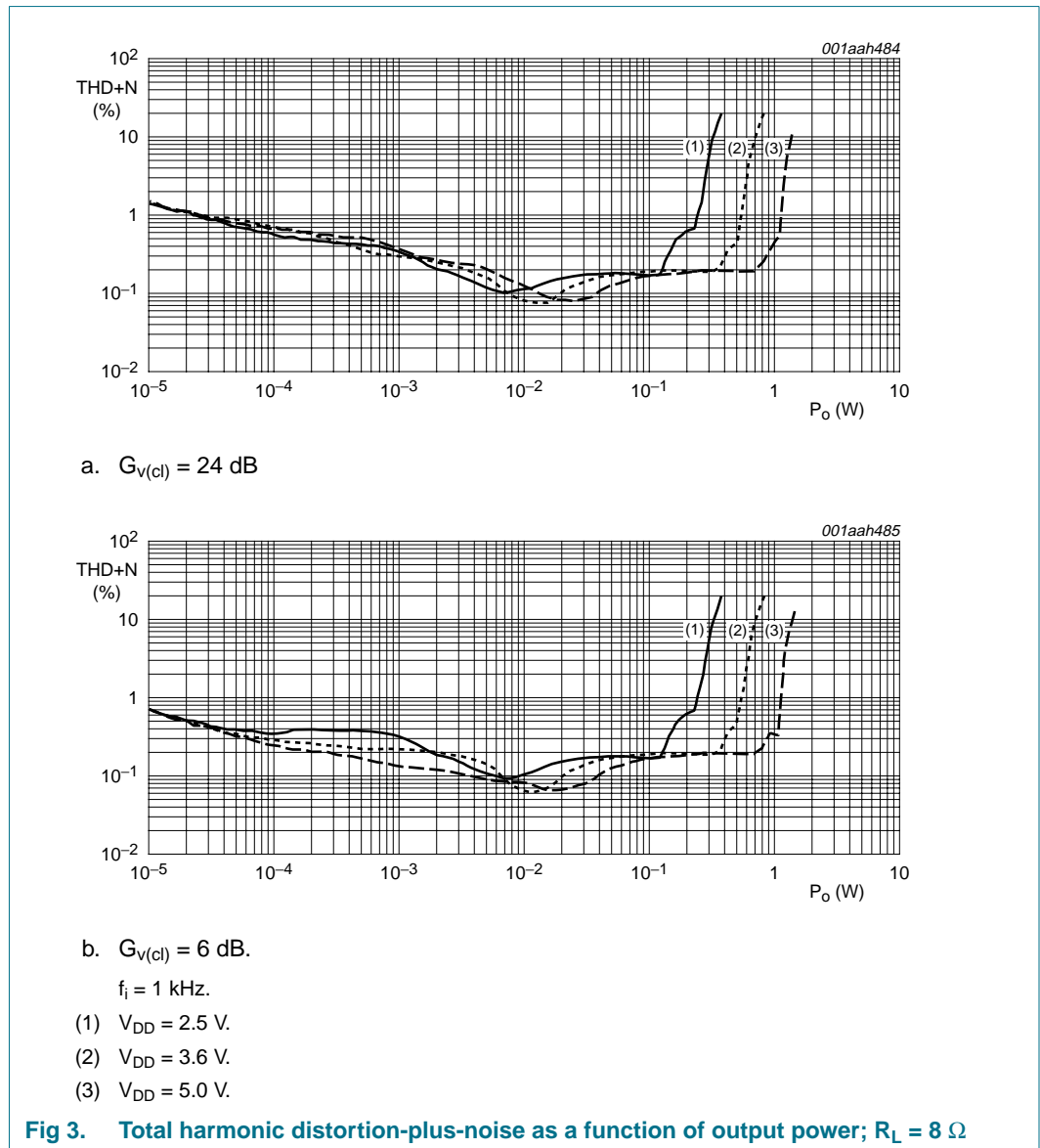

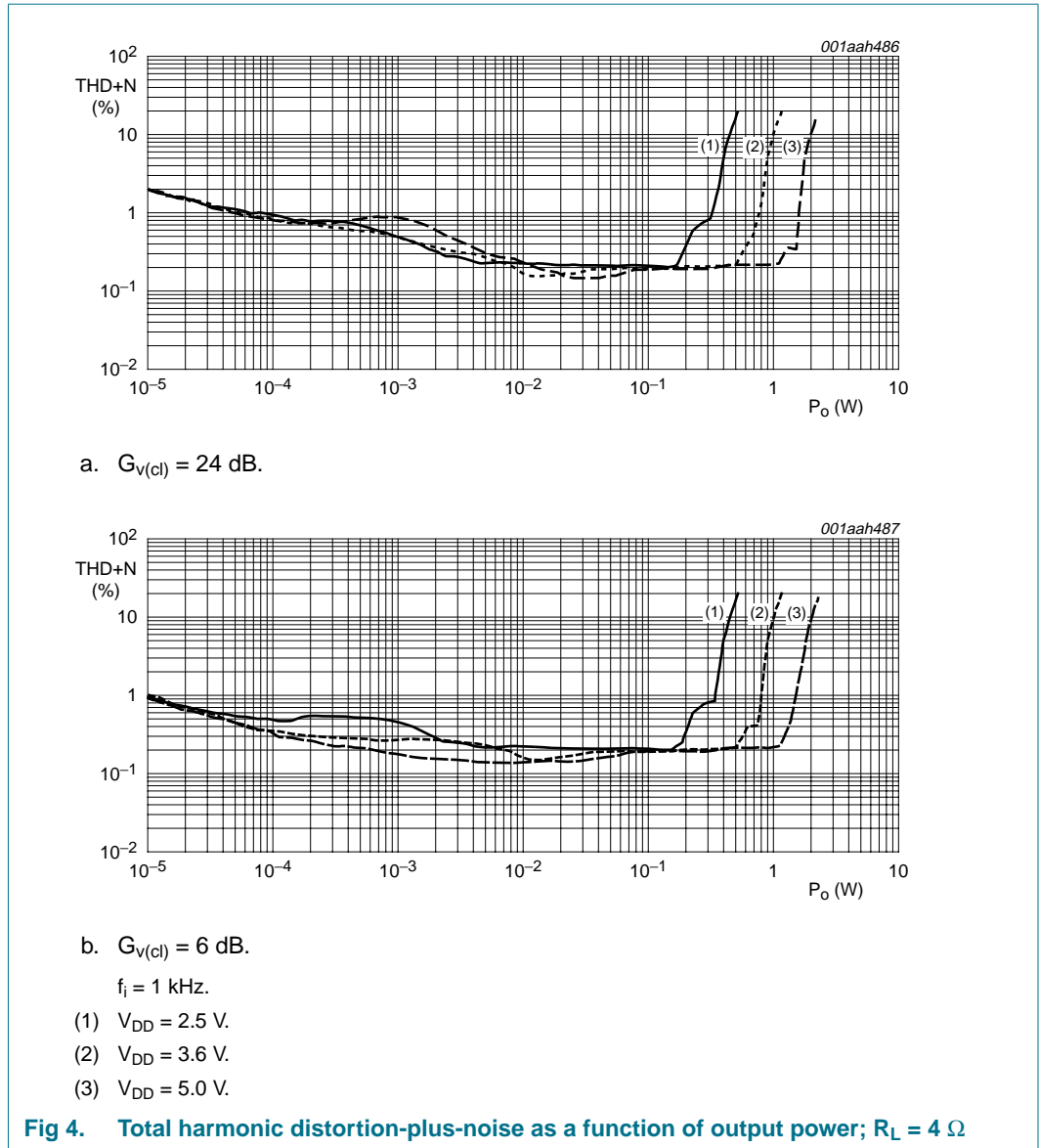

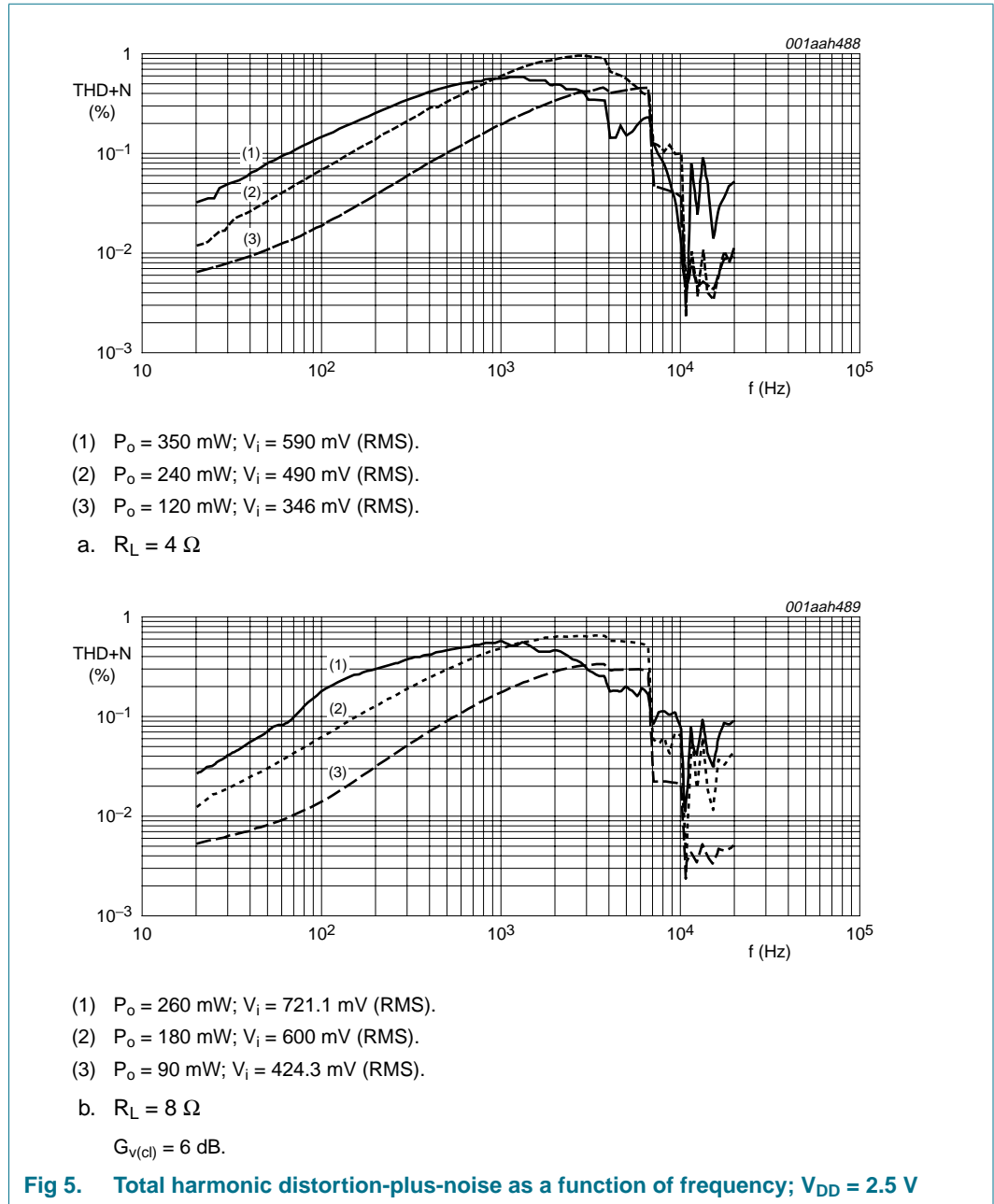

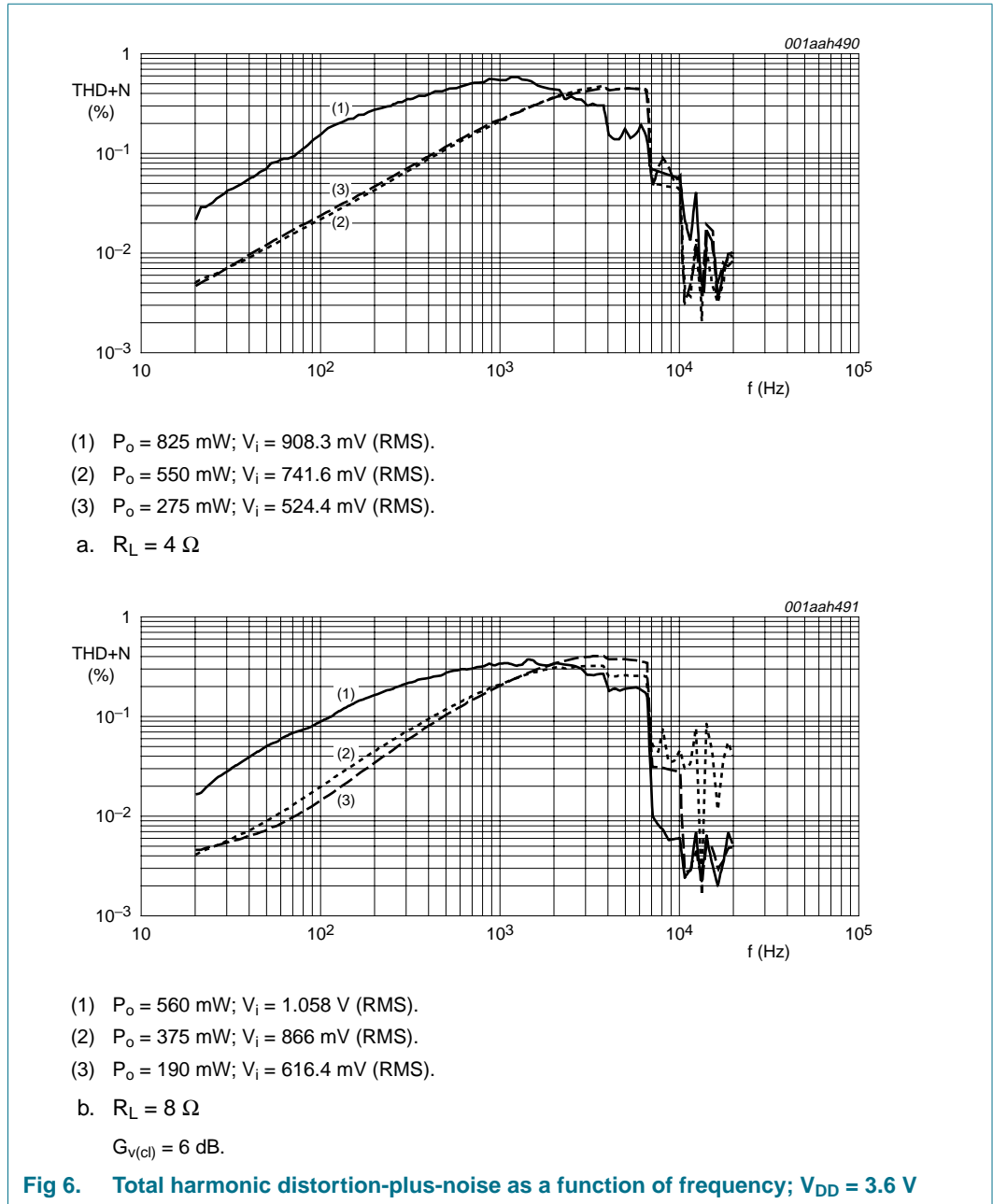

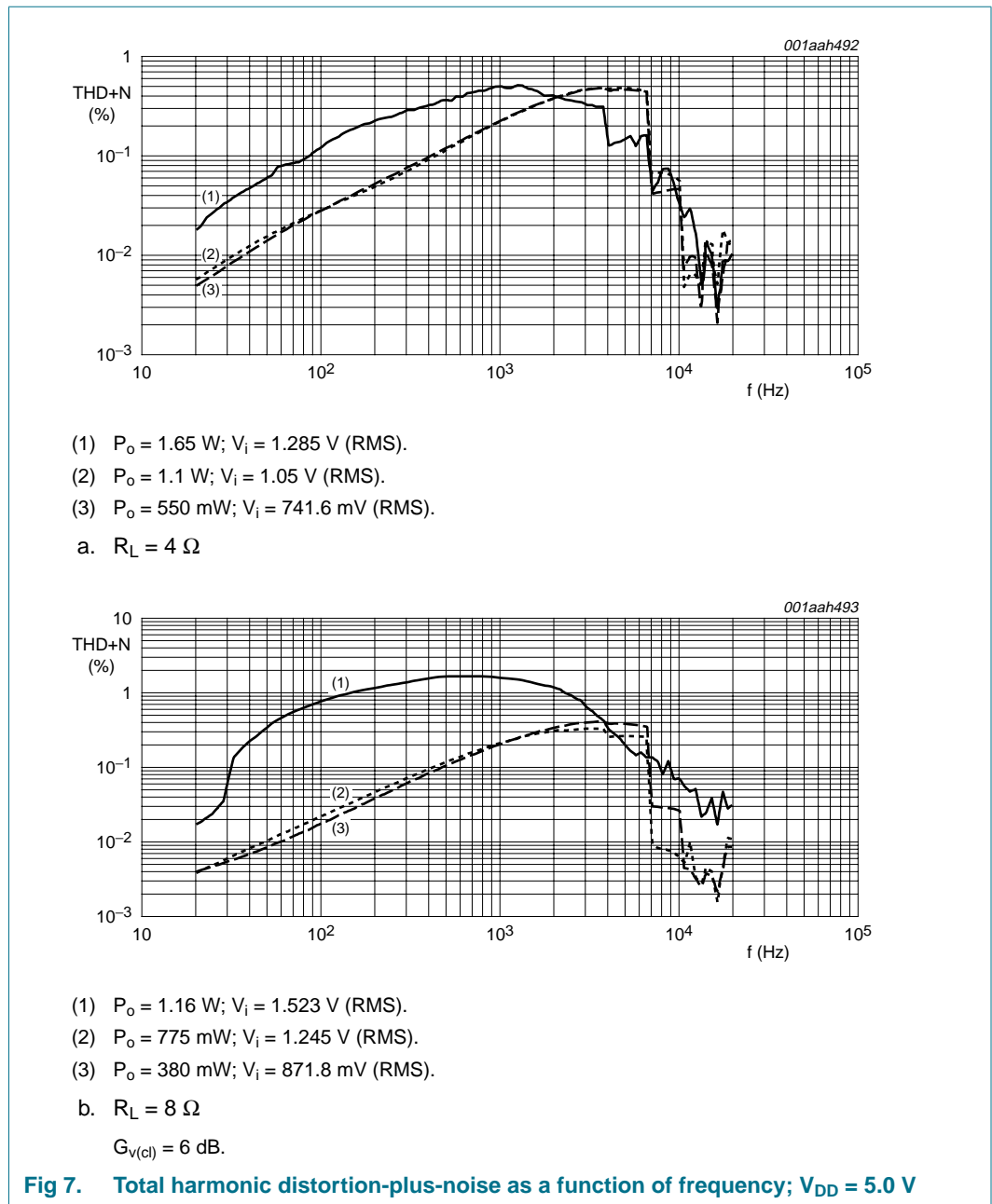

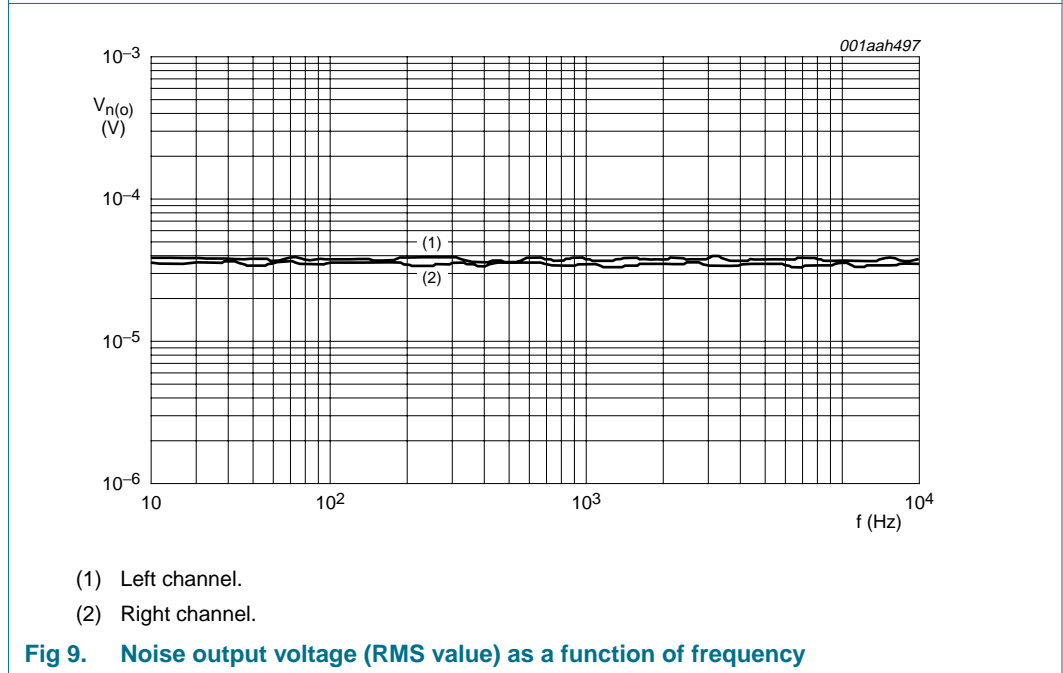
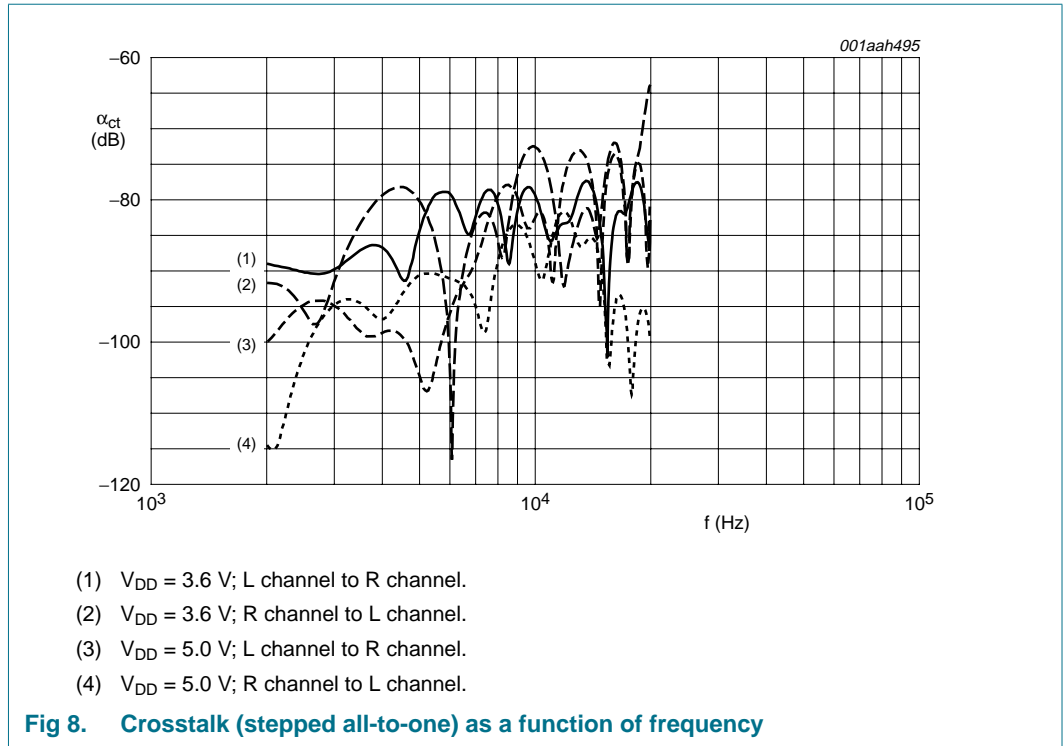

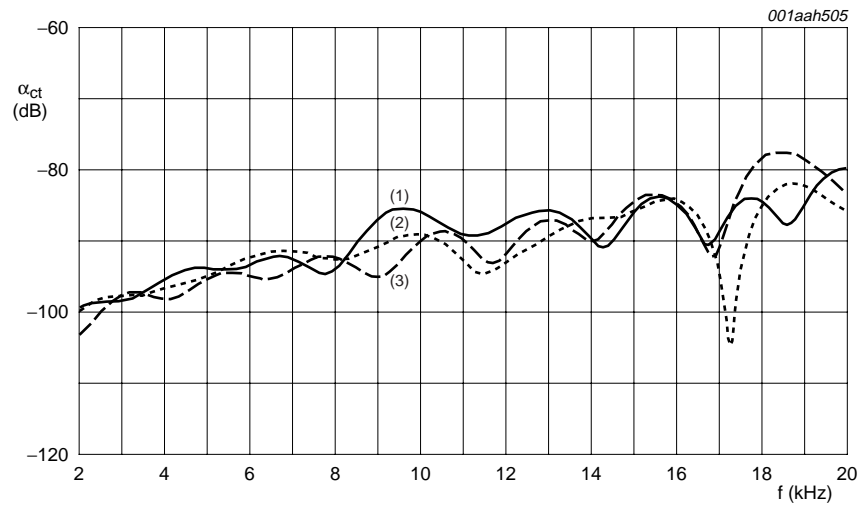

a. $R_L = 4 \Omega$

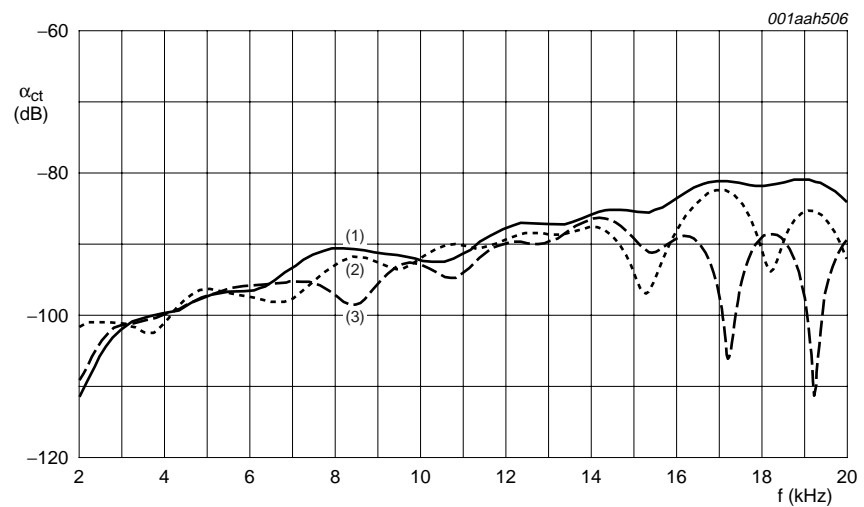

b. $R_L = 8 \Omega$

- (1) $V_{DD} = 2.5 \text{ V}$.
- (2) $V_{DD} = 3.6 \text{ V}$.
- (3) $V_{DD} = 5.0 \text{ V}$.

Fig 10. Crosstalk (one-to-one) as a function of frequency

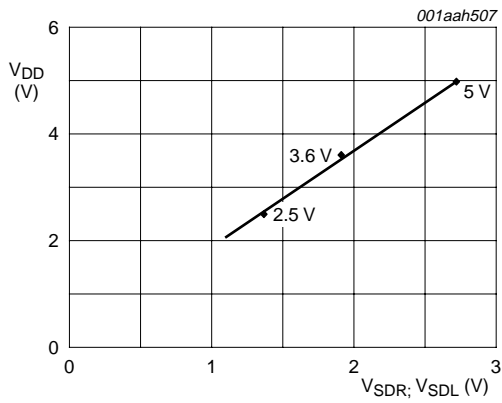
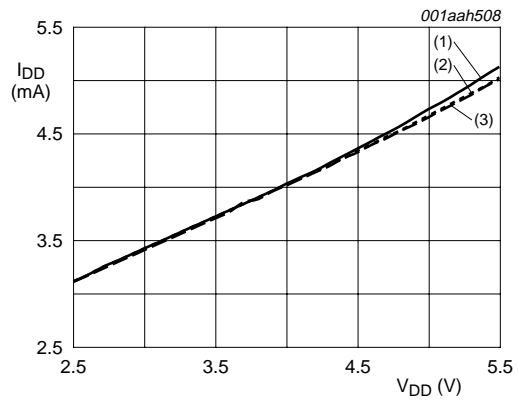
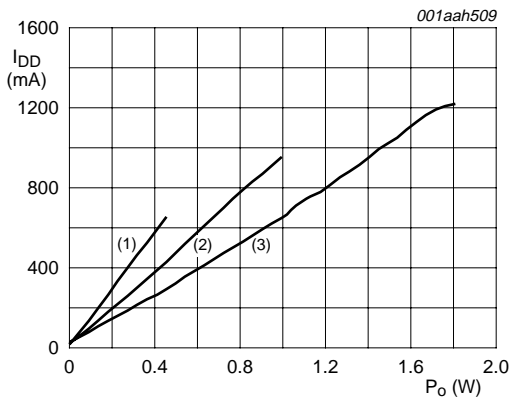

Fig 11. Supply voltage as a function of shutdown voltage



- (1) left channel; $R_L = 8 \Omega$.
- (2) right channel; $R_L = 4 \Omega$.
- (3) right channel; $R_L = 8 \Omega$.

Fig 12. Supply current as a function of supply voltage



- a. $R_L = 4 \Omega$
- (1) $V_{DD} = 2.5$ V.
 - (2) $V_{DD} = 3.6$ V.
 - (3) $V_{DD} = 5.0$ V.

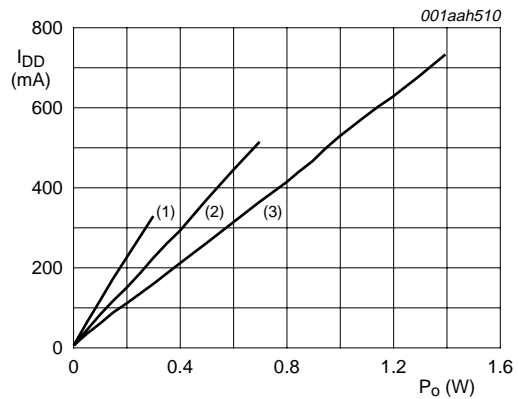

- b. $R_L = 8 \Omega$

Fig 13. Supply current as a function of output power

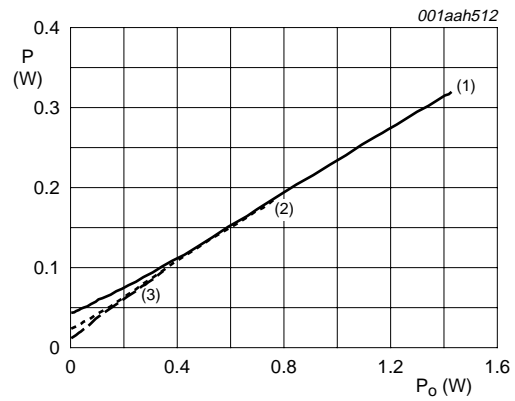
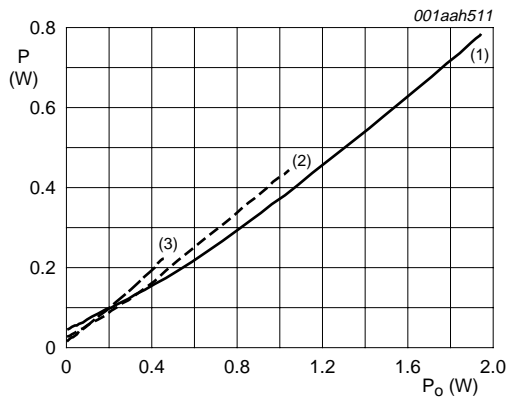

a. $R_L = 4 \Omega$

(1) $V_{DD} = 5.0 \text{ V}$.

(2) $V_{DD} = 3.6 \text{ V}$.

(3) $V_{DD} = 2.5 \text{ V}$.

b. $R_L = 8 \Omega$

Fig 14. Power dissipation as a function of output power

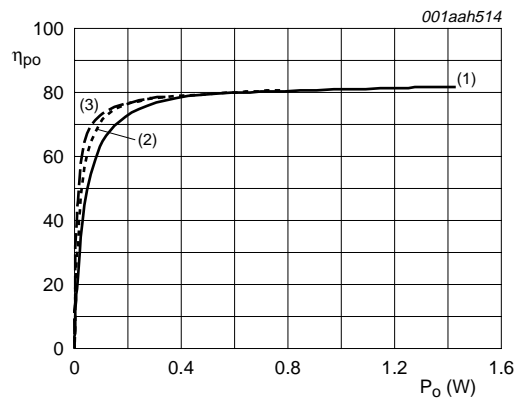
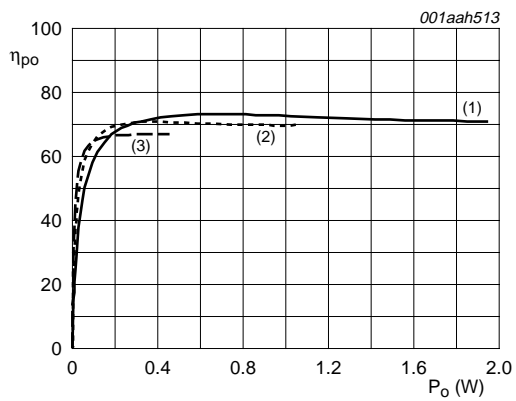

a. $R_L = 4 \Omega$

(1) $V_{DD} = 5.0 \text{ V}$.

(2) $V_{DD} = 3.6 \text{ V}$.

(3) $V_{DD} = 2.5 \text{ V}$.

b. $R_L = 8 \Omega$

Fig 15. Output power efficiency as a function of output power

11. Application information

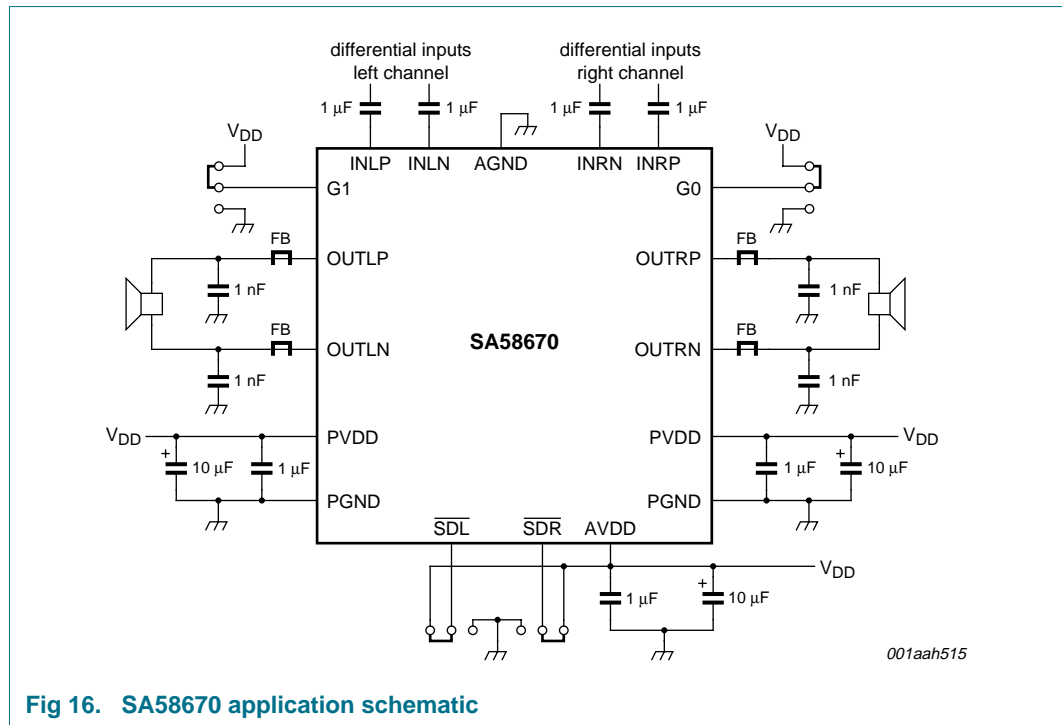

Fig 16. SA58670 application schematic

11.1 Power supply decoupling considerations

The SA58670 is a stereo class-D audio amplifier that requires proper supply voltage decoupling to ensure the rated performance for THD+N and power efficiency. To decouple high frequency transients, supply voltage spikes and digital noise on the supply voltage bus line, a low Equivalent Series Resistance (ESR) capacitor of typically 1 µF is placed as close as possible to the PVDD pins of the SA58670. It is important to place the decoupling capacitor at the supply voltage pins of the SA58670 because any resistance or inductance in the PCB trace between the SA58670 and the capacitor can cause a loss in efficiency. Additional decoupling using a larger capacitor, 4.7 µF or greater, may be done on the supply voltage connection on the PCB to filter low frequency signals. Usually this is not required due to high PSRR of the SA58670.

11.2 Input capacitor selection

The SA58670 does not require input coupling capacitors when used with a differential audio source that is biased from 0.5 V to $V_{DD} - 0.8$ V. In other words, the input signal must be biased within the common-mode input voltage ($V_{i(cm)}$) range. If high-pass filtering is required or if it is driven using a single-ended source, input coupling capacitors are required.

The 3 dB cut-off frequency created by the input coupling capacitor and the input resistors (see [Table 6](#)) is calculated by [Equation 1](#):

$$f_{-3dB} = \frac{1}{2\pi \times R_i \times C_i} \tag{1}$$

Table 6. Gain selection

G1	G0	Gain (V/V)	Gain (dB)	Input impedance (kΩ)
LOW	LOW	2	6	28.1
LOW	HIGH	4	12	17.3
HIGH	LOW	8	18	9.8
HIGH	HIGH	16	24	5.2

Since the value of the input decoupling capacitor and the input resistance determined by the gain setting affects the low frequency performance of the audio amplifier, it is important to consider this during the system design. Small speakers in wireless and cellular phones usually do not respond well to low frequency signals, so the 3 dB cut-off frequency may be increased to block the low frequency signals to the speakers. Not using input coupling capacitors may increase the output offset voltage.

[Equation 2](#) is solved for C_i :

$$C_i = \frac{I}{2\pi \times R_i \times f_{-3dB}} \tag{2}$$

11.3 PCB layout considerations

Component location is very important for performance of the SA58670. Place all external components very close to the SA58670. Placing decoupling capacitors directly at the power supply voltage pins increases efficiency because the resistance and inductance in the trace between the SA58670 power supply voltage pins and the decoupling capacitor causes a loss in power efficiency.

The trace width and routing are also very important for power output and noise considerations.

For high current pins (PVDD, PGND and audio output), the trace widths should be maximized to ensure proper performance and output power. Use at least 500 μm wide traces.

For the input pins (INRP, INRN, INLP and INLN), the traces must be symmetrical and run side-by-side to maximize common-mode cancellation.

11.4 Filter-free operation and ferrite bead filters

A ferrite bead low-pass filter can be used to reduce radio frequency emissions in applications that have circuits sensitive to frequencies greater than 1 MHz. A ferrite bead low-pass filter functions well for amplifiers that must pass FCC unintentional radiation requirements for frequencies greater than 30 MHz. Choose a bead with high-impedance at high frequencies and very low-impedance at low frequencies. In order to prevent distortion of the output signal, select a ferrite bead with adequate current rating.

For applications in which there are circuits that are EMI sensitive to low frequencies (< 1 MHz) and there are long leads from amplifier to speaker, it is necessary to use an LC output filter.

11.5 Efficiency and thermal considerations

The maximum ambient operating temperature depends on the heat transferring ability of the heat spreader on the PCB layout. In [Table 3 "Limiting values"](#), the power derating factor is given as 41.6 mW/K. The device thermal resistance, $R_{th(j-a)}$ is the reciprocal of the power derating factor. Convert the power derating factor to $R_{th(j-a)}$ by [Equation 3](#):

$$R_{th(j-a)} = \frac{1}{\text{derating factor}} = \frac{1}{0.0416} = 24 \text{ K/W} \quad (3)$$

For a maximum allowable junction temperature $T_j = 150 \text{ }^\circ\text{C}$ and $R_{th(j-a)} = 24 \text{ K/W}$ and a maximum device dissipation of 1.5 W (750 mW per channel) and for 2.1 W per channel output power, 4 Ω load, 5 V supply, the maximum ambient temperature is calculated using [Equation 4](#):

$$T_{amb(max)} = T_{j(max)} - (R_{th(j-a)} \times P_{max}) = 150 - (24 \times 1.5) = 114 \text{ }^\circ\text{C} \quad (4)$$

The maximum ambient temperature is 114 $^\circ\text{C}$ at maximum power dissipation for 5 V supply and 4 Ω load. If the junction temperature of the SA58670 rises above 150 $^\circ\text{C}$, the thermal protection circuitry turns the SA58670 off; this prevents damage to IC. Using speakers greater than 4 Ω further enhances thermal performance and battery lifetime by reducing the output load current and increasing amplifier efficiency.

11.6 Additional thermal information

The SA58670 HVQFN20 package incorporates an exposed DAP that is designed to solder the mount directly to the PCB heat spreader. By the use of thermal vias, the DAP may be soldered directly to a ground plane or special heat sinking layer designed into the PCB. The thickness and area of the heat spreader may be maximized to optimize heat transfer and achieve lowest package thermal resistance.

12. Package outline

HVQFN20: plastic thermal enhanced very thin quad flat package; no leads;
20 terminals; body 4 x 4 x 0.85 mm

SOT917-1

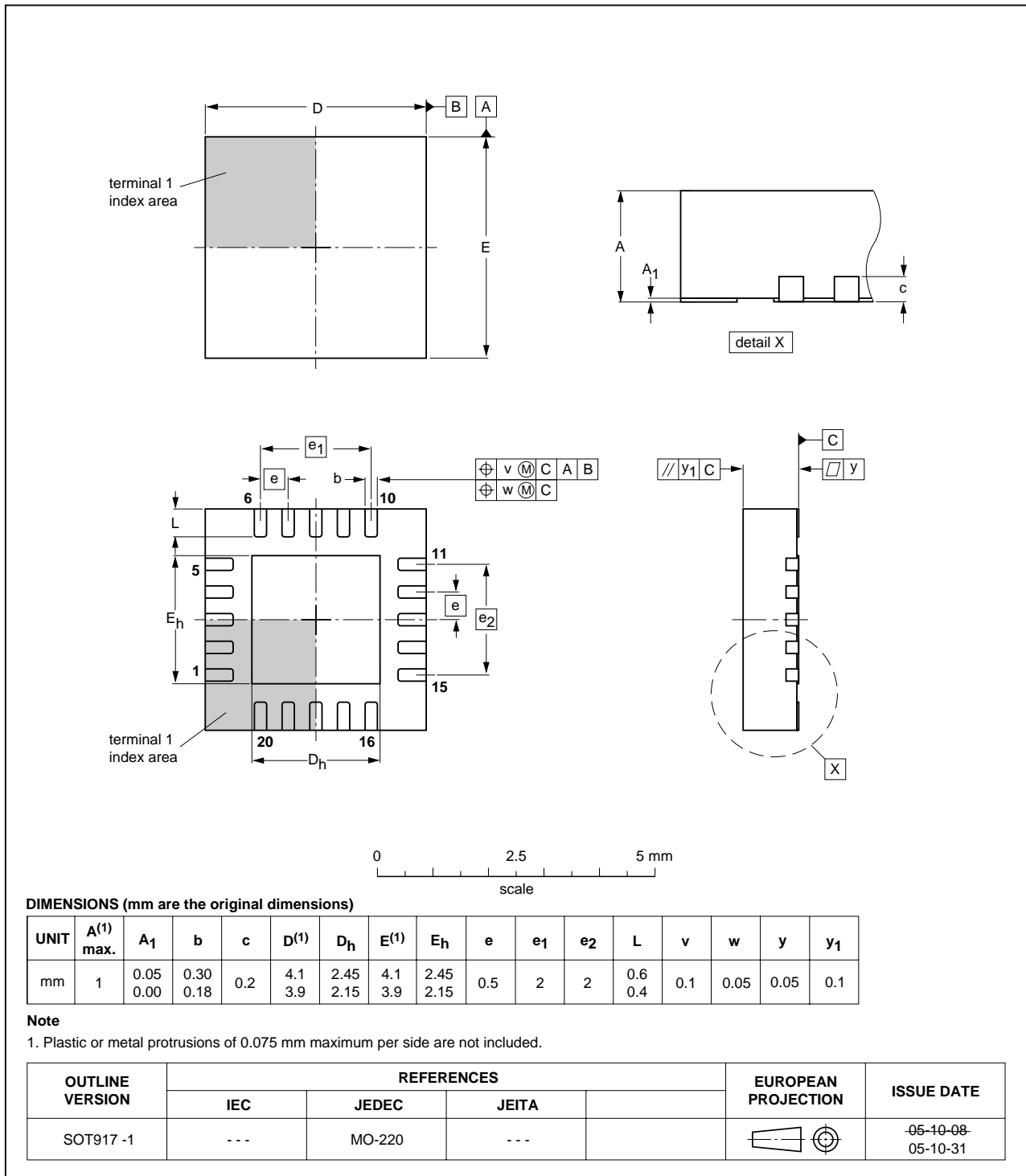

Fig 17. Package outline SOT917-1 (HVQFN20)

13. Soldering of SMD packages

This text provides a very brief insight into a complex technology. A more in-depth account of soldering ICs can be found in Application Note AN10365 "Surface mount reflow soldering description".

13.1 Introduction to soldering

Soldering is one of the most common methods through which packages are attached to Printed Circuit Boards (PCBs), to form electrical circuits. The soldered joint provides both the mechanical and the electrical connection. There is no single soldering method that is ideal for all IC packages. Wave soldering is often preferred when through-hole and Surface Mount Devices (SMDs) are mixed on one printed wiring board; however, it is not suitable for fine pitch SMDs. Reflow soldering is ideal for the small pitches and high densities that come with increased miniaturization.

13.2 Wave and reflow soldering

Wave soldering is a joining technology in which the joints are made by solder coming from a standing wave of liquid solder. The wave soldering process is suitable for the following:

- Through-hole components
- Leaded or leadless SMDs, which are glued to the surface of the printed circuit board

Not all SMDs can be wave soldered. Packages with solder balls, and some leadless packages which have solder lands underneath the body, cannot be wave soldered. Also, leaded SMDs with leads having a pitch smaller than ~0.6 mm cannot be wave soldered, due to an increased probability of bridging.

The reflow soldering process involves applying solder paste to a board, followed by component placement and exposure to a temperature profile. Leaded packages, packages with solder balls, and leadless packages are all reflow solderable.

Key characteristics in both wave and reflow soldering are:

- Board specifications, including the board finish, solder masks and vias
- Package footprints, including solder thieves and orientation
- The moisture sensitivity level of the packages
- Package placement
- Inspection and repair
- Lead-free soldering versus SnPb soldering

13.3 Wave soldering

Key characteristics in wave soldering are:

- Process issues, such as application of adhesive and flux, clinching of leads, board transport, the solder wave parameters, and the time during which components are exposed to the wave
- Solder bath specifications, including temperature and impurities

13.4 Reflow soldering

Key characteristics in reflow soldering are:

- Lead-free versus SnPb soldering; note that a lead-free reflow process usually leads to higher minimum peak temperatures (see [Figure 18](#)) than a SnPb process, thus reducing the process window
- Solder paste printing issues including smearing, release, and adjusting the process window for a mix of large and small components on one board
- Reflow temperature profile; this profile includes preheat, reflow (in which the board is heated to the peak temperature) and cooling down. It is imperative that the peak temperature is high enough for the solder to make reliable solder joints (a solder paste characteristic). In addition, the peak temperature must be low enough that the packages and/or boards are not damaged. The peak temperature of the package depends on package thickness and volume and is classified in accordance with [Table 7](#) and [8](#)

Table 7. SnPb eutectic process (from J-STD-020C)

Package thickness (mm)	Package reflow temperature (°C)	
	Volume (mm ³)	
	< 350	≥ 350
< 2.5	235	220
≥ 2.5	220	220

Table 8. Lead-free process (from J-STD-020C)

Package thickness (mm)	Package reflow temperature (°C)		
	Volume (mm ³)		
	< 350	350 to 2000	> 2000
< 1.6	260	260	260
1.6 to 2.5	260	250	245
> 2.5	250	245	245

Moisture sensitivity precautions, as indicated on the packing, must be respected at all times.

Studies have shown that small packages reach higher temperatures during reflow soldering, see [Figure 18](#).

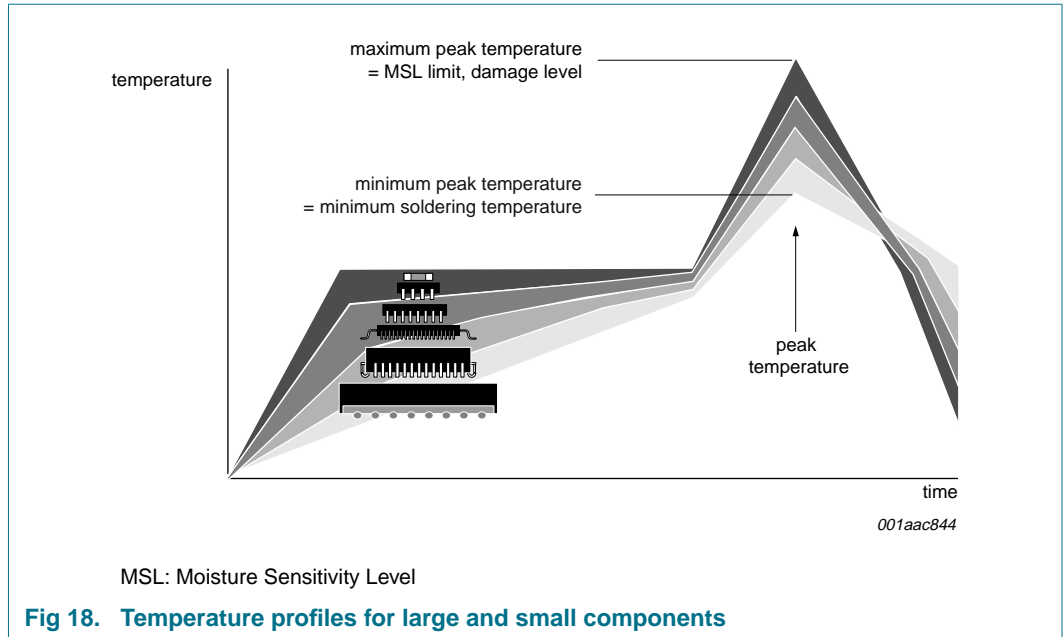

For further information on temperature profiles, refer to Application Note AN10365 “Surface mount reflow soldering description”.

14. Abbreviations

Table 9. Abbreviations

Acronym	Description
DAP	Die Attach Paddle
DVD	Digital Video Disc
EMI	ElectroMagnetic Interference
ESR	Equivalent Series Resistance
LC	inductor-capacitor filter
PC	Personal Computer
PCB	Printed-Circuit Board
PDA	Personal Digital Assistant
PWM	Pulse Width Modulator
USB	Universal Serial Bus

15. Revision history

Table 10. Revision history

Document ID	Release date	Data sheet status	Change notice	Supersedes
SA58670_3	20090611	Product data sheet	-	SA58670_2
Modifications:	<ul style="list-style-type: none"> • Table 4 "Static characteristics": <ul style="list-style-type: none"> – Changed V_{IH} Min value from "1.3 V" to "$0.7 \times V_{DD}$ V" – Changed V_{IL} Max value from "0.35 V" to "$0.3 \times V_{DD}$ V" 			
SA58670_2	20081023	Product data sheet	-	SA58670_1
SA58670_1	20080104	Product data sheet	-	-

16. Legal information

16.1 Data sheet status

Document status ^{[1][2]}	Product status ^[3]	Definition
Objective [short] data sheet	Development	This document contains data from the objective specification for product development.
Preliminary [short] data sheet	Qualification	This document contains data from the preliminary specification.
Product [short] data sheet	Production	This document contains the product specification.

[1] Please consult the most recently issued document before initiating or completing a design.

[2] The term 'short data sheet' is explained in section "Definitions".

[3] The product status of device(s) described in this document may have changed since this document was published and may differ in case of multiple devices. The latest product status information is available on the Internet at URL <http://www.nxp.com>.

16.2 Definitions

Draft — The document is a draft version only. The content is still under internal review and subject to formal approval, which may result in modifications or additions. NXP Semiconductors does not give any representations or warranties as to the accuracy or completeness of information included herein and shall have no liability for the consequences of use of such information.

Short data sheet — A short data sheet is an extract from a full data sheet with the same product type number(s) and title. A short data sheet is intended for quick reference only and should not be relied upon to contain detailed and full information. For detailed and full information see the relevant full data sheet, which is available on request via the local NXP Semiconductors sales office. In case of any inconsistency or conflict with the short data sheet, the full data sheet shall prevail.

16.3 Disclaimers

General — Information in this document is believed to be accurate and reliable. However, NXP Semiconductors does not give any representations or warranties, expressed or implied, as to the accuracy or completeness of such information and shall have no liability for the consequences of use of such information.

Right to make changes — NXP Semiconductors reserves the right to make changes to information published in this document, including without limitation specifications and product descriptions, at any time and without notice. This document supersedes and replaces all information supplied prior to the publication hereof.

Suitability for use — NXP Semiconductors products are not designed, authorized or warranted to be suitable for use in medical, military, aircraft, space or life support equipment, nor in applications where failure or malfunction of an NXP Semiconductors product can reasonably be expected to result in personal injury, death or severe property or environmental

damage. NXP Semiconductors accepts no liability for inclusion and/or use of NXP Semiconductors products in such equipment or applications and therefore such inclusion and/or use is at the customer's own risk.

Applications — Applications that are described herein for any of these products are for illustrative purposes only. NXP Semiconductors makes no representation or warranty that such applications will be suitable for the specified use without further testing or modification.

Limiting values — Stress above one or more limiting values (as defined in the Absolute Maximum Ratings System of IEC 60134) may cause permanent damage to the device. Limiting values are stress ratings only and operation of the device at these or any other conditions above those given in the Characteristics sections of this document is not implied. Exposure to limiting values for extended periods may affect device reliability.

Terms and conditions of sale — NXP Semiconductors products are sold subject to the general terms and conditions of commercial sale, as published at <http://www.nxp.com/profile/terms>, including those pertaining to warranty, intellectual property rights infringement and limitation of liability, unless explicitly otherwise agreed to in writing by NXP Semiconductors. In case of any inconsistency or conflict between information in this document and such terms and conditions, the latter will prevail.

No offer to sell or license — Nothing in this document may be interpreted or construed as an offer to sell products that is open for acceptance or the grant, conveyance or implication of any license under any copyrights, patents or other industrial or intellectual property rights.

Export control — This document as well as the item(s) described herein may be subject to export control regulations. Export might require a prior authorization from national authorities.

16.4 Trademarks

Notice: All referenced brands, product names, service names and trademarks are the property of their respective owners.

17. Contact information

For more information, please visit: <http://www.nxp.com>

For sales office addresses, please send an email to: salesaddresses@nxp.com

18. Contents

1	General description	1
2	Features	1
3	Applications	1
4	Ordering information	2
5	Block diagram	2
6	Pinning information	3
6.1	Pinning	3
6.2	Pin description	3
7	Limiting values	4
8	Static characteristics	5
9	Dynamic characteristics	6
10	Typical performance curves	7
11	Application information	16
11.1	Power supply decoupling considerations	16
11.2	Input capacitor selection	16
11.3	PCB layout considerations	17
11.4	Filter-free operation and ferrite bead filters	17
11.5	Efficiency and thermal considerations	18
11.6	Additional thermal information	18
12	Package outline	19
13	Soldering of SMD packages	20
13.1	Introduction to soldering	20
13.2	Wave and reflow soldering	20
13.3	Wave soldering	20
13.4	Reflow soldering	21
14	Abbreviations	22
15	Revision history	23
16	Legal information	24
16.1	Data sheet status	24
16.2	Definitions	24
16.3	Disclaimers	24
16.4	Trademarks	24
17	Contact information	24
18	Contents	25

Please be aware that important notices concerning this document and the product(s) described herein, have been included in section 'Legal information'.



© NXP B.V. 2009.

All rights reserved.

For more information, please visit: <http://www.nxp.com>

For sales office addresses, please send an email to: salesaddresses@nxp.com

Date of release: 11 June 2009

Document identifier: SA58670_3