

# CET CEG8205A Transistor Datasheet

<http://www.manuallib.com/cet/ceg8205a-transistor-datasheet.html>

## FEATURES

20V, 6.2A,  $R_{DS(ON)} = 24\text{m}\Omega$  @  $V_{GS} = 4.5\text{V}$ .

$R_{DS(ON)} = 34\text{m}\Omega$  @  $V_{GS} = 2.5\text{V}$ .

Super High dense cell design for extremely low  $R_{DS(ON)}$ .

High power and current handing capability.

Lead free product is acquired.

TSSOP-8 Package.

ManualLib.com collects and classifies the global product instruction manuals to help users access anytime and anywhere, helping users make better use of products.

<http://www.manuallib.com>

## Dual N-Channel Enhancement Mode Field Effect Transistor

### FEATURES

- 20V, 6A,  $R_{DS(ON)} = 25m\Omega$  @ $V_{GS} = 4.5V$ .  
 $R_{DS(ON)} = 35m\Omega$  @ $V_{GS} = 2.5V$ .
- Super High dense cell design for extremely low  $R_{DS(ON)}$ .
- High power and current handling capability.
- Lead free product is acquired.
- TSSOP-8 for Surface Mount Package.

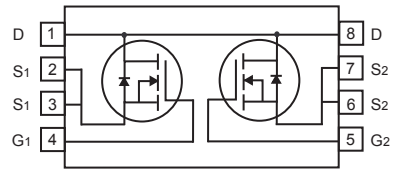
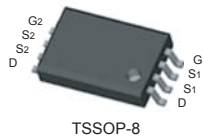

### ABSOLUTE MAXIMUM RATINGS $T_A = 25^\circ C$ unless otherwise noted

Parameter	Symbol	Limit	Units
Drain-Source Voltage	$V_{DS}$	20	V
Gate-Source Voltage	$V_{GS}$	$\pm 12$	V
Drain Current-Continuous	$I_D$	6	A
Drain Current-Pulsed <sup>a</sup>	$I_{DM}$	25	A
Maximum Power Dissipation	$P_D$	1.5	W
Operating and Store Temperature Range	$T_J, T_{stg}$	-55 to 150	$^\circ C$

### Thermal Characteristics

Parameter	Symbol	Limit	Units
Thermal Resistance, Junction-to-Ambient <sup>b</sup>	$R_{\theta JA}$	83	$^\circ C/W$



# CEG8205A

## Electrical Characteristics $T_A = 25^\circ\text{C}$ unless otherwise noted

Parameter	Symbol	Test Condition	Min	Typ	Max	Units
<b>Off Characteristics</b>						
Drain-Source Breakdown Voltage	$BV_{DSS}$	$V_{GS} = 0V, I_D = 250\mu A$	20			V
Zero Gate Voltage Drain Current	$I_{DSS}$	$V_{DS} = 18V, V_{GS} = 0V$			1	$\mu A$
Gate Body Leakage Current, Forward	$I_{GSSF}$	$V_{GS} = 12V, V_{DS} = 0V$			100	nA
Gate Body Leakage Current, Reverse	$I_{GSSR}$	$V_{GS} = -12V, V_{DS} = 0V$			-100	nA
<b>On Characteristics <sup>c</sup></b>						
Gate Threshold Voltage	$V_{GS(th)}$	$V_{GS} = V_{DS}, I_D = 250\mu A$	0.5		1.2	V
Static Drain-Source On-Resistance	$R_{DS(on)}$	$V_{GS} = 4.5V, I_D = 4.5A$		21	25	$m\Omega$
		$V_{GS} = 2.5V, I_D = 3.5A$		27	35	$m\Omega$
<b>Dynamic Characteristics <sup>d</sup></b>						
Input Capacitance	$C_{iss}$	$V_{DS} = 8V, V_{GS} = 0V, \square$ $f = 1.0\text{ MHz}$		720		pF
Output Capacitance	$C_{oss}$			130		pF
Reverse Transfer Capacitance	$C_{rss}$			95		pF
<b>Switching Characteristics <sup>d</sup></b>						
Turn-On Delay Time	$t_{d(on)}$	$V_{DD} = 10V, I_D = 1A,$ $V_{GS} = 4.5V, R_{GEN} = 6\Omega$		10	20	ns
Turn-On Rise Time	$t_r$			7	14	ns
Turn-Off Delay Time	$t_{d(off)}$			34	68	ns
Turn-Off Fall Time	$t_f$			6	12	ns
Total Gate Charge	$Q_g$	$V_{DS} = 10V, I_D = 6A,$ $V_{GS} = 4.5V$		6.8	8.8	nC
Gate-Source Charge	$Q_{gs}$			0.5		nC
Gate-Drain Charge	$Q_{gd}$			1.8		nC
<b>Drain-Source Diode Characteristics and Maximum Ratings</b>						
Drain-Source Diode Forward Current <sup>b</sup>	$I_S$				1.7	A
Drain-Source Diode Forward Voltage <sup>c</sup>	$V_{SD}$	$V_{GS} = 0V, I_S = 1.7A$			1.2	V
<b>Notes :</b> $\square$ a.Repetitive Rating : Pulse width limited by maximum junction temperature. $\square$ b.Surface Mounted on FR4 Board, $t \leq 10\text{ sec.}$ $\square$ c.Pulse Test : Pulse Width $\leq 300\mu s$ , Duty Cycle $\leq 2\%.$ $\square$ d.Guaranteed by design, not subject to production testing. $\square$ $\square$						



# CEG8205A

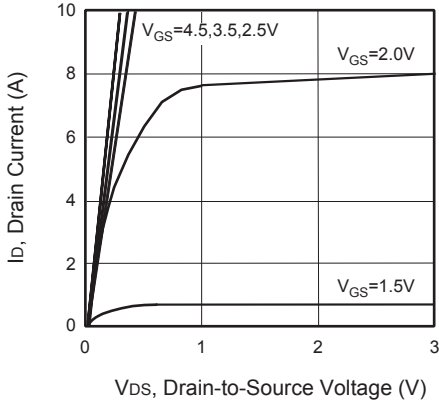

**Figure 1. Output Characteristics**

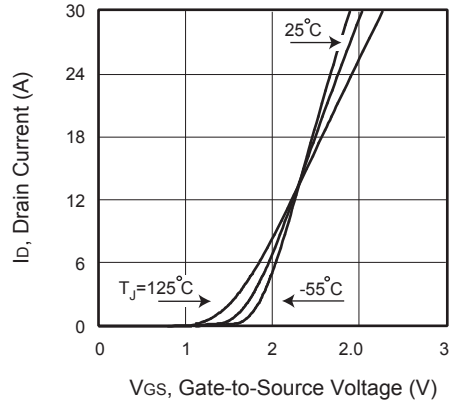

**Figure 2. Transfer Characteristics**

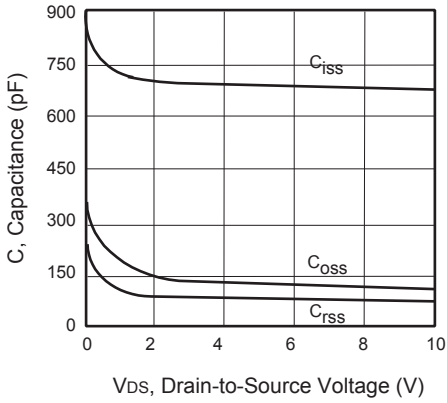

**Figure 3. Capacitance**

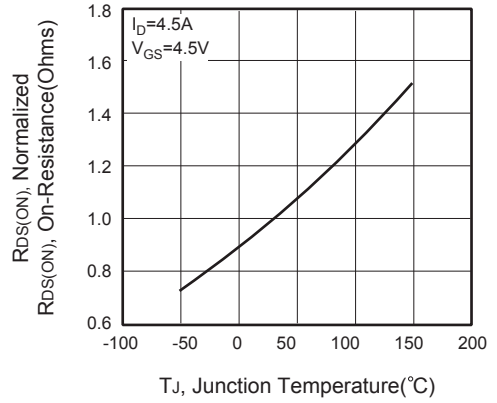

**Figure 4. On-Resistance Variation with Temperature**

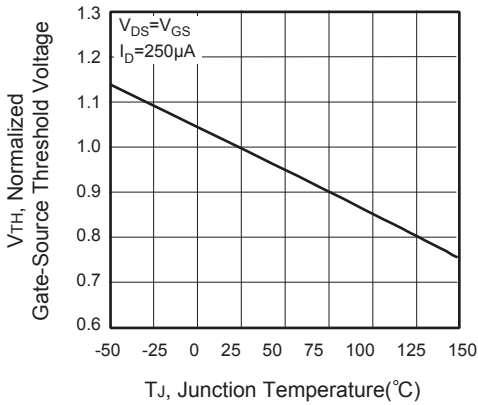

**Figure 5. Gate Threshold Variation with Temperature**

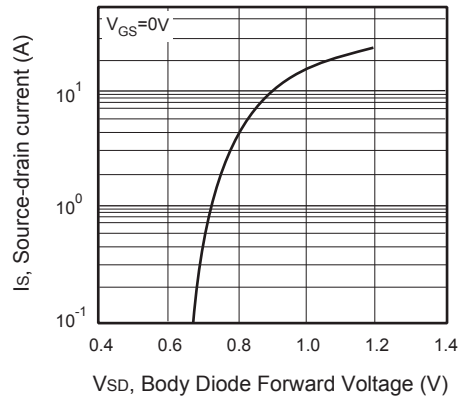

**Figure 6. Body Diode Forward Voltage Variation with Source Current**



# CEG8205A

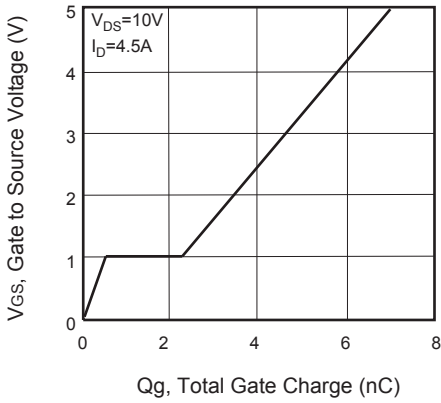

Figure 7. Gate Charge

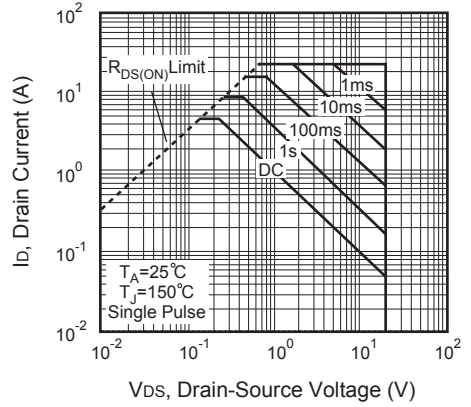

Figure 8. Maximum Safe Operating Area

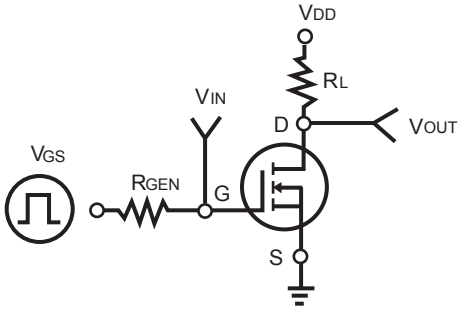

Figure 9. Switching Test Circuit

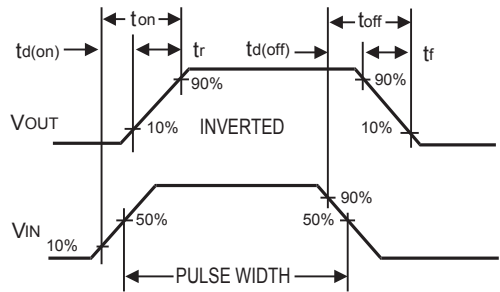

Figure 10. Switching Waveforms

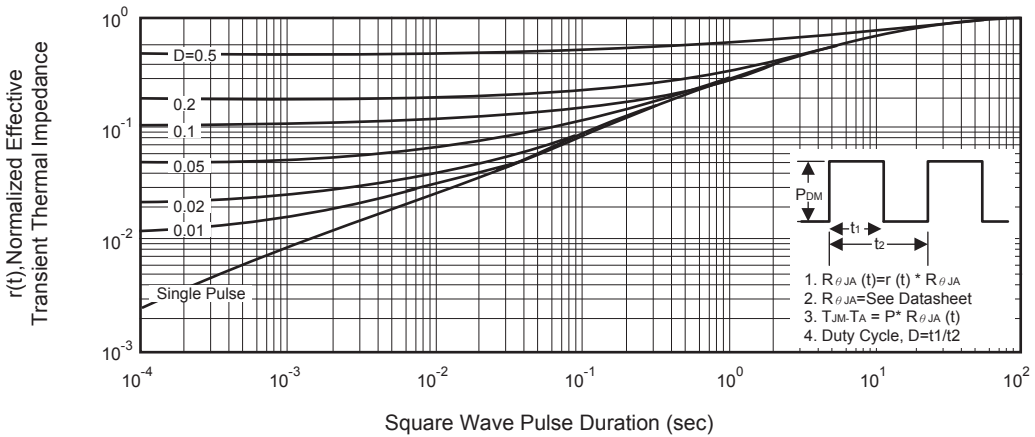

Figure 11. Normalized Thermal Transient Impedance Curve