

ARCH AQF120O-180W AC-DC Switching Power Supply Datasheet

<http://www.manuallib.com/arch/aqf120o-180w-ac-dc-switching-power-supply-datasheet.html>

KEY FEATURES

- Open Frame Switching Power Supply
- 180 Watt with 18CFM FAN for 12V to 48V Output Voltage
- 180 Watt with 30CFM FAN for 5V Output Voltage
- High Efficiency up to 93%
- Universal Input: 90-264 VAC
- Low Ripple and Noise
- With P.F.C. Function >0.95
- 120 Watt with Free Air Convection
- Ultra Compact Size: 5.0 x 3.0 x 1.16 Inches
- 3-Years Product Warranty

ManualLib.com collects and classifies the global product instruction manuals to help users access anytime and anywhere, helping users make better use of products.

<http://www.manuallib.com>

AQF1200 SERIES
180 Watts
KEY FEATURES

- Open Frame Switching Power Supply
- 180 Watt with 18CFM FAN for 12V to 48V Output Voltage
- 180 Watt with 30CFM FAN for 5V Output Voltage
- High Efficiency up to 93%
- Universal Input: 90-264 VAC
- Low Ripple and Noise
- With P.F.C. Function >0.95
- 120 Watt with Free Air Convection
- Ultra Compact Size: 5.0 x 3.0 x 1.16 Inches
- 3-Years Product Warranty

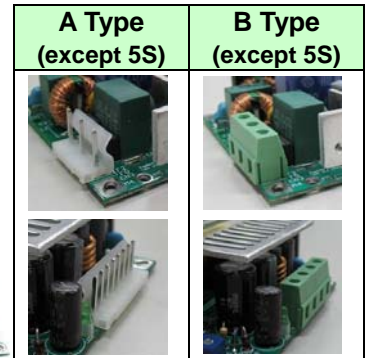
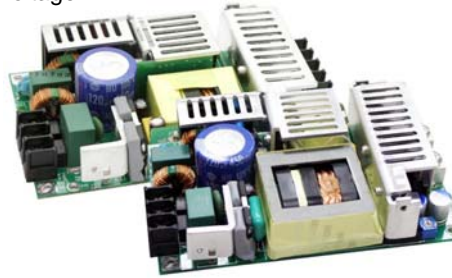
ELECTRICAL SPECIFICATIONS

Model No.	AQF1200-5S	AQF1200-12S	AQF1200-15S	AQF1200-24S	AQF1200-48S	
Max Output Wattage (W)	150 W (30CFM FAN)	180 W (18CFM FAN)				
Max Output Wattage (W)	100 W	120 W				
Input	Voltage	90-264 VAC or 120-370 VDC (80-274 VAC or 110-390 VDC with Derating)				
	Frequency (Hz)	47-63 Hz				
	Current (Full load)	<2.0 A max. (115 VAC) / <1.0 A max. (230 VAC)				
	Inrush Current (<2ms)	< 30 A max. (115 VAC) / < 60 A max. (230 VAC)				
	Leakage Current	< 0.5 mA max.				
	Power Factor	PF>0.99 (115 VAC) / PF>0.95 (230 VAC) at Full Load				
Output	Voltage (V.DC.)	5V	12V	15V	24V	48V
	Voltage Accuracy	±2%				
	Voltage Adj. Range (V.DC)	4.7~5.3V	11.4~13.2V	13.5~16V	22.8~26.4V	45.6~52V
	Current (18/30 CFM FAN)(A) max	0~30 (30CFM FAN)	0~15 (18CFM FAN)	0~12 (18CFM FAN)	0~7.5 (18CFM FAN)	0~3.75 (18CFM FAN)
	Current (Convection) (A) max	0~20	0~10	0~8	0~5	0~2.5
	Line Regulation	±1%				
	Load Regulation	±1%				
	Minimum Load	5%	1%			
	Maximum Capacitive Load	100,000µF	40,000µF	35,000µF	20,000µF	1,200µF
	Ripple & Noise (max.)	100mV	50mV	50mV	100mV	200mV
	Efficiency (typ.)	87%	90%	90%	93%	93%
	Hold-up Time	15 ms min.				
	Switching Frequency	90 kHz	100 kHz			
Protection	Over Power Protection	Auto recovery				
	Over Voltage Protection	Auto recovery (> 125% Vout)				
	Short Circuit Protection	Auto recovery				
Isolation	Input-Output (V.AC)	4000V				
	Input-FG (V.AC)	2000V				
	Output-FG (V.AC)	500V				
Environment	Operating Temperature	-25°C...+70°C (with derating)				
	Storage Temperature	-25°C...+85°C				
	Temperature Coefficient	±0.03%/°C (0~50°C)				
	Humidity	95% RH				
	MTBF	>120,000 h @ 25°C (MIL-HDBK-217F, Notice 1)				
	Vibration	10~500Hz, 2G 10min./1cycle, 60min. each along X, Y, Z axes.				
Physical	Dimension (L x W x H)	5S: 5.0 x 3.0 x 1.24 Inches (127.0 x 76.2 x 31.5 mm) Tolerance ±0.5 mm	others: 5.0 x 3.0 x 1.16 Inches (127.0 x 76.2 x 29.5 mm) Tolerance ±0.5 mm			
	Weight	5S:350 g / others:280 g				
	Cooling Method	Free convection / 18 CFM FAN				
Safety	Agency Approvals	CE, UL60950-1(except 5S / 15S), CB(except 5S / 15S)				
EMC	EMI (Conducted & Radiated Emission)	EN61000-6-3 · EN 55022 class B				
	EMS (Noise Immunity)	EN 55024				

1.All specifications valid at normal input voltage, full load and +25°C after warm-up time unless otherwise stated.

2.Ripple & Noise are measured at 20MHz of bandwidth with 0.1UF & 47UF parallel capacitor.

3.Hold-up Time measured at 90% Vout.

<http://www.archcorp.com.tw>

TEL: +886-2-26989508 FAX: +886-2-26981319

-1-

DERATING

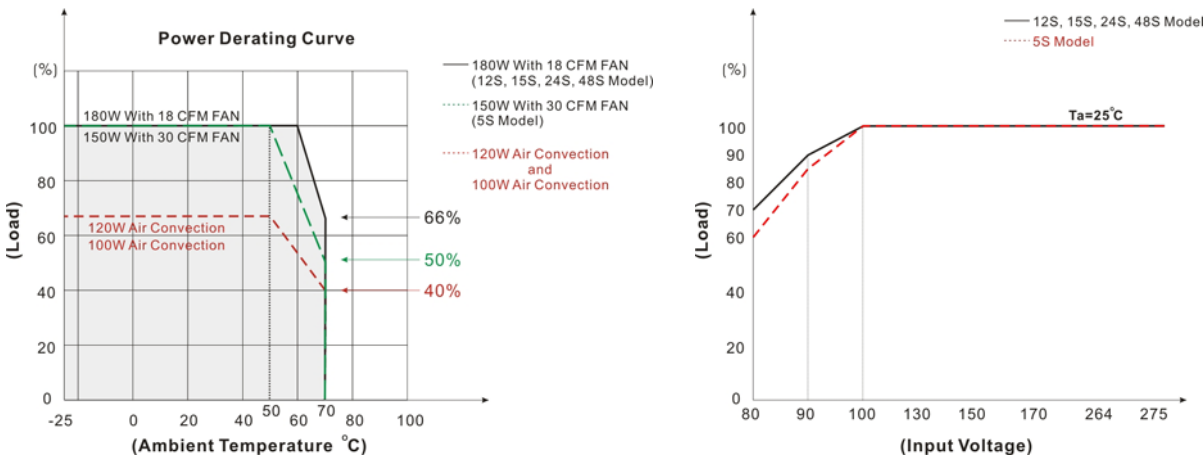

BLOCK DIAGRAM

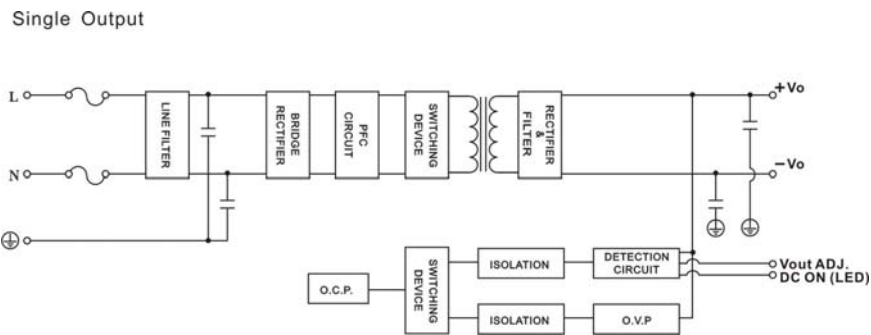

MECHANICAL DIMENSION (Top View)

Standard (5S)

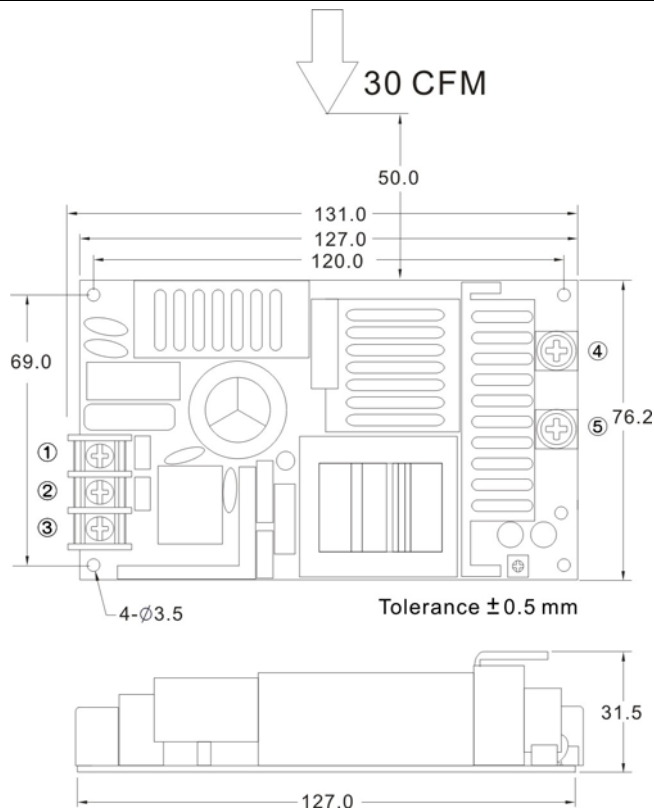

PIN#	SINGLE
1	AC IN (L)
2	AC IN (N)
3	FG
4	+DC OUT
5	-DC OUT

MECHANICAL DIMENSION (Top View)
Standard (12S 、 15S 、 24S 、 48S)

PIN#	SINGLE
1	AC IN (L)
2	AC IN (N)
3	FG
4	+DC OUT
5	+DC OUT
6	-DC OUT
7	-DC OUT

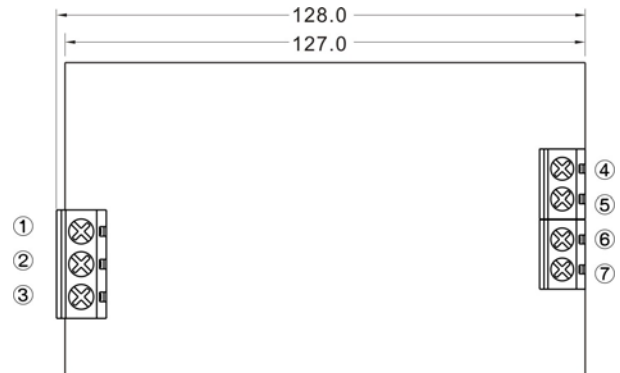
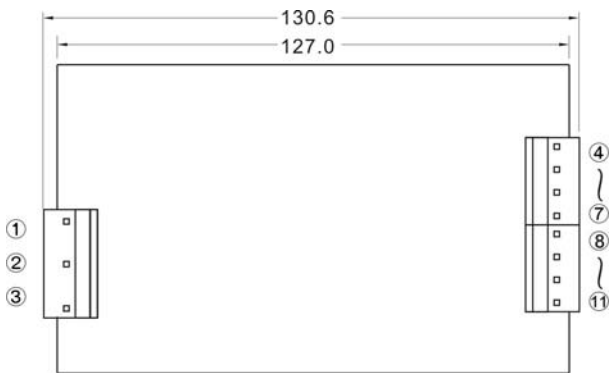
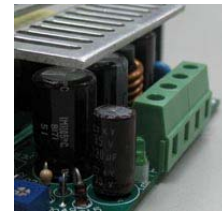
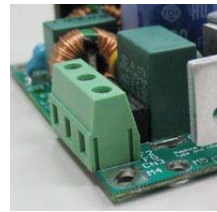
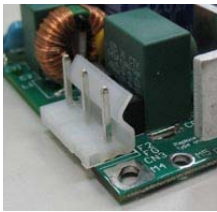
A Type (except 5S)
B Type (except 5S)

PIN#	Single
1	AC IN (L)
2	AC IN (N)
3	FG
4 ~ 7	+DC OUT
8 ~ 11	-DC OUT

PIN#	Single
1	AC IN (L)
2	AC IN (N)
3	FG
4 ~ 5	+DC OUT
6 ~ 7	-DC OUT

EFFICIENCY VERSUS LOAD
AQF1200-5S
VIN VS Efficiency

Input Voltage (V)	90	115	180	230	264
Efficiency (%)	85.37	86.17	87.46	87.76	88.14

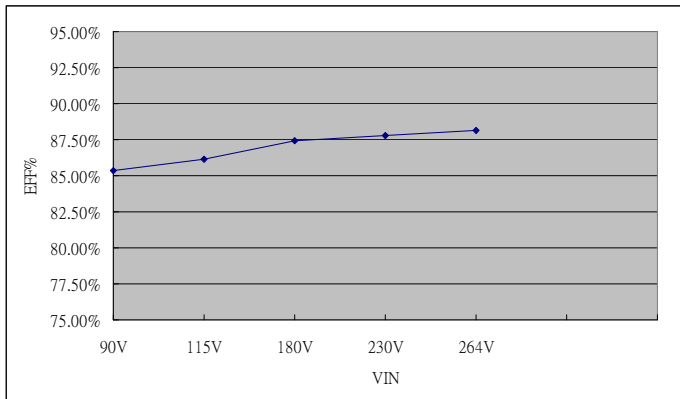
LOAD VS Efficiency

Load (%)	10	20	30	40	50
115V (%)	69.59	81.53	83.15	84.92	85.96
230V (%)	73.66	81.49	85.04	86.21	87.16
Load (%)	60	70	80	90	100
115V (%)	86.44	86.45	86.37	86.48	86.20
230V (%)	87.57	87.75	87.98	87.94	87.80

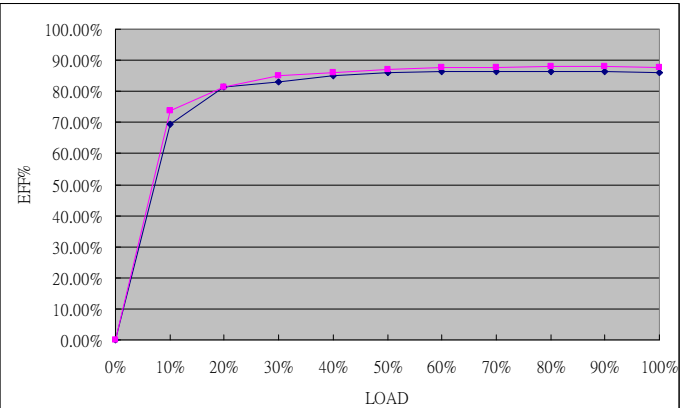
AQF1200-12S
VIN VS Efficiency

Input Voltage (V)	90	115	180	230	264
Efficiency (%)	86.45	89.96	92	92.77	92.3

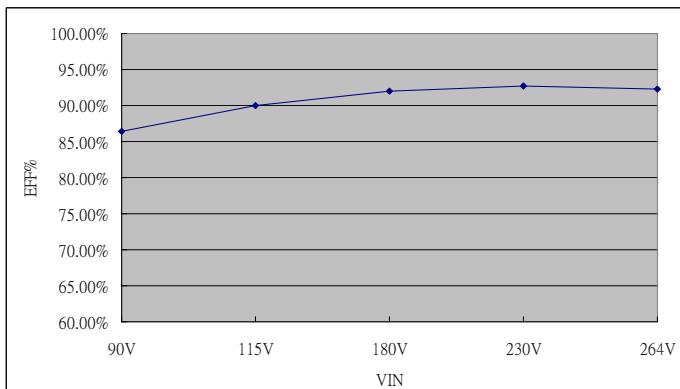

LOAD VS Efficiency

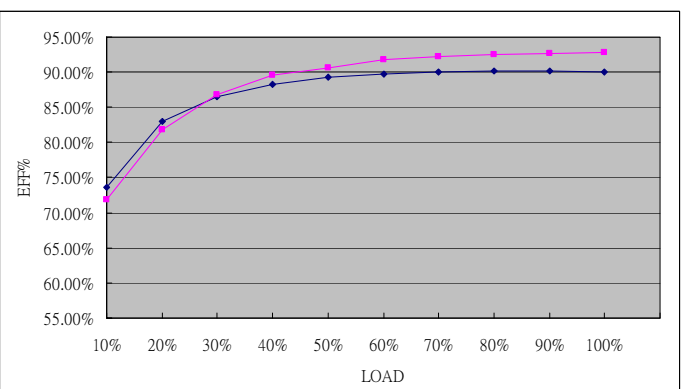
Load (%)	10	20	30	40	50
115V (%)	73.62	82.98	86.43	88.26	89.27
230V (%)	71.83	81.82	86.81	89.54	90.58
Load (%)	60	70	80	90	100
115V (%)	89.72	89.95	90.11	90.1	89.96
230V (%)	91.74	92.18	92.53	92.62	92.77

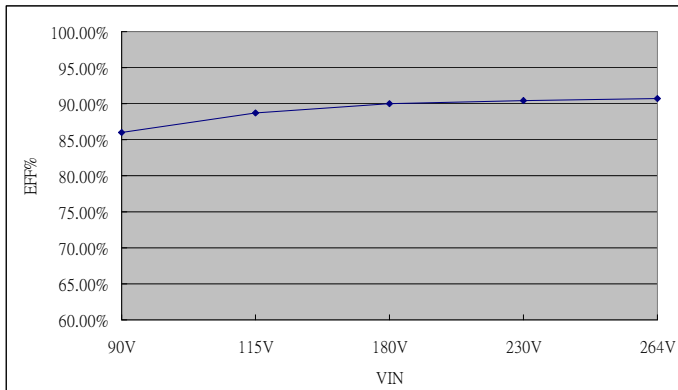

EFFICIENCY VERSUS LOAD
AQF1200-15S
VIN VS Efficiency

Input Voltage (V)	90	115	180	230	264
Efficiency (%)	86.03	88.78	90.06	90.45	90.75

LOAD VS Efficiency

Load (%)	10	20	30	40	50
115V (%)	67.05	78.17	82.74	85.07	85.52
230V (%)	67.05	77.17	82.17	84.61	86.14
Load (%)	60	70	80	90	100
115V (%)	87.40	88.34	88.44	88.67	88.78
230V (%)	87.39	88.68	89.5	90.14	90.45

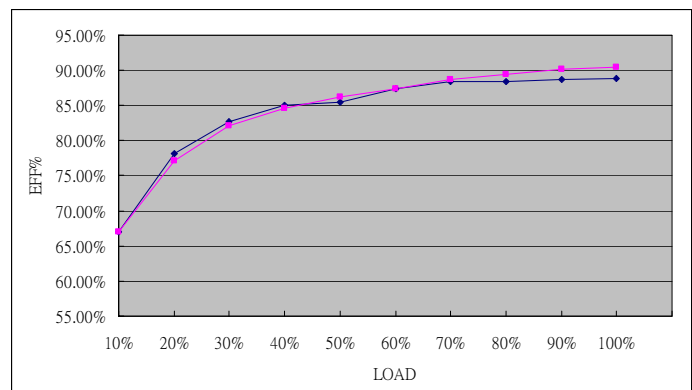
AQF1200-24S
VIN VS Efficiency

Input Voltage (V)	90	115	180	230	264
Efficiency (%)	88.78	91.27	93.11	93.52	93.81

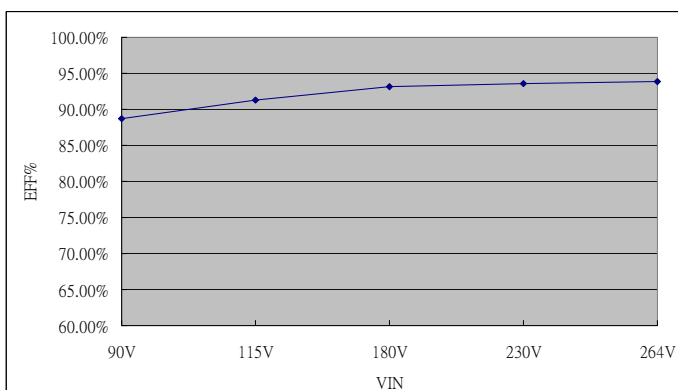

LOAD VS Efficiency

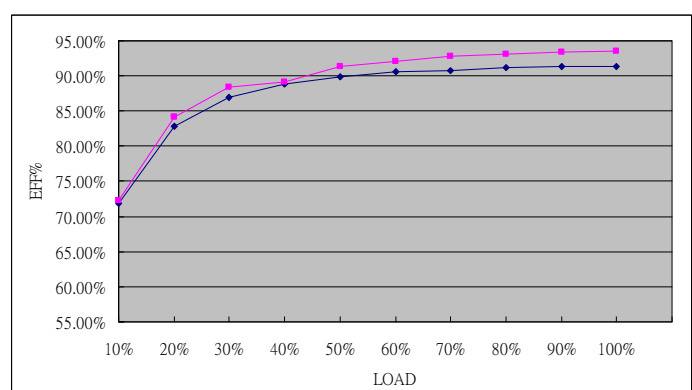
Load (%)	10	20	30	40	50
115V (%)	71.89	82.79	86.97	88.9	89.82
230V (%)	72.3	84.22	88.46	89.21	92.29
Load (%)	60	70	80	90	100
115V (%)	90.54	90.78	91.13	91.4	91.27
230V (%)	92.14	92.86	93.14	93.44	93.52

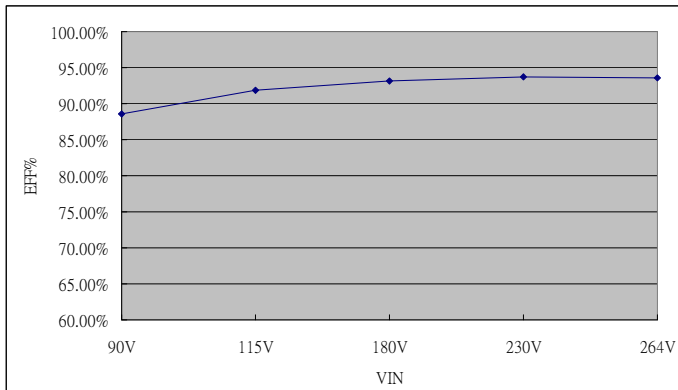

EFFICIENCY VERSUS LOAD
AQF1200-48S
VIN VS Efficiency

Input Voltage (V)	90	115	180	230	264
Efficiency (%)	88.56	91.86	93.20	93.76	93.61

LOAD VS Efficiency

Load (%)	10	20	30	40	50
115V (%)	74.99	83.9	87.25	89.17	90.01
230V (%)	67.31	79.29	84.97	88.18	89.99
Load (%)	60	70	80	90	100
115V (%)	90.69	91.18	91.46	91.84	91.86
230V (%)	91.24	92.15	92.84	93.36	93.76

