

Panasonic

DVD/CD PLAYER

Operating Instructions

Model No. **DVD-RV32/DVD-RV27/DVD-RV22**



Before connecting, operating or adjusting this product, please read these instructions completely. Please keep this manual for future reference.



As an ENERGY STAR® Partner, Panasonic has determined that this product meets the ENERGY STAR® guidelines for energy efficiency.



This manual was printed with soy based ink.

P PC PP PX GC GCS GN

Region number supported by this player

Region numbers are allocated to DVD players and software according to where they are sold.

For U.S.A., Canada, and units with PX printed on the outer packaging

- The region number of this player is "1".
- The player will play DVDs marked with labels containing "1" or "ALL".

Example:



For the Middle East and South Africa

- The region number of this player is "2".
- The player will play DVDs marked with labels containing "2" or "ALL".

Example:



For Asia

- The region number of this player is "3".
- The player will play DVDs marked with labels containing "3" or "ALL".

Example:



For Australia and N.Z.

- The region number of this player is "4".
- The player will play DVDs marked with labels containing "4" or "ALL".

Example:



[For U.S.A. only]

The warranty can be found on page 21.

En la página 23 hay una guía de referencia rápida en español.

RQT6236-1P

Dear customer

Thank you for purchasing this product. For optimum performance and safety, please read these instructions carefully.

These operating instructions are applicable to models DVD-RV32, DVD-RV27 and DVD-RV22.

Operations in these instructions are described mainly with the remote control, but you can do the operations on the main unit if the controls are the same.

[DVD-RV32]: indicates features applicable to DVD-RV32 only.

[DVD-RV27]: DVD-RV27 only.

[DVD-RV22]: DVD-RV22 only.

Getting started

Accessories



Please check and identify the supplied accessories. Use numbers indicated in parentheses when asking for replacement parts.

(Only for U.S.A.)

To order accessories contact 1-800-332-5368 or web site (<http://www.panasonic.com>).

(For other areas)

To order accessories, call the dealer from whom you have made your purchase.

1 Remote control

[For U.S.A. and Canada] (N2QAJB000043)

[For others] (N2QAJB000050)



2 Batteries

for remote control

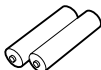

1 AC power supply cord

[For U.S.A. and Canada] [For Australia and N.Z.] [For others]
(RJA0065-A) (RJA0035-2X) (RJA0019-2X)

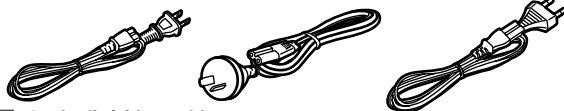

1 Audio/video cable

(VJA0788-D)

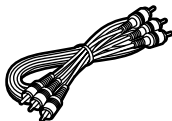

[DVD-RV32] (for units with PX printed on the outer packaging)

1 Power plug adaptor

(VJP2974)



[Note]

The included AC power supply cord is for use with this unit only. Do not use it with other equipment.

User memo:

DATE OF PURCHASE _____
DEALER NAME _____
DEALER ADDRESS _____
TELEPHONE NUMBER _____

The model number and serial number of this product can be found on either the back or the bottom of the unit. Please note them in the space provided below and keep for future reference.

MODEL NUMBER _____
SERIAL NUMBER _____

Table of contents

Getting started

Accessories	2
IMPORTANT SAFETY INSTRUCTIONS	4
Maintenance	4
Control reference guide	5
Disc information	5
[1] Connection to a television	6
[2] The remote control	7
[3] Quick Setup	7

Basic operations

Basic play	8
Replaying a scene — QUICK REPLAY	8
Setting the unit to turn off — SLEEP timer	8
Using menus to play MP3 discs	9
Resume function	9
Skipping chapters or tracks	10
Fast forward and rewind—SEARCH	10
Slow-motion play	10
Frame-by-frame viewing	10
Starting play from a selected title or track	10
4:3 TV ZOOM function	10

Advanced operations

Convenient features	11
Repeat play	11
A-B repeat play	11
Program play	11
Random play	11
Increasing your enjoyment of movies	12
Soundtracks	12
Subtitles	12
Angles	12
[A] ADVANCED SURROUND	13
[B] BASS PLUS	13
[C] CINEMA	13
[D] DIALOGUE ENHANCER	13
ONE TOUCH CINEMA MEMORY	13
Using On-Screen Menu Icons	14
Common procedures	14
Disc information	14
Unit information	15
Progress indicator	15
Changing settings	16
Common procedures	17
Entering a password (Ratings)	17
Digital output	17
Home Theater—Enjoying more powerful sound	18

Reference

Troubleshooting guide	19
Glossary	20
Limited Warranty (U.S.A.)	21
Product Service (U.S.A. and Canada)	22
Guía de referencia rápida en español	23
(Spanish Quick Reference)	
Specifications	Back cover

CAUTION!

THIS PRODUCT UTILIZES A LASER.
 USE OF CONTROLS OR ADJUSTMENTS OR PERFORMANCE OF PROCEDURES OTHER THAN THOSE SPECIFIED HEREIN MAY RESULT IN HAZARDOUS RADIATION EXPOSURE.
 DO NOT OPEN COVERS AND DO NOT REPAIR YOURSELF. REFER SERVICING TO QUALIFIED PERSONNEL.

WARNING:

TO REDUCE THE RISK OF FIRE, ELECTRIC SHOCK OR PRODUCT DAMAGE, DO NOT EXPOSE THIS APPARATUS TO RAIN, MOISTURE, DRIPPING OR SPLASHING AND THAT NO OBJECTS FILLED WITH LIQUIDS, SUCH AS VASES, SHALL BE PLACED ON THE APPARATUS.

CAUTION!

- DO NOT INSTALL, OR PLACE THIS UNIT, IN A BOOKCASE, BUILT-IN CABINET OR IN ANOTHER CONFINED SPACE. ENSURE THE UNIT IS WELL VENTILATED. TO PREVENT RISK OF ELECTRIC SHOCK OR FIRE HAZARD DUE TO OVERHEATING, ENSURE THAT CURTAINS AND ANY OTHER MATERIALS DO NOT OBSTRUCT THE VENTILATION VENTS.
- DO NOT OBSTRUCT THE UNIT'S VENTILATION OPENINGS WITH NEWSPAPERS, TABLECLOTHS, CURTAINS, AND SIMILAR ITEMS.
- DO NOT PLACE SOURCES OF NAKED FLAMES, SUCH AS LIGHTED CANDLES, ON THE UNIT.
- DISPOSE OF BATTERIES IN AN ENVIRONMENTALLY FRIENDLY MANNER.

THE FOLLOWING APPLIES ONLY IN THE U.S.A. AND CANADA:

CAUTION:

TO PREVENT ELECTRIC SHOCK MATCH WIDE BLADE OF PLUG TO WIDE SLOT, FULLY INSERT.

For the Middle East, South Africa and Asia
 THIS UNIT IS INTENDED FOR USE IN TROPICAL CLIMATES.

For Australia, N.Z. and units with PX printed on the outer packaging
 THIS UNIT IS INTENDED FOR USE IN MODERATE CLIMATES.

This product may receive radio interference caused by mobile telephones during use. If such interference is apparent, please increase separation between the product and the mobile telephone.

DANGER	- VISIBLE AND INVISIBLE LASER RADIATION WHEN OPEN. AVOID DIRECT EXPOSURE TO BEAM. (FDA 21 CFR)
CAUTION	- VISIBLE AND INVISIBLE LASER RADIATION WHEN OPEN. AVOID EXPOSURE TO BEAM. (IEC60825-1)
ATTENTION	- RAYONNEMENT LASER VISIBLE ET INVISIBLE EN CAS D'OUVERTURE. EXPOSITION DANGEREUSE AU FASCEAU.
ADVARSEL	- SYNLIG OG USYNLIG LASERSTRÅLING VED ÅBNING. UNDGÅ UDSÆTTELSE FOR STRÅLING.
VARO!	- AVATTAESSA OLET ALTTIINA NÄKYVÄÄ JA NÄKYMÄTÖN LASERSÄTEILYLLE. ÄLÄ KATSO SÄTEESEEN.
VARNING	- SYNLIG OCH OSYNLIG LASERSTRÅLNING NÄR DENNA DEL ÄR ÖPPNAD. BETRÄKTA EJ STRÅLEN.
ADVARSEL	- SYNLIG OG USYNLIG LASERSTRÅLING NÄR DEKSEL ÅPNES. UNNGÅ EKSPONERING FOR STRÅLEN.
VORSICHT	- SICHTBARE UND UNSICHTBARE LASERSTRALHUNG, WENN ABDECKUNG GEOFFNET. NICHT DEM STRAHL AUSSETZEN.
注意	- 打开时有可见及不可见激光辐射。避免激光束照射。
注意	- ここを開くと可視及び不可視のレーザー光が出ます。ビームを直接見たり、触れたりしないでください。 RQLS0233

(Inside of product)

THE FOLLOWING APPLIES ONLY IN THE U.S.A.:

CAUTION:

This equipment has been tested and found to comply with the limits for a Class B digital device, pursuant to Part 15 of the FCC Rules.

These limits are designed to provide reasonable protection against harmful interference in a residential installation. This equipment generates, uses and can radiate radio frequency energy and, if not installed and used in accordance with the instructions, may cause harmful interference to radio communications. However, there is no guarantee that interference will not occur in a particular installation. If this equipment does cause harmful interference to radio or television reception, which can be determined by turning the equipment off and on, the user is encouraged to try to correct the interference by one or more of the following measures:

- Reorient or relocate the receiving antenna.
- Increase the separation between the equipment and receiver.
- Connect the equipment into an outlet on a circuit different from that to which the receiver is connected.
- Consult the dealer or an experienced radio/TV technician for help.

Any unauthorized changes or modifications to this equipment would void the user's authority to operate this device.

This device complies with Part 15 of the FCC Rules. Operation is subject to the following two conditions: (1) This device may not cause harmful interference, and (2) this device must accept any interference received, including interference that may cause undesired operation.

THE FOLLOWING APPLIES ONLY IN THE U.S.A. AND CANADA:



CAUTION

RISK OF ELECTRIC SHOCK

DO NOT OPEN



CAUTION: TO REDUCE THE RISK OF ELECTRIC SHOCK, DO NOT REMOVE SCREWS. NO USER-SERVICEABLE PARTS INSIDE. REFER SERVICING TO QUALIFIED SERVICE PERSONNEL.

The lightning flash with arrowhead symbol, within an equilateral triangle, is intended to alert the user to the presence of uninsulated "dangerous voltage" within the product's enclosure that may be of sufficient magnitude to constitute a risk of electric shock to persons.

The exclamation point within an equilateral triangle is intended to alert the user to the presence of important operating and maintenance (servicing) instructions in the literature accompanying the appliance.

[DVD-RV32]

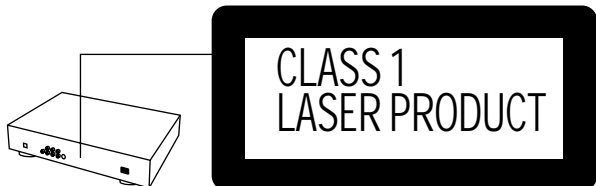

The laser product label has not been attached to products for U.S.A. and Canada.

IMPORTANT SAFETY INSTRUCTIONS

Read these operating instructions carefully before using the unit. Follow the safety instructions on the unit and the safety precautions listed below. Keep these operating instructions handy for future reference.

Safety

1. **Power source**—Connect the unit to a power source of the type described in these instructions or as marked on the unit.
2. **Polarization**—The unit is equipped with a polarized power plug where one blade is wider than the other. This safety feature ensures that the plug fits into your household AC outlet only one way. If the plug doesn't fit one way, try reversing it. If the plug still doesn't fit, contact an electrician to replace the obsolete outlet. Do not attempt to defeat the safety purpose of the plug.
3. **Power cord protection**—Route the AC power supply cord so that it will not be walked on or pinched by items placed on or against it. Never take hold of the plug or cord with wet hands. Always grasp the plug body firmly when connecting and disconnecting it.
4. **Overloading**—When connecting the AC power supply cord, be careful not to overload the household AC outlet, extension cord, or outlet from any other device as this can result in fire or electric shock.
5. **Nonuse periods**—Turn the unit off when it is not in use. Unplug the unit from the household AC outlet if it is not to be used for a long time. Unplug the unit during lightning storms.
6. **Attachments and accessories**—Use only the attachments and accessories recommended in these operating instructions.

Installation

Placement

1. **Ventilation**—Situate the unit so that it receives proper ventilation. Do not install in a confined space such as a bookcase or cabinet. Allow at least 10 cm (4 inches) clearance from the rear of the unit. To prevent the risk of electric shock or fire due to overheating ensure curtains and other materials do not obstruct the unit's ventilation.
2. **Foreign material**—Ensure objects and liquids do not get into the unit. Avoid exposing the unit to excessive smoke, dust, mechanical vibration, and shock.
3. **Magnetism**—Situate the unit away from equipment and devices that generate strong magnetic fields.
4. **Stacking**—Do not place heavy objects on top of this unit.
5. **Surface**—Place the unit on a flat, level surface.
6. **Carts and stands**—Use the unit only with carts and stands recommended by the manufacturer. Move carts with care. Sudden stops, excessive force, and uneven surfaces can cause carts to overturn.
7. **Wall and ceiling mounting**—Do not mount the unit on walls or ceilings unless specified in the instructions.



Do not place the unit on amplifiers or equipment that may become hot.

The heat can damage the unit.

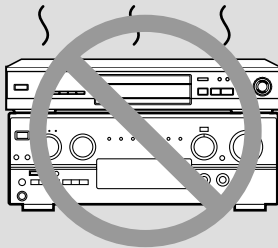

Environment

1. **Water and moisture**—Do not use the unit near water, such as near a bathtub or swimming pool. Avoid damp basements.
2. **Heat**—Situate the unit away from heat sources, such as radiators. Do not situate where temperatures fall below 5 °C (41 °F) or rise above 35 °C (95 °F).

Maintenance

(See below for details.)

Unplug the unit from the household AC outlet before cleaning. Clean with a damp cloth. Do not use abrasive pads, scouring powders, or solvents.

Service

1. **Damage requiring service**—The unit should be serviced by qualified service personnel if:
 - (a) The AC power supply cord or the plug has been damaged; or
 - (b) Objects or liquids have gotten into the unit; or
 - (c) The unit has been exposed to rain; or
 - (d) The unit does not operate normally or exhibits a marked change in performance; or
 - (e) The unit has been dropped or the cabinet damaged.
2. **Servicing**—Do not attempt to service the unit beyond that described in these operating instructions. Refer all other servicing to authorized servicing personnel.
3. **Replacement parts**—When parts need replacing ensure the servicer uses parts specified by the manufacturer or parts that have the same characteristics as the original parts. Unauthorized substitutes may result in fire, electric shock, or other hazards.
4. **Safety check**—After repairs or service, ask the servicer to perform safety checks to confirm that the unit is in proper working condition.

Item 2 in "Safety" applies only in the U.S.A. and Canada.

Maintenance

To clean this unit, wipe with a soft, damp cloth.

- Never use alcohol, paint thinner or benzine to clean this unit.
- Before using chemically treated cloth, read the instructions that came with the cloth carefully.

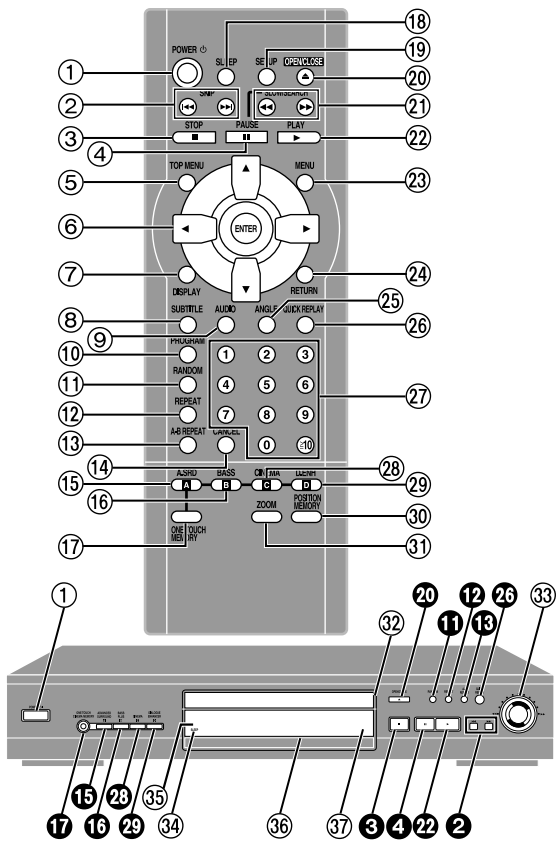

Buttons such as 2 function the same as the controls on the remote control. The actual marking of the standby/on switch depends on the area. Illustrations in these operating instructions use the markings shown in the above illustration.

1	Standby/on switch (⏻)	7
2	Skip buttons (◀◀, ▶▶) SKIP	10
3	Stop button (■ STOP)	8
4	Pause button (⏸ PAUSE)	8
5	Top menu button (TOP MENU)	8, 9
6	Cursor buttons (▲, ▼, ◀, ▶)/Enter button (ENTER)	8
7	Display button (DISPLAY)	14
8	Subtitle button (SUBTITLE)	12
9	Audio button (AUDIO)	12
10	Program button (PROGRAM)	11
11	Random play button (RANDOM)	11
12	Repeat button (REPEAT)	11
13	A-B repeat button (A-B REPEAT)	11
14	Cancel button (CANCEL)	11
15	Advanced Surround button ([A] A.SRD)	13
16	Bass plus button ([B] BASS)	13
17	One touch cinema memory button (ONE TOUCH MEMORY)	13
18	Sleep button (SLEEP)	8
19	Setup button (SETUP)	7, 17
20	Open/Close button (▲ OPEN/CLOSE)	8
21	Slow/Search buttons (◀◀, ▶▶ SLOW/SEARCH)	10
22	Play button (▶ PLAY)	8
23	Menu button (MENU)	8, 9
24	Return button (RETURN)	7
25	Angle button (ANGLE)	12
26	Quick replay button (QUICK REPLAY)	8
27	Numbered buttons (1-9, 0, ≥10)	8
28	Cinema button ([C] CINEMA)	13
29	Dialogue Enhancer button ([D] D.ENH)	13
30	Position memory button (POSITION MEMORY)	9
31	4:3 TV ZOOM button (ZOOM)	10
32	Disc tray	8
33	Shuttle dial (◀◀, ▶▶)	10
34	Sleep indicator (SLEEP)	8
35	Remote control signal sensor	
36	Display	
37	[DVD-RV32] (For units sold outside U.S.A. and Canada)	

Getting started

Disc information

Discs that can be played

DVD-Video	DVD-R	Audio CD	Video CD
Indication used in instructions			
[DVD]		[CD]*	[VCD]

*Including CD-R/RW and discs recorded with MP3 (and WMA for the U.S.A., Canada and units with PX printed on the outer packaging [DVD-RV32] [DVD-RV27]).

Do not use irregularly shaped discs (e.g. heart-shaped), as these can damage the unit.

Discs that cannot be played

DVD-Audio, PAL discs*, DVD-ROM, DVD-RAM, CD-ROM, CDV, CD-G, +RW, DVD-RW, CVD, SVCD, SACD, Divx Video Discs and Photo CD.

*Only for U.S.A., Canada and units with PX printed on the outer packaging

DVDs that can be played

This unit has a Dolby Digital decoder so you can play DVDs with this mark.



This unit does not have a DTS decoder. Connect this unit to equipment that has a DTS decoder to enjoy DVDs with this mark.

Playing DVDs and Video CDs

The producer of these discs can control how they are played so you may not always be able to control play as described in these operating instructions. Read the disc's instructions carefully.

Video systems

(For the Middle East, South Africa, Asia, Australia and N.Z.)

This unit can play both the PAL and NTSC video systems. To view PAL or NTSC, however, your television must match the system used on the disc. PAL discs cannot be correctly viewed on an NTSC television. NTSC can be correctly viewed on a PAL television by converting the video signal to PAL 60 (➡ page 16, Video—NTSC Disc Output).

CD-R and CD-RW discs

This unit can play CD-DA (digital audio) and video CD format audio CD-R and CD-RW that have been finalized (a process that enables CD-R and CD-RW players to play audio CD-R and CD-RW) upon completion of recording. It may not be able to play some CD-R/RW due to the condition of the recording.

DVD-R discs

Panasonic DVD-R recorded and finalized on a Panasonic DVD video recorder are played as DVD-Video on this unit.

It may not be possible to play these discs in all cases due to the type of disc or condition of the recording.

Handling precautions

- Do not write on the label side with a ball-point pen or other writing instrument.
- Do not use record cleaning sprays, benzene, thinner, static electricity prevention liquids or any other solvent.
- Do not attach labels or stickers to discs. (Do not use discs with exposed adhesive from tape or left over peeled-off stickers.)
- Do not use scratch-proof protectors or covers.
- Do not use discs printed with label printers available on the market.

[1] Connection to a television

This page explains how to connect the unit to a television and set it up so you hear the audio through the television's speakers. To get the full benefit from the powerful 5.1-channel audio found on DVDs, you should connect an amplifier and six speakers (➔ page 18).

Before connection

- Disconnect the AC power supply cord.
- Refer to the television's operating instructions.

Connect your unit directly to your television.

Do not connect the unit through your video cassette recorder when setting up your home entertainment system, because the picture may not be played correctly due to the copy guard.

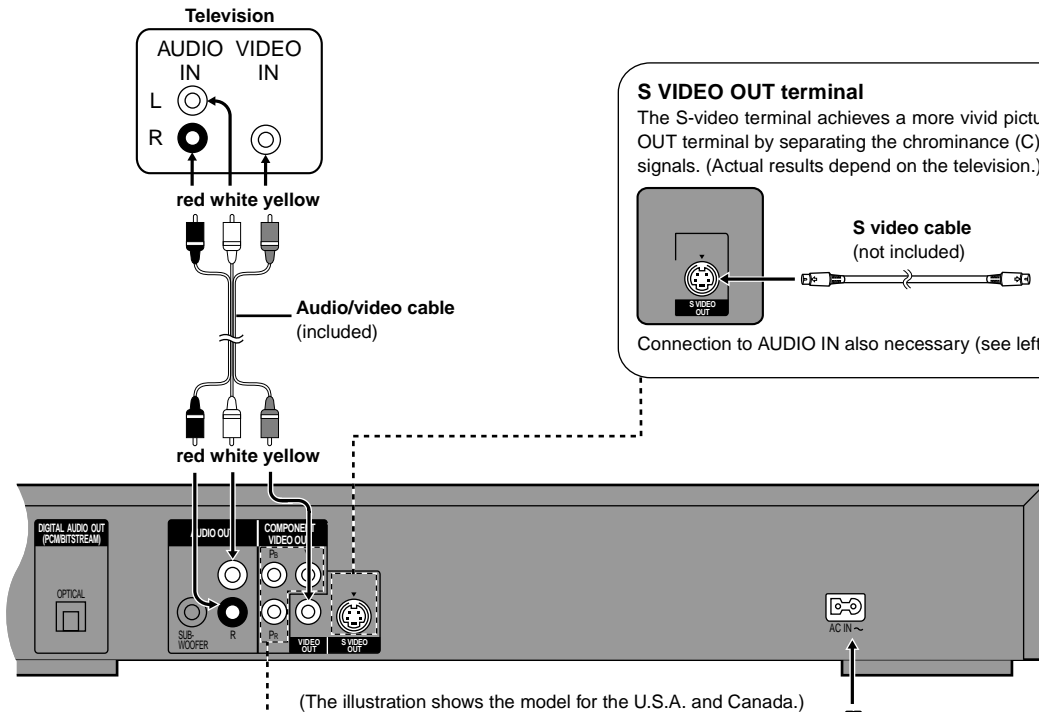

S VIDEO OUT terminal

The S-video terminal achieves a more vivid picture than the VIDEO OUT terminal by separating the chrominance (C) and luminance (Y) signals. (Actual results depend on the television.)

Television
S VIDEO IN

S video cable (not included)

Connection to AUDIO IN also necessary (see left)

COMPONENT VIDEO OUT terminal

Connection using these terminals outputs the color difference signals (Pb/P_R) and luminance signal (Y) separately in order to achieve high fidelity in reproducing colors.

- The description of the component video input terminals depends on the television or monitor (e.g. Y/P_B/P_R, Y/B-Y/R-Y, Y/C_B/C_R). Connect to terminals of the same color.

[For U.S.A., \Canada and units with PX printed on the outer packaging]

- After making this connection, change the black level for a better picture (➔ page 16, Video—Black Level Control).

Television
COMPONENT VIDEO IN
Y
P_B
P_R

Video cable (not included)

Connection to AUDIO IN also necessary (see above)

[DVD-RV32] (for units with PX printed on the outer packaging)
If the power plug does not fit your AC outlet
 • Use the power plug adaptor (included).

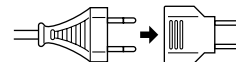

If it still doesn't fit, contact an electrical parts distributor for assistance.

Conserving power

This unit consumes a small amount of power, even when it is turned off.

[DVD-RV32]	approx. 2 W
(For U.S.A. and Canada)	approx. 3 W
(For others)	approx. 2 W
[DVD-RV27] [DVD-RV22]	approx. 2 W

To save power when the unit is not to be used for a long time, unplug it from the household AC outlet.

[2] The remote control

■ Batteries

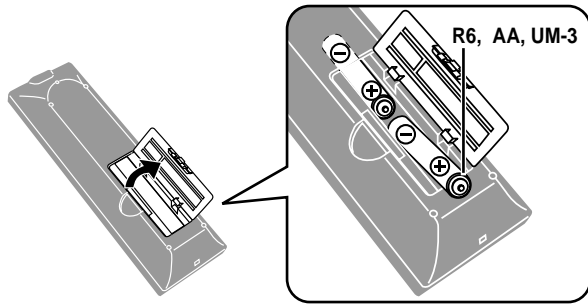

- Insert so the poles (+ and -) match those in the remote control.
- Do not use rechargeable type batteries.

Do not:

- mix old and new batteries.
 - use different types at the same time.
 - heat or expose to flame.
 - take apart or short circuit.
 - attempt to recharge alkaline or manganese batteries.
 - use batteries if the covering has been peeled off.
- Mishandling of batteries can cause electrolyte leakage which can damage items the fluid contacts and may cause a fire.

Remove if the remote control is not going to be used for a long period of time. Store in a cool, dark place.

■ Use

Aim at the sensor, avoiding obstacles, at a maximum range of 7 m (23 feet) directly in front of the unit.

[3] Quick Setup

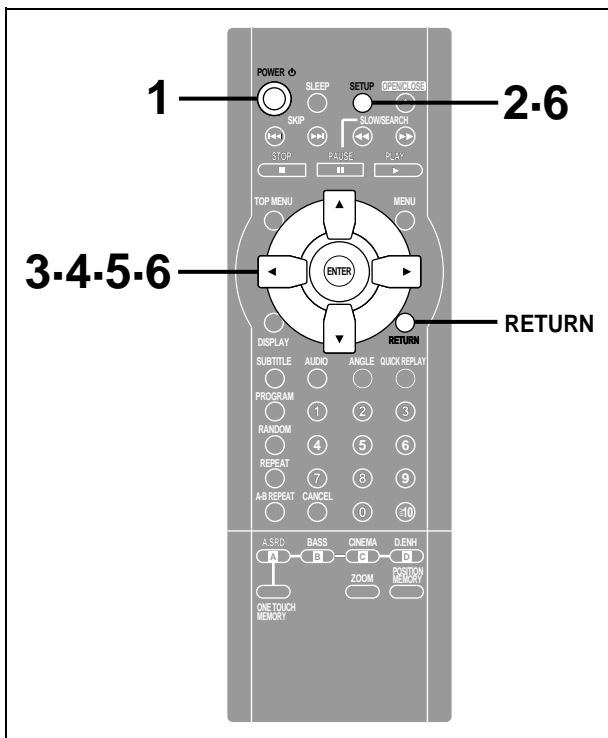

Remote control only

The **QUICK SETUP** screen appears when you press [SETUP] the first time after purchase and assists you to make necessary settings.

Preparation

Turn on the television and select the appropriate video input on the television to suit the connections for the player.

1 Press [POWER] to turn on the unit.

2 Press [SETUP] to show the Quick Setup screen.
e.g. For U.S.A., Canada and units with PX printed on the outer packaging

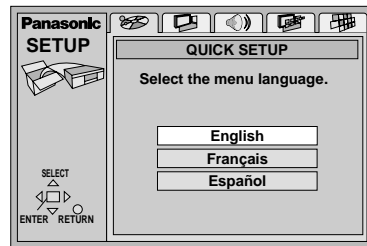

3 Press [▲, ▼, ◀, ▶] to select the menu language and press [ENTER].

4 Press [▲, ▼] to select “Yes” to continue and press [ENTER].

5 Press [▲, ▼, ◀, ▶] to select the item and press [ENTER].

- Audio Language (For setting details ➔ page 16)
- Subtitle Language (For setting details ➔ page 16)
- TV Aspect (For setting details ➔ below)

6 Press [ENTER] and then [SETUP] to end the settings.

To return to the previous screen

Press [RETURN].

■ TV Aspect

Select “4:3” (regular) or “16:9” (widescreen) to suit your television.

If you have a regular 4:3 television, you can also select how video on some discs is shown (➔ page 16, Video—TV Aspect).

•4:3 Pan&Scan (Factory preset)

The pan and scan (the original widescreen images are converted for viewing on a regular television) version of the video is automatically selected if recorded on the disc.



•4:3 Letterbox

The letterbox (the original widescreen images appear with black bands above and below) version of the video is automatically selected if recorded on the disc.



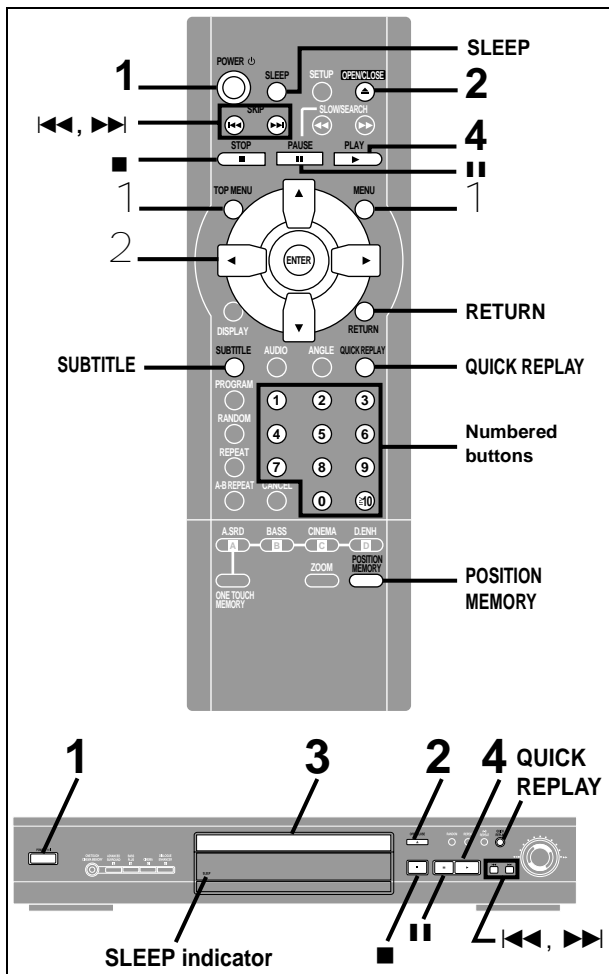

[Note]

● If "Ⓞ" appears on the television

- The operation is prohibited by the unit or disc.
- The disc continues to rotate while the menu is displayed even after you finish playing an item. Press [■] when you finish to preserve the unit's motor and your television screen.
- Volume may be lower when playing DVDs than when playing other discs or during television broadcasts. If you turn the volume up on the television or amplifier, be sure to reduce the volume again before playing other sources so that a sudden increase in output does not occur.

When a menu screen appears on the television

[DVD] [VCD]

Press the numbered buttons to select an item.

To select a 2-digit number

Example: To select item 23, press ≥ 10 ⇒ [2] ⇒ [3].

- When playing DVDs, you can also use [▲], [▼], [◀], [▶] to select items. Press [ENTER] to confirm your selection.

Play of the selected item now begins.

Other buttons used to operate menus

Read the disc's instructions for further details about operation.

- [▶▶]: Shows the next menu.
- [◀◀]: Shows the previous menu.
- [RETURN]: Shows the menu screen. [VCD]
- [TOP MENU]: Shows the first menu screen. [DVD]
- [MENU]: Shows the menu screen. [DVD]

Replaying a scene — QUICK REPLAY

[DVD] [CD] [VCD]

During play

Press [QUICK REPLAY].

Play skips back a few seconds each time you press the button.

- You cannot skip beyond the beginning of a track or title.
- This feature doesn't work with some discs.

Setting the unit to turn off — SLEEP timer

[DVD] [CD] [VCD]

Remote control only

Press [SLEEP] to select the setting.

Each time you press the button:
OFF → AUTO* → 60 min → 90 min → 120 min

- *The unit turns off 5 minutes after play finishes. The SLEEP indicator lights when the sleep timer is on.

For example:

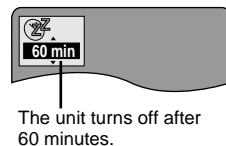

To cancel the SLEEP timer

Press [SLEEP] to select "OFF".

To confirm the remaining time

Press [SLEEP].

[Note]

- AUTO also works with DVDs that show a menu after play finishes.
- AUTO does not work if you press [■], [MENU], or [TOP MENU]. It is activated again when you restart play.
- AUTO does not work correctly with some discs (e.g., if menus appear after playing video CDs).

Auto standby

The unit switches to standby mode after about 30 minutes in the stop mode, irrespective of the SLEEP setting.

[DVD] [CD] [VCD]

Preparation

Turn on the television and select the appropriate video input on the television to suit the connections for the player.

- Press [POWER] to turn on the unit.
- Press [▲] to open the disc tray.
- Place the disc on the disc tray.

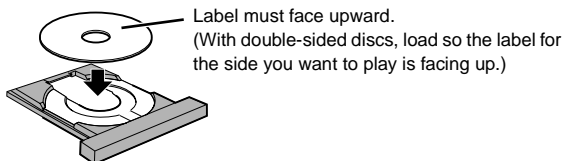

4 Press [▶] (PLAY).

The disc tray closes and play begins.
[CD] (MP3 discs)
Group and track names are displayed on the television.
Press [SUBTITLE] to change the display.

To stop play

Press [■] (⇒ page 9, Resume function).

To pause play

Press [||] during play.
Press [▶] (PLAY) to restart play.

Using menus to play MP3 discs

[CD] (MP3 discs)

This unit can play MP3 files recorded on CD-R/RW with a computer. Files are treated as tracks and folders are treated as groups.

1 Press [TOP MENU] or [MENU].

A file list appears.

Group name

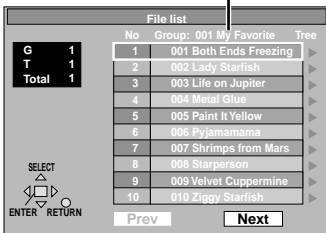

2 Press [▲, ▼] to select the track and press [ENTER].

Play starts and continues to the last track in the last group. "◀" indicates the track currently playing.

To show other pages

Press [▲, ▼, ◀, ▶] to select "Prev" or "Next" and press [ENTER]. After listing all the tracks in one group, the list for the next group appears.

To close the file list screen

Press [TOP MENU] or [MENU].

Using the tree screen to find a group

1 Press [▶] while a track is highlighted to display the tree screen.

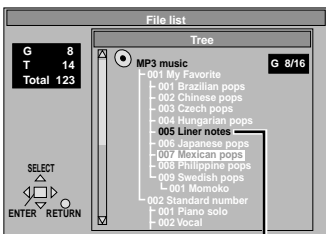

You cannot select groups that contain no compatible files.

2 Press [▲, ▼] to select a group and press [ENTER].

The file list for the group appears.

For your reference

- Press [◀, ▶] to jump layers in the tree screen.
- [Note]
- Discs must conform to ISO9660 level 1 or 2 (except for extended formats). MP3 files must have the extension ".MP3" or ".mp3".
- This unit is compatible with multi-session but if there are a lot of sessions it takes more time for play to start. Keep the number of sessions to a minimum to avoid this.
- This unit is not compatible with ID3 tags.
- This unit is not compatible with files with a sampling rate of 32 kHz.

[DVD-RV32] [DVD-RV27]

(For U.S.A., Canada and units with PX printed on the outer packaging)

This unit can also play Windows Media Audio (WMA).

- When creating a WMA disc, ensure the copyright feature is off.
- WMA files must have the extension ".WMA" or ".wma".
- This unit can play WMA files with a compression rate of 48 kbps or more.
- Noise may occur when playing WMA files.
- There are some files this unit cannot play (e.g., copyright protected). "TRACK PROTECTED" or "CANNOT PLAY THIS TRACK" appear on the unit's display to indicate such tracks.

Naming folders and files

At the time of recording, prefix folder and file names with 3-digit numbers in the order you want to play them (this may not work at times).

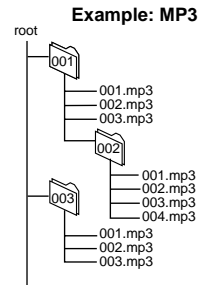

Windows Media, and the Windows logo are trademarks, or registered trademarks of Microsoft Corporation in the United States and/or other countries.

WMA is a compression format developed by Microsoft Corporation. It achieves the same sound quality as MP3 with a file size that is smaller than that of MP3.



Resume function

[DVD] [CD] [VCD]

(When the elapsed play time is displayed)

The position you stopped play at is recorded by the unit when "▷" is flashing on the display.

e.g. DVD



While "▷" is flashing, press [▶] (PLAY) to start play from where you stopped it. (When playing DVD → Chapter Preview below)

- The position is cleared when the disc tray is opened or the unit is switched to standby.
- Press [■] to clear the position.

Position Memory function

This function allows you to memorize a position to start from even after switching the unit to standby or changing discs.

1. During play, press [POSITION MEMORY].
2. Press [POWER ⏻] to switch the unit to standby, or press [▲] to remove the disc.
3. When you are ready to play the disc again, press [▶] (PLAY). Play starts from the memorized position and the position is cleared. (When playing DVD → Chapter Preview below)

Position memorized

To clear the position before play
Press [■].

- You can memorize positions on up to five different discs at a time. When you memorize another position, the earliest position is replaced.

Chapter Preview [DVD]

One of these messages appears immediately after you press [▶] (PLAY).

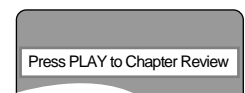
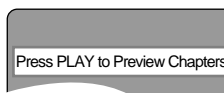

Press [▶] (PLAY) while the message is displayed and the beginning portions of each chapter up to the current one are played. Full play resumes from the point where you pressed [■] or [POSITION MEMORY]. (This feature works only within a title.)

If you do not press [▶] (PLAY), the message disappears and play starts from where you pressed [■] or [POSITION MEMORY].

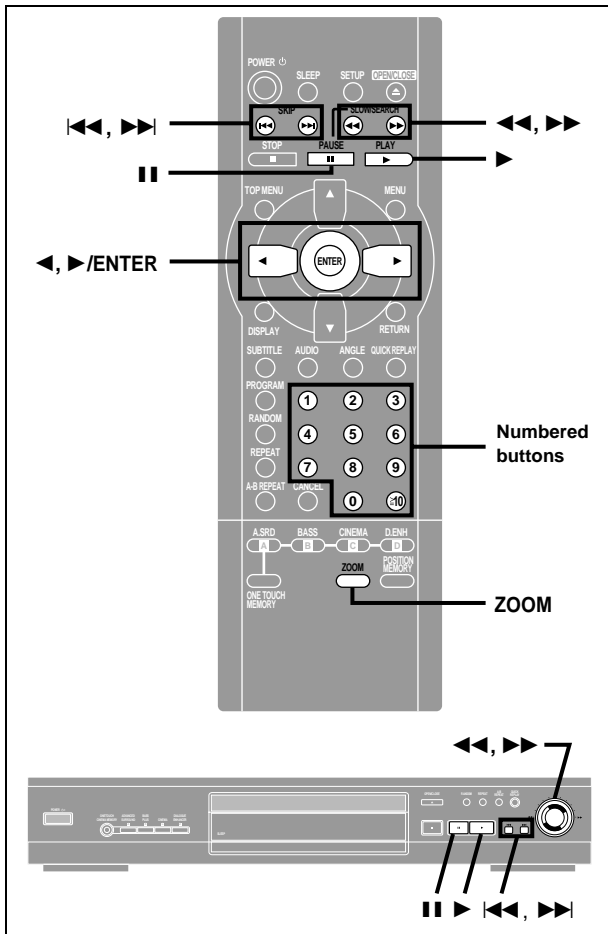

Skipping chapters or tracks

[DVD] [CD] [VCD]

During play or while paused

Press [**◀◀**] or [**▶▶**].

- Each press increases the number of skips.

Fast forward and rewind—SEARCH

[DVD] [CD] [VCD]

During play

Press [**◀◀**] or [**▶▶**].

Turn the shuttle dial [**◀◀**, **▶▶**] on the main unit.

- Play starts again when you release the shuttle dial.
- Audio will be heard during search (except for WMA files). You can turn this audio off if you want to (➡ page 16, Audio—Audio during Search).

Slow-motion play

[DVD] [VCD]

While paused

Press [**◀◀**] or [**▶▶**].

Turn the shuttle dial [**◀◀**, **▶▶**] on the main unit.

- The picture stills again when you release the shuttle dial.

Frame-by-frame viewing

[DVD] [VCD]

Remote control only

While paused

Press [**◀**] or [**▶**].

The frame changes each time you press the button.

- The frames change in succession if you press and hold the button.
- Pressing [**⏮**] also activates forward frame-by-frame.

Notes

- The speed of search and slow-motion increases up to 5 steps.
- Press [**▶**] (PLAY) to restart play.
- You cannot move backwards with Video CD during slow-motion and frame-by-frame.

When playing Video CDs with playback control

Turning the shuttle dial or pressing buttons to perform skip, search or slow-motion may take you to a menu screen.

Starting play from a selected title or track

[DVD] [CD] [VCD]

Press the numbered buttons to select the item.

To select a 2-digit number

Example: To select track 23, press [**≥10**] ➡ [**2**] ➡ [**3**].

Play starts from the selected item.

[Note]

- This works only when stopped with some discs.
- **MP3 discs**
Press [ENTER] after pressing the numbered buttons. (You do not have to press [**≥10**].)

4:3 TV ZOOM function

[DVD]

Remote control only

Widescreen software often appears as a letterbox picture when shown on a regular 4:3 aspect television. Use 4:3 TV ZOOM to expand these pictures to fill more of the television. (The sides of the picture are cut off when you do this.)

During play

Press [**ZOOM**].

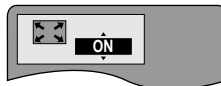

- Press again to cancel.
- 4:3 TV ZOOM is also canceled when you open the disc tray or switch the unit to standby.

[Note]

- Depending on the video format of the disc and current play status, this feature may not work as described.
- Menus may act or appear differently while 4:3 TV ZOOM is on.

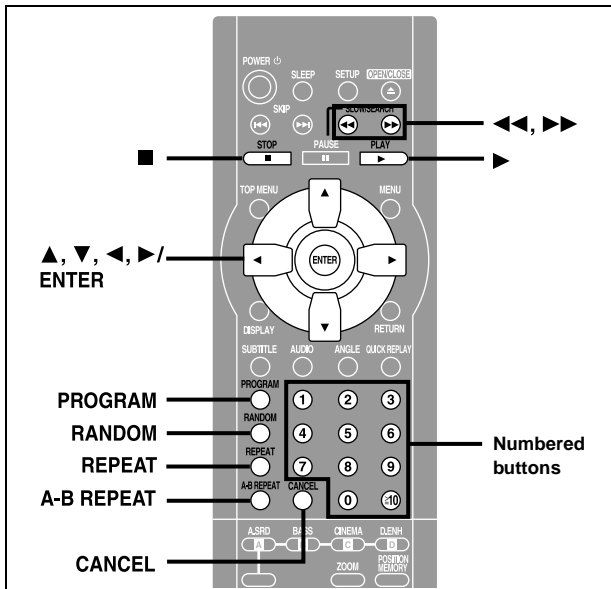

[DVD] [CD] [VCD]

(When the elapsed play time is displayed)

Repeat play

During play

Press [REPEAT].

Each time you press the button:

[DVD]
Chapter (C) → Title (T)* → OFF

[CD] [VCD]
Track (T) → Entire disc (A) → OFF

[CD] (MP3 discs)
Track (T) → Group (G)* → OFF

*"All (A)" during program and random play.

For example: DVD



If the Video CD has playback control

1. Press [■] during play until "PBC PLAY" is cleared from the display.
2. Press the numbered buttons to select a track to start play (➡ page 10).
3. Press [REPEAT] (➡ above).

[Note]

You cannot use repeat play to repeat an entire DVD or an entire MP3 disc.

To repeat only your favorite tracks/chapters

Start program play (see right) and press [REPEAT] to display "A".

A-B repeat play

You can repeat a section between points A and B within a title or track.

During play

1 Press [A-B REPEAT] at the starting point (A).

2 Press [A-B REPEAT] at the finishing point (B).

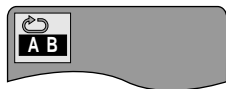

e.g. DVD



To cancel

Press [A-B REPEAT] until "A-B REPEAT" is displayed.

[Note]

- Some subtitles recorded around point A or B may fail to appear. [DVD]
- The unit automatically determines the end of a title/track as point B when the end of the title/track is reached.
- A-B repeat is canceled when you press [QUICK REPLAY].

Program play

Remote control only

You can select up to 32 items to play in the order you choose.

While stopped

1 Press [PROGRAM].

e.g. CD

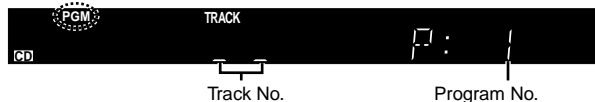
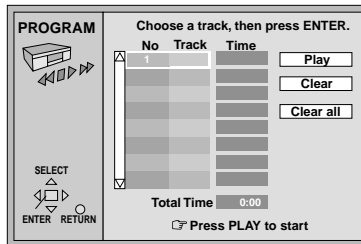

2 [DVD,MP3\discs\only] Press the numbered buttons to select a title (DVD) or group (MP3 discs).

- Some items cannot be selected.
- Different titles have different soundtrack and subtitles.

3 Press the numbered buttons to select a track (CD or VCD) or chapter (DVD) (and, for MP3 discs press [ENTER]).

- Repeat steps 2 and 3 to program other items.
- To select an item using the cursor buttons
Press [ENTER] and [▲, ▼] to select an item, then press [ENTER] again to register the number.
All the items on a disc, a title or a group are selected when you select "ALL".
- Times are not displayed when programming DVD and MP3.

4 Press [▶] (PLAY).

Play now begins in the programmed sequence.

- Some items cannot be played even if you programmed them. [DVD]

To add or change items

Press [▲, ▼] to select an available item, then repeat steps 2 and 3.

To move to the page before or after the one shown

Press [◀] or [▶].

To clear the programmed items one by one

Press [▲, ▼] to select the item number (No) and press [CANCEL]. (Alternatively, you can select "Clear" with [▲, ▼, ◀, ▶] and press [ENTER].)

To clear the whole program

Move to "Clear all" with [▲, ▼, ◀, ▶] and press [ENTER]. The whole program is also cleared when the unit is turned off or the disc tray is opened.

To exit the program mode

Press [PROGRAM] while stopped. (The program is retained in memory.)

Random play

While stopped

1 Press [RANDOM].

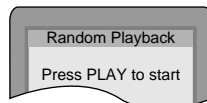

e.g. CD



2 Press the numbered buttons to select a title (DVD only) and press [▶] (PLAY).

- Some titles cannot be selected. [DVD]
- Play now begins in random order.

To exit the random mode

Press [RANDOM] while stopped.

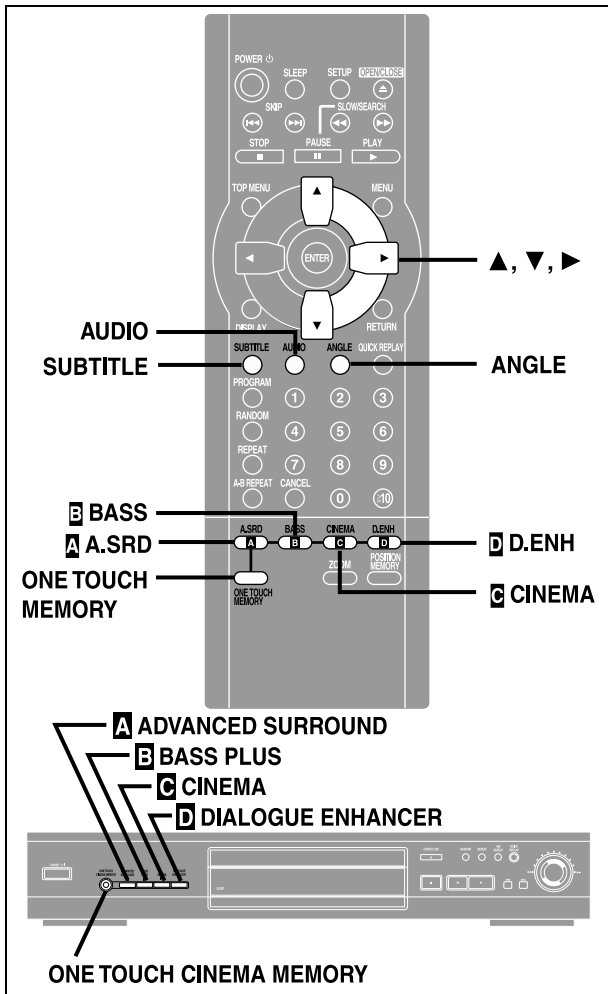

[DVD]

Remote control only

Some DVDs have multiple soundtracks, subtitle languages and camera angles, and you can change these during play.

- "—" or "—" is displayed instead of the language number in circumstances such as when no language is recorded on the disc.

Soundtracks

During play
Press [AUDIO].

The number changes each time you press the button.

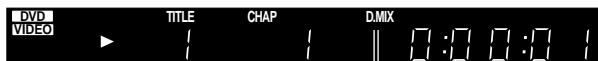
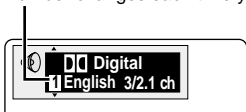

Indicates that a multi-channel soundtrack can be down-mixed to two channels.

- You can also use this button to turn the vocals on and off on karaoke discs. Read the disc's instructions for details.
- Refer to [B] on page 15 for audio signal type details.

Subtitles

During play
Press [SUBTITLE].

The number changes each time you press the button.

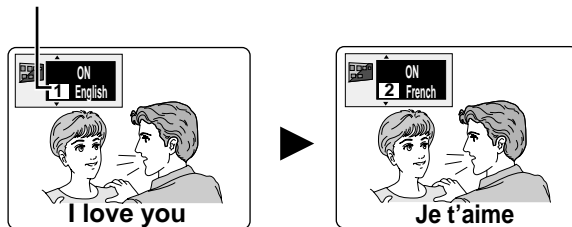

- In some cases, the subtitle language is not changed to the selected one immediately.

[For U.S.A., Canada and units with PX printed on the outer packaging]

- If the subtitles overlap closed captions recorded on discs, turn the subtitles off.

To clear/display the subtitles

1. Press [SUBTITLE].
2. Press [▶].
3. Press [▲, ▼] to select "OFF" or "ON".

Angles

During play
Press [ANGLE].

The number changes each time you press the button.

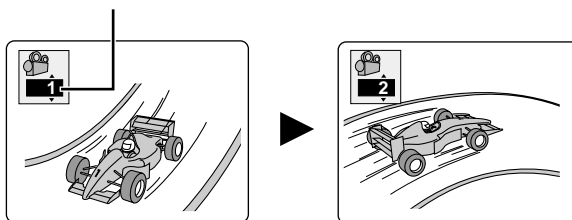

Use the [A] [B] [C] [D] buttons to control the following features, used to enhance your enjoyment of movies. ONE TOUCH CINEMA MEMORY then allows you to store the settings and recall them at a touch of a button.

[Note]

Turn Advanced Surround and BASS PLUS off when using Dolby Pro Logic. Dolby Pro Logic will not work correctly if they are on.

A ADVANCED SURROUND

[DVD]

(Dolby Digital, 2-channel or over only)

Use ADVANCED SURROUND V.S.S. (Virtual Surround Sound) to enjoy a surround-like effect if you are using 2 front speakers.

If you are playing a disc with surround effects recorded on it, the effect is broadened and sound seems to come from virtual speakers on either side.

During play

Press [[A] A.SRD].



Each time you press the button:

- 1: Natural effect
- ↓
- 2: Emphasized effect
- ↓
- OFF: Cancel (Factory preset)

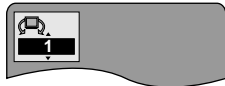

Optimum seating position

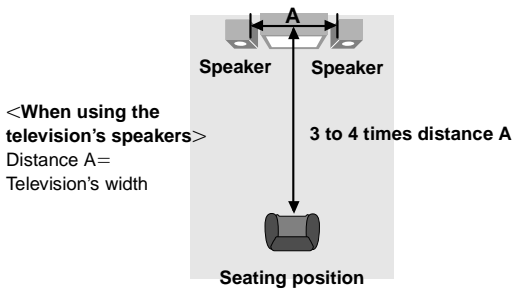

[Note]

- Advanced Surround will not work, or will have less effect with some discs.
- Turn off the surround sound effects on the equipment you have connected when using this effect.
- Turn Advanced Surround off if it causes distortion.

B BASS PLUS

[DVD] [CD] [VCD]

Turn BASS PLUS on when you have connected an active subwoofer to the SUBWOOFER terminal on the rear of the unit (➡ page 18).

Press [[B] BASS].



Each time you press the button:

- OFF
- ↓
- 1: Natural bass effect (Factory preset)
- ↓
- 2: Emphasized bass effect

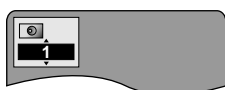

C CINEMA

[DVD] [VCD]

You can change the picture quality for movie viewing.

Press [[C] CINEMA].

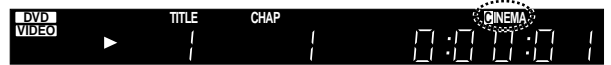

Each time you press the button:

- Cin.1: Mellows images and enhances detail in dark scenes.
- ↓
- Cin.2: Sharpens images and enhances detail in dark scenes.
- ↓
- Nor.: Normal mode (Factory preset)



For your reference

You can make finer adjustments to the picture if desired (➡ page 15, Digital picture mode—User mode).

D DIALOGUE ENHANCER

[DVD] (Dolby Digital, 3-channel or over, where the dialogue is recorded in the center channel)

This mode makes the dialogue in movies easier to hear.

Press [[D] D.ENH].

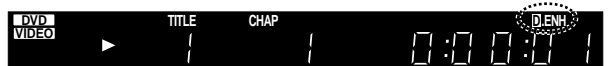

Each time you press the button:

ON ↔ OFF (Factory preset)



[Note]

Dialogue Enhancer will not work, or will have less effect with some discs.

ONE TOUCH CINEMA MEMORY

This feature allows you to reselect the settings you made for ADVANCED SURROUND, BASS PLUS, CINEMA and DIALOGUE ENHANCER with one button press.

[Putting the settings into memory]

After making the settings

Press and hold [ONE TOUCH MEMORY].

The button on the main unit lights.

The settings remain in the memory even if you turn the unit off.

[Recalling the settings]

Press [ONE TOUCH MEMORY].

The button on the main unit lights.

To cancel

Press [ONE TOUCH MEMORY] to turn it off and return the settings for the features to the factory preset.

- [A] ADVANCED SURROUND: OFF
- [B] BASS PLUS: 1
- [C] CINEMA: Nor.
- [D] DIALOGUE ENHANCER: OFF

The button's light also turns off if you press any of the other buttons to change the settings.

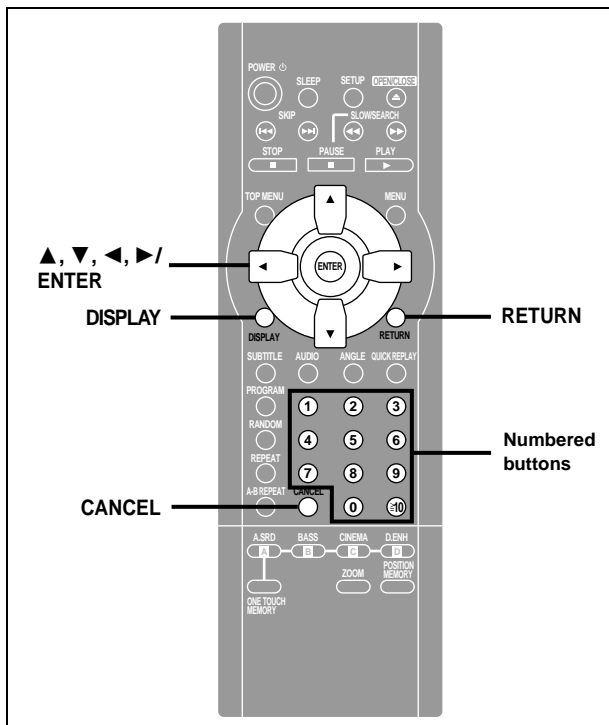

For your reference

- Depending on the condition of the unit (playing, stopped, etc.) and the type of software you are playing, there are some items that you cannot select or change.
- When numbers are displayed (e.g. title No.), the numbered buttons are also effective for setting. After entering numbers, press [ENTER] to register the setting.

To clear the icons

Press [RETURN] until the menus disappear.

To change the position of the icons

1. Press [◀, ▶] to select the rightmost icon.
2. Press [▲, ▼] to move the icons.
(There are 5 positions.)



Disc information

e.g. DVD

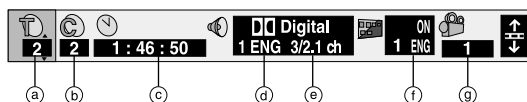

e.g. MP3 disc

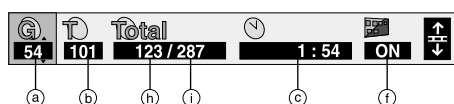

e.g. Video CD

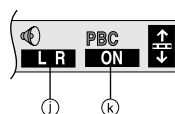

a) T: Title number [DVD]

G: Group number [CD] (MP3 discs)

b) C: Chapter number [DVD]

T: Track number in group [CD] (MP3 discs)

T: Track number [CD] [VCD]

c) Time [DVD]

- Press [▲, ▼] to show the elapsed play time or remaining time for the title (or chapter during program and random play).
- Select a position to start play by specifying a time with the numbered buttons.

Changing the time display [CD] [VCD]

Press [▲, ▼] to show the elapsed play time, remaining time for the track, or remaining time for the disc.

Elapsed play time [CD] (MP3 discs)

(display only, cannot be changed)

d) Soundtrack language [DVD] (⇒ page 12)

(See [A] on page 15 for language abbreviations.)

e) Audio signal type [DVD] (⇒ page 12)

(See [B] on page 15 for details.)

Karaoke vocal on/off (Karaoke DVD only) [DVD]

Solo: OFF or ON

Duet: OFF, V1+V2, V1 or V2

f) Subtitle language [DVD] (⇒ page 12)

(See [A] on page 15 for language abbreviations.)

Subtitles on/off

ON ↔ OFF

Group/Track name display on/off [CD] (MP3 discs)

ON ↔ OFF

g) Angle number [DVD] (⇒ page 12)

h) Track number in disc [CD] (MP3 discs)

i) Total number of tracks on disc [CD] (MP3 discs)

j) Audio mode [VCD]

LR ↔ L ↔ R

↑ ↔ ↓

k) Menu play [VCD] (with playback control only)

Indicates whether menu play (playback control) is on or off.

On-Screen Menu Icons are menus that contain information about the disc or unit. These menus allow you to perform operations by changing this information.

Common procedures

[DVD] [CD] [VCD]

Remote control only

1 Press [DISPLAY].

Each time you press the button:

Disc information → Progress indicator [DVD-RV32] (⇒ page 15)

Original display ← Unit information (⇒ step 2)

2 [Unit\information\only]

While the leftmost icon is highlighted

Press [▲, ▼] to select the menu.

Each time you press the button:

Play menu ↔ Video menu

Display menu ↔ Audio menu

3 Press [◀, ▶] to select the item.

4 Press [▲, ▼] to select the setting.

- Items with "▲" or "▼" above and below can be changed by [▲, ▼].
- Press [ENTER] if the setting does not change after pressing [▲, ▼].
- Some items require different operations. Read the following explanations.

Unit information

Play menu

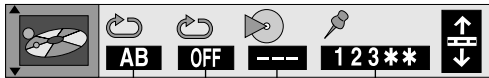

- a **A-B repeat** [DVD] [CD] [VCD] (⇒ page 11)
[ENTER] (start point) ⇒ [ENTER] (finish point)
To cancel: [ENTER]
- b **Repeat play** (⇒ page 11)
[DVD]
Chapter (C) ↔ Title (T)* [CD] (MP3 discs)
Track (T) ↔ Group (G)*
↑↔OFF↔↓ ↑↔OFF↔↓
- [CD] [VCD]
Track (T) ↔ Entire disc (A)
↑↔OFF↔↓ *="All (A)" during program and random play.
- c **Play mode display** [DVD] [CD] [VCD]
---: Normal play PGM: Program play RND: Random play
- d **Marker** [DVD] [CD] [VCD]
You can mark up to 5 positions to play again.
[ENTER] (The unit is now ready to accept markers.)
To mark a position: [ENTER] (at the desired point)
To mark another position: [◀, ▶] ⇒ [ENTER]
To recall a marker: [◀, ▶] ⇒ [ENTER]
To erase a marker: [◀, ▶] ⇒ [CANCEL]

Video menu



- Digital picture mode** [DVD] [VCD] (⇒ page 13)
Nor.: Normal mode
Cin.1: Mellows images and enhances detail in dark scenes
Cin.2: Sharpens images and enhances detail in dark scenes
User: User mode
The following items are also displayed when you select "User".

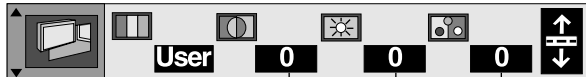

- a **Contrast** (-7 to +7)
- b **Brightness** (0 to +15)
- c **Color** (-7 to +7)

Progress indicator

Indicates how far you have played through an item. ([DVD-RV32] only)
e.g. DVD

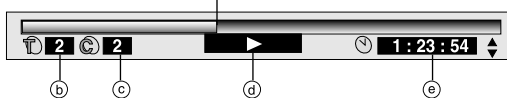

- a **Current position** [DVD] [CD] [VCD]
 - b **T: Title number** [DVD]
 - c **G: Group number** [CD] (MP3 discs)
 - d **C: Chapter number** [DVD]
 - e **T: Track number in group** [CD] (MP3 discs)
 - f **T: Track number** [CD] [VCD]
 - d **Condition – play, pause, or slow/search** [DVD] [CD] [VCD]
 - e **Time** [DVD]
 - Press [▲, ▼] to show the elapsed play time or remaining time for the title (or chapter during program and random play).
 - Select a position to start play by specifying a time with the numbered buttons.
- Changing the time display** [CD] [VCD]
Press [▲, ▼] to show the elapsed play time or remaining time for the track.
- Elapsed play time** [CD] (MP3 discs)
(display only, cannot be changed)

Audio menu



- a **Advanced Surround** [DVD] (⇒ page 13)
1 ↔ 2 ↔ OFF
- b **Bass Plus** [DVD] [CD] [VCD] (⇒ page 13)
1 ↔ 2 ↔ OFF
- c **Dialogue Enhancer** [DVD] (⇒ page 13)
ON ↔ OFF

Display menu



- a **4:3 TV ZOOM** [DVD] (⇒ page 10)
ON ↔ OFF
- b **IPB display** [DVD] (⇒ page 20, Glossary)
ON ↔ OFF
Displays the picture type (I/P/B) in the still picture mode.
- c **Display dimmer** [DVD] [CD] [VCD]
Changes the brightness of the unit's display.
Bright ↔ Dim ↔ Auto* ([DVD] [VCD])

* The display is dimmed during play, but brightens when you perform operations such as slow-motion, search, and pause.

[A] Audio/Subtitle language

ENG: English	SVE: Swedish	CHI: Chinese
FRA: French	NOR: Norwegian	KOR: Korean
DEU: German	DAN: Danish	MAL: Malay
ITA: Italian	POR: Portuguese	VIE: Vietnamese
ESP: Spanish	RUS: Russian	THA: Thai
NLD: Dutch	JPN: Japanese	*: Others

[B] Signal type/data





LPCM/Digital/DTS/MPEG: Signal type
k (kHz): Sampling frequency
b (bit): Number of bits
ch (channel): Number of channels

Example: 3/2_1ch

- L.1: Subwoofer signal
(not displayed if there is no subwoofer signal)
- 0: No surround
- 1: Mono surround
- 2: Stereo surround (left/right)
- 1: Center
- 2: Front left+Front right
- 3: Front left+Front right+Center

Changing settings

This chart shows the settings for this unit. Change the settings to suit your preferences and to suit the unit to the environment in which it is being used. These settings are retained in memory until they are changed, even if the unit is turned off. See page 17 for details on menu operation.

Menus	Items	Options (Underlined items are the factory preset.)
 Disc	Audio [DVD] Choose the audio language.	Language options *1 French Spanish *2 French German Italian Spanish Portuguese Swedish Dutch *3 Chinese
	Subtitle [DVD] Choose the subtitle language.	*1 French Spanish *2 French German Italian Spanish Portuguese Swedish Dutch *3 Chinese
	Menus [DVD] Choose the language for disc menus.	*1 French Spanish *2 French German Italian Spanish Portuguese Swedish Dutch *3 Chinese
	Ratings [DVD] Set a ratings level to limit DVD play. ● The password screen is shown if you choose levels 0 to 7 or if you choose "Ratings" when levels 0 to 7 have been selected (⇒ page 17). ● Select Level "0" to prevent play of discs that do not have ratings levels recorded on them.	Setting ratings (When level 8 is selected) 8 No Limit 1 to 7*7 0 Lock All Changing ratings (When level 0-7 is selected) Unlock Player Change Password Change Level Temporary Unlock
 Video	TV Aspect (⇒ page 7) Choose the setting to suit your television and preference.	4:3 Pan&Scan 4:3 Letterbox 16:9
	Still Mode (⇒ page 20, Glossary) Specify the type of picture shown when paused.	Automatic Field Frame
	Black Level Control*1 Change the black level of the picture if you connected a television through the COMPONENT VIDEO OUT terminals.	Lighter: when connected to a TV through the VIDEO OUT or S VIDEO OUT terminal. Darker: when connected to a TV through the COMPONENT VIDEO OUT (Y/Ps/P _R) terminals.
	NTSC Disc Output*2 *3 Choose whether PAL 60 or NTSC signals are output during playback of NTSC discs (⇒ page 5).	PAL60: when connected to a PAL television. NTSC: when connected to an NTSC television. (For Asia: "NTSC" is the factory preset.)
 Audio	PCM Down Conversion [DVD] (⇒ page 17)	No Yes
	Dolby Digital [DVD] (⇒ page 17)	Bitstream PCM
	DTS Digital Surround [DVD] (⇒ page 17)	Off Bitstream
	MPEG*2 [DVD] (⇒ page 17)	PCM Bitstream
	D. Range Compression [DVD] Dolby Digital only (⇒ page 20, Glossary) Change the dynamic range for late night viewing.	Off On
	Audio during Search Choose whether to have sound during search.	On Off
 Display	Menu Language Choose the language for these menus and the on-screen messages.	*1 English Français Español *2 English Français Deutsch Italiano Español Português Svenska Nederlands *3 English 中文
	On-Screen Messages Choose whether to show on-screen messages or not.	On Off
 Others	Demo A demonstration of the unit's on-screen displays starts when you select "On". The demonstration stops when you press a button and the setting reverts to "Off".	Off On
	QUICK SETUP (⇒ page 7) Answer questions to make basic settings.	Yes No

*1 For U.S.A., Canada and units with PX printed on the outer packaging.

*2 For the Middle East, South Africa, Australia and N.Z.

*3 For Asia.

*4 The original language of each disc will be selected.

*5 Input a code number with the numbered buttons (see below).

*6 If the language selected for "Audio" is not available, subtitles of that language will automatically appear if available on that disc.

*7 Prohibits play of DVDs with corresponding ratings recorded on them.

Language code list

Abkhazian: 6566	Byelorussian: 6669	Georgian: 7565	Kashmiri: 7583	Mongolian: 7778	Serbo-Croatian: 8372	Tigrinya: 8473
Afar: 6565	Cambodian: 7577	German: 6869	Kazakh: 7575	Nauru: 7865	Shona: 8378	Tonga: 8479
Afrikaans: 6570	Catalan: 6765	Greek: 6976	Kirghiz: 7589	Nepali: 7869	Sindhi: 8368	Turkish: 8482
Albanian: 8381	Chinese: 9072	Greenlandic: 7576	Korean: 7579	Norwegian: 7879	Singhalese: 8373	Turkmen: 8475
Ameharic: 6577	Corsican: 6779	Guarani: 7178	Kurdish: 7585	Oriya: 7982	Slovak: 8375	Twi: 8487
Arabic: 6582	Croatian: 7282	Gujarati: 7185	Laotian: 7679	Pashto, Pushto: 8083	Slovenian: 8376	Ukrainian: 8575
Armenian: 7289	Czech: 6783	Hausa: 7265	Latin: 7665	Persian: 7065	Somali: 8379	Urdu: 8582
Assamese: 6583	Danish: 6865	Hebrew: 7387	Latvian, Lettish: 7686	Polish: 8076	Spanish: 6983	Uzbek: 8590
Aymara: 6588	Dutch: 7876	Hindi: 7273	Lingala: 7678	Portuguese: 8084	Sundanese: 8385	Vietnamese: 8673
Azerbaijani: 6590	English: 6978	Hungarian: 7285	Lithuanian: 7684	Punjabi: 8065	Swahili: 8387	Volapük: 8679
Bashkir: 6665	Esperanto: 6979	Icelandic: 7383	Macedonian: 7775	Quechua: 8185	Swedish: 8386	Welsh: 6789
Basque: 6985	Estonian: 6984	Indonesian: 7378	Malagasy: 7771	Rhaeto-Romance: 8277	Tagalog: 8476	Wolof: 8779
Bengali; Bangla: 6678	Faroese: 7079	Interlingua: 7365	Malay: 7783	Romanian: 8279	Tajik: 8471	Xhosa: 8872
Bhutani: 6890	Fiji: 7074	Irish: 7165	Malayalam: 7776	Russian: 8285	Tamil: 8465	Yiddish: 7473
Bihari: 6672	Finnish: 7073	Italian: 7384	Maltese: 7784	Samoan: 8377	Tatar: 8484	Yoruba: 8979
Breton: 6682	French: 7082	Japanese: 7465	Maori: 7773	Sanskrit: 8365	Telugu: 8469	Zulu: 9085
Bulgarian: 6671	Frisian: 7089	Javanese: 7487	Marathi: 7782	Scots Gaelic: 7168	Thai: 8472	
Burmese: 7789	Galician: 7176	Kannada: 7578	Moldavian: 7779	Serbian: 8382	Tibetan: 6679	

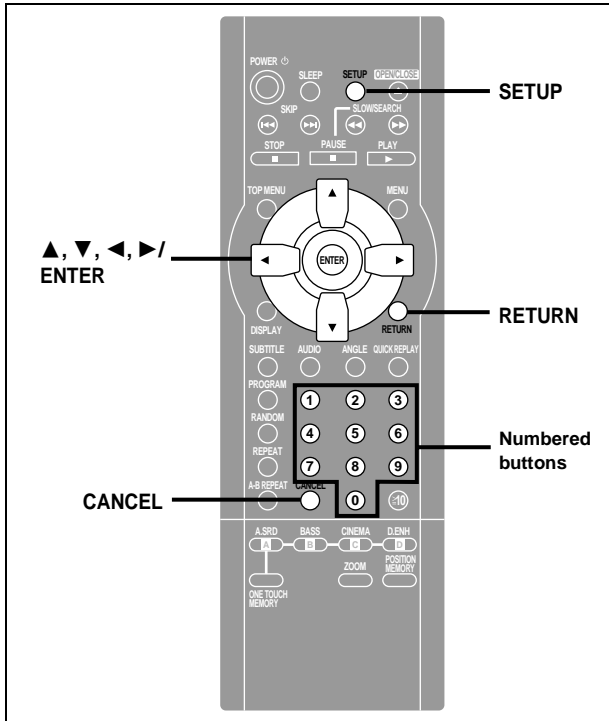

Common procedures

Remote control only

See page 16 for menu and option details.

1 Press [SETUP] to show the menus.

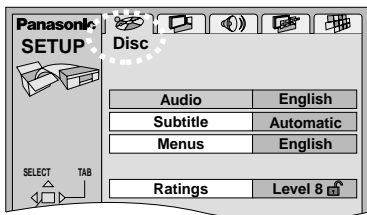

•The QUICK SETUP screen appears when you press [SETUP] the first time after purchase (➔ page 7).

2 Press [◀, ▶] to select the menu's tab.

The screen changes to display the menu.

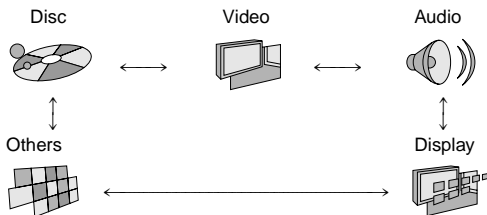

3 Press [▲, ▼] to select the item you want to change and press [ENTER].

4 Press [▲, ▼, ▶, ◀] to select the option and press [ENTER].

The screen now shows the menu again.

To return to the previous screen

Press [RETURN].

When you are finished

Press [SETUP].

Entering a password (Ratings)

[DVD]

The password screen is shown when you select levels 0 to 7.

1. Input a 4-digit password with the numbered buttons and press [ENTER].

- If you enter a wrong number, press [CANCEL] to erase it before you press [ENTER].

- The lock symbol appears closed to show the rating is locked.

- Do not forget your password.

2. Press [ENTER] to confirm the 4 digits.

Now, when you insert a DVD that exceeds the ratings limit you set, a message appears on the television. Follow the on-screen instructions.

Digital output

[DVD]

Change the settings when you have connected equipment through this unit's DIGITAL AUDIO OUT terminal (OPTICAL).

PCM Down Conversion

Select how to output the high-quality 96-kHz audio signals on discs that do not have copyright protection.

No (Factory preset):

Output as 96 kHz. The equipment you connect must be compatible with these signals.

Yes:

Down-sampled to 48 kHz/16 bit.

Dolby Digital, DTS Digital Surround and MPEG*

Bitstream (Factory preset for Dolby Digital):

Select if the equipment you connected can decode the signal.

PCM (Factory preset for MPEG*):

Select if the equipment you connected cannot decode the signal.

*Only for the Middle East, South Africa, Australia and N.Z.

Off (Factory preset for DTS Digital Surround):

Select if the equipment you connected cannot decode the signal.

IMPORTANT

If the equipment you connected cannot decode the signal, the setting must be changed to PCM or Off. If not, signals the equipment cannot process will be output by this unit, causing high levels of noise which can damage your hearing and the speakers.

Home Theater—Enjoying more powerful sound

This model can play Dolby Digital, but only in two channels. This model does not have a DTS decoder. You must connect a unit with a Dolby Digital or DTS decoder to enjoy surround sound.

[Note]

- The equipment connections described are examples.
- Peripheral equipment and optional cables sold separately unless otherwise indicated.
- Before connection, turn off all equipment and read the appropriate operating instructions.

Advanced operations

A Digital connection

To enjoy 5.1-ch surround sound

Connect an amplifier with a built-in decoder or a decoder-amplifier combination.

- Change the settings in "Digital output" to suit the decoder (➔ page 17).
 - Dolby Digital decoder: set "Dolby Digital" to "Bitstream"
 - DTS decoder: set "DTS Digital Surround" to "Bitstream"
 - MPEG decoder: set "MPEG*" to "Bitstream"
- * Only for the Middle East, South Africa, Australia and N.Z.

[Note]

You cannot use DTS Digital Surround decoders not suited to DVD.

To enjoy stereo or Dolby Pro Logic

Connect a digital amplifier or system component.

- Go to "Digital output" and change the settings to "PCM" and "Off" (➔ page 17).

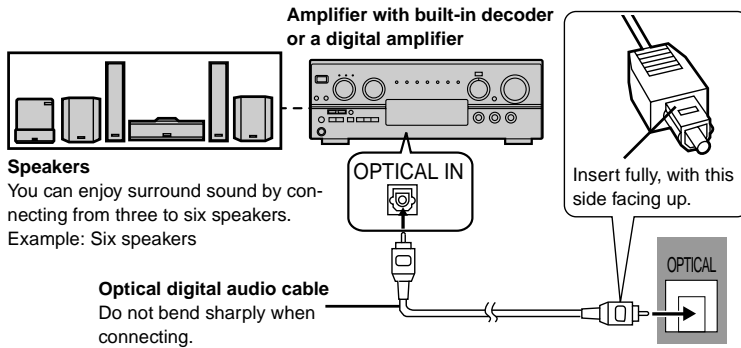

B Analog connection

To enjoy stereo or Dolby Pro Logic

Connect an analog amplifier or system component.

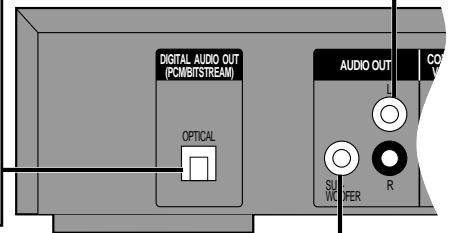
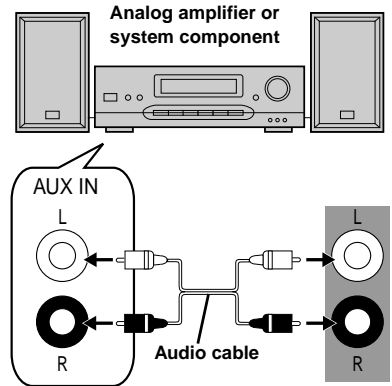

Connecting an active subwoofer

You can enjoy more powerful bass by connecting an active subwoofer.

- Place the subwoofer as close as possible to the front center.
- Turn BASS PLUS on to boost the output from the subwoofer (➔ page 13).
- Adjust the volume on the subwoofer to suit your preference.

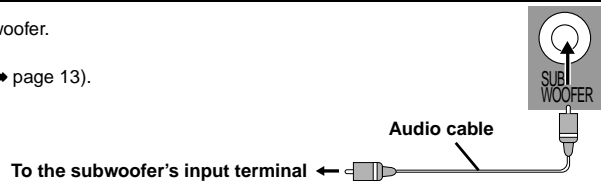

Recording to digital recording equipment or cassette tapes

• Digital recording

You can record the digital signal directly onto digital recording equipment. The signals on DVDs will be converted to 48 kHz/16 bit linear PCM. Ensure the following conditions are met.

- The recording equipment can handle a sampling frequency of 48 kHz.
- You cannot record MP3 (or WMA for U.S.A., Canada and units with PX printed on the outer packaging [DVD-RV32] [DVD-RV27]).

To make a digital recording

1. Connect the recording equipment with an optical digital audio cable (➔ [A] above).
2. When recording DVDs, make the following settings.
 - ADVANCED SURROUND: OFF (➔ page 13)
 - PCM Down Conversion: Yes (➔ page 17)
 - Dolby Digital: PCM (➔ page 17)
 - DTS Digital Surround: Off (➔ page 17)
 - MPEG*: PCM (➔ page 17)
 - * Only for the Middle East, South Africa, Australia and N.Z.

• Analog recording

You can record to a digital recording equipment or cassette deck. Using analog connection means sound will be unaffected by the copy guards found on DVDs.

To make an analog recording

Connect the recording equipment with an audio cable (➔ [B] above).

Troubleshooting guide

Before requesting service, make the below checks. If you are in doubt about some of the check points, or if the remedies indicated in the chart do not solve the problem:

In the U.S.A., contact the Panasonic Customer Call Center at 1-800-211-7262, or e-mail consumerproducts@panasonic.com, or web site (<http://www.panasonic.com>).

In Canada, contact Panasonic Canada Inc. Customer Care Centre at 1-800-561-5505, web site (www.panasonic.ca), or an authorized Servicentre closest to you.

In other areas, consult your dealer.

Power		Page
No power.	<ul style="list-style-type: none"> ● Insert the AC power supply cord securely into the household AC outlet. 	6
The unit is automatically switched to the standby mode.	<ul style="list-style-type: none"> ● To conserve power, the unit automatically switches to standby after approximately 30 minutes in the stop mode. Turn the power back to ON. 	–
	<ul style="list-style-type: none"> ● The unit was switched to standby by the SLEEP timer. 	8

Operation

No response when buttons pressed.	<ul style="list-style-type: none"> ● Some operations may be prohibited by the disc. 	–
	<ul style="list-style-type: none"> ● The unit may not be operating properly due to lightning, static electricity or some other external factor. <p>Reset procedure: Press [POWER ⏻] to switch the unit to the standby mode and then back to ON. Alternatively, press [POWER ⏻] to switch the unit to the standby mode, disconnect the AC power supply cord, and then reconnect it.</p>	–
No operations can be performed with the remote control.	<ul style="list-style-type: none"> ● Check the batteries are installed correctly. 	7
	<ul style="list-style-type: none"> ● The batteries are depleted: Replace them with new ones. 	7
	<ul style="list-style-type: none"> ● Point the remote control at the remote control sensor and operate. 	7
Play fails to start even when [▶] (PLAY) is pressed. Play starts but then stops immediately.	<ul style="list-style-type: none"> ● Condensation has formed: Wait 1 to 2 hours for it to evaporate. 	–
	<ul style="list-style-type: none"> ● This unit cannot play discs other than DVD, CD and Video CD. 	5
	<ul style="list-style-type: none"> ● You can only play DVD if their region number is the same or includes the same region number as the unit or if the DVD is marked "ALL". Confirm the region number for the unit on the rear panel. 	Cover page
	<ul style="list-style-type: none"> ● The disc may be dirty and may require cleaning. ● Ensure that the disc is installed with the label of the side to be played facing upwards. 	– 8
Alternative languages fail to be selected.	<ul style="list-style-type: none"> ● An alternative language is not selected with discs which do not contain more than one language. 	–
	<ul style="list-style-type: none"> ● In the case of some discs, the alternative language cannot be selected with [AUDIO] or [SUBTITLE]. Try selecting it from the disc's menu if one is available. 	8
No menu play.	<ul style="list-style-type: none"> ● Menus are only displayed if they are recorded on the disc. 	–
No subtitles.	<ul style="list-style-type: none"> ● Subtitles appear only with discs that contain them. 	–
	<ul style="list-style-type: none"> ● Subtitles are cleared from the television. Display the subtitles. 	12
Soundtrack and/or subtitle language is not the one selected with the SETUP menus.	<ul style="list-style-type: none"> ● The language is not recorded on the disc. 	–
Angle cannot be changed.	<ul style="list-style-type: none"> ● This function is dependent on software availability. Even if a disc has a number of angles recorded, these angles may be recorded for specific scenes only. 	12
Dialogue Enhancer has no effect.	<ul style="list-style-type: none"> ● This feature does not work when the unit is outputting bitstream signals. 	–
You have forgotten your ratings password. Reset all the settings to Factory Preset.	<ul style="list-style-type: none"> ● While stopped, press and hold [◀◀] and [▶▶] on the unit and then also press and hold [▲] on the unit until "Initialized" disappears from the television. Turn the unit off and on again. All settings will return to the default values. 	–

Sound

No sound. Distorted sound.	<ul style="list-style-type: none"> ● Check the connections. 	6, 18
	<ul style="list-style-type: none"> ● Check the volume on the equipment you have connected. 	–
	<ul style="list-style-type: none"> ● Ensure that the input settings for the television and stereo system are correct. 	–
	<ul style="list-style-type: none"> ● Turn Advanced Surround off if it causes distortion. 	13
Piercing noise comes from the speakers.	<ul style="list-style-type: none"> ● If you have connected this unit to other equipment through the DIGITAL AUDIO OUT terminal, ensure you have selected the correct settings for "Dolby Digital", "DTS Digital Surround" and "MPEG#" in the SETUP menu's Audio menu. * Only for the Middle East, South Africa, Australia and N.Z. 	17

Picture

Page

Picture distorted.	<ul style="list-style-type: none"> Some distortion is normal during SEARCH. 	–
No picture.	<ul style="list-style-type: none"> Ensure that the equipment is connected properly. Make sure the television is on. Ensure the television's video input setting (e.g., VIDEO 1) is correct. 	6 – –
The picture shown on the television is not normal. (The sides of the picture are cut off or black bands appear at the top and bottom of the screen.)	<ul style="list-style-type: none"> Go to the Video menu in the SETUP screen, and change "TV Aspect" to suit your television. You may also need to change the screen mode on the television itself. Ensure that the unit is connected directly to the television, and is not connected through a video cassette recorder. The 4:3 TV ZOOM function is on. 	7, 16 – 10
Picture quality is poor.	<ul style="list-style-type: none"> Check the settings in the On-Screen Menu Icons' Video menu. 	15
The SETUP menus and other screens shown on the television are displayed incorrectly. Colors appear faded.	<ul style="list-style-type: none"> The unit and television are using different video systems. \For the Middle East, South Africa, Australia and N.Z.\ Use a multi-system or PAL television. \For others\ Use a multi-system or NTSC television. 	–

Unit displays

"NO PLAY"	<ul style="list-style-type: none"> You inserted a disc the unit cannot play; insert one it can. 	5
"CHECK DISC"	<ul style="list-style-type: none"> Disc is dirty. Wipe the disc clean. 	–
"H□□" □□ stands for a number.	<ul style="list-style-type: none"> Trouble is likely to have occurred. The number following "H" depends on the status of the unit. Reset procedure: Press [POWER ⏻] to switch the unit to the standby mode and then back to ON. Alternatively, press [POWER ⏻] to switch the unit to the standby mode, disconnect the AC power supply cord, and then reconnect it. If the service numbers fail to clear, note the service number and contact a qualified service person. 	– –
"NO DISC"	<ul style="list-style-type: none"> You haven't inserted a disc; insert one. You haven't inserted the disc correctly; insert it correctly. 	– 8

Television displays

No on-screen display.	<ul style="list-style-type: none"> Go to Display in the SETUP menus, and select "On" for "On-Screen Messages". 	16
On-Screen Menu Icons not displayed or only partially displayed on the television.	<ul style="list-style-type: none"> Press [▲, ▼] while the rightmost icon is highlighted to move them down. 	14
The disc's menu is displayed in a different language.	<ul style="list-style-type: none"> Go to Disc in the SETUP menus, and select the preferred language for "Menus". 	16

Glossary

Bitstream

This is the digital form of multiple channel audio data (e.g., 5.1 channel) before it is decoded into its various channels.

Decoder

A decoder restores the coded audio signals on DVDs to normal. This is called decoding.

Dolby Digital

This is a method of coding digital signals developed by Dolby Laboratories. Apart from stereo (2-channel) audio, these signals can also be 5.1-channel audio. A large amount of audio information can be recorded on one disc using this method.

Dolby Pro Logic

A surround system where a 4-channel audio track is recorded as 2 channels and then is restored to 4 channels for play. The surround channel is monaural and can reproduce up to 7 kHz.

DTS (Digital Theater Systems)

This surround system is used in many movie theaters around the world. There is good separation between the channels, so realistic sound effects are possible.

Dynamic range

Dynamic range is the difference between the lowest level of sound that can be heard above the noise of the equipment and the highest level of sound before distortion occurs.

Frame still and field still

Frames are the still pictures that go together to make a moving picture. There are about 30 frames shown each second.

One frame is made up of two fields. A regular television shows these fields one after the other to create frames.

A still is shown when you pause a moving picture. A frame still is made up of two alternating fields, so the picture may appear blurred, but overall quality is high.

A field still is not blurred, but it has only half the information of a frame still so picture quality is lower.

I/P/B

MPEG 2, the video compression standard adopted for use with DVD-Video, codes frames using these 3 picture types.

I: Intra coded picture (I-picture)

This is the standard picture and is a complete picture in itself. This means it has the best picture quality and is the best to use when adjusting the picture.

P: Predictive coded picture (P-picture)

This picture is calculated based on past I or P-pictures.

B: Bidirectionally-predictive coded picture (B-picture)

This picture is calculated by comparing past and future I and P-pictures so it has the lowest volume of information.

Linear PCM (pulse code modulation)

These are uncompressed digital signals, similar to those found on CDs.

Playback control (PBC)

If a Video CD has playback control, you can select scenes and information with menus (called menu play in these instructions).

Limited Warranty (U.S.A.)

Panasonic Consumer Electronics Company,
Division of Matsushita Electric Corporation of America
One Panasonic Way Secaucus, New Jersey 07094

Panasonic Sales Company, Division of Matsushita Electric
of Puerto Rico, Inc.
Ave. 65 de Infantería, Km. 9.5
San Gabriel Industrial Park, Carolina, Puerto Rico 00985

Panasonic DVD Player/Recorder Limited Warranty

Limited Warranty Coverage

If your product does not work properly because of a defect in materials or workmanship, Panasonic Consumer Electronics Company or Panasonic Sales Company (collectively referred to as "the warrantor") will, for the length of the period indicated on the chart below, which starts with the date of original purchase ("warranty period"), at its option either (a) repair your product with new or refurbished parts, or (b) replace it with a new or a refurbished product. The decision to repair or replace will be made by the warrantor.

Product or Part Name	Parts	Labor
DVD Player	One (1) Year	Ninety (90) Days
DVD Recorder	One (1) Year	One (1) Year
Rechargeable Batteries, DVD-RAM Disc (in exchange for defective item)	Ten (10) Days	Not Applicable

During the "Labor" warranty period there will be no charge for labor. During the "Parts" warranty period, there will be no charge for parts. You must carry-in or mail-in your product during the warranty period. If non-rechargeable batteries are included, they are not warranted. This warranty only applies to products purchased and serviced in the United States or Puerto Rico. This warranty is extended only to the original purchaser of a new product which was not sold "as is". A purchase receipt or other proof of the original purchase date is required for warranty service.

Carry-In or Mail-In Service

For Carry-In or Mail-In Service in the United States call 1-800-211-PANA(7262) or visit Panasonic Web Site: <http://www.panasonic.com>
For assistance in Puerto Rico call Panasonic Sales Company (787)-750-4300 or fax (787)-768-2910.

Limited Warranty Limits And Exclusions

This warranty ONLY COVERS failures due to defects in materials or workmanship, and DOES NOT COVER normal wear and tear or cosmetic damage. The warranty ALSO DOES NOT COVER damages which occurred in shipment, or failures which are caused by products not supplied by the warrantor, or failures which result from accidents, misuse, abuse, neglect, mishandling, misapplication, alteration, faulty installation, set-up adjustments, misadjustment of consumer controls, improper maintenance, power line surge, lightning damage, modification, or commercial use (such as in a hotel, office, restaurant, or other business), rental use of the product, service by anyone other than a Factory Servicenter or other Authorized Servicer, or damage that is attributable to acts of God.

THERE ARE NO EXPRESS WARRANTIES EXCEPT AS LISTED UNDER "LIMITED WARRANTY COVERAGE". THE WARRANTOR IS NOT LIABLE FOR INCIDENTAL OR CONSEQUENTIAL DAMAGES RESULTING FROM THE USE OF THIS PRODUCT, OR ARISING OUT OF ANY BREACH OF THIS WARRANTY. (As examples, this excludes damages for lost time, travel to and from the servicer, loss of media or images, data or other recorded content. The items listed are not exclusive, but are for illustration only.) **ALL EXPRESS AND IMPLIED WARRANTIES, INCLUDING THE WARRANTY OF MERCHANTABILITY, ARE LIMITED TO THE PERIOD OF THE LIMITED WARRANTY.**

Some states do not allow the exclusion or limitation of incidental or consequential damages, or limitations on how long an implied warranty lasts, so the exclusions may not apply to you.

This warranty gives you specific legal rights and you may also have other rights which vary from state to state. If a problem with this product develops during or after the warranty period, you may contact your dealer or Servicer. If the problem is not handled to your satisfaction, then write to the warrantor's Consumer Affairs Department at the addresses listed for the warrantor.

PARTS AND SERVICE WHICH ARE NOT COVERED BY THIS LIMITED WARRANTY ARE YOUR RESPONSIBILITY.

***For Product Information, Operating Assistance, Literature Request, Dealer Locations, and all Customer Service inquiries please contact:
1-800-211-PANA (7262), Monday-Friday 9 am-9 pm; Saturday-Sunday 9 am-7 pm, EST.***

***Web Site: <http://www.panasonic.com>
You can purchase parts, accessories or locate your nearest servicenter by visiting our Web Site.***

Accessory Purchases:

1-800-332-5368 (Customer Orders Only)
Panasonic Services Company 20421 84th Avenue South, Kent, WA 98032
(6 am to 5 pm Monday-Friday; 6 am to 10:30 am Saturday; PST)
(Visa, MasterCard, Discover Card, American Express, Check)

***Service in Puerto Rico
Matsushita Electric of Puerto Rico, Inc. Panasonic Sales Company/Factory Servicenter:
Ave. 65 de Infantería, Km. 9.5, San Gabriel Industrial Park, Carolina, Puerto Rico 00985
Phone (787) 750-4300 Fax (787) 768-2910***

1. **Damage requiring service**—The unit should be serviced by qualified service personnel if:
 - (a) The AC power supply cord or AC adaptor has been damaged; or
 - (b) Objects or liquids have gotten into the unit; or
 - (c) The unit has been exposed to rain; or
 - (d) The unit does not operate normally or exhibits a marked change in performance; or
 - (e) The unit has been dropped or the cabinet damaged.
2. **Servicing**—Do not attempt to service the unit beyond that described in these operating instructions. Refer all other servicing to authorized servicing personnel.
3. **Replacement parts**—When parts need replacing ensure the servicer uses parts specified by the manufacturer or parts that have the same characteristics as the original parts. Unauthorized substitutes may result in fire, electric shock, or other hazards.
4. **Safety check**—After repairs or service, ask the servicer to perform safety checks to confirm that the unit is in proper working condition.

Product information

For product information or assistance with product operation:

In the U.S.A., contact the Panasonic Customer Call Center at 1-800-211-7262, or e-mail consumerproducts@panasonic.com, or web site (<http://www.panasonic.com>).

In Canada, contact Panasonic Canada Inc. Customer Care Centre at 1-800-561-5505, web site (www.panasonic.ca), or an authorized Servicentre closest to you.

Conexión a un televisor

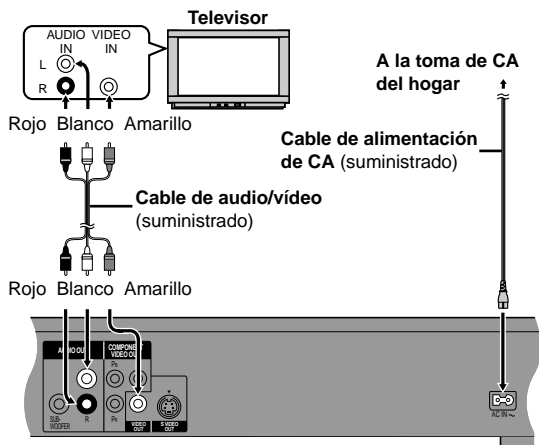

Preparación Rápida

Mando a distancia solamente

La pantalla Preparación Rápida aparece cuando usted pulsa [SETUP] por primera vez después de adquirir el aparato y le ayuda a efectuar los ajustes necesarios.

- 1 Pulse [POWER] para encender el aparato.
- 2 Pulse [SETUP] para visualizar la pantalla "QUICK SETUP".
- 3 Pulse [▲, ▼] para seleccionar "Español" y pulse [ENTER].
- 4 Pulse [▲, ▼] para seleccionar "SI" y pulse [ENTER].
- 5 Pulse [▲, ▼] para seleccionar el elemento y pulse [ENTER].
 - Idioma de audio
 - Idioma de subtítulos
 - Aspecto de su televisor
- 6 Pulse [ENTER] y luego [SETUP] para finalizar los ajustes.

• Para volver a la pantalla anterior, pulse [RETURN].

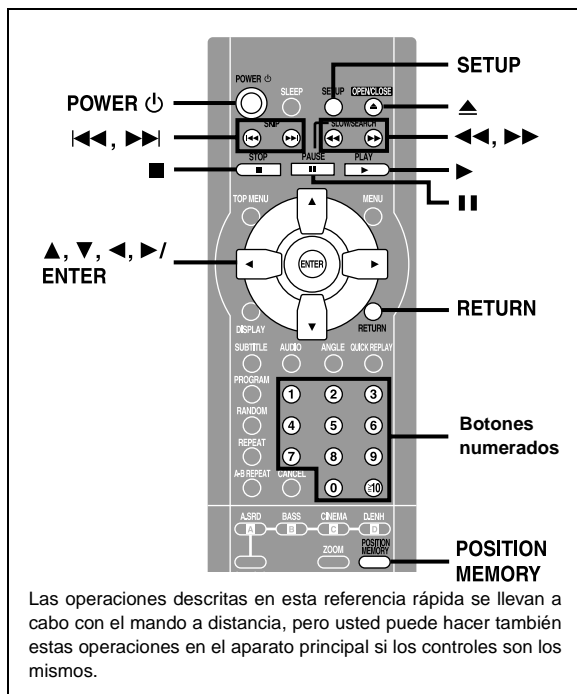

Las operaciones descritas en esta referencia rápida se llevan a cabo con el mando a distancia, pero usted puede hacer también estas operaciones en el aparato principal si los controles son los mismos.

Reproducción básica

[DVD] [CD] [VCD]

- 1 Pulse [▲] para abrir la bandeja del disco y coloque el disco.
- 2 Pulse [▶] (PLAY).
La bandeja del disco se cierra y la reproducción empieza.

- Para detener la reproducción, pulse [■].
- Para hacer una pausa, pulse [⏸] durante la reproducción.

Cuando una pantalla de menús aparece en el televisor [DVD] [VCD]

Mando a distancia solamente

Pulse los botones numerados para seleccionar un elemento.

Función de reanudación

Parada-reanudación

El aparato memoriza la posición en la que usted detuvo la reproducción hasta que usted abre la bandeja del disco o pone el aparato en el modo de espera.

Para guardar una posición incluso después de abrir la bandeja del disco o poner el aparato en el modo de espera

Pulse [POSITION MEMORY] durante la reproducción. Puede tener memorizadas posiciones de hasta cinco discos diferentes al mismo tiempo. Cuando encienda el aparato o vuelva a insertar un disco, ">" parpadeará en el visualizador.

Para reanudar la reproducción

Pulse [▶] (PLAY) mientras parpadea ">" en el visualizador del aparato.

Salto de capítulos o pistas

Durante la reproducción o durante la pausa
Pulse [◀◀] o [▶▶].

Avance rápido y rebobinado-SEARCH

Durante la reproducción
Pulse [◀◀] o [▶▶].

Reproducción a cámara lenta [DVD] [VCD]

Durante la pausa
Pulse [◀◀] o [▶▶].

Visión cuadro a cuadro [DVD] [VCD]

Durante la pausa
Pulse [◀] o [▶].

• Pulse [▶] (PLAY) para iniciar la reproducción.

Specifications

Signal system:

[For U.S.A., Canada and units with PX printed on the outer packaging]

NTSC

[For others]

PAL 625/50, PAL525/60, NTSC

Operating temperature range: +5 to +35 °C (+41 to +95 °F)

Operating humidity range: 5 to 90 % RH (no condensation)

Discs played [8 cm (3") or 12 cm (5")]:

(1) DVD-Video, DVD-R (DVD-Video compatible)

(2) CD-Audio (CD-DA)

(3) Video CD

(4) CD-R/CD-RW (CD-DA, Video CD formatted discs)

(5) MP3

• Maximum number of tracks and groups recognizable: 999 tracks and 99 groups*

• Compatible compression rate: between 32 kbps and 320 kbps

[DVD-RV32] [DVD-RV27]

(For U.S.A., Canada and units with PX printed on the outer packaging)

(6) WMA

Video output:

Output level: 1 Vp-p (75 Ω)

Output terminal: Pin jack (1 system)

S video output:

Y output level: 1 Vp-p (75 Ω)

C output level: NTSC; 0.286 Vp-p (75 Ω)

[For the Middle East, South Africa, Asia, Australia and N.Z.]

PAL; 0.300 Vp-p (75 Ω)

Output terminal: S terminal (1 system)

Component video output:

Y output level: 1 Vp-p (75 Ω)

P_B output level: 0.7 Vp-p (75 Ω)

P_R output level: 0.7 Vp-p (75 Ω)

Output terminal: Pin jack (Y: green, P_B: blue, P_R: red)

Number of terminals: 1 system

Audio output:

Output level: 2 Vrms (1 kHz, 0 dB)

Output terminal: Pin jack

Number of terminals:

2ch: 1 system

Subwoofer output (0.1 ch): 1 system

Audio performance:

(1) Frequency response:

• DVD (linear audio): 4 Hz–22 kHz (48 kHz sampling)

4 Hz–44 kHz (96 kHz sampling)

4 Hz–20 kHz

• CD audio:

(2) S/N ratio:

• CD audio:

115 dB

(3) Dynamic range:

• DVD (linear audio):

102 dB

• CD audio:

98 dB

(4) Total harmonic distortion:

• CD audio:

0.0025 %

Digital audio output:

Optical digital output: Optical terminal

Pickup: Wave length: 658 nm/790 nm

[For U.S.A., Canada and units with PX printed on the outer packaging]

Laser power: CLASS IIa/CLASS I

[For the Middle East, South Africa, Asia, Australia and N.Z.]

Laser power: CLASS 2/CLASS 1

Power supply:

[For U.S.A. and Canada]

AC 120 V, 60 Hz

[For Australia and N.Z.]

AC 220–240 V, 50 Hz

[For others]

AC 110–240 V, 50/60 Hz

Power consumption:

14 W

Dimensions:

430 (W) × 247 (D) × 74.5 (H) mm

[16⁵/₁₆" (W) × 9⁷/₁₆" (D) × 2¹⁵/₁₆" (H)]

(excluding protrusions)

Mass:

2.4 kg (5.31 lb.)

Power consumption in standby mode:

[DVD-RV32]

(For U.S.A. and Canada)

approx. 2 W

(For others)

approx. 3 W

[DVD-RV27] [DVD-RV22]

approx. 2 W

[Note]

*Including WMA files. [DVD-RV32] [DVD-RV27]

(For U.S.A., Canada and units with PX printed on the outer packaging)

Specifications are subject to change without notice.

Mass and dimensions are approximate.

Manufactured under license from Dolby Laboratories. "Dolby", "Pro Logic" and the double-D symbol are trademarks of Dolby Laboratories.

"DTS", "DTS Digital Surround" and "DTS Digital Out" are registered trademarks of Digital Theater Systems, Inc.

Apparatus Claims of U.S. Patent Nos. 4,631,603, 4,577,216, and 4,819,098, licensed for limited viewing uses only.

This product incorporates copyright protection technology that is protected by method claims of certain U.S. patents and other intellectual property rights owned by Macrovision Corporation and other rights owners. Use of this copyright protection technology must be authorized by Macrovision Corporation, and is intended for home and other limited viewing uses only unless otherwise authorized by Macrovision Corporation. Reverse engineering or disassembly is prohibited.

[For U.S.A.]

Panasonic Consumer Electronics Company, Division of Matsushita Electric Corporation of America

One Panasonic Way Secaucus, New Jersey 07094

<http://www.panasonic.com>

[For units with PX printed on the outer packaging]

Matsushita Electric Industrial Co., Ltd. Corporate Management Division for the Americas

Sales Office for North America

Tokyo Panasonic Sales Section

32nd Floor, World Trade Center 4-1, Hamamatsu-cho, 2-Chome, Minato-Ku, Tokyo 105-6132, Japan

© 2001 Matsushita Electric Industrial Co., Ltd.

Panasonic Sales Company, Division of Matsushita Electric of Puerto Rico, Inc. ("PSC")

Ave. 65 de Infantería, Km. 9.5 San Gabriel Industrial Park, Carolina, Puerto Rico 00985

Panasonic Marketing Europe G.M.B.H. Wiesbaden N. (a Division of Panasonic Marketing G.M.B.H.)

Military Sales Department

6200 Wiesbaden-Biebrich, Hagenauerstr. 43 Germany

[For Canada]

Panasonic Canada Inc.

5770 Ambler Drive Mississauga, Ontario L4W 2T3
www.panasonic.ca

[For others]

Matsushita Electric Industrial Co., Ltd.

Web Site: <http://www.panasonic.co.jp/global/>

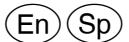

RQT6236-1P

F1101YU2022

Specifications

Signal system:

[For U.S.A., Canada and units with PX printed on the outer packaging]

NTSC

[For others]

PAL 625/50, PAL525/60, NTSC

Operating temperature range: +5 to +35 °C (+41 to +95 °F)

Operating humidity range: 5 to 90 % RH (no condensation)

Discs played [8 cm (3") or 12 cm (5")]:

(1) DVD-Video, DVD-R (DVD-Video compatible)

(2) CD-Audio (CD-DA)

(3) Video CD

(4) CD-R/CD-RW (CD-DA, Video CD formatted discs)

(5) MP3

• Maximum number of tracks and groups recognizable: 999 tracks and 99 groups*

• Compatible compression rate: between 32 kbps and 320 kbps

[DVD-RV32] [DVD-RV27]

(For U.S.A., Canada and units with PX printed on the outer packaging)

(6) WMA

Video output:

Output level: 1 Vp-p (75 Ω)

Output terminal: Pin jack (1 system)

S video output:

Y output level: 1 Vp-p (75 Ω)

C output level: NTSC; 0.286 Vp-p (75 Ω)

[For the Middle East, South Africa, Asia, Australia and N.Z.]

PAL; 0.300 Vp-p (75 Ω)

Output terminal: S terminal (1 system)

Component video output:

Y output level: 1 Vp-p (75 Ω)

P_B output level: 0.7 Vp-p (75 Ω)

P_R output level: 0.7 Vp-p (75 Ω)

Output terminal: Pin jack (Y: green, P_B: blue, P_R: red)

Number of terminals: 1 system

Audio output:

Output level: 2 Vrms (1 kHz, 0 dB)

Output terminal: Pin jack

Number of terminals:

2ch: 1 system

Subwoofer output (0.1 ch): 1 system

Audio performance:

(1) Frequency response:

• DVD (linear audio): 4 Hz–22 kHz (48 kHz sampling)

4 Hz–44 kHz (96 kHz sampling)

4 Hz–20 kHz

• CD audio:

(2) S/N ratio:

• CD audio: 115 dB

(3) Dynamic range:

• DVD (linear audio): 102 dB

• CD audio: 98 dB

(4) Total harmonic distortion:

• CD audio: 0.0025 %

Digital audio output:

Optical digital output: Optical terminal

Pickup: Wave length: 658 nm/790 nm

[For U.S.A., Canada and units with PX printed on the outer packaging]

Laser power: CLASS IIa/CLASS I

[For the Middle East, South Africa, Asia, Australia and N.Z.]

Laser power: CLASS 2/CLASS 1

Power supply:

[For U.S.A. and Canada] AC 120 V, 60 Hz

[For Australia and N.Z.] AC 220–240 V, 50 Hz

[For others] AC 110–240 V, 50/60 Hz

Power consumption:

14 W

Dimensions:

430 (W) × 247 (D) × 74.5 (H) mm

[16⁵/₁₆" (W) × 9⁷/₁₆" (D) × 2¹⁵/₁₆" (H)]

(excluding protrusions)

Mass:

2.4 kg (5.31 lb.)

Power consumption in standby mode:

[DVD-RV32]

(For U.S.A. and Canada)

approx. 2 W

(For others)

approx. 3 W

[DVD-RV27] [DVD-RV22]

approx. 2 W

[Note]

*Including WMA files. [DVD-RV32] [DVD-RV27]

(For U.S.A., Canada and units with PX printed on the outer packaging)

Specifications are subject to change without notice.

Mass and dimensions are approximate.

Manufactured under license from Dolby Laboratories.
"Dolby", "Pro Logic" and the double-D symbol are trademarks of
Dolby Laboratories.

"DTS", "DTS Digital Surround" and "DTS Digital Out" are regis-
tered trademarks of Digital Theater Systems, Inc.

Apparatus Claims of U.S. Patent Nos. 4,631,603, 4,577,216, and 4,819,098, licensed for limited viewing uses only.

This product incorporates copyright protection technology that is protected by method claims of certain U.S. patents and other intellectual property rights owned by Macrovision Corporation and other rights owners. Use of this copyright protection technology must be authorized by Macrovision Corporation, and is intended for home and other limited viewing uses only unless otherwise authorized by Macrovision Corporation. Reverse engineering or disassembly is prohibited.

[For U.S.A.]

**Panasonic Consumer Electronics
Company, Division of Matsushita
Electric Corporation of America**

One Panasonic Way Secaucus,
New Jersey 07094

<http://www.panasonic.com>

[For units with PX printed on the outer packaging]

**Matsushita Electric Industrial Co., Ltd.
Corporate Management Division for
the Americas**

Sales Office for North America

Tokyo Panasonic Sales Section

32nd Floor, World Trade Center 4-1,
Hamamatsu-cho, 2-Chome, Minato-Ku,
Tokyo 105-6132, Japan

© 2001 Matsushita Electric Industrial Co., Ltd.

**Panasonic Sales Company,
Division of Matsushita Electric of
Puerto Rico, Inc. ("PSC")**

Ave. 65 de Infantería, Km. 9.5
San Gabriel Industrial Park, Carolina,
Puerto Rico 00985

**Panasonic Marketing Europe G.M.B.H.
Wiesbaden N. (a Division of Panasonic Mar-
keting G.M.B.H.)**

Military Sales Department

6200 Wiesbaden-Biebrich,
Hagenauerstr. 43
Germany

[For Canada]

Panasonic Canada Inc.

5770 Ambler Drive
Mississauga, Ontario
L4W 2T3
www.panasonic.ca

[For others]

Matsushita Electric Industrial Co., Ltd.

Web Site: <http://www.panasonic.co.jp/global/>



RQT6236-1P

F1101YU2022