

Panasonic®

使用说明书（另附保修证）
Operating Instructions

交流·充电式 电动剃须刀
AC • Rechargeable Shaver

型号 ES-LC60
Model No.

中文	2
English	9



在使用本产品前，请仔细阅读本说明书并妥善保管。
Before operating this unit, please read these instructions completely and save them.

重要事项

► 使用剃须刀

注意 - 外刀网很薄，若使用不正确就可能造成损坏。使用剃须刀前，请确认刀网是否损坏。如果刀网已损坏请不要使用该剃须刀，因为这样会割伤皮肤。请勿用于修剪宠物的毛发。

► 给剃须刀充电

除本型号 (RE7-27) 剃须刀专用充电器外，请勿使用其他任何电源线或充电器进行充电。将充电器插入家用插座内，操作时双手要保持干燥。剃须刀在使用和充电过程中可能会变热，但这不是故障。不要将剃须刀放置在阳光直射或有其他热源的地方下进行充电。从家用插座上拔出充电器时请抓紧充电器。如果用力拉电源线，可能会损坏电源线。存放剃须刀时请拔出电源线。不要折弯电源线或将电源线绕在剃须刀上。

充电的合适环境温度为 15 至 35 摄氏度。如充电状态 (➡) 灯不亮，请稍等片刻直至其亮起。

► 清洁剃须刀

警告 - 清洁剃须刀前请断开电源线，以防

触电。

请保持两个内刀头同时装载的情况下进行清洗，若在仅装有一个内刀头的状态进行清洗，可能会损坏剃须刀。用清水清洗剃须刀，不要使用盐水或热水。不要将剃须刀长时间浸泡在水中。可用蘸肥皂水的布擦拭剃须刀。不要使用稀释剂，汽油或酒精擦拭剃须刀任何部位。

► 存放剃须刀

存放剃须刀时应断开电源线。不要弯曲电源线或将其缠绕在剃须刀上。本品不宜供肢体、感官或精神上有残疾者、缺乏经验和知识者（包括儿童）使用，除非有人对此类人加以监督或者对本品的使用加以指导，且对使用者的安全能承担责任。请对儿童进行监督，避免其将本品视为玩具，引发危险。请妥善保管本说明书。请妥善处理本产品的包装袋，避免婴幼儿窒息等意外发生。

各部分名称

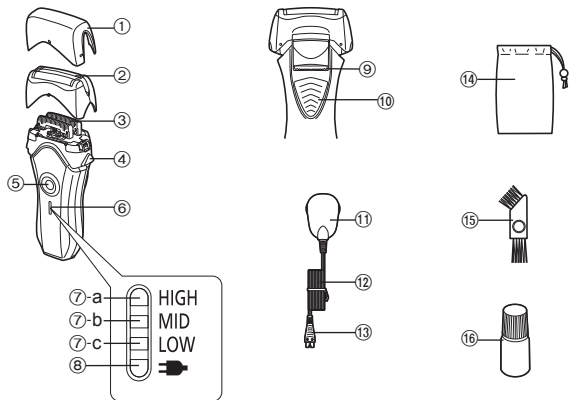

- | | |
|-----------|----------------|
| ① 保护盖 | ⑧ 充电状态 (🔌) 灯 |
| ② 外刀网 | ⑨ 修剪刀 |
| ③ 内刀头 | ⑩ 修剪刀操纵杆 |
| ④ 外刀网释放按钮 | ⑪ 充电器 (RE7-27) |
| ⑤ 0/1 开关 | ⑫ 电源线 |
| ⑥ LED 显示灯 | ⑬ 电源插头 |
| ⑦ 电池电量显示灯 | ⑭ 旅行包 |
| a- HIGH | ⑮ 清洁刷 |
| b- MID | ⑯ 润滑油 |
| c- LOW | |

充电

充电中

女
中

当“LOW”闪烁时表示电池电量低。
在“LOW”闪烁后还可剃须 1 至 2 次。
(根据使用情况而定。)

• 充足电后大约可提供 14 次剃须所需的电量。
(以一次剃须 3 分钟计)

- 1 将充电器电源线插头连接到剃须刀上。
- 2 将充电器插头插入家用电源插座里。

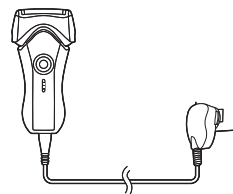

► 交流电剃须

当电池电量低时，您也可以将剃须刀通过充电器连接至家用电源插座，利用交流电进行剃须。

• 如果剃须刀不能工作，请充电约 1 分钟后使用。

关于指示灯

充电时

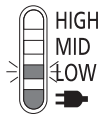

充电状态 () 灯亮。

- “LOW” 闪烁。

充电完成 10 分钟后

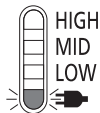

充电状态 () 灯每 2 秒闪烁一次。

- “HIGH/MID/LOW” 关闭。

充电完成后

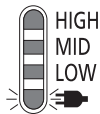

充电状态 () 灯每秒闪烁一次。

电池电量不足时

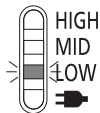

“LOW” 闪烁。

剃须

使用剃须刀



- 1 按下 0/1 开关。
- 2 如上图所示握住剃须刀剃须。

- 轻轻地压向面部开始剃须。用另一只手绷紧脸上皮肤，对准胡须前后移动剃须刀。当皮肤适应剃须刀之后您可以稍稍增加压力。但是施加过多的压力却有可能造成皮肤伤害。

► 使用修剪刀

将修剪刀操纵杆往上推，以打开修剪刀。将修剪刀放置与皮肤成直角（90度）的位置，然后向下移动以修剪鬓角。

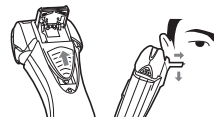

清洁

清洁剃须刀

3

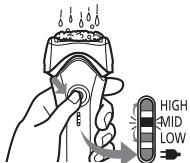

1. 断开电源线。
2. 在外刀网上涂少许洗手液。
3. 按下 0/1 开关 2 秒钟以上启动声波洗净模式进行“sonic”（声波）振动清洗。

• 大约 20 秒钟后，它会自动关闭，或者按 0/1 开关关闭它。

4

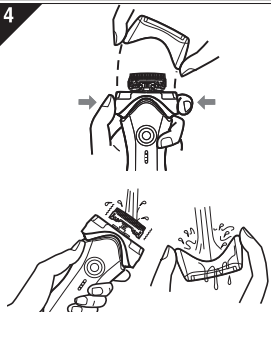

4. 取下外刀网，按下 0/1 开关 2 秒钟以上启动声波洗净模式进行“sonic”（声波）振动清洗。使用流动水来清洁。
5. 用干布拭去水珠。

6



6. 将外刀网和剃须刀完全擦干
7. 将外刀网安装至剃须刀。
8. 给剃须刀上油。



左侧符号表示剃须刀可以用水清洗。

警告：剃须刀需与电源软线分离后才能用水清洗。

注意声波洗净模式

- 以声波洗净模式剃须可能会损伤皮肤。关闭剃须刀，再打开即可取消声波洗净模式。
- 使用剃须刀时不要将手指放在 0/1 开关上。这样会导致剃须刀关闭或进入声波洗净模式。

以
母

润滑

为长期保持剃须的舒适度，建议使用随剃须刀一起提供的润滑油。

1. 关闭剃须刀。
2. 给每个外刀网加一滴油。
3. 推起修剪刀并加一滴油。
4. 接通剃须刀电源，运转约 5 秒钟。
5. 关闭剃须刀，使用软布从外刀网上拭去多余的润滑油。

更换外刀网和内刀头

建议外刀网每年更换一次，内刀头每两年更换一次，以维持剃须刀剃须性能。

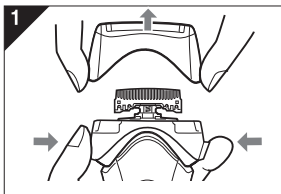

1. 如图示，按下外刀网释放按钮并向上提起取出外刀网。

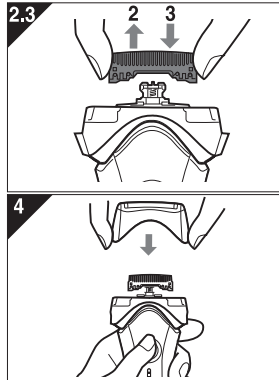

2. 如图示取下内刀头，每次取下一个。
 - 不要触摸内刀头的边沿（金属部分），以防伤手。
3. 如图示，安装内刀头时，每次插入一只内刀头，直至固定位置为止。
4. 向下插入外刀网直至固定位置为止。

使用刷子清洁

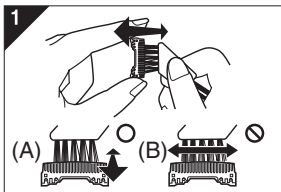

1. 使用短刷，沿图示(A)的移动方向移动，清洁内刀头。
使用长刷，清洁外刀网，剃须刀机身和修剪刀。
 - 请勿沿(B)方向移动短刷，因为这样将损坏内刀头，影响刀片的锋利度。
 - 请勿使用短刷清洁外刀网。

取出内置的可充电电池

本机内藏有可充电的电池，在消费者决定废弃本机前，请务必将电池从机器中取出。

- 分解剃须刀，取出电池前，一定要断开电源。
- 建议消费者在决定废弃剃须刀前，事先征求经销商或本公司指定维修点的意见，尽量延长剃须刀的使用寿命。
- 当消费者决定废弃剃须刀又不想自行分解机器取出电池时，建议消费者将器具送往本公司指定的维修站，由维修店对电池进行分解和回收。
- 电池务必废弃于政府规定的地方或回收处理单位。
- 按右图所示的①～⑦的顺序拆开本体，卸下电池。

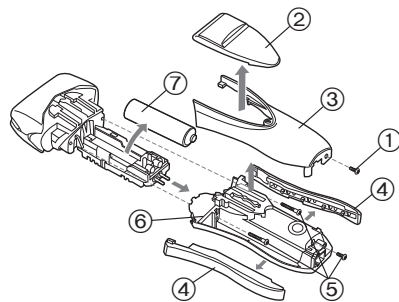

环境保护与资源回收

此剃须刀使用锂电池。
如果您的国家有相关规定，请务必在指定处
对旧电池进行统一处理。

规格

产品名称	电动剃须刀
产品型号	ES-LC60
额定电压	交流 100-240 V 50-60 Hz (自动电压转换)
马达电压	直流 3.6 V
充电时间	1 小时
原产地	本机：日本 充电器：中国
生产日期	请见商品上刻印
执行标准	GB4706.1 附录 B、GB4706.9

规格如有变更，恕不另行通知。
本产品仅适合家庭使用。

Important

► Using the shaver

Caution - The outer foil is very thin and can be damaged if not used correctly. Check that the foil is not damaged before using the shaver. Do not use the shaver if the foil etc. is damaged as you will cut your skin.

► Charging the shaver

Do not use any power cord or AC adaptor other than one specifically designed for this model (RE7-27). Plug in the adaptor into a household outlet where there is no moisture and handle it with dry hands. The shaver may become warm during use and charging. However, this is not a malfunction. Do not charge the shaver where it will be exposed to direct sunlight or other heat sources. Hold the adaptor when disconnecting it from the household outlet. If you tug on the power cord, you may damage it. The supply cord cannot be replaced. If the cord is damaged, the appliance should be scrapped. Adequate ambient temperature for charging is 15-35 °C.

If the charge status (➡) lamp does not glow initially when the shaver is plugged in, wait for a short while until it does.

► Cleaning the shaver

Warning - Disconnect the power cord from the shaver before cleaning it to prevent electric shock. Keep both the inner blades inserted. If only one of

the inner blades is inserted, the shaver may be damaged. If you clean the shaver with water, do not use salt water or hot water. Do not soak the shaver in water for a long period of time. Wipe it with a cloth dampened with soapy water. Do not use thinner, benzine or alcohol.

► Storing the shaver

Disconnect the power cord when storing the shaver. Do not bend the power cord or wrap it around the shaver. This appliance is not intended for use by persons (including children) with reduced physical, sensory or mental capabilities, or lack of experience and knowledge, unless they have been given supervision or instruction concerning use of the appliance by a person responsible for their safety. Children should be supervised to ensure that they do not play with the appliance. Keep these operating instructions in a safe place.

Parts identification

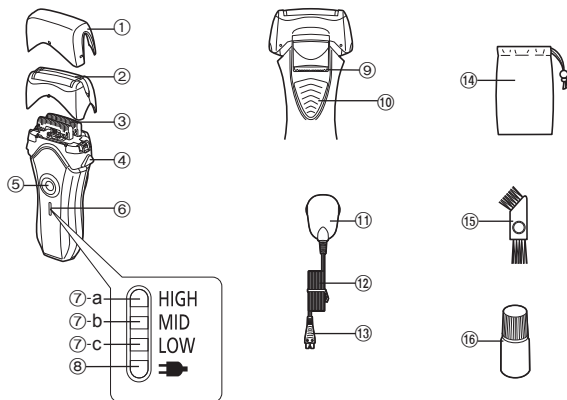

- ① Protective cap
- ② System outer foil
- ③ Inner blades
- ④ System outer foil release buttons
- ⑤ 0/1 switch
- ⑥ LED display
- ⑦ Battery capacity monitor
 - a- HIGH
 - b- MID
 - c- LOW
- ⑧ Charge status () lamp
- ⑨ Trimmer
- ⑩ Trimmer handle
- ⑪ Adaptor (RE7-27)
- ⑫ Power cord
- ⑬ Appliance plug
- ⑭ Travel pouch
- ⑮ Cleaning brush
- ⑯ Oil

Charge

Charging

The battery capacity is low when “LOW” blinks.
You can shave 1 to 2 times after “LOW” blinks.
(This will differ depending on usage.)

- A full charge will supply enough power for approx. 14 shaves of 3 minutes each.

- 1** Insert the appliance plug into the shaver.
- 2** Plug in the adaptor into a household outlet.

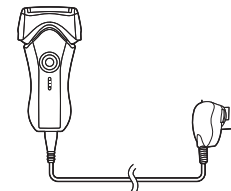

► Cord shaving

If you insert the appliance plug to the shaver and plug in the adaptor into a household outlet, you can use it even if the battery capacity is low.

- If the shaver does not work, continue charging it for approx. 1 minute.

About the LED display

While charging

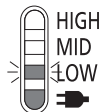

The charge status (➡) lamp glows.
• "LOW" blinks.

10 minutes after charging is completed



The charge status (➡) lamp blinks once every 2 seconds.
• "HIGH/MID/LOW" go out.

After charging is completed

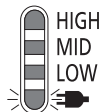

The charge status (➡) lamp blinks once every second.

When the battery capacity is low

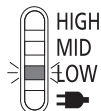

"LOW" blinks.

Shave

Using the shaver



1 Press the 0/1 switch.

2 Hold the shaver as illustrated above and shave.

- Start out shaving by applying gentle pressure to your face. Stretch your skin with your free hand and move the shaver back and forth in the direction of your beard. You may gently increase the amount of pressure as your skin becomes accustomed to this shaver. Applying excessive pressure does not provide a closer shave.

▶ Using the trimmer

Slide the trimmer handle up. Place at a right angle to your skin and move downwards to trim your sideburns.

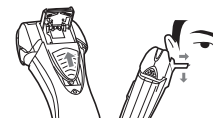

Clean

Cleaning

3

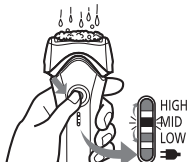

1. Disconnect the power cord from the shaver.
2. Apply some hand soap and some water to the outer foil.

4

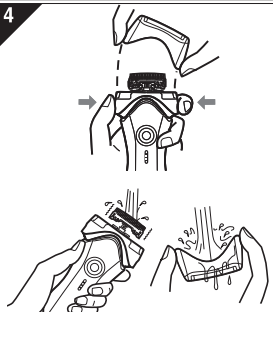

3. Press the 0/1 switch for more than 2 seconds to activate the turbo mode for “sonic” vibration cleaning.
 - After about 20 seconds, it will be automatically turned off, or you can turn it off by pressing the 0/1 switch.
4. Remove the system outer foil and press the 0/1 switch for more than 2 seconds to activate the turbo mode for “sonic” vibration cleaning and clean it with running water.
5. Wipe off any drops of water with a dry cloth.

6



6. Dry the system outer foil and the shaver completely.
7. Attach the system outer foil to the shaver.
8. Lubricate the shaver.



The mark on the left is for a washable shaver and indicates it can be cleaned with water.

Caution for turbo mode

- Shaving in turbo mode may damage your skin. Turn the shaver off and then on again to cancel turbo mode.
- Do not place your fingers on the 0/1 switch while using the shaver. This may cause the shaver to turn off or enter turbo mode.

Lubrication

To maintain shaving comfort for a long time, it is recommended that the oil provided with the shaver is used.

1. Switch off the shaver.
2. Apply one drop of oil to each of the outer foils.
3. Raise the trimmer and apply a drop of oil.
4. Switch the shaver on, and run it for approximately five seconds.
5. Switch off the shaver, and wipe off any excess oil from the outer foils with a soft cloth.

Replacing the system outer foil and the inner blades

system outer foil	once every year
inner blade	once every two years

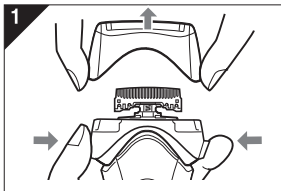

1. Press the system outer foil release buttons and lift the system outer foil upwards as illustrated.

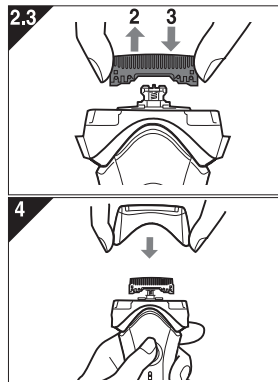

2. Remove the inner blades one at a time as illustrated.
 - Do not touch the edges (metal parts) of the inner blades to prevent injury to your hand.
3. Insert the inner blades one at a time until they click as illustrated.
4. Insert the system outer foil by pushing it downwards until it clicks.

Cleaning with the brush

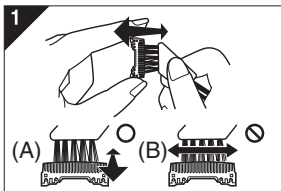

1. Clean the inner blades using the short brush by moving it in direction (A). Clean the system outer foil, the shaver body and the trimmer using the long brush.
 - Do not move the short brush in direction (B) as it will damage the inner blades and affect their sharpness.
 - Do not use the short brush to clean the outer foils.

Removing the built-in rechargeable battery

Remove the built-in rechargeable battery before disposing of the shaver. Please make sure that the battery is disposed of at an officially designated location if there is one. Do not dismantle or replace the battery so that you can use the shaver again. This could cause fire or an electric shock. Replace it at an authorized service center.

- Disconnect the power cord from the shaver when removing the battery.
- Perform steps ① to ⑦ and lift the battery, and then remove it.

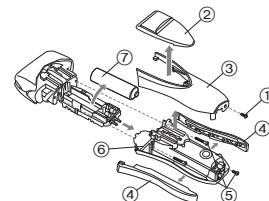

For environmental protection and recycling of materials

This shaver contains a Lithium-ion battery. Please make sure that the battery is disposed of at an officially assigned location, if there is one in your country.

SPECIFICATIONS

Product name	AC • Rechargeable Shaver
Product model	ES-LC60
Power source	a.c 100-240 V 50-60 Hz
Motor voltage	d.c 3.6 V
Charging time	1 hour
Place of origin	Main body: Japan Adaptor: China
Produce date	Please see on the commodity to engrave
Execution standard	GB4706.1 appendix B GB4706.9

Specifications are subject to change without notice.
This product is intended for household use only.



进口商：松下电工（中国）有限公司
地址：北京市朝阳区建国路79号 华贸中心2号写字楼6层、7层703室
电话：86-10-59255988
邮政编码：100025

制造商：松下电工株式会社
地址：日本大阪府门真市门真1048

Panasonic Electric Works Co., Ltd.
1048, Kadoma, Osaka 571-8686, Japan

日本印刷
Printed in Japan
ES9700LC601K Y0709-0
发行：2009年7月

© CH, EN

