

## 程序表

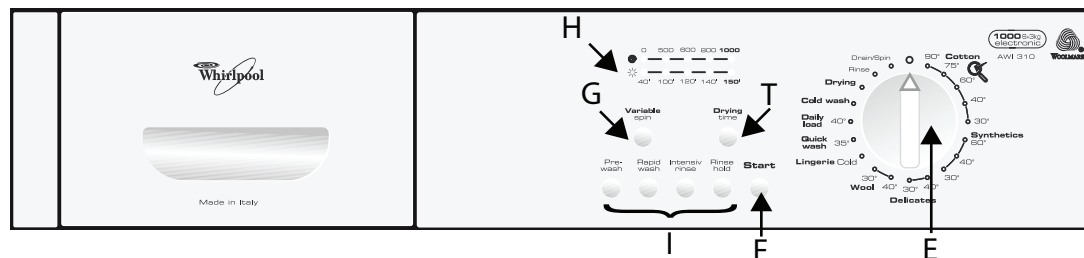

## E. 程序選擇旋鈕

## F. 「開始」按鈕

## G. 「脫水轉速選擇」按鈕

## T. 「乾衣時間」按鈕

## H. 轉速及乾衣指示燈

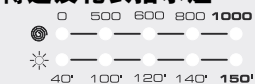

## I. 選擇功能按鈕

程序	溫度	護理標籤	最大洗衣量 公斤	衣物類型 / 備註  -關於溫度的選擇, 請遵從護理標籤上的製造商建議	洗衣劑及添加劑			特別功能					最高脫水轉速 轉/分鐘	
					預洗 	主洗 	柔順劑 	乾衣時間	預洗	深層過水	延遲脫水	速洗		脫水轉速選擇
白色純棉質 / 抗菌	75 - 90 °C		6.0	一般至非常骯髒之床單、桌布及內衣褲、毛巾、襯衫等棉麻衣物。溫度80°C以上, 此程序可消滅細菌, 確保衣物衛生。細菌消滅效能通過2001年11月NF EN 13697標準的類似方式測試。	*	是	*	*	*	*	—	*	*	最高
棉質	60 °C		6.0		30 - 40 °C			6.0	*	是	*	*	*	*
合成纖維	30 - 60 °C	  	3.0	一般至非常骯髒之襯衫、罩衫等滌綸(迪奧綸、特雷維拉)、錦綸(貝龍、尼龍)或混棉織物。	*	是	*	*	*	*	*	*	*	800 <sup>1)</sup>
織幼衣物	30 - 40 °C	 	3.0	窗簾與質料織幼之連身裙、半截裙及襯衫等衣物。	—	是	*	—	—	—	*	*	*	500 <sup>1)</sup>
羊毛	30 - 40 °C	 	1.5	只可洗滌有羊毛標記並標明可機洗的羊毛衣物。此程序(40°C)經國際羊毛局測試及認可, 適合手洗之衣物。	—	是	*	—	—	—	—	—	*	800 <sup>1)</sup>
貼身衣物	—	—	3.0	窗簾、手洗之絲質及羊毛衣物, 只適用於冷水。	—	是	*	—	—	—	—	—	*	800 <sup>1)</sup>
速洗	35 °C		3.0	適合穿著時間短之外衣等棉質、滌綸、錦綸及混棉織物。	—	是	*	*	—	—	—	—	*	最高
日日洗	40 °C	 	4.0	輕微到一般骯髒之棉質和/ 或合成纖維衣物。	*	是	*	*	*	*	—	—	*	最高
冷水洗	—	—	6.0	輕微骯髒之棉質和/ 或合成纖維衣物, 只適用於冷水。	—	是	*	*	—	*	—	—	*	最高
乾衣	—		3.0	乾衣能處理之棉質程序(3公斤)/合成纖維程序(1.5公斤)	—	—	—	*	—	—	—	—	—	—
過水	—	—	6.0	與「棉質」程序的最後一次過水及最後脫水相同。	—	—	*	*	—	*	—	—	*	最高
排水 / 脫水	—	—	6.0	此程序進行強力脫水。與「棉質」程序的脫水步驟相同。	—	—	—	*	—	—	—	—	*	最高

\* : 可選擇 / 是 : 須放入洗衣劑

1) 為更好地護理衣物, 此程序的脫水轉速被受限制。

此洗衣機之“羊毛”清洗程序經由 The Woolmark Company 認可, 適合有可機洗羊毛標誌的衣物使用。請依照衣物上的清洗指示及洗衣機生產商所提供之洗衣指引。(Cert. No. M0402-M0403-M0404-M0405)。

惠而浦乃美國惠而浦 Whirlpool, U.S.A. 的註冊商標。



## 水電消耗資料表

程序	溫度 (°C)	洗衣量 (公斤)	耗水量 (公升)	耗電量 (千瓦小時)	大約程序時間 (小時：分鐘)*
白色純棉質 / 抗菌	90	6.0	60**	1.70	2:09
棉質	75	6.0	60	1.33	2:05
棉質加「節能」***	60	6.0	57	0.94	2:07
棉質	40	6.0	57	0.69	1:51
合成纖維	60	3.0	44**	0.88	1:51
合成纖維	40	3.0	44	0.43	1:39
日日洗	40	4.0	40	0.39	1:28
速洗	35	3.0	37	0.27	0:41
纖幼衣物	30	3.0	50	0.22	0:53
羊毛	40	1.5	54	0.39	0:50

上表中的能源消耗資料，是根據 IEC/EN 60 456 標準所規定的正常條件下測量而獲得。供水壓力和溫度以及洗衣量和衣物類型的不同，各家庭的能源消耗與上表中的資料可能會有不同。

\* 時間顯示器可能與表中所列數值有所偏差，因為剩餘時間按洗衣時的家庭實際情況計算。

\*\* 為在水泵排水前降低水溫，主洗步驟結束時會加入一些冷水。

\*\*\* 能源標籤的參考程序。

## 添加洗衣劑，關閉機門並選擇程序

按前頁所示和「使用說明書」中的「洗衣劑及添加劑」一章所述添加洗衣劑。

1. 將**程序選擇旋鈕**轉到所需程序。
2. 程序預設的轉速會於顯示器亮起；如欲更改轉速，請按「**脫水轉速選擇**」**按鈕**更改。

## 選擇所需的特別功能

按下所需的任何特別功能按鈕時，相應的指示燈會發亮。

如果程序與附加功能的組合不可能時，指示燈會自動熄滅。

不適當的功能組合會被自動取消。

### 「預洗」按鈕

- 僅適用於非常骯髒的衣物(含泥沙、粗粒)。洗衣時間約增加15分鐘。
- 當啟動預洗程序時，切勿使用液體洗衣劑。

### 「速洗」按鈕

- 綿質及合成纖維程序在速洗時會省卻預洗及一次過水程序，故可縮短洗衣時間。
- 注水量增加，配合輕柔的旋轉洗滌。

### 「深層過水」按鈕

- 注入額外的清水，循環沖洗時間會延長。
- 此選擇特別適用於軟性水質地區，清洗嬰兒衣物，及有助敏感症之人士。

### 「延遲脫水」按鈕

- 衣物保留在最後一次過水的水中，不進行最後脫水步驟，以防衣物起皺及變色。
- 建議採用「合成纖維」、「日日洗」或「纖幼衣物」程序時選擇此功能。
- 當延遲脫水或只想排水時，此功能特別有用。
- 如選擇了「延遲脫水」，切勿讓衣物浸泡過久。

**備註：**程序步驟顯示器的「防皺」指示燈發亮時，程序在「延遲脫水」時停止。「**開始**」按鈕旁邊的指示燈會閃爍。

### 結束「延遲脫水」功能：

- 按下「**開始**」按鈕，洗衣機將運行到當前洗衣程序的最後脫水步驟時自動結束程序。

### 「脫水轉速選擇」按鈕

- 每一程序均有一個預設最高的脫水轉速。
- 按此按鈕以另設脫水轉速。
- 如選擇的脫水轉速為「0」，最後一次脫水將會取消，但過水時的中途脫水仍會保留。只會進行排水。

## 乾衣時間

當使用自動洗衣程序，按此按鈕選擇乾衣時間(於清洗完畢時)或於自選程序選擇「乾衣」程序(於手洗衣物時)。  
需在自選程序選擇「乾衣」程序時，脫水轉速最低為800轉/分鐘。當乾衣程序啟動時，程序指示燈會發亮。

## 程序表

打開水龍頭並按下「**開始**」按鈕。「**開始**」按鈕旁邊的指示燈發亮。

洗衣程序指示燈會順序顯示正進行之洗衣階段；從左至右為預洗，洗衣，過水，排水/脫水，完成。

## 「開門」指示燈

當結束洗衣程序後，「**完成**」指示燈發亮表示可以打開機門。洗衣程序運行期間，機門保持鎖閉，決不能強行打開。如在洗衣程序運行期間您急需打開機門，請參閱「結束前取消(重設)運行中的程序」。

## 紅色顯示燈

### 「維修」指示燈

「維修」指示燈的發亮可能是由一個電子元件的故障所引至。請參閱「使用說明書」的「故障排除指引」；如果故障依然存在，請聯絡我們的星級服務中心。

### 「清理過濾器」指示燈

廢水未泵出。檢查排水軟管是否扭曲或過濾器是否需要清潔；在後一種情況請查閱「使用說明書」(「拆除過濾器」)。

### 「入水喉關閉」指示燈

洗衣機無水供應或供應不足。打開水龍頭把程序選擇旋鈕調校到「關機/0」位置，並重新設定程序；如指示燈仍顯示，請查閱「使用說明書」中的「故障排除指引」。

## 「開門」指示燈

「開門」指示燈的發亮可能是洗衣門仍未關上，可再次關上，關上後把程序選擇旋鈕調校到「關機/0」位置並重新設定程序；如指示燈仍顯示，請查閱「使用說明書」中的「故障排除指引」。

## 洗衣程序結束

- 洗衣程序結束後，洗衣順序指示燈會發亮，表示機門鎖已開啟。

1. 將程序選擇旋鈕轉到「關機/0」位置。
2. 關閉水龍頭。
3. 打開機門並取出衣物。
4. 讓機門微開，令洗衣鼓吹乾。

## 程序開始後改變程序及 / 或特別功能

1. 把程序選擇旋鈕調校到「關機/0」位置。
2. 選擇新程序和任何特別功能，如需要時也可選另一脫水轉速。
3. 再次按下「**開始**」按鈕。新程序在先前的程序中斷之處繼續進行。此程序無需添加洗衣劑。

## 結速前取消(重設)運行中的程序

- 把程序選擇旋鈕調校到「關機/0」位置，並選擇「排水/脫水」以便機門被打開前排走所有留在機內的水。。

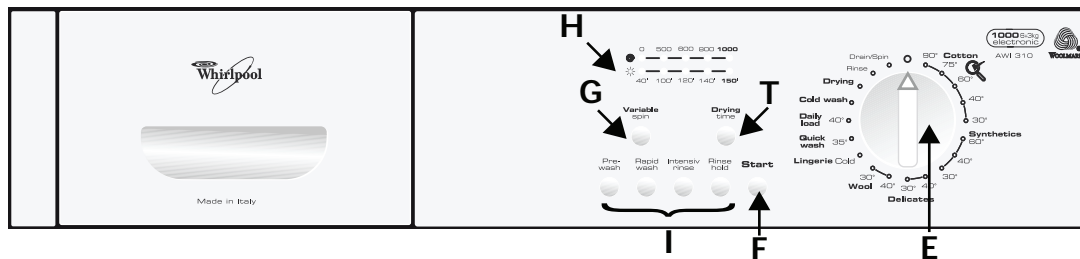

- E. Programme selector
- F. "Start" button
- G. "Variable spin" button
- T. "Drying time" button
- H. Spin speed indicator / Drying time indicator
- I. Optional function buttons

Programme	Temperature	Care Labels	Max. Load kg	Type of wash/Notes - For temperature selection, respect the manufacturer's recommendations on the care label	Detergents and additives			Special functions					Max. spin speed rpm	
					Pre-wash	Main wash	Softener	Drying time	Pre-wash	Intensive rinse	Rinse hold	Rapid wash		Variable spin
<b>White Cotton Antibacterial</b>	75 - 90 °C		6.0	Normally to heavily soiled bed linen, table linen and underwear, towels, shirts etc. made of cotton and linen. At a temperature of 80°C or more, this programme eliminates bacteria, ensuring sanitization of your laundry. The bacteria removal efficiency has been tested following a similar methodology to the NF EN 13697 standard of Nov. 2001.	—	—	—	—	—	—	—	—	—	—
<b>Cotton</b>	60 °C		6.0		*	Yes	*	*	*	*	—	*	*	Max.
	30 - 40 °C		6.0		—	—	—	—	—	—	—	—	—	—
<b>Synthetics</b>	30 - 60 °C		3.0	Normally soiled blouses, shirts, overalls etc. made of polyester (Diolen, Trevira), polyamide (Perlon, Nylon) or blends with cotton.	*	Yes	*	*	*	*	*	*	*	800 <sup>1)</sup>
<b>Delicates</b>	30 - 40 °C		3.0	Curtains and delicate clothing, skirts, shirts and blouses.	—	Yes	*	—	—	—	*	*	*	500 <sup>1)</sup>
<b>Wool</b>	30 - 40 °C		1.5	Only woollens labelled with the Woolmark and identified as machine washable. This programme (40°C) is tested and approved by The Woolmark Company for handwashable wool.	—	Yes	*	—	—	—	—	—	*	800 <sup>1)</sup>
<b>Lingerie</b>	—	—	3.0	Curtains and delicate clothing in wool or silk only washable in cold water.	—	Yes	*	—	—	—	—	—	*	800 <sup>1)</sup>
<b>Quick wash</b>	35 °C		3.0	Outer clothing worn for short periods and made of cotton, polyester, polyamide and cotton blends.	—	Yes	*	*	—	—	—	—	*	Max.
<b>Daily load</b>	40 °C		4.0	Slightly to normally soiled garments made of cotton and/or synthetics.	*	Yes	*	*	*	*	—	—	*	Max.
<b>Cold wash</b>	—	—	6.0	Slightly soiled garments in cotton and/or synthetics washable only in cold water.	—	Yes	*	*	—	*	—	—	*	Max.
<b>Drying</b>	—		3.0	Drying can be carried out using the "Cotton" programme (with dry laundry load of 3 kg) or the "Synthetics" programme (with dry laundry load of 1.5 kg).	—	—	—	*	—	—	—	—	—	—
Rinse	—	—	6.0	Same as the last rinse and the final spin in the "Cotton" programme.	—	—	*	*	—	*	—	—	*	Max.
Drain/Spin	—	—	6.0	In this programme spinning is intensive. Same as the spin cycle in the "Cotton" programme.	—	—	—	*	—	—	—	—	*	Max.

\* optional / Yes : dosing required

<sup>1)</sup> For improved garment care, spin speed is restricted in these programmes.

The "wool" programme of this washing machine has been approved by The Woolmark Company for the washing of garments labelled as "machine washable". Follow the instructions given on the label sewn on the garment and the instructions supplied by the washing-machine manufacturer. (Cert. no. M0402-M0403-M0404-M0405).



## CONSUMPTION DATA

Programme	Temperature (°C)	Load (kg)	Water (l)	Energy (kWh)	Approx. programme duration (hours : minutes)*
White Cotton / Antibacterial	90	6.0	60**	1.70	2:09
Cotton	75	6.0	60	1.33	2:05
Cotton with "Eco"***	60	6.0	57	0.94	2:07
Cotton	40	6.0	57	0.69	1:51
Synthetics	60	3.0	44**	0.88	1:51
Synthetics	40	3.0	44	0.43	1:39
Dailywash	40	4.0	40	0.39	1:28
Quickwash	35	3.0	37	0.27	0:41
Delicates	30	3.0	50	0.22	0:53
Wool	40	1.5	54	0.39	0:50

Consumption values were measured in normalized conditions in compliance with standard IEC/EN 60 456. In domestic use, consumption data may vary with respect to the values in the table in relation to the water supply pressure and temperature, the load and the type of wash.

\* The time indicated on the display (if present) can deviate from the values in the table, because it takes into account the household conditions applicable at that time.

\*\* To reduce the water temperature, some cold water is added at the end of the main wash cycle, before the pump drains the water out.

\*\*\* Reference programme for energy label.

## ADD DETERGENTS, CLOSE THE DOOR AND SELECT THE PROGRAMME

Add detergent as indicated on the front page and as described in the chapter "Detergent and Additives" in the Instructions for Use.

1. Turn the **programme selector** to the desired programme.
2. The indicator of the predefined **spin speed** lights up; in case you want to set another spin speed, press the "Variable spin" button.

## SELECT ANY DESIRED OPTION

Press the button(s) of any required option(s) - the respective indicator lights up.

When the combination of programme and additional option(s) is not possible, the indicators switch off automatically. Unsuitable combinations of options are deselected automatically.

### "Prewash" button

- Only for heavily soiled loads (e.g. sand, granular dirt). Increases the cycle time by approx. 15 minutes.
- Do not use liquid detergent for the main wash when activating the prewash option.

### "Rapid wash" button

- Allows you reduce the wash times of the "Cotton" and "Synthetics" programmes; with this option selected the machine does one less rinse and disables the prewash function.
- Increases the water quantity and the clothes are spun very gently.

### "Intensive rinse" button

- More water is added and the rinse cycle is prolonged.
- This option is particularly suitable for areas with very soft water, washing baby linen, and helps people with allergies.

### "Rinse hold" button

- The laundry remains in the last rinse water without the final spin cycle, to avoid creasing and prevent colours from changing.
- This option is particularly recommended for the "Synthetics", "Dailywash" or "Delicates" programmes.
- It is particularly useful if you want to postpone spinning to a later time, or if you want to drain only.
- If you select "Rinse hold", do not leave the laundry to soak for too long.

**Note:** The programme stops to "Rinse hold" at the time the "Rinse Hold" light in the programme sequence indicator is on. The indicator next to the "Start" button flashes.

### To terminate the "Rinse hold" option:

- Press the "Start" button; the programme will terminate automatically with the final spin cycle for the preset wash programme.

### "Variable spin" button

- Every programme has a predefined maximum spin speed.
- Press the button to set another spin speed.
- If spin speed "0" is selected, the final spin is cancelled but intermediate spin peaks remain during rinse. The water is drained out only.

## DRYING TIME

Press the button to select the drying time, in automatic mode (at end of wash cycle) or in manual mode, selecting the "Drying" programme (with hand-washed laundry). In the latter case it is necessary to spin at a speed of at least 800 rpm. The set time is that indicated by the light on; when they are all off drying is not carried out.

## PROGRAMME START

Open the tap and press the "Start". The indicator next to the "Start" button lights up. The programme sequence indicator shows the current programme stage, running from left to right through Prewash/Wash, Rinse, Spin/Drain, End.

## "DOOR OPEN" INDICATOR

The "Start" button flashes when the wash cycle has completed indicating that the door can now be opened. As long as a wash programme is running, the door remains locked and must not be forced open. In case you have an urgent need to open it during a running programme, refer to "Cancel (Reset) a running programme before the end".

## RED INDICATORS

### "Service" indicator

Lighting up of the "Service" indicator can be caused by a fault in an electrical component. Refer to the "Troubleshooting Guide" in the Instructions for Use; If the fault persists, contact our After-Sales Service.

### "Clean pump" indicator

The water is not pumped out. Check whether the drain hose is kinked or the filter must be cleaned; in the latter case refer to the Instructions for Use ("Removing the filter").

### "Door open" indicator

Lighting up of the indicator could be caused by the door not being properly closed. Try closing it again. Turn the programme selector to "Off/O" and reset the programme. If the indicator remains on, refer to the "Troubleshooting Guide" in the Instructions for Use.

## PROGRAMME END

- The "Start" button flashing indicates that the programme has finished and the door is unlocked.
1. Turn the programme selector to the "Off/O" position.
  2. Close the water tap.
  3. Open the door and unload the machine.
  4. Leave the door ajar to allow the drum to dry.

## CHANGING PROGRAMME AND/OR OPTIONS AFTER PROGRAMME START

1. Turn the programme selector to "Off/O".
2. Select the new programme, any options and another spin speed if you want.
3. Press the "Start" button again. The new programme resumes the wash programme from where the previous one was interrupted. Do not add detergent for this programme.

## CANCEL (RESET) A RUNNING PROGRAMME BEFORE THE END

- Reset by turning the programme selector to "Off/O" and select the "Drain Spin" programme to remove the water remaining in the bowl before the door can be opened.

**Gebrauchsanweisung**

使用説明書

**Mode d'emploi**

Gebruiksaanwijzing

**Istruzioni per l'uso**



**Brugsanvisning**

Bruksanvisning

**Käyttöohje**

Manual de utilização

**Instrucciones para el uso**



**Οδηγίες χρήσης**

Instrukcje użytkowania

**Használati utasítás**

Инструкция за употреба

**הוראות שימוש**



**Návod k použití**

Návod na použitie

**Instrucțiuni de utilizare**

Инструкции по эксплуатации

تعليمات وكيفية الاستعمال



# **CONTENTS**

**BEFORE USING THE WASHING MACHINE**

**PRECAUTIONS AND GENERAL  
RECOMMENDATIONS**

**INSTALLATION**

**DESCRIPTION OF THE WASHING MACHINE**

**DOOR**

**BEFORE THE FIRST WASH CYCLE**

**PREPARATION OF THE WASHING**

**DETERGENTS AND ADDITIVES**

**REMOVING THE FILTER/DRAINING  
RESIDUAL WATER**

**CARE AND MAINTENANCE**

**TROUBLESHOOTING GUIDE**

**AFTER-SALES SERVICE**

**ACCESSORIES**

**BUILT-IN MODELS**

# BEFORE USING THE WASHING MACHINE

## 1. Removing the packaging and inspection

- After unpacking, make sure that the washing machine is undamaged. If in doubt, do not use the washing machine. Contact After-Sales Service or your local retailer.
- Check that the accessories and supplied parts are all present.
- Keep the packaging materials (plastic bags, polystyrene parts, etc.) out of reach of children, as they are potentially dangerous.
- If the appliance was exposed to the cold before delivery, keep it at room temperature for a few hours before operating.

## 2. Remove the transport bolts

- The washing machine is fitted with transport bolts to avoid any possible damage to the interior during transport. Before using the washing machine, it is imperative that the transport bolts are removed.
- After their removal, cover the openings with the 4 enclosed plastic caps.

## 3. Install the washing machine

- You are advised not to install the appliance in a room where the temperature could drop to below 0°C.
- Given the weight of the appliance, attention must be paid to safety standards when it is being moved.
- When positioning the appliance, make sure that the power cable is not kinked or compressed and that it can be easily accessed if required.
- Remove the protective film from the control panel (if available on your model).
- Move the appliance without carrying it by the worktop.
- Install the appliance on a solid and level floor surface, preferably in a corner of the room.
- Make sure that all four feet are stable and resting on the floor and then check that the washing machine is perfectly level (use a spirit level).
- In case of wooden or so-called “floating floors” (for instance certain parquet or laminate floors), place the appliance on a 60 x 60 cm sheet of plywood at least 3 cm in thickness which is secured to the floor.

## 4. Water supply

- Connect the water supply inlet hose in accordance with the regulations of your local water company.
- Water supply: Cold water only (unless otherwise indicated on the programme chart)
- Water tap: 3/4" threaded hose connector"
- Water pressure (flow pressure): 100-1000 kPa (1-10 bar).

- Use only new hoses to connect the washing machine to the water supply. Used hoses must not be used and should be discarded,

## 5. Drain

- Connect the drain hose to the siphon or hook it over the edge of a sink by means of the “U” bend supplied.
- If the washing machine is connected to an integrated drainage system, ensure the latter is equipped with a vent to avoid simultaneous loading and draining of water (siphoning effect).

## 6. Electrical connections

- Electrical connections must be carried out by a qualified technician in compliance with the manufacturer’s instructions and current standard safety regulations.
- Voltage, power consumption and electrical protection data are supplied on the inside of the appliance door.
- The washing machine must be connected exclusively by means of a socket with an earth connection in accordance with current regulations. The washing machine must be earthed by law. The manufacturer declines all liability for possible damage to property or injury to persons or pets deriving from failure to observe the a/m directions.
- Do not use extension leads or multi sockets.
- Before any maintenance on the washing machine disconnect it from the mains supply.
- After installation, access to the mains plug or to disconnection from mains supply must be ensured at all times via a double-pole switch.
- Do not operate the washing machine if it has been damaged during transport. Inform the After-Sales Service.
- Mains cable replacement is only to be carried out by After-Sales Service.
- Use the appliance only for domestic washing and for its intended applications.

### Minimum housing dimensions:

Width:	600 mm
Height:	850 mm
Depth:	600 mm

# PRECAUTIONS AND GENERAL RECOMMENDATIONS

## 1. Packing

- The packaging material is entirely recyclable, and marked with the recycling symbol . Adhere to local regulations when disposing of packaging material.

## 2. Disposing of packaging and scrapping old washing machines

- The appliance is built from reusable materials. It must be disposed of in compliance with current local waste disposal regulations.
- Before scrapping, remove all detergent residues and cut off the power cable so that the washing machine is made unusable.
- This appliance is marked according to European Directive 2002/96/EC on Waste Electrical and Electronic Equipment (WEEE). By ensuring that this product is disposed of correctly, you will help prevent potential negative consequences for the environment and human health.



The symbol  on the product, or on the documents accompanying the product, indicates that this appliance may not be treated as household waste. Instead it shall be handed over to the applicable collection point for the recycling of electrical and electronic equipment.

Disposal must be carried out in accordance with local environmental regulations for waste disposal.

For more detailed information about treatment, recovery and recycling of this product, please contact your local city office, your household waste disposal service or the shop where you purchased the product.

## 3. Safety Instructions

- The washing machine can only be used indoors.
- Do not store flammable fluids near the appliance.
- If you want to place a dryer on top of your washing machine, first contact our After-Sales Service or your specialist dealer to verify if this is possible. Placing a dryer on your washing machine is only admitted by using an appropriate stacking kit available through our After-Sales Service or your specialist dealer.
- Do not leave the appliance plugged in when not in use.
- Turn off the tap when not in use.
- Before any cleaning and maintenance switch off the machine or disconnect it from the mains.
- Never open the door forcibly or use it as a step.
- Children must not be allowed to play with the washing machine or to climb into the drum.
- If necessary, the power cable may be replaced with an identical one obtained from our After-Sales Service. The power cable must only be replaced by a qualified technician.

## For washer/dryer models

- Do NOT dry items that have been washed or treated with chemical stain removers, cooking oil, petroleum, acetone, alcohol, petrol, paraffin, white spirit, wax. Remove these substances by means of a hot wash with abundant detergent before drying.
- Do NOT dry items made from foam rubber, latex, raincoats, waterproof fabrics, rubber airbeds, printed objects, clothes or pillows filled with foam rubber. These materials could melt and damage other items in the wash or damage the appliance.

## 4. Advice on saving energy

- To achieve the best use of energy, water, detergent and time use the recommended maximum load size.
- Do not exceed the recommended dosages on the detergent packet.
- The Eco Flap - a special system in the outlet - prevents detergent loss from the drum to avoid detergent loss into the environment.
- Use the "Pre-wash" programme for heavily soiled laundry only. Use a programme with no "Pre-wash" cycle for slightly or normally soiled items; You save on water, energy and time as a result.
- Before using the washing machine, treat laundry with a stain remover or soak dry stained items in water so as to avoid having to use high temperature wash programmes.
- Save energy by using a 60° C instead of a 95° C wash programme or a 40° C instead of a 60° C wash programme.
- Save energy and time by selecting a high spin speed to reduce the water content in laundry before using a drying programme (for machines with adjustable spin speed).

## 5. EC Declaration of Conformity

- The appliance conforms to the following European Standards:  
73/23/EEC Low voltage directive  
89/336/EEC EMC Directive  
93/68/EC CE Marking Directive





# INSTALLATION

## Remove the transport bolts

1. Loosen the three or four bolts (A).
2. Unscrew the bolts by hand.
3. Take hold of the bolts and plastic spacers and remove them. Keep the transport safety bolts for possible future use.
4. Close the holes with the plastic covers (supplied with the documents).

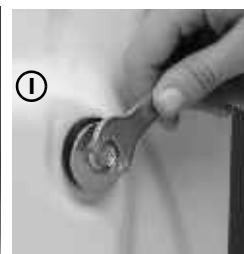
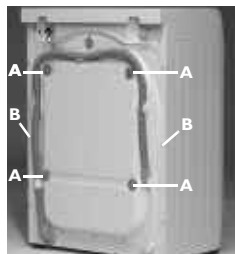

# TRANSPORT/HANDLING

## Never lift the appliance by the worktop when transporting.

1. Unplug the appliance.
2. Shut off the water tap.
3. Check that the door and detergent dispenser are properly closed.
4. Remove the water supply and drain hose from the domestic connection.
5. Remove any water remaining in the hoses and the appliance (see "Removing The Filter/Draining Residual Water").
6. Pry off the plastic covers with a screwdriver and remove them.
7. Insert the transit screws following the removal procedure in reverse.

# DESCRIPTION OF THE WASHING MACHINE

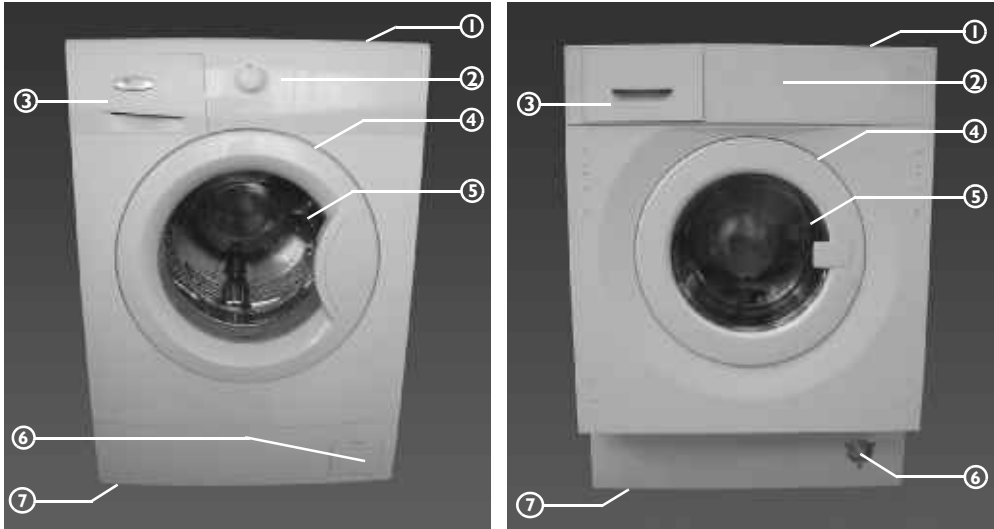

1. Worktop
2. Control panel
3. Detergent drawer
4. After-Sales Service sticker (inside door)
5. Door
6. Pump access behind plinth or cover (depending on the model)
7. Adjustable feet

## DOOR

To open the door, hold the door handle, press the inside handle (if available on your model) and pull the door. Close the door by pressing it without excessive force until it clicks shut.

## BEFORE THE FIRST WASH CYCLE

To remove any residual water used in testing by the manufacturer, we recommend that you carry out a short wash cycle without laundry.

1. Turn on the water supply tap.
2. Close the door.
3. Pour a little detergent (about 30 ml) into the main wash chamber  of the detergent dispenser.
4. Select and start a short programme (see separate “Programme Chart”).

# PREPARATION OF THE WASHING

## 1. Sort the load according to...

- **Type of fabric / care label symbol**  
Cottons, mixed fibres, easy care/synthetics, wool, handwash items.
  - **Colour**  
Separate coloured and white items. Wash new coloured items separately.
  - **Loading**  
Wash items of different sizes in the same load to improve washing efficiency and distribution in the drum.
  - **Delicates**  
Wash small items (e.g. nylon stockings, belts etc.) and items with hooks (e.g. bras) in a washbag or pillow case with a zip fastener. Always remove curtain glides or wash curtains with the glides inside a cotton bag.
- ## 2. Empty all pockets
- Coins, safety pins etc. can damage your laundry as well as the appliance drum and tub.
- ## 3. Fasteners
- Close zips and fasten buttons or hooks; loose belts or ribbons should be tied together.

## Stain removal

- Blood, milk, eggs etc. are generally removed by the automatic enzyme phase of the programme.
- For stains made by red wine, coffee, tea, grass, fruit etc. add a stain remover to the main wash chamber  of the detergent dispenser.
- Pre-treat heavily-soiled areas with stain remover if necessary.

## Dyeing and bleaching

- Only use dyes and bleaches that are suitable for washing machines.
- Follow the manufacturer's instructions.
- Plastic and rubber parts of the washing machine can be stained by dyes or bleaches.

## LOADING THE LAUNDRY

1. Open the door.
2. Unfold the laundry and place it loosely in the drum. Observe the load sizes given in the quick reference guide.  
**Note:** Overloading the machine reduces the wash efficiency and encourages creasing.
3. Close the door.

# DETERGENTS AND ADDITIVES

## Keep detergents and additives in a dry place out of the reach of children.

### The type of detergent depends on:

- type of fabric (cottons, easy care/synthetics, delicate items, wool).  
**Note:** Use only specific detergents for wool.
- Colour.
- washing temperature.
- Degree and type of soiling.

### Remarks:

- Whitish residues on dark fabrics are due to the insoluble water softeners in modern phosphate-free detergents. If you notice this problem, shake or brush the affected items or use a liquid detergent.
- Use only detergents and additives specifically produced for domestic washing machines.
- When using descaling agents, dyes or bleaches for the pre-wash, make sure that they are suitable for use in domestic washing machines. Descalers could contain products which could damage your washing machine.
- Do not use any solvents (e.g. turpentine, benzene). Do not wash fabrics in the machine which have been treated with solvents or flammable liquids.
- Do not use liquid detergent for the main wash when having activated the "prewash" option (if available on your model).
- Do not use liquid detergents when activating the "Start Delay" function (if available on your washing machine).

## Dosage

Follow the dosage recommendations on the detergent pack. They depend on:

- Degree and type of soiling
- size of wash full load: follow the detergent manufacturer's instructions;  
half load: 3/4 the amount used for a full load;  
minimum load (about 1 kg):  
1/2 the dose recommended for a full load
- water hardness in your area (request information from the water company). Soft water requires less detergent than hard water (refer to the water hardness table in the operating instructions).

### Note:

Too much detergent can result in excess foam formation, which reduces washing efficiency. If the washing machine detects too much foam, it may prevent spinning. Insufficient detergent may result in grey laundry in time and also calcifies the heating system, drum and hoses.

## Pouring in the detergents and additives

The detergent drawer has three chambers (fig. "A").

### Prewash Chamber

- Detergent for the prewash

### Main Wash Chamber

- Detergent for the main wash
- Stain remover
- Water softener

### Softener Chamber

- Fabric Softener
- Liquid starch

Pour additives only up to the "MAX" mark".

### Using bleach

- Wash your laundry with the desired programme (Cotton, Synthetics), adding an appropriate amount of bleach to the SOFTENER chamber (close the detergent dispenser carefully)
- Immediately after the end of the programme, start the "Rinse and Spin" programme to eliminate any residual bleach smell; if you want, you can add softener. Never put both chlorine bleach and softener into the softener chamber at the same time.

### Using starch

- Select the "Rinse and Spin" programme and check that the spin speed is set to not more than 800 rpm.
- Start the programme, pull out the detergent dispenser so that you can see approximately 3 cm of the softener chamber.
- Pour the starch solution prepared into the softener chamber while the water is running into the detergent dispenser.

### Position the liquid detergent separator in the main wash chamber.

When you use a liquid detergent (recommended for non pre-wash programmes), position the separator in the main wash chamber  on the guides so that it touches the bottom of the chamber then pour in the detergent until it reaches the full mark.

**Remember to remove the separator when you use a powder detergent.**

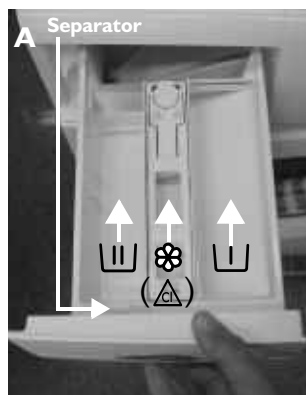

**Type 1 basin**

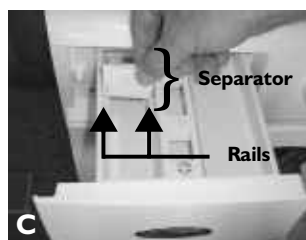

**C**

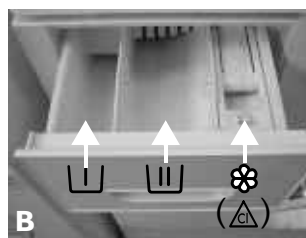

**B**

**Type 2 basin**

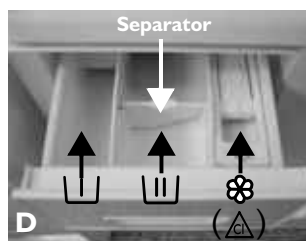

**D**

# REMOVING THE FILTER/DRAINING RESIDUAL WATER

We recommend that you check and clean the filter regularly, at least two or three times a year.

## Especially:

- If the appliance does not drain correctly or if single spin cycles do not take place.

- If the “Clean filter” indication lights up:

**IMPORTANT: make sure the water has cooled before draining the appliance.**

1. Switch off the appliance and unplug it.
2. Remove the plinth or open the cover (depending on the model) by using the separator of the detergent dispenser (fig. **A** / **B**).
3. Place a bowl beneath the filter. If the filter is located behind the plinth (see pictures “**A**” e “**C**”), use a wide and very flat container with a maximum height of 2 cm.
4. Open the filter but do not remove it completely. Slowly turn the filter counterclockwise (fig. **C**) until the water begins to drain out.
5. Wait until all the water has drained.
6. Now unscrew the filter completely and extract it.
7. Tilt the appliance forwards carefully to allow the water to flow out.
8. Clean the filter and the filter chamber.
9. Check that the pump impeller can still rotate.
10. Re-insert the filter and screw it in clockwise as far as it will go.
11. Pour about 1 l of water into the detergent dispenser to reactivate the ecosystem”. Check that the filter is inserted properly and securely.
12. Reinstall the plinth or the cover, depending on the model.
13. Plug in the appliance again.
14. Select a programme and start it.



# CARE AND MAINTENANCE

## Appliance exterior and control panel

- Can be washed down with a soft, damp cloth.
- A little neutral detergent (non abrasive) can also be used
- Dry with a soft cloth.

## Appliance internal parts

- After each wash, leave the door open for some time to allow the inside of the appliance to dry.
- If you never or seldom wash your laundry at 90°C, we recommend to occasionally run a 90°C programme without laundry, adding a small amount of detergent, to keep the interior of the appliance clean.

## Door seal

- Clean with a damp cloth when necessary.
- Check the condition of the door seal regularly.

## Filter

- Check and clean the filter regularly, at least two or three times a year (see “Removing the filter / Draining residual water”)

## Water supply hose

- Check the hose regularly for brittleness and cracks.
- Regularly check and clean the mesh filter inside the inlet hose (see “Cleaning the mesh filter in the water supply hose(s)”).

## Do not use flammable fluids for cleaning the appliance.

### Detergent drawer

**Clean the detergent dispenser regularly, at least three or four times a year to prevent a build-up of detergent.**

1. Press “PUSH” and extract the dispenser drawer.
2. Remove the cover grid from the fabric softener compartment. Remove the separator from the main wash compartment by pulling it upwards (see dark arrows).
3. Wash all the parts under running water.
4. Clean detergent from the dispenser with a damp cloth.
5. Refit the separator and the cover grid in the detergent dispenser and fit the dispenser back inside its housing.

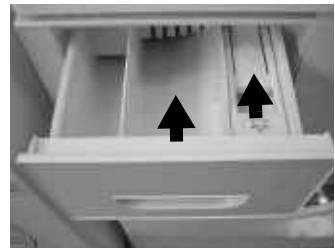
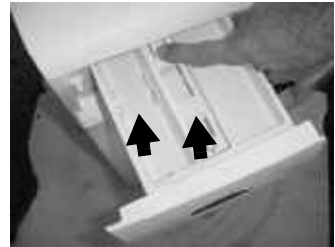

### Inlet hose

If a supply hose shows a damage, replace it by a new hose of the same type, available through our After-Sales Service or your specialist dealer.  
Contact our After-Sales Service team or specialist dealer to obtain a replacement hose.

### Cleaning the mesh filter in the water supply hose(s)

1. Close the tap and loosen the inlet hose on the tap.
2. Clean the internal mesh filter and screw the water inlet hose back onto the tap.
3. Now unscrew the inlet hose on the rear of the washing machine.
4. Pull off the mesh filter from the washing machine connection with universal pliers and clean it.
5. Refit the mesh filter and screw the inlet hose on again.
6. Turn on the tap and check that the connections are water-tight.







# TROUBLESHOOTING GUIDE

The appliance is fitted with automatic safety functions that detect faults at an early stage and allow the safety system to react appropriately. These faults are frequently so minor that they can be dealt with a few minutes.

Problem	Causes, Solutions, Suggestions
<b>The machine will not turn on and no lamps are lit</b>	<ul style="list-style-type: none"> <li>• The plug has not been properly inserted in the socket.</li> <li>• The socket or fuse is faulty (use another lamp or electrical device to test the socket).</li> <li>• The “On/Off” switch (if present) has not been pressed.</li> </ul>
<b>The machine will not start even though the “Start” button has been pressed</b>	<ul style="list-style-type: none"> <li>• The door has not been closed correctly.</li> </ul>
<b>The machine stops during the programme and the “Start” light flashes</b>	<ul style="list-style-type: none"> <li>• The “Rinse Hold” function (if present) is turned on and the Anticrease light  goes on in the programme sequence indicator; terminate “Rinse Hold” by pressing the “Start” button or by choosing and starting the “Drain” programme.</li> <li>• the programme has been changed: select the new programme and press “Start”.</li> <li>• The programme has been interrupted and the door opened: close the door and re-start the programme by pressing “Start”.</li> <li>• The appliance’s safety system has been activated (see “Description of red indications”).</li> <li>• The water tap is not open or the water inlet hose is kinked (“Water tap closed” indication lights up).</li> </ul>
<b>The dispenser contains detergent and/or additive residue</b>	<ul style="list-style-type: none"> <li>• The separator in the main wash chamber has not been correctly fitted or is not suitable for the use of powder and liquid detergents (see “Detergents and additives”).</li> <li>• The water level is insufficient; the mesh filters of the water supply may be blocked (see “Care and maintenance”).</li> </ul>
<b>The washing machine vibrates during the spin cycle</b>	<ul style="list-style-type: none"> <li>• The transport bolts have not been removed; <b>Before using the machine, it is imperative that the transport bolts are removed.</b></li> <li>• The appliance is not level/not standing firmly on all four feet (see separate “Installation Guide”).</li> </ul>
<b>Final spin results are poor</b>	<p>The washing machine has an imbalance detection and correction system. If individual heavy items are loaded (e.g. bathrobes), this system may reduce the spin speed automatically or even interrupt the cycle in order to protect the washing machine .</p> <ul style="list-style-type: none"> <li>• Heavy items may prevent the spin cycle from being carried out; add small items and repeat the spin cycle.</li> <li>• The excessive formation of foam may prevent the spin cycle from being carried out; select and start the “Rinse &amp; Spin” programme. Avoid using excessive amounts of detergent (see “Detergents and additives”).</li> <li>• The “Variable Spin” button (if present) has been set to a low spin speed or the “No Spin” option (if present) has been activated.</li> </ul>
<b>The programme time initially shown on the display can be lengthened/shortened by a given amount of time (only on appliances with a display indicating remaining programme time)</b>	<p>It is normal for the washing machine to adjust to factors that might affect the duration of the wash cycle, e.g. the excessive formation of foam, an unbalanced load of very heavy items or extended heating time due to a low water temperature.</p> <p>For reasons like these, the wash time is recalculated and up-dated if necessary. <b>On some displays (depending on the model), an animation appears during such update periods.</b></p>

### Description of red indications

The red light will go on (if fitted to the appliance)	Alphanumeric indications shown on the display (on models fitted with them)	Description Cause Solutions
<p>“Water Tap Closed” </p>	E00	<p>The appliance has insufficient or no water supply. The <b>“Start”</b> light goes on. Check that:</p> <ul style="list-style-type: none"> <li>• The water tap is fully open and the water pressure is sufficient.</li> <li>• The water supply hose is kinked.</li> <li>• the mesh filters of the water supply could be blocked (see “Care and maintenance”).</li> <li>• The water hose is frozen up.</li> </ul> <p>When the problem has been resolved, re-start the programme by pressing the <b>“Start”</b> button. If the fault occurs again, contact the After-Sales Service [see next chapter].</p>
<p>“Clean Pump” </p>	E01	<p>The water is not pumped out of the washing machine. The appliance stops in mid programme; unplug the appliance and check if:</p> <ul style="list-style-type: none"> <li>• there are kinks in the drain hose.</li> <li>• the filter or pump is blocked (see chapter “Removing The Filter/Draining Residual Water”; <b>make sure the water has cooled before draining the appliance</b>).</li> <li>• the water in the water inlet hose is frozen.</li> </ul> <p>When you have resolved the problem, turn the programme selector to “Off/O” to reset the appliance; next re-start the desired programme. If the fault occurs again, contact the After-Sales Service [see next chapter].</p>
<p>“Service” </p> <p>Door locking error </p>	<p>E02 E03 “Fod” E04</p>	<p>“Electrical module fault”</p> <p>Unplug the appliance and turn the programme selector to <b>“Off/O”</b>, then turn the appliance ON again. Select the “Drain/Spin” programme and re-start within 15 seconds.</p> <p>Turn the appliance OFF by turning the programme selector to <b>“Off/O”</b>; Open and close the door again with more force then reselect the programme and press <b>“Start”</b>.</p> <p>If any of the faults described above persists, unplug the appliance, turn off the water supply and contact our After-Sales Service (see next chapter).</p>



# AFTER-SALES SERVICE

Before contacting After-Sales Service:

1. Try to remedy the problem yourself (see "Troubleshooting Guide").
2. Restart the programme to check whether the problem has solved itself.
3. If the washing machine continues to function incorrectly, call After Sales Service.

Specify:

- The nature of the problem.
- The washing machine model.
- The service code (number after the word SERVICE )

**SERVICE** 0000 000 00000



The After Sales Service sticker can be found inside the door.

- Your full address.
  - Your telephone number and area code.
- After-Sales Service phone numbers and addresses are given on the guarantee card. Alternatively, consult the dealer where you purchased the appliance.

## ACCESSORIES

Some models are able to be installed under your kitchen worktop; in that case, please contact our After-Sales Service (see above). Attention:

- the appliance **MUST** be installed under a continuous worktop.
- according to the legal safety regulations, the installation of the appliance **MUST** be carried out by an authorized technician or by our After-Sales Service.
- the appliance **MUST** be installed using the intermediate cover panel of the UBS Base Set which can be purchased from specialist dealers or our After-Sales Service.

# BUILT-IN MODELS

## INSTALLATION TIPS

Washer dryer housing dimensions:

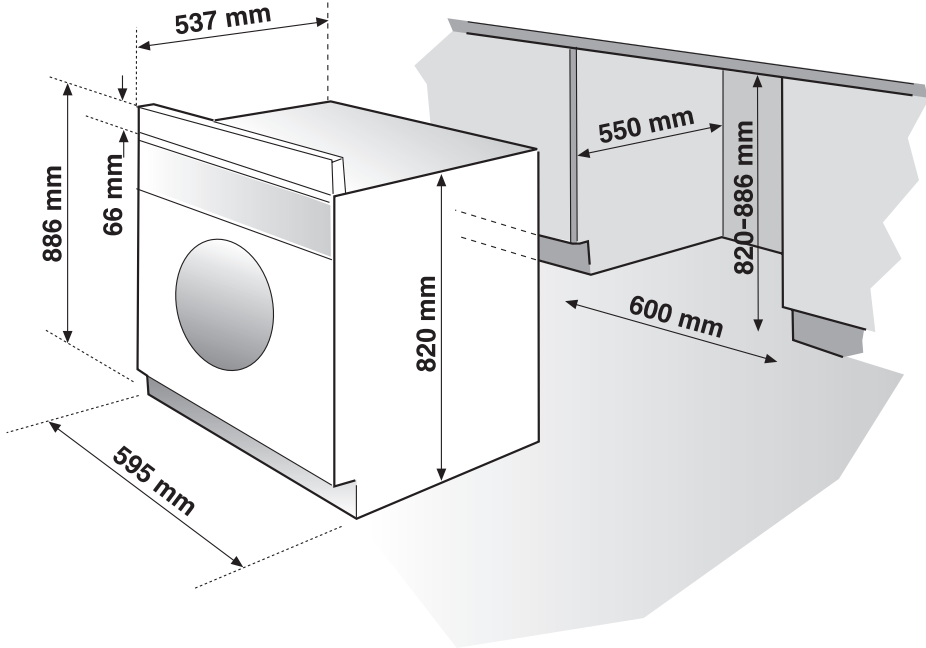

- Due to the need for the washer dryer filter to be cleaned periodically the plinth should be easily removable.
- For easy care and maintenance water supply and drain should not be positioned behind the appliance.
- The electrical connections should be positioned so that the appliance can be disconnected when fitted in position.

## FITTING A DÉCOR DOOR TO THE APPLIANCE

The appliance front part has been fitted to accommodate the hinges so that the door can be opened either from the left or from the right hand side.

Proceed as follows:

1. Screw the hinges onto the décor door, if a dummy drawer front is also being used ensure it to be fastened to the top edge of the door. Ensure the gap between door and drawer matches the units either side.
2. Fix the two hinge plates to the front of the washer dryer using the two plastic backing pieces.  
**Note:** an 8mm box spanner can be used to screw the thread cutting screws into position.
3. Fasten the two magnetic catches to the opposite side to the hinges and ensure the metal straps are fastened to the back of the door.
4. Locate the hinges on the door into the two hinge plates on the appliance.
5. If adjustment is necessary this can be achieved by either the hinge plates (vertical) or by the hinge fixing screws (horizontal).

## FITTING A FULL HEIGHT DOOR

If a full height door is to be fitted (no dummy drawer front is being used) a top hinge hole has to be drilled in the door.

The distance between the two hinge hole centres is 360 - 384mm and the distance from the edge of the door is 21.5mm.

The hinge hole should be max 12mm deep and its diameter 35mm: make sure you do not drill through the door.

The two fixing holes for the hinge screws are 2mm.

## DÉCOR STRIP

A décor strip can be screwed into position on the edge of the washer dryer. If needed, the strip can be cut to be adjusted to your furniture but normally this will not be necessary.

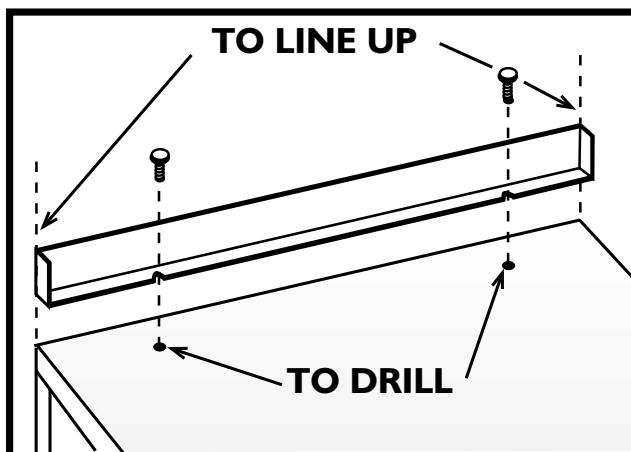

# 目錄

使用洗衣機前

注意事項及綜合建議

安裝

洗衣機圖解

機門

初次洗衣

洗衣準備

洗衣劑和添加劑

拆除過濾器/排走積水

保養和維修

故障排除指引

售後服務

配件

嵌入式型號

# 使用洗衣機前

## 1. 拆除包裝並檢查

- 拆除包裝後，確認洗衣機無損。如有疑問，請勿使用洗衣機，並聯絡售後服務中心或當地經銷商。
- 確定所有附件和提供的配件齊全。
- 包裝材料（塑膠袋、聚苯乙烯部件等）可能會對兒童造成危險，應存放在兒童無法觸及的地方。
- 若洗衣機在裝運前暴露於冷空氣中，請讓它處於室溫數小時後才開始操作。

## 2. 拆除搬運螺栓

- 本洗衣機配備搬運螺絲，以防搬運時造成洗衣機內部損毀。使用洗衣機前，請務必拆除搬運螺栓。
- 拆除螺栓之後，請用4個塑膠帽蓋封蓋開口。

## 3. 安裝洗衣機

- 請勿將洗衣機安裝在可能降至 0°C 以下的房間。
- 考慮到洗衣機的重量，移動洗衣機前必須留意安全標準。
- 放置洗衣機時，注意電線不應有扭結或擠壓，並應在需要時能容易取出。
- 拆除控制面板上的保護膠薄膜（視乎機型而定）。
- 移動洗衣機時不要提拉其頂板。
- 將洗衣機安裝於堅固平穩的地面上，最好是室內的角落。
- 確定所有的四個機腳穩固置於地板上，然後檢查洗衣機完全水平（使用水平儀測量）。
- 若是木製地板或稱為“浮動地板”（例如，某些鑲木地板或薄板覆蓋的地板）上，請將洗衣機放置在緊壓於地板和厚度至少 3 厘米的60 x 60 之夾板上。

## 4. 水源

- 根據當地供水機構的規定連接進水軟管。
- 水源：  
只可用冷水（若您的程序圖表上未提供其他資訊）
- 水龍頭：  
3/4 英寸螺紋供水軟管接頭

- 水壓（水流壓力）：  
100-1000 kPa (1-10 bar)。
- 只可使用新的軟管將洗衣機連接到水源。請勿使用舊的軟管，且應將它丟棄。

## 5. 排水

- 將排水軟管連接到虹吸管上或利用提供的“U”形管托將它掛在洗滌槽邊緣。
- 如果洗衣機連接內嵌排水系統，確保此系統配備排水口，以免同時進水及排水（虹吸效果）。

## 6. 電源連接

- 電源連接必須由持牌技工遵循製造廠商指示和現行的標準安全法規執行。
- 關於電壓、電源消耗及保險絲要求的資料在機門內標明。
- 本洗衣機必須透過接地符合現行法規的插座來連接電源。本機必須依法連接接地線。若因不遵循上述指示而導致任何的財產損失或對人身或動物造成傷害，製造廠商將不負任何責任。
- 切勿使用拖板或萬能插頭。
- 保養洗衣機前，必須先拔下電源插頭。
- 安裝後必須確保能隨時透過雙極開關接觸電源插頭或切斷電源。
- 若洗衣機在搬運期間受損，則請勿使用。請通知售後服務中心。
- 電線只能由售後服務中心更換。
- 本洗衣機僅適用於家用洗衣和所既定的用途。

## 最小外殼規格：

- 闊： 600 毫米
- 高： 850 毫米
- 深： 600 毫米

# 注意事項及綜合建議

## 1. 包裝

- 正如循環標記  所示，包裝箱可被完全循環再用。丟棄包裝材料時要遵循本地規定。

## 2. 處置包裝材料和廢棄舊洗衣機

- 洗衣機由可回收再用的材料製成，處置時必須遵循本地的廢物處置現行規定。
- 廢棄洗衣機前，請先清除殘餘的洗衣劑、搗破門勾並將電源線切除，令洗衣機不可使用。
- 本產品是根據電器廢物和電子器材 (WEEE) 的歐盟指令 2002/96/EC 所標記。

如能確保本產品適當棄置，可對環境及人體健康，減低不良的影響。若將本產品不適當棄置，便會對環境造成不良後果。

產品或產品隨附文件上的  圖標，表示不能將本洗衣機當作家居廢物處理。它必須運送到特別的收集中心，作為電器及電子器材的循環再用。用戶必須根據本地的廢物棄置條例處理本產品。如希望知道本產品的處理、再用、回收等詳情，請聯絡本地的辦事處、家居廢物棄置服務中心或向所購買的店鋪查詢。。

## 3. 安全指示

- 本機只適合室內使用。
- 請勿在本機附近儲存易燃液體。
- 若您要在洗衣機上面放置乾衣機，請先聯絡本公司的售後服務中心或您的專業經銷商瞭解是否可行。要在洗衣機上面放置乾衣機，只可使用本公司的售後服務中心或您的專業經銷商提供的適當堆疊工具。
- 不使用本機時，請勿連接電源。
- 不使用本機時，請關上水龍頭。
- 清潔或保養本機之前，請關機或拔下電源插頭。
- 請勿強行打開機門或將它當作台階使用。
- 切勿讓兒童玩弄洗衣機或爬入洗衣機內玩。
- 如有必要，電源線可使用本公司的售

後服務中心所提供的同類型電源線來更換。電源線必須由持牌技工進行更換。

## 洗衣乾衣機型號

- 用化學去污劑、食油、石油、丙酮、酒精、汽油、石蠟、石油溶劑油或蠟洗過或處理過的衣物，切勿烘乾。乾衣前先用熱水及大量的洗衣液清洗上述物質。
- 切勿烘乾用泡沫橡膠、乳膠、雨衣、防水布料、橡膠空氣床、印花衣物、泡沫橡膠製的衣服或枕頭。這些物質會溶解及損壞一同清洗的衣物或損害洗衣機。

## 4. 省電提示

- 使用本機建議的最大洗衣量，將可最有效利用能源、供水、洗衣劑和時間。
- 請勿使用超出洗衣劑包裝上標明的建議用量。
- 本機排水口配備的特殊系統“Eco-Flap”可防止洗衣槽內的洗衣劑流失，從而避免洗衣劑污染環境。
- “預洗”程序只用於洗滌非常髒的衣物。洗滌輕微或一般骯髒程度的衣服時，不要選擇“預洗”程序，以節省水、能源和時間的消耗。
- 洗滌前，用去污劑預先處理污漬，或將乾了的污漬浸泡在水中，可減少熱洗程序的需要。
- 使用 60°C 取代 95°C 的洗衣程序或 40°C 取代 60°C 的洗衣程序將可節省能源。
- 使用滾筒乾衣機（可調整轉速的機型）前，選擇高速脫水轉速以減少衣物的水份含量，將可節省能源和時間。

## 5. 符合 EC 聲明

- 本機符合下列歐洲標準：  
73/23/EEC 低電壓指示  
89/336/EEC 電磁相容性指示  
93/68/EC CE 標記指示



# 安裝

## 移除搬運螺栓

1. 鬆開三或四顆螺栓(A)。
2. 用手轉鬆螺栓。
3. 取出螺栓及塑膠間隔物。保存搬運螺栓以供日後使用。
4. 用塑膠蓋（與文件一併提供）將開口處蓋緊。

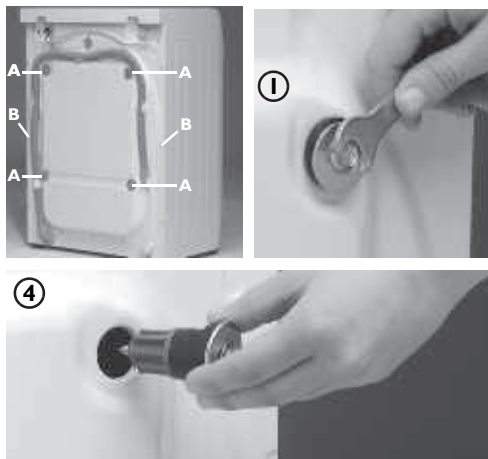

# 搬運/處理

## 搬運時，切勿提拉洗衣機的頂板。

1. 拔下電源插頭。
2. 關閉水龍頭。
3. 檢查並確定機門和洗衣劑格都已正確關閉。
4. 拆除進水和排水軟管。
5. 排出軟管和洗衣機內的所有積水（請參閱"拆除過濾器/排出積水"）。
6. 用螺絲起子撬開並移除塑膠蓋。
7. 按移除搬運螺栓的相反步驟，安裝搬運螺栓。

## 洗衣機圖解

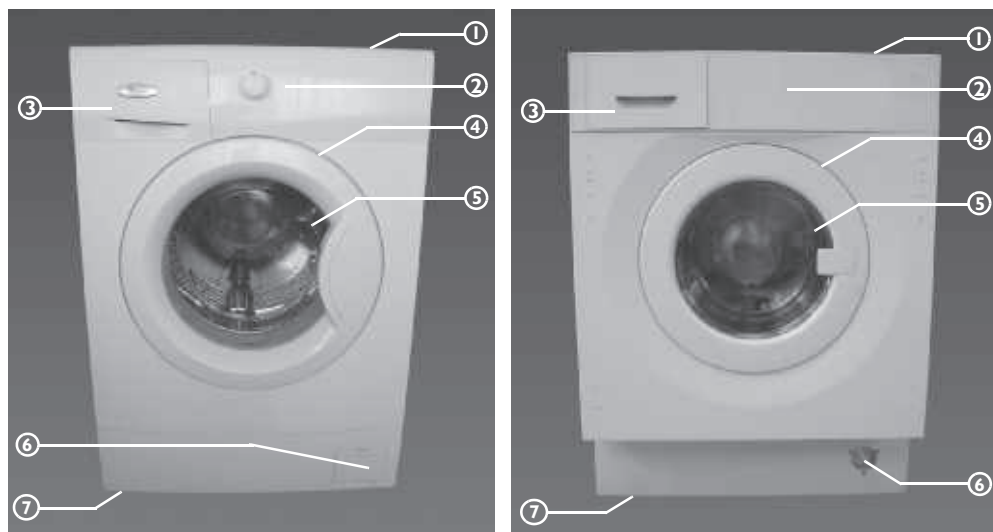

- 1.頂板
- 2.控制面板
- 3.洗衣劑格
- 4.維修服務銘牌（在機門內）
- 5.機門
- 6.位於底座或護蓋後之泵通道（視乎機型而定）
- 7.可調校高度之機腳

## 機門

如需打開機門，必須手握門柄，然後按下門內門柄再拉開機門。如須關閉機門，只須輕力按下直至聽到咔嗒聲。

## 初次洗衣

我們建議初次洗衣時，空機進行短周期洗衣程序，這將可清除製造商測試洗衣機時所遺留的積水。

1. 打開水龍頭。
2. 關閉機門。
3. 將少量洗衣劑（約30毫升）倒入洗衣劑格的主洗室內。 
4. 選擇並開始一個較短的洗衣程序（請參閱快速參考指南）。



# 洗衣準備

## 1. 請依下列方式將衣物分類...

- **衣料類型/護理標籤符號**  
包括棉質、混紡、免燙/合成纖維、羊毛及手洗衣物。
  - **顏色**  
請將白色衣物與顏色衣物分開，並將簇新的顏色衣物分開清洗。
  - **放入衣物**  
不同大小的衣物放在一起清洗時，可改善洗衣及脫水的效率，並可使衣物在洗衣鼓內的分佈更為均勻。
  - **纖幼衣物**  
在洗滌尼龍襪、腰帶等小物件或如胸圍等帶勾扣的衣物時，請放入洗衣袋或有拉鏈的枕頭套內清洗。清洗窗簾時，務必將掛勾取下或以棉袋套起來清洗。
- ## 2. 清空所有的衣物口袋
- 銀幣、別針等物品會損害衣物、洗衣鼓及洗衣桶。
- ## 3. 將衣物扣好、繫緊
- 在洗衣前請將衣物的拉鏈拉上、扣好勾子或扣子，並將鬆開的腰帶或絲帶繫在一起。

# 洗衣劑和添加劑

請將洗衣劑和添加劑存放在乾燥和兒童無法觸及之處。

洗衣劑的選擇將取決於：

- 衣物質料（棉質、免燙/合成纖維、纖幼衣物、羊毛衣物）。

**注意：**清洗羊毛衣物時，必須使用專用之洗衣劑。

- 顏色
- 洗衣溫度
- 骯髒程度及類別

**備註：**

- 目前，不含磷酸鹽的洗衣劑內含非水溶性柔軟劑，可能會令深色衣物上留下白色的洗衣粉殘漬。如遇上述情況時，應輕輕拍動或刷掉附於衣物上的殘漬，或改用洗衣液。
- 請只使用專為家用洗衣劑生產的洗衣劑和添加劑。
- 在"預洗"中使用除水垢劑、染料或漂白劑時，必須確定其適用於家用洗衣機。除水垢劑所含成分可損毀您的洗衣機。
- 切勿使用任何溶劑（如松節油、汽油等）。切勿用洗衣機清洗曾經浸泡過

## 污漬清除

- 由血漬、牛奶、雞蛋及其他有機物所留下的污漬，一般而言，可在酵素的作用下自然分解。
- 若要清除紅酒、咖啡、茶、草或水果等所留下的污漬，請在洗衣劑格的主洗室  內加入去污劑。
- 如有必要，可在洗衣前先去污劑預先處理頑強污漬。

## 染色及漂白

- 請只使用適用於洗衣機的染色和漂白劑。
- 遵循製造廠商的指示進行。
- 本機的塑膠及橡膠部件可能會被染色劑或漂白劑染污。

## 放入衣物

1. 打開機門。
2. 將衣物揚鬆並逐件放入洗衣槽內，切勿過量裝入。遵循快速參考指南中提供的洗衣量。

**注意：**裝入過量衣物將降低洗衣效率並使衣物起皺。

3. 關閉機門。

溶劑或易燃液體的衣物。

- 在啓動"預洗"（若您的機型配備此選項）時，切勿在主洗中使用洗衣液。
- 在啓動"預校開機時間"（若您的洗衣機配備此功能）時，切勿使用洗衣液。

## 用量

請依照洗衣劑包裝上的用量建議。它取決於：

- 骯髒程度及類別
- 衣物數量

足量：請按照洗衣劑製造廠商的建議量；

半量：足量的3/4；

最少洗衣量（約 1 公斤）：足量的1/2。

- 您所處地區的水質硬度（請參考供水單位所提供的資訊）。軟水質所需的洗衣劑用量較硬水質少（請參閱操作指示中的水質硬度表）。

**注意：**

過量的洗衣劑會造成泡沫過多，並且降低洗衣效率。若洗衣機偵測到泡沫過多，將會阻止脫水。若洗衣劑用量不足，衣物則無法洗淨，同時亦會在電熱元件、洗衣鼓及軟管上留下水垢。

## 注入洗衣劑和添加劑

洗衣劑格具備三格（圖"A"）。

### 預洗室

- 用於預洗的洗衣劑

### 主洗室

- 用於主洗的洗衣劑
- 去污劑
- 軟水劑

### 柔順劑格

- 衣物柔順劑
- 漿衣液

注入添加劑時不可超過"MAX" 標記。

### 使用漂白劑

- 在所需程序（棉質、合成纖維）中洗滌您的衣物，在柔順劑格中加入適量的氯漂白劑（小心關上洗衣劑格）。
  - 程序結束時立即啟動“過水及脫水”程序以消除任何殘留的漂白劑氣味；若需要，您可以添加柔順劑。
- 切勿同時將氯漂白劑和柔順劑放入柔順劑格。

### 使用漿衣液

- 選擇“過水及脫水”程序，檢查轉速是否設定為不超過 800轉/分。
- 啟動程序，將洗衣劑格拉出直到您可以看到約 3 厘米的柔順劑格。
- 在水注入洗衣劑格時將漿衣液倒入柔順劑格。

### 於主洗室內把洗衣粉和洗衣劑的分隔器定位

使用洗衣液時（建議用於非預洗程序），將分隔器放在主洗室  內的導軌上，使分隔器碰觸主洗室的底部，然後注入洗衣液至注滿標記。緊記在使用洗衣粉時移走分隔器。

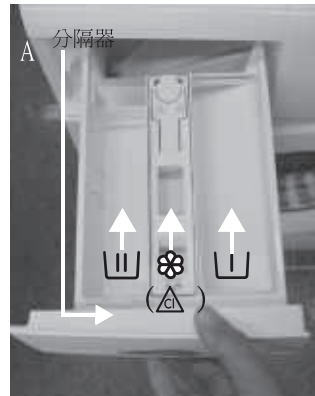

第一類洗衣劑格

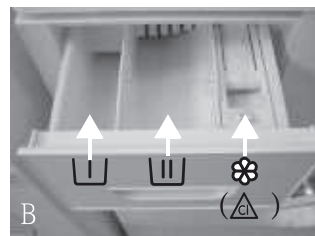

第二類洗衣劑格

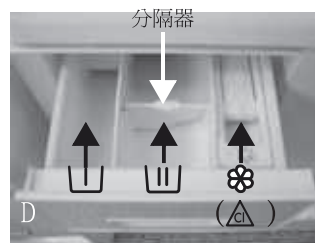

## 拆除過濾器/排出積水

建議您每年至少定期檢查和清潔過濾器兩至三次。

**特別是發生以下情況時：**

- 洗衣機無法正常排水或不能進行脫水週期。
- 若"清潔過濾器"指示燈亮起：

**重要資訊：洗衣機排水前請確保水已冷卻。**

1. 關閉洗衣機並拔下電源插頭。
2. 使用洗衣劑格的分隔器（圖 "A" / "B"）來拆除底座或撬開過濾器外蓋（視乎機型而定）。
3. 在過濾器下放一個碗。若您的洗衣機的過濾器位於底座後方（請參閱圖片"A"和"C"），請使用寬闊和非常扁平而高度不超過 2 厘米的容器。
4. 打開過濾器但不要將它完全拉出。慢慢地將過濾器逆時針旋轉（圖 "C"），直到開始排水。
5. 等待所有的水完全排出。
6. 現在將過濾器完全旋鬆並拉出。
7. 小心地向前傾斜洗衣機讓水流出。
8. 清潔過濾器和過濾器室。
9. 檢查排水泵葉輪轉動是否順暢。
10. 將過濾器塞回原位，然後按順時針方向旋緊到最深位置。
11. 將大約一公升清水倒入洗衣劑格，重新啟動" 慳電系統" (eco system)。確定過濾器安裝正確並穩固到位。
12. 視乎機型而定，裝回底座或護蓋。
13. 將電源插頭重新插入插座。
14. 選擇一個程序並啟動。

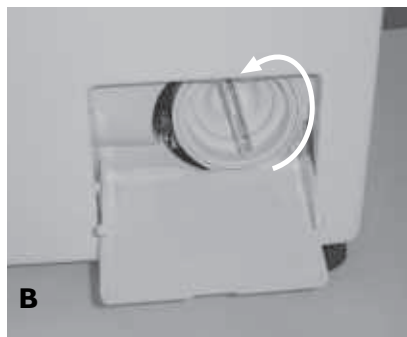

# 保養和維修

## 洗衣機外部和控制面板

- 可使用柔軟濕布清洗。
- 也可使用少許中性清潔劑（不具研磨性質）。
- 用軟布抹乾。

## 洗衣機內部

- 每次洗衣之後，讓機門打開一段時間使洗衣機內部變乾。
- 若您從不或很少採用 90° C 洗衣，我們建議您偶爾使用 90° C 程序空機和加入少量洗衣劑清洗，以保持洗衣機內部清潔。

## 門膠圈

- 必要時以濕布清潔。
- 定期檢查門膠圈的狀況。

## 過濾器

- 每年至少定期檢查和清潔過濾器兩至三次（請參閱" 拆除過濾器/ 排出積水"）。

## 進水軟管

- 定期檢查軟管是否脆弱和出現裂縫。
- 定期檢查和清潔進水軟管內的濾網（請參閱" 清潔進水軟管內的濾網"）。

請勿使用易燃液體來清潔洗衣機。

### 洗衣劑格

每年至少定期清潔洗衣劑格三或四次，以防止洗衣劑積聚。

1. 按下"推"，將洗衣劑抽屜取出。
2. 拆下柔順劑格的蓋子格柵。將主洗室內的分隔器向上拉將其取出（請查看黑色箭頭）。
3. 在水龍頭下沖洗所有的部件。
4. 用濕布清潔洗衣劑隔間的洗衣劑。
5. 重新將蓋子格柵和分隔器裝回洗衣劑格並將洗衣劑格插回底座中。

### 進水軟管

若進水軟管出現損毀跡象，請用本公司的售後服務中心或您的專業經銷商提供的相同類型新軟管進行更換。

請聯絡本公司的售後服務中心或專業經銷商更換進水軟管。

### 清潔進水軟管內的濾網

1. 關掉水龍頭並從水龍頭上鬆開進水軟管。
2. 清潔管內的濾網並將進水軟管擰回水龍頭。
3. 拆下洗衣機後方的進水軟管。
4. 用鉗子將濾網從洗衣機連接上拆下並加以清潔。
5. 裝回濾網並將進水軟管擰回機上。
6. 打開水龍頭並確認各連接位均完全不漏水。

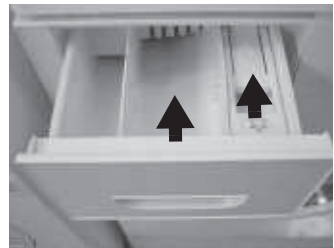
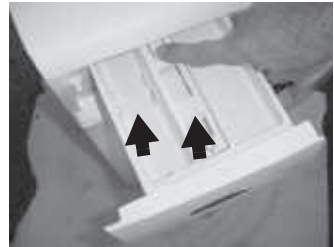





# 故障排除指引

您的洗衣機配備各種自動安全功能。這將能更快地偵測故障並適時啓動安全系統。這些常有的小問題可在數分鐘內獲得解決。

問題	原因、解決方法、提示
洗衣機無法開動，指示燈沒有亮起。	<ul style="list-style-type: none"> <li>• 插頭未正確插入插座。</li> <li>• 電源插座或保險絲未正常操作（可使用檯燈或類似器具測試）</li> <li>• 未按下"開關"按鈕（若您的機型配備此按鈕）。</li> </ul>
雖然已按下"開始/暫停"，但洗衣機無法開動	<ul style="list-style-type: none"> <li>• 機門未正確關閉（另請參閱"兒童安全"）。</li> </ul>
洗衣機在程序運行期間停止，而且"開始/暫停"指示燈閃爍	<ul style="list-style-type: none"> <li>• 已啓動"延遲脫水"選項（若您的機型配備此選項）並且☐（防皺）在程序順序指示燈中亮起 - 按下"開始/暫停"或選擇並啓動"排水"程序以終止"延遲脫水"。</li> <li>• 程序已更改 - 重新選擇所需程序並按下"開始/暫停"。</li> <li>• 程序被中斷且最終打開機門 - 關閉機門並按下"開始/暫停"重新啓動程序。</li> <li>• 已啓動洗衣機的安全系統（請參閱"紅色指示燈說明"）。</li> <li>• 水龍頭未打開或進水軟管扭結（"水龍頭關閉"指示燈亮起）。</li> </ul>
洗衣劑和/或添加劑殘留在洗衣劑格內	<ul style="list-style-type: none"> <li>• 主洗格室的分隔器未正確安裝或不適合使用洗衣粉或洗衣劑（請參閱"洗衣劑和添加劑"）。</li> <li>• 進水不足；供水軟管內的濾網可能阻塞（請參閱"保養和維修"）。</li> </ul>
脫水時機身震動	<ul style="list-style-type: none"> <li>• 搬運螺絲尚未拆除；<b>使用洗衣機前，請務必拆除搬運螺絲。</b></li> <li>• 洗衣機不水平/未穩固地固定在四個機腳上（請參閱個別的《安裝指南》）。</li> </ul>
最終脫水效果不理想	<p>洗衣機配備衣物失衡檢測及校正系統。若個別放入厚大衣物（如浴衣等），此系統可能會自動降低脫水轉速或甚至會完全中斷脫水操作以保護洗衣機。</p> <ul style="list-style-type: none"> <li>• 厚大衣物會阻止脫水；添加較小件的衣物並重複脫水程序。</li> <li>• 過量的泡沫會阻止脫水；選擇並啓動"過水及脫水"程序。避免使用過量洗衣劑（請參閱"洗衣劑和添加劑"）。</li> <li>• "脫水轉速選擇"按鈕（若您的機型配備此按鈕）被設為低轉速，或已啓動"不脫水"選項（若您的機型配備此選項）。</li> </ul>
最初顯示的程序時間被延長/縮短一段時間（僅適用於配備顯示幕以標示剩餘程序時間的洗衣機）	<p>這是洗衣機適應洗衣程序時間可能受影響的因素之正常情況，例如：泡沫過多、由於衣物過重而失衡、由於降低供水溫度而導致加熱時間延長。</p> <p>由於這些影響，程序時間將會重新計算並在必要時更新。</p> <p><b>在某些螢幕上（視乎機型而定），在這段更新時期，在時間顯示屏會出現動畫圖案。</b></p>

## 紅色指示燈說明

紅色指示燈亮起（若您的洗衣機配備該指示燈）	在螢幕上顯示的字母與數字指示（若您的洗衣機配備該螢幕）	說明、原因、解決方法
"入水喉關閉" 	E00	洗衣機沒有供水或供水不足。"開始/暫停"指示燈閃爍。 請檢查： <ul style="list-style-type: none"> <li>• 水龍頭是否完全打開，水壓是否足夠。</li> <li>• 進水軟管是否扭結。</li> <li>• 進水軟管內的濾網是否阻塞（請參閱"保養和維護"）。</li> <li>• 進水軟管是否結冰。</li> </ul> 問題解決之後，按下"開始/暫停"重新啟動程序。若故障再次出現，請聯絡本公司的售後服務中心（請參閱下一章節）。
"清理過濾器" 	E01	廢水未泵出。洗衣機在相應的步驟中停止；拔下電源插頭並檢查： <ul style="list-style-type: none"> <li>• 排水管是否扭結。</li> <li>• 過濾器或泵是否阻塞（請參閱"拆除過濾器/排出積水"章節，<b>確定洗衣機排水前水已冷卻</b>）。</li> <li>• 排水管是否結冰。</li> </ul> 問題解決之後，將程序選擇器轉到"關閉"位置並重新啟動洗衣機；然後重新啟動所需程序。若故障再次出現，請聯絡本公司的售後服務中心（請參閱下一章節）。
"維修"   "機門關閉錯誤" 	E02 E03  "Fod" E04	"電氣模組故障"  拔下電源插頭，將程序選擇器轉到"關閉/0"位置並重新啟動洗衣機。選擇"排水"程序並於15秒內重新啟動。  關閉洗衣機電源（透過將程序選擇器轉到"關閉"位置）。再次用較大力度開啓並閉上機門，然後重選程序並按下"開始/暫停"。  若上述任何故障仍然存在，請拔下洗衣機的電源插頭、關閉水龍頭，然後聯絡本公司的售後服務部（請參閱下一章節）。

# 售後服務

## 聯絡售後服務中心前，請：

1. 儘量自行解決問題（請參閱"故障排除指引"）。
2. 重新啟動程序，看看問題是否已經解決。
3. 若洗衣機繼續運轉不正常，請致電本公司的售後服務中心。

## 請說明：

- 問題的本質。
- 洗衣機機型。
- 維修編號（在 SERVICE 之後的編號）。

**SERVICE** 0000 000 00000



## 售後服務標籤位於機門內側。

- 您的聯絡地址。
- 您的電話號碼和區域碼。

售後服務中心的電話號碼和地址可在保證卡上找到，或可向您購買洗衣機的經銷商洽詢。

# 配件

某些機型可以安裝在廚房工作台下；在此情況下，請聯絡本公司的售後服務中心（請參閱上文）。請注意：

- 本機必須安裝在連續的工作臺下。
- 根據安全法律規定，本機的安裝必須由授權技術人員或惠而浦的售後服務中心派員安裝。
- 本機的安裝必須使用 UBS 底座套件的間隔蓋板，蓋板可從專業經銷商或本公司的售後服務中心購買。

## 嵌入式型號

### 安裝小貼示 洗衣乾衣機外殼規格

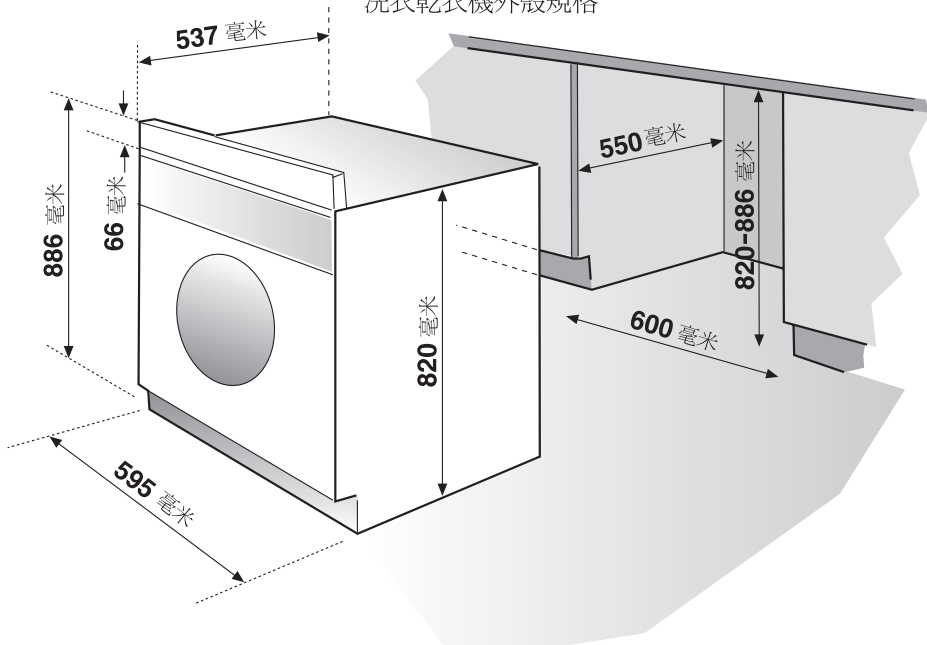

- 洗衣乾衣機的過濾器需要定期清洗，機身底座必須容易移開。
- 進水和去水管不應置於洗衣機後，阻礙維修保養。
- 電力接線應置於適當位置，方便洗衣機嵌入後能截斷電源。



## 安裝洗衣機裝飾機門

洗衣機前方可以裝上門鉸，讓門可以從左或右打開。

安裝步驟：

1. 把門鉸轉上裝飾門，若門上有仿製抽屜，確保抽屜已扣緊門的上方邊緣並確定門及抽屜間的缺口與組件的其中一邊相配。
2. 利用兩片塑膠背板將兩個鉸合板穩固在洗衣乾衣機的前方。

**附註：**可用8毫米套筒扳手將割尾螺絲轉入適當的位置。

3. 在門鉸的相反方向繫緊兩個磁吸，確定金屬帶繫緊在門的背後。
4. 將門上的門鉸置在洗衣機的兩個鉸合板上。
5. 如需調整，可以調教鉸合板（縱向）或門鉸固定螺絲（橫向）。

## 安裝全高式門

若使安裝全高式門（門前沒有仿製抽屜），門上需鑽一個頂部門鉸洞。

兩個門鉸洞中心的相距為360-384毫米，距離門邊緣21.5毫米。

門鉸洞最深為12毫米，直徑為35毫米：請確保沒有鑽穿門身。

兩個門鉸螺絲的固定洞為2毫米。

## 裝飾帶

裝飾帶可轉入洗衣乾衣機邊緣的適當位置。如有需要可裁短裝飾帶以配合傢俱。一般情況並不需要剪裁。

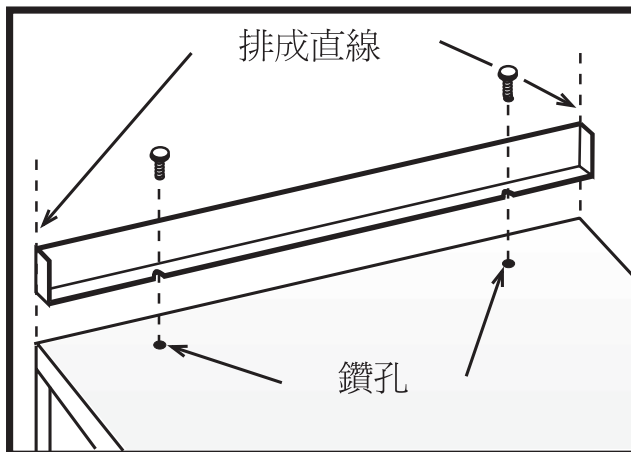



意大利印刷

