



CC450

Digital Camera

User Manual

Table of Contents

Preface	1
About this Manual	1
Safety and Handling Precautions Camera Information	2
Battery Information	2
Important Notes and Information	2
Photography Terms and Definitions	3
Specifications	5
Package Contents	6
Getting Started	7
Attach the Camera Strap	7
Inserting the Batteries	7
Inserting an SD/SDHC Memory Card	8
Camera Memory	8
Camera Views	9
Camera Buttons	11
Navigation Control	11
Turning the Power On and Off	12
Initial Settings	13
Modes Selector Switch	13
Understanding the LCD Screen	14
LCD Screen Layout	14
Changing the LCD Display	20
Recording Photos, Movies and Voices	21
Taking Photos	21
Recording Videos	22
Using the Stabilizer Feature	23
Setting the Zoom Control	23
Using the Flash Features	24
Setting the Focus Mode	25

Using the Function Menu	26
Using the Record Menu	30
Setting the Scene Mode	30
Playback.....	49
Using the Setup Menu	64
Setting Sounds.....	64
Setting Power Save.....	65
Setting LCD Save.....	65
Setting Date & Time.....	65
Setting Language	66
Setting File Numbering	66
Setting TV Out.....	66
Setting LCD Brightness	67
Setting Memory Kit	67
Reset All	68
Making Connections	69
Connecting the Camera to a PC	69
Connecting the Camera to a Printer	71
Setting the Print Mode Menu	71
Appendix	73
About Folder and File Names	73
Troubleshooting	74
Getting Help	75

Preface

About this Manual

This manual is designed to assist you in using your new digital camera. All information presented is as accurate as possible but is subject to change without notice.

For the latest revision, please visit www.hp.com/support.

Copyright

This manual contains proprietary information protected by copyright. All rights are reserved. No part of this manual may be reproduced by any mechanical, electronic or other means, in any form, without prior written permission of the manufacturer. © Copyright 2010

Federal Communications Commission (FCC) Compliance

This equipment has been tested and found to comply with the limits for a Class B digital device, pursuant to Part 15 of the FCC Rules. These limits are designed to provide reasonable protection against harmful interference in a residential installation. This equipment generates, uses, and can radiate radio frequency energy and, if not installed and used in accordance with the instructions, may cause harmful interference to radio communications. However, there is no guarantee that interference will not occur in a particular installation. If this equipment does cause harmful interference to radio or television reception, which can be determined by turning the equipment off and on, the user is encouraged to try to correct the interference by one or more of the following measures:

- Reorient or relocate the receiving antenna.
- Increase the distance between the equipment and the receiver.
- Connect the equipment to an outlet on a circuit different from that to which the receiver is connected.
- Consult the dealer or an experienced radio/TV technician for help.

Declaration of Conformity

This device complies with Part 15 of the FCC rules. Operation is subject to the following conditions:

- This device may not cause harmful interference.
- This device must accept any interference received, including interference that may cause undesired operation.

Trademark Recognition

Windows 2000/XP/Vista/Windows 7 are registered trademarks of Microsoft Corporation in the United States and/or other countries. Macintosh and Mac OS are registered trademarks of Apple Inc. In addition, all other companies or product names are trademarks or registered trademarks of their respective companies.

Safety and Handling Precautions Camera Information



- Do not take apart or attempt to service the camera yourself.
- Do not expose the camera to moisture, or extreme temperatures.
- Allow the camera to warm up when moving from cold to warm temperatures.
- Do not touch the camera lens.
- Do not expose the lens to direct sunlight for extended periods.
- Do not use abrasive chemicals, cleaning solvents or strong detergents to clean the product. Wipe the product with a clean slightly damp soft cloth.

Battery Information

- The HP CC450 camera uses 2 - AA batteries. For optimal performance and battery life, please use photo lithium.
- Turn off the camera before installing or removing the batteries.
- When the camera is used for an extended period of time, it is normal for the camera body to feel warm.
- Do not remove the batteries while downloading pictures, videos, or audio content. This could result in a complete loss of these items.
- It is recommended to remove the batteries if the camera will not be used for a long period of time.
- When inserting the batteries in this camera, ensure that they are oriented correctly. Please see **Inserting the Batteries** section of this manual for additional details. Inserting the batteries incorrectly may cause damage to the camera and batteries.
- An single depleted or low battery power level may cause the lens to not extend or retract properly.
- Dispose of used batteries according to their instructions.

Important Notes and Information

Throughout this manual, look for the symbols below that highlight useful and important information.

	This symbol will be used to indicate useful information when using the camera.
	This symbol will be used to indicate important message that should be read before using the function.

Photography Terms and Definitions

Terms	Definitions
Auto Exposure Bracketing (AEB)	A simple technique professional photographers use to ensure they properly expose their pictures, especially in challenging lighting situations. When AEB is selected, the camera automatically takes three or more shots with a different exposure for each frame.
Auto Focus (AF)	Auto focus refers to a camera lens' ability to adjust its configuration in order to focus properly on a subject regardless of whether it is near or far from the camera. Auto focus lenses generally provide vastly superior image quality than do their fixed focus cousins since they do not have to rely on their depth of field. Also known as: "AF", "auto-focus".
Album	An end-user created object that is used to logically group data objects according to some user-defined criteria. An album may or may not be a physical folder in a file system.
Analog to Digital Converter (A/D or ADC)	A circuit that converts an analog signal, having a continuously varying amplitude, to a digitally quantized representation using binary output signals.
Aspect Ratio	The aspect ratio of a camera is the ratio of the length of the length and width of the display or images.
Auto White Balance (AWB)	With auto white balance, the camera attempts to determine the color temperature of the light and automatically adjust for that color temperature. Many people just leave the camera set to auto white balance all the time.
Charge Coupled Device (CCD)	A type of silicon integrated circuit used to convert light into an electronic signal.
Compression	The process of encoding information using fewer bits cf. image compression, sound file compression.
Digital Print Order Format (DPOF)	A standardized ASCII file created in a digital camera and stored on removable media along with the image files that indicate how many copies of which images should be printed. It also allows index prints, cropping, and text overlays to be specified.
Digital Still Camera (DSC)	A camera incorporating an image sensor which outputs a digital signal representing a still picture, or records a digital signal representing a still picture on a removable medium, such as a memory card or magnetic disk.
Dynamic Range	Dynamic range in photography describes the ratio between the maximum and minimum measurable light intensities (white and black, respectively).
Exif/JPEG	A compressed file format for digital cameras in which the images are compressed using the baseline JPEG standard, described in ISO 12234-2, and metadata and thumbnail images are stored using TIFF tags within an application segment at the beginning of the JPEG file.
Exposure Index	A numerical value that is inversely proportional to the exposure provided to an image sensor to obtain an image. Images obtained from a camera using a range of exposure index values will normally provide a range of image quality levels.
ISO Speed	A numerical value calculated from the exposure provided at the focal plane of an electronic camera to produce specified camera output signal characteristics using the methods described in the referenced standard. The ISO speed should correlate with the highest exposure index value that provides peak image quality for normal scenes.
JPEG	Joint Photographic Experts Group. An image compression method defined in ISO/IEC 10918-1.
Protocol	Defined mechanisms for exchanging data between devices.

Terms	Definitions
StorageID	A device-specific four byte unsigned integer (UINT32) that represents a unique storage area that may contain data objects. The most significant sixteen bits of a StorageID represents the PhysicalStorageID, while the least significant sixteen bits of a StorageID represents the LogicalStorageID.
USB	Universal serial bus, a digital interface for connecting up to 64 devices in a tiered-star topology. See http://www.usb.org .
White Balance	The adjustment of electronic still picture color channel gains or image processing so that radiation with relative spectral power distribution equal to that of the scene illumination source is rendered as a visual neutral.

Source: ISO/WE 12231 Photography-- Electronic still-picture cameras -- Terminology

Specifications

Display	2.7" color LCD
Sensor Type	1/2.3" CCD
Effective Pixels	12.2MP (4032x3024)
Zoom	4X optical zoom, 5X digital zoom
Lens	Focal Length: 5.05 (W) ~ 20.2 (T) mm
Aperture	F2.8 ~ F6.3
Still Image Format	JPEG/EXIF 2.2
Photo Resolution	14 M (4320 x 3240), 3:2 (4320 x 2880), 8M (3264 x 2448), 5M (2592 x 1944), 3M (2048 x 1536), 16:9 (1920 x 1080), VGA (640 x 480)
ISO Sensitivity	Auto, 50, 100, 200, 400, 800, 1600, 3200 (<3MP), 6400 (1280x960)
Video Format	AVI (Motion JPEG)
Video Resolution	1280 x 720p (16:9)_Only SDHC Class 6 memory cards supported, 640 x 480, 320 x 240, 640 x 480 (Web)
Storage Media	SD/SDHC (Up to 32GB)
Power	AA battery _Photo Lithium recommended for maximum performance
Dimensions	3.7 x 2.4 x 0.9 inch / 94.7 x 61.1 x 24.1 mm
Weight	0.25 lb / 115g (without battery)

Package Contents

Please check the contents of your camera package. It should contain:



Digital camera

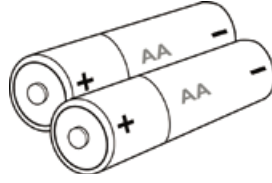

AA battery x 2 pcs



Wrist strap

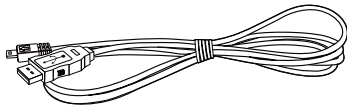

USB cable

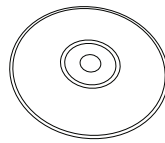

CDROM disc with User Manual and Software installation

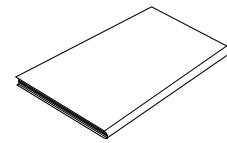

Quick Start guide



Warranty card

Getting Started

Attach the Camera Strap

To reduce the risk of dropping the camera, it is strongly recommended to attach and use the provided camera strap.

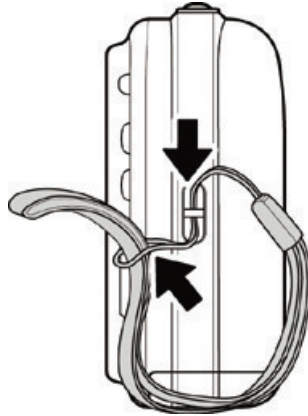

Inserting the Batteries

Follow these instructions to insert the batteries into the battery/memory card compartment. Please read "Battery Information" on page 2 before inserting/removing batteries.

1. If the batteries are already installed, make sure to power off the camera before removing and inserting recharged or new batteries.

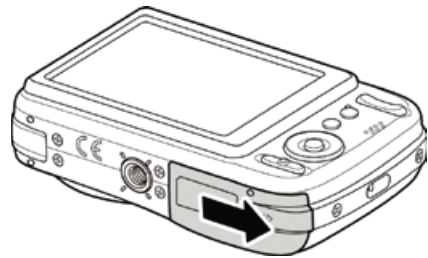

2. Open the battery/memory card compartment at the bottom of the camera as illustrated.

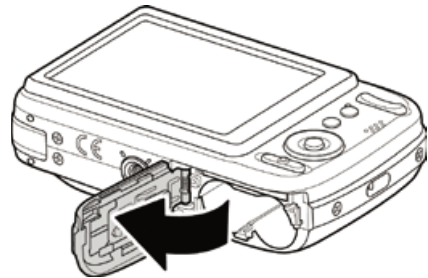

3. Insert the batteries into the compartment with correct orientation as illustrated.

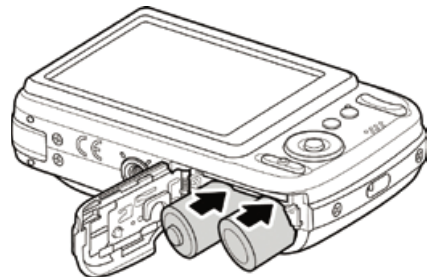

4. Close and secure the battery/memory card compartment.

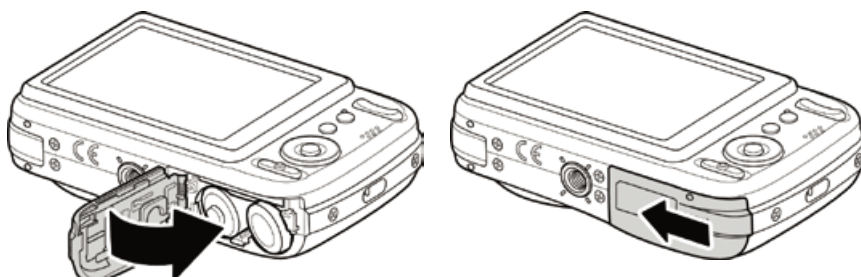

Inserting an SD/SDHC Memory Card

It is highly recommended that the camera storage is expanded by inserting a SD or SDHC memory card. These memory cards are available at most consumer store and online locations.

1. Make sure to power off the camera before proceeding. Inserting the memory card while powered on may damage the card and camera.
2. Open the Battery/memory card compartment at the bottom of the camera.
3. Insert the SD/SDHC card into the memory card slot with the metallic connectors facing the front side of the camera as illustrated below.
4. Push the SD/SDHC card into the memory slot until it clicks into place. If the card does not click into place, repeat the previous step to ensure proper orientation.
5. Close the Battery/memory card compartment.

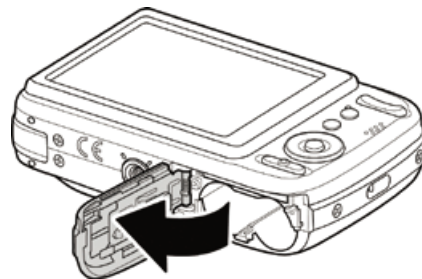

To remove the SD/SDHC card

1. Make sure to power off the camera before proceeding. Removing the memory card while powered on may damage the card and camera.
2. Open the battery/memory card compartment.
3. Gently push the card until it clicks and pushes out of position.
4. Carefully pull out the card.

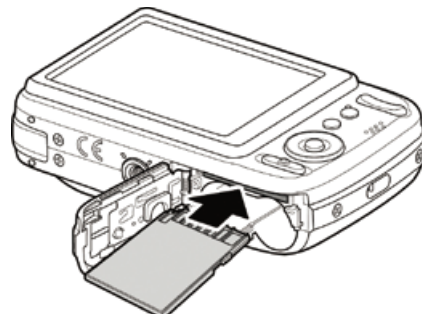

Camera Memory

Internal memory

This camera is equipped with 32MB of internal memory. However, storage of images, video and audio clips is limited to approximately 12MB. For optimal use, it is strongly recommend that this camera is used with SD or SDHC memory cards. If there is no SD or SDHC memory card inserted in the memory card slot, all images, videos and audio clips recorded are automatically stored in the internal memory.

External storage

This camera supports SD cards of up to 4GB, and SDHC cards with a maximum capacity of 32GB. It is strongly recommended that Class 4 or above memory cards are used with this camera. Consult the reseller or manufacturer of the memory card for class rating details.

If a SD/SDHC card is inserted in the memory slot, the camera automatically saves all images, videos and audio clips to this storage card. The LCD memory card icon  indicates the camera is using SD card.



Not all SD/SDHC memory cards may be compatible with this camera. When purchasing a card, please verify the card's specifications.

Camera Views

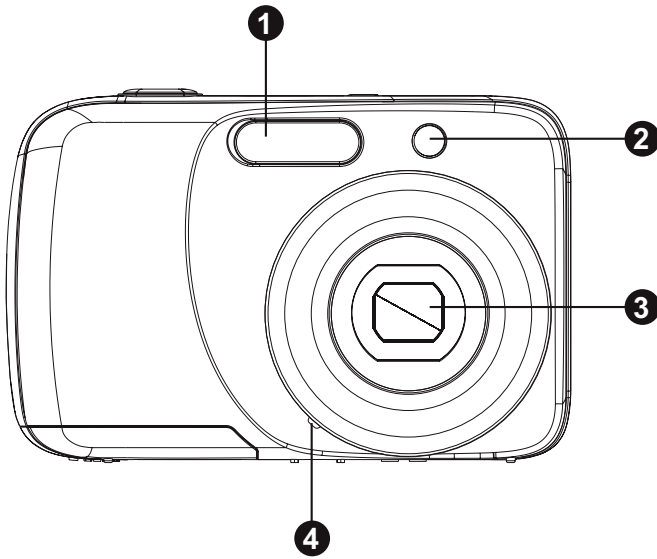

Front View

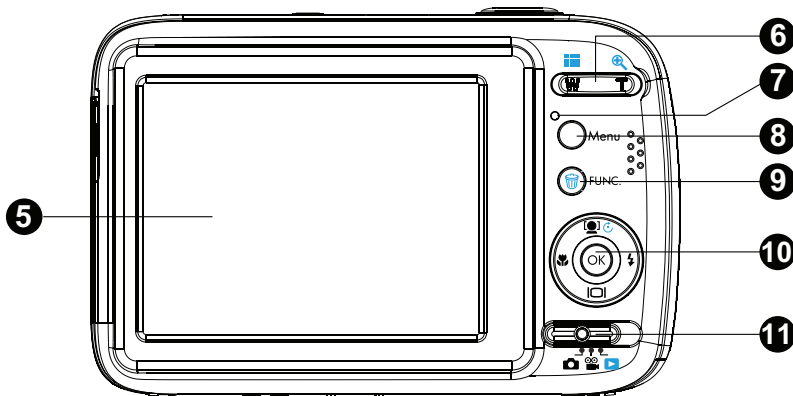

- 1. Flash
- 2. Self-timer LED / AF Assist Lamp
- 3. Lens
- 4. Microphone

Back View



- 5. LCD display screen
 - 6. Zoom buttons
 - 7. LED indicator
 - 8. Menu button
 - 9. Function / Delete button
 - 10. OK button / 4-way navigation control
 - 11. Mode Selector Switch
-  Photo Mode
 -  Video Mode
 -  Playback Mode

Top View

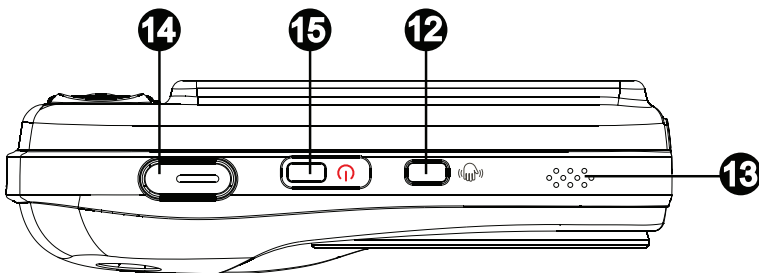

- 12. Stabilizer button
- 13. Speaker
- 14. Shutter button
- 15. Power button

Bottom View

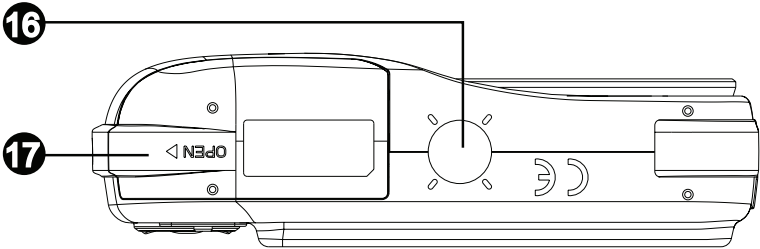



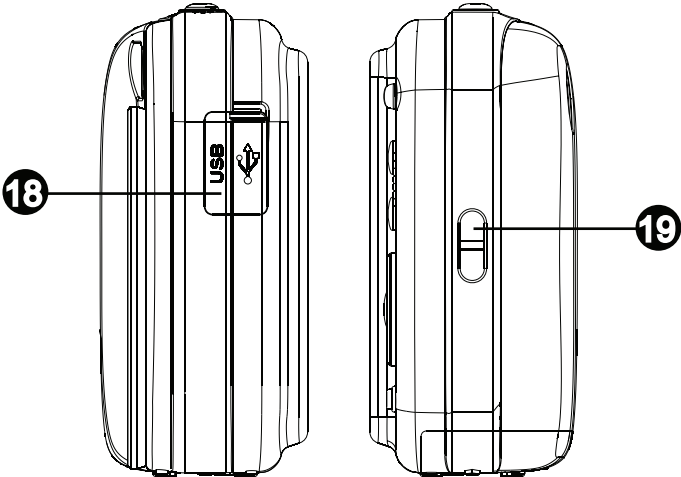

- 16. Tripod screw hole
- 17. Battery/Memory compartment door

Left/Right View

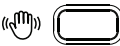

- 18. USB/TV Out
- 19. Strap ring

Camera Buttons





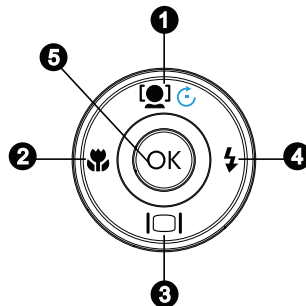

Button		Description
Power		Press the Power button to turn the power on/off.
Stabilizer		The stabilizer sets the optimal ISO value according to light levels to compensate for camera motion and help reduce motion blur. Press to set stabilizer on/off.
Shutter		Press to capture an image or start/stop recording video or audio clips.
Zoom		In Photo and Movie mode, press the "W" button to zoom out, or "T" button to zoom in. In Playback mode, press to zoom in to magnify image or zoom out to enter 9-image/calendar thumbnails.
Menu	 Menu	Press to enter or exit menu/submenu.
Function/Delete	 FUNC.	In Photo or Video Mode, press to enter function submenu. In Playback mode, press to delete an image, video or audio clip.



Navigation Control

The 4-way **Navigation Control** and the OK button is used to access and select the various menus, settings and options available from the On Screen Display (OSD). Configure a wide range of settings to ensure optimal results for images and videos. Further functions of these buttons are as follows:



No.	Description
1	Face Tracking, Photo Rotation, and up direction
2	Macro/Focus mode selector and left direction
3	Display mode selection and down direction
4	Flash mode / right direction
5	OK Button

Button	Description
OK Button	 <ol style="list-style-type: none"> Press to confirm a selection when using the OSD menus. Press to start the playback of video and audio clips. Note: Must have the mode selector switch set to Playback mode.
Flash Mode/ Right	 <ol style="list-style-type: none"> In Photo Mode, press to cycle through the flash mode options. ( Auto,  Anti Red-eye,  Slow Sync,  Forced On and  Forced Off) See page 24 for additional details. In Playback mode, press to view the next image, video or audio clip. During playback of recorded video clips, press to fast forward. In Menu and Settings mode, press to enter the submenu or to navigate through the menu selections.

Button	Description
Macro/Left 	<ol style="list-style-type: none"> In Photo Mode, press to cycle through Macro and other focus options. (Macro, PF Pan focus and INF Infinity) See pages 24-25 for additional details. In Playback mode, press to view the previous image, video or audio clip. During playback of recorded video clips, press to rewind. In Menu, press to exit a submenu or to navigate through the menu selections.
Up/Face Tracking/Rotate 	<ol style="list-style-type: none"> In Photo Mode, press to turn the face tracking function on and off. During playback of video or audio clips, press once to Pause, press again to Resume. In Playback of photos, press to rotate the image clockwise 90 degrees by each press of the button. Please note that this feature is applicable for Photos only and video clips cannot be rotated. In Menu, press to navigate through the menu and submenu selections.
Display/Down 	<ol style="list-style-type: none"> In Photo Mode, press to change the LCD screen display information. Continue to press to cycle through the display options. See page 12 for additional details. In Playback Mode, press to change the display of photo, video, or audio information. Continue to press to cycle through the display options. See page 12 for additional details. During playback of recorded video or audio clips, press to stop the playback. In Menu, press to navigate through the menu and submenu selections.

Turning the Power On and Off

Press the **Power button**  to power on and off the camera.

- If the mode selector switch is set to Photo or Video mode, the startup image displays briefly and the startup sound plays if enabled. The camera lens extends and the camera is ready for use.
- If the mode selector switch is set to Playback mode, the last recorded photo, video clip, or audio clip will be displayed and the lens will not be extended.

To turn off the camera, press the **Power button**  or the camera will automatically shut off when not used for the selected Power Save (see page 62 for details) setting. The default setting is after 1 minute of inactivity.

Initial Settings

When the camera is powered up for the first time, please set the display language and date & time.

Setting the Language

1. Press directional buttons to move through the selection.

2. Highlight the desired a language, and then press **OK button** .

Setting the Date & Time

1. Press left and right direction buttons to move through the selection.

2. Press the up and down buttons to change the value for the date and time.

3. Press **OK button**  when finished. This will save your date and time settings.

4. If necessary, press **Menu button**  to close the menu.

At this point, the camera settings are set to the default automatic mode and is ready to take photos and videos.

	<ul style="list-style-type: none">• If the camera is without battery power for more than 48 hours, the initial settings may reset and require another setup.
---	--

Modes Selector Switch

This camera has a three mode selector switch. The different modes are:

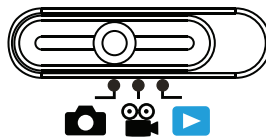





Photo Mode

- Slide the mode switch to [] take photos and record audio clips by selecting Voice REC from scene modes (see pages 12 for additional details).

Video Mode

- Slide the mode switch to [] record videos (see page 29 for additional details).

Playback Mode

- Slide the mode switch to [] view and edit captured images or playback videos and audio clips. The recording of voice memo attached to images is also available in this mode.

Understanding the LCD Screen

The LCD monitor shows all important information regarding camera settings as well as the visual image of your image or video. The display on the LCD monitor is called the On Screen Display or OSD.

LCD Screen Layout

Photo Mode Screen Layout

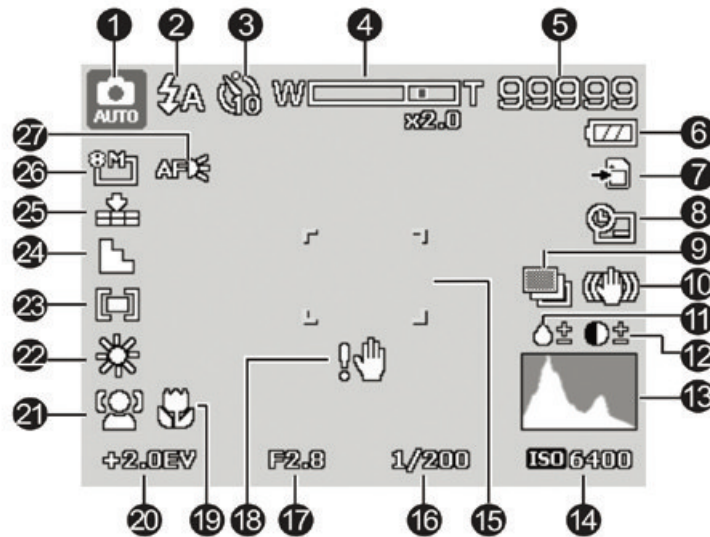

No.	Item	Description
1	Record Mode	Indicates the current capture/scene mode. Please see page 43 for additional details.
2	Flash	Please see page 24 for additional flash option details.
3	Self-timer/Burst	Indicates drive mode settings.
4	Zoom indicator	Displays zoom type and level. Please see page 23 for additional details.
5	Shots remaining	Indicates the remaining shots available.
6	Battery	Indicates approximate battery level. Please see page 2 for additional details.
7	Storage media	Indicates current storage media in use. Options are Internal memory and SD/SDHC memory card.
8	Date stamp	Indicates date stamp is enabled. Please see page 45 for additional details.
9	Auto Exposure Bracketing (AEB)	Indicates AEB function is enabled. Please see page 3 for additional details.
10	Image Stabilizer	Indicates if the image stabilizer function is enabled. Please see page 22 for additional details.
11	Saturation	Displays saturation settings. Please see page 44 for additional details.
12	Contrast	Displays contrast settings. Please see page 44 for additional details.
13	Histogram	Display the darkest and brightest values, corresponding to black and white respectively.
14	ISO	Displays ISO settings. Please see page 28 for additional details.
15	Display focus area settings	Use to frame subject to capture.

No.	Item	Description
16	Shutter speed	Displays shutter speed settings. Please see page 22 for additional details.
17	Aperture value	Displays aperture settings. Please see page 40 for additional details.
18	Shake warning	Indicates that the camera is moving too much that may result in image blur. Use of a tripod or steady hand may be required.
19	Macro	Indicates macro is enabled. Please see page 25 for additional details.
20	Exposure	Displays exposure settings. Please see page 41 for additional details.
21	Face tracking	Indicates face tracking is enabled.
22	White balance	Displays white balance settings. Please see page 27 for additional details.
23	Metering	Displays metering settings. Please see page 28 for additional details.
24	Sharpness	Displays sharpness settings. Please see page 43 for additional details.
25	Quality	Displays quality settings. Please see page 27 for additional details.
26	Resolution	Displays photo resolution settings. Please see page 26 for additional details.
27	AF lamp	Indicates AF lamp is enabled. Please see page 43 for additional details.

Video Mode Screen Layout

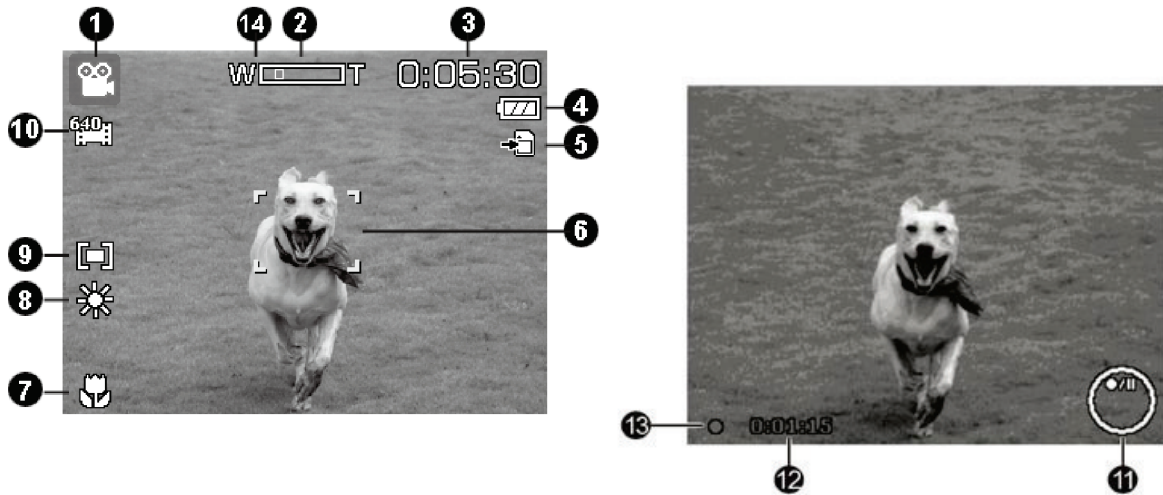

Standby layout

Recording Layout

No.	Item	Description
1	Record Mode	Indicates the current mode.
2	Zoom indicator	Displays zoom.
3	Time remaining	Indicates the remaining time of video available.
4	Battery	Indicates battery level.
5	Storage media	Indicates current storage media in use.
6	Display focus area settings	Use to frame subject to record.
7	Macro	Indicates macro is enabled.
8	White balance	Displays white balance settings.
9	Metering	Displays metering settings.
10	Resolution	Displays movie resolution settings.
11	Key indicator	Indicates the buttons to press on the camera to apply the functions.
12	Recorded time	Displays recorded time.
13	Recording status	Indicates recording status.
14	Pre-record 	Indicates pre-record is enable.



The Pre-Record icon appears on the screen in red color as the same position as zoom indicator.

Playback Mode Screen Layout

The Playback mode display varies depending on the type of image being viewed.

Playback mode display of photos:

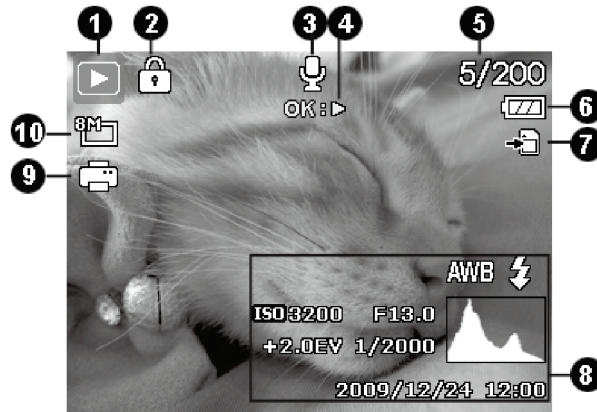

No.	Item	Description
1	Playback mode	Indicates the camera is in playback mode.
2	Protect	Indicates file is protected. Please see page 56 for additional details.
3	Voice clip	Indicates the photo has a attached audio clip.
4	Button intro	Indicates that pressing the OK button will begin playback.
5	File Number	Indicates the file number over the total number of files in the internal memory or SD/SDHC memory card.
6	Battery	Indicates approximate battery level.
7	Storage media	Indicates current storage memory. Options are internal camera memory or SD/SDHC memory card.
8	Recording information	Displays the capture details of the photo.
9	DPOF	Indicates the file is marked for printing. Please see page 60 for additional details.
10	Resolution	Displays the photo resolution setting at the time it was taken.

Playback mode of videos:

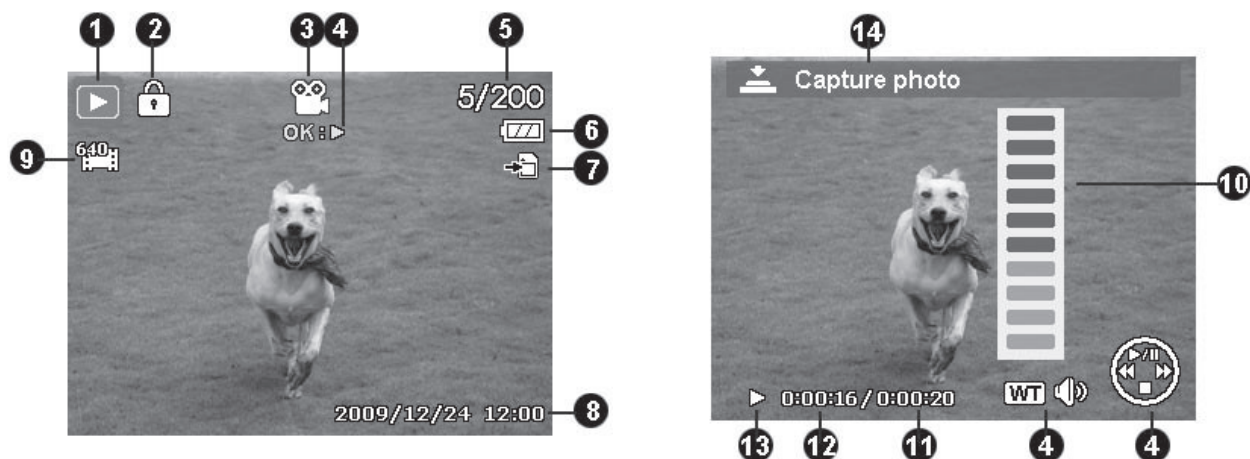

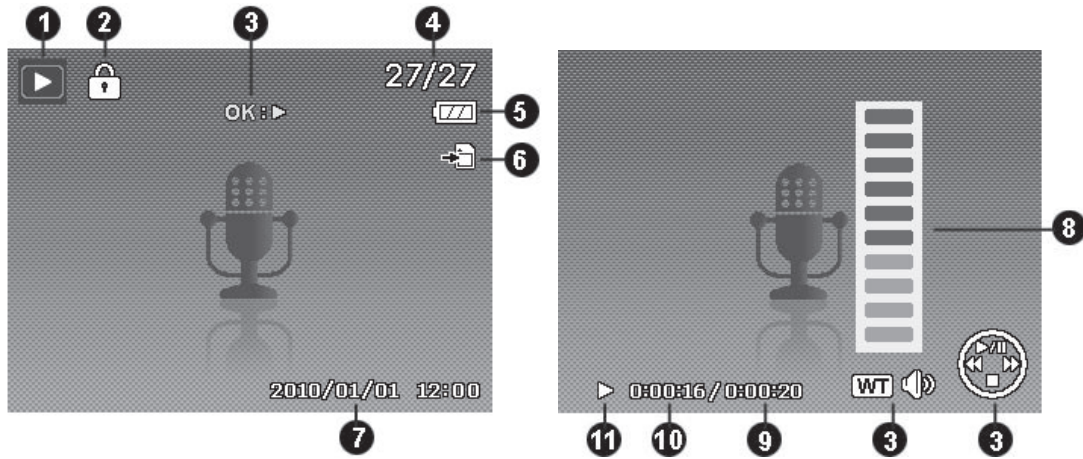

No.	Item	Description
1	Playback mode	Indicates the camera is in playback mode.
2	Protect	Indicates file is protected. Please see page 56 for additional details.
3	Video clip	Indicates the file is a video clip.
4	Button intro	Indicates buttons used during playback.
5	File Number	Indicates the current file number and total files stored in the internal memory or SD/SDHC memory card.
6	Battery	Indicates approximate battery level.
7	Storage media	Indicates current storage memory. Options are internal camera memory or SD/SDHC memory card.
8	Recording date & time	Displays the date and time of the video clip at the time is was recorded.
9	Video Resolution	Indicates the resolution setting of the video clip at the time is was recorded.
10	Volume	Indicates the volume while playing. Use the Zoom buttons to increase or decrease playback volume.
11	Video length	Display the total length of the video clip.
12	Played time	Indicates the played time of the video clip.
13	Playing status	Displays playing status. The options are: play, pause, rewind, or fast forward.
14	Capture photo	To capture a still image from the video clip, pause at the desired moment and press the shutter button. The image is automatically saved to memory and the video can resume playback.

Playback mode of audio clips:



No.	Item	Description
1	Playback mode	Indicates the camera is in playback mode.
2	Protect	Indicates file is protected. Please see page 56 for additional details.
3	Button intro	Indicates buttons used during playback.
4	File no./Total no.	Indicates the current file number and total files stored in the internal memory or SD/SDHC memory card.
5	Battery	Indicates the approximate battery level.
6	Storage media	Indicates current storage memory. Options are internal camera memory or SD/SDHC memory card.
7	Recording information	Displays recording information at the time the audio clip was recorded.
8	Volume	Indicates the volume while playing. Use the Zoom buttons to increase or decrease playback volume.
9	Audio length	Display the total length of the audio clip.
10	Played time	Indicates played time.
11	Playing status	Displays playing status. Options are play and pause.

Changing the LCD Display

The type of information displayed on the LCD monitor can be changed using the  button. Press the  button repeatedly to change the LCD display from one type to another. In Photo/Movie Mode, the LCD display can be changed into any of the following:

- Basic
- Full
- Minimal
- Guidelines
- No icons or information



- The OSD information may vary depending on the record mode type.
- Use the "Guide lines" to properly set image for capture. Typically, these guide lines are used to help vertical and horizontal alignment of the photo.

In Playback mode, the LCD display can be changed into any of the following:

- Basic
- Full
- No icons or information







LCD display cannot be changed in the following situations:

- While recording movie or audio clips
- During playing movie or audio clips
- Playing slideshow

Recording Photos, Movies and Voices

Taking Photos

This camera is designed to make the experience of taking photos simple and quick. It's Auto mode feature will optimise the internal settings so that in most situations, it can take photos with ease. This camera also has additional modes and features that extend the capabilities for the more experienced user.









1. Power on the camera by pressing the **Power button** .
2. Slide the **Mode switch** to Photo mode .
3. Frame the shot using the focus bracket on the LCD monitor.
4. Lightly pressing the **Shutter button**  down to the halfway position will start the automatic focus and adjustments to the exposure level. When the camera has successfully completed this automatic routine, the focus bracket will turn green. If the automatic focus and exposure routine is not successful, the bracket will turn red. If this occurs, simply release the shutter and repeat this step until the bracket turns green. In some situations, lighting and contrast may be insufficient for the camera to successfully complete the auto focus and exposure level routine. If this occurs, try better lighting.
5. Pressing the **Shutter button**  down fully will take the photo. If you take the photo when the bracket is red, the focus and exposure may not be correct.





If the shake warning icon  appears, hold the camera steadily, with your arms at your side or use a tripod to stabilize the camera to reduce the risk of blurred photos.

Recording Videos

This camera is capable of recording videos. Since video recording requires significant memory capacity, it is highly recommended to use SD/SDHC cards with this feature. The available recording time depends on the capacity of the memory card. Videos can be recorded until the maximum memory capacity has been reached. However the length of a single video clip is limited to 4 GB. To increase the recording length, lower the video quality settings (See page 26 for details).

1. Power on the camera by pressing the **Power button** .
2. Slide the **Mode switch** to Video mode .
3. Lightly pressing the **Shutter button**  down to the halfway position will start the automatic focus and adjustments the exposure level. When the camera has successfully completed this automatic routine, the focus bracket will turn green. If the automatic focus and exposure routine is not successful, the bracket will turn red. If this occurs, simply release the shutter and repeat this step until the bracket turns green. In some situations, lighting and contrast may be insufficient for the camera to successfully complete the auto focus and exposure level routine. If this occurs, try better lighting.
4. Pressing the **Shutter button**  down fully will begin the video recording.
5. Use the **Zoom buttons**  to zoom in and zoom out.
6. To pause recording, press the key .
7. To continue recording, press the key  again.
8. To stop recording, press the **Shutter button**  down fully.



	<ul style="list-style-type: none">• When the camera stops recording due to reaching maximum capacity (4GB) for a single video clip, simply press the Shutter button again to continue recording. To increase the recording length, lower the video quality settings (See page 26 for details).• The camera will automatically stop recording when the memory capacity is full.• Digital zoom is not available while recording a video.• Sound cannot be recorded while pressing the Zoom buttons .• Power save is not available in video recording or pause recording.
---	---

Using the Stabilizer Feature

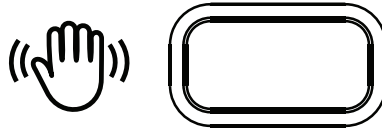

The Stabilizer feature is for Photo mode only. This feature is designed to help reduce the blurring effects on photos caused by slight camera movement. It is important to note that this feature cannot compensate for all movement and lighting situations and that in many cases may slow the camera's ability to auto focus.

How does it work? It works according to the luminance of the target object. This function uses special image data processing to optimise the high sensitivity of CCD sensor (also known as the digital film). High sensitivity allows the use of faster shutter speeds compared to the default mode, so it may reduce blurring caused by camera movement.



Stabilizer button

To activate Stabilizer

- Press the **Stabilizer button**   located on the top of the camera to enable/disable stabilizer.

If Stabilizer is enabled, the stabilizer icon is displayed on the LCD screen and the ISO setting is automatically set to Automatic. See "ISO" on page 28 for more details.



 — Stabilizer on

Setting the Zoom Control

Using a combination of 4 times optical zoom and 5 times digital zoom permits zoom photography at up to 20 times magnification. While the digital zoom can be a useful feature, the more an image is enlarged (zoomed), the more pixelated (grainier) the image may appear. Please refer to "Setting the Digital Zoom" on page 23 on how to setup digital zoom.

To adjust the optical zoom:



1. Press the **Zoom buttons**  to zoom in or zoom out.
2. The zoom indicator appears on the LCD monitor .

Zoom buttons

1. Press the "T" button to zoom in.
2. Press the "W" button to zoom out.



To adjust the digital zoom:

1. Activate digital zoom. See "Setting the Digital Zoom" on page 23.
2. Press the T button  to optically zooms in until maximum 4X limit is reached.
3. Momentarily stop pressing the T button then press again to now initiate the Digital Zoom feature .
4. Pressing the W button will zoom out until and return the camera to optical zoom.

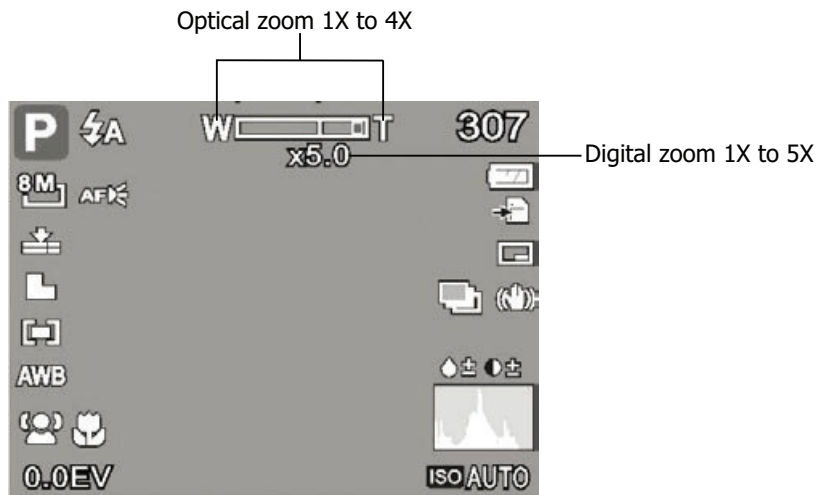

- Digital zoom is not available for video recording.
- Slight camera movement in digital zoom will make it more difficult to focus on objects/subjects. Use of a tripod can reduce this issue.

Using the Flash Features

By default, this camera is set to automatic flash mode which means that it will determine when to use this feature or not. However, in some situations, it may be useful to manually select the appropriate flash mode. When taking

pictures in difficult lighting conditions, use the **Flash button**  to select the desired mode. This function cannot be activated while recording videos or continuous shooting.

To activate Flash:

- Press the **Flash/Right** button on your camera repeatedly until your desired flash mode is displayed on the LCD screen.

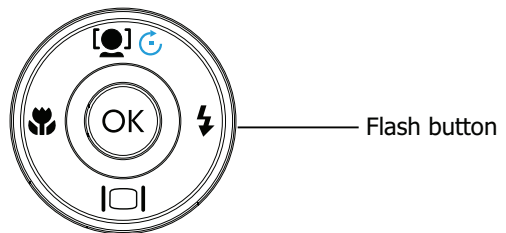

This camera is equipped with five flash modes:

AUTO.

The flash fires automatically whenever the camera determines extra lighting is needed. This is the default mode of the camera.

Red-eye reduction.

The flash fires twice to help reduce the red-eye effect. The first flash strobe is designed to force the iris of the subject to reduce in size to compensate for the bright light, thus reducing the reflection (red eye effect) of the Eye retina. The second strobe is when the photo is taken.

Forced on.

The flash fires whenever you press the Shutter button regardless of lighting conditions. This may be useful in some bright backlight situations.

Auto flash is enabled



SL Slow sync.

This would be used to capture a dimly lit background while keeping the foreground (subject) properly lighted. This flash mode forces the camera to use a slower shutter speed in combination with the flash. The flash fires briefly to light the foreground (subject) while capturing ambient light to reveal more detail in the background. If Slow Sync flash is not used, the background may appear black or underexposed.

Forced off.

The flash is turned off and will not fire regardless of the lighting situation. In low light situations, the use of a tripod may be required to reduce photo blurring.

	<ul style="list-style-type: none">• Flash function is only available in shooting still images but not available in Burst and AEB modes.• Do not try to change the flash while pressing the zoom button. Change the flash after releasing the zoom button if necessary.
---	---

Setting the Focus Mode

This function allows users to define the type focus when recording a still image or a video clip.

To set the Focus mode

- Press the **Macro** button repeatedly until the desired focus mode icon is displayed on the lower left corner of the LCD monitor.

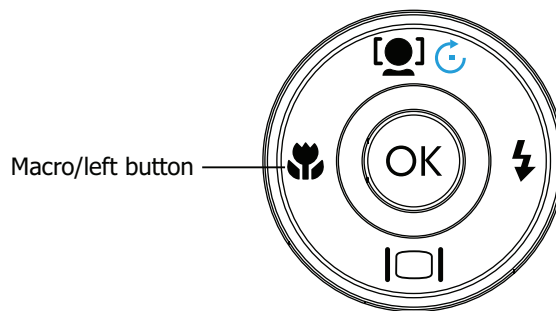

This camera supports the following four focus modes:

Normal.

With normal focus, the focus range starts from 0.4m (about 16 inches) to near infinity. When the camera is set to Normal mode, there is no icon displayed on the screen.



Macro.

This mode is designed for close-up photography. This mode should be used for subjects closer than 0.4 m (or 16 inches) from the lens. If Macro is enabled, the camera can capture the detail and sharpness of a very close subject by fixed focus.

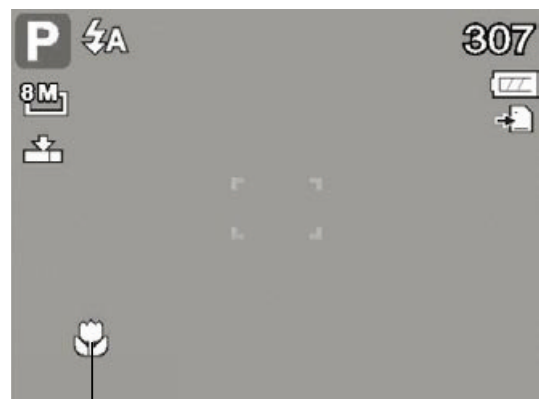

Macro enabled

PF Pan Focus.

This mode is designed to accurately focus on a desired subject so that closer and further objects are out of focus. For example, the camera might focus on a nearby tree, and the distant trees and mountains are blurry, as well as an even closer object such as a flower.

INF Infinity.

When Infinity is set, the camera focuses on distant objects. This may be good to use when taking landscape photos.

Using the Function Menu

The Function Menu is used to quickly adjust basic capture settings while in Photo and Video mode. In Photo mode, the Function menu displays the last 6 scene modes used as well as allow changes to be made in resolution and file compression quality settings, (EV compensation, Auto White Balance (AWB), ISO settings, Metering, and Color mode may be available for different scene modes). In Video mode, the function menu displays and allows changes to be made to Video resolution setting, AWB, Metering, and Color mode.



FUNC.

Press the **FUNC** button of your camera to launch the Function Menu.

Press the **FUNC** button again to close the menu.

- The Menu bar displays the current status of the camera settings. Only the available functions for the settings are shown as icon on the menu bar.
- The available options for each item on the menu bar are shown in the Menu options.
- Use the or key to move through the menu

selections then press the **OK button** to save and apply the changes.

Menu bar

Menu Options

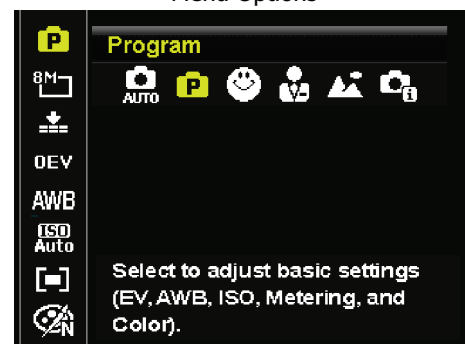

My Mode

The My Mode function displays the **6** most recent modes used in order. When moving through the different modes in the menu options, the items on the menu bar changes synchronously to the corresponding available settings.

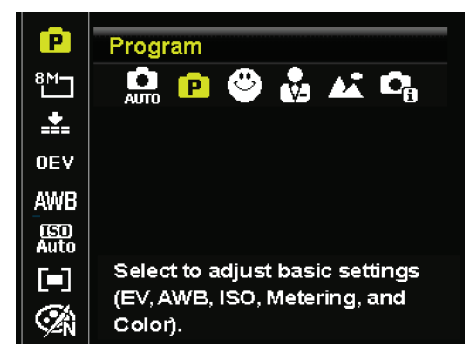
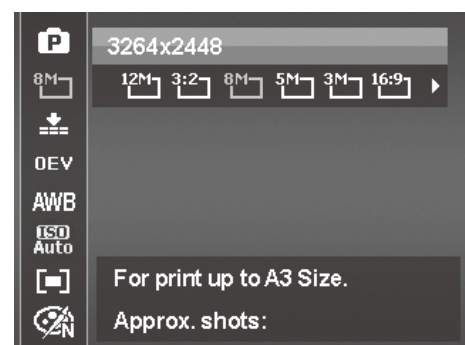

Photo Size

The Photo Size function is used to set the resolution before taking the photo. Changing the Photo Size affects the number of images that can be stored in memory. The higher the resolution, the more memory space is required.



The table below shows the Photo Size values for still images:

Icon	Pixel Size	Printing Size Suggestion	Icon	Pixel Size	Printing Size Suggestion
	4000 x 3000	A2 Size		2048 x 1536	4" x 6"
	3648 x 2432	A2 Size		1920 x 1080	HDTV
	3264 x 2448	A3 Size		640 x 480	E-mail
	2592 x 1944	A4 Size			

Quality

This allows the quality (compression) at which the photo is captured to be increased or decreased. The quality determines the amount of compression applied to the photos. Superfine setting results in a more detailed image. However, the higher the quality, the more memory space is required in memory.

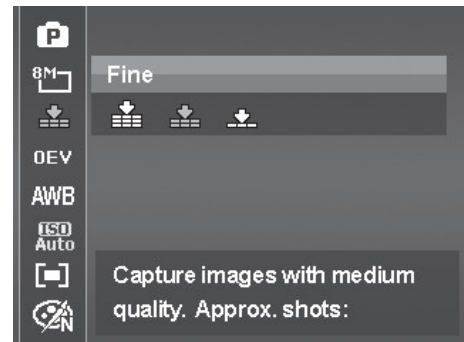

EV Compensation

Images can be captured with the overall scene intentionally made brighter or darker. These settings are used when a suitable brightness (exposure) cannot otherwise be obtained in circumstances where the difference in brightness between the subject and the background (the contrast) is large, or when the subject that you wish to capture is very small within the scene. Available for still images only.

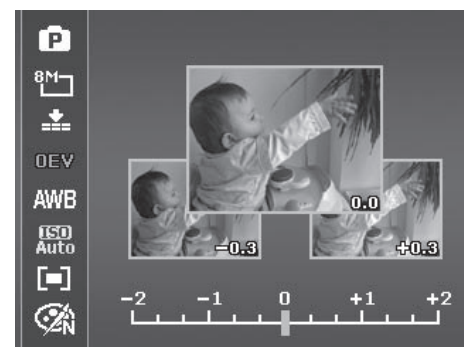

- To adjust EV settings, press the or keys to increase/decrease the value. As adjustments to the settings are

made, the LCD screen synchronously displays the image applying the EV settings. Press the **OK button** to save and apply changes.

- The available settings are: 0EV / +2.0EV / +1.7EV / +1.3EV / +1.0EV / +0.7EV / +0.3EV / 0EV / -0.3EV / -0.7EV / -1.0EV / -1.3EV / -1.7EV / -2.0EV

White Balance





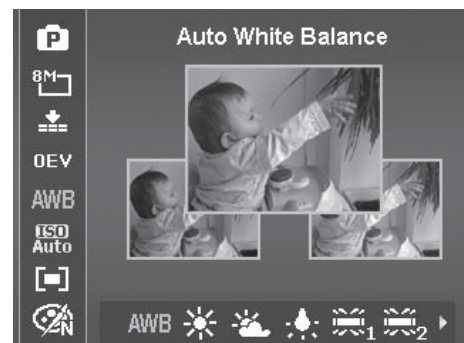

This sets the white balance for a variety of lighting conditions and permits photos to be captured to the desired level.

- As adjustments to the settings are made, the LCD screen synchronously displays the image applying the

AWB settings. Press the **OK button** to save and apply changes.

- Below is a table with a description of the different settings.



Icon	Item	Description
	Auto	The camera automatically adjusts the white balance.
	Daylight	Ideally used for bright sunny conditions.
	Cloudy	Ideally used for cloudy conditions.
	Tungsten	Ideally used for indoor photos with tungsten or halogen lighting without a flash.
	Fluorescent 1	Ideally used for indoor photos with reddish fluorescent lighting conditions.
	Fluorescent 2	Ideally used for indoor photos with bluish fluorescent lighting conditions.
	Manual	Used when light source cannot be specified. Press the Shutter button for the camera to automatically adjust the appropriate white balance setting according to the environment.

ISO

This sets the sensitivity of the sensor for capturing photos to compensate for various lighting situations. When the sensitivity is raised (and the ISO value is increased), photography in dark or dim lit locations are improved. However, this may result in a more pixelated (grainier) photo.

- Use a higher ISO setting in dim conditions and a lower ISO setting in brighter conditions. Read the text at the top to assist in determining the desired result.
- Available settings are: Auto, 100, 200, 400, 800, 1600, 3200 <3M>, 6400 <3M>.

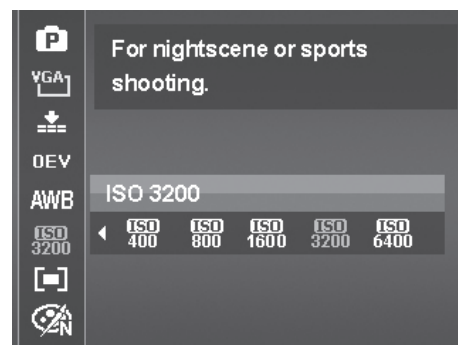

If the Stabilizer is enabled, ISO is automatically set to Auto and cannot be adjusted. To adjust ISO disable Stabilizer first.

Metering

The Metering function allows adjustment to select the area of the subject or frame by which the camera measures light to record still images or video.

- As adjustments to the settings are made, the LCD screen synchronously displays the image applying the

metering settings. Press the OK button  to save and apply changes.

- Below is a table with a description of the different settings.

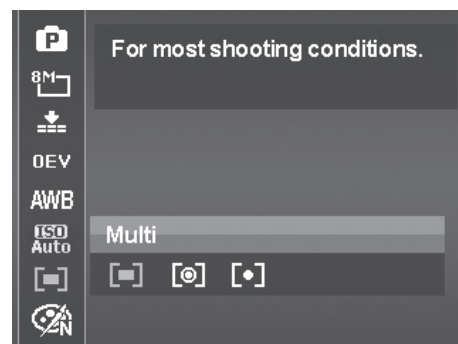

Icon	Item	Description
	Multi	The camera measures the exposure readings from multiple points in the subject area and selects the settings that best match this situation.
	Center	The camera measures the average light from the entire frame but gives greater weight to the subject matter at the center. The camera will select the settings that best match the situation.
	Spot	The camera selects the exposure value based on the center of your picture and selects the appropriate settings to match.

Color Mode

This feature allows adjustment to record photos and videos in different colors and tones for a more artistic effect. Tinting an photo or video color can make them appear more vivid.

- As adjustments to the settings are made, the LCD screen synchronously displays the image applying the Color

settings. Press the OK button  to save and apply changes.

- Below is a table with a description of the different settings.

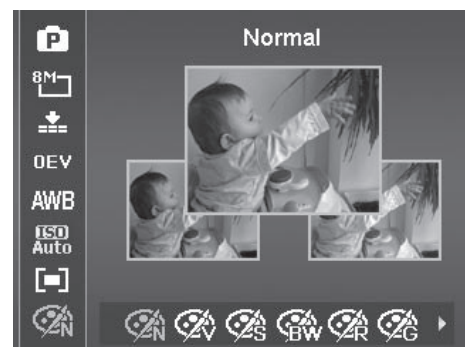

Icon	Item	Description
	Normal	The camera records normally.
	Vivid	The camera captures with more contrast and saturation emphasizing the bold colors.
	Sepia	Used to add the effect of an "aged" photo or video.
	B&W	Used to remove color and capture in black and white.
	Vivid Red	Images are tinted red. Ideally used to record images like flowers and cars to make them more vivid.
	Vivid Green	Images are tinted green. Ideally used to record images like mountains and lawns to make them more vivid.
	Vivid Blue	Images are tinted blue. Ideally used to record images like the sky and the ocean to make them look more vivid.

Using the Record Menu

In Photo mode, access to the Record menu is done by simply by pressing the **Menu button**  on back of the camera.





When the menu is displayed, use the 4-way navigation control and the **OK button**  to move through menu selections and apply the desired settings. To close the menu anytime, press the menu button again.

Record Menu

The Record menu allows changes to the scene modes, and setup other capture settings.

To go to Record Menu:

Set the mode switch Photo Mode [].

1. Press **Menu button**  to launch the Record Menu.
2. Use the  or  keys to move through the menu
3. To select an item, press .
4. Change the submenu settings using the 4-way navigation control.
5. Press the **OK button**  to save and apply settings.



Setting the Scene Mode





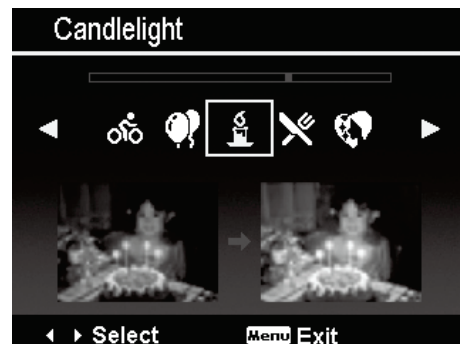









This camera offers 34 different modes, that can assist in taking a photo with the optimal settings or desired effects.













1. From the Record Menu, enter the **Scene Mode** options menu.
2. Use the left and right navigation controls to move through the selections.









3. The highlighted scene mode will either have text that describes the benefits of the mode or have a side-by-side photo comparison that illustrates the benefits. The photo on the left is a typical auto mode result and the photo on the right illustrates the benefit of selecting that scene mode. It is important to note that by selecting a particular scene mode (other than Auto) will take the camera out of its normal automatic settings capabilities and therefore optimise various settings that match a specific scene.
4. Press the **OK button**  to save and activate the selected scene mode.
5. It is important to return the camera to the Auto mode when finished shooting specific conditions. This will reduce the risk of taking a bad photo in normal situations. If the camera is powered off and then powered on, it will return to Auto scene mode by default.

The table below shows the available scene mode settings:

Icon	Item	Description
	Auto	The simplest and usually safest way to shoot basic photos. Settings are automatically adjusted by the camera. Each time the camera is Powered off then on, this mode will be selected by default. This is recommended for novice photographers.
	Program	The camera automatically adjusts suitable shooting settings like shutter speed and aperture values. However, this mode allows for manual adjustments to EV, Auto White Balance, ISO (gain), Metering, and Color effects.
	Intelligent Scene	The camera detects the shooting conditions and automatically switches to the appropriate scene mode.
	Portrait	This scene mode will attempt to isolate the subject by opening a wide aperture to blur the background and providing little depth of field. The subject will stand out because the background is blurry and the subject is in focus.
	Landscape	This feature is used to emphasize wide distant scenic views.
	Sunset	This feature enhances the red hue for recording dramatic sunrise or sunset images.
	Backlight	This feature is best used to capture photos with a strong backlight. For example, this mode will lighten the exposure to make the face of the person in the foreground to look normal instead of dark while maintaining the clarity and brightness of the background details.
	Kids	This feature forces the camera to select settings that will be optimal for moving kids. Red eye reduction and skin tone enhancement are also a benefit of using this mode.
	Night Scene	This feature is used to taking photos with night scenery background. Camera settings will be adjusted to capture brighter and more vivid night shots. For best results and reduced image blurring, the use of a tripod for this mode is strongly recommended.
	LOMO	This mode emulates the image effects known as Lomography.
	Fireworks	This feature slows shutter speed to capture the full burst of fireworks. Another interesting use would be to take photos of night traffic. This will produce artistic head and tail light stretch effects For best results and reduced image blurring, the use of a tripod for this mode is strongly recommended.
	Snow	This scene mode is best used when you're shooting against a bright background, such as snow or sand. This will enable the camera to focus on the subject instead of the background to determine the proper exposure and AWB settings for optimal results. If not selected, the subject may be too dark and the background "washed out".
	Sports	This scene mode will continue to capture images as long as the shutter button is pressed down. This is designed to aid for subjects in constant motion. It should only be used in adequate lighting situations because the flash will be disabled.
	Party	This scene mode will set red-eye flash and narrow other parameters that best match typical indoor wedding/party conditions.
	Candlelight	This feature is used to capture warm candle light effects.

Icon	Item	Description
	Night Portrait	This scene mode uses the flash and will leave the shutter open longer to get more ambient light from the background. This will help reduce typical flash pictures where the subject does not have a black/dark background. Ideally, this will produce photos that have more detail in the background. For best results and reduced image blurring, the use of a tripod for this mode is strongly recommended.
	Soft Skin	This scene mode will set red-eye flash and other camera parameters to enhance/soften tones that produce smoother younger looking skin as well as reduce the appearance of blemishes.
	Flowing Water	This mode enhances flowing water by applying a slight blurring effect.
	Food	This scene mode is designed to capture pictures of food in vivid colors. The Camera is set to macro mode focus and other parameters to increase saturation for enticing food images.
	Building	This feature enhances the edges of captured images that make it ideal to highlight details of buildings.
	Text	This feature enhances the black and white contrast normally used when capturing text images. Typically, normal photos of documents may look grey in tone. This mode will optimise settings for more color accurate results.
	Foliage	This feature boosts the saturation of greens to give a rich color to foliage and lawns.
	Auction	This feature combines up to 4 shots into a single photo and provides 4 patterns to select for usage of auction. It also selects resolution settings that produce detailed but smaller size photos that are Ideal for email attachments and online auction postings.
	Smile Capture	This feature uses face tracking to auto detect faces to capture. Press the shutter button and with each smile, the camera automatically detects and takes the photo to help ensure those moments are captured. The camera will continuously take smile detected subjects until the shutter button is pressed again.
	Blink Detection	This feature detects if the subject blinked an eye when the image is captured and gives the user an option whether to save the photo or not.
	Pre-composition	Compose the desired background and capture the shot by pressing the shutter button. A semi-transparent portion of the photo will display in the background of the LCD live display. Use this as a guide to compose the final photo. Press the shutter again to capture the final photo.
	Love Portrait	This feature uses face tracking to auto detect faces to capture portraits photos without the help of others. When two faces or more are detected in the same focus range, the AF is automatically activated and the camera starts a visual count down. In a few seconds, the camera automatically takes a picture. The camera will continue to snap photos as long as the two or more subjects are in range. This is a great feature to have when no one is around to assist.
	Self Portrait	Normally, self portraits require the subject to hold the camera at arms length so that they can push the shutter button. Often the result is a too close-up self image that is over exposed and background details reduced. This mode will not require the shutter button to be press while using face detection to track one or more faces in focus range. Once the camera has made the appropriate adjustments, it will start a visual countdown In a few seconds, the camera automatically take a picture. The camera will continue to snap photos as long as the one or more subjects are in range. This feature is great to compose never before possible self portraits.

Icon	Item	Description
	HDR	This feature applies digital processing only to the necessary portion(s) of the image and preserves details in highlights and shadows with natural contrast.
	Fisheye Lens	This mode emulates the effects of a Fisheye lens to photograph.
	Aperture Priority	This mode allows manual adjustment to aperture value. The camera automatically selects the shutter speed to match the brightness.
	Shutter Priority	This mode allows manual adjustment to shutter speed. The camera automatically selects the aperture value to match the brightness.
	Manual Exposure	This mode allows manual adjustment to shutter speed and aperture value regardless the brightness. This is recommended for experienced users only.
	Voice REC	This mode is used to record audio clips. Slide the mode selector switch to the Voice Record icon () to enable this mode.

After selecting the scene mode, the selected mode, except Voice Rec, will be added to the forefront in **My Mode** of Function Menu.

Using Intelligent Scene

This feature is most useful for novice users to capture great images even without basic knowledge of photography. Simply frame the shot with the help of Intelligent Scene Mode, the camera automatically recognizes 11 kinds of scenes - Portrait, Landscape, Sunset, Macro, Text, Snow, Backlight Portrait, Backlight Portrait, Night Scene, Night Portrait and Foliage - and selects the ideal settings.

Intelligent scene icon. After the camera detects the shooting conditions, this icon changes to show the detected scene mode.

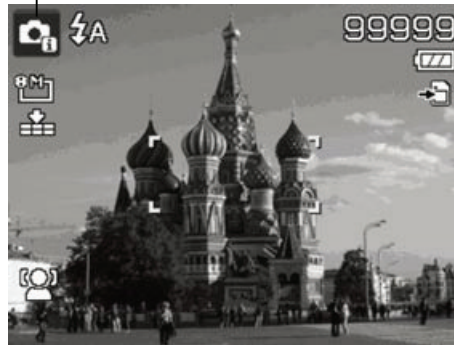

To enable Intelligent Scene:

1. Select  from the Scene Mode submenu.
2. Focus the camera on the subject to capture.
3. The camera detects the shooting conditions and switches to an appropriate scene mode.
4. Half press the Shutter button to focus the subject. The frame turns green to indicate focus is set.
5. Press the Shutter button to take the shot.

The camera changed to Landscape mode automatically.

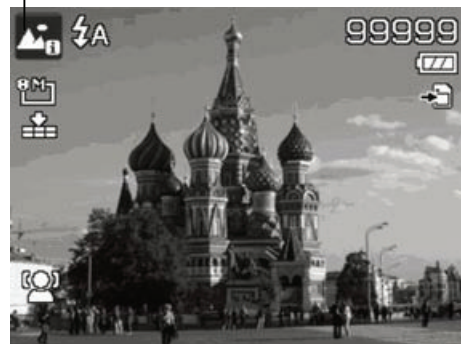

Using Kids Mode

Many people believe kids are one of the most difficult subjects to photograph. They tend to be highly animated and can be a real challenge to make them pay attention for more than just a second or two. To capture a great moment for your kids, just keep the camera in kid mode. The mode provides higher shutter speed and always focuses on moving subjects.



Using LOMO Mode

The LOMO mode applies the following effects on the photo:

1. Over-saturated colors
2. Off-kilter exposure
3. Blurring
4. Darkening around the edges of photo



Using Sports Mode

Ideal to taking a series of sports motion images, such as a golf swing, or try to capture the images of a flying hummingbird/butterfly, be sure to switch the scene mode to sports mode. This mode provides shutter in **Burst speed** (Keep shooting images long as the Shutter button is pressed) which allows you to capture a sequence of pictures that are frames apart clearly.



Make sure to have plenty of capacity on the memory card as it will be needed.

Using Party Mode

Let the Party begin! It can be difficult to get everyone on a party. Get the whole gang together, take a group or family portrait. Party mode features Red-eye reduction flash and face tracking. Miss fewer shots, and have more time to focus on enjoying the party.

Using Soft Skin mode

When the soft skin mode is activated, it makes wrinkles and lines look less conspicuous, while preserving resolution in areas of the picture outside of the skin. The camera detects skin color area, such as the face and processes the image to make the skin appear smooth.

Using Flowing water

Select this mode to enhance flowing water by applying a slight blurring effect.



Using Food Mode

How to share your dining experiences and comments of interesting widgets on your blog by close-up images? Just get the camera and set the scene with food mode. This mode features on macro focus and auto flash designed for close-up photography.

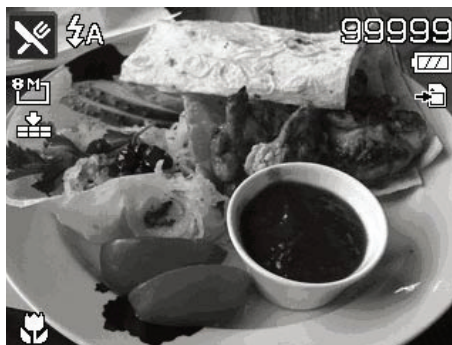



Using Foliage Mode

A scenic image, such as a garden or forest scene, that full of dull green colors is boring. In foliage mode, the greens, blues, are brilliantly enhanced making scenic pictures pop out with bright color.



Using Auction Mode

It's hard and wastes a lot of time to combine several images by software. Select Auction mode and choose a pattern, then take a few shots from different angle. The camera composes a combined image in lower resolution suited to online posting.

1. Select Auction mode from Scene mode menu.
2. Use  or  keys to choose a pattern.
3. Press the **OK button**  to start shooting.



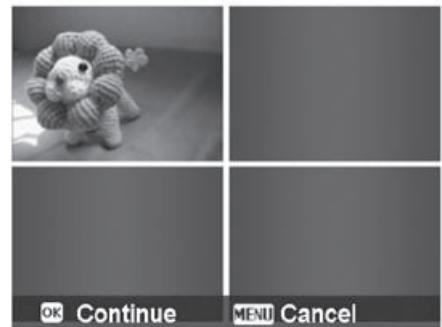

4. Frame the subject and press the **Shutter button**  to take the first shot.

5. Press the **OK button**  to continue the second shot.
6. Or, press **Menu button**  to go back the first shot.



7. Repeat step 4 to 6, until the pattern is filled in images.

8. Press **OK button**  to save the composed image.
9. Or, press **Menu button**  to go back last shot.



10. The camera save the image to memory.
11. Use USB cable or memory card reader (Please refer to "Connecting the Camera to a PC" on page 69) to transfer the image to PC and upload it to website.

Auction mode provides 4 kinds of pattern as follow



The end photo is set to low quality and VGA (640x480) size only for the purposes of having a small files size easy for uploading.

Using Smile Capture Mode

When facing the camera, especially kids, smiles are always short and hard to seize by manual shutter. Smile capture mode detects every smile all the time and performs Automatic Focus (AF) to capture an image without pressing Shutter button.

Follow these instructions to capture a photo by Smile Capture Mode:

1. Select  from scene menu.
2. Focus the camera on the subject to capture.
3. When a smile is detected, the white focus frame turns green to denote camera shutter and take a shot automatically.

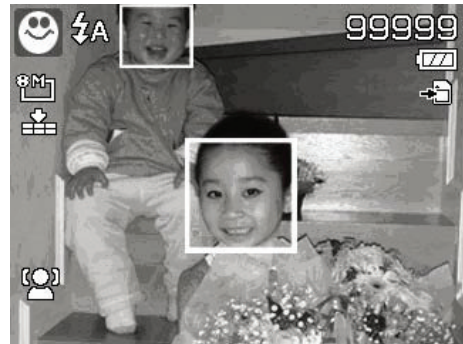



Using Blink Detection Mode

Nothing ruins a great picture more than having a subjects' eyes closed. Blink Detection provides an extra assurance when capturing once-in-a-lifetime moments.

If closed eyes are detected, a saving confirmation menu appears on the screen, allowing for a re-take of the shot before your subject or subjects move on.

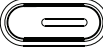
To activate Blink Detection

1. Select  from Scene Mode submenu.
2. Half press the **Shutter button**  to focus the subject. The frame turns green to indicate focus is set.
3. Press the **Shutter button**  to capture the photo and automatically save the Image.





4. If the camera detects that a subject has blinked, a "Save image or Cancel" option appears on the screen.
5. Select **Save image** to save the photo, or **Cancel** to disregard.

Using Pre-composition Mode

When asking someone else to take photos for you, but the photos always don't come up right?

Pre-composition helps to get the desired background, even if someone else is needed to take the picture.

Basically, Pre-composition is a two-step process.

1. Compose the desired background and press the **Shutter button**  (full press), which causes a semi-transparent image of the background to remain on the LCD monitor. If the background is not correct, press the **Menu button**  to cancel the semi-transparent temporarily image and repeat this step until the desired background is achieved.

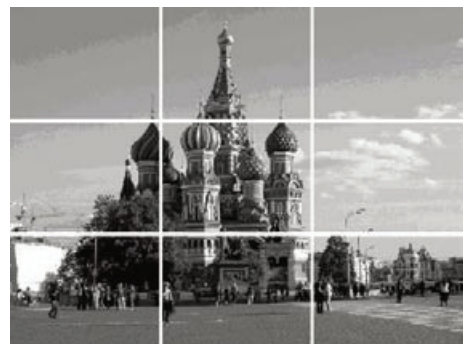

2. Ask someone else to take the desired picture by using the semi-transparent screen image as a guide.



3. Move your position until photographer confirm your whole or half body in the frame and in the right place.
4. Press the Shutter button. Camera stores the image produced by this step only.



Using Love Portrait

Want to take a good photo when there are just two of you? All you have to do is position the camera and smile together.

If two or more faces are recognized, the camera performs 2-second countdown with a beep notice then take a shot without pressing the **Shutter button** .

Using Self Portrait

When taking the picture for yourself, the self portrait mode is necessary besides the tripod. If a face has been recognized, the camera performs 2-second countdown with a beep notice then take a shot without pressing the

Shutter button .

Tips to make a great shape by self portrait photography:

- Lean in towards the camera to reduce double chin.
- Angle your body and bend your arms to look slimmer.
- Keep your shoulders back.

Using HDR Mode

Active HDR mode preserves details in highlights and shadows, creating photos with natural contrast. Use for high contrast scenes, for example, when photographing brightly light outdoor scenery through a door/window, or taking pictures of shaded subjects on a sunny day. With this feature, the adjustment of contrast is accomplished in-camera and requires no additional post-processing for the bulk of images.

Using Fisheye Lens Mode

The Fisheye Lens mode applies a hemispherical effect on the photos to make them look more interesting.





Using Aperture Priority Mode

This mode is designed for control the aperture value by user and let camera decide the shutter speed. The main impact that aperture had on images was with regards to Depth of Field. (DOF)

- Choose larger aperture, only one subject in focus but the background nice and blurred. (Shallow DOF)
- Choose smaller aperture, an image with everything in focus. (Great DOF)

To set Aperture values

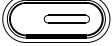
1. Select **A** from the Scene Mode submenu.
2. Press **OK button**  to enter the adjust mode.
3. Use the  or  keys to select the aperture value options.
4. Press the **Shutter button**  to capture the image.





Displays the aperture value

Using Shutter Priority Mode

This mode is designed for capturing moving subjects. A faster shutter speed is required to freeze a motion (flying birds), while the slower shutter speed creates a sense of motion (water flowing).

To set Shutter values

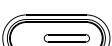
1. Select **S** from the Scene Mode submenu.
2. Press **OK button**  to enter the adjust mode.
3. Use the  or  keys to select the shutter value options.
4. Press the **Shutter button**  to capture the image.









Displays the shutter value

Using Manual Exposure

When the camera is in the manual exposure mode, you can change either aperture or shutter speed, or both.



To activate Manual Exposure

1. Select **M** from the Scene Mode submenu.
2. Press **OK button**  to enter the adjust mode.
3. Use the  or  keys to select the shutter speed.
4. Or, use the  or  keys to select the aperture value.
5. Use the **OK button**  to switch between aperture and shutter speed adjustment and vice versa.
6. Press the **Shutter button**  to capture the image.

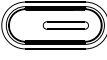

Displays the aperture and shutter speed value

Using Voice Recording

1. From the Scene menu, select . The Voice Recording screen layout is displayed on the LCD monitor.
2. Press the **Shutter button**  to start recording.
3. Press the **Shutter button**  again to stop recording.



Setting the Drive Mode





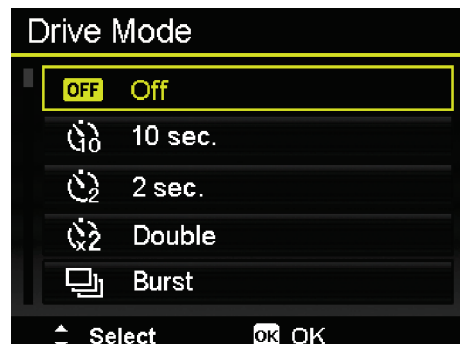
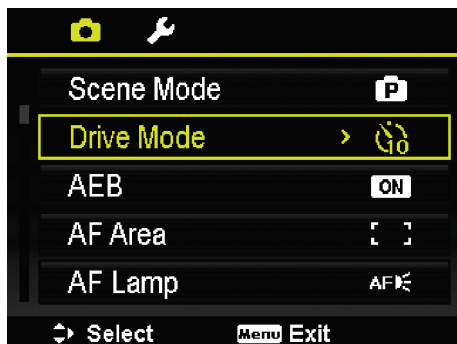

This camera features a Self-timer and Burst which can be set in the Burst mode function in the Record Menu. The Self-timer will take photos after a predefined delay. The burst will take consecutive shots. This function is only available in Photo mode. The Burst mode setting is automatically set to off when you turn off the camera.

To set the Drive Mode

1. From the Record menu, select **Drive Mode**.
2. Use the  or  keys to go through the selection.
3. Press the **OK button**  to save and apply changes.





The table below shows the available Drive mode settings.

Icon	Item	Description
	10 Sec Self-timer	Sets a 10-second delay to capture image after pressing the Shutter button.
	2 Sec Self-timer	Sets a 2-second delay to capture image after pressing the Shutter button.
	Double Self-timer	Performs delay and capture twice: <ul style="list-style-type: none"> • Performs a 10-second delay, then captures the image. • Performs another 2-second delay then captures the image again.
	Burst	Performs continuous shooting when the Shutter button is pressed. Stops shooting when the shutter button is released.
	Speedy Burst	Captures 30 images in a shot when the Shutter button is pressed. Auto set Image size to VGA only.
	Off	Captures an image without time delay.

Setting the AEB

AAEB stands for Automatic Exposure Bracketing. It takes 3 consecutive photos in the order of standard exposure, under exposure and overexposure compensation.

To set AEB

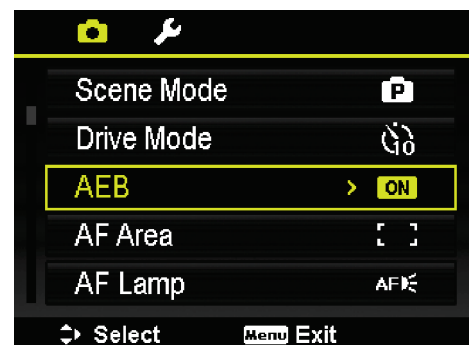

1. From the Record menu, select **AEB**.
2. Use the  or  keys to go through the selection.
3. Press the **OK button**  to save and apply changes.



Setting the AF Area

AF stands for Automatic Focus. This feature determines the area on which the camera focuses.

To set AF Area

1. From the Record menu, select AF Area.
2. Use the  or  keys to go through the selection.
3. Press the **OK button**  to save and apply changes.

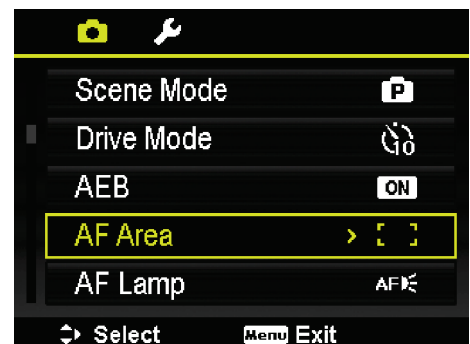

The table below shows the available AF area settings.

Icon	Item	Description
	Multi	The camera automatically selects focus area within the wide frame.
	Spot	The focus area is fixed on the center spot.

Setting the AF Lamp

The AF Lamp function allows you to record images even low light conditions.

If AF Lamp is set to Auto, the AF lamp located in the front of the camera, see "Front View" on page 9, emits a red light by half pressing the Shutter button allowing the camera to focus easily.

To set AF Lamp

1. From the Record menu, select AF Lamp.
2. Use the or keys to go through the selection.
3. Press the **OK button** to save and apply changes.

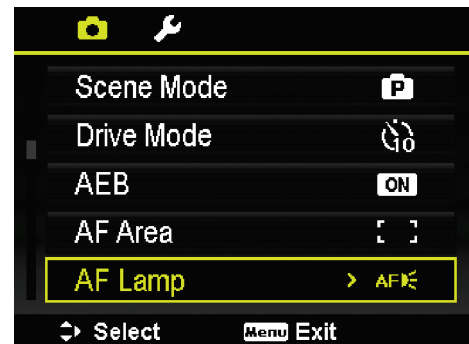

Setting Sharpness

This function allows you to enhance or soften finer details of your photos.

To set Sharpness

1. From the Record menu, select **Sharpness**.
2. Use the or keys to go through the selection.
3. Press the **OK button** to save and apply changes.

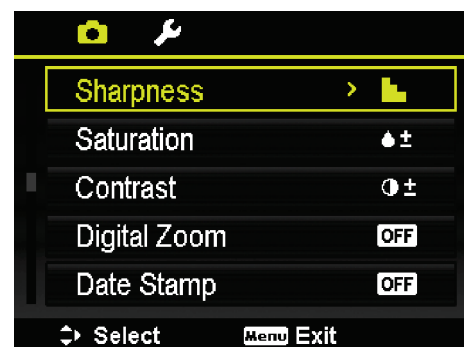



The table below shows the available Sharpness settings:

Icon	Item	Description
	High	Sharpens the image.
	Medium	Medium sharpness.
	Low	Softens the image.

Setting Saturation



The Saturation function lets you adjust the color saturation in your photos. Use a higher saturation setting for rich colors and a lower saturation setting for more natural tones.

To set Saturation

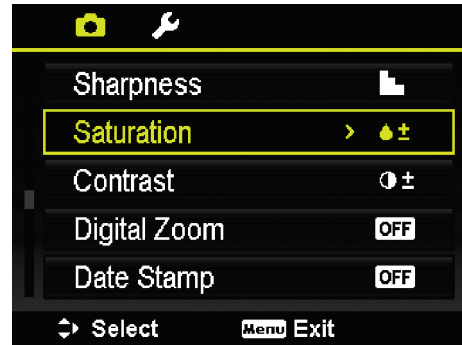
1. From the Record menu, select **Saturation**.
2. Use the  or  keys to go through the selection.
3. Press the **OK button**  to save and apply changes.





The table below shows the available Saturation settings.

Icon	Item	Description
	High	Enhance the saturation.
	Medium	Medium saturation is applied.
	Low	Reduce the saturation.



Setting Contrast

This function allows you to adjust the contrast of your photos.

To set Contrast

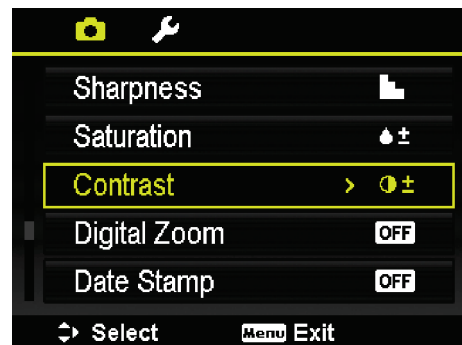
1. From the Record menu, select **Contrast**.
2. Use the  or  keys to go through the selection.
3. Press the **OK button**  to save and apply changes.



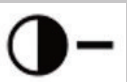

Icon	Item	Description
	High	Enhance the contrast
	Medium	Medium contrast
	Low	Reduce the contrast

Setting the Digital Zoom

This feature controls the digital zoom mode of your camera.

Your camera enlarges an image using the optical zoom first. When the zoom scale exceeds 4x, the camera uses digital zoom.



To set Digital Zoom

1. From the Record menu, select **Digital Zoom**.
2. Use the  or  keys to go through the selection.

3. Press the **OK button**  to save and apply changes.

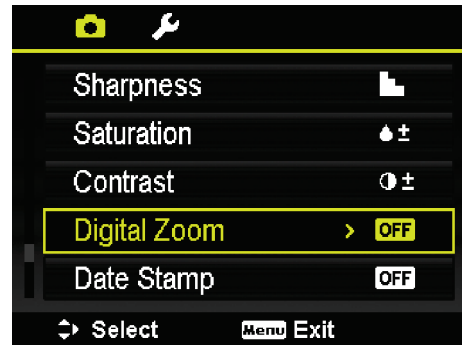
The table below shows the available Digital Zoom settings.



Icon	Item	Description
	Intelligent Zoom	Enlarges the image digitally with almost no distortion. This feature is available for still images only.
	Standard Zoom	Enlarges all image sizes up to a maximum of 5x in playback, but the image quality deteriorates.
	Off	Uses the optical zoom only.



- Digital Zoom is not available in Smile Capture, Movie, and Voice Recording modes.
- The maximum Intellect zoom scale varies depending on the image type and resolution.



Setting the Date Stamp

The date of recording can be printed directly on the still images. This function must be activated before the image is captured. Once date and time are stamped on a photo, they can no longer be edited or deleted.

Limitations of Date Stamp functions are as follows:

- Available for Photos only.
- May slow down AEB/ Burst mode when Date Stamp is enabled in AEB/ Burst mode.
- In vertical or rotated images, the date and time on your photos still appear horizontally.

To set Date Stamp

1. From the Record menu, select **Date Stamp**.
2. Use the  or  keys to go through the selection.

3. Press the **OK button**  to save and apply changes.

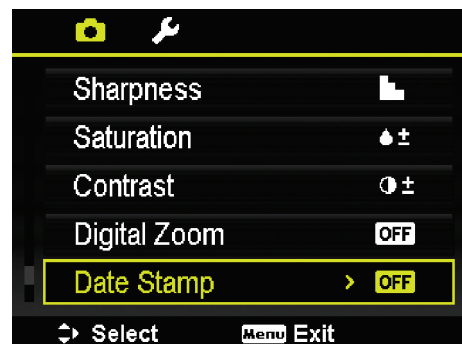



Setting Auto Review

The Auto Review function lets you view the captured image right after shooting it.

If Auto review is On, the camera will display the captured image for **1 second** on the LCD monitor.



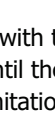

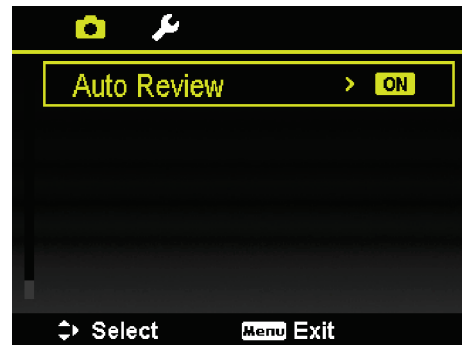
To set Auto Review

1. From the Record menu, select **Auto Review**.
2. Use the  or  keys to go through the selection.
3. Press the **OK button**  to save and apply changes.



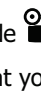
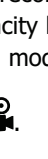

Recording Videos

Record videos with the camera, the available recording time depends on the capacity of the memory card. Videos can be recorded until the maximum memory capacity has been reached. However the length of a single video may be limited (the limitation depends on the camera model).

1. Slide the **Mode switch** to Video mode .
2. Focus your camera on the subject that you want to take.
3. Press the **Shutter button**  to start recording.
4. Use the **Zoom buttons**  to zoom in and zoom out an image.
5. To pause recording, press the key .
6. To continue recording, press the key  again.
7. To stop recording, press the **Shutter button** .

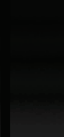

	<ul style="list-style-type: none"> • When the camera stop recording due to reaching maximum capacity (4GB) for a single video, simply press the Shutter button again to continue recording. • The camera will automatically stop recording when the memory capacity is full. • Digital zoom is not available while recording a movie. • Sound cannot be recorded while using zooms (Pressing the Zoom buttons ). • Power save is not available in movie recording or pause recording.
--	---

Settings of Recording Videos



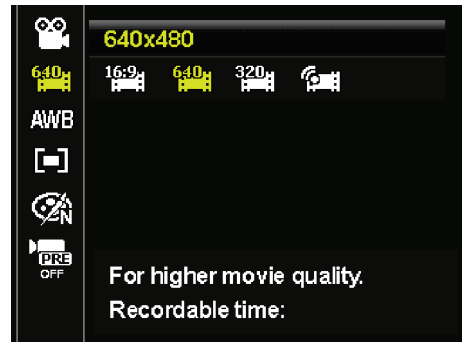

Press **Function button**  FUNC. to enable video setting menu before recording a video.

Video Size

The Video Size function appears only in Video mode. Use this function to adjust the resolution and quality of video clips.



The table below shows the available size and corresponding image quality settings:

Icon	Item	Description
	16:9	HD 720p: Please note that only the use of a class 6 SD/SDHC card will allow to record at this resolution.
	640 X 480	High Quality
	320 x 240	Normal
	Web	Optimizes video file size for Internet publishing.

Internet Mode

The Internet Mode will record videos with predefined settings for easy upload to the Internet website.

The Internet supports two file upload standards:

- Single File Uploader. The maximum movie file size is up to 100 MB.
- Internet Uploader. The maximum movie file size is up to 1 GB.

Most uploaded movie length ranges within 5 minutes.

Therefore when recording in YouTube mode, the following standards are followed:

- Recorded movies are set to Internet standard resolution of 640 X 480.
- Recording automatically stops when the file reaches 100 MB.
- To record a YouTube movie, select from the Movie Size function. Available recording time for a YouTube movie is up to 10 minutes.

White Balance, Metering, Color Mode

To set above settings, please refer to “Using the Function Menu” on page 26.

Pre-record

Catch the first three seconds of action that may would have potentially missed. Once enable this function, the camera starts recording movie automatically before pressing Shutter button. As soon as the Shutter button is hit, the most recent three seconds of video are added to the beginning of the clip.

Display the icon in red while turning Pre-record on.



	<p>Pre-record will be cancelled in the following situation:</p> <ul style="list-style-type: none">• After recording starts.• Switch to Photo mode or Playback mode.• Any kind of menu is turned on.• Enter USB mode.
---	---

Playback



Playback the still images, video and audio clips on the LCD screen.

Viewing in Single Navigation

The Single navigation mode displays the image one by one on the LCD monitor. To view images/videos/audio clips, follow the steps below.

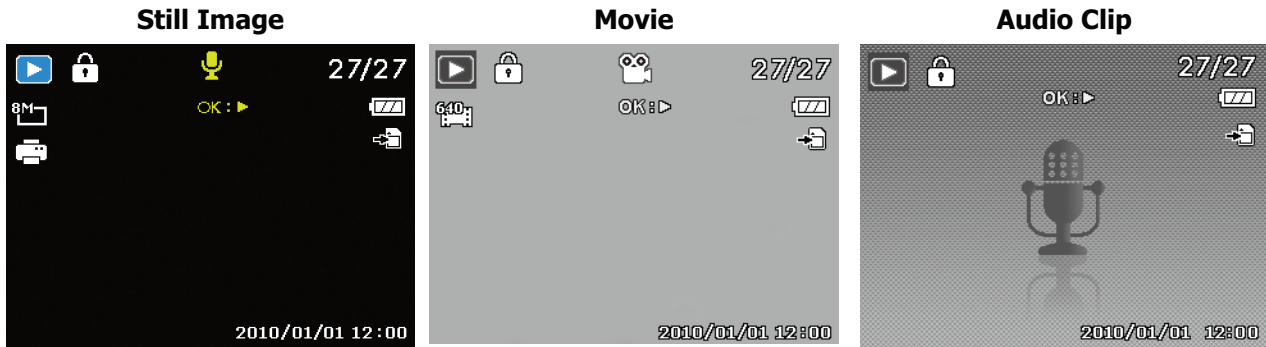
1. Slide the Mode switch to Playback mode .
2. The LCD monitor displays an image. To understand the icons and other information on the screen, please see "Photo Mode Screen Layout" on page 14.





3. Use the  or  keys to view next/previous image/video/audio.

4. To play a movie or audio clip, press the **OK button** . See "Playing Videos" on page 51 and "Playing Voice Recording" on page 52 for more details.

Viewing Thumbnails

This feature will display 9-thumbnail images or by calendar mode on the LCD monitor at the same time. Searching numerous of images is much easier than single view navigation.

To set 9-images mode



1. Set the camera to Playback mode .
2. Press the  button **once** to enter 9-images mode.
3. Use the navigation controls to move through the items.
4. Press the **OK button**  to select the image and view it normally.

Scroll bar.

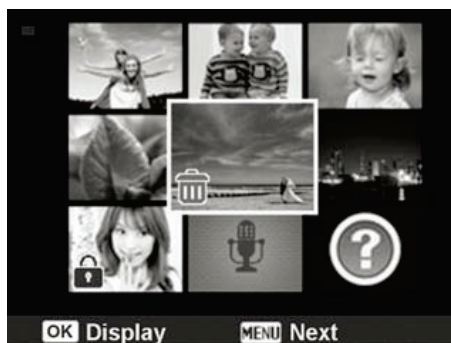

If scroll bars appear, it indicates that the screen can be scrolled.



To set calendar mode





1. Set the camera to Playback mode .
2. Press the  button **twice** to view thumbnails in calendar mode.
3. Use the navigation controls to move through the items.
4. Press the **OK button**  to select a image and view it normally.



	<p>In calendar mode:</p> <ul style="list-style-type: none"> • The first file (Including photo, video, audio and error file) recorded on each date appears on the screen. • Press the  button would back to 9-images mode.
---	---

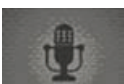

Thumbnail icons:

Thumbnails images may contain icons. These icons indicate the type of file or recording:

Icon	Item	Description
	Voice Memo	Indicates that a voice memo is attached to the image.
	Movie	Indicates a recorded movie. The image displayed is the first frame of the movie clip.
	Locked File	Indicates that the image has been locked. Locked files cannot be edited or deleted.
	Voice Record	Indicates a voice recording file.
	File Error	Indicates an error file.

Zooming images

The zoom view function works with Photos only.

- In normal view, press the  button repeatedly until the desired zoom view.
- The 4 arrows on the LCD monitor indicate that the image is zoomed in.
- Zoom to view a Photo of up to 12X.
- Use the navigation controls to view the zoomed photo.
- Press the **Menu button**  Menu to close zoom view.





















	For 320 x 240 resolution photos, they can only zoom in up to 6X.
---	--

Playing Videos



1. Set the camera to Playback mode .
2. Use the navigation controls to scroll through the saved images. A movie clip has a movie icon displayed on screen.





3. Press the **OK button**  to play the video.
4. During playback, press and hold the  or  keys to fast forward or rewind the movie. The camera supports forward and rewind speed of up to 4x.
5. During playback, use the **Zoom buttons**   to control volume. Press the  button to increase volume/Press the  button to decrease volume.
6. Press the  key to pause playback. Press the key  again to resume. When paused, the play info will remain on screen except  .
7. To forward or rewind the video frame by frame, press the key  to pause playback, then press the  or  keys.
8. Press the  key to stop the playback. The LCD monitor displays the movie frame image in Single navigation mode.

	<ul style="list-style-type: none"> • The play info, except the icon  , will be displayed when the movie is paused, during REW/FF or frame by frame modes • Volume cannot be adjusted when paused or during REW/FF modes.
--	--

To capture screenshot image from a movie clip

1. During playback of movie, press the key  to pause playback on your desired movie frame to capture.
2. Press the **Shutter button**  to capture a screenshot.
3. The camera will automatically stop playback. The LCD monitor displays the captured photo in Single navigation mode.









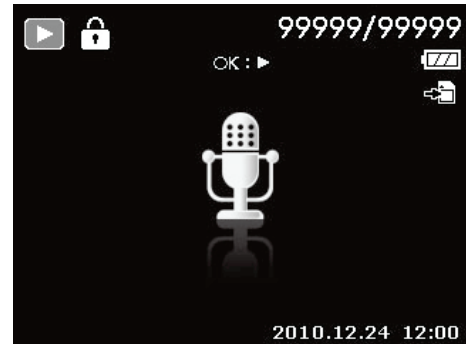

	<p>This feature does not function when the memory card is full or the folder cannot be created. The icon  does not appear on the screen either.</p>
---	--

Playing Voice Recording

1. Set the camera to Playback mode .
2. Use the navigation controls to scroll through the saved images. When viewing a voice recording file, the LCD monitor displays the screen layout of Audio clips. See picture on the right.



3. Press the **OK button**  to play the voice recording.
4. During playback, use the **Zoom buttons**  to control volume. Press the  button to increase volume/Press the  button to decrease volume.
5. Press the  key to pause playback. Press the  key again to resume. When paused, the play info will remain on screen except **WT** .
6. Press the  key to stop the playback. The LCD monitor displays the image in Single navigation mode.

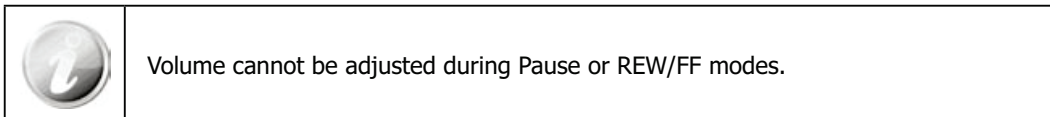









Playing Voice Memo

Voice memo is separately recorded and attached to a captured image. See "**Voice Memo**" on page 56 on how to record voice memo.

1. Set the camera to Playback mode .
2. Use the navigation controls to scroll through the saved images. An image file with voice memo has a voice memo icon located on the top center of the LCD monitor. See picture on the right.



3. Press the **OK button**  to play the voice recording.
4. During playback, use the **Zoom buttons**  to control volume. Press the  button to increase volume/Press the  button to decrease volume.
5. Press the key  to pause playback. Press the key  again to resume. When paused, the play info will remain on screen except **WT** .
6. Press the key  to stop the playback. The LCD monitor displays the image in Single navigation mode.

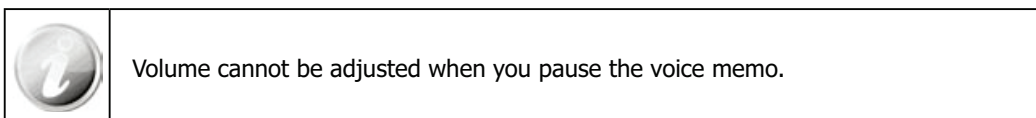





Deleting an Image/Video/Audio

There are two ways to delete an image/video/audio:



- Using the Delete button.
- Using Playback Menu Delete settings. See "**Delete**" on page 53.

Using the Delete Button

	<p>Use the Fn/Delete button on your camera to delete or mark an image/video/audio clip for deletion.</p>
---	--

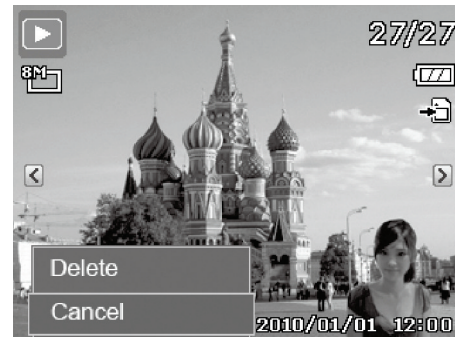
1. Set the camera to Playback mode .
2. View images/videos/audio clips in Single navigation mode.
3. Use the  or  keys to scroll the display.
4. When the desired image/video/audio clip is displayed on the LCD monitor, press the **Fn/Delete**  **FUNC.** button.
5. A confirmation selection appears on screen.
6. Select **Delete**.









7. Press the **OK button**  to delete.
8. The next image is displayed on the LCD monitor. To delete another file, use the  or  keys to scroll through the images/videos/audio clips. Then, repeat steps 5 to 7.
9. To close the Delete function and go back to the single navigation mode, select Cancel.

	<p>Locked files cannot be deleted at any time. When you try to delete a locked file, the camera displays "File Locked" message on the LCD monitor.</p>
---	--

Playback Menu

The Playback menu allows you to edit images, record voice memo, and setup playback settings.

To go to Playback Menu:

1. Slide the mode switch to Playback mode .
2. Press **Menu button**  to launch the Playback Menu.
3. Use the  or  keys to move through the menu selections.
4. To select a menu, press  or the **OK button** .
5. Change the submenu settings using the 4-way navigation control.
6. Press the **OK button**  to save and apply settings.

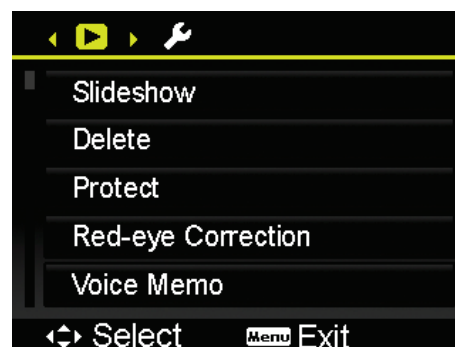





Slideshow









The slideshow function enables you to playback your still images automatically in order one image at a time.

To view slideshow:

1. From the Playback menu, select Slideshow. The Slideshow menu appears.
2. Set the slideshow settings.

3. Select **Start**, then press the **OK button**  to start the slideshow.
4. During slideshow, press the **OK button**  to pause slideshow.
5. Use the  or  keys to move through the options. Select whether to **Continue** or **Exit** the slideshow.
6. Press the **OK button**  to apply selected option.

To change slideshow settings:

1. From the Slideshow menu, use the  or  keys to move through the selections.
2. Select Interval setting. Press the  or  keys to adjust. Choose among the available interval settings: 1 sec., 3 sec., 5 sec., and 10 sec.
3. Select Transition setting. Press the  or  keys to adjust. Choose among the available transition settings:
 - Horizontal
 - Shrink
 - Fade
 - Random
4. Select Repeat setting. Press the  or  keys to adjust. Available settings are: Yes, No.

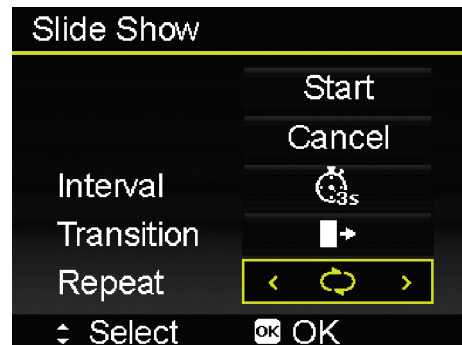

Delete



The Delete function allows to remove unwanted files in the internal memory or on the memory card. Protected files cannot be erased, to delete, unprotect the file first. See "Protect" on page 55.

To delete a image/video/audio clip:

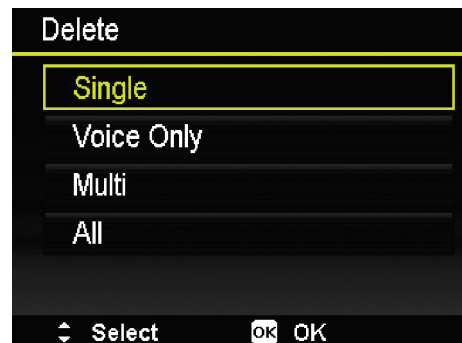
1. From the Playback menu, select **Delete**.
2. The Delete submenu is displayed on the LCD monitor. Available select settings:
 - **Single**. Select one file to delete.
 - **Voice Only**. Delete only the attached voice memo, not voice clips. The image is still retained in the memory.
 - **Multi**. Select multiple files to delete at the same time.
 - **All**. Delete all files.





To delete a single file:



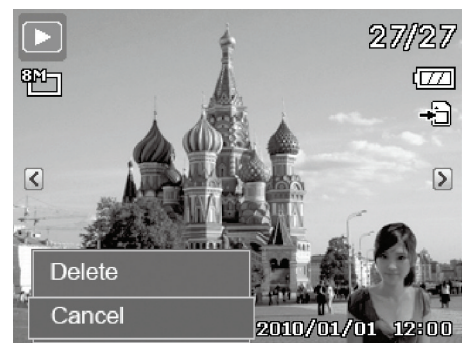



1. Select **Single** in the Delete submenu, the images are displayed on the LCD monitor in single navigation mode.
2. Use the  or  keys to scroll the display.
3. When the desired image/video/audio clip is displayed on the LCD monitor, select **Delete**.

4. Press the **OK button**  to delete.





5. The next image is displayed on the LCD monitor. To delete another file, use the  or  keys to scroll through the images/videos/audio clips. Repeat steps 3 to 4.
6. To close the Delete function and go back Playback menu, select **Cancel**.

To delete attached voice memo:

1. Set the camera to Playback mode .
2. View images/videos/audio clips in Single navigation mode.
3. Use the  or  keys to scroll until the desired image with voice memo is displayed on the screen.
4. Press **Menu button**  to launch the Playback Menu.
5. Use the  or  keys to move through the Playback menu selections then select **Delete**.
6. From the Delete submenu, select **Voice only**.
7. A confirmation selection appears, select **Delete**.



8. Press the **OK button**  to delete the attached voice memo and go back to Playback mode.

	The Voice Memo submenu is disabled if the current image displayed, at the time you access the Delete menu, does not have any attached voice memo.
---	---

To delete multiple files:

1. Select **Multi** in the Delete submenu, the images are displayed in thumbnail view on the LCD monitor.
2. Use the navigation control to move through the files.
3. When the desired image/video/audio clip is highlighted, press the **OK button**  to mark image/video/audio clip for deletion.
4. Repeat step 3 until all desired images for deletion are marked.

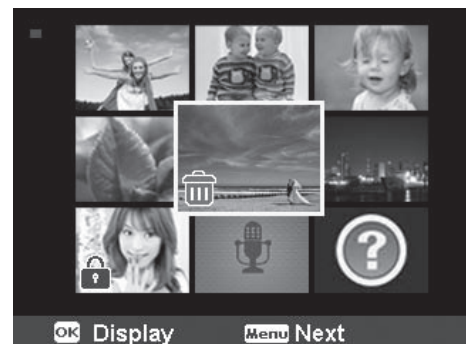

5. Press the **Menu button** . A confirmation selection appears.
6. Select Yes to confirm.

7. Press the **OK button**  to delete marked files.

To delete all files:

1. Select **All** in the Delete submenu. A confirmation message appears.
2. Select **Yes**.

3. Press the **OK button**  to delete all files.

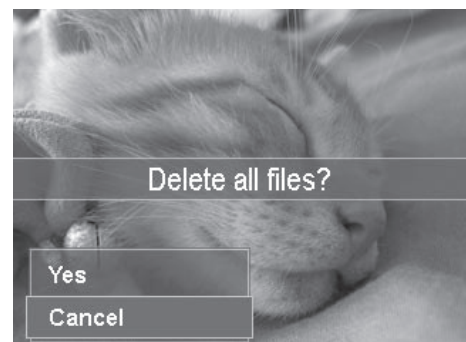

Protect

Set the data to read-only to prevent images from being erased by mistake.



A protected file has a lock icon  when viewed on Playback mode.

To protect files:

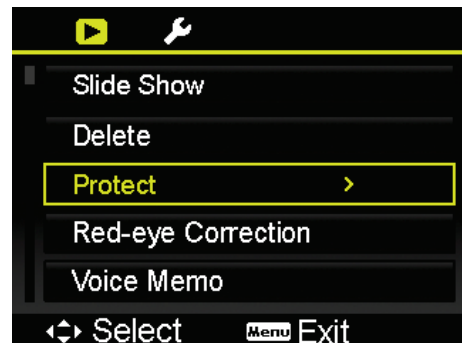
1. From the Playback menu, select **Protect**.
2. The Protect submenu is displayed on the LCD monitor.
Available select settings:
 - **Single**. Select one file to lock.
 - **Multi**. Select multiple files from the thumbnail view to lock.
 - **Lock All**. Lock all files
 - **Unlock All**. Unlock all files.



To protect/unprotect a single file:

1. Select **Single** in the Protect submenu, the images are displayed on the LCD monitor in single navigation mode.
2. Use  or  keys to scroll the display.
3. When the desired file is displayed on the LCD monitor, select **Lock/Unlock**.

4. Press the **OK button**  to protect/unprotect the file and go back to Playback mode.

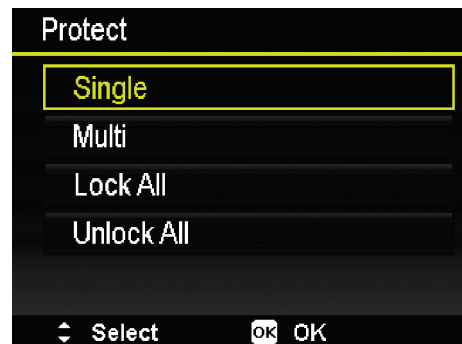

To protect/unprotect multiple files:

1. Select Multi in the Protect submenu, the images are displayed in thumbnail view on the LCD monitor.
2. Use the navigation control to move through the files.
3. When the desired file is highlighted, press the **OK button**  to mark/unmark the file clip for protection.
4. Repeat step 3 until all desired files to protect are marked.

5. Press the **Menu button** . A confirmation selection appears.
6. Select **Yes**.

7. Press the **OK button**  to lock files and go back to Playback mode.

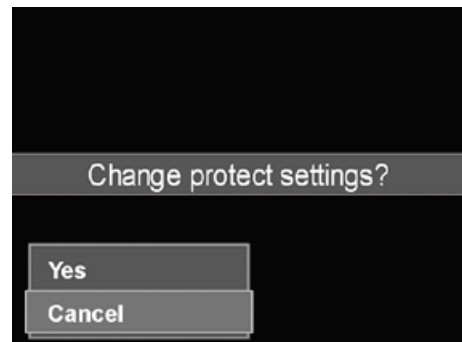

To protect all files:

1. Select **Lock all** in the Protect submenu. A confirmation message appears.
2. Select **Yes**.

3. Press the **OK button**  to lock all files.

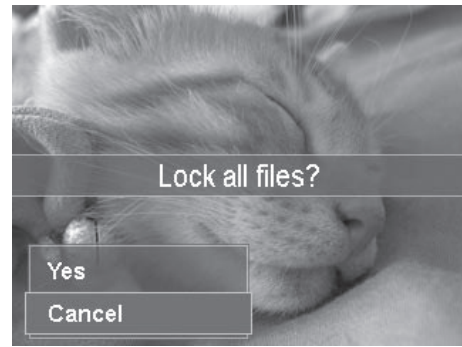

To unlock all files:

1. Select **Unlock all** in the Protect submenu. A confirmation message appears.
2. Select **Yes**.



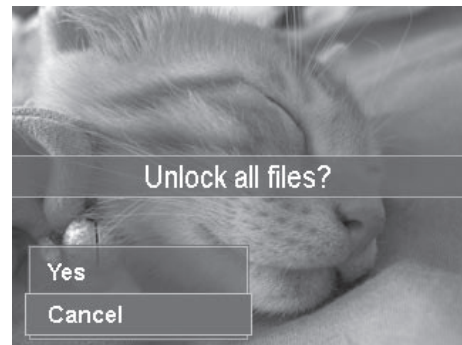

3. Press the **OK button**  to unlock all protected files.





Red-eye Correction

The Red-eye Correction function is used to reduce red eye in captured images. This function is only available for still images. Red-eye correction can be applied to an image several times, but the quality may gradually deteriorate.

To activate Red-eye Correction:

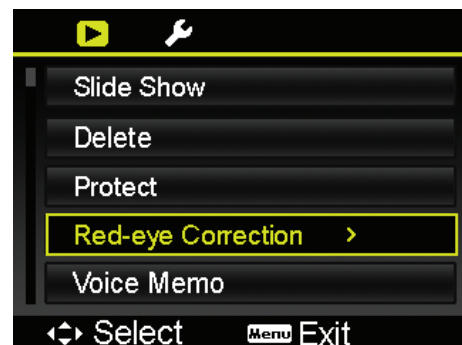
1. Set the camera to Playback mode .
2. Press the  or  keys to scroll and select an image.
3. Press the **Menu button**  Menu to launch the Playback menu.
4. Select **Red-eye Correction**.
5. Select **Start**.





6. Press the **OK button**  to start correction.
7. After completing Red-eye correction, a menu selection appears. Select whether to:
 - **Overwrite**. Save and replace old file with a new one.
 - **Save As**. Save the new file as a new one.
 - **Cancel**. Cancel red-eye correction.



8. Press the **OK button**  to save/cancel changes.

Voice Memo

A maximum of 30 seconds of audio can be recorded as a memo for captured still images.

To record voice memo:

1. Set the camera to Playback mode .
2. Press the  or  keys to scroll and select an image to attach voice memo to.

3. Press the **Menu button**  Menu to launch the Playback menu.
4. Select **Voice Memo**.
5. Select Start, then press the **OK button**  to start recording.
6. Press the **OK button**  again to stop recording.

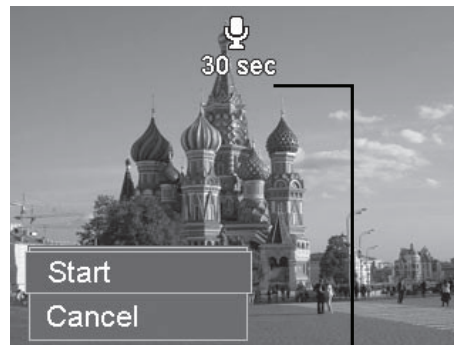
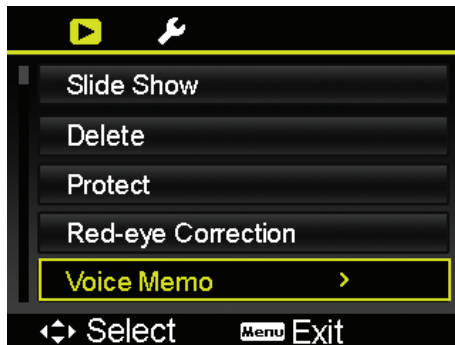





Time left (n seconds) for recording.

 When recording a voice memo to an image with an existing voice memo, the old recording file would be replaced by the new one.



Color Mode

The Color Mode function lets you adjust edit still images to apply different colors or tones for a more artistic effect. Edited photos in this function are saved as a new file.

To activate Color Mode:

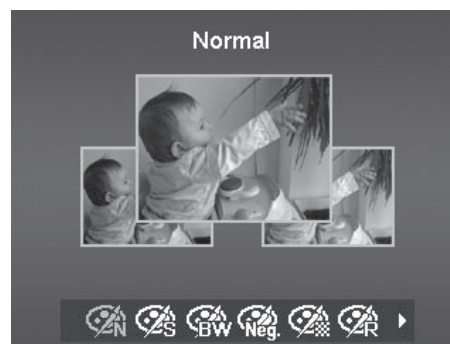
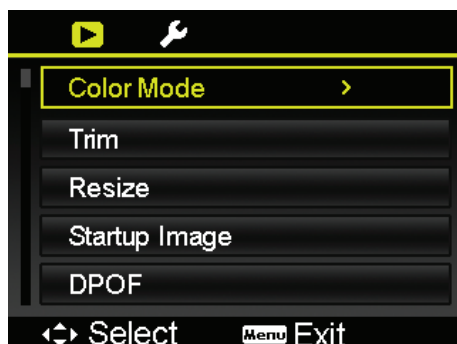
1. Set the camera to Playback mode .
2. Press the  or  keys to scroll and select an image to edit.
3. Press the **Menu button**  Menu to launch the Playback menu.
4. Select **Photo Edit**. The Photo Edit submenu appears.



5. Press the  or  keys to scroll and select an option. As you move through the selection, the preview on the LCD monitor changes synchronously.





The succeeding table shows the available settings.

Icon	Item	Description
	Normal	No effect is added to the image.
	Sepia	Image is saved with a sepia tone.
	B&W	Image is saved in black and white.
	Negative	Image appears to be the opposite of the original image.
	Mosaic	Image is saved with mosaic tiles.
	Vivid Red	Image is saved with reddish tint.
	Vivid Green	Image is saved with greenish tint.
	Vivid Blue	Image is saved with bluish tint.

Trim

The Trim function allows you to trim an image to another image size. This function is only available for still images.

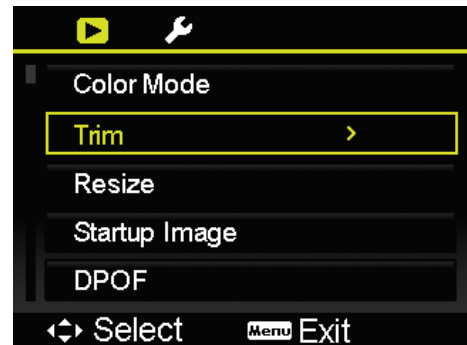

To trim an image:

1. Set the camera to Playback mode.
2. Use the  or  keys to scroll and select an image to trim.
3. Press the **Menu button**  Menu to launch the Playback menu.
4. Select **Trim**. The Trim screen layout is displayed on the LCD monitor.
5. Use the **Zoom buttons**  to change size as zoom in/out.



No.	Description
1	Enlarged image
2	4-way indicator
3	Trimmed size
4	The approx. location of the trimmed area
5	Image area







6. Use the navigation controls to move the image.
7. Press the **OK button**  to apply changes. A menu selection appears.
8. Select whether to:
 - **Overwrite.** Save and replace the old file with the new one.
 - **Save As.** Save the new file as a new one.
 - **Cancel.** Cancel resize.
9. Press the **OK button**  to save/cancel changes.

	<ul style="list-style-type: none"> • Trim function is not available for photos with image size set to VGA. • All images will be trimmed in 4:3 ratio regardless of its original image ratio.
---	--

Resize

Resizes a previously saved image and only resizing to a smaller size is available.

To resize an image:



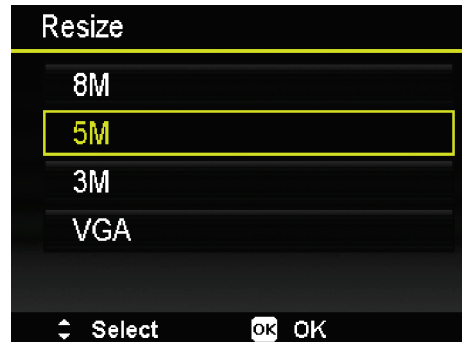

1. Set the camera to Playback mode .
2. Use the  or  keys to scroll and select an image to resize.
3. Press the **Menu button**  Menu to launch the Playback menu.
4. Select **Resize**. The Resize submenu is displayed on the LCD monitor.
5. Select size among: 8M, 5M, 3M, and VGA. Available size settings may vary depending on original image size. Unavailable settings appear as gray icons in Resize submenu.
6. After selecting size, a menu selection appears. Select whether to:
 - **Overwrite**. Save and replace old file with a new one.
 - **Save As**. Save the new file as a new one.
 - **Cancel**. Cancel resize.
7. Press the **OK button**  to save/cancel changes.





	Resize function is not available for photos with image size set to VGA.
---	---

Startup Image

Specify the startup image from the captured images for camera.

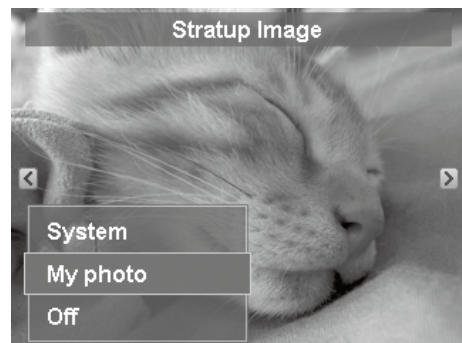
1. Press the **Menu button**  Menu to launch the Playback menu.
2. Select **Startup Image**. The menu selection appears.
3. Select options:
 - **System**. Use camera default image.
 - **My Photo**. Use the  or  keys to scroll and select desired image.
 - **Off**. Disable the startup image.
4. Press the **OK button**  to apply changes.



	The startup image will still be displayed startup even if the selected image was deleted.
---	---

DPOF



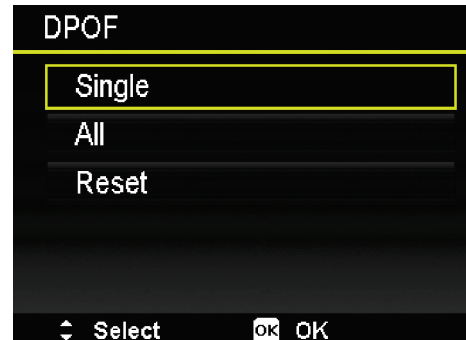

DPOF is the abbreviation for Digital Print Order Format, which allows you to embed printing information on your memory card. You can select the images to be printed and how many prints to make with the DPOF menu in the camera and insert the memory card to the card compatible printer. When the printer starts printing, it will read the embedded information on the memory card and print the specified images.

To set DPOF:

1. Press the **Menu button**  to launch the Playback menu.
2. Select **DPOF**. The submenu appears. Available settings are as follows:
 - **Single**. Select a single image to mark.
 - **All**. Mark all images in the memory card.
 - **Reset**. Reset all DPOF settings to initial default settings.



To set DPOF on a single image/all images:

1. Select **Single** or **All** on the DPOF submenu.
2. For single image, use the  or  keys to scroll and select an image to mark for printing.
3. Specify the number of copies. Use the  or  to increase/decrease number.
4. Press the  **FUNC.** button to toggle between turning on/off the date stamp.



5. Press the **OK button**  to save DPOF settings.

To reset DPOF:

1. Select **Reset** on the DPOF submenu. A confirmation message appears.
2. Select **Yes**.
3. Press the **OK button**  to reset DPOF settings.



PictBridge

The PictBridge function allows you to print images captured by your camera without connecting the camera to a PC. Print images with a PictBridge compatible printer directly.

To activate PictBridge:

Connect your camera to a PictBridge compatible printer using the USB cable. See illustration below.

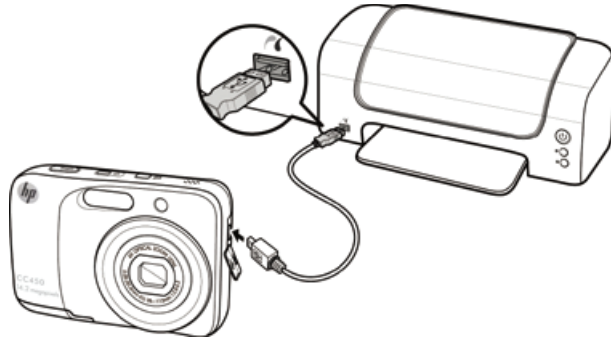

If the printer does not support date & time imprint, the date & time imprint function will be disabled in PictBridge.

Radial Blur

The Radial Blur is an effect creates blurs around a point, simulating the result of a zooming or rotating camera.

To set Radial blur for an image:

1. Use the **|<** or **>|** keys to specify the level of blurs. The adjusting result on preview synchronously while selecting the level.

2. Press the **OK button**  to proceed save options.

3. Available settings are as follow:

- **Overwrite.** Save and replace the old file with a new one.
- **Save As.** Save the new file as a new one.
- **Cancel.** Cancel Radial blur.

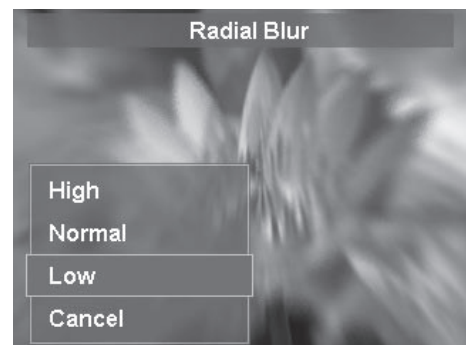









Using the Setup Menu

You can access the Setup menu whether you are in Record or Playback mode.

The Setup menu allows to configure general camera settings.

To go to Setup Menu:

1. Press **Menu button**  to launch the Record/Playback Menu.
2. Use the  or  keys to switch the menu tab to **Setup** menu.
3. Use the  or  keys to move through the menu selections.
4. To select an item, press the **OK button**  or  key.
5. Change the submenu settings using the 4-way navigation control.
6. Press the **OK button**  to save and apply settings.

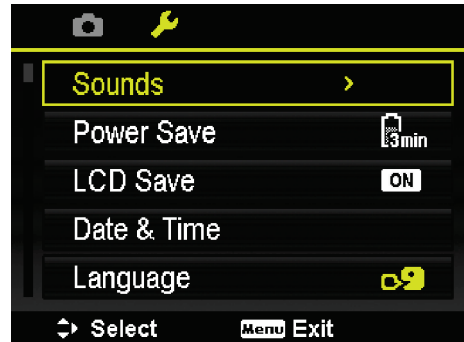

Setting Sounds

Use the Sound menu functions to control the sounds produced by the camera.

1. From the Setup menu, select **Sounds**.
2. Adjusts sound settings.
3. Press the **OK button**  to apply changes.

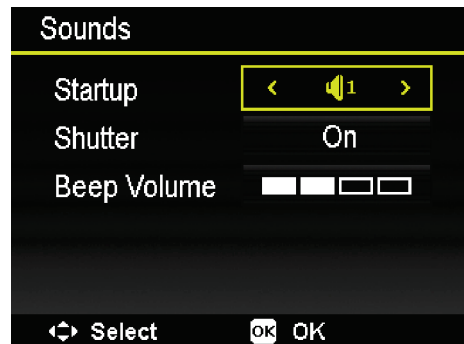

Item	Available Settings	Description
Startup	Sound 1, Sound 2, Sound 3, Off	Selects the startup sound when camera is turned on.
Shutter	On, Off	Enables or disables shutter sound when Shutter button is pressed. Shutter sound is not available when recording movies or voice clips.
Beep Volume	0-4	Adjusts volume.

Setting Power Save

The Power Save function allows you to set an idle time after which the camera automatically sets to sleep mode to save power. After a minute of being in sleep mode, the camera eventually turns off power.

This function is not available in the following instances:

- Recording a movie or audio file
- Playing a slideshow/video/audio file
- Using the USB connector

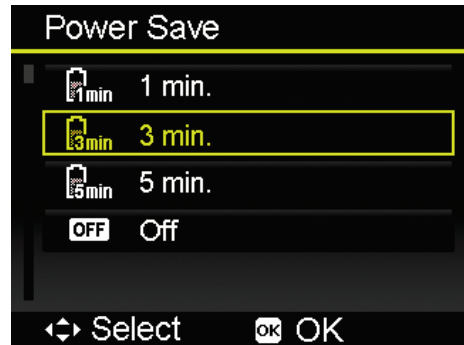

Setting LCD Save

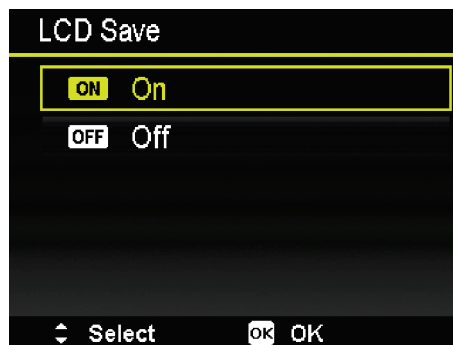

Enable the LCD Save function to automatically decrease the LCD brightness to conserve battery power. When the camera is idle for 20 seconds, the LCD darkens. Press any button to resume to normal brightness.

- The camera is idle when no buttons are pressed. LCD Save, though enabled, does not function during video playback, slideshow, video recording and Pre-Composition scene mode shooting.



Setting Date & Time

Use the Date & Time function to set the date and time of your camera. This function is useful in attaching date stamps on captured images. Your camera uses a 24-hour time format.

1. Press the navigation controls to adjust date and time value. By holding down the  or  keys, the numeric values changes continuously.

2. Press the **OK button**  to apply changes.

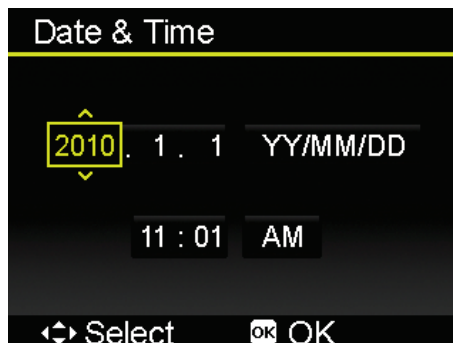

Setting Language

Specify in which language menus and messages are to be displayed on the LCD monitor.

1. Use the navigation control to scroll through the list and select the desired language.

2. Press the **OK button**  to confirm and apply settings.



Setting File Numbering

This function allows you to select the method in which to assign file numbers to images.

Available settings are:

- **Series.** Assigns number to files in sequence even if the folder is changed.
- **Reset.** Starts from 0001 each time the folder is changed.

To understand folder and file structure of your camera, see "About Folder and File Names" on page 72.

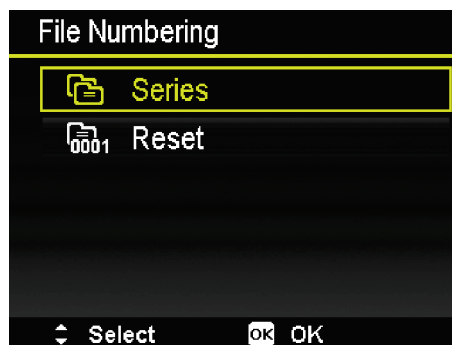

Setting TV Out

Use the TV Out function to adjust video output signal to accommodate different regional settings. If TV out is not set correctly, the image may not display properly on TV.

Available settings are:

- **NTSC.** Applicable in Japan, USA, Canada, Taiwan and others.
- **PAL.** Applicable in Europe, Asia (excluding Taiwan), Oceania and others.

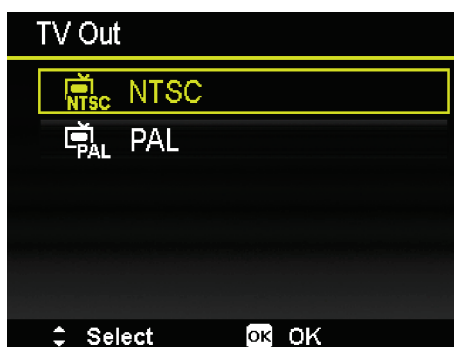

Setting LCD Brightness

Select a brightness level for the LCD monitor.

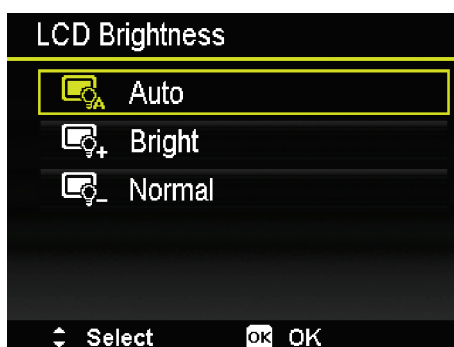

Setting Memory Kit

This utility formats the internal memory (or memory card) and erases all stored images and data.

Available settings are:

- **Format.** Select to format currently used memory.
- **Copy to Card.** Select to copy all files stored in the internal memory to the memory card.

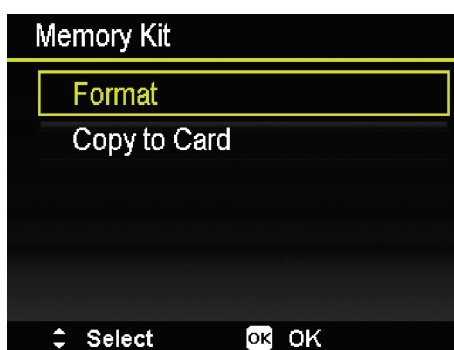

- If the photos were saved in the internal memory when inserting memory card into the camera. You can use **Copy to Card** function in order to copy all photos from the internal memory into memory card.
- If there is a memory card inserted in the memory slot, the camera automatically saves all files to the memory card.
- If there is no memory card or the internal memory is empty, the **Copy to Card** function is disabled.

Reset All

Use this function to reset the camera to its factory settings. However, the following settings are exceptions and not affected by Reset.

- Date and Time
- Language
- TV Out
- Custom White Balance data



Making Connections

Connect your camera to: computer, or a printer.

Connecting the Camera to a PC

You can transfer images, videos and audio files to your PC.

1. Connect one end of the USB cable to an available USB port on your computer.
2. Connect the other end of the USB cable to the USB terminal on the camera.
3. Power on the camera.

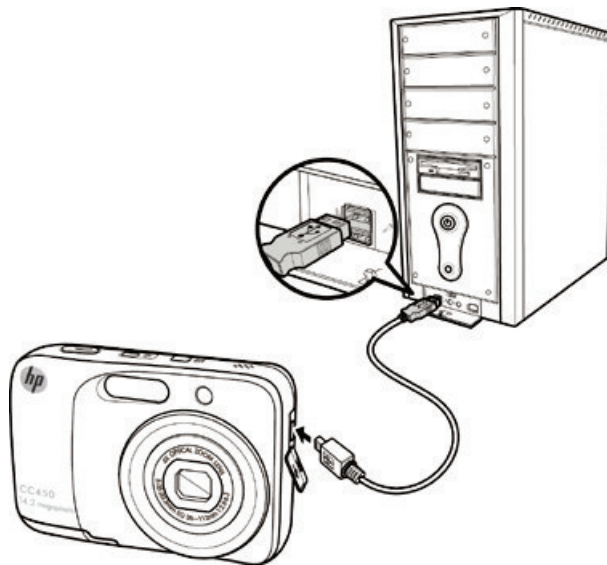

4. The USB mode menu appears on the screen. Select **Computer** by using the  or  key and press the **OK**

button  .

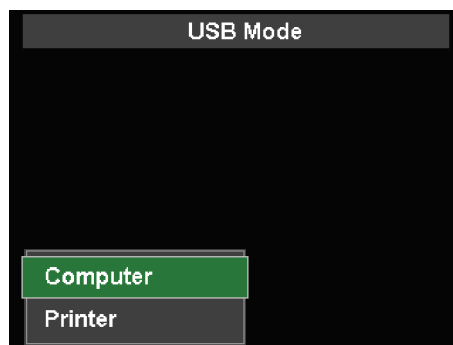

5. The PC starts to detect the connection while the LCD monitor appears **Connecting....**



6. Connection established after **PC MODE** appeared on the LCD monitor.
7. Access the files in the camera by your PC.

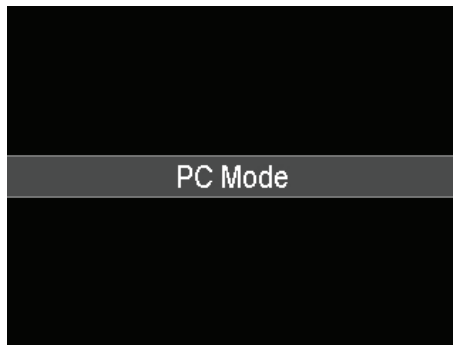



	<ul style="list-style-type: none">• The camera's internal memory and memory card would display as removable drives in PC.• After the connection, no image is displayed on the LCD monitor.
---	---

Connecting the Camera to a Printer

Print your photos directly using a **PictBridge compatible** printer.

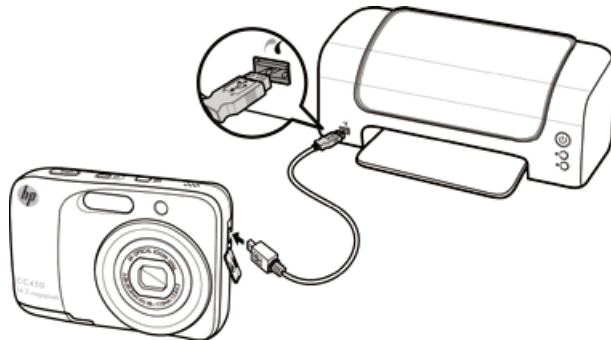
1. Turn on your Printer. Check that the printer is turned on, there is paper in the printer, and there are no printer error messages.
2. Connect one end of the USB cable to the printer while the other end to USB terminal on the camera.



3. The USB mode menu appears on the screen. Select **Printer** by using the  or  key and press the **OK** button .
4. Enter the print mode and print the selected images.

For details on the following page "**Setting the Print Mode Menu**".

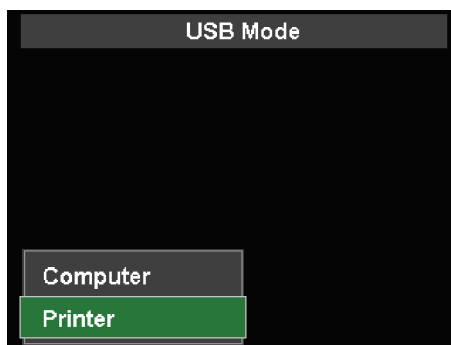

Setting the Print Mode Menu





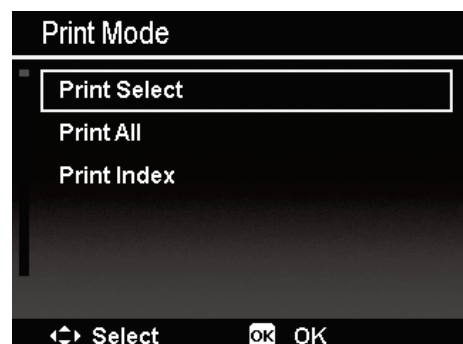

Print Mode menu appears on the screen after the connection between a printer and your camera is established.

Print Mode includes three major settings:

- **Print Select.** An image can then be selected to print.
- **Print All.** Prints all images.
- **Print Index.** Prints all images as thumbnails.



To set Print Select





1. Use the  or  keys to scroll and select an image for printing.
2. Specify the number of copies. Use the  or  key to increase/decrease number.
3. Press the **FUNC button**  **FUNC.** to toggle between turning on/ off the date stamp.
4. Press the **OK button**  to enter printer settings.



To set Print All and Print Index

Repeat the same steps 2 to 4, then enter printer settings.

To set Printer Settings

1. Use the  or  key to specify a print option.
2. Modify paper size and quality by the  or  keys. Available setting:
 - **Paper size:** Default / A4 / 4"x 6"
 - **Quality:** Default / Fine / Normal
3. Select **Print** on the screen for printing. Or **Cancel** to go back Print Mode.

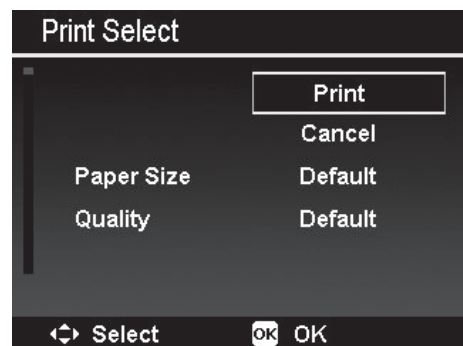

Start Printing

- LCD monitor appears "Now printing...".
- Or press **Menu button**  **Menu** to stop printing anytime.



After the printer has printed all the photos that had been selected, disconnect the camera from the printer.

Appendix

About Folder and File Names

Your camera automatically creates specific directory of folder in the internal memory cards to organize captured images, videos and audio files.

File Naming

File names begin with "HPIM" and followed by a 4-digit number that increases in sequence. File numbering starts from 0001 when a new folder is created.

If the highest folder number is 999 and the highest file number exceeds 9999, the camera will display the warning message "**Folder cannot be created**". When this happens, try one of the following ways:

- Reset the file number. See "**Setting File Numbering**" on page 66.
- Plug in a new memory card.



Do not change the folder and file names in the memory card using your PC. It may be unable to playback the data using the camera.

Troubleshooting

Problem	Cause and/or Action
Camera does not turn on.	One or both of the batteries may be exhausted. Replace the batteries.
Camera turns off automatically.	Press any button except the Power button to power on the camera.
LCD turns blank.	Press any button except the Power button to turn on the LCD.
Empty battery icon is displayed on the LCD, and then the camera turns off.	One or both of the batteries may be exhausted. Replace the batteries.
LCD screen displays 'No images in memory'.	The image file on the memory card. Image file format may not be supported.
LCD screen displays 'Not available for this file'.	Function is only available for specific file types. File format is not supported.
LCD screen displays 'Memory full'.	Memory card is full. Replace the memory card with a new one or delete unnecessary images.
LCD screen displays 'File locked'.	This file is locked. Unlock the file.
LCD screen displays 'Card locked'.	The memory card is protected. Remove the card and slide the write-protect switch to its unlock position.
LCD screen displays 'CARD HAS WRONG FORMAT'.	The memory card is protected. Remove the card and slide the write-protect switch to its unlock position.
LCD screen displays 'Copy error'.	The memory card is protected. Remove the card and slide the write-protect switch to its unlock position. The memory card is full. Replace card or delete unnecessary files.
The lens is extended and will NOT retract.	Do not force the lens to go back. The type of the battery used may be incorrect or the battery power level is too low. Change the battery or charge the battery before using the camera.

Getting Help

Should you have a technical support question or your HP Digital Camera require service within the warranty period, please contact the original point of purchase or an authorized HP reseller in your country. If service is not available at those locations, please contact an HP Branded Product warranty agent from the support contact list provided below. A service agent will work with you to troubleshoot your issue and if necessary, issue a Return Material Authorization (RMA) number in order to replace your HP Branded Product. For warranty claims, you will be required to provide a copy of your original dated sales receipt as proof of purchase and the issued RMA number. You will be responsible for shipping charges when shipping the product to the service center. The service agent will provide you with an address and you will also be responsible for any shipping charges to the warranty service center. Once your product is received by this service center, a replacement unit will be shipped back to you typically within 5 business days.

Contact/phone Support:	
Language	Contact/phone Support:
繁體中文	simp.chinese@hpodd.com
	trad.chinese@hpodd.com
Deutsch	deutsch@hpodd.com
Nederlands	hollands@hpodd.com
English	english@hpodd.com
Español	espanol@hpodd.com
Français	francais@hpodd.com
Italiano	italiano@hpodd.com
日本語	nippon@hpodd.com
한국어	korean@hpodd.com
Português	portugues@hpodd.com
Svenska	svensk@hpodd.com

Contact/phone Support:			
Country	Language	Number	
Europe Region (EMEA)			
België	Nederlandsk/ Deutsch	+ 32 2700 1724	
Deutschland	Deutsch	+ 49 6950073896	
España	Español	+ 34 914533458	
France	Français	+ 33 171230454	
Ireland	English	+ 353 1850882016	
Italia	Italiano	+ 39 269682189	
Nederland	Nederlandsk	+ 31 202015093	
Schweiz	Deutsch/ Français/ Italiano	+ 41 18009686	
UK	English	+ 44 2073652400	
North America			
United States	English	1.866.694.7633	
Canada	English and Français	1.866.694.7633	
Country	Language	City	Number
México	Español	Mexico City	52.55.1204.8185
		Guadalajara	52.33.1031.3872
		Monterrey	52.81.1107.2639
Venezuela	Español	Caracas	58.212.335.4574
Colombia	Español	Bogota	57.1.508.2325
Perú	Español	Lima	51.1.705.6232
Chile	Español	Santiago	55.11.5504.6633
Brasil	Português	Sao Paolo	55.11.5504.6633
Argentina	Español	Buenos Aires	54.11.6091.2399

