

At your side.  
**brother**®

# USER'S GUIDE

MFC-210C

MFC-410CN



At your side.  
**brother**®

## **If you need to call Customer Service**

**Please complete the following information for future reference:**

**Model Number: MFC-210C and MFC-410CN**  
**(Circle your model number)**

**Serial Number:\* \_\_\_\_\_**

**Date of Purchase: \_\_\_\_\_**

**Place of Purchase: \_\_\_\_\_**

**\* The serial number is on the back of the unit. Retain this User's Guide with your sales receipt as a permanent record of your purchase, in the event of theft, fire or warranty service.**

**Register your product on-line at**

**<http://www.brother.com/registration>**

By registering your product with Brother, you will be recorded as the original owner of the product.

THIS EQUIPMENT IS DESIGNED TO WORK WITH A TWO WIRE ANALOGUE PSTN LINE FITTED WITH THE APPROPRIATE CONNECTOR.

## **APPROVAL INFORMATION**

---

Brother advises that this product may not function correctly in a country other than where it was originally purchased, and does not offer any warranty in the event that this product is used on public telecommunication lines in another country.

## **Compilation and Publication Notice**

---

Under the supervision of Brother Industries Ltd., this manual has been compiled and published, covering the latest product descriptions and specifications.

The contents of this manual and the specifications of this product are subject to change without notice.

Brother reserves the right to make changes without notice in the specifications and materials contained herein and shall not be responsible for any damages (including consequential) caused by reliance on the materials presented, including but not limited to typographical and other errors relating to the publication.



“EC” Declaration of Conformity

Manufacturer

Brother Industries, Ltd.  
15-1, Naeshiro-cho, Mizuho-ku,  
Nagoya 467-8561, Japan

Plant

Brother Industries (Shen Zhen) Ltd  
G02414-1, Bao Chang Li Bonded  
Transportation Industrial Park,  
Bao Long Industrial Estate,  
Longgang, Shenzhen, China

Herewith declare that:

Products description: Facsimile Machine  
Type: : Group 3  
Model Name : MFC-210C, MFC-410CN

is in conformity with provisions of the R & TTE Directive (1999/5/EC) and we declare compliance with the following standards :

Standards applied :

Harmonized :

Safety : EN60950:2000

EMC : EN55022:1998 Class B

EN55024:1998

EN61000-3-2:2000

EN61000-3-3:1995

Year in which CE marking was First affixed : 2004

Issued by : Brother Industries, Ltd.

Date : 25th February, 2004

Place : Nagoya, Japan

Signature :

Takashi Maeda

Manager

Quality Management Group

Quality Management Dept.







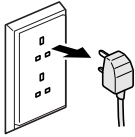

Information & Document Company

# Safety precautions

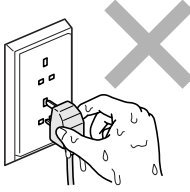
## To use the MFC safely

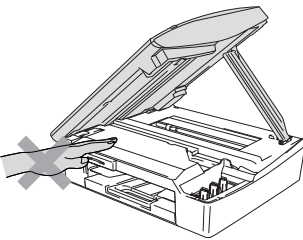
Please refer to these instructions for later reference and before attempting any maintenance.

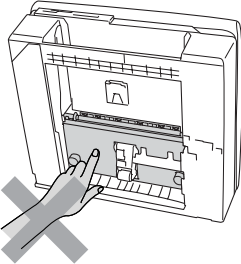
### WARNING

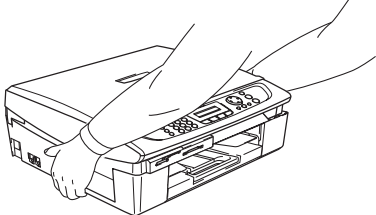
	<p>There are high voltage electrodes inside the MFC. Before you clean the MFC, make sure you have unplugged the telephone line cord first and then the power cord from the electrical socket.</p> 		<p>Do not handle the plug with wet hands. Doing this might cause an electrical shock.</p> 
	<p>To prevent injuries, be careful not to put your hands on the edge of the MFC under the scanner cover.</p> 		<p>To prevent injuries, be careful not to touch the area shaded in the illustration.</p> 
	<p>When you move the MFC, place a hand at each side of the unit so you are supporting the base when you lift it. (See the illustration on the right.) Do not carry the MFC by holding the scanner cover.</p> 		

 **WARNING**

- Use caution when installing or modifying telephone lines. Never touch telephone wires or terminals that are not insulated unless the telephone line has been disconnected at the wall socket. Never install telephone wiring during a lightning storm. Never install a telephone wall socket in a wet location.
- This product must be installed near an electrical socket that is easily accessible. In case of emergencies, you must disconnect the power cord from the electrical socket in order to shut off power completely.

**IMPORTANT SAFETY INSTRUCTIONS**

When using your telephone equipment, basic safety precautions should always be followed to reduce the risk of fire, electric shock and injury to persons, including the following:



1. Do not use this product near water, for example, near a bath tub, wash bowl, kitchen sink or washing machine, in a wet basement or near a swimming pool.
2. Avoid using this product during an electrical storm. There may be a remote risk of electric shock from lightning.
3. Do not use this product to report a gas leak in the vicinity of the leak.

**SAVE THESE INSTRUCTIONS**

# Choosing a location

Place your MFC on a flat, stable surface that is free of vibration and shocks, such as a desk. Put the MFC near a telephone socket and a standard, grounded electrical socket. Choose a location where the temperature remains between 10° and 35°C.

## ! Caution

- Avoid placing your MFC in a high-traffic area.
- Avoid placing your MFC on the carpet.
- Do not place near heaters, air conditioners, water, chemicals, or refrigerators.
- Do not expose the MFC to direct sunlight, excessive heat, moisture, or dust.
- Do not connect your MFC to electrical sockets controlled by wall switches or automatic timers.
- Disruption of power can wipe out information in the MFC's memory.
- Do not connect your MFC to electrical sockets on the same circuit as large appliances or other equipment that might disrupt the power supply.
- Avoid interference sources, such as speakers or the base units of cordless phones.

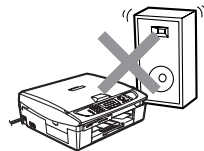
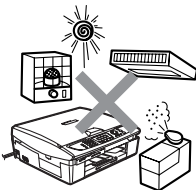

# Quick Reference Guide

## Sending Black & White Faxes

### Automatic Transmission

#### Sending a fax

- 1 If it is not illuminated in green, press  (**Fax**).
- 2 Load your document.
- 3 Enter the fax number using Speed-Dial, Search or the dial pad.
- 4 Press **Mono Start**.  
The MFC starts scanning the first page.

Next Page?  
1.Yes 2.No(Dial)

- 5 Press **2** to begin dialling.  
Press **Stop/Exit** to cancel.

#### Sending more than one page

- 1 If it is not illuminated in green, press  (**Fax**).
- 2 Load your document.
- 3 Enter the fax number using Speed-Dial, Search or the dial pad.
- 4 Press **Mono Start** or **Colour Start**.  
The MFC starts scanning the first page.

Next Page?  
1.Yes 2.No(Dial)

- 5 Press **1**.
- 6 Place the next page on the scanner glass.  
Press **Menu/Set**.  
The MFC starts scanning.  
(Repeat step 5 and 6 for each additional page.)
- 7 Press **2** to begin dialling.  
Press **Stop/Exit** to cancel.

## Storing numbers

### Storing Speed-Dial numbers

- 1 Press **Menu/Set**, **2**, **3**, **1**.
- 2 Using the dial pad, enter a two-digit Speed-Dial location number, and then press **Menu/Set**.
- 3 Enter a number (up to 20 digits), and then press **Menu/Set**.
- 4 Enter a name up to 15 characters (or leave it blank), and then press **Menu/Set**.
- 5 Press **Stop/Exit**.



## Dialling operations

### Speed-Dialling

- 1 If it is not illuminated in green, press  (**Fax**).
- 2 Load your document.
- 3 Press **Search/Speed Dial**, press #, and then press the two-digit Speed-Dial number.
- 4 Press **Mono Start** or **Colour Start**.

### Using Search

- 1 If it is not illuminated in green, press  (**Fax**).
- 2 Load your document.
- 3 Press **Search/Speed Dial**, and then enter the first letter of the name you're looking for.
- 4 Press ◀ or ▶ to search the memory.
- 5 Press **Mono Start** or **Colour Start**.

## Making copies

- 1 Press  (**Copy**) to illuminate it in green.
- 2 Load your document.
- 3 Press **Mono Start** or **Colour Start**.

# Table of Contents

## 1

<b>Introduction .....</b>	<b>1-1</b>
Using this Guide .....	1-1
Finding information .....	1-1
Symbols used in this Guide .....	1-1
Control panel overview .....	1-2
Turning the MFC to Power Save condition .....	1-4
Power Save Setting .....	1-5
Load documents .....	1-6
Using the scanner glass .....	1-6
About paper .....	1-7
Recommended Paper .....	1-7
Handling and using special paper .....	1-8
Paper type and size for each operation .....	1-9
Paper weight, thickness and capacity .....	1-10
Paper capacity of the output paper tray .....	1-10
Printable area .....	1-11
How to load paper, envelopes and post cards .....	1-12
To load paper or other media .....	1-12
To load envelopes .....	1-14
To load post cards .....	1-15
About fax machines .....	1-16
Custom features .....	1-16
Do you have BT's Call Minder on the phone line? ...	1-16
Why should there be problems? .....	1-16
How can you avoid possible problems? .....	1-16
Fax tones and handshake .....	1-17
ECM (Error Correction Mode) .....	1-18

## 2

<b>Getting started .....</b>	<b>2-1</b>
Initial Setup .....	2-1
Setting the Date and Time .....	2-1
Setting Tone or Pulse dialling mode (Except for the Nordic Countries) .....	2-1
Setting the Station ID .....	2-2
Setting the Phone Line Type .....	2-3
PABX and TRANSFER .....	2-3
General Setup .....	2-4
Setting the Mode Timer .....	2-4
Setting the Paper Type .....	2-4
Setting the Paper Size .....	2-5
Setting the Ring Volume .....	2-5

Setting the Beeper Volume.....	2-6
Setting the Speaker Volume.....	2-6
Turning on Automatic Daylight Savings Time.....	2-7
Setting the LCD Contrast.....	2-7

<b>Setup Send .....</b>	<b>3-1</b>
How to enter Fax mode .....	3-1
How to dial .....	3-1
Manual dialling.....	3-1
Speed-Dialling .....	3-2
Search .....	3-2
Fax Redial.....	3-2
How to Fax (B&W and Colour) .....	3-3
Automatic transmission.....	3-3
Colour fax transmission .....	3-4
Manual transmission.....	3-4
Basic sending operations.....	3-5
Sending faxes using multiple settings.....	3-5
Contrast .....	3-5
Fax Resolution.....	3-6
Dual Access (Not available for colour faxes) .....	3-7
Real Time Transmission.....	3-8
Checking job status .....	3-9
Cancelling a fax in progress .....	3-9
Cancelling a scheduled job.....	3-9
Advanced sending operations .....	3-10
Broadcasting (Not available for colour faxes) .....	3-10
Overseas Mode .....	3-11
Delayed Fax (Not available for colour faxes)	
(MFC-410CN only) .....	3-12
Delayed Batch Transmission	
(Not available for colour faxes)	
(MFC-410CN only) .....	3-13
Setup for Polled Transmit (Standard)	
(Not available for colour faxes)	
(MFC-410CN only) .....	3-13
Setup for Polled Transmit with Secure Code	
(Not available for colour faxes)	
(MFC-410CN only) .....	3-14
TX Lock .....	3-15
Setting up the password.....	3-16
Changing the TX Lock password.....	3-16
Turning TX Lock on .....	3-16
Turning TX Lock off .....	3-17

Faxing letter size documents from the scanner glass .....	3-17
--	------

## 4

<b>Setup Receive .....</b>	<b>4-1</b>
Basic receiving operations.....	4-1
Choosing the Receive Mode .....	4-1
To select or change your Receive Mode .....	4-2
Setting the Ring Delay .....	4-2
Setting the F/T Ring Time (Fax/Tel mode only).....	4-3
Fax Detect .....	4-4
Printing a reduced incoming fax (Auto Reduction) .....	4-5
Printing a fax from the memory (MFC-410CN only) ...	4-5
Reception into memory (Not available for colour fax reception).....	4-6
Polling (MFC-410CN only).....	4-7
Secure Polling .....	4-7
Setup for Polling Receive (Standard) .....	4-7
Setup for Polling Receive with Secure Code.....	4-8
Setup Delayed Polling Receive .....	4-8
Sequential Polling.....	4-9

## 5

<b>Quick-Dial numbers and dialling options .....</b>	<b>5-1</b>
Storing numbers for easy dialling .....	5-1
Storing Speed-Dial numbers .....	5-1
Changing Speed-Dial numbers .....	5-2
Setting up Groups for Broadcasting .....	5-3
Dialling options .....	5-5
Access codes and credit card numbers.....	5-5
Pause .....	5-5
Tone or Pulse .....	5-6

## 6

<b>Remote Fax Options (MFC-410CN only) (Not available for colour faxes) .....</b>	<b>6-1</b>
Setting up Fax Forwarding .....	6-1
Setting Fax Storage.....	6-2
Setting PC Fax Receive .....	6-2
Turning off Remote Fax Options .....	6-3
Setting your Remote Access Code.....	6-3
Remote Retrieval .....	6-4
Using your Remote Access Code.....	6-4
Remote commands .....	6-5
Retrieving fax messages .....	6-6
Changing your Fax Forwarding number .....	6-6

<b>Printing reports .....</b>	<b>7-1</b>
Fax settings and activity .....	7-1
Customizing the Transmission Verification Report .....	7-1
Setting the Journal Period .....	7-2
Printing reports .....	7-3
How to print a report .....	7-3

<b>Making copies .....</b>	<b>8-1</b>
Using the MFC as a copier .....	8-1
Enter Copy mode .....	8-1
Making a single copy .....	8-2
Making multiple copies .....	8-2
Stop copying .....	8-2
Using the Copy Options key (Temporary settings) .....	8-3
Changing the temporary copy settings .....	8-4
Increasing copy speed or quality .....	8-5
Enlarging or reducing the image copied .....	8-6
Setting paper type .....	8-7
Setting paper size .....	8-8
Adjusting brightness .....	8-8
Making N in 1 copies or a poster (Page Layout) (MFC-410CN only) .....	8-9
Changing the default copy settings .....	8-12
Increasing copy speed or quality .....	8-12
Adjusting brightness .....	8-12
Adjusting contrast .....	8-12
Adjusting colour saturation .....	8-13
Legal limitations .....	8-14

<b>Walk-Up PhotoCapture Center™ .....</b>	<b>9-1</b>
Introduction .....	9-1
PhotoCapture Center™ requirements .....	9-2
Getting started .....	9-3
Printing the Index (Thumbnails) .....	9-5
Printing images .....	9-6
DPOF printing .....	9-8
Changing the default settings .....	9-9
Increasing print speed or quality .....	9-9
Setting the paper & size .....	9-9
Adjusting brightness .....	9-10
Adjusting contrast .....	9-10
Colour enhancement (MFC-410CN only) .....	9-10
Cropping .....	9-12
Borderless .....	9-12

Understanding the Error Messages.....	9-13
Using PhotoCapture Center™ from your PC.....	9-14
Using PhotoCapture Center™ for scanning documents...	9-14

## 10

<b>Important information .....</b>	<b>10-1</b>
For your safety.....	10-1
IT power system (For Norway only).....	10-1
LAN connection (MFC-410CN only).....	10-1
International ENERGY STAR® Compliance Statement ...	10-1
Important safety instructions.....	10-2
Trademarks .....	10-4

## 11

<b>Troubleshooting and routine maintenance .....</b>	<b>11-1</b>
Troubleshooting.....	11-1
Error messages .....	11-1
Printer jam or paper jam .....	11-5
Paper is jammed inside the paper tray .....	11-5
Paper is jammed inside the MFC .....	11-6
If you are having difficulty with your MFC.....	11-8
How to change LCD language.....	11-13
Compatibility .....	11-13
How to improve print quality .....	11-14
Cleaning the print head .....	11-14
Checking the print quality .....	11-15
Checking the printing alignment .....	11-17
Checking the ink volume .....	11-18
Packing and shipping the MFC.....	11-19
Routine maintenance.....	11-22
Cleaning the scanner.....	11-22
Cleaning the MFC printer platen.....	11-23
Replacing the ink cartridges .....	11-24

## A

<b>Appendix A .....</b>	<b>A-1</b>
Telephone services .....	A-1
BT Call Sign (For U.K. Only) .....	A-1
To enable the MFC to work with BT Call Sign (Only with your external phone) .....	A-1
Advanced receiving operations .....	A-2
Operation from extension telephones.....	A-2
For Fax/Tel mode only.....	A-2
Fax/Tel mode in the power save condition .....	A-2
Using a cordless external handset .....	A-3
Changing the remote codes .....	A-3
Connecting an external device to your MFC .....	A-4

Connecting an external telephone .....	A-4
Connecting an external telephone answering device (TAD).....	A-5
Sequence .....	A-5
Connections.....	A-6
Recording outgoing message (OGM) on an external TAD.....	A-7
Using extension telephones (For U.K. only) .....	A-8
Multi-line connections (PBX).....	A-10
If you are installing the MFC to work with a PBX ...	A-10
Custom features on your phone line.....	A-10

## B

<b>Appendix B .....</b>	<b>B-1</b>
On-screen programming.....	B-1
Menu table .....	B-1
Memory storage.....	B-1
Navigation keys .....	B-2
Entering Text .....	B-12
Inserting spaces .....	B-12
Making corrections .....	B-12
Repeating letters .....	B-12
Special characters and symbols .....	B-13

## G

<b>Glossary .....</b>	<b>G-1</b>
-----------------------	------------

## S

<b>Specifications .....</b>	<b>S-1</b>
Product description.....	S-1
General .....	S-1
Print media.....	S-2
Copy .....	S-3
PhotoCapture Center.....	S-4
Fax.....	S-5
Scanner .....	S-6
Printer .....	S-7
Interfaces.....	S-7
Computer requirements.....	S-8
Consumable items.....	S-9
Network (LAN) (MFC-410CN only).....	S-10
Optional External Wireless Print/Scan Server (NC-2200w) .....	S-11

<b>Index .....</b>	<b>I-1</b>
--------------------	------------

<b>Remote Retrieval Access card (MFC-410CN only) .....</b>	<b>R-1</b>
--	------------

# 1 Introduction

## Using this Guide

Thank you for buying a Brother Multi-Function Center (MFC). Your MFC is simple to use, with LCD screen instructions to guide you through programming it. You can make the most of your MFC by reading through this Guide.

## Finding information

---





All the chapter headings and subheadings are listed in the Table of Contents. You will be able to find information about a specific feature or operation by checking the Index at the back of this Guide.

## Symbols used in this Guide

---

Throughout this Guide you will see special symbols alerting you to important warnings, notes and actions. To make things clearer and to help you press the correct keys, we used special fonts and added some of the messages that will appear in the LCD.

- |                |   |
|----------------|---|
| <b>Bold</b>    | Bold typeface identifies specific keys on the MFC control panel.                    |
| <i>Italics</i> | Italicized typeface emphasizes an important point or refers you to a related topic. |
| Courier New    | Courier New type face identifies the messages on the LCD of the MFC.                |

-  Warnings inform you what to do to avoid possible personal injury.
-  Cautions specify procedures you must follow or avoid to prevent possible damage to the MFC.
-  Notes tell you how you should respond to a situation that may arise or give tips about how the current operation works with other features.
-  Improper Setup alerts you to devices and operations that are not compatible with the MFC.



# Control panel overview

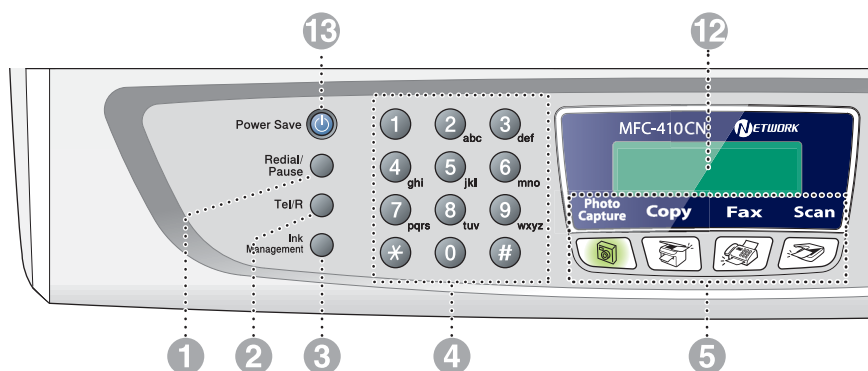

## 1 Redial/Pause

Redials the last number you called. It also inserts a pause in quick dial numbers.

## 2 Tel/R

This key is used to have a telephone conversation after picking up the external handset in F/T pseudo-ringing.

Also, use this key to transfer a call to another extension when it is connected to a PABX.

## 3 Ink Management

Lets you clean the print head, check the print quality, and check the available ink volume.

## 4 Dial Pad

Use these keys to dial telephone or fax numbers and as a keyboard for entering information into the MFC.

The # key lets you temporarily switch the dialling mode during a telephone call from Pulse to Tone.

## 5 Mode keys:



### PhotoCapture

Lets you access the PhotoCapture Center™ mode.



### Copy

Lets you access Copy mode.



### Fax

Lets you access Fax mode.



### Scan

Lets you access Scan mode.

## 6 Copy Options

You can quickly and easily select temporary settings for copying.

## 7 Fax Resolution

Sets the resolution when you send a fax.

## 8 Mono Start **Mono Start**

Lets you start sending faxes or make copies in black and white.

Also lets you start a scanning operation (in colour or mono, depending on the scanning setting on your PC).

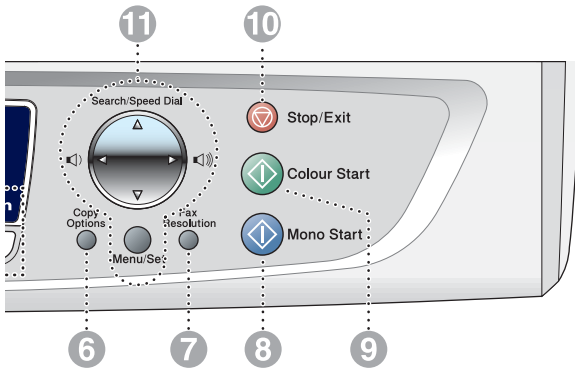

9  **Colour Start**

Lets you start sending faxes or make copies in full colour. Also lets you start a scanning operation (in colour or mono, depending on the scanning setting on your PC).

10  **Stop/Exit**

Stops an operation or exits from the menu.

11 **Navigation keys:**

**Menu/Set**

The same key is used for Menu and Set operations.

Lets you access the Menu to program and store your settings in the MFC.



When using the speaker or during ringing in fax mode, you can press these keys to adjust the volume.

▲ **Search/Speed Dial**

Lets you look up numbers that are stored in the dialling memory. It also lets you dial stored numbers by pressing # and a two-digit number.



Press to scroll backward to a menu selection.



Press to scroll through the menus and options.

12 **Liquid Crystal Display (LCD)**

Displays messages on the screen to help you set up and use your MFC. The LCD examples in this guide are for models with a two-line display. There may be slight differences between the examples provided and models with a one-line display.

13 **Power Save**

You can turn the MFC to power save condition.

## Turning the MFC to Power Save condition

---

When the MFC is idle, you can turn it to Power Save condition by pressing the Power Save key. In Power Save mode, the MFC will receive telephone calls as normal. For further information on receiving faxes in the power save condition, please see the table on page 1-5. The delayed faxes that have been set up will be sent (MFC-410CN only). You can even retrieve faxes using Remote Retrieval if you are away from your MFC (MFC-410CN only). If you want to do other operations, you must turn the MFC back on.

### Turning the MFC to Power Save condition

Press and hold down the **Power Save** key until the LCD shows:

Shutting Down

The LCD light will go off.

### Turning the MFC to Power Save condition off

Press and hold down the **Power Save** key until the LCD shows:

Please Wait

The LCD will show the date and time (Fax mode).



Even if you turned the MFC off, it will periodically clean the print head to preserve print quality.

If you unplug the AC power cord, no MFC operations will be available.



You can turn the MFC Off by customizing the **Power Save** key as shown next page. In this Off mode, no MFC operation will be available. (See *Power Save Setting* on page 1-5.)



The external telephone is always available.

## Power Save Setting

You can customize the machine's **Power Save** key. The default mode is `Fax Receive:On`, so your machine can receive faxes or calls even when the machine is in Power Save mode. If you do not want your machine to receive faxes or calls, turn this setting to `Fax Receive:Off`. (See *Turning the MFC to Power Save condition* on page 1-4.)

- 1 Press **Menu/Set**, **1**, **6**.
- 2 Press **▲** or **▼** to select `Off` (or `On`).
- 3 Press **Menu/Set**.
- 4 Press **Stop/Exit**.

### (For MFC-410CN)

On/Off Setting	Receive Mode	Available Operations
Fax Receive:On (default)	Fax Only External TAD	Fax Receive, Fax Detect, Delayed Fax, Remote Fax Option, Remote Retrieval: <ul style="list-style-type: none"> <li>■ You cannot receive a fax with <b>Mono Start</b> or <b>Colour Start</b>.</li> <li>■ Delayed Fax and Remote Fax Option should be set before you switch off the MFC.</li> </ul>
	Manual Fax/Tel*	Delayed Fax, Fax Detect: <ul style="list-style-type: none"> <li>■ You cannot receive a fax with <b>Mono Start</b> or <b>Colour Start</b>.</li> <li>■ * You cannot receive a fax automatically even if you have set the receive mode to Fax/Tel.</li> <li>■ Delayed Fax should be set before you switch off MFC.</li> </ul>
Fax Receive:Off	—	No MFC operations will be available.

### (For MFC-210C)

On/Off Setting	Receive Mode	Available Operations
Fax Receive:On (default)	Fax Only External TAD	Fax Receive, Fax Detect: <ul style="list-style-type: none"> <li>■ You cannot receive a fax with <b>Mono Start</b> or <b>Colour Start</b>.</li> </ul>
	Manual Fax/Tel*	Fax Detect: <ul style="list-style-type: none"> <li>■ You cannot receive a fax with <b>Mono Start</b> or <b>Colour Start</b>.</li> <li>■ * You cannot receive a fax automatically even if you have set the receive mode to Fax/Tel.</li> </ul>
Fax Receive:Off	—	No MFC operations will be available.

# Load documents

## Using the scanner glass

---

You can use the scanner glass to fax pages of a book or one page at a time. Documents can be up to A4 size (21.6 to 29.7 cm).

- 1 Lift the document cover.

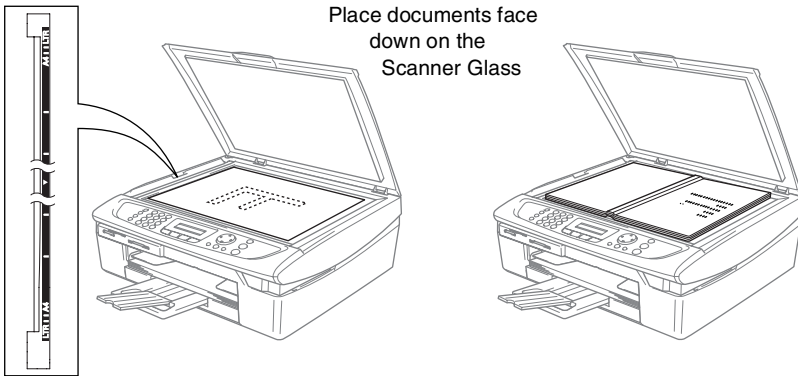

- 2 Using the document guidelines on the left, center the document face down on the scanner glass.
  - 3 Close the document cover.
- ! If the document is a book or is thick, do not slam the cover or press on it.

# About paper

The print quality can be affected by the type of paper you use in the MFC.

To get the best print quality for the settings you've chosen, always set the Paper Type to match the type of paper you load.

You can use plain paper, inkjet paper (coated paper), glossy paper, transparencies and envelopes.

We recommend testing various paper types before purchasing large quantities.

For best results, use the recommended paper.



- When you print on inkjet paper (coated paper), transparencies and glossy paper, be sure to select the proper media in the “Basic” tab of the printer driver or in the Paper Type setting of the menu (**Menu/Set, 1, 2**).
- When you print on Brother glossy paper, load the instruction sheet included with the glossy paper in the paper tray first, and then place the glossy paper on the instruction sheet.
- When you use transparencies or glossy paper, remove each sheet immediately to prevent smudging or paper jams.
- Avoid touching the printed surface of the paper immediately after printing; the surface may not be completely dry and stain your fingers.

## Recommended Paper

---

To get the best print quality, we suggest using Brother paper. (See table below.)

If Brother paper is not available in your country, we recommend testing various papers before purchasing large quantities.

We recommend using “3M Transparency Film” when you print on transparencies.

### Brother Paper

Paper Type	Item
A4 Plain	BP60PA
A4 Glossy	BP60GLA
A4 Inkjet (Photo Matte)	BP60MA

## Handling and using special paper

---

- Store paper in its original packaging, and keep it sealed. Keep the paper flat and away from moisture, direct sunlight and heat.
- The coated side of glossy paper is shiny. Avoid touching the shiny (coated) side. Load glossy paper with the shiny side facing down.
- Avoid touching either side of transparencies, because they absorb water and perspiration easily, and this may cause decreased output quality. Transparencies designed for laser printers/copiers may stain your next document. Use only transparencies recommended for inkjet printing.



Do not use paper:

- that are damaged, curled, wrinkled, or irregularly shaped

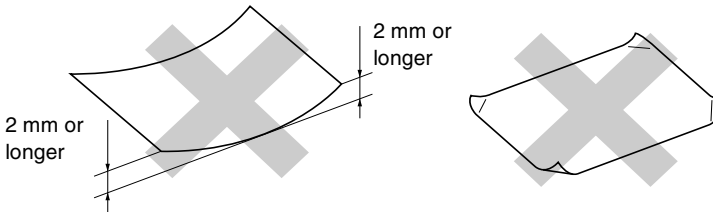

- that are extremely shiny or highly textured
- that were previously printed by a printer
- that cannot be arranged uniformly when stacked
- that are made with a short grain

## Paper type and size for each operation

Paper Type	Paper Size	Usage			
		Fax	Copy	PhotoCapture	Printer
Cut Paper	Letter	216 x 279 mm (8 1/2" x 11")	Yes	Yes	Yes
	A4	210 x 297 mm (8.3" x 11.7")	Yes	Yes	Yes
	Legal	216 x 356 mm (8 1/2" x 14")	Yes	-	Yes
	Executive	184 x 267 mm (7 1/4" x 10 1/2")	-	-	Yes
	JIS B5	182 x 257 mm (7.2" x 10.1")	-	-	Yes
	A5	148 x 210 mm (5.8" x 8.3")	-	Yes	Yes
A6	105 x 148 mm (4.1" x 5.8")	-	-	Yes	
Cards	Photo	102 x 152 mm (4" x 6")	-	Yes	Yes
	Photo L	89 x 127 mm (3 1/2" x 5")	-	-	Yes
	Photo 2L	127 x 178 mm (5" x 7")	-	Yes	Yes
	Index Card	127 x 203 mm (5" x 8")	-	-	Yes
	Post Card 1	100 x 148 mm (3.9" x 5.8")	-	-	Yes
	Post Card 2	148 x 200 mm (5.8" x 7.9")	-	-	Yes
	(Double)		-	-	Yes
			-	-	Yes
Envelopes	C5 Envelope	162 x 229 mm (6.4" x 9")	-	-	Yes
	DL Envelope	110 x 220 mm (4.3" x 8.7")	-	-	Yes
	COM-10	105 x 241 mm (4 1/8" x 9 1/2")	-	-	Yes
	Monarch	98 x 191 mm (3 7/8" x 7 1/2")	-	-	Yes
	JE4 Envelope	105 x 235 mm (4.1" x 9.3")	-	-	Yes
Transparencies	Letter	216 x 279 mm (8 1/2" x 11")	-	-	Yes
	A4	210 x 297 mm (8.3" x 11.7")	-	-	Yes



## Paper weight, thickness and capacity

Paper Type		Weight	Thickness	No. of sheets
Cut Paper	Plain Paper	64 to 120 g/m <sup>2</sup> (17 to 32 lb)	0.08 to 0.15 mm (0.003" to 0.006")	100*
	Inkjet Paper	64 to 200 g/m <sup>2</sup> (17 to 53 lb)	0.08 to 0.25 mm (0.003" to 0.01")	20
	Glossy Paper	Up to 220 g/m <sup>2</sup> (Up to 58 lb)	Up to 0.25 mm (Up to 0.01")	20
Cards	Photo Card	Up to 240 g/m <sup>2</sup> (Up to 64 lb)	Up to 0.28 mm (Up to 0.01")	20
	Index Card	Up to 120 g/m <sup>2</sup> (Up to 32 lb)	Up to 0.15 mm (Up to 0.006")	30
	Post Card	Up to 200 g/m <sup>2</sup> (Up to 53 lb)	Up to 0.23 mm (Up to 0.01")	30
Envelopes		-	Up to 0.52 mm (Up to 0.02")	10
Transparencies		-	-	10

\* Up to 50 sheets for Legal size paper (80 g/m<sup>2</sup>).

\* Up to 100 sheets of 80 g/m<sup>2</sup>.

## Paper capacity of the output paper tray

Output Paper Tray	<p>Up to 25 sheets of 80 g/m<sup>2</sup> (A4)</p> <ul style="list-style-type: none"> <li>■ Transparencies or glossy paper must be picked up from the output paper tray one page at a time to avoid smudging.</li> <li>■ Legal paper cannot be stacked on the output paper tray.</li> </ul>
-------------------	--

## Printable area

The printable area depends on the settings in the application you are using. The figures below show the unprintable areas on cut sheet paper and envelopes.

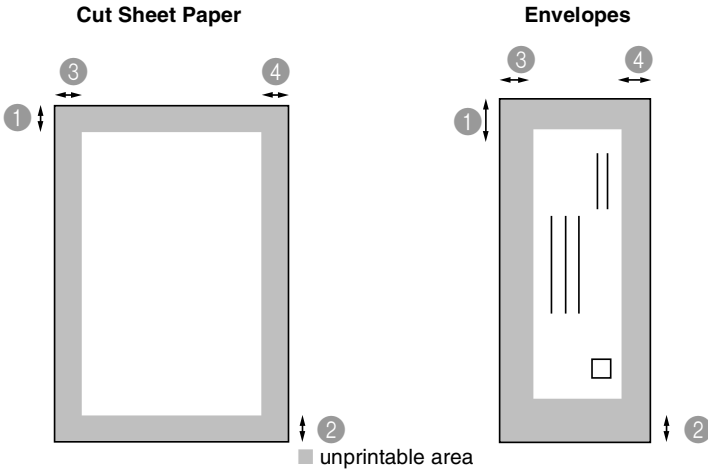

	① Top	② Bottom	③ Left	④ Right
Cut Sheet	3 mm (0 mm)*1	3 mm (0 mm)*1	3 mm (0 mm)*1	3 mm (0 mm)*1
Envelopes	12 mm	24 mm	3 mm	3 mm



\*1 When you set the Borderless feature to On.

Printable area depends on the Printer driver settings.

The figures above are approximate and the printable area may vary depending on the type of cut sheet paper you are using.

# How to load paper, envelopes and post cards

## To load paper or other media

- 1 Pull the paper tray completely out of the MFC and remove the output paper tray.

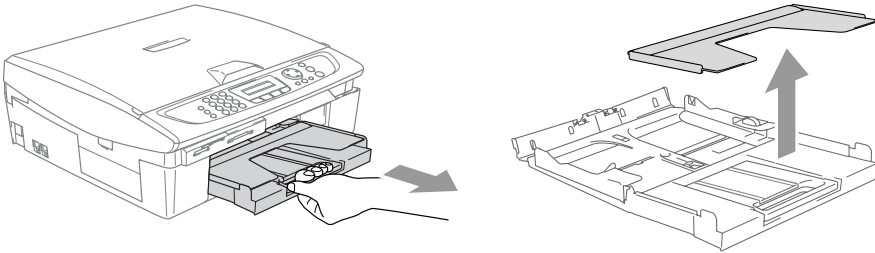

- 2 Press and slide the paper side guide to fit the paper width.

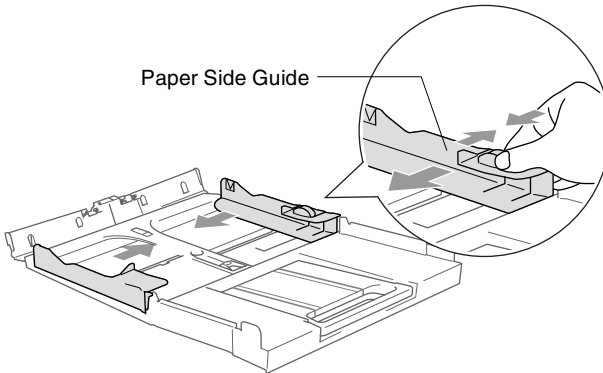

- 3 Pull out the paper support and unfold the paper support flap.

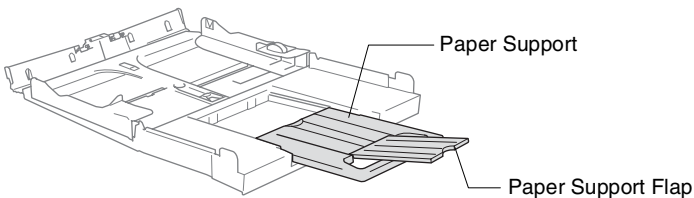

Use the paper support flap for Letter, Legal and A4.

- 4** Fan the stack of paper well to avoid paper jams and mis-feeds.

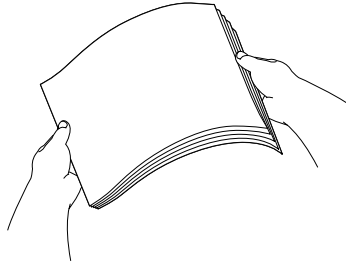

- 5** Gently insert the paper into the paper tray print side down and the leading edge (top of the paper) in first.

Check that the paper is flat in the tray and below the maximum paper mark.

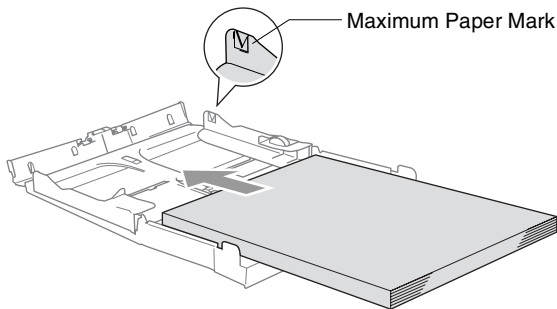

-  ■ Make sure the paper side guides touch the sides of the paper.
  - Be careful that you do not push the paper in too far; it may lift at the back of the tray and cause feed problems.
- 6** Put the output paper tray back on and push the paper tray firmly back into the MFC.

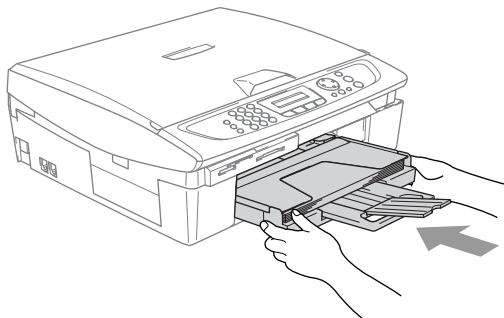

## To load envelopes

- Use envelopes that weigh from 75-95 g/m<sup>2</sup>.
- Some envelopes require margin settings in the application. Make sure you do a test print first.
- ⊘ To prevent possible damage to the feeding mechanism, do not use the types of envelopes shown below.

### DO NOT USE ENVELOPES:

- that are of a baggy construction
- that are embossed (have raised writing on them)
- that have clasps on them
- that are not sharply creased
- that are preprinted on the inside

#### ■ Glue

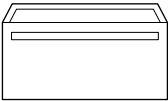

#### ■ Rounded flap

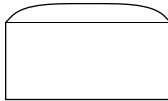

#### ■ Double flap

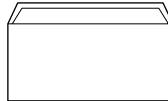

#### ■ Triangular flap

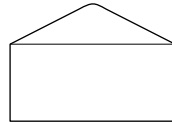

## How to load envelopes

- 1 Before loading, press the corners and sides of the envelopes to make them as flat as possible.

-  If the envelopes are 'double-feeding,' put one envelope in the paper tray at a time.

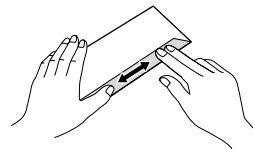
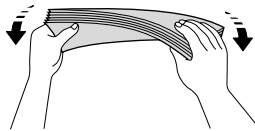
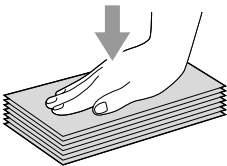

- 2 Insert the envelopes into the paper tray with the address side down and the leading edge (top of the envelopes) in first. Slide the paper side guide to fit the width of the envelopes.

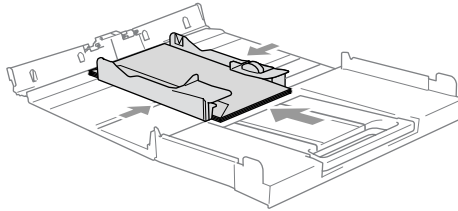

***If you have problems when printing on envelopes, try the following suggestions:***

- 1 Open the envelope flap.
- 2 Make sure the open flap is either to the side of the envelope or to the back edge of the envelope when printing.
- 3 Adjust the size and margin in your application.

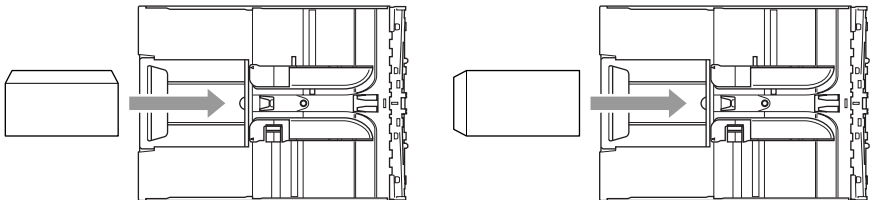

## **To load post cards**

- 1 Raise the paper stop and insert the post cards into the paper tray. Slide the paper side guide to fit the width of the post cards.

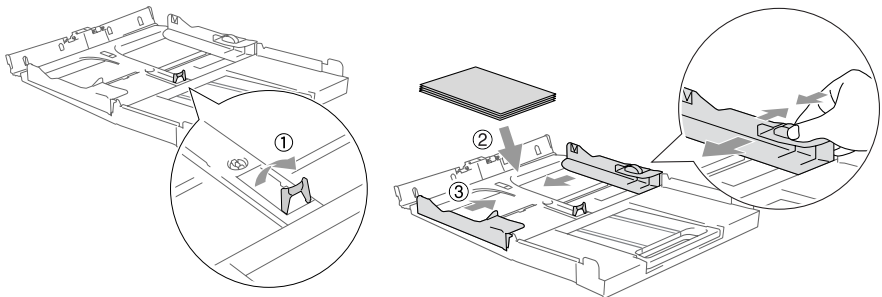

# About fax machines

## Custom features

---

### **Do you have BT's Call Minder on the phone line?**

If you have Call Minder on the phone line where you will install your new MFC, *there is a strong possibility that Call Minder and the MFC may conflict with each other while receiving incoming calls.*

### **Why should there be problems?**

Since both the MFC and Call Minder will pick up the call, after the number of rings you have set, each of them has the ability to keep the other from receiving calls.

For example, if Call Minder is set to answer after two rings and your MFC is set to answer after four, Call Minder will stop your MFC from receiving faxes.

If you set Call Minder and the Brother MFC to answer after the same number of rings, there is no way of knowing which one will answer first. It is important to remember that neither Call Minder nor the MFC can pass the call back to the other after the call has been answered.

### **How can you avoid possible problems?**

A very good way to avoid problems like the one mentioned, *is to get a second phone number on your present phone line.*

Many people with Call Minder choose an alternative service, which is called "BT Call Sign", and they are very satisfied with it. (See *BT Call Sign (For U.K. Only)* on page A-1.)

Another way to avoid possible problems is to replace BT's Call Minder with an answering machine. Your Brother MFC is designed to work with an answering machine or TAD (telephone answering device).

(See *Connecting an external telephone answering device (TAD)* on page A-5.)

## Fax tones and handshake

---

When someone is sending a fax, the MFC sends fax calling tones (CNG tones). These are quiet, intermittent beeps every 4-seconds. You'll hear them after you dial and press **Mono Start** or **Colour Start** and they will continue for about 60 seconds after dialling. During that time, the sending machine must begin the "handshake", or connection, with the receiving machine.

Each time you use automatic procedures to send a fax, you are sending CNG tones over the phone line. You will soon learn to listen for these quiet beeps each time you answer a phone on your fax line, so you will know if you are receiving a fax message.

The receiving fax responds with fax receiving tones, which are loud, chirping sounds. A receiving fax chirps for about 40 seconds over the phone line, and the LCD shows *Receiving*.

If your MFC is set to the Fax Only mode, it will answer every call automatically with fax receiving tones. If the other person hangs up, your MFC will continue to send the "chirps" for about 40 seconds, and the LCD continues to show *Receiving*. To cancel receiving, press **Stop/Exit**.

The fax 'handshake' is the time in which the sending machine's CNG tones and the receiving machine's "chirps" overlap. This must be for at least 2 to 4 seconds, so both machines can understand how each is sending and receiving the fax. The handshake cannot begin until the call is answered, and the CNG tones only last for about 60 seconds after the number is dialed. So it is important for the receiving machine to answer the call in as few rings as possible.



When you have an external Telephone Answering Device (TAD) on your fax line, your TAD will decide the number of rings before the call is answered.



## **ECM (Error Correction Mode)**

---

The Error Correction Mode (ECM) is a way for the MFC to check a fax transmission while it is in progress. If the MFC detects errors during fax transmission, it resends the pages of the fax that had an error. ECM transmissions are only possible between fax machines that both have this feature. If they do, you may send and receive fax messages that are continuously being checked by the MFC.

Your MFC must have enough memory for this feature to work.

# 2

## Getting started

### Initial Setup

#### Setting the Date and Time

---

When the MFC is not in use it will display the date and time. If you set up the Station ID the date and time displayed by your MFC will be printed on every fax you send. If there is a power failure, you may have to reset the date and time. No other settings will be affected.

**1** Press **Menu/Set, 0, 2**.

**2** Enter the last two digits of the year.

Press **Menu/Set**.

**3** Enter two digits for the month.

Press **Menu/Set**.

(For example, enter 09 for September, or 10 for October.)

**4** Enter two digits for the day.

Press **Menu/Set**. (For example, enter 06 for 6th.)

**5** Enter the time in 24-Hour format.

Press **Menu/Set**. (For example, enter 15:25 for 3:25 P.M.)

**6** Press **Stop/Exit**.

The LCD now shows the date and time whenever the MFC is in Fax mode.

#### Setting Tone or Pulse dialling mode (Except for the Nordic Countries)

---

**1** Press **Menu/Set, 0, 4**.

**2** Press **▲** or **▼** to select **Pulse** (or **Tone**).

Press **Menu/Set**.

**3** Press **Stop/Exit**.

## Setting the Station ID

---

You should store your name or company name and fax number so they print on all fax pages you send.

It is important that you enter the fax number in the internationally standardized format, i.e. in accordance with the following strict sequence:

- The “+” (plus) character (by pressing \* key)
- Your Country Code (e.g. “44” for the United Kingdom, “41” for Switzerland)
- Your local area code minus any leading “0” (“9” in Spain)
- A space
- Your number on the local exchange, using spaces to aid readability as appropriate.

As an example, if the machine is installed in the United Kingdom and the same line is to be used for both fax and voice calls, and your national telephone number is 0161 444 5555, then you must set the fax and telephone number parts of your station ID as:

+44 161 444 5555.

**1** Press **Menu/Set, 0, 3**.

**2** Enter your fax number (up to 20 digits).

Press **Menu/Set**.



You cannot enter a hyphen in the fax number. To enter a space press ► once between numbers.

**3** Use the dial pad to enter your name (up to 20 characters).

(See *Entering Text* on page B-12.)

Press **Menu/Set**.

**4** Press **Stop/Exit**.



If the Station ID has already been programmed, the LCD will ask you to press **1** to make a change or **2** to exit without changing.

## Setting the Phone Line Type

---

If you are connecting the MFC to a line that features a PABX (PBX), ADSL or ISDN to send and receive faxes, it is also necessary to change the Phone Line Type accordingly by completing the following steps.

- 1** Press **Menu/Set, 0, 5**.
- 2** Press **▲** or **▼** to select **PBX, ADSL, ISDN (or Normal)**. Press **Menu/Set**.
- 3** Press **Stop/Exit**.

### PABX and TRANSFER

The MFC is initially set to be connected with PSTN (Public Switched Telephone Network) lines. However, many offices use a central telephone system or Private Automatic Branch Exchange (PABX). Your MFC can be connected to most types of PABX. The MFC's recall feature supports timed break recall only (TBR). TBR will work with most PABX systems allowing you to gain access to an outside line, or transfer calls to another extension. The feature works when the **Tel/R** key is pressed.



You can program a **Tel/R** keypress as part of a number stored in a Speed-Dial location. When programming the Speed-Dial number (**Menu/Set** 2-3-1 or 2-3-2) press **Tel/R** first (the screen displays "!"), then enter the telephone number. If you do this, you do not need to press **Tel/R** each time before you dial using a Speed-Dial location. (See *Storing numbers for easy dialling* on page 5-1.)

# General Setup

## Setting the Mode Timer

---

The MFC has four temporary mode keys on the control panel: PhotoCapture, Copy, Fax and Scan. You can change the number of seconds or minutes the MFC takes after the last Copy, Scan or PhotoCapture operation before it returns to Fax mode. If you select **Off**, the MFC stays in the mode you used last.

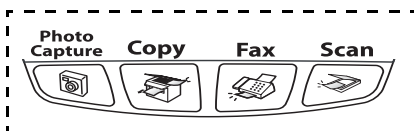

- 1 Press **Menu/Set**, **1**, **1**.
- 2 Press **▲** or **▼** to select **0 Sec**, **30 Secs**, **1 Min**, **2 Mins**, **5 Mins** or **Off**.
- 3 Press **Menu/Set**.
- 4 Press **Stop/Exit**.

## Setting the Paper Type

---

To get the best print quality, set the MFC for the type of paper you are using.

- 1 Press **Menu/Set**, **1**, **2**.
- 2 Press **▲** or **▼** to select **Plain**, **Inkjet**, **Glossy** or **Transparency**.  
Press **Menu/Set**.
- 3 Press **Stop/Exit**.



The MFC ejects paper with printed surfaces face up onto the paper tray in the front of the machine. When you use transparencies or glossy paper, remove each sheet immediately to prevent smudging or paper jams.

## Setting the Paper Size

---

You can use five sizes of paper for printing copies: Letter, Legal, A4, A5, and 10 x 15 cm and three sizes for printing faxes: Letter, Legal and A4. When you change the type of paper you load in the MFC, you will need to change the setting for Paper Size at the same time so your MFC can fit an incoming fax on the page.

- 1** Press **Menu/Set, 1, 3**.
- 2** Press **▲** or **▼** to select **Letter, Legal, A4, A5** or **10x15cm**. Press **Menu/Set**.
- 3** Press **Stop/Exit**.



## Setting the Ring Volume

---

You can turn the ring **Off** or you can select the ring volume level.

- 1** Press **Menu/Set, 1, 4, 1**.
- 2** Press **▲** or **▼** to select **Low, Med, High** or **Off**. Press **Menu/Set**.
- 3** Press **Stop/Exit**.

—OR—

You can adjust the ring volume when your MFC is idle (not being used). In Fax mode , press  or  to adjust the volume level. Every time you press these keys, the MFC will ring so you can hear the active setting as the LCD shows it. The volume changes with each key press. The new setting will stay until you change it again.

## Setting the Beeper Volume

---

You can change the beeper volume. The default (factory) setting is **Low**. When the beeper is on, the MFC will beep when you press a key, make a mistake or you send or receive a fax.

- 1** Press **Menu/Set, 1, 4, 2**.
- 2** Press **▲** or **▼** to select your option.  
(**Low, Med, High** or **Off**)  
Press **Menu/Set**.
- 3** Press **Stop/Exit**.

## Setting the Speaker Volume

---

You can adjust the MFC's one-way speaker volume.

- 1** Press **Menu/Set, 1, 4, 3**.
- 2** Press **▲** or **▼** to select **Low, Med, High** or **Off**.  
Press **Menu/Set**.
- 3** Press **Stop/Exit**.

## Turning on Automatic Daylight Savings Time

---

You can set the MFC to change automatically for Daylight Savings Time. It will reset itself forward one hour in the Spring and backward one hour in the Autumn. Make sure you have set the correct day and time in the `Date/Time` setting.

- 1** Press **Menu/Set**, **1**, **5**.
- 2** Press **▲** or **▼** to select `On` (or `Off`).  
Press **Menu/Set**.
- 3** Press **Stop/Exit**.

## Setting the LCD Contrast

---



You can adjust the LCD contrast for a sharper and more vivid display. If you are having difficulty reading the LCD from your position, try changing the contrast setting for improved viewing.

- 1** Press **Menu/Set**, **1**, **7**.
- 2** Press **▲** or **▼** to select `Light` or `Dark`.  
Press **Menu/Set**.
- 3** Press **Stop/Exit**.



# 3 Setup Send

## How to enter Fax mode

Before sending faxes, make sure  (**Fax**) is illuminated in green. If not, press  (**Fax**) to enter Fax mode. The default setting is Fax.

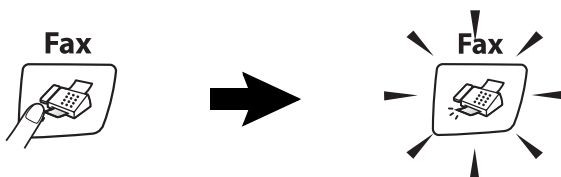

## How to dial

You can dial in any way of the following ways.

### Manual dialling

---

Press all of the digits of the phone or fax number.

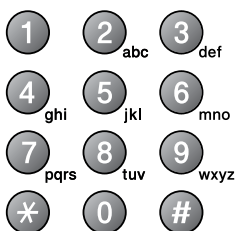

## Speed-Dialling

---

Press **Search/Speed Dial**, **#**, and then the two digit Speed-Dial number. (See *Storing Speed-Dial numbers* on page 5-1.)

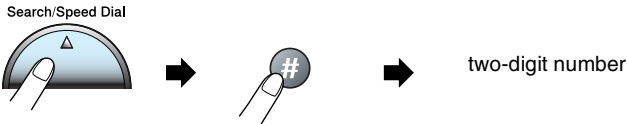

 If the LCD shows **Not Registered** when you enter the Speed-Dial number, a number has not been stored for it.

## Search

---

You can search for names you have stored in the Speed-Dial memories. Press **Search/Speed Dial** and the navigation keys to search. (See *Storing Speed-Dial numbers* on page 5-1.)

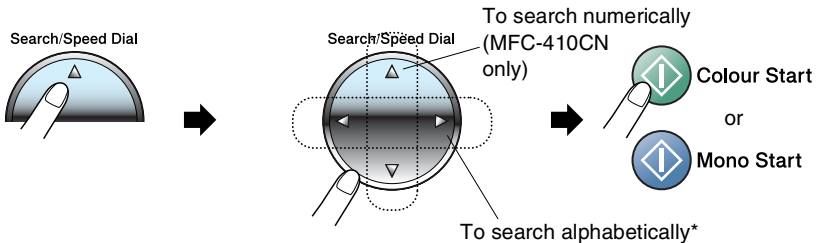

\* To search alphabetically, you can use the dial pad to enter the first letter of the name you are looking for.

## Fax Redial

---

If you are sending a fax manually and the line is busy, press **Redial/Pause**, and then press **Mono Start** or **Colour Start** to try again. If you want to make a second call to the last number dialed, you can save time by pressing **Redial/Pause** and **Mono Start** or **Colour Start**.

**Redial/Pause** only works if you dialed from the control panel.

*If you are sending a fax automatically* and the line is busy, the MFC will automatically redial up to three times at five minutes intervals.

# How to Fax (B&W and Colour)

## Automatic transmission

---

You can use the scanner glass to fax pages of a book or one page at a time. The documents can be up to A4 size. To cancel, press **Stop/Exit**.

**1** If it is not illuminated in green, press  (**Fax**).

**2** Load your document on the scanner glass.

**3** Dial the fax number.

Press **Mono Start** or **Colour Start**.

The MFC starts scanning the first page.

If you press **Colour Start**, the MFC starts sending.

**4** To send a single page, press **2** (or press **Mono Start** again).

Next Page?  
1.Yes 2.No(Dial)

The MFC starts sending the document.

—OR—

To send more than one page, press **1** and go to Step 5.

**5** Place the next page on the scanner glass.

Set Next Page  
Then Press Set

Press **Menu/Set**.

The MFC starts scanning. (Repeat Steps 4 and 5 for each additional page.)



■ If the memory is full and you are faxing a single page, it will be sent in real time.

■ You cannot send multiple pages for colour faxes.

## Colour fax transmission

---

Your MFC can send a colour fax to machines that support this feature.

However, colour faxes cannot be stored in the memory. When you send a colour fax, the MFC will send it in real time (even if Real Time TX is set to Off).



(MFC-410CN)

Delayed fax and Polling Transmit features are not available in colour.

## Manual transmission

---

Manual transmission lets you hear the dialling, ringing and fax-receiving tones while sending a fax.

- 1** If it is not illuminated in green, press  (**Fax**).
- 2** Load your document.
- 3** Pick up the handset of the external phone and listen for a dial tone.
- 4** Dial the fax number you want to call.
- 5** When you hear the fax tone, press **Mono Start** or **Colour Start**.
- 6** Press **1** to send a fax.
- 7** Replace the handset of the external phone.

1.Send 2.Receive

# Basic sending operations

## Sending faxes using multiple settings

---

When you send a fax you can choose any combination of these settings: contrast, resolution, overseas mode, delayed fax timer (MFC-410CN only), polling transmission (MFC-410CN only) or real time transmission.

- 1 If it is not illuminated in green, press  (**Fax**).

After each setting is accepted, the LCD will ask if you want to enter more settings:

- 2 Press **1** to select more settings. The LCD will return to the Setup Send menu.

Next 1.Yes 2.No
--------------------

—OR—

Press **2** if you have finished choosing settings and go to the next step.

## Contrast

---

If your document is very light or very dark, you may want to change the contrast.

Use *Light* to send a light document.

Use *Dark* to send a dark document.

- 1 If it is not illuminated in green, press  (**Fax**).

- 2 Load your document.

- 3 Press **Menu/Set**, **2**, **2**, **1**.

- 4 Press **▲** or **▼** to select *Auto*, *Light* or *Dark*.

Press **Menu/Set**.

## Fax Resolution

---

You can use the **Fax Resolution** key to change the setting temporarily (for this fax only). In Fax mode  (**Fax**), press **Fax Resolution** and ▲ or ▼ to select the setting you want, and then press **Menu/Set**.

—OR—

You can change the default setting:

- 1** If it is not illuminated in green, press  (**Fax**).
- 2** Load your document.
- 3** Press **Menu/Set, 2, 2, 2**.
- 4** Press ▲ or ▼ to select the resolution you want.

Press **Menu/Set**.

Standard	Suitable for most typed documents.
Fine	Good for small print and transmits a little slower than Standard resolution.
S.Fine	Good for small print or artwork and transmits slower than Fine resolution.
Photo	Use when the document has varying shades of gray or is a photograph. This has the slowest transmission time.

## Dual Access (Not available for colour faxes)

---

You can dial a number, and begin scanning the fax into memory—even when the MFC is sending from memory or receiving faxes. The LCD shows the new job number and available memory.



Your MFC normally uses Dual Access. However, to send a colour fax, the MFC will send the document in real time (even if *Real Time TX is Off*).

The number of pages you can scan into the memory will vary depending on the data that is printed on them.



If you get an *Out of Memory* message while scanning the first page of a fax, press **Stop/Exit** to cancel scanning. If you get an *Out of Memory* message while scanning a subsequent page, you can press **Mono Start** to send the pages scanned so far, or press **Stop/Exit** to cancel the operation.

## Real Time Transmission

---

When you are sending a fax, the MFC will scan the documents into the memory before sending. Then, as soon as the phone line is free, the MFC will start dialling and sending.

If the memory becomes full, the MFC will send the document in real time (even if `Real Time TX` is set to `Off`).

Sometimes, you may want to send an important document immediately, without waiting for memory transmission. You can set `Real Time TX` to `On` for all documents or for the next fax only.

If you want to fax multiple pages from the scanner glass, `Real Time Transmission` should be set to `Off`.

- 1 If it is not illuminated in green, press  (**Fax**).
- 2 Load your document.
- 3 For MFC-210C, press **Menu/Set**, **2**, **2**, **3**.  
For MFC-410CN, press **Menu/Set**, **2**, **2**, **5**.
- 4 To change the default setting, press **▲** or **▼** to select `On` (or `Off`).  
Press **Menu/Set**.  
—OR—  
For the next fax transmission only, press **▲** or **▼** to select `Next Fax Only`.  
Press **Menu/Set**.
- 5 Press **▲** or **▼** to select `On` (or `Off`).  
Press **Menu/Set**.

 In Real Time Transmission, the redial feature does not work.

 If you are sending a colour Fax, the MFC will send it in real time (even if `Real Time TX` is set to `Off`).



## Checking job status

---

Check which jobs are still waiting in the memory to be sent. (If there are no jobs, the LCD shows `No Jobs Waiting`.)

- 1 For MFC-210C, press **Menu/Set, 2, 5**.  
For MFC-410CN, press **Menu/Set, 2, 6**.
- 2 If you have more than one job waiting, press **▲** or **▼** to scroll through the list.
- 3 Press **Stop/Exit**.

## Cancelling a fax in progress

---

If you want to cancel a fax, while the MFC is scanning, dialling or sending it, press **Stop/Exit**.

## Cancelling a scheduled job

---

You can cancel a fax job that is stored and waiting in the memory.

- 1 For MFC-210C, press **Menu/Set, 2, 5**.  
For MFC-410CN, press **Menu/Set, 2, 6**.  
Any jobs that are waiting will appear on the LCD.
- 2 If you have more than one job waiting, press **▲** or **▼** to select the job you want to cancel.  
Press **Menu/Set**.  
—OR—  
If you only have one job waiting, go to Step 3.
- 3 Press **1** to cancel.  
To cancel another job go to Step 2.  
—OR—  
Press **2** to exit without cancelling.
- 4 Press **Stop/Exit**.

# Advanced sending operations

## Broadcasting (Not available for colour faxes)

---

Broadcasting is when the same fax message is automatically sent to more than one fax number. You can include Groups, Speed-Dial numbers and up to 50 manually dialled numbers in the same broadcast.

Press **Menu/Set** between each of the numbers. Use **Search/Speed Dial** to help you choose the numbers easily. (To set up Group dial numbers, see *Setting up Groups for Broadcasting* on page 5-3.)

After the broadcast is finished, a Broadcast Report will be printed to let you know the results.

- 1** If it is not illuminated in green, press  **(Fax)**.
- 2** Load your document.
- 3** Enter a number using Speed-Dial, a Group number, Search or manual dialling using the dial pad.  
(Example: Group number)
- 4** When the LCD displays the fax number or name of the other party, press **Menu/Set**.  
You will be asked to enter the next number.
- 5** Enter the next number.  
(Example: Speed-Dial number)
- 6** When the LCD displays the fax number or name of the other party, press **Menu/Set**.
- 7** After you have entered all the fax numbers, go to Step 8 to start the broadcast.
- 8** Press **Mono Start**.



- If you did not use up any of the numbers for Groups, access codes or credit card numbers, you can 'broadcast' faxes to as many as 70 (MFC-210C) or 130 (MFC-410CN) different numbers.
- The available memory will vary depending on the types of jobs in the memory and the number of locations used for broadcasting. If you broadcast to the maximum numbers available, you will not be able to use Dual Access and Delayed fax (MFC-410CN only).
- Enter the long dialling sequence numbers as you would normally, but remember that each Speed-Dial number counts as one number, so the number of locations you can store becomes limited.
- If the memory is full, press **Stop/Exit** to stop the job or if more than one page has been scanned, press **Mono Start** to send the portion that is in the memory.

## Overseas Mode

---

If you are having difficulty sending a fax overseas due to possible interference on the phone line, we recommend that you turn on the Overseas Mode. After you send a fax using this feature, the feature will turn itself off.

- 1 If it is not illuminated in green, press  (**Fax**).
- 2 Load your document.
- 3 For MFC-210C, press **Menu/Set, 2, 2, 4**.  
For MFC-410CN, press **Menu/Set, 2, 2, 7**.
- 4 Press **▲** or **▼** to select **On** (or **Off**).  
Press **Menu/Set**.

## Delayed Fax (Not available for colour faxes) (MFC-410CN only)

---

During the day you can store up to 50 faxes in the memory to be sent within 24 hours. These faxes will be sent at the time of day you enter in Step 4.

**1** If it is not illuminated in green, press  (**Fax**).

**2** Load your document.

**3** Press **Menu/Set**, **2**, **2**, **3**.

**4** Press **Menu/Set** to accept the displayed time.

Setup Send  
3.Delayed Fax

—OR—

Enter the time you want the fax to be sent (in 24-hour format).

Press **Menu/Set**.

(For example, enter 19:45 for 7:45 PM.)



The number of pages you can scan into the memory depends on the amount of data that is printed on each page.

## Delayed Batch Transmission (Not available for colour faxes) (MFC-410CN only)

---

Before sending the delayed faxes, your MFC will help you economize by sorting all the faxes in the memory by destination and scheduled time. All delayed faxes that are scheduled to be sent at the same time to the same fax number will be sent as one fax to save transmission time.

- 1 If it is not illuminated in green, press  (**Fax**).
- 2 Press **Menu/Set, 2, 2, 4**.
- 3 Press **▲** or **▼** to select **On** (or **Off**).  
Press **Menu/Set**.
- 4 Press **Stop/Exit**.

Setup Send  
4.Batch TX

## Setup for Polled Transmit (Standard) (Not available for colour faxes) (MFC-410CN only)

---

Polled Transmit is when you set up the MFC to wait with a document so another fax machine can retrieve it.

- 1 If it is not illuminated in green, press  (**Fax**).
- 2 Load your document.
- 3 Press **Menu/Set, 2, 2, 6**.
- 4 Press **▲** or **▼** to select **Standard**.  
Press **Menu/Set**.

## Setup for Polled Transmit with Secure Code (Not available for colour faxes) (MFC-410CN only)

---

When you choose `Polled TX:Secure`, anyone who polls the machine must enter the polling secure code.

- 1** If it is not illuminated in green, press  (**Fax**).
- 2** Load your document.
- 3** Press **Menu/Set, 2, 2, 6**.
- 4** Press **▲** or **▼** to select `Secure`.  
Press **Menu/Set**.
- 5** Enter a four-digit number.  
Press **Menu/Set**.

 The document will be stored and can be retrieved from any other fax machine until you delete the fax in memory by using the Cancelling a job menu setting. (See *Cancelling a scheduled job* on page 3-9.)

 You can use Secure Polling only with another Brother fax machine.

# TX Lock

---

TX Lock lets you prevent unauthorized access to the MFC.

While TX Lock is On the following operations are available:

- Receiving faxes
- Fax Forwarding (If Fax Forwarding was already On)  
(MFC-410CN only)
- Remote Retrieval (If Fax Storage was already On)  
(MFC-410CN only)

While TX Lock is On the following operations are NOT available:

- Sending faxes
- Copy
- PC printing
- PC scanning
- PhotoCapture



(MFC-410CN only)

You will not be able to continue to schedule Delayed Faxes or Polling jobs. However, any pre-scheduled Delayed Faxes will be sent when you turn TX Lock On, so they won't be lost.

If you have selected Fax Forwarding or Fax Storage (**Menu/Set, 2, 5**) *before* you turn TX Lock On, then Fax Forwarding and Remote Retrieval will continue to work.



To print the faxes in memory, turn TX Lock **Off**.

## Setting up the password



If you forget the TX Lock password, please contact your Brother dealer or Brother for assistance.

- 1** Press **Menu/Set, 2, 0, 1**.
- 2** Enter a 4-digit number for the password.  
Press **Menu/Set**.
- 3** If the LCD shows *Verify :*, re-enter the password.  
Press **Menu/Set**.

## Changing the TX Lock password

- 1** Press **Menu/Set, 2, 0, 1**.
- 2** Press **▲** or **▼** to select *Set Password*.  
Press **Menu/Set**.
- 3** Enter a 4-digit number for the current password.  
Press **Menu/Set**.
- 4** Enter a 4-digit number for a new password.  
Press **Menu/Set**.
- 5** If the LCD shows *Verify :*, re-enter the password.  
Press **Menu/Set**.

## Turning TX Lock on

- 1** Press **Menu/Set, 2, 0, 1**.
- 2** Press **▲** or **▼** to select *Set TX Lock*.  
Press **Menu/Set**.
- 3** Enter the registered 4-digit password.  
Press **Menu/Set**.  
The MFC goes offline and the LCD shows *TX Lock Mode*.



## Turning TX Lock off

- 1 Press **Menu/Set**.
- 2 Enter the registered 4-digit password.  
Press **Menu/Set**.  
TX lock is automatically turned off.



If you enter the wrong Password, the LCD shows *Wrong Password* and stays offline. The MFC will stay in TX Lock Mode until the registered password is entered.

## Faxing letter size documents from the scanner glass

---

When documents are letter size, you need to set Scan Glass Size to letter, if you do not, the side portion of the faxes will be missing.

- 1 Press **Menu/Set, 2, 2, 0**.
- 2 Press **▲** or **▼** to select *Letter* (or *A4*).  
Press **Menu/Set**.
- 3 Press **Stop/Exit**.

# 4 Setup Receive

## Basic receiving operations

### Choosing the Receive Mode

---

There are four different Receive Modes for your MFC. You can choose the mode that best suits your needs.

<b>LCD</b>	<b>How it works</b>	<b>When to use it</b>
Fax Only (automatic receive)	The MFC automatically answers every call as a fax.	For dedicated fax lines.
Fax/Tel (fax and telephone)  (with an external or extension telephone for models without a handset)	The MFC controls the line and automatically answers every call. If the call is a fax it will receive the fax. If the call is not a fax it will ring (pseudo/double ring) for you to pick up the call.	Use this mode if you expect to receive lots of fax messages and few telephone calls. You cannot have an answering machine on the same line, even if it is on a separate wall socket/phone socket on the same line. You cannot use the telephone company's Voice Mail in this mode.
External TAD (with an external answering machine only)	The external answering machine (TAD) automatically answers every call. Voice messages are stored on the external TAD. Fax messages are printed.	Use this mode if you have connected an answering machine to your MFC. The External TAD setting works only with an external answering machine. Ring Delay does not work in this setting.
Manual (manual receive) (with an external or extension telephone for models without a handset or with BT Call Sign)	You control the phone line and must answer every call yourself.	Use this mode if you do not receive many fax messages, use BT Call Sign, or if you are using a computer on the same line. If you answer and hear fax tones, wait until the MFC takes over the call, then hang up. (See <i>Fax Detect</i> on page 4-4.)

## To select or change your Receive Mode

- 1 If it is not illuminated in green, press  (**Fax**).
- 2 Press **Menu/Set, 0, 1**.
- 3 Press **▲** or **▼** to select **Fax Only**, **Fax/Tel**, **External TAD** or **Manual**.  
Press **Menu/Set**.
- 4 Press **Stop/Exit**.

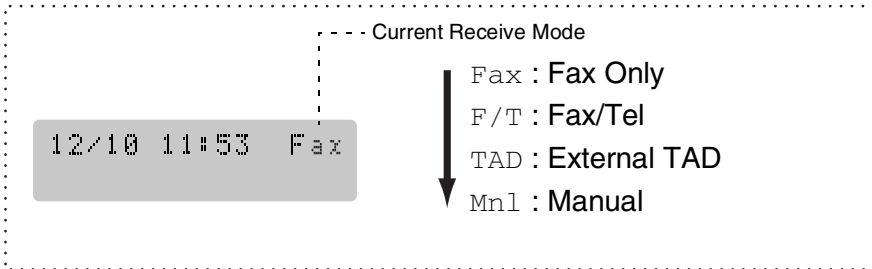

## Setting the Ring Delay

The Ring Delay sets the number of times the MFC rings before it answers in **Fax Only** or **Fax/Tel** mode. If you have extension phones on the same line as the MFC or subscribe to the telephone company's BT Call Sign service, keep the Ring Delay setting of 4. (See *Operation from extension telephones* on page A-2 and *Fax Detect* on page 4-4.)

- 1 If it is not illuminated in green, press  (**Fax**).
- 2 Press **Menu/Set, 2, 1, 1**.
- 3 Press **▲** or **▼** to select how many times the line rings before the MFC answers (00 - 04 UK only)(00 - 05 Nordic countries only).  
Press **Menu/Set**.  
(If you select 00, the line won't ring at all.)
- 4 Press **Stop/Exit**.

## Setting the F/T Ring Time (Fax/Tel mode only)

---

If you set the Receive Mode to Fax/Tel, you'll need to decide how long the MFC will signal you with its special pseudo/double-ring when you have a *voice* call. (If it's a fax call, the MFC prints the fax.)

This pseudo/double-ring happens after the initial ringing from the phone company. Only the MFC rings and no other phones on the same line will ring with the special pseudo/double-ring. However, you can still answer the call on any telephone on the same line as the MFC. (See *For Fax/Tel mode only* on page A-2.)

- 1** If it is not illuminated in green, press  **(Fax)**.
- 2** Press **Menu/Set, 2, 1, 2**.
- 3** Press **▲** or **▼** to select how long the MFC will ring to alert you that you have a voice call (20, 30, 40 or 70 seconds).  
Press **Menu/Set**.
- 4** Press **Stop/Exit**.

 Even if the caller hangs up during the pseudo/double-ringing, the MFC will continue to ring for the set time.

## Fax Detect

---

When you use this feature, you don't have to press **Mono Start**, **Colour Start**, or the Fax Receive Code \* 51 when you answer a fax call. Selecting **On** allows the MFC to receive fax calls automatically, even if you lift the handset of an extension or external phone. When you see **Receiving** on the LCD or when you hear 'chirps' through the handset of an extension phone connected to another wall socket/phone socket, just replace the handset and your MFC will do the rest.



- If this feature is set to **On**, but your MFC does not connect a fax call when you lift an extension or external phone handset, press the Fax Receive Code \* 51.
- If you send faxes from a computer on the same phone line and the MFC intercepts them, set Fax Detect to **Off**.
- Selecting **Off** means you'll have to activate the MFC yourself by lifting the handset of an external or extension phone, and then press **Mono Start** or **Colour Start** on the MFC  
—OR—  
by pressing \* 51 if you are not at your MFC. (See *Operation from extension telephones* on page A-2.)

- 1 If it is not illuminated in green, press  (**Fax**).
- 2 Press **Menu/Set**, **2**, **1**, **3**.
- 3 Use **▲** or **▼** to select **On** (or **Off**).  
Press **Menu/Set**.
- 4 Press **Stop/Exit**.

## Printing a reduced incoming fax (Auto Reduction)

---

If you choose **On**, the MFC automatically reduces an incoming fax to fit on one page of A4, Letter or Legal size paper. The MFC calculates the reduction ratio by using the page size of the document and your Paper Size setting (**Menu/Set, 1, 3**).

**1** If it is not illuminated in green, press  (**Fax**).

**2** Press **Menu/Set, 2, 1, 5**.

**3** Use **▲** or **▼** to select **On** (or **Off**).

Setup Receive  
5.Auto Reduction

Press **Menu/Set**.

**4** Press **Stop/Exit**.



■ Turn on this setting if you receive faxes that are split onto two pages. However, if the document is too long the MFC may still print it on two pages.

■ If left and right margins are cut off, turn on this setting.

## Printing a fax from the memory (MFC-410CN only)

---

If you have selected Fax Forwarding or Fax Storage (**Menu/Set, 2, 5, 1**), you can still print a fax from the memory when you are at your MFC. (See *Setting Fax Storage* on page 6-2.)

**1** Press **Menu/Set, 2, 5, 3**.

**2** Press **Mono Start**.

## Reception into memory (Not available for colour fax reception)

---

As soon as the paper tray becomes empty during fax reception, the screen will display *No Paper Fed*; please put some paper in the paper tray. (See *How to load paper, envelopes and post cards* on page 1-12.)

### If the **Memory Receive** is **On** at this time...

The current fax reception will continue, with the remaining page(s) being stored in memory, subject to available memory. Subsequent incoming faxes will also be stored into memory until the memory is full, following this no further incoming fax calls will be automatically answered. To print all data put fresh paper in the paper tray and press **Mono Start** or **Colour Start**.

### If the **Memory Receive** is **Off** at this time...

The current fax reception will continue, with the remaining page(s) being stored in memory, subject to available memory. Subsequent incoming fax calls will not be automatically answered until fresh paper is put in the paper tray. To print the last fax received, put paper in the paper tray and press **Mono Start** or **Colour Start**.

- 1 If it is not illuminated in green, press  (**Fax**).
- 2 Press **Menu/Set**, **2**, **1**, **6**.
- 3 Use **▲** or **▼** to select **On** (or **Off**).  
Press **Menu/Set**.
- 4 Press **Stop/Exit**.

## Polling (MFC-410CN only)

---

Polling is the process of retrieving faxes from another fax machine. You can use your MFC to 'poll' other machines, or you can have someone poll your MFC.

Everyone who is involved in Polling needs to set up their fax machines for Polling. When someone polls your MFC to receive a fax, they pay for the call. If you poll someone's fax machine to receive a fax, you pay for the call.



Some fax machines do not respond to the Polling feature.

### Secure Polling

Secure Polling is a way to keep your documents and others from falling into the wrong hands while the MFC is set up for polling. You can use Secure Polling only with another Brother fax machine. Anyone who polls to receive a fax must enter the polling secure code.

### Setup for Polling Receive (Standard)

Polling Receive is when you call another fax machine to receive a fax from it.

- 1** If it is not illuminated in green, press  **(Fax)**.
- 2** Press **Menu/Set**, **2**, **1**, **7**.
- 3** Press **▲** or **▼** to select **Standard**.  
Press **Menu/Set**.
- 4** Enter the fax number you are polling.  
Press **Mono Start** or **Colour Start**.



## Setup for Polling Receive with Secure Code

You need to make sure you are using the same secure code as the other party.

- 1 If it is not illuminated in green, press  (**Fax**).
- 2 Press **Menu/Set, 2, 1, 7**.
- 3 Press **▲** or **▼** to select *Secure*.  
Press **Menu/Set**.
- 4 Enter a four-digit secure code.  
This is the same as the security code of the fax machine you are polling.
- 5 Press **Menu/Set**.
- 6 Enter the fax number you are polling.
- 7 Press **Mono Start** or **Colour Start**.

## Setup Delayed Polling Receive

You can set the MFC to begin Polling Receive at a later time.



- 1 If it is not illuminated in green, press  (**Fax**).
- 2 Press **Menu/Set, 2, 1, 7**.
- 3 Press **▲** or **▼** to select *Timer*.  
Press **Menu/Set**.
- 4 Enter the time (in 24-hour format) you want to begin polling.  
For example, enter 21:45 for 9:45 PM.
- 5 Press **Menu/Set**.
- 6 Enter the fax number you are polling.  
Press **Mono Start** or **Colour Start**.  
The MFC makes the polling call at the time you entered.



You can set up only one Delayed Polling.

## Sequential Polling

The MFC can request documents from several fax units in a single operation. You just specify several destinations in Step 5. Afterwards, a Sequential Polling Report will be printed.

- 1** If it is not illuminated in green, press  (**Fax**).
  - 2** Press **Menu/Set, 2, 1, 7**.
  - 3** Press **▲** or **▼** to choose *Standard*, *Secure* or *Timer*.  
Press **Menu/Set** when the screen displays the setting you want.
  - 4** If you selected *Standard*, go to Step 5.
    - If you selected *Secure*, enter a four-digit number and press **Menu/Set**, and then go to Step 5.
    - If you selected *Timer*, enter the time (in 24-hour format) you want to begin polling and press **Menu/Set**, and then go to Step 5.
  - 5** Specify the destination fax machines, which you wish to poll by using *Speed-Dial*, *Search*, a *Group* (see *Setting up Groups for Broadcasting* on page 5-3) or the dial pad. You must press **Menu/Set** between each location.
  - 6** Press **Mono Start** or **Colour Start**.  
The MFC polls each number or group in turn for a document.
-  Press **Stop/Exit** while the MFC is dialling to cancel the polling process.
- To cancel all sequential polling receive jobs, press **Menu/Set, 2, 6**. (See *Cancelling a scheduled job* on page 3-9.)

# 5 Quick-Dial numbers and dialling options

## Storing numbers for easy dialling

You can set up your MFC to do two types of easy dialling: Speed-Dial and Groups for Broadcasting faxes. When you dial a quick-dial number, the LCD shows the name, if you stored it, or the number.



*If you lose electrical power, the quick-dial numbers that are in the memory will not be lost.*

## Storing Speed-Dial numbers

---

You can store Speed-Dial numbers, so that when you dial you will only have to press a few keys (**Search/Speed Dial**, **#**, the two-digit number, and **Mono Start** or **Colour Start**). The MFC-210C can store 20 Speed-Dial numbers and the MFC-410CN can store 80 numbers.

- 1 Press **Menu/Set**, **2**, **3**, **1**.
- 2 Use the dial pad to enter a two-digit Speed-Dial location number (01-20 for MFC-210C, 01-80 for MFC-410CN).  
(For example, press **05**.)  
Press **Menu/Set**.
- 3 Enter the phone or fax number (up to 20 digits).  
Press **Menu/Set**.
- 4 Use the dial pad to enter the name (up to 15 characters).  
Press **Menu/Set**.  
(You can use the chart on page B-12 to help you enter letters.)  
—OR—  
Press **Menu/Set** to store the number without a name.
- 5 Go to Step 2 to store another Speed-Dial number.  
—OR—  
Press **Stop/Exit**.

## Changing Speed-Dial numbers

---

If you try to store a Speed-Dial number where a number has already been stored, the LCD will show the name that has been stored there (or number) and will ask you to do one of the following:

**1** Press **1** to change the stored number.

—OR—

Press **2** to exit without making a change.

*How to change the stored number or name:*

- If you want to change a character, use ◀ or ▶ to position the cursor under the character you want to change, and then type over it.
- If you want to erase the whole number or whole name, press **Stop/Exit** when the cursor is under the first digit or letter. The characters above and to the right of the cursor will be deleted.

**2** Enter a new number.

Press **Menu/Set**.

**3** Follow the directions beginning at Step 4 in Storing Speed-Dial numbers. (See page 5-1.)

## Setting up Groups for Broadcasting

---

Groups allow you to send the same fax message to many fax numbers by pressing only a few keys (**Search/Speed Dial**, **#**, the two-digit number, and **Mono Start**). First, you'll need to store each fax number as a Speed-Dial number.

Then, you can combine them into a Group. Each Group uses up a Speed-Dial number. You can have up to six Groups, or you can assign up to 19 numbers (MFC-210C) or up to 79 numbers (MFC-410CN) to one large Group.

(See *Storing Speed-Dial numbers* on page 5-1 and *Broadcasting* (Not available for colour faxes) on page 3-10.)

- 1 Press **Menu/Set**, **2**, **3**, **2**.

Set Quick-Dial  
2.Setup Groups

- 2 Use the dial pad to enter the two-digit Speed-Dial number where you want to store the Group.

Setup Groups  
Speed-Dial? #

Press **Menu/Set**.

(For example, press **07** and **Menu/Set**.)

- 3 Use the dial pad to enter the Group number (1 to 6).

Setup Groups  
Setup Group:G01

Press **Menu/Set**.

(For example, press **1** for Group 1.)



The Group number must be between 1 and 6.

- 4 To include Speed-Dial numbers in the Group, press them as follows:

Setup Groups  
G01:#05#09

For example, for Speed-Dial

numbers 05 and 09. Press **Search/Speed Dial**, **05**, **Search/Speed Dial**, **09**. The LCD shows: #05#09.

- 5 Press **Menu/Set** to accept the Speed-Dial numbers for this Group.
  - 6 Use the dial pad and the chart on page B-12 to enter a name for the Group.  
Press **Menu/Set**.  
(For example, type NEW CLIENTS).
  - 7 Press **Stop/Exit**.
-  You can print a list of all the Speed-Dial numbers. Group numbers will be marked in the GROUP column.  
(See *Printing reports* on page 7-3.)

# Dialling options



There are two ways to dial. (See *How to dial* on page 3-1.)

## Access codes and credit card numbers

---

Sometimes you may want to choose from several long distance carriers when you make a call. Rates may vary depending on the time and destination. To take advantage of low rates, you can store the access codes or long-distance carriers and credit card numbers as Speed-Dial numbers. You can store these long dialling sequences by dividing them and setting them up on separate Speed Dial numbers in any combination. You can even include manual dialling using the dial pad. (See *Storing Speed-Dial numbers* on page 5-1.)

For example, perhaps you have stored '555' on Speed-Dial #03 and '7000' on Speed-Dial #02. If you press **Search/Speed Dial, #03**, **Search/Speed Dial, #02**, and **Mono Start** or **Colour Start**, you will dial '555-7000'.

To temporarily change a number, you can substitute part of the number with manual dialling using the dial pad.

For example, to change the number to 555-7001 you could press **Search/Speed Dial, #03** and then press **7001** using the dialling pad.



If you must wait for another dial tone or signal at any point in the dialling sequence, store a pause in the number by pressing **Redial/Pause**. Each key press adds a 3.5-second delay.

## Pause

---

Press **Redial/Pause** to insert a 3.5-second pause between numbers. If you are dialling overseas, you can press **Redial/Pause** as many times as needed to increase the length of the pause.

## Tone or Pulse

---

If you have a Pulse dialling service, but need to send Tone signals (for example, for telephone banking), follow the instructions below. If you have Touch Tone service, you will not need this feature to send tone signals.

- 1** Lift the handset of the external phone.
- 2** Press # on the MFC's control panel. Any digits dialled after this will send tone signals.

When you hang up, the MFC will return to the Pulse dialling service.



# 6

## Remote Fax Options (MFC-410CN only) (Not available for colour faxes)

### Setting up Fax Forwarding

---

When you select Fax Forward, your MFC stores the received fax in the memory. The MFC will then dial the fax number you've programmed and forward the fax message.

- 1 Press **Menu/Set**, **2**, **5**, **1**.
- 2 Press **▲** or **▼** to select `Fax Forward`.  
Press **Menu/Set**.

The LCD will ask you to enter the fax number to which faxes will be forwarded.

- 3 Enter the forwarding number (up to 20 digits).  
Press **Menu/Set**.

- 4 Press **▲** or **▼** to select `Backup Print:On` or `Backup Print:Off`.  
Press **Menu/Set**.

<code>Fax Forward</code> <code>Backup Print:On</code>
--



If you select `Backup Print:On`, the MFC will also print the fax at your MFC so you will have a copy if there is a power failure before it is forwarded.

- 5 Press **Stop/Exit**.

## Setting Fax Storage

---

If you select Fax Storage, your MFC stores the received fax in the memory. You will be able to retrieve fax messages from another location using the Remote Retrieval commands.

- 1 Press **Menu/Set**, **2**, **5**, **1**.
- 2 Press **▲** or **▼** to select `Fax Storage`.  
Press **Menu/Set**.
- 3 Press **Stop/Exit**.



If you have set Fax Storage, a backup copy of the received fax will automatically be printed at the MFC.

## Setting PC Fax Receive

---

If you select PC Fax Receive, your MFC will temporarily store your received fax messages in its memory, and then automatically send the faxes to the PC. You can then use your PC to view and store these faxes.

- 1 Press **Menu/Set**, **2**, **5**, **1**.
- 2 Press **▲** or **▼** to select `PC Fax Receive`.  
Press **Menu/Set**.
- 3 Press **▲** or **▼** to select `Backup Print:On` or `Backup Print:Off`.  
Press **Menu/Set**.
- 4 Press **Stop/Exit**.

<code>PC Fax Receive</code> <code>Backup Print:On</code>
---



- Before you can set up PC Fax Receive you must install the MFL-Pro Suite software on your PC. Make sure your PC is connected and turned on. (For details see *Using Brother PC-FAX software* on page 5-1 in Software User's Guide on the CD-ROM.)
- If you select `Backup Print:On`, the MFC will also print the fax at your MFC so you will have a copy if there is a power failure before it is sent to the PC.
- If you get an error message and the MFC cannot print the faxes in memory, you can use this setting to transfer your faxes to your PC. (For details, see *Error messages* on page 11-1.)

## Turning off Remote Fax Options

---

If you set the Remote Fax Options to **Off** and there are faxes in your MFC's memory, the LCD will give you two options.

- If you press **1**, all unprinted faxes will be printed and erased before the setting turns off. If a backup copy has already been printed it will not be printed again.
- If you press **2**, the memory will not be erased and the setting will be unchanged.

(See *Printing a fax from the memory (MFC-410CN only)* on page 4-5.)

## Setting your Remote Access Code

---

The remote access code lets you access the Remote Retrieval features when you are away from your MFC. Before you use the remote access and retrieval features, you have to set up your own code. The default code is inactive code (--- \*).

**1** Press **Menu/Set, 2, 5, 2**.

**2** Enter a three-digit code using numbers **0-9** or **\***.

Press **Menu/Set**. (The preset '**\***' cannot be changed.)



Do not use the same code used for your Fax Receive Code (**\*51**) or Telephone Answer Code (**#51**).

(See *Operation from extension telephones* on page A-2.)

**3** Press **Stop/Exit**.



You can change your code at any time by entering a new one. If you want to make your code inactive, press **Stop/Exit** in Step 2 to restore the inactive setting (--- \*).

# Remote Retrieval

You can call your MFC from any touch tone telephone or fax machine, then use the Remote Access Code and remote commands to retrieve fax messages.

## Using your Remote Access Code

---

- 1** Dial your fax number from a telephone or another fax machine using touch tone.
  - 2** When your MFC answers, immediately enter your Remote Access Code (3 digits followed by \*).
  - 3** The MFC signals if it has received fax messages:
    - 1 long beep — Fax messages**
    - No beeps — No messages**
  - 4** The MFC gives two short beeps to tell you to enter a command. The MFC will hang up if you wait longer than 30 seconds to enter a command. The MFC will beep three times, if you enter an invalid command.
  - 5** Press **90** to reset the MFC when you've finished.
  - 6** Hang up.
-  If your MFC is set to `Manual` mode and you want to use the remote retrieval features, you can access your MFC by waiting about 2 minutes after it starts ringing, and then entering the Remote Access Code within 30 seconds.

## Remote commands

Follow the commands below to access features when you are away from the MFC. When you call the MFC and enter your Remote Access Code (3 digits followed by \*), the system will give two short beeps and you must enter a remote command.

Remote commands	Operation details
<b>95 Change the Fax Forwarding or Fax Storage settings</b>	
1 OFF	You can select OFF after you have retrieved or erased all your messages.
2 Fax Forwarding	If you hear one long beep, the change has been accepted. If you hear three short beeps, you cannot change it because the conditions have not been met (for example, registering a Fax Forwarding number). You can register your Fax Forwarding number by entering 4. (See <i>Changing your Fax Forwarding number</i> on page 6-6.) Once you have registered the number, Fax Forwarding will work.
4 Fax Forwarding number	
6 Fax Storage	
<b>96 Retrieve a fax</b>	
2 Retrieve all faxes	Enter the number of a remote fax machine to receive stored fax message(s). (See page 6-6.)
3 Erase faxes from the memory	If you hear one long beep, fax messages have been erased from the memory.
<b>97 Check the receiving status</b>	
1 Fax	You can check whether your MFC has received any faxes. If yes, you will hear one long beep. If no, you will hear three short beeps.
<b>98 Change the Receive Mode</b>	
1 External TAD	If you hear one long beep, your change has been accepted.
2 Fax/Tel	
3 Fax Only	
<b>90 Exit</b>	Press <b>90</b> to exit Remote Retrieval. Wait for the long beep, then replace the handset.

## Retrieving fax messages

---

You can call your MFC from any touch tone phone and have your fax messages sent to a fax machine.

- 1** Dial your fax number.
  - 2** When your MFC answers, immediately enter your Remote Access Code (3 digits followed by \* ). If you hear one long beep, you have messages.
  - 3** As soon as you hear two short beeps, use the dial pad to press **962**.
  - 4** Wait for the long beep, and then use the dial pad to enter the number of the remote fax machine where you want your fax messages sent to followed by ## (up to 20 digits).
-  You cannot use \* and # as dial numbers. However, press # if you want to store a pause.
- 5** Hang up after you hear your MFC beep. Your MFC will call the other machine, which will then print your fax messages.

## Changing your Fax Forwarding number

---

You can change the default setting of your fax forwarding number from another telephone or fax machine using touch tone.

- 1** Dial your fax number.
  - 2** When your MFC answers, immediately enter your Remote Access Code (3 digits followed by \* ). If you hear one long beep, you have messages.
  - 3** When you hear two short beeps, use the dial pad to press **954**.
  - 4** Wait for the long beep, and then use the dial pad to enter the new number of the remote fax machine where you want your fax messages forwarded followed by ## (up to 20 digits).
-  You cannot use \* and # as dial numbers. However, press # if you want to store a pause.
- 5** Hang up after you hear your MFC beep.

# 7 Printing reports

## Fax settings and activity

You need to set up the Transmission Verification Report and Journal Period in the menu table.

Press **Menu/Set, 2, 4, 1.**

—OR—

Press **Menu/Set, 2, 4, 2.**

## Customizing the Transmission Verification Report

---

You can use the Transmission Report as proof that you sent a fax. This report lists the time and date of transmission and whether the transmission was successful (OK). If you select **On** or **On+Image**, the report will print for every fax you send.

If you send a lot of faxes to the same place, you may need more than the job numbers to know which faxes you must send again. Selecting **On+Image** or **Off+Image** will print a section of the fax's first page on the report to help you remember.



When the Verification Report is turned **Off** or **Off+Image**, the Report will only print if there is a transmission error, with NG in the RESULT column.

- 1 Press **Menu/Set, 2, 4, 1.**
- 2 Press **▲** or **▼** to select **Off+Image, On, On+Image** or **Off.**  
Press **Menu/Set.**
- 3 Press **Stop/Exit.**

## Setting the Journal Period

---

You can set the MFC to print a journal at specific intervals (every 50 faxes, 6, 12 or 24 hours, 2 or 7 days). If you set the interval to `Off`, you can print the report by following the steps on the next page.

The default setting is `Every 50 Faxes`.

**1** Press **Menu/Set**, **2**, **4**, **2**.

Report Setting  
2.Journal Period

**2** Press **▲** or **▼** to choose an interval.

Press **Menu/Set**.

(If you choose 7 days, the LCD will ask you to choose a day on which to begin the 7-day countdown.)

**3** Enter the time to begin printing in 24-hour format.

Press **Menu/Set**.

(For example: enter 19:45 for 7:45 PM.)

**4** Press **Stop/Exit**.



If you select 6, 12, 24 hours, 2 or 7 days, the MFC will print the report at the selected time and then erase all jobs from its memory. If the MFC's memory becomes full with 200 jobs before the time you selected has passed, the MFC will print the Journal early and then erase all jobs from memory. If you want an extra report before it is due to print, you can print it without erasing the jobs from memory.



If you select `Every 50 Faxes`, the MFC will print the Journal when the MFC has stored 50 jobs.



## Printing reports

---

Following reports are available:

- |                                       |   |
|---------------------------------------|---|
| 1. Help List                          | Prints the Help List so you can see at-a-glance how to quickly program your MFC.                          |
| 2. Quick-Dial                         | Lists names and numbers stored in the Speed-Dial memory, in numerical order.                              |
| 3. Fax Journal                        | Lists information about the last incoming and outgoing faxes.<br>(TX means Transmit.) (RX means Receive.) |
| 4. XMIT Verify                        | Prints a Transmission Verification Report for your last transmission.                                     |
| 5. User Settings<br>(MFC-410CN only)  | Lists your settings.  |
| 6. Network Config<br>(MFC-410CN only) | Lists your Network settings.  |

### How to print a report

- 1 For MFC-210C, press **Menu/Set, 5**.  
For MFC-410CN, press **Menu/Set, 6**.
- 2 Press **▲** or **▼** to select the report you want.  
Press **Menu/Set**.  
**—OR—**  
Enter the number of the report you want to print.  
For example, press **1** to print the Help List.
- 3 Press **Mono Start**.



# 8 Making copies

## Using the MFC as a copier

You can use your MFC as a copier, making up to 99 copies at a time.

### Enter Copy mode

---

Before making copies, make sure that  (**Copy**) is illuminated in green. If it is not, press  (**Copy**) to enter **Copy** mode. The default setting is Fax. You can change the number of seconds or minutes that the MFC stays in Copy mode. (See *Setting the Mode Timer* on page 2-4.)

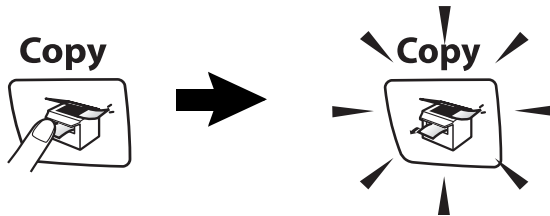

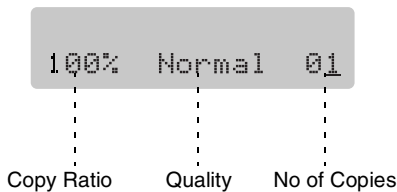

The LCD shows the default copy setting



## Making a single copy

---

- 1 Press  (**Copy**) to illuminate it in green.
  - 2 Load your document.  
(See *Load documents* on page 1-6.)
  - 3 Press **Mono Start** or **Colour Start**.
-  To stop copying, press **Stop/Exit**.

## Making multiple copies

---

- 1 Press  (**Copy**) to illuminate it in green.
- 2 Load your document.
- 3 Use the dial pad to enter the number of copies you want (up to 99).
- 4 Press **Mono Start** or **Colour Start**.

## Stop copying



---

To stop copying, press **Stop/Exit**.

# Using the Copy Options key (Temporary settings)







When you want to quickly change the copy settings temporarily for the next copy, use the **Copy Options** key. You can use different combinations.



-  These settings are temporary, and the MFC returns to its default settings 60 seconds after it finishes copying. However if you have set the Mode Timer to 0 or 30 seconds, the MFC returns to the default settings after the number of seconds that has been set for mode timer. (See *Setting the Mode Timer* on page 2-4.)
-  You can save the copy settings you use most often by setting them as default. (See *Changing the default copy settings* on page 8-12.)

## Changing the temporary copy settings

Use the **Copy Options** key to quickly set the following copy settings temporarily for the next copy.

Press Copy Options  	<b>Menu Selections</b>  →   select	<b>Options</b>  →   select	<b>Factory Setting</b>	<b>Page</b>
	Quality	Fast/Normal/Best	Normal	8-5
	Enlarge/Reduce	50%/69%/78%/83%/93%/97%/100%/104%/142%/186%/198%/200%/Custom(25-400%)	100%	8-6
	Paper Type	Plain/Inkjet/ Glossy/ Transparency	Plain	8-7
	Paper Size	Letter/Legal/ A4/A5/ 10 (W) x 15 (H) cm	A4	8-8
	Brightness	- ■■■■ +	- ■■■■ +	8-8
	Page Layout (MFC-410CN only)	Off(1 in 1)/ 2 in 1 (P)/ 2 in 1 (L)/ 4 in 1 (P)/ 4 in 1 (L)/ Poster(3 x 3)	Off (1 in 1)	8-12
	No. of Copies	No. of Copies:01 (01-99)	01	

After you choose your settings by pressing **Menu/Set**, the LCD shows Set temporarily.

Press **Mono Start** or **Colour Start** if you're finished choosing settings.

—OR—

Press ▲ or ▼ to select more settings.

## Increasing copy speed or quality

You can select the copy quality. The default setting is *Normal*.

Normal	Recommended mode for ordinary printouts. Good copy quality with adequate copy speed.
Fast	Fast copy speed and lowest ink consumption. Use FAST to save time (document to be proof-read, large documents or many copies).
Best	Use this mode to copy precise images such as photographs. BEST uses the highest resolution and slowest speed.

- 1 Press  (**Copy**) to illuminate it in green.
- 2 Load your document.
- 3 Use the dial pad to enter the number of copies you want (up to 99).
- 4 Press **Copy Options** and ▲ or ▼ to select *Quality*.  
Press **Menu/Set**.
- 5 Press ▲ or ▼ to choose the copy quality (*Fast*, *Normal* or *Best*).  
Press **Menu/Set**.
- 6 Press **Mono Start** or **Colour Start**.

## Enlarging or reducing the image copied

You can select the following enlargement or reduction ratios.

Custom(25-400%) allows you to enter a ratio from 25% to 400%.

<p><b>Press Copy Options</b></p> <p><b>Copy Options</b></p>  <p>and ▲ or ▼ to select Enlarge/Reduce</p>	Custom(25-400%)
	200%
	198% 10x15cm→A4
	186%10x15cm→LTR
	142% A5→A4
	104% EXE→LTR
	100%
	97% LTR→A4
	93% A4→LTR
	83%
	78%
	69% A4→A5
	50%

- 1 Press  (**Copy**) to illuminate it in green.
- 2 Load your document.
- 3 Use the dial pad to enter the number of copies you want (up to 99).
- 4 Press **Copy Options** and ▲ or ▼ to select Enlarge/Reduce. Press **Menu/Set**.

- 5 Press ▲ or ▼ to select the enlargement or reduction ratio you want.

Press **Menu/Set**.

—OR—

You can select *Custom* (25-400%) and press **Menu/Set**.

Use the dial pad to enter an enlargement or reduction ratio from 25% to 400%.

Press **Menu/Set**.

(For example, press **5 3** to enter 53%.)

- 6 Press **Mono Start** or **Colour Start**.

 Special Copy Options 2 in 1 (P), 2 in 1 (L), 4 in 1 (P), 4 in 1 (L) or Poster are not available with Enlarge/Reduce.

## Setting paper type

If you are copying on special paper, be sure to select the type of paper you are using so you will get the best print quality.

- 1 Press  (**Copy**) to illuminate it in green.
- 2 Load your document.
- 3 Use the dial pad to enter the number of copies you want (up to 99).
- 4 Press **Copy Options** and ▲ or ▼ to select *Paper Type*.  
Press **Menu/Set**.
- 5 Press ▲ or ▼ to select the type of paper you are using (*Plain, Inkjet, Glossy or Transparency*).  
Press **Menu/Set**.
- 6 Press **Mono Start** or **Colour Start**.

 You can change the default Paper Type setting at any time.  
(See *Setting the Paper Type* on page 2-4.)



## Setting paper size

If copying on paper other than A4 size, you will need to change the paper size setting.



You can copy on Letter, Legal, A4, A5 or Photo Card (10 (W) cm x 15 (H) cm) paper.

- 1 Press  (**Copy**) to illuminate it in green.
- 2 Load your document.
- 3 Use the dial pad to enter the number of copies you want (up to 99).
- 4 Press **Copy Options** and ▲ or ▼ to select *Paper Size*. Press **Menu/Set**.
- 5 Press ▲ or ▼ to select the size of paper you are using (Letter, Legal, A4, A5 or 10 (W) x 15 (H) cm). Press **Menu/Set**.
- 6 Press **Mono Start** or **Colour Start**.

## Adjusting brightness

You can adjust the copy brightness to make copies darker or lighter.

- 1 Press  (**Copy**) to illuminate it in green.
- 2 Load your document.
- 3 Use the dial pad to enter the number of copies you want (up to 99).
- 4 Press **Copy Options** and ▲ or ▼ to select *Brightness*. Press **Menu/Set**.
- 5 Press ▲ to make a lighter copy.  
—OR—  
Press ▼ to make a darker copy.  
Press **Menu/Set**.
- 6 Press **Mono Start** or **Colour Start**.

## Making N in 1 copies or a poster (Page Layout) (MFC-410CN only)

You can reduce the amount of copies by using the N in 1 copy feature. This allows you to copy two or four pages onto one page, allowing you to save paper. It is also possible to create a poster. When you use the Poster feature your MFC divides your document into sections, then enlarges the sections so you can assemble them into a poster.



- Please make sure Paper Size is set to A4.
- You can use N in 1 copy feature with 100% copy size only.
- (P) means Portrait and (L) means Landscape.

- 1 Press  (**Copy**) to illuminate it in green.
- 2 Load your document.
- 3 Use the dial pad to enter the number of copies you want (up to 99).
- 4 Press **Copy Options** and ▲ or ▼ to select **Page Layout**. Press **Menu/Set**.
- 5 Press ▲ or ▼ to select **2 in 1 (P)**, **2 in 1 (L)**, **4 in 1 (P)**, **4 in 1 (L)**, **Poster (3 x 3)** or **Off (1 in 1)**. Press **Menu/Set**.
- 6 Press **Mono Start** or **Colour Start** to scan the document.
- 7 If you are making a poster, the MFC scans document and starts printing.

—OR—

If you selected the 2 in 1 or the 4 in 1 option, the MFC scans the page and then the LCD shows:

Next Page? 1.Yes 2.No
--------------------------

Press **1** to scan the next page.

**8** Put the next document on the scanner glass.

Set Next Page  
Then Press Set

Press **Menu/Set**.

Repeat Steps 7 and 8 for each page of the layout.

**9** After all the pages of the document have been scanned, press **2** to end.

 If **Glossy** has been selected in the Paper Type setting for N in 1 copies, the MFC will print the images as if Plain paper had been selected.

-  ■ If you are producing multiple colour copies, N in 1 copies are not available.
- For Poster copies, you cannot make more than one copy.

**Place document face down in the direction shown below.**

**2 in 1 (P)**

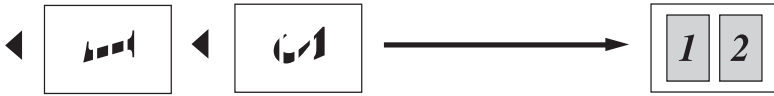

**2 in 1 (L)**

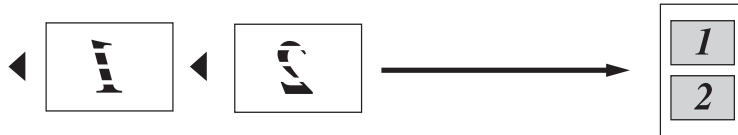

**4 in 1 (P)**



**4 in 1 (L)**



### **Poster (3X3)**

You can make a poster size copy of a photograph.

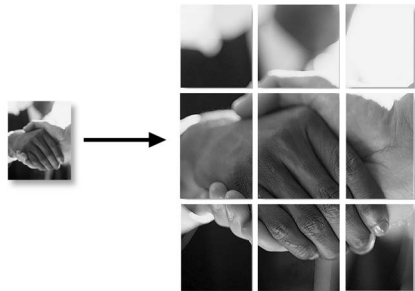

# Changing the default copy settings

You can save the copy settings you use most often by setting them as default. These settings will remain until you change them again.

## Increasing copy speed or quality

---

- 1 Press **Menu/Set**, **3**, **1**.
- 2 Press **▲** or **▼** to select **Normal**, **Best** or **Fast**.  
Press **Menu/Set**.
- 3 Press **Stop/Exit**.

## Adjusting brightness

---

- 1 Press **Menu/Set**, **3**, **2**.
- 2 Press **▲** to make a lighter copy.  
—OR—  
Press **▼** to make a darker copy.  
Press **Menu/Set**.
- 3 Press **Stop/Exit**.

## Adjusting contrast

---

You can change the contrast to help an image look sharper and more vivid.

- 1 Press **Menu/Set**, **3**, **3**.
- 2 Press **▲** to increase the contrast.  
—OR—  
Press **▼** to decrease the contrast.  
Press **Menu/Set**.
- 3 Press **Stop/Exit**.

## Adjusting colour saturation

---

- 1** Press **Menu/Set**, **3**, **4**.
- 2** Press **▲** or **▼** to select **Red**, **Green** or **Blue**.  
Press **Menu/Set**.
- 3** Press **▲** to increase the colour saturation.  
—OR—  
Press **▼** to decrease the colour saturation.  
Press **Menu/Set**.
- 4** Return to Step 2 to select the next colour.  
—OR—  
Press **Stop/Exit**.

# Legal limitations

Colour reproductions of certain documents are illegal and may result in either criminal or civil liability. This memorandum is intended to be a guide rather than a complete listing of every possible prohibition. In case of doubt, we suggest that you check with relevant authorities as to any particular questionable documents.

The following are examples of documents which should not be copied:

- Money
- Bonds or other certificates of indebtedness
- Certificates of Deposit
- Armed Forces Service or Draft papers.
- Passports
- Postage Stamps (cancelled or uncanceled)
- Immigration Papers
- Welfare documents
- Cheques or Drafts drawn by Governmental Agencies
- Identification Documents, badges or insignias
- Licences and Certificates of Title to motor vehicles

Copyrighted works cannot be copied. Sections of a copyrighted work can be copied for 'fair use.' Multiple copies would indicate improper use.

Works of art should be considered the equivalent of copyrighted works.

# 9

# Walk-Up PhotoCapture Center™

## Introduction

Even if your MFC is not connected to your computer, you can print photos directly from the digital camera media. Your Brother MFC includes five media drives (slots) for use with popular digital camera media: CompactFlash®, SmartMedia®, Memory Stick®, SecureDigital™, and xD-Picture Card™.

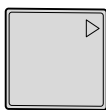

CompactFlash®  
(Type I only)



SmartMedia®



Memory Stick®

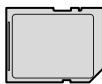

SecureDigital™



xD-Picture Card™

The PhotoCapture Center™ feature lets you print digital photos from your digital camera at high resolution to get photo quality printing.



- miniSD™ can be used with miniSD™ adapter.
- Memory Stick Duo™ can be used with Memory Stick Duo™ adapter.
- Adapters are not included with the MFC. Contact a third party supplier for adapters.



## PhotoCapture Center™ requirements

To avoid error conditions, please remember:

- The DPOF file on the media card must be in a valid format. (See *DPOF printing* on page 9-8.)
- The image file extension must be .JPG (Other image file extensions .JPEG, .TIF, .GIF and so on will not be recognized).
- Walk-up PhotoCapture Center™ printing must be performed separately from PhotoCapture Center™ operations using the PC. (Simultaneous operation is not available.)
- IBM Microdrive™ is not compatible with the MFC.
- The MFC can read up to 999 files in a media card.
- Use only Smart media cards with a 3.3v voltage rating.
- CompactFlash® Type II is not supported.

 When printing the INDEX or IMAGE, the PhotoCapture Center™ will print all the valid images, even if one or more images have been corrupted. A portion of the corrupted image may be printed.

 Your MFC is designed to read media cards that have been formatted by a digital camera.

When a digital camera formats a media card it creates a special folder into which it copies image data. If you need to modify the image data stored on a media card with your PC, we recommend that you do not modify the folder structure created by the digital camera. When saving new or modified image files to the media card we also recommend you use the same folder your digital camera uses. If the data is not saved to the same folder the MFC may not be able to read the file or print the image.

# Getting started

Firmly insert the card into the appropriate slot.

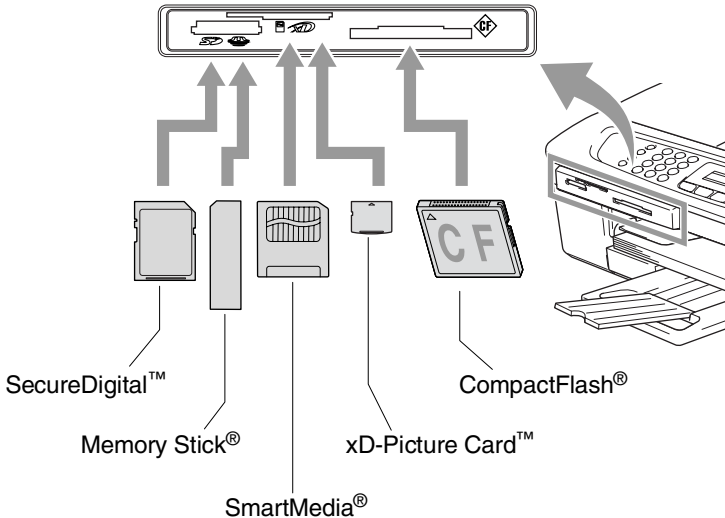

## PhotoCapture key indications:

- **PhotoCapture** light is ON, the media card is inserted properly.
- **PhotoCapture** light is OFF, the media card is not properly inserted.
- **PhotoCapture** light is BLINKING, the media card is being read or written to.

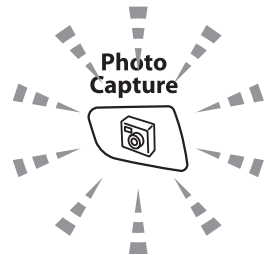

- ⚠ Do NOT unplug the power cord or remove the media card from the media drive (slot) while the MFC is reading or writing to the card (the **PhotoCapture** key is blinking). **You will lose your data or damage the card.**

The MFC can only read one media card at a time so do not insert more than one card.

**The steps below give a brief outline of the Direct Printing feature. Please see the remaining pages of this chapter for more detailed instructions.**

- 1** Insert the media card firmly into the media drive (slot).

When you insert your media card into the proper slot, the LCD shows.

C.Flash Active Press PhotoCapture key...
---



The media active message will be shown for 60 seconds and then disappear. Even in that case, you can enter the PhotoCapture mode by pressing **PhotoCapture**.

- 2** Press **PhotoCapture**.

If your digital camera supports DPOF printing, see *DPOF printing* on page 9-8.

- 3** Print the index that shows thumbnail views of images stored on your media card. Your MFC will assign an image number to each thumbnail.

Press **▲** or **▼** to select `Print Index` and then press **Menu/Set**.

Press **Colour Start** to start printing the index sheet.  
(See *Printing the Index (Thumbnails)* on page 9-5.)

- 4** To print images, press **▲** or **▼** to select `Print Images` and then press **Menu/Set**.

Enter the image number and press **Menu/Set**.

Press **Colour Start** to start printing.

(See *Printing images* on page 9-6.)



You can change the settings for printing images, such as the Paper Type & Paper Size, Print Size and number of copies.  
(See *Printing images* on page 9-6.)

# Printing the Index (Thumbnails)

The PhotoCapture Center™ assigns numbers for images (such as No.1, No.2, No.3, and so on).



► No. 1  
DEI.JPG

01.01.2003  
100KB

It does not recognize any other numbers or file names that your digital camera or PC have used to identify the pictures. You can print a thumbnail page (Index page with 6 or 5 images per line). This will show all the pictures on the media card.

- 1** Make sure you have inserted the media card.  
Press **PhotoCapture**. (See page 9-3.)
- 2** Press **▲** or **▼** to select **Print Index**.  
Press **Menu/Set**.
- 3** Press **▲** or **▼** to select **6 Images/Line** or **5 Images/Line**.  
Press **Menu/Set**.

Index



5 Images/Line

Index

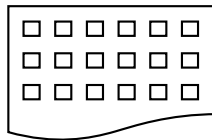

6 Images/Line

- 4** Press **Colour Start** to start printing.
-  Print time for 5 Images/Line will be slower than 6 Images/Line, but the quality is better. To print an image, see *Printing images* on page 9-6.

# Printing images

Before you can print an individual image, you have to know the image number.



Print the Index first.

(See *Printing the Index (Thumbnails)* on page 9-5.)

**1** Make sure you have inserted the media card.

Press **PhotoCapture**. (See page 9-3.)

**2** Press **▲** or **▼** to choose `Print Images`.

Press **Menu/Set**.



If your media card contains valid DPOF information, the LCD shows `DPOF Print:Yes`, please go to *DPOF printing* on page 9-8.

**3** Use the dial pad to enter the image number that you want to print from the Index page (Thumbnails).

Enter & Set Key No. : 1, 3, 6
----------------------------------

Press **Menu/Set**.

Repeat this step until you have entered all the image numbers that you want to print.



You can enter all the numbers at one time by using the **\*** key for a comma or the **#** key for hyphen.

(For example, Enter **1 \* 3 \* 6** - to print images No.1, No.3 and No.6. Enter **1 # 5** to print images No.1 to No.5).

**4** After you have selected all the image numbers, press **Menu/Set** again, and go to Step 5.

—**OR**—

If you have finished choosing settings, press **Colour Start**.

## Paper Type & Paper Size

- 5** Press ▲ or ▼ to select the type of paper you are using, Letter Glossy, 10x15cm Glossy, 13x18cm Glossy, A4 Glossy, Letter Plain, A4 Plain, Letter Inkjet, A4 Inkjet or 10x15cm Inkjet.

Press **Menu/Set**.

If you selected Letter or A4, go to Step 6.

If you selected another size, go to Step 7.

—OR—

If you have finished choosing settings, press **Colour Start**.

## Print Size





- 6** If you selected Letter or A4, press ▲ or ▼ to select the print size (10 x 8cm, 13 x 9cm, 15 x 10cm, 18 x 13cm, 20 x 15cm or Max. Size).

Press **Menu/Set**, and go to Step 7.

—OR—

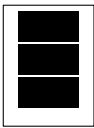
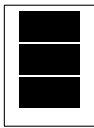
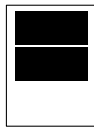
If you have finished choosing settings, press **Colour Start**.

Printed Position for A4 paper

①	②	③	④	⑤	⑥
10 x 8cm	13 x 9cm	15 x 10cm	18 x 13cm	20 x 15cm	Max. Size
					



The Max. Size is available for MFC-410CN only.

## Number of Copies

- 7** Use the dial pad to enter the number of copies you want.

Press **Menu/Set**.

- 8** Press **Colour Start** to print.



The settings that you want to use with the card will be kept until you take out the media card from the drive (slot), print images or press **Stop/Exit**.

## DPOF printing

---

DPOF stands for Digital Print Order Format.

Major Digital Camera manufacturers (Canon Inc., Eastman Kodak Company, Fuji Photo Film Co. Ltd., Matsushita Electric Industrial Co. Ltd. and Sony Corporation.) created this standard to make it easier to print images from a digital camera.

If your digital camera supports DPOF printing, you will be able to select on the Digital Camera display the images and number of copies you want to print.

When the memory card (CompactFlash®, SmartMedia®, Memory Stick®, SecureDigital™ and xD-Picture Card™) containing DPOF information is put into your MFC, you can print the selected image easily.

- 1 Insert your media card into the proper drive (slot).

C.Flash Active  
Press PhotoCapture key...



The media active message will be shown for 60 seconds and then disappear. Even in that case, you can enter the PhotoCapture mode by pressing **PhotoCapture**.

- 2 Press **PhotoCapture**.
- 3 Press **▲** or **▼** to select `Print Images`.  
Press **Menu/Set**.

- 4 If there is a DPOF file on the card, the LCD shows:

Select **▲▼** & Set  
DPOF Print:Yes

- 5 Press **▲** or **▼** to select `DPOF Print:Yes`.  
Press **Menu/Set**.



If you want to choose the images and their print options now, select `DPOF Print:No`.

- 6 Press **Colour Start** to print.

## Changing the default settings

---

You can save the PhotoCapture Center™ settings you use most often by setting them as default. These settings will remain until you change them again.

### Increasing print speed or quality

- 1** Press **Menu/Set, 4, 1**.
- 2** Press **▲** or **▼** to select **Normal** or **Photo**.  
Press **Menu/Set**.
- 3** Press **Stop/Exit**.

### Setting the paper & size

- 1** Press **Menu/Set, 4, 2**.
- 2** Press **▲** or **▼** to select **Letter Glossy, 10x15cm Glossy, 13x18cm Glossy, A4 Glossy, Letter Plain, A4 Plain, Letter Inkjet, A4 Inkjet** or **10x15cm Inkjet**.  
Press **Menu/Set**.  
If you selected **Letter** or **A4**, press **▲** or **▼** to select the print size (10 x 8cm, 13 x 9cm, 15 x 10cm, 18 x 13cm, 20 x 15cm or **Max. Size**).  
Press **Menu/Set**.
- 3** Press **Stop/Exit**.



The **Max. Size** is available for MFC-410CN only.



## Adjusting brightness

- 1 Press **Menu/Set**, **4**, **3**.
- 2 Press **▲** to make a lighter print.  
—OR—  
Press **▼** to make a darker print.  
Press **Menu/Set**.
- 3 Press **Stop/Exit**.

## Adjusting contrast

You can choose the contrast setting. More contrast will make an image look sharper and more vivid.

- 1 Press **Menu/Set**, **4**, **4**.
- 2 Press **▲** to increase the contrast.  
—OR—  
Press **▼** to decrease the contrast.  
Press **Menu/Set**.
- 3 Press **Stop/Exit**.

## Colour enhancement (MFC-410CN only)

You can turn on the colour enhancement feature to print more vivid images. Printing time will be slower.

- 1 Press **Menu/Set**, **4**, **5**.
- 2 Press **▲** or **▼** to select **On**.  
Press **Menu/Set**.  
—OR—  
Select **Off** and press **Menu/Set**, then go to Step 5.



If you select **On**, you can customize the White Balance, Sharpness or Colour Density.

**3** Press **▲** or **▼** to select **White Balance**, **Sharpness** or **Colour Density**.

Press **Menu/Set**.

**4** Press **▲** or **▼** to adjust the degree of the setting.

Press **Menu/Set**.

**5** Press **Stop/Exit**.

■ **White Balance**

This setting adjusts the hue of the white areas of an image. Lighting, camera settings and other influences will effect the appearance of white. The white areas of a picture may be slightly pink, yellow or some other colour. By using this adjustment you can correct this effect and bring the white areas back to pure white.

■ **Sharpness**

This setting enhances the detail of an image. It is similar to adjusting the fine focus on a camera. If the image is not in true focus and you cannot see the fine details of the picture, then adjust the sharpness.

■ **Colour Density**

This setting adjusts the total amount of colour in the image. You can increase or decrease the amount of colour in an image to improve a washed out or weak picture.

## Cropping

If your photo is too long or wide to fit the available space on your selected layout, part of the image will be automatically cropped.

The default setting is **On**. If you want to print the whole image, turn this setting to **Off**.

- 1** For MFC-210C, press **Menu/Set, 4, 5**.  
For MFC-410CN, press **Menu/Set, 4, 6**.
- 2** Press **▲** or **▼** to select **Off** (or **On**).  
Press **Menu/Set**.
- 3** Press **Stop/Exit**.

Cropping:On

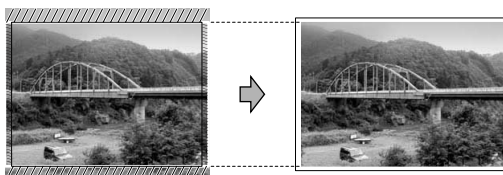

Cropping:Off

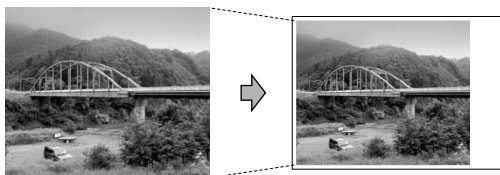

## Borderless

This feature expands the printable area to the edges of the paper. Printing time will be slightly slower.

- 1** For MFC-210C, press **Menu/Set, 4, 6**.  
For MFC-410CN, press **Menu/Set, 4, 7**.
- 2** Press **▲** or **▼** to select **Off** (or **On**).  
Press **Menu/Set**.
- 3** Press **Stop/Exit**.

## Understanding the Error Messages

---

Once you are familiar with the types of errors that can occur while you're using the PhotoCapture Center™, you can easily identify and troubleshoot any difficulties.

When an error message appears on the LCD, the MFC will beep to get your attention.

**Media Error**—This message will appear if you insert a media card that is either bad or not formatted, or when there is a problem with the media drive. To clear this error, take out the media card.

**No File**—This message will appear if you try to access a media card in the drive (slot) that does not contain a .JPG file.

**Out of Memory**—This message will appear if you are working with images that are too large for the MFC's memory.

# Using PhotoCapture Center™ from your PC

You can access the media card that is in the media drive (slot) of the MFC from your PC.

(See *Using the PhotoCapture Center™ from your PC* on page 6-1 in Software User's Guide on the CD-ROM or *Using the PhotoCapture Center™ from a Macintosh®* (not available for MFC-3240C and MFC-5440CN) on page 8-45 in the Software User's Guide on the CD-ROM.)

# Using PhotoCapture Center™ for scanning documents

You can scan documents and save them onto a media card to quickly and easily make documents portable. (See *Scan to Card* (not available for MFC-3240C, MFC-210C and MFC-5440CN) on page 2-23 in Software User's Guide on the CD-ROM.)

# 10 Important information

## For your safety

---

To ensure safe operation the supplied three-pin plug must be inserted only into a standard three-pin electrical socket that is effectively grounded through the normal household wiring.

The fact that the equipment operates satisfactorily does not imply that the power is grounded and that the installation is completely safe. For your safety, if in any doubt about the effective grounding of the power, consult a qualified electrician.

## IT power system (For Norway only)

---

This product is also designed for IT power system with phase to phase voltage 230V.

## LAN connection (MFC-410CN only)

---

### Caution

Do not connect this product to a LAN connection that is subject to over-voltages.

## International ENERGY STAR<sup>®</sup> Compliance Statement

---

The purpose of the International ENERGY STAR<sup>®</sup> Program is to promote the development and popularization of energy-efficient office equipment.

As an ENERGY STAR<sup>®</sup> Partner, Brother Industries, Ltd. has determined that this product meets the ENERGY STAR<sup>®</sup> guidelines for energy efficiency.



## Important safety instructions

---

- 1** Read all of these instructions.
- 2** Save them for later reference.
- 3** Follow all warnings and instructions marked on the product.
- 4** Unplug this product from the wall socket before cleaning. Do not use liquid or aerosol cleaners. Use a damp cloth for cleaning.
- 5** Do not use this product near water.
- 6** Do not place this product on an unstable cart, stand, or table. The product may fall, causing serious damage to the product.
- 7** Slots and openings in the cabinet and the back or bottom are provided for ventilation; to ensure reliable operation of the product and to protect it from overheating, these openings must not be blocked or covered. The openings should never be blocked by placing the product on a bed, sofa, rug, or other similar surface. This product should never be placed near or over a radiator or heater. This product should never be placed in a built-in installation unless proper ventilation is provided.
- 8** This product should be operated from the type of power source indicated on the label. If you are not sure of the type of power available, call your dealer or local power company.  
Use only the power cord supplied with this MFC.
- 9** This product is equipped with a 3-wire grounded plug, a plug having a third (grounded) pin. This plug will only fit into a grounded power outlet. This is a safety feature. If you are unable to insert the plug into the outlet, call your electrician to replace your obsolete outlet. Do not defeat the purpose of the grounded plug.
- 10** Do not allow anything to rest on the power cord. Do not place this product where people can walk on the cord.

- 11** Do not place anything in front of the MFC that will block received faxes. Do not place anything in the path of received faxes.
- 12** Wait until pages have exited the MFC before picking them up.
- 13** Unplug this product from the power socket and refer servicing to Authorized Service Personnel under the following conditions:
  - When the power cord is damaged or frayed.
  - If liquid has been spilled into the product.
  - If the product has been exposed to rain or water.
  - If the product does not operate normally when the operating instructions are followed. Adjust only those controls that are covered by the operating instructions. Improper adjustment of other controls may result in damage and will often require extensive work by a qualified technician to restore the product to normal operation.
  - If the product has been dropped or the cabinet has been damaged.
  - If the product exhibits a distinct change in performance, indicating a need for service.
- 14** To protect your product against power surges, we recommend the use of a power protection device (Surge Protector).



## Trademarks

---

The Brother logo is a registered trademark of Brother Industries, Ltd.

Brother is a registered trademark of Brother Industries, Ltd.

Multi-Function Link is a registered trademark of Brother International Corporation.

© 2004 Brother Industries, Ltd. All rights reserved.

Windows and Microsoft are registered trademarks of Microsoft in the U.S. and other countries.

Macintosh and TrueType are registered trademarks of Apple Computer, Inc.

PaperPort and OmniPage OCR are registered trademarks of ScanSoft, Inc.

Presto! PageManager is a registered trademark of NewSoft Technology Corporation.

Microdrive is a trademark of International Business Machine Corporation.

SmartMedia is a registered trademark of Toshiba Corporation.

CompactFlash is a registered trademark of SanDisk Corporation.

Memory Stick is a registered trademark of Sony Corporation.

SecureDigital is a trademark of Matsushita Electric Industrial Co.Ltd., SanDisk Corporation and Toshiba Corporation.

SanDisk is a licensee of the SD and miniSD trademarks.

xD-Picture Card is a trademark of Fujifilm Co.Ltd., Toshiba Corporation and Olympus Optical Co. Ltd.

Memory Stick Duo and MagicGate are trademarks of Sony Corporation.

Each company whose software title is mentioned in this manual has a Software License Agreement specific to its proprietary programs.

**All other brand and product names mentioned in this User's Guide, the Software User's Guide, and the Network User's Guide (MFC-410CN only) are registered trademarks of their respective companies.**

# 11 Troubleshooting and routine maintenance

## Troubleshooting

### Error messages

---

As with any sophisticated office product, errors may occur. If this happens, your MFC identifies the problem and displays an error message. The most common error messages are shown below.

You can correct most problems by yourself. If you need additional help, the Brother Solutions Center offers latest FAQs and troubleshooting tips.

Visit us at <http://solutions.brother.com>.

ERROR MESSAGES		
ERROR MESSAGE	CAUSE	ACTION
BT Call Sign On	The machine is set BT Call Sign to ON. You cannot change the Receive Mode from Manual to another mode.	Set BT Call Sign to OFF. (See <i>BT Call Sign (For U.K. Only)</i> on page A-1.)
Comm.Error	Poor phone line quality caused a communication error.	Try the call again. If the problem continues, call the telephone company and ask them to check your phone line.
Connection Fail	You tried to poll a fax machine that is not in Polled Waiting mode.	Check the other fax machine's polling setup.
Cover is Open	The scanner cover is not closed completely.	Lift the scanner cover and then close it again.
Data Remaining	Print data remains in the MFC's memory.	Re-start printing from your computer.
	Print data remains in the MFC's memory. The USB cable was unplugged while the computer was sending the data to the MFC.	Press <b>Stop/Exit</b> . The MFC will cancel the job and eject the page that is being printed.
Disconnected	The other person or other person's fax machine stopped the call.	Try to send or receive again.
High Temperature	The print head is too warm.	Allow the MFC to cool down.

ERROR MESSAGES		
ERROR MESSAGE	CAUSE	ACTION
Ink Empty	One or more of the ink cartridges is empty. The MFC will stop all print operations. While memory is available, black and white faxes will be received into memory. If a sending machine has a colour fax, the MFC's 'handshake' will request that the fax be sent as black and white. If the sending machine has the ability to convert it, the colour fax will be received into memory as a black and white fax.	Replace the ink cartridges. (See <i>Replacing the ink cartridges</i> on page 11-24.)
Low Temperature	The print head is too cold.	Allow the MFC to warm up.
Media Error	The media card is either corrupted, Improperly formatted, or there is a problem with the media card.	Re-insert the card firmly into the slot to make sure it is in the correct position. If the error remains, check the media drive by inserting another media card that you know is working.
Near Empty	One or more of the ink cartridges are running out of ink. If a sending machine has a colour fax, the MFC's 'handshake' will request that the fax be sent as black and white. If the sending machine has the ability to convert it, the colour fax will be received into memory as a black and white fax.	Order a new ink cartridge.
No Cartridge	An ink cartridge is not properly installed.	Take out the ink cartridge and put it in again seating it properly. (See <i>Replacing the ink cartridges</i> on page 11-24.)
No File	The media card in the media drive does not contain a .JPG file.	Reinsert the correct media card.
No Paper Fed	The MFC is out of paper.	Add paper, and then press <b>Mono Start</b> or <b>Colour Start</b> .
	The paper is jammed in the MFC.	See <i>Printer jam or paper jam</i> on page 11-5.
No Response/Busy	The number you dialled does not answer or is busy.	Verify the number and try again.
Not Registered	You tried to access a Speed Dial number that is not programmed.	Set up the Speed Dial number. (See <i>Storing Speed-Dial numbers</i> on page 5-1.)

ERROR MESSAGES		
ERROR MESSAGE	CAUSE	ACTION
Out of Memory	The MFC's memory is full.	(Fax sending or copy operation in process) Press <b>Stop/Exit</b> and wait until the other operations in progress finish and then try again. —OR— (MFC-410CN only) Clear the data in the memory. To gain extra memory, you can turn off Fax Storage. (See <i>Setting Fax Storage</i> on page 6-2.) —OR— (MFC-410CN only) Print the faxes that are in the memory. (See <i>Printing a fax from the memory (MFC-410CN only)</i> on page 4-5.) (Printing operation in process) Reduce print resolution.
Paper Jam	The paper is jammed in the MFC.	(See <i>Printer jam or paper jam</i> on page 11-5.)
Wrong Paper Size	Paper is not the correct size.	Reload the correct size of paper (Letter, Legal or A4), and then press <b>Mono Start</b> or <b>Colour Start</b> .

**ERROR MESSAGES**

<b>ERROR MESSAGE</b>	<b>CAUSE</b>	<b>ACTION</b>
<p>Unable to Change</p> <p>Unable to Clean</p> <p>Unable to Init.</p> <p>Unable to Print</p> <p>Unable to Scan</p>	<p>The MFC has a mechanical problem.</p> <p>—OR—</p> <p>A foreign obstacle, such as a clip or ripped paper, is in the MFC.</p>	<p>Open the scanner cover and remove any foreign obstacles from inside the MFC. If the error message continues, please follow the steps below before disconnecting the MFC so you will not lose any important messages. Then, disconnect the MFC from the power source for several minutes (which will erase all faxes), and then reconnect it.</p> <p><b>Check whether the MFC has faxes in memory</b></p> <ol style="list-style-type: none"> <li>1. Press <b>Menu/Set, 9, 0, 1</b>.</li> <li>2. If the MFC has no faxes, disconnect the MFC from the power source for several minutes and then reconnect it.</li> </ol> <p>—OR—</p> <p>If faxes are present, you can transfer them to another fax machine. Go to step 3.</p> <p>—OR—</p> <p>For MFC-410CN, you can forward the remaining faxes to your PC. Please see <b>Transfer faxes to your PC</b>.</p> <p><b>Transfer faxes to another fax machine</b></p> <p>If you have not set up your Station ID, you cannot enter fax transfer mode.</p> <ol style="list-style-type: none"> <li>3. Enter the fax number to which faxes will be forwarded.</li> <li>4. Press <b>Mono Start</b>.</li> <li>5. After the faxes are transferred, disconnect the MFC from the power source for several minutes and then reconnect it.</li> </ol> <p>You can transfer the Fax Journal report to another fax machine by pressing <b>Menu/Set, 9, 0, 2</b> in step 1.</p> <p><b>Transfer faxes to your PC (MFC-410CN only)</b></p> <p>You can move the faxes from your MFC's memory to your PC.</p> <ol style="list-style-type: none"> <li>1. Press <b>Menu/Set, 2, 5, 1</b>.</li> <li>2. Using <b>▲</b> or <b>▼</b>, select <b>PC Fax Receive</b>, and then press <b>Menu/Set</b>. The LCD will ask if you want to transfer a fax to your PC.</li> <li>3. To transfer all faxes to your PC, press <b>1</b>.</li> </ol> <p>—OR—</p> <p>To keep all faxes in the MFC's memory, press <b>2</b>.</p> <ol style="list-style-type: none"> <li>4. After the faxes are transferred, disconnect the MFC from the power source for several minutes and then reconnect it.</li> </ol> <p>(For details see <i>Using Brother PC-FAX software</i> on page 5-1 in Software User's Guide on the CD-ROM.)</p>

## Printer jam or paper jam

---

Remove the jammed paper depending on where it is jammed in the MFC.

### Paper is jammed inside the paper tray

- 1 Pull the paper tray out of the MFC.

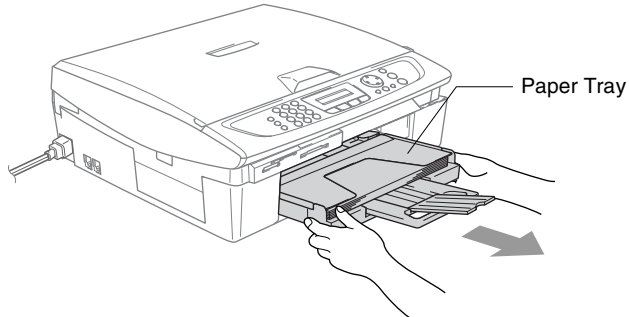

- 2 Pull out the jammed paper to remove it.

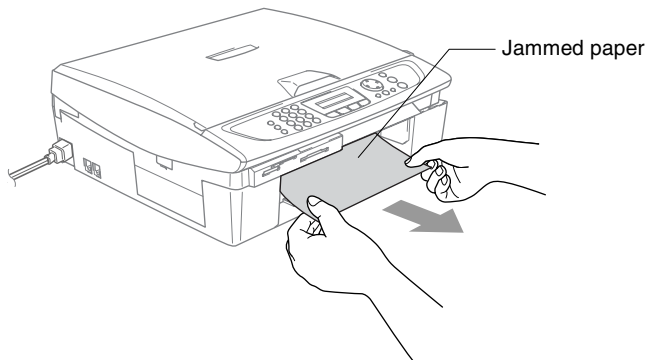

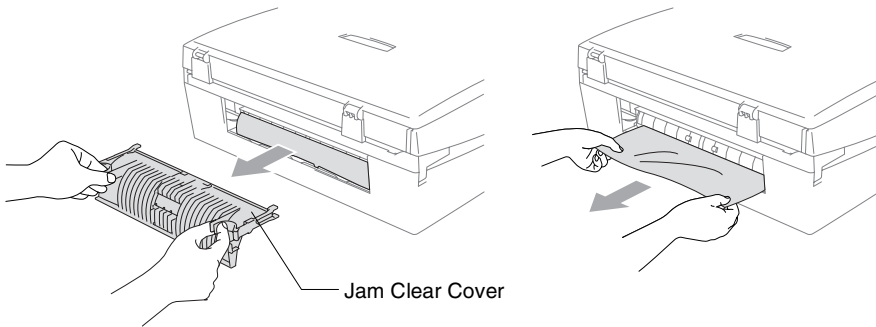

## Paper is jammed inside the MFC

- 1 Remove the Jam Clear Cover. Pull the jammed paper out of the MFC.

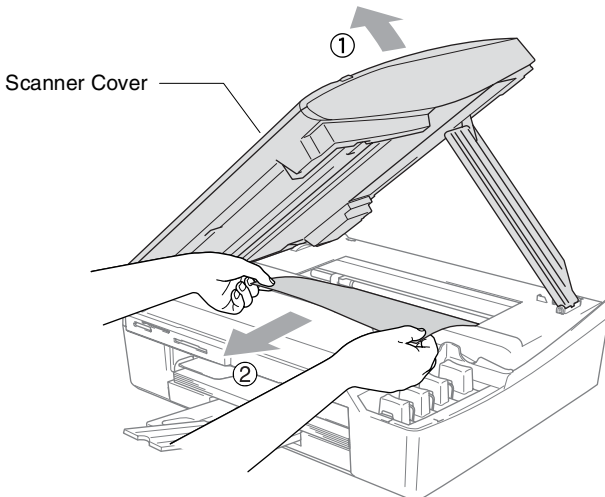

- 2 Re-insert the Jam Clear Cover.
- 3 If you can not pull out the jammed paper, lift the scanner cover from the right-hand side of the MFC until it locks securely into the open position.
- 4 Remove the jammed paper.



-  If the paper is jammed underneath the print head, disconnect the MFC from the power source so you can move the print head to take out the paper.

- 5** Lift the scanner cover to release the lock. Gently push the scanner cover support down and close the scanner cover.

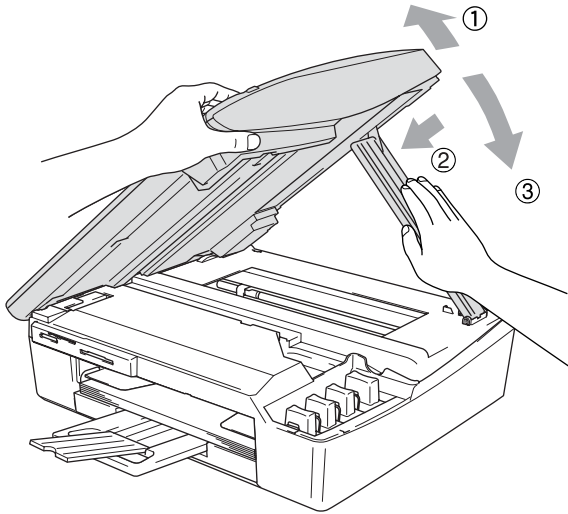



## If you are having difficulty with your MFC

If you think there is a problem with your MFC, check the chart below and follow the troubleshooting tips.

The Brother Solutions Center offers the latest FAQs and troubleshooting tips.

Visit us at <http://solutions.brother.com>.

DIFFICULTY	SUGGESTIONS
<b>Printing</b>	
No printout	Check the interface cable connection on both the MFC and your computer.
	Check the MFC is plugged in and not in the Power Save condition.
	One or more ink cartridges are empty. (See <i>Replacing the ink cartridges</i> on page 11-24.)
	Check to see if the LCD is showing an error message. (See <i>Error messages</i> on page 11-1.)
Poor quality print.	Check the print quality. (See <i>Checking the print quality</i> on page 11-15.)
	Make sure the Printer Driver or Paper Type setting in the menu matches the type of paper you are using. (See <i>Media Type</i> on page 1-8 in Software User's Guide on the CD-ROM and <i>Setting the Paper Type</i> on page 2-4.)
	Make sure your ink cartridges are fresh. Cartridges remain fresh for up to two years if kept in their original packaging, after that the ink may become clogged. Cartridge expiration dates are printed on the package.
	Try using the recommended types of paper. (See <i>About paper</i> on page 1-7.)
	The recommended environment for your MFC is between 20°C to 33°C.
White horizontal lines appear in text or graphics.	Clean the print head. (See <i>Cleaning the print head</i> on page 11-14.)
	Try using the recommended types of paper. (See <i>About paper</i> on page 1-7.)
	If horizontal bands appear when using plain paper, use the 'Enhanced Normal Printing' mode to help avoid banding on some types of plain paper. In the printer driver 'Basic' tab, click 'Settings', and check 'Enhanced Normal Printing'. If you continue to have horizontal bands, change the Media Type selection to 'Slow Drying Paper' in the printer driver 'Basic' tab to help enhance the print quality.
The MFC prints blank pages.	Clean the print head. (See <i>Cleaning the print head</i> on page 11-14.)
Characters and lines are stacked.	Check the printing alignment. (See <i>Checking the printing alignment</i> on page 11-17.)
Printed text or images are skewed.	Make sure the paper is loaded properly in the paper tray and the paper side guide is adjusted correctly. (See <i>How to load paper, envelopes and post cards</i> on page 1-12.)

DIFFICULTY	SUGGESTIONS
<b>Printing (Continued)</b>	
Smudged stain at the top center of the printed page.	Make sure the paper is not too thick or not curled. (See <i>About paper</i> on page 1-7.)
Printing appears dirty or ink seems to run.	Make sure you are using the proper types of paper. (See <i>About paper</i> on page 1-7.) Don't handle the paper until the ink is dry.
Stains appear on the reverse side or at the bottom of the page.	Make sure the Printer Platen is not dirty with ink. (See <i>Cleaning the MFC printer platen</i> on page 11-23.)
	Make sure you are using the paper support flap. (See <i>How to load paper, envelopes and post cards</i> on page 1-12.)
There are some dense lines.	Check 'Reverse Order' in the Basic tab of the printer driver.
The printouts are wrinkled.	In the printer driver 'Basic' tab, click the 'Settings', and uncheck the 'Bi-Directional Printing'.
Cannot perform '2 in 1 or 4 in 1' printing.	Check that the paper size setting in the application and in the printer driver are the same.
Print speed is too slow.	Changing the printer driver setting may improve the print speed. Highest resolution needs longer data processing, transfer and printing time. Try the other settings of quality in the printer driver 'Basic' tab. Also, click the 'Settings' tab, and make sure you uncheck the Colour Enhancement.
	Borderless printing is slower than normal printing. If you want to print more quickly, set the Borderless feature off. (See <i>Borderless</i> on page 9-12 and see <i>Paper Size</i> on page 1-12 in Software User's Guide on the CD-ROM.)
Colour Enhancement is not working properly.	If the image data is not full colour in your application (Such as 256 colour), Colour Enhancement will not work. Please use at least 24 bit colour data with the Colour Enhancement feature.
MFC feeds multiple pages	Make sure the paper is loaded properly in the paper tray. (See <i>How to load paper, envelopes and post cards</i> on page 1-12.)
	Check that more than two types of paper are not loaded in the paper tray at any one time.
Printed pages are not stacked neatly.	Make sure you are using the paper support flap. (See <i>How to load paper, envelopes and post cards</i> on page 1-12.)
Machine does not print from Paint Brush.	Try setting the Display setting to '256 colours.'
Machine does not print from Adobe Illustrator.	Try to reduce the print resolution.
<b>Printing Received Faxes</b>	
Condensed print and white streaks across the page or the top and bottom of sentences are cut off.	This can be caused by static or interference on the telephone line. You can make a copy using the <b>Mono Start</b> key to see if the same problem occurs. If the copy looks good then the problem is probably the phone line and not your machine.
Vertical black lines when receiving.	The sender's scanner may be dirty. Ask the sender to make a copy to see if the problem is with the sending machine. Try receiving from another fax machine.
Received colour fax prints only in black and white.	Replace the colour ink cartridges that are empty or nearly empty, and then ask the other person to send the colour fax again. (See <i>Replacing the ink cartridges</i> on page 11-24.) For MFC-410CN, check that Fax Storage is set to OFF. (See <i>Setting Fax Storage</i> on page 6-2.)

DIFFICULTY	SUGGESTIONS
<b>Printing Received Faxes (Continued)</b>	
Left and Right margins are cut off or a single page is printed on two pages.	Turn on Auto Reduction. (See <i>Printing a reduced incoming fax (Auto Reduction)</i> on page 4-5.)
<b>Phone Line or Connections</b>	
Dialling does not work. (No dial tone)	Check the MFC is plugged in.
	Check for a dial tone. If possible, call your MFC to hear it answer. If there is still no answer, check the telephone line cord connection and make sure all telephone connections are secured. If there is no ringing when you call your MFC, ask your telephone company to check the line.
	Change Tone/Pulse setting. (See <i>Setting Tone or Pulse dialling mode (Except for the Nordic Countries)</i> on page 2-1.)
<b>Receiving Faxes</b>	
Cannot receive a fax	Make sure the MFC is in the correct receiving mode for your setup. (See <i>Basic receiving operations</i> on page 4-1.)
	If you frequently encounter interference on the phone line, try changing the menu setting of Compatibility to <i>Basic</i> . (See <i>Compatibility</i> on page 11-13.)
	If you connect your MFC to PBX, PABX, ADSL or ISDN, set the menu setting of Phone Line Type to your phone type. (See <i>Setting the Phone Line Type</i> on page 2-3.)
<b>Sending Faxes</b>	
Cannot send a fax	Make sure that the Fax  key is illuminated. (See <i>How to enter Fax mode</i> on page 3-1.)
	Ask the other party to check that receiving machine has paper.
	Print the Transmission Verification Report and check for an error. (See <i>Printing reports</i> on page 7-3.)
Transmission Verification Report says 'Result:NG' or 'Result:ERROR'.	There is probably temporary noise or static on the line. Try sending the fax again. If you send a PC FAX message and get 'Result:NG' on the Transmission Verification Report, your MFC may be out of memory.  (MFC-410CN only) To gain extra memory, you can turn off Fax Storage (see <i>Setting Fax Storage</i> on page 6-2), print fax messages in memory (see <i>Printing a fax from the memory (MFC-410CN only)</i> on page 4-5) or cancel a Delayed Fax or Polling Job (see <i>Cancelling a scheduled job</i> on page 3-9). If the problem continues, ask the telephone company to check your phone line.
	If you frequently get transmission error with possible interference on the phone line, try to change the menu setting of Compatibility to <i>Basic</i> . (See <i>Compatibility</i> on page 11-13.)
	If you connect your MFC to PBX, PABX, ADSL or ISDN, set the menu setting of Phone Line Type to your phone type. (See <i>Setting the Phone Line Type</i> on page 2-3.)
Poor sending quality.	Try changing your resolution to <i>Fine</i> or <i>S.Fine</i> . Make a copy to check your MFC's scanner operation.
Vertical black lines when sending.	If the copy you made shows the same problem, your scanner is dirty. (See <i>Cleaning the scanner</i> on page 11-22.)

DIFFICULTY	SUGGESTIONS
<b>Handling Incoming Calls</b>	
MFC 'Hears' Voice as CNG Tone.	If your MFC is set to Fax Detect ON, it is more sensitive to sounds. Your MFC may mistakenly interpret certain voices or music on the line as a calling fax machine and respond with fax receiving tones. Deactivate the fax by pressing <b>Stop/Exit</b> . Try avoiding this problem by turning Fax Detect to Off. (See <i>Fax Detect</i> on page 4-4.)
Transferring a Fax Call to the MFC.	If you answered at the MFC, press <b>Mono Start</b> and hang up immediately. If you answered on an extension phone, press your Fax Receive Code (default setting is (✕)51). When your MFC answers, hang up.
Custom features on a single line.	If you have Call Waiting, Call Waiting/Caller ID, Ring Master, BT's Call minder, an alarm system or any other custom feature on a single phone line with your MFC, it may create a problem sending or receiving faxes. For example: If you are sending or receiving a fax message while a custom feature signal comes through on the line, the signal can temporarily interrupt or disrupt the faxes. Brother's ECM feature should help overcome this problem. This condition is related to the telephone system industry and is common to all devices that send and receive data on a single, shared line with custom features. If avoiding a slight interruption is crucial to your business, we recommend a separate phone line with no custom features.
<b>Copying Difficulties</b>	
Cannot make a copy	Make sure that the Copy  key is illuminated. (See <i>Enter Copy mode</i> on page 8-1.)
Vertical streaks appear in copies	Sometimes you may see vertical streaks on copies. Clean the scanner. (See <i>Cleaning the scanner</i> on page 11-22.)
Poor copy results	Try using the scanner glass. (See <i>Using the scanner glass</i> on page 1-6.)
<b>Scanning Difficulties</b>	
TWAIN/WIA errors appear while scanning.	Make sure the Brother TWAIN/WIA driver is selected as the primary source. In PaperPort®, click Scan in the File menu and select the Brother TWAIN/WIA driver.
Poor scanning results	Try using the scanner glass. (See <i>Using the scanner glass</i> on page 1-6.)
<b>Software Difficulties</b>	
Cannot install software or print	Run the <b>Repair MFL-Pro Suite</b> program on the CD-ROM. This program will repair and reinstall the software.
'Device Busy'	Make sure the MFC is not showing an error message on the LCD.
'Connect Failure'	<p>If the MFC is not connected to your PC and you have loaded the Brother software, the PC will show 'MFC Connect Failure' each time you restart Windows®. You can ignore this message or you can turn it off as follows. Double-click "tool\warnOff.REG" from the supplied CD-ROM.</p> <p>The Scan key on the MFC's control panel will not work unless you restart your PC with the MFC connected.</p> <p>To turn it back on, double-click "tool\WarnOn.REG" from the supplied CD-ROM.</p>

DIFFICULTY	SUGGESTIONS
<b>PhotoCapture Center™ Difficulties</b>	
Removable Disk does not work properly.	<p>a) Have you installed the Windows® 2000 update? If not, do the following:</p> <ol style="list-style-type: none"> <li>1. Disconnect the USB cable.</li> <li>2. Install the Windows® 2000 update. Please see the Quick Setup Guide. After the installation the PC will be automatically restarted.</li> <li>3. Wait about 1 minute after you reboot the PC, and then connect the USB cable.</li> </ol> <p>b) Take out the media card and put it back in again.</p> <p>c) If you have tried "Eject" from within Windows®, you must take out the media card before you continue.</p> <p>d) If an error message appears when you try to eject the media card, it means the card is being accessed. Wait a while and then try again.</p> <p>e) If all of the above do not work, please turn off your PC and MFC, and then turn them on again. (You will have to unplug the power cord of the MFC to turn it off.)</p>
Cannot access Removable Disk from Desktop icon. (MFC-410CN only)	Make sure you have inserted the media card into the media slot.
<b>Network Difficulties (MFC-410CN only)</b>	
I cannot print over the Network	Make sure that your MFC is powered on and is On Line and in Ready mode. Print Network Configuration list. (See <i>Printing reports</i> on page 7-1.) Then the current settings of the network are printed. Reconnect the LAN cable to the hub to verify that the cabling and network connections are good. If possible, try connecting the MFC to a different port on your hub using a different cable. If the connections are good, the machine shows LAN Active for 2 seconds.
<b>Other Difficulties</b>	
Incorrect LCD language	See <i>How to change LCD language</i> on page 11-13.

## How to change LCD language

---

You can change the LCD language.

- 1 Press **Menu/Set**, **0**, **0**.
- 2 Press **▲** or **▼** to select your language.  
Press **Menu/Set**.
- 3 Press **Stop/Exit**.

## Compatibility

---

If you are having difficulty sending or receiving a fax due to possible interference on the phone line, we recommend that you adjust the Equalization for compatibility. The MFC adjusts the modem speed for fax operations.

- 1 Press **Menu/Set**, **2**, **0**, **2**.
- 2 Press **▲** or **▼** to select `Basic` (or `Normal`).  
Press **Menu/Set**.
- 3 Press **Stop/Exit**.

Miscellaneous 2.Compatibility
----------------------------------



- `Basic` reduces the modem speed to 9600 bps. Unless interference is a chronic problem on your phone line, you may prefer to use it only when needed.
- `Normal` sets the modem speed at 14400 bps. (Default)

# How to improve print quality

## Cleaning the print head

---

To ensure good print quality, the MFC will regularly clean the print head. You can start the cleaning process manually if needed.

Clean the print head and ink cartridges if you get a horizontal line in the text or graphics on your printed pages. You can clean Black only or three colours at a time (Cyan/Yellow/Magenta), or all four colours at once.

Cleaning the print head consumes ink. Cleaning too often uses ink unnecessarily.

### **Caution**

Do NOT touch the print head. Touching the print head may cause permanent damage and may void the print head's warranty.

- 1** Press **Ink Management**.
- 2** Press **▲** or **▼** to select **Cleaning**.  
Press **Menu/Set**.
- 3** Press **▲** or **▼** to select **Black, Color** or **All**.  
Press **Menu/Set**.

The MFC will clean the print head. When cleaning is finished, the MFC will go back to standby mode automatically.



If you clean the print head at least five times and the print has not improved, call your Brother dealer for service.

## Checking the print quality

---

If faded or streaked colours and text appears on your output, some of the nozzles may be clogged. You can check this by printing the Print Quality Check Sheet and looking at the nozzle check pattern.

- 1 Press **Ink Management**.
- 2 Press **▲** or **▼** to select `Test Print`.  
Press **Menu/Set**.
- 3 Press **▲** or **▼** to select `Print Quality`.  
Press **Menu/Set**.
- 4 Press **Colour Start**.  
The MFC begins printing the Print Quality Check Sheet.
- 5 Follow the instructions given on the sheet to see if the quality is OK.

### Colour block quality check

The LCD shows:

Is Quality OK?  
1.Yes 2.No

- 6 Check the quality of the four colour blocks on the sheet.
- 7 If all lines are clear and visible, press **1** (Yes), and go to Step 10.  
—OR—

If you can see missing short lines as shown below, press **2** (No).

OK

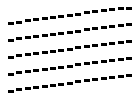

Poor

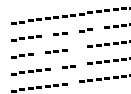

The LCD will ask you if the print quality is OK for black and three colours.

Black OK?  
1.Yes 2.No



- 8** Press **2** (No) for Black or three colours with a problem.

The LCD shows:

Start Cleaning?  
1.Yes 2.No

Press **1** (Yes).

The MFC will start cleaning the print head.

- 9** After cleaning is finished, press **Colour Start**. The MFC will start printing the Print Quality Check Sheet again and then return to step 5.

- 10** Press **Stop/Exit**.

If you still see missing ink in this Print Quality Check Sheet, repeat the cleaning and test print procedures at least five times. If ink is still missing after the fifth cleaning and test print, replace the ink cartridge for the clogged colour. (Perhaps the ink cartridge was in your MFC over six months or the expiration date written on the cartridge package has passed. Or, the ink may not have been stored properly before use.)

After replacing the ink cartridge, check it by printing another Print Quality Check Sheet. If the problem still exists, repeat the cleaning and test print procedures at least five times for the new ink cartridge. If ink is still missing, call your Brother dealer for service.

**!** **Caution**

Do NOT touch the print head. Touching the print head may cause permanent damage and may void the print head's warranty.



When an print head nozzle is clogged the printed sample looks like this.



After the print head nozzle is cleaned, the horizontal lines are gone.

## Checking the printing alignment

---

You should rarely need to adjust the printing alignment however, if after transporting the machine your printed text becomes blurred or images become faded then adjustment may need to be made.

- 1** Press **Ink Management**.
- 2** Press **▲** or **▼** to select `Test Print`.  
Press **Menu/Set**.
- 3** Press **▲** or **▼** to select `Alignment`.  
Press **Menu/Set**.
- 4** Press **Mono Start** or **Colour Start**.

The MFC begins printing the Alignment Check Sheet.

The LCD shows:

```
Is Alignment OK?  
1.Yes 2.No
```

- 5** Check the 600 dpi and 1200 dpi test prints to see if number 5 most closely matches number 0. If the number 5 sample of both the 600 dpi and 1200 dpi are the best matches, press **1** (Yes) to finish Alignment Check, and go to Step 8.

—OR—

If another test print number is a better match for either 600 dpi or 1200 dpi, press **2** (No) to select it.

- 6** For 600 dpi, press the number of the test print that most closely matches the number 0 sample (1-8).
- 7** For 1200 dpi, press the number of the test print that most closely matches the number 0 sample (1-8).
- 8** Press **Stop/Exit**.

```
600dpi Adjust  
Select Best # 5
```

```
1200dpi Adjust  
Select Best # 5
```

# Checking the ink volume

You can check the ink that is left in the cartridge.

- 1 Press **Ink Management**.
- 2 Press ▲ or ▼ to select **Ink Volume**.  
Press **Menu/Set**.

- 3 Press ▲ or ▼ to select the colour you want to check.



The LCD shows the ink volume.

- 4 Press **Stop/Exit**.



You can check the ink volume from your computer. (See *MFC Remote Setup* (not available for DCP-110C, DCP-310CN and MFC-210C) on page 4-1 in Software User's Guide on the CD-ROM or *MFC Remote Setup (Mac OS® X 10.2.4 or greater)* (not available for DCP-110C, DCP-310CN and MFC-210C) on page 8-43 in Software User's Guide on the CD-ROM.)

## Packing and shipping the MFC

---

Whenever you transport the MFC, use the packing materials that came with your MFC. If you do not pack the MFC properly, you could void your warranty.

### ! Caution

It is important to allow the MFC to 'park' the print head after a print job. Listen carefully to the MFC before disconnecting it from the power source to ensure that all mechanical noise has stopped. Not allowing the MFC to complete this parking process may lead to print problems and possible damage to the print head.

- 1 Lift the scanner cover from the right-hand side of the MFC until it locks securely into the open position.
- 2 Remove all the ink cartridges and attach the protective parts. (See *Replacing the ink cartridges* on page 11-24.)

When attaching the protective parts, make sure it clips into place as shown in the diagram.

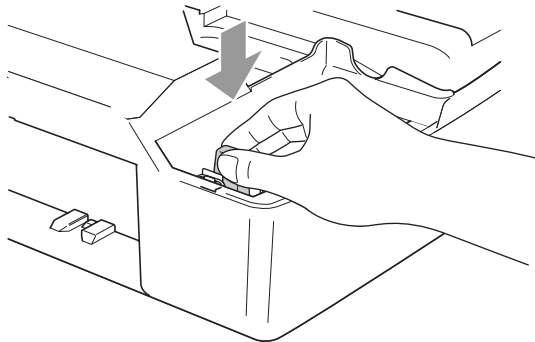

### ! Caution

If you are not able to find the protective parts, do NOT remove the ink cartridges before shipping. It is essential that the MFC be shipped with either the protective parts or the ink cartridges in position. Shipping without them will cause damage to your MFC and may void your warranty.

- 3** Lift the scanner cover to release the lock. Gently push the scanner cover support and close the scanner cover.

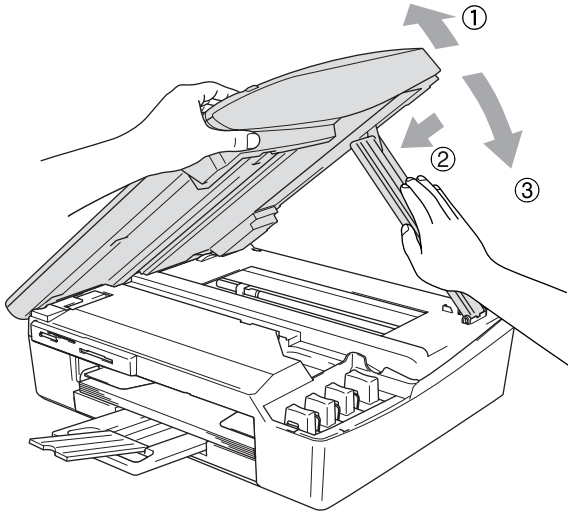

- 4** Unplug the MFC from the telephone wall socket and remove the telephone line cord from MFC.
- 5** Unplug the MFC from the electrical socket.
- 6** Unplug the USB cable or LAN cable from the MFC, if it is connected.
- 7** Wrap the MFC in the bag and place it in the original carton with the original packing material.

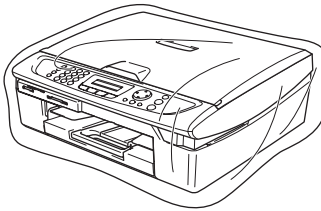

- 8** Pack the printed materials in the original carton as shown below. Do not pack the used ink cartridges in the carton.

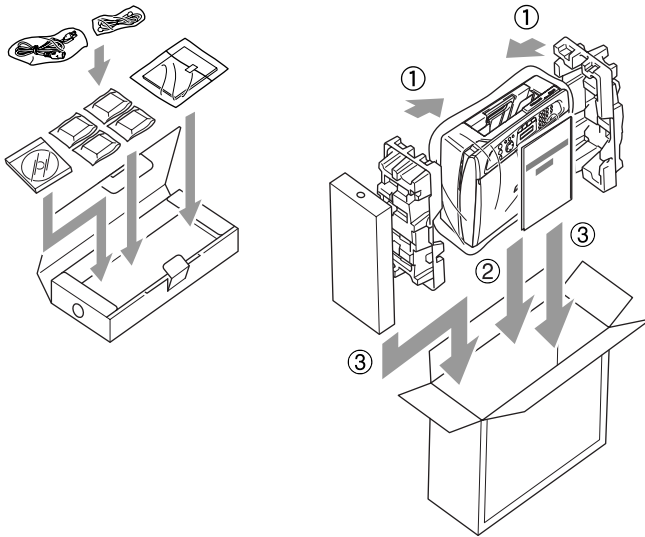

- 9** Close the carton.

# Routine maintenance

## Cleaning the scanner

---

Unplug the MFC and lift the document cover. Clean the scanner glass with isopropyl alcohol on a soft lint-free cloth.

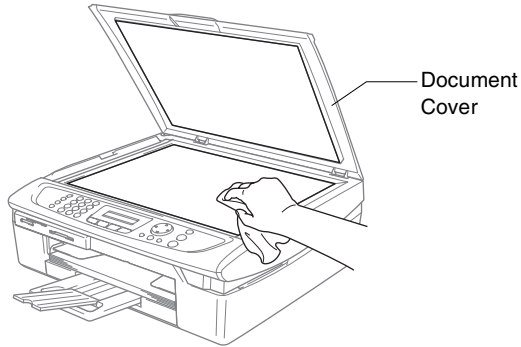

Clean the glass strip under the film with isopropyl alcohol on a lint-free cloth.

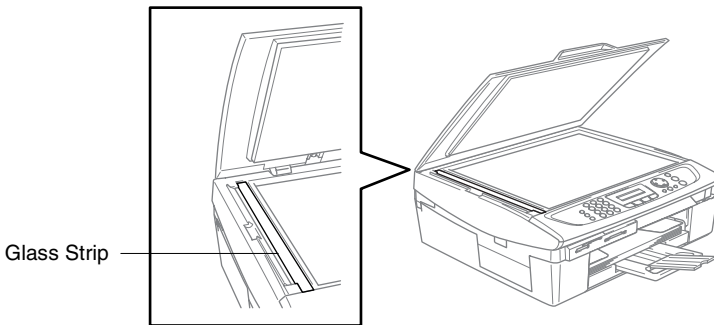

## Cleaning the MFC printer platen

---

- Be careful not to touch the paper feed star wheels or encoder film.
- Be sure to unplug the MFC from the electrical socket before cleaning the printer platen.
- If ink is scattered on or around the printer platen be sure to wipe it off with a soft, dry, lint-free cloth.

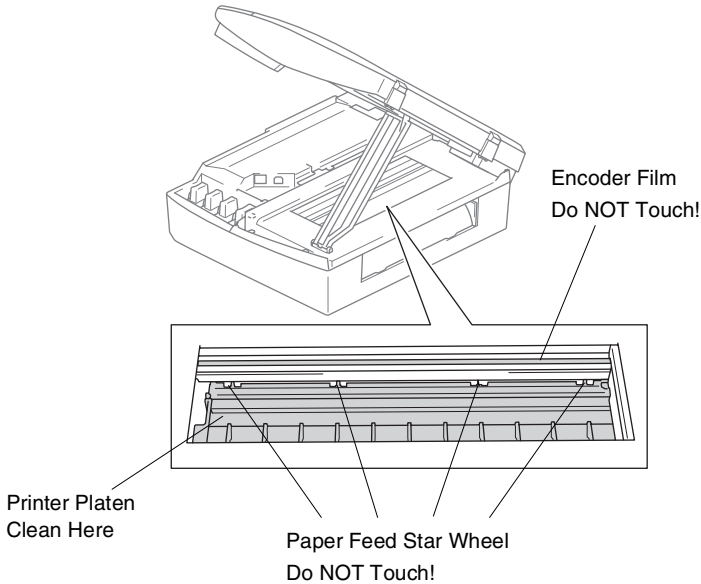



## Replacing the ink cartridges

---

Your MFC is equipped with an ink dot counter. The ink dot counter automatically monitors the level of ink in each of the 4 cartridges. When the MFC detects an ink cartridge is running out of ink, the MFC will notify you with a message on the LCD.

The LCD will inform you which ink cartridge is low or needs replacing. Be sure to follow the LCD prompts to replace the ink cartridges in the correct order.

Even though the MFC informs you that an ink cartridge is empty, there will be a small amount of ink remaining in the ink cartridge. It is necessary to keep some ink in the ink cartridge to prevent air from drying out and damaging the print head assembly.

- 1** Lift the scanner cover from the right-hand side of the MFC until it locks securely into the open position.

If one or more ink cartridges are empty, for example Black, the LCD shows `Ink Empty Black and Cover is Open`.

- 2** Pull the ink cartridge hook toward you and remove the ink cartridge for the colour shown on the LCD.

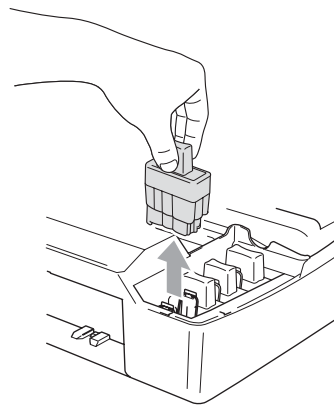
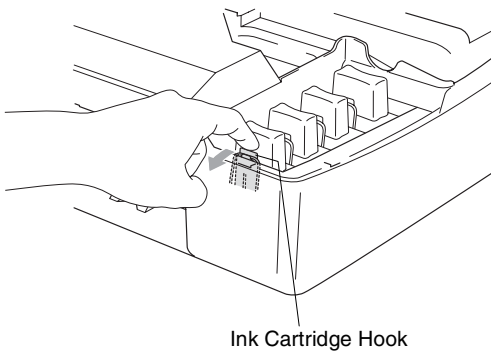

- 3** Open the new ink cartridge bag for the colour shown on the LCD, and then take out the ink cartridge.

**4** Remove the cartridge covers.

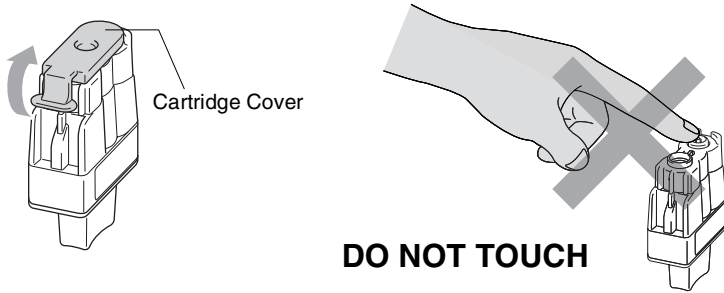

 Do not touch the area shown in the illustration above.

 If the cartridge cover comes off when you open the bag the cartridge will not be damaged.

**5** Each colour has its own correct position. Keep the ink cartridge in an upright position when you insert it into slot. Press down on the ink cartridge until the hook snaps over it.

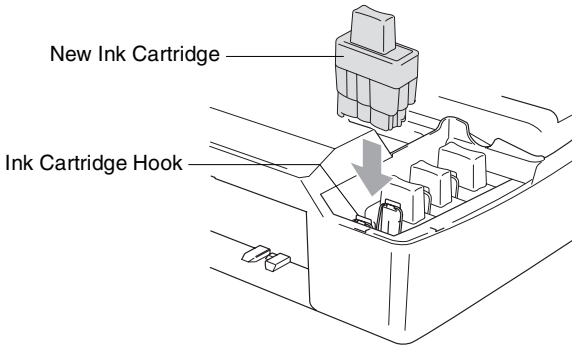

**6** Lift the scanner cover to release the lock. Gently push the scanner cover support down and close the scanner cover.

**7** If you replaced an ink cartridge while `Near Empty` was displayed on the LCD, the LCD may ask you to verify that it was a brand new one. Example: `Did You Change Blck? 1.Yes 2.No`. For each *new* cartridge you installed, press **1** on the dial pad to automatically reset the ink dot counter for that colour. If the ink cartridge you installed is not a brand new one, please be sure to select **2**.



If you wait until `Ink Empty` message is displayed on the LCD, the MFC will automatically reset the ink dot counter.



If the `Install` message is on the display after you have installed ink cartridges, check that the ink cartridges are installed properly.

** WARNING**

If ink gets in your eyes, irrigate them with water immediately and call a doctor if you are concerned.

 **Caution**

- Do not remove ink cartridges if you do not need to replace them. If you do so, it may reduce the ink quantity and the MFC will not know the quantity of ink left in the cartridge.
- Do not touch the cartridge insertion slots. If you do so, the ink may stain your skin.
- If ink stains your skin or clothing, wash with soap or detergent immediately.
- If you install an ink cartridge in the wrong colour position, you must clean the print head several times before you start printing (after correcting the cartridge installation) because the colours were mixed.
- Once you open an ink cartridge, install it in the MFC and use it up within six months of installation. Use unopened ink cartridges by the expiration date written on the cartridge package.
- Do not dismantle or tamper with the ink cartridge, this can cause the ink to leak out of the cartridge.
- Brother multifunction machines are designed to work with ink of a particular specification and work to a level of optimum performance when used with genuine Brother ink cartridges. Brother cannot guarantee this optimum performance if ink or ink cartridges of other specifications are used. Brother does not therefore recommend the use of cartridges other than genuine Brother cartridges with this machine or the refilling of empty cartridges with ink from other sources. If damage is caused to the print head or other parts of this machine as a result of the use of ink or ink cartridges other than genuine Brother products due to the incompatibility or lack of suitability of those products with this machine, any repairs required as a result will not be covered by the warranty.

# A Appendix A

## Telephone services

### BT Call Sign (For U.K. Only)

---

This MFC feature lets you use the BT Call Sign subscriber service which allows you to have at least two separate telephone numbers on one phone line. Each phone number has its own distinctive ringing pattern, so you know which phone number is ringing. This is one way you can have a separate phone number for your MFC.

Your MFC has a BT Call Sign compatible distinctive ringing function, allowing you to dedicate a second phone number (on the same phone line) just for receiving faxes.



You can switch BT Call Sign off temporarily, then turn it back on. When you get a new fax number, make sure you reset this function. The MFC will automatically answer incoming calls that use your new fax number.



When you set the BT Call Sign feature to ON, the receive mode is set to **Manual** automatically. **Manual** mode will not respond to incoming telephone calls, since the number you use for telephone calls will use the normal ring pattern.

### To enable the MFC to work with BT Call Sign (Only with your external phone)

- 1 Press **Menu/Set**, **2**, **0**, **3**.  
The screen displays the current setting of this feature.
- 2 Press **▲** or **▼** to select **On** (or **Off**).
- 3 Press **Menu/Set**.
- 4 Press **Stop/Exit**.



If you turn off BT Call Sign, receive mode stays **Manual**. You need to set receive mode again.

# Advanced receiving operations

## Operation from extension telephones

---

If you answer a fax call on an extension telephone, or an external telephone into the correct socket on the MFC, you can make your MFC take the call by using the Fax Receive Code. When you press the Fax Receive Code \***51**, the MFC starts to receive a fax. (See *Fax Detect* on page 4-4.)

If the MFC answers a voice call and pseudo/double-rings for you to take over, use the Telephone Answer Code **#51** to take the call at an extension phone. (See *Setting the F/T Ring Time (Fax/Tel mode only)* on page 4-3.)

If you answer a call and no one is on the line, you should assume that you're receiving a manual fax.

- Press \***51** and wait for the chirp or until the MFC's LCD displays *Receiving*, and then hang up.

Your caller will have to press **Start** to send the fax.

## For Fax/Tel mode only

---

When the MFC is in Fax/Tel mode, it will use the F/T Ring Time (pseudo/double-ringing) to alert you to pick up a voice call.

Lift the external telephone's handset, and then press **Tel/R** to answer.

If you're at an extension phone, you'll need to lift the handset during the F/T Ring Time and then press **#51** between the pseudo/double rings. If no one is on the line, or if someone wants to send you a fax, send the call back to the MFC by pressing \***51**.

## Fax/Tel mode in the power save condition

---

Fax/Tel mode does not work in the power save condition. The MFC will not answer telephone or fax calls and will keep ringing.

If you are at an external or extension phone, lift the handset of the extension phone and talk. If you hear fax tones, hold the handset until Fax Detect activates your MFC. If the other party says they want to send you a fax, activate the MFC by pressing \***51**.

## Using a cordless external handset

---

If the base unit of your cordless telephone is connected (see page A-4) and you typically carry the cordless handset elsewhere, it is easier to answer calls during the Ring Delay. If you let the MFC answer first, you will have to go to the MFC so you can press **Tel/R** to transfer the call to the cordless handset.

## Changing the remote codes

---

Remote Codes might not work with some telephone systems. The preset Fax Receive Code is \***51**. The preset Telephone Answer Code is **#51**.



If you are always disconnected when accessing your external TAD remotely, try changing the Fax Receive Code and Telephone Answer Code to another three-digit code (such as **###** and **998**).

- 1** If it is not illuminated in green, press  (**Fax**).
- 2** Press **Menu/Set, 2, 1, 4**.
- 3** Press **▲** or **▼** to select **On** (or **Off**).  
Press **Menu/Set**.
- 4** Enter the new Fax Receive Code.  
Press **Menu/Set**.
- 5** Enter the new Telephone Answer Code.  
Press **Menu/Set**.
- 6** Press **Stop/Exit**.

# Connecting an external device to your MFC

## Connecting an external telephone

---

You can connect a separate telephone as shown in the diagram below.

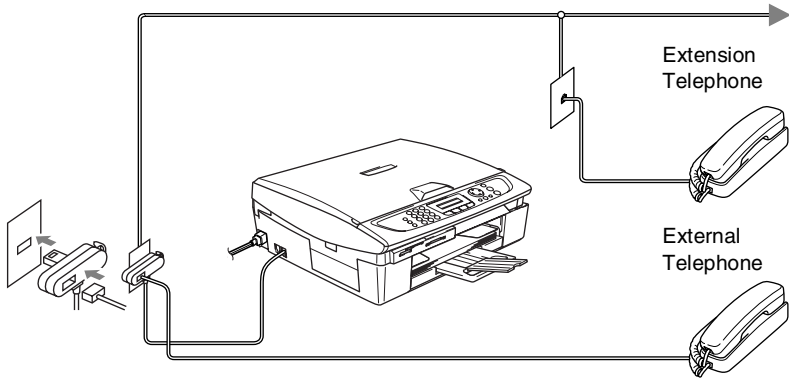

When you are using a TAD, the LCD shows `Ext. Tel in Use.`



# Connecting an external telephone answering device (TAD)

---

## Sequence

You may choose to connect an additional answering device. However, when you have an **external** TAD on the same telephone line as the MFC, the TAD answers all calls and the MFC “listens” for fax calling (CNG) tones. If it hears them, the MFC takes over the call and receives the fax. If it does not hear CNG tones, the MFC lets the TAD continue playing your outgoing message so your caller can leave you a voice message.

The TAD must answer within four rings (the recommended setting is two rings). The MFC cannot hear CNG tones until the TAD has answered the call, and with four rings there are only 8 to 10 seconds of CNG tones left for the fax “handshake”. Make sure you carefully follow the instructions in this guide for recording your outgoing message. We do not recommend using the toll saver feature on your external answering machine if it exceeds five rings.



If you do not receive all your faxes, reduce the Ring Delay setting on your external TAD.

 **Do not connect a TAD elsewhere on the same phone line.**

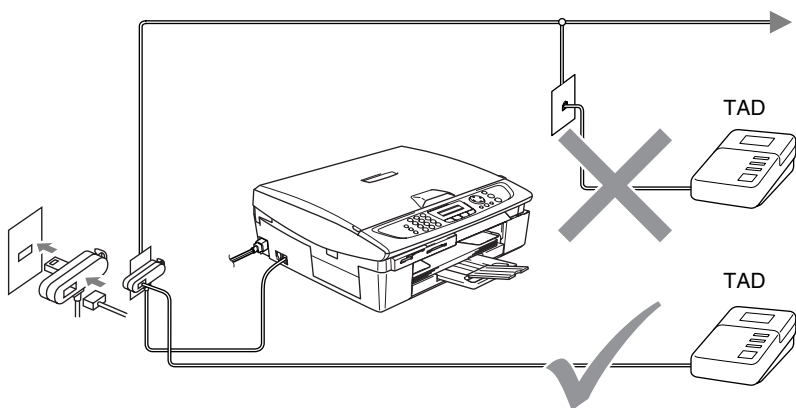

When you are using a TAD, the LCD shows `Telephone`.

## Connections

The external TAD must be connected as shown above.

- 1** Set your external TAD to one or two rings. (The MFC's Ring Delay setting does not apply.)
- 2** Record the outgoing message on your external TAD.
- 3** Set the TAD to answer calls.
- 4** Set the Receive Mode to `External TAD`.  
(See *Choosing the Receive Mode* on page 4-1.)

## Recording outgoing message (OGM) on an external TAD

Timing is important in recording this message. The message sets up the ways to handle both manual and automatic fax reception.

- 1** Record 5 seconds of silence at the beginning of your message. (This allows your MFC time to listen for the fax CNG tones of automatic transmissions before they stop.)
- 2** Limit your speaking to 20 seconds.



We recommend beginning your OGM with an initial 5-second silence because the MFC cannot hear fax tones over a resonant or loud voice. You may try omitting this pause, but if your MFC has trouble receiving, then you must re-record the OGM to include it.

## **Using extension telephones (For U.K. only)**

It may be that your premises are already wired with parallel extension telephones, or you intend to add extension telephones to your line, in addition to your MFC. While the simplest arrangement is straightforward parallel connection, there are some reasons as to why this arrangement will cause unsatisfactory service, the most obvious of which is inadvertent interruption of a facsimile transmission by someone picking up an extension telephone in order to make an outgoing call. Additionally, Fax receive code may not operate reliably in such a simple configuration.

This MFC may also be set to make a delayed transmission (i.e. a transmission at a pre-set time). This pre-set job may coincide with someone picking up an extension handset.

Such problems can easily be eliminated however, if you arrange modification of your extension wiring circuit, such that extension devices are connected “downstream” of your MFC, in a master/slave configuration (see fig. 2 on next page). In such a configuration, this MFC can always detect whether a telephone is in use, thus it will not attempt to seize the line during that time. This is known as “telephone off-hook detection.”

The inadvisable configuration is shown in figure 1 on the next page, and the recommended master/slave configuration is shown in figure 2.

This new connection configuration can be arranged by contacting BT, Kingston upon Hull Telecommunications, your PABX maintainer or a qualified telephone installation company as appropriate. Simply explained, the extension telephone circuit should be terminated on a normal modular plug (BT 431A style), which in turn should be inserted into the modular socket of the white “T”-shaped connector provided as part of the line cord assembly.

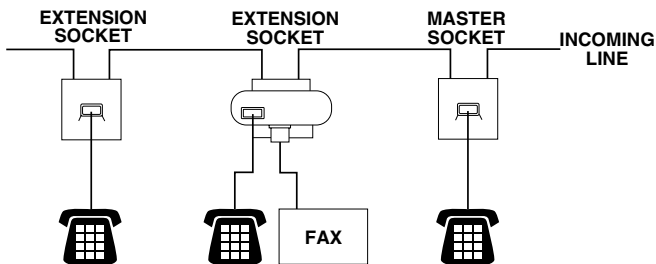
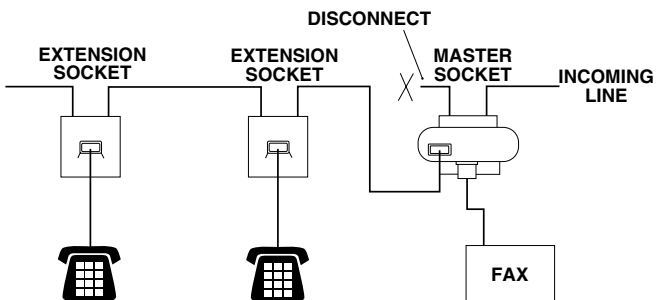

Fig. 1.



RECOMMENDED CONNECTION OF EXTENSION SOCKETS

Fig. 2.



These phones are now connected as external devices as per page A-4, because they are connected to the fax machine via the T-connector.

## Multi-line connections (PBX)

---

Most offices use a central telephone system. While it is often relatively simple to connect the MFC to a key system or a PBX (Private Branch Exchange), we suggest that you contact the company that installed your telephone system and ask them to connect the MFC for you. It is advisable to have a separate line for the MFC.

If the MFC is to be connected to a multi-line system, ask your installer to connect the unit to the last line on the system. This prevents the unit from being activated each time a telephone call is received.

### If you are installing the MFC to work with a PBX

- 1** It is not guaranteed that the unit will operate properly under all circumstances with a PBX. Any cases of difficulty should be reported first to the company that handles your PBX.
- 2** If all incoming calls will be answered by a switchboard operator, it is recommended that the Receive Mode be set to *Manual*. All incoming calls should initially be regarded as telephone calls.

## Custom features on your phone line

---

If you have Voice Mail, Call Waiting, Call Waiting/Caller ID, RingMaster, an answering service, an alarm system or other custom feature on one phone line it may create a problem with the operation of your MFC. (See *Custom features on a single line*. on page 11-11.)

# B Appendix B

## On-screen programming

Your MFC is designed to be easy to use with LCD on-screen programming using the navigation keys. User-friendly programming helps you take full advantage of all the menu selections your MFC has to offer.

Since your programming is done on the LCD, we have created step-by-step on-screen instructions to help you program your MFC. All you need to do is follow the instructions as they guide you through the menu selections and programming options.

### Menu table

---

You can probably program your MFC without the User's Guide if you use the Menu table that begins on page B-3. These pages will help you understand the menu selections and options that are found in the MFC's programs.



You can program your MFC by pressing **Menu/Set**, followed by the menu numbers.

For example to set `Fax Resolution` to `Fine`:

Press **Menu/Set**, **2**, **2**, **2** and **▲** or **▼** to select `Fine`.





Press **Menu/Set**.

### Memory storage

---

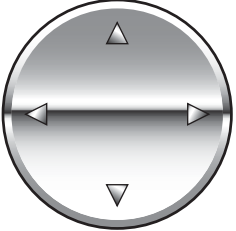
If there is a power failure, you will not lose your menu settings because they are stored permanently. Temporary settings (such as Contrast, Overseas Mode, and so on) will be lost. You may also have to reset the date and time.

# Navigation keys

	 Menu/Set	Access the menu Go to the next menu level Accept an option
		Scroll through the current menu level
		Go back to the previous menu level
	 Stop/Exit	Exit the menu

You can access the menu mode by pressing **Menu/Set**.  
 When you enter the menu, the LCD scrolls.

Press **1** for General Setup menu

—OR—

Select ▲▼ & Set  
 1.General Setup

Press **2** for Fax menu

—OR—

Select ▲▼ & Set  
 2.Fax

Press **3** for Copy menu

⋮

Select ▲▼ & Set  
 3.Copy

Press **0** for Initial Setup

Select ▲▼ & Set  
 0.Initial Setup

You can scroll more quickly through each menu level by pressing the arrow for the direction you want: ▲ or ▼.

Select an option by pressing **Menu/Set** when that option appears on the LCD.

The LCD will then show the next menu level.

Press ▲ or ▼ to scroll to your next menu selection.

Press **Menu/Set**.

When you finish setting an option, the LCD shows *Accepted*.



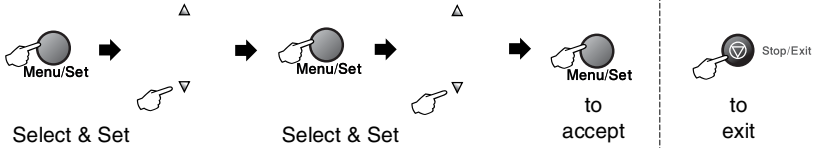

Main Menu	Submenu	Menu Selections	Options	Descriptions	Page	
1.General Setup	1.Mode Timer	—	5 Mins <b>2 Mins</b> 1 Min 30 Secs 0 Sec Off	Sets the time to return to Fax mode.	2-4	
	2.Paper Type	—	<b>Plain</b> Inkjet Glossy Transparency	Sets the type of paper in the paper tray.	2-4	
	3.Paper Size	—	Letter Legal <b>A4</b> A5 10x15cm	Sets the size of the paper in the paper tray.	2-5	
	4.Volume	1.Ring	—	High <b>Med</b> Low Off	Adjusts the ring volume.	2-5
		2.Beeper	—	High Med <b>Low</b> Off	Adjusts the volume level of the beeper.	2-6
		3.Speaker	—	High <b>Med</b> Low Off	Adjusts the speaker volume.	2-6
	5.Auto Daylight	—	<b>On</b> Off	Changes for Daylight Savings Time automatically.	2-7	
	6.P. Save Setting	—	<b>Fax Receive:On</b> Fax Receive:Off	Customizes the <b>Power Save</b> key not to receive fax in Power Save mode.	1-5	
7.LCD Contrast	—	<b>Light</b> Dark	Adjust the contrast of LCD.	2-7		



The factory settings are shown in Bold.

Main Menu	Submenu	Menu Selections	Options	Descriptions	Page
2.Fax	1.Setup Receive (In Fax mode only)	1.Ring Delay	01-04 (02) (UK only) 00-05 (02) (Nordic countries only)	Sets the number of rings before the MFC answers in Fax Only or Fax/Tel mode.	4-2
		2.F/T Ring Time	70 Sec 40 Sec <b>30 Sec</b> 20 Sec	Sets the pseudo/double-ring time in Fax/Tel mode.	4-3
		3.Fax Detect	<b>On</b> Off	Receives fax messages without pressing the <b>Mono Start</b> or <b>Colour Start</b> key.	4-4
		4.Remote Code	<b>On</b> (*51, #51) Off	You can answer all calls at an extension or external phone and use codes to turn the MFC on or off. You can personalize these codes.	A-3
		5.Auto Reduction	<b>On</b> Off	Reduces the size of incoming faxes.	4-5
		6.Memory Receive	<b>On</b> Off	Automatically stores any incoming faxes in its memory if it runs out of paper.	4-6
		7.Polling RX (MFC-410CN only)	Standard Secure Timer	Sets up your MFC to poll another fax machine.	4-7
	2.Setup Send (In Fax mode only)	1.Contrast	<b>Auto</b> Light Dark	Changes the lightness or darkness of faxes you send.	3-5
		2.Fax Resolution	<b>Standard</b> Fine S.Fine Photo	Sets the default resolution for outgoing faxes.	3-6
		3.Delayed Fax (MFC-410CN only)	—	Set the time of day in 24 hour format that the delayed faxes will be sent.	3-12



The factory settings are shown in Bold.

Main Menu	Submenu	Menu Selections	Options	Descriptions	Page
2.Fax (Continued)	2.Setup Send (In Fax mode only) (Continued)	4.Batch TX (MFC-410CN only)	On <b>Off</b>	Combines delayed faxes to the same fax number at the same time of day into one transmission.	3-13
		3.Real Time TX (MFC-210C only) 5.Real Time TX (MFC-410CN only)	<b>Off</b> On Next Fax Only	You can send a fax without using the memory.	3-8
		6.Polled TX (MFC-410CN only)	Standard Secure	Sets up the document on your MFC to be retrieved by another fax machine.	3-13
		4.Overseas Mode (MFC-210C only) 7.Overseas Mode (MFC-410CN only)	On <b>Off</b>	If you are having difficulty sending faxes overseas, set this to On.	3-11
		0.Scan Size	Letter <b>A4</b>	Adjust the scan area of the scanner glass to the size of the document.	3-17
		3.Set Quick-Dial	1.Speed-Dial	—	Stores Speed-Dial numbers, so you can dial by pressing only a few keys (and Start).
	2.Setup Groups		—	Sets up a Group number for Broadcasting.	5-3
	4.Report Setting	1.XMIT Report	On On+Image <b>Off</b> Off+Image	Initial setup for Transmission Verification Report and Journal Report.	7-1
		2.Journal Period	Every 7 Days Every 2 Days Every 24 Hours Every 12 Hours Every 6 Hours <b>Every 50 Faxes</b> Off		7-2



The factory settings are shown in Bold.

Main Menu	Submenu	Menu Selections	Options	Descriptions	Page	
2.Fax (Continued)	5.Remote Fax Opt (MFC-410CN only)	1.Forward/Store	Off Fax Forward Fax Storage PC Fax Receive	Sets the MFC to forward fax messages, to store incoming faxes in the memory (so you can retrieve them while you are away from your MFC), or to send faxes to your PC.	6-2	
		2.Remote Access	---*	You must set your own code for Remote Retrieval.	6-3	
		3.Print Document	—	Prints incoming faxes stored in the memory.	4-5	
	5.Remaining Jobs (MFC-210C only) 6.Remaining Jobs (MFC-410CN only)	—	—	Checks which jobs are in the memory and lets you cancel selected jobs.	3-9	
		0.Miscellaneous	1.TX Lock	—	Prohibits most functions except receiving faxes.	3-15
	3.Copy	1.Quality	2.Compatibility	Normal Basic	Adjust the Equalization for transmission problems.	11-13
			3.BT Call Sign (U.K. Only)	On off	Use with BT Call Sign.	A-1
			3.Distinctive (Denmark Only)	—	See Danish User's Guide included on the CD-ROM.	—
	3.Copy	2.Brightness	1.Quality	Best Normal Fast	Selects the Copy resolution for your type of document.	8-12
			3.Contrast	—	Adjusts the contrast for copies.	8-12
2.Brightness			—	Adjusts the brightness.	8-12	
3.Copy	3.Contrast	1.Quality	Best Normal Fast	Selects the Copy resolution for your type of document.	8-12	
		3.Contrast	—	Adjusts the contrast for copies.	8-12	
		2.Brightness	—	Adjusts the brightness.	8-12	



The factory settings are shown in Bold.

Main Menu	Submenu	Menu Selections	Options	Descriptions	Page
3.Copy (Continued)	4.Color Adjust	1.Red	R:- 0000■ + R:- 0000■ + <b>R:- 0000■ +</b> R:- 0■000 + R:- ■0000 +	Adjusts the amount of Red in copies.	8-13
		2.Green	G:- 0000■ + G:- 0000■ + <b>G:- 0000■ +</b> G:- 0■000 + G:- ■0000 +	Adjusts the amount of Green in copies.	
		3.Blue	B:- 0000■ + B:- 0000■ + <b>B:- 0000■ +</b> B:- 0■000 + B:- ■0000 +	Adjusts the amount of Blue in copies.	
4.PhotoCapture	1.Print Quality	—	Normal <b>Photo</b>	Selects the print quality.	9-9
	2.Paper & Size	—	Letter Glossy 10x15cm Glossy 13x18cm Glossy <b>A4 Glossy</b> Letter Plain A4 Plain Letter Inkjet A4 Inkjet 10x15cm Inkjet	Selects the paper and print size.	9-9
	3.Brightness	—	- 0000■ + - 0000■ + - 0000■ + - 0■000 + - ■0000 +	Adjusts the brightness.	9-10
	4.Contrast	—	- 0000■ + - 0000■ + - 0000■ + - 0■000 + - ■0000 +	Adjusts the contrast.	9-10



The factory settings are shown in Bold.

Main Menu	Submenu	Menu Selections	Options	Descriptions	Page
4.PhotoCapture (Continued)	5.Color Enhance (MFC-410CN only)	Color Enhance:On Color Enhance:Off	1.White Balance - 0000 ■ + - 000 ■ 0 + - 00 ■ 00 + - 0 ■ 000 + - ■ 0000 +	Adjusts the hue of the white areas.	9-10
			2.Sharpness - 0000 ■ + - 000 ■ 0 + - 00 ■ 00 + - 0 ■ 000 + - ■ 0000 +	Enhances the detail of the image.	
			3.Color Density - 0000 ■ + - 000 ■ 0 + - 00 ■ 00 + - 0 ■ 000 + - ■ 0000 +	Adjusts the total amount of colour in the image.	
	5.Cropping (MFC-210C only) 6.Cropping (MFC-410CN only)	—	On Off	Crops the image around the margin to fit the paper size or print size. Turn this feature Off if you want to print whole images or prevent unwanted cropping.	9-12
	6.Borderless (MFC-210C only) 7.Borderless (MFC-410CN only)	—	On Off	Expands the printable area to fit the edges of the paper	9-12
8.Scan to Card (MFC-410CN only)	1.Quality	B/W 200x100 dpi B/W 200 dpi Color 150 dpi Color 300 dpi Color 600 dpi	Selects the Scan resolution for your type of document.	2-25* <sup>1</sup>	
	2.B/W File Type	TIFF PDF	Selects the default file format for black and white scanning.	2-26* <sup>1</sup>	
	3.ColorFile Type	PDF JPEG	Selects the default file format for colour scanning.	2-27* <sup>1</sup>	



The factory settings are shown in Bold.

\*<sup>1</sup> See the complete Software User's Guide on the CD-ROM.

Main Menu	Submenu	Menu Selections	Options	Descriptions	Page
5.LAN (MFC-410CN only)	1.Setup TCP/IP	1.BOOT Method	<b>Auto</b> Static RARP BOOTP DHCP	You can choose the BOOT method that best suits you needs.	See Network User's Guide on the CD-ROM
		2.IP Address	[000-255]. [000-255]. [000-255]. [000-255]	Enter the IP address.	
		3.Subnet Mask	[000-255]. [000-255]. [000-255]. [000-255]	Enter the Subnet mask.	
		4.Gateway	[000-255]. [000-255]. [000-255]. [000-255]	Enter the Gateway address.	
		5.Host Name	BRN_XXXXXX	Enter the Host name.	
		6.WINS Config	<b>Auto</b> Static	You can choose the WINS configuration mode.	
		7.WINS Server	(Primary) 000.000.000.000	Specifies the IP address of the primary or secondary server.	
		8.DNS Server	(Primary) 000.000.000.000	Specifies the IP address of the primary or secondary server.	
		9.APIPA	<b>On</b> Off	Automatically allocates the IP address from the link-local address range.	



The factory settings are shown in Bold.

Main Menu	Submenu	Menu Selections	Options	Descriptions	Page
5.LAN (MFC-410CN only) (Continued)	2.Setup Misc.	1.Ethernet	<b>Auto</b> 100B-FD 100B-HD 10B-FD 10B-HD	Selects Ethernet link mode.	See Network User's Guide on the CD-ROM
		2.Time Zone	GMT+0:00	Sets the time zone for your country.	
	0.Factory Reset	—	—	Restore all network settings to factory default.	
5.Print Reports (MFC-210C only) 6.Print Reports (MFC-410CN only)	1.Help List	—	—	You can print these lists and reports.	7-3
	2.Quick-Dial	—	—		
	3.Fax Journal	—	—		
	4.XMIT Verify	—	—		
	5.User Settings (MFC-410CN only)	—	—		
	6.Network Config (MFC-410CN only)	—	—		
0.Initial Setup	1.Receive Mode	—	<b>Fax Only</b> Fax/Tel External TAD Manual	You can choose the receive mode that best suits your needs.	4-1 4-2
	2.Date/Time	—	—	Puts the date and time on the LCD and in headings of faxes you send.	2-1
	3.Station ID	—	Fax: Name:	Program your name and fax number to appear on each page you fax.	2-2
	4.Tone/Pulse (Excluding Nordic countries)	—	<b>Tone</b> Pulse	Selects the dialling mode.	2-1



The factory settings are shown in Bold.



Main Menu	Submenu	Menu Selections	Options	Descriptions	Page
0.Initial Setup (Continued)	5.Phone Line Set	—	<b>Normal</b> PBX ADSL ISDN	Select the phone line type.	2-3
	0.Local Language (For Czech and Hungarian)	—	Czech Hungar. English	Allows you to change the LCD Language for your country.	11-13
	0.Local Language (For Norwegian, Swedish, Danish and Finnish)	—	Norweg. Swedish Danish Finnish English		



The factory settings are shown in Bold.

## Entering Text

---

When you are setting certain menu selections, such as the Station ID, you may need to type text into the MFC. Most number keys have three or four letters printed above them. The keys for **0**, **#** and **\*** do not have printed letters because they are used for special characters.

By pressing the appropriate number key repeatedly, you can access the character you want.

Press Key	one time	two times	three times	four times
<b>2</b>	A	B	C	2
<b>3</b>	D	E	F	3
<b>4</b>	G	H	I	4
<b>5</b>	J	K	L	5
<b>6</b>	M	N	O	6
<b>7</b>	P	Q	R	S
<b>8</b>	T	U	V	8
<b>9</b>	W	X	Y	Z

### Inserting spaces

To enter a space in the fax number, press ► once between numbers. To enter a space in the name, press ► twice between characters.

### Making corrections

If you entered a letter incorrectly and want to change it, press ◀ to move the cursor under the incorrect character. Then press **Stop/Exit**. All letters above and to the right of the cursor will be deleted. Re-enter the correct character. You can also back up and type over incorrect letters.

### Repeating letters

If you need to enter a character that is on the same key as the previous character, press ► to move the cursor to the right before you press the key again.

## Special characters and symbols

Press **\***, **#** or **0**, and then press **◀** or **▶** to move the cursor under the special character or symbol you want. Then press **Menu/Set** to select it.

Press <b>*</b>	for	(space) ! " # \$ % & ' ( ) * + , - . / €
Press <b>#</b>	for	: ; < = > ? @ [ ] ^ _
Press <b>0</b>	for	Ä Ë Ö Ü À Ç È É 0

# G Glossary

**Auto Reduction** Reduces the size of incoming faxes.

**Automatic fax transmission** Sending a fax without picking up the handset of an external phone.

**Automatic Redial** A feature that enables your MFC to redial the last fax number after five minutes if the fax did not go through because the line was busy.

**Backup Print** Your MFC prints a copy of every fax that is received and stored in memory.

This is a safety feature so you will not lose messages during a power failure.

**Batch Transmission (MFC-410CN only)** (Black and white faxes only) As a cost saving feature, all delayed faxes to the same fax number will be sent as one transmission.

**Beeper Volume** Volume setting for the beep when you press a key or make an error.

**Brightness** Changing the Brightness makes the whole image lighter or darker.

**Broadcasting** The ability to send the same fax message to more than one location.

**Cancel Job** Cancels a programmed job, like Delayed Fax or Polling.

**CNG tones** The special tones (beeps) sent by fax machines during automatic transmission to tell the receiving machine that a fax machine is calling.

**Coding method** Method of coding the information contained in the document. All fax machines must use a minimum standard of Modified Huffman (MH). Your MFC is capable of greater compression methods, Modified Read (MR), Modified Modified Read (MMR) and JPEG, if the receiving machine has the same capability.

**Communication error (or Comm. Error)** An error during fax sending or receiving, usually caused by line noise or static.

- Compatibility group** The ability of one fax unit to communicate with another. Compatibility is assured between ITU-T Groups.
- Contrast** Setting to compensate for dark or light documents, by making faxes or copies of dark documents lighter and light documents darker.
- Colour Enhancement (MFC-410CN only)** Adjusts the colour in the image for better print quality by improving sharpness, white balance and colour density.
- Delayed Fax (MFC-410CN only)** Sends your fax at a specified later time that day.
- Dual Access** Your MFC can scan outgoing faxes or scheduled jobs into memory at the same time it is sending a fax or receiving or printing an incoming fax.
- ECM (Error Correction Mode)** Detects errors during fax transmission and resends the pages of the fax that had an error.
- Extension phone** A telephone on the fax number that is plugged into a separate wall socket.
- External phone** A TAD (telephone answering device) or telephone that is connected to your MFC.
- F/T Ring Time** The length of time that the Brother MFC rings (when the Receive Mode setting is Fax/Tel) to notify you to pick up a voice call that it answered.
- Fax Detect** Enables your MFC to respond to CNG tones if you interrupt a fax call by answering it.
- Fax Forwarding (MFC-410CN only)** Sends a fax received into the memory to another pre-programmed fax number.
- Fax Journal** Lists information about the last 200 incoming and outgoing faxes. TX means Transmit. RX means Receive.
- Fax Receive Code** Press this code (✳ 51) when you answer a fax call on an extension or external phone.
- Fax Storage (MFC-410CN only)** You can store faxes in memory.
- Fax tones** The signals sent by sending and receiving fax machines while communicating information.

**Fax/Tel** You can receive faxes and telephone calls. Do not use this mode if you are using a telephone answering device (TAD).

**Fine resolution** Resolution is 203 x 196 dpi. It is used for small print and graphs.

**Gray scale** The shades of gray available for copying and faxing photographs.

**Group number** A combination of Speed-Dial numbers that are stored in a Speed-Dial location for Broadcasting.

**Help list** A printout of the complete Menu table that you can use to program your MFC when you do not have the User's Guide with you.

**Journal Period** The pre-programmed time period between automatically printed Fax Journal Reports. You can print the Fax Journal on demand without interrupting the cycle.

**LCD (liquid crystal display)** The display screen on the MFC that shows interactive messages during On-Screen Programming and shows the date and time when the MFC is idle.

**Manual fax** When you lift the handset of your external telephone so you can hear the receiving fax machine answer before you press **Mono Start** or **Colour Start** to begin transmission.

**Menu mode** Programming mode for changing your MFC's settings.

**OCR (optical character recognition)** The bundled ScanSoft® OmniPage® software application converts an image of text to text you can edit.

**Out of Paper Reception** Receives faxes into the MFC's memory when the MFC is out of paper.

**Overseas Mode** Makes temporary changes to the fax tones to accommodate noise and static on overseas phone lines.

**Pause** Allows you to place a 3.5 second delay in the dialling sequence stored on Speed-Dial numbers. Press **Redial/Pause** as many times as needed for longer pauses.

**PhotoCapture Center™** Allows you to print digital photos from your digital camera at high resolution for photo quality printing.

**Photo resolution** A resolution setting that uses varying shades of gray for the best representation of photographs.

- Polling (MFC-410CN only)** The process of a fax machine calling another fax machine to retrieve waiting fax messages.
- Pulse** A form of rotary dialling on a telephone line.
- Quick Dial List** A listing of names and numbers stored in Speed-Dial memory, in numerical order.
- Real Time Transmission** When memory is full, you can send faxes in real time.
- Remaining jobs** You can check which jobs are waiting in memory and cancel jobs individually.
- Remote Access Code (MFC-410CN only)** Your own four-digit code (---\*) that allows you to call and access your MFC from a remote location.
- Remote Retrieval Access (MFC-410CN only)** The ability to access your MFC remotely from a touch tone phone.
- Resolution** The number of vertical and horizontal lines per inch. See: Standard, Fine, Super Fine and Photo.
- Ring Delay** The number of rings before the MFC answers in *Fax Only* and *Fax/Tel* mode.
- Ring Volume** Volume setting for the MFC's ring.
- Scanning** The process of sending an electronic image of a paper document into your computer.
- Scan to Card (MFC-410CN)** You can scan a black and white or colour document into a Media Card. Black and white images will be in TIFF or PDF file format and colour images may be in PDF or JPEG file format.
- Search** An electronic, alphabetical listing of stored Speed-Dial and Group numbers.
- Speed-Dial** A pre-programmed number for easy dialling. You must press the **Search/Speed Dial**, **#**, and the two digit code, and **Mono Start** or **Colour Start** to start the dialling process.
- Standard resolution** 203 x 97 dpi. It is used for regular size text and quickest transmission.

**Station ID** The stored information that appears on the top of faxed pages. It includes the sender's name and fax number.

**Super Fine resolution** 392 x 203 dpi. Best for very small print and line art.

**TAD (telephone answering device)** You can connect an external TAD to your MFC.

**Temporary settings** You can select certain options for each fax transmission and copy without changing the default settings.

**Tone** A form of dialling on the telephone line used for Touch Tone telephones.

**Transmission** The process of sending faxes over the phone lines from your MFC to the receiving fax machine.

**User Settings (MFC-410CN only)** A printed report that shows the current settings of the MFC.

**Xmit Report (Transmission Verification Report)** A listing for each transmission, that shows its date, time and number.



# S Specifications

## Product description

### General

<b>Memory Capacity</b>	8 MB (MFC-210C) 16 MB (MFC-410CN)
<b>Paper Tray</b>	100 Sheets (80 g/m <sup>2</sup> )
<b>Printer Type</b>	Ink Jet
<b>Print Method</b>	Piezo with 74 × 5 nozzles
<b>LCD (Liquid Crystal Display)</b>	16 characters × 1 line (MFC-210C) 16 characters × 2 lines (MFC-410CN)
<b>Power Source</b>	220 - 240V 50/60Hz
<b>Power Consumption</b>	(MFC-210C) Power Save Mode: Under 3.5 watts Standby: 6.9 Wh or less (25°C) Operating: 20 Wh or less (MFC-410CN) Power Save Mode: Under 4 watts Standby: 9 Wh or less (25°C) Operating: 19 Wh or less

### Dimensions

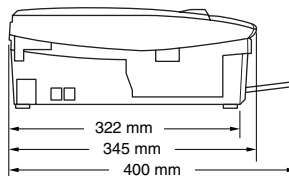
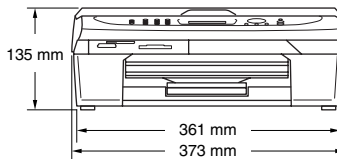

<b>Weight</b>	5 kg
<b>Noise</b>	Operating: 42.5 to 51 dB* * It depends on printing conditions
<b>Temperature</b>	Operating: 10 - 35°C Best Print Quality: 20 - 33°C
<b>Humidity</b>	Operating: 20 to 80% (without condensation) Best Print Quality: 20 to 80% (without condensation)

## Print media

### Paper Input

### Paper Tray

- Paper type:  
Plain paper, inkjet paper (coated paper), glossy paper\*<sup>2</sup>, transparencies\*<sup>1\*2</sup> and envelopes
- Paper size:  
Letter, Legal\*<sup>3</sup>, Executive, A4, A5, A6, JIS\_B5, envelopes (commercial No.10, DL, C5, Monarch, JE4), Photo card, Index card and Post card.  
For more details, see *Paper weight, thickness and capacity* on page 1-10.
- Maximum paper tray capacity: Approx. 100 sheets of 80 g/m<sup>2</sup> plain paper

### Paper Output

Up to 25 sheets of A4 plain paper (Face up print delivery to the output paper tray)\*<sup>2</sup>

\*<sup>1</sup> Use only transparencies recommended for inkjet printing.

\*<sup>2</sup> For glossy paper or transparencies, we recommend removing printed pages from the output paper tray immediately after they exit the machine to avoid smudging.

\*<sup>3</sup> Legal paper cannot be stacked on the output paper tray.

# Copy

**Colour/Black**

Colour/Black

**Document Size  
(MFC-210C only)**

Scanner Glass Width: Max. 216 mm  
Scanner Glass Height: Max. 297 mm

**Copy Speed**

Black

Up to 17 pages/minute (A4 paper)\*

Colour

Up to 11 pages/minute (A4 paper)\*

\* Does not include the time it takes to feed the paper.  
Based on Brother standard pattern. (Fast mode/Stack Copy)  
Copy speeds vary with the complexity of the document.

**Multiple Copies**

Stacks up to 99 pages

**Enlarge/Reduce**

25% to 400% (in increments of 1%)

**Resolution**

Up to 600 x 1200 dpi copy resolution for plain,  
inkjet or glossy paper and up to 1200 x 1200 dpi  
for OHP/transparency

# PhotoCapture Center

## Available Media

CompactFlash®

(Type I only)

(Microdrive™ is not compatible)

(Compact I/O card such as Compact LAN card and Compact Modem card are not supported.)

SmartMedia® (3.3V)

(Not available for use with ID)

Memory Stick®

(Not available for music data with MagicGate™)

SecureDigital™

xD-Picture Card™

## File Extension

(Media Format)

DPOF, EXIF, DCF

(Image Format)

Photo Print: JPEG\*

Scan to Card (MFC-410CN only):

JPEG, PDF (Colour)

TIFF, PDF (Black)

\* Progressive JPEG format is not supported.

## Number of Files

Up to 999 files in the media card

## Folder

File must be in the 3rd folder level of the Media Card.

## Borderless

Letter, A4, Photo Card (MFC-410CN)

Photo Card (MFC-210C)

# Fax

<b>Compatibility</b>	ITU-T Group 3
<b>Coding System</b>	MH/MR/MMR/JPEG
<b>Modem Speed</b>	Automatic Fallback 14400 bps
<b>Document Size (MFC-210C only)</b>	Scanner Glass Width: Max. 216 mm Scanner Glass Height: Max. 297 mm
<b>Scanning Width</b>	208 mm
<b>Printing Width</b>	204 mm
<b>Gray Scale</b>	256 levels
<b>Polling Types (MFC-410CN only)</b>	Standard, Secure, Timer Sequential: (B&W only)
<b>Contrast Control</b>	Automatic/Light/Dark (manual setting)
<b>Resolution</b>	<ul style="list-style-type: none"><li>• Horizontal 203 dot/inch (8 dot/mm)</li><li>• Vertical Standard -<ul style="list-style-type: none"><li>3.85 line/mm (Black)</li><li>7.7 line/mm (Colour)</li><li>Fine - 7.7 line/mm (Black/Colour)</li><li>Photo - 7.7 line/mm (Black)</li><li>Superfine - 15.4 line/mm (Black)</li></ul></li></ul>
<b>Speed-Dial</b>	20 stations (MFC-210C) 80 stations (MFC-410CN)
<b>Broadcasting</b>	70 stations (MFC-210C) 130 stations (MFC-410CN)
<b>Automatic Redial</b>	3 times at 5 minute intervals
<b>Auto Answer</b>	0, 1, 2, 3 or 4 rings (0, 1, 2, 3, 4, or 5 rings - Nordic countries only)

<b>Communication Source</b>	Public switched telephone network and PABX.
<b>Memory Transmission</b>	Up to 200* <sup>1</sup> /170* <sup>2</sup> pages (MFC-210C) Up to 480* <sup>1</sup> /400* <sup>2</sup> pages (MFC-410CN only)
<b>Out of Paper Reception</b>	Up to 200* <sup>1</sup> /170* <sup>2</sup> pages (MFC-210C) Up to 480* <sup>1</sup> /400* <sup>2</sup> pages (MFC-410CN only)

\*1 "Pages" refers to the "Brother Standard Chart No. 1" (a typical business letter, Standard resolution, MMR code). Specifications and printed materials are subject to change without prior notice.

\*2 "Pages" refers to the "ITU-T Test Chart #1" (a typical business letter, Standard resolution, MMR code). Specifications and printed materials are subject to change without prior notice.

## Scanner

<b>Colour/Black</b>	Colour/Black
<b>TWAIN Compliant</b>	Yes (Windows <sup>®</sup> 98/98SE/Me/2000 Professional/XP) Mac OS <sup>®</sup> 8.6-9.2/Mac OS <sup>®</sup> X 10.2.4 or greater
<b>WIA Compliant</b>	Yes (Windows <sup>®</sup> XP)
<b>Colour Depth</b>	36 bit colour processing (Input) 24 bit colour processing (Output)
<b>Resolution</b>	Up to 19200 × 19200 dpi (interpolated)* Up to 600 × 2400 dpi (optical) <small>* Maximum 1200 x 1200 dpi scanning with Windows<sup>®</sup> XP (resolution up to 19200 x 19200 dpi can be selected by using the Brother scanner utility)</small>
<b>Scanning Speed</b>	Colour: up to 5.93 sec. Black: up to 3.76 sec. (A4 size in 100 × 100 dpi)
<b>Document Size (MFC-210C only)</b>	Scanner Glass Width: Max. 216 mm Scanner Glass Height: Max. 297 mm
<b>Scanning Width</b>	210 mm
<b>Gray Scale</b>	256 levels

 Mac OS<sup>®</sup> X scanning is supported in Mac OS<sup>®</sup> X 10.2.4 or greater.

# Printer

<b>Printer Driver</b>	Windows® 98/98SE/Me/2000 Professional and XP driver supporting Brother Native Compression mode and bi-directional capability Apple® Macintosh® QuickDraw® Driver For Mac OS® 8.6-9.2/Mac OS® X 10.2.4 or greater
<b>Resolution</b>	Up to 1200 x 6000 dots per inch (dpi)* 1200 x 1200 dots per inch (dpi) 600 x 600 dots per inch (dpi) 600 x 150 dots per inch (dpi) <small>* Output image quality varies based upon many factors including but not limited to input image resolution and quality and print media.</small>
<b>Print Speed</b>	up to 20 pages/minute (Black)* up to 15 pages/minute (Colour)* <small>* Based on Brother standard pattern. A4 size in draft mode. Does not include the time it takes to feed the paper.</small>
<b>Printing Width</b>	204 mm (216 mm)* <small>* When you set the Borderless feature to On.</small>
<b>Disk-Based Fonts</b>	35 TrueType
<b>Borderless</b>	Letter, A4, A6, Photo Card, Index Card, Post Card

# Interfaces

<b>USB</b>	A Full-Speed USB 2.0 cable that is no longer than 2.0 m.*
<b>LAN cable (MFC-410CN only)</b>	Ethernet UTP cable category 5 or greater.  <small>* Your MFC has a Full-Speed USB 2.0 interface. This interface is compatible with Hi-Speed USB 2.0; however, the maximum data transfer rate will be 12 Mbits/s. The MFC can also be connected to a computer that has a USB 1.1 interface.</small>

# Computer requirements

Minimum System Requirements						
Computer Platform & Operating System Version		Processor Minimum Speed	Minimum RAM	Recommended RAM	Available Hard Disk Space	
					for Drivers	for Applications
Windows® *1 Operating System	98, 98SE	Pentium II or equivalent	32 MB	64 MB	90 MB	130 MB
	Me		64 MB	128 MB		
	2000 Professional		128 MB	256 MB	150 MB	220 MB
	XP*2					
Apple® Macintosh® Operating System	Mac OS® 8.6 (Printing and PC-FAX Send*4 Only)	All base models meet minimum Requirements		64 MB	80 MB	200 MB
	Mac OS® 9.X (Printing, Scanning*3, PhotoCapture Center™ and PC-FAX Send*4 Only)					
	Mac OS® X 10.2.4 or greater		128 MB	160 MB		
<b>NOTE:</b> All registered trademarks referenced herein are the property of their respective companies.						
For the latest drivers, go to the Brother Solutions Center at <a href="http://solutions.brother.com/">http://solutions.brother.com/</a>						

\*1 Microsoft® Internet Explorer 5 or greater.

\*2 Maximum 1200 x 1200 dpi scanning with Windows® XP. (Resolutions up to 19200 x 19200 dpi can be selected using the Brother Utility.)

\*3 Dedicated "Scan" key and direct Network Scanning (MFC-410CN only) supported in Mac® Operating Systems Mac OS® X 10.2.4 or greater.

\*4 PC Fax supports black and white faxing only.



# Consumable items

## Ink

The MFC uses individual Black, Yellow, Cyan and Magenta ink cartridges that are separate from the print head assembly.

## Service Life of Ink Cartridge

Black - Approximately 500 pages at 5% coverage  
Yellow, Cyan and Magenta - Approximately 400 pages at 5% coverage

The above figures are based upon the following assumptions:

- Continuous printing at a resolution of 600 x 600 dpi in normal mode after installing new ink cartridge;
- The printing frequency;
- The number of pages printed;
- Periodic, automatic, print head assembly cleaning (Your MFC will clean the print head assembly periodically. This process will use a small amount of ink); and,
- Ink remaining in cartridge identified as “empty” (It is necessary to leave a small amount of ink in the ink cartridge to prevent air from drying out and damaging the print head assembly).

## Replacement Consumables

<Black> LC900BK, <Cyan> LC900C,  
<Magenta> LC900M, <Yellow> LC900Y

# Network (LAN) (MFC-410CN only)

## LAN

You can connect your MFC to a network for Network Printing, Network Scanning and PC Fax Send. Also included is Brother BRAdmin Professional Network Management software.

## Support for

Windows® 98/98SE/Me/2000/XP  
Mac OS® 8.6 - 9.2, Mac OS® X 10.2.4 or greater\*  
Ethernet 10/100 BASE-TX Auto Negotiation

## Protocols

TCP/IP

RARP, BOOTP, DHCP, APIPA, NetBIOS, WINS  
LPR/LPD, Port9100, mDNS, FTP

\* Network Printing and PC-FAX are available for  
Mac OS® 8.6-9.2, Mac OS® 10.2.4 or greater.

\* Mac OS® 8.6-9.2 (Quick Draw over TCP/IP)

\* Mac OS® X 10.2.4 or greater (mDNS)

\* Network Scanning and Remote Setup are available for  
Mac OS® 10.2.4 or greater.

\* Media drive is not available for Mac OS® 8.6.

Included Utilities:

BRAdmin Professional (Windows®)



BRAdmin Professional is not supported in Mac OS®.

# Optional External Wireless Print/Scan Server (NC-2200w)

## **NC-2200w External Wireless Print/Scan Server (Optional)**

Connecting the optional External Wireless Print/Scan Server (NC-2200w) to your MFC will allow you to print and scan over a wireless network.

### **Network types**

IEEE 802.11b wireless LAN

### **Support for**

Windows® 98/98SE/Me/2000/XP  
Mac OS® X 10.2.4 or greater

### **Protocols**

TCP/IP  
ARP, RARP, BOOTP, DHCP, APIPA (Auto IP),  
WINS/NetBIOS, DNS, LPR/LPD, Port9100,  
SMB Print, IPP, RawPort, mDNS, TELNET,  
SNMP, HTTP



You can assign the scan key to one networked computer only.

# Index

## A

- Access codes, storing and dialling ..... 5-5
- Answering machine (TAD) ...A-5
  - connecting .....A-6
- Automatic
  - fax receive ..... 4-1
    - Fax Detect ..... 4-4
  - fax redial ..... 3-2
  - transmission ..... 3-3

## B

- Broadcasting ..... 3-10
  - setting up Groups for ..... 5-3

## C

- Cancelling
  - Fax Forwarding ..... 6-1
  - fax jobs in memory ..... 3-9
  - jobs awaiting redial ..... 3-9
- Cleaning
  - print head ..... 11-14
  - printer platen ..... 11-23
  - scanner ..... 11-22
- CNG tones ..... 1-17
- Connecting
  - external TAD .....A-5
  - external telephone .....A-4
- Consumable items .....S-9
- Control panel overview ..... 1-2
- Copy
  - brightness ..... 8-8
  - colour adjustment ..... 8-13
  - contrast ..... 8-12
  - default settings ..... 8-12
  - Enlarge/Reduce ..... 8-4
  - multiple ..... 8-2

- Page Layout .....8-9
  - paper size .....8-8
  - paper type .....8-7
  - quality setting ..... 8-5, 8-12
  - single copy .....8-2
  - temporary settings .....8-3
- Cordless phone ..... A-3
- Credit card numbers .....5-5
- Custom telephone features
  - on a single line .... 11-11, A-10

## D

- Date and Time .....2-1
- Delayed Batch
  - Transmission .....3-13
- Dialling
  - a pause .....5-5
  - access codes and
    - credit card numbers .....5-5
  - automatic fax redial .....3-2
  - automatic transmission ....3-3
  - Groups .....3-10
  - manual .....3-1
  - Speed-Dial .....3-2
- Dual Access .....3-7

## E

- ECM (Error Correction Mode) .....1-18
- Envelopes ..... 1-11
- Equalization .....11-13
- Error messages on LCD ....11-1
  - Comm. Error .....11-1
  - Ink Empty .....11-2
  - Near Empty .....11-2
  - No Paper Fed .....11-2
  - Not Registered .....3-2

Out of Memory ..... 11-3  
 Unable to Change ..... 11-4  
 Unable to Clean ..... 11-4  
 Unable to Init. .... 11-4  
 Unable to Print ..... 11-4  
 Unable to Scan ..... 11-4  
 Extension telephone,  
   using ..... A-2, A-8  
 External telephone,  
   connecting ..... A-4

## F

Fax codes  
   changing ..... 6-3, A-3  
   Fax Receive Code ..... A-2  
   Remote Access Code ..... 6-3  
   Telephone Answer Code ... A-2  
 Fax Detect ..... 4-4  
 Fax Forwarding  
   changing remotely .... 6-5, 6-6  
   programming a number ... 6-1  
 Fax Storage ..... 6-2  
   printing from memory ..... 4-5  
   turning on ..... 6-2  
 Fax, stand-alone  
   receiving ..... 4-1  
     compatibility ..... 11-13  
     difficulties ..... 11-8, 11-9  
   Fax Forwarding ..... 6-1, 6-5  
   from extension phone ... A-2  
   reducing to fit on paper ... 4-5  
   retrieving from a remote  
     site ..... 6-6  
   Ring Delay, setting ..... 4-2  
   sending ..... 3-1  
     automatic ..... 3-3  
     Broadcasting ..... 3-10  
     cancelling from memory ... 3-9  
     colour fax ..... 3-4  
     compatibility ..... 11-13

  contrast ..... 3-5  
   enter Fax mode ..... 3-1  
   from memory  
     (Dual Access) ..... 3-7  
   from scanner glass ..... 3-3  
   manual ..... 3-4  
   overseas ..... 3-11  
   Real Time Transmission ... 3-8  
   resolution ..... 3-6

Fax/Tel mode  
   answering at extension  
     phones ..... A-2  
   double-ringing  
     (voice calls) ..... 4-3  
   F/T Ring Time ..... 4-3  
   Fax Receive Code ..... A-2  
   receiving faxes ..... A-2  
   Ring Delay ..... 4-2  
   Telephone Answer Code ... A-2

## G

Gray scale ..... S-5, S-6  
 Groups for Broadcasting ..... 5-3

## H

HELP  
   LCD messages ..... B-1  
     using navigation keys .... B-2  
   Menu Table ..... B-1, B-3

## I

Ink cartridges  
   checking ink volume ..... 11-18  
   replacing ..... 11-24  
 Ink Dot Counter ..... 11-24

## L

LCD (liquid crystal display)  
   contrast ..... 2-7  
   Help List ..... 7-3

## M

Maintenance, routine .....	11-22
Manual	
dialling .....	3-1
receive .....	4-1
transmission .....	3-4
Memory Storage .....	B-1
Menu Selection Table .....	B-1
Mode, entering	
Copy .....	8-1
Fax .....	3-1
PhotoCapture Center™ .....	1-2
Scan .....	1-2
Multi-line connections (PBX) .....	A-10

## P

Paper .....	1-7, S-2
Size .....	2-5
Type .....	2-4
Phone line	
connections .....	A-6
difficulties .....	11-10
multi-line (PBX) .....	A-10
Type .....	2-3
PhotoCapture Center™	
Borderless .....	9-12
Colour enhancement .....	9-10
CompactFlash® .....	9-1
Cropping .....	9-12
Default setting .....	9-9
DPOF printing .....	9-8
Memory Stick® .....	9-1
Printing images .....	9-6
Printing Index .....	9-5
SecureDigital™ .....	9-1
SmartMedia® .....	9-1
specifications .....	S-4
xD-Picture Card™ .....	9-1

Power failure .....	B-1
Print	
area .....	1-11
difficulties .....	11-8, 11-9
drivers .....	S-7
fax from memory .....	4-5
improving quality .....	11-14
paper jams .....	11-5
report .....	7-3
resolution .....	S-7
specifications .....	S-7
Programming your MFC .....	B-1, B-2

## Q

Quick-Dial	
Access codes and credit card numbers setting up .....	5-5
Broadcasting .....	3-10
using Groups .....	3-10
Group dial	
changing .....	5-2
setting up Groups for Broadcasting .....	5-3
Search .....	3-2
Speed-Dial	
using .....	3-2

## R

Receive Mode .....	4-1
External TAD .....	4-1
Fax Only .....	4-1
Fax/Tel .....	4-1
Manual .....	4-1
Redial/Pause .....	3-2
Reducing	
copies .....	8-6
incoming faxes .....	4-5

Remote Retrieval .....	6-4
access code .....	6-3, 6-4
commands .....	6-5
getting your faxes .....	6-6
Reports .....	7-1
Fax Journal .....	7-2
Journal Period .....	7-2
Help List .....	7-3
how to print .....	7-3
Network Configuration .....	7-3
Quick-Dial List .....	7-3
Transmission Verification ...	7-1
User Settings .....	7-3
XMIT Verify .....	7-3
Resolution	
copy .....	S-3
fax (Standard, Fine, SuperFine, Photo) .....	S-5
print .....	S-7
scan .....	S-6
setting for next fax .....	3-6
Ring Delay, setting .....	4-2

## S

Safety Instructions .....	iii, 10-2
Setup	
Date and Time .....	2-1
Station ID (fax header) entering text .....	2-2
Shipping the machine .....	11-19
Speed-Dial	
changing .....	5-2
dialling .....	3-2
storing .....	5-1

## T

TAD (telephone answering device), external .....	4-1, A-5
connecting .....	A-5, A-6
receive mode .....	4-1
recording OGM .....	A-7
Text, entering .....	B-12
special characters .....	B-13
Troubleshooting .....	11-1
checking ink volume .....	11-18
error messages on LCD ...	11-1
if you are having difficulty	
Copying Difficulties ...	11-11
Handling Incoming Calls .....	11-11
Network Difficulties ...	11-12
phone line .....	11-13
Phone Line or Connection .....	11-10
PhotoCapture Center™ Difficulties .....	11-12
Printing .....	11-8, 11-9
Printing Received Faxes .....	11-9
Receiving Faxes .....	11-10
Scanning Difficulties ...	11-11
Sending Faxes .....	11-10
Software Difficulties ...	11-11
paper jam .....	11-5
print quality .....	11-14
TX Lock .....	3-15

## V

Volume, setting .....	2-5
beeper .....	2-6
ring .....	2-5
speaker .....	2-6

# Remote Retrieval Access card (MFC-410CN only)

If you plan to receive fax messages while away from your MFC, carrying the Remote Retrieval Access Card printed below will serve as a convenient reminder of the retrieval procedures. Simply cut out the card and fold it to fit your wallet or organizer. Keeping it handy will help you derive the full benefit of your MFC's Fax Forwarding, and Remote Retrieval features.

**REMOTE RETRIEVAL ACCESS CARD**

---

**Using Remote Access Code**

- 1** Dial your fax number from a telephone or fax machine using touch tone.
- 2** When your machine answers, immediately enter your Remote Access Code (3 digits followed by \*).
- 3** Your machine signals the kinds of messages it received:
  - 1 long beep — Fax messages**
  - No beeps — No messages.**
- 4** After 2 short beeps, enter a command.
- 5** Press **90** to reset your machine when you finish.
- 6** Hang up.

**1**

**REMOTE RETRIEVAL ACCESS CARD**

---

**CHECK RECEIVING STATUS**  
Press **971**  
1 long beep — Fax messages  
3 short beeps — No messages

**CHANGE RECEIVE MODE**  
Press **98**  
*then for* External TAD, press **1**.  
Fax/Tel, press **2**.  
Fax Only, press **3**.

**EXIT REMOTE OPERATION**  
Press **90**.

**4**

**REMOTE RETRIEVAL ACCESS CARD**

---

**Using Remote Access Code**

- 1** Dial your fax number from a telephone or fax machine using touch tone.
- 2** When your machine answers, immediately enter your Remote Access Code (3 digits followed by \*).
- 3** Your machine signals the kinds of messages it received:
  - 1 long beep — Fax messages**
  - No beeps — No messages.**
- 4** After 2 short beeps, enter a command.
- 5** Press **90** to reset your machine when you finish.
- 6** Hang up.

**1**



### Changing Remote Access Code

- 1 Press Menu/Set, 2, 5, 2.
- 2 Enter a three-digit number from 000 to 998.  
The \* cannot be changed.
- 3 Press Menu/Set.
- 4 Press Stop/Exit.

### Remote Commands

#### CHANGE FAX FORWARDING SETTING

Press 9 5.  
Turn feature OFF, press 1.  
then to Select Fax Forwarding, press 2

Fold

**Program Fax Forwarding Number**, press 4. Enter the new fax number where you want your fax messages forwarded followed by ##.

**Turn Fax Storage On**, press 6.

### RETRIEVE A FAX

Press 96

then to Retrieve all faxes, press 2.

then enter the number of remote fax machine followed by ##  
After the beep, hang up and wait.

Erase all fax messages, press 3.

Fold

At your side.  
**brother**®

**Visit us on the World Wide Web**  
**<http://www.brother.com>**

This machine is approved for use in the country of purchase only, local Brother companies or their dealers will only support machines purchased in their own countries.



UK/IRE/SAF/PAN NORDIC  
LF5820004