



PSCH-SR *Series*

User Guide

Motherboard

E1935

Revised edition V2

January 2005

Copyright © 2005 ASUSTeK COMPUTER INC. All Rights Reserved.

No part of this manual, including the products and software described in it, may be reproduced, transmitted, transcribed, stored in a retrieval system, or translated into any language in any form or by any means, except documentation kept by the purchaser for backup purposes, without the express written permission of ASUSTeK COMPUTER INC. ("ASUS").

Product warranty or service will not be extended if: (1) the product is repaired, modified or altered, unless such repair, modification or alteration is authorized in writing by ASUS; or (2) the serial number of the product is defaced or missing.

ASUS PROVIDES THIS MANUAL "AS IS" WITHOUT WARRANTY OF ANY KIND, EITHER EXPRESS OR IMPLIED, INCLUDING BUT NOT LIMITED TO THE IMPLIED WARRANTIES OR CONDITIONS OF MERCHANTABILITY OR FITNESS FOR A PARTICULAR PURPOSE. IN NO EVENT SHALL ASUS, ITS DIRECTORS, OFFICERS, EMPLOYEES OR AGENTS BE LIABLE FOR ANY INDIRECT, SPECIAL, INCIDENTAL, OR CONSEQUENTIAL DAMAGES (INCLUDING DAMAGES FOR LOSS OF PROFITS, LOSS OF BUSINESS, LOSS OF USE OR DATA, INTERRUPTION OF BUSINESS AND THE LIKE), EVEN IF ASUS HAS BEEN ADVISED OF THE POSSIBILITY OF SUCH DAMAGES ARISING FROM ANY DEFECT OR ERROR IN THIS MANUAL OR PRODUCT.

SPECIFICATIONS AND INFORMATION CONTAINED IN THIS MANUAL ARE FURNISHED FOR INFORMATIONAL USE ONLY, AND ARE SUBJECT TO CHANGE AT ANY TIME WITHOUT NOTICE, AND SHOULD NOT BE CONSTRUED AS A COMMITMENT BY ASUS. ASUS ASSUMES NO RESPONSIBILITY OR LIABILITY FOR ANY ERRORS OR INACCURACIES THAT MAY APPEAR IN THIS MANUAL, INCLUDING THE PRODUCTS AND SOFTWARE DESCRIBED IN IT.

Products and corporate names appearing in this manual may or may not be registered trademarks or copyrights of their respective companies, and are used only for identification or explanation and to the owners' benefit, without intent to infringe.

Contents

Notices	v
Safety information	vi
About this guide	vii
PSCH-SR specifications summary	ix

Chapter 1: Product introduction

1.1 Welcome!	1-1
1.2 Package contents	1-1
1.3 Special features	1-2

Chapter 2: Hardware information

2.1 Before you proceed	2-1
2.2 Motherboard installation	2-2
2.2.1 Placement direction	2-2
2.2.2 Screw holes	2-2
2.2.3 Motherboard layouts	2-3
2.2.4 Layout contents	2-6
2.3 Central Processing Unit (CPU)	2-7
2.3.1 Overview	2-7
2.3.2 Installing the CPU	2-7
2.3.3 Installing the optional CPU heatsink and thermal plate	2-9
2.4 System memory	2-11
2.4.1 Overview	2-11
2.4.2 Memory configurations	2-11
2.4.3 Installing a DIMM	2-13
2.4.4 Removing a DIMM	2-13
2.5 Expansion slots	2-14
2.5.1 Installing an expansion card	2-14
2.5.2 Configuring an expansion card	2-14
2.5.3 PCI slots	2-16
2.6 Jumpers	2-17
2.7 Connectors	2-22
2.7.1 Rear panel connectors	2-22
2.7.2 Internal connectors	2-23

Chapter 3: Powering up

3.1 Starting up for the first time	3-1
3.2 Powering off the computer	3-2
3.3.1 Using the OS shut down function	3-2
3.3.2 Using the dual function power switch	3-2

Contents

Chapter 4: BIOS setup

4.1	Managing and updating your BIOS	4-1
4.1.1	Creating a bootable floppy disk	4-1
4.1.2	Updating the BIOS	4-2
4.1.3	Saving the current BIOS file	4-4
4.2	BIOS Setup program	4-6
4.2.1	BIOS menu screen	4-7
4.2.2	Menu bar	4-7
4.2.3	Navigation keys	4-8
4.2.4	General help	4-8
4.2.5	Sub-menu	4-8
4.2.6	Scroll bar	4-8
4.2.7	Pop-up window	4-8
4.3	Main menu	4-9
4.3.1	Primary IDE Master	4-10
4.3.2	Primary IDE Slave	4-13
4.3.3	Secondary IDE Master	4-13
4.3.4	Secondary IDE Slave	4-13
4.4	Advanced menu	4-14
4.4.1	Advanced BIOS Features	4-15
4.4.2	CPU Configuration	4-16
4.4.3	Memory Configuration	4-17
4.4.4	Chipset	4-18
4.4.5	Onboard Device	4-20
4.4.6	PCIPnP	4-24
4.4.7	USB Configuration	4-26
4.5	Power menu	4-27
4.5.1	APM Configuration	4-27
4.5.2	Hardware Monitor	4-31
4.6	Boot menu	4-33
4.6.1	Boot Device Priority	4-33
4.6.2	Hard Disk Boot Priority	4-34
4.6.3	Removable Device Priority	4-34
4.6.4	CD-ROM Boot Priority	4-35
4.6.5	Boot Settings Configuration	4-35
4.6.6	Security	4-37
4.7	Exit menu	4-39

Appendix: Reference information

A.1	PSCH-SR block diagrams	A-1
-----	------------------------------	-----

Notices

Federal Communications Commission Statement

This device complies with Part 15 of the FCC Rules. Operation is subject to the following two conditions:

- This device may not cause harmful interference, and
- This device must accept any interference received including interference that may cause undesired operation.

This equipment has been tested and found to comply with the limits for a Class B digital device, pursuant to Part 15 of the FCC Rules. These limits are designed to provide reasonable protection against harmful interference in a residential installation. This equipment generates, uses and can radiate radio frequency energy and, if not installed and used in accordance with manufacturer's instructions, may cause harmful interference to radio communications. However, there is no guarantee that interference will not occur in a particular installation. If this equipment does cause harmful interference to radio or television reception, which can be determined by turning the equipment off and on, the user is encouraged to try to correct the interference by one or more of the following measures:

- Reorient or relocate the receiving antenna.
- Increase the separation between the equipment and receiver.
- Connect the equipment to an outlet on a circuit different from that to which the receiver is connected.
- Consult the dealer or an experienced radio/TV technician for help.



The use of shielded cables for connection of the monitor to the graphics card is required to assure compliance with FCC regulations. Changes or modifications to this unit not expressly approved by the party responsible for compliance could void the user's authority to operate this equipment.

Canadian Department of Communications Statement

This digital apparatus does not exceed the Class B limits for radio noise emissions from digital apparatus set out in the Radio Interference Regulations of the Canadian Department of Communications.

This class B digital apparatus complies with Canadian ICES-003.

Safety information

Electrical safety

- To prevent electrical shock hazard, disconnect the power cable from the electrical outlet before relocating the system.
- When adding or removing devices to or from the system, ensure that the power cables for the devices are unplugged before the signal cables are connected. If possible, disconnect all power cables from the existing system before you add a device.
- Before connecting or removing signal cables from the motherboard, ensure that all power cables are unplugged.
- Seek professional assistance before using an adapter or extension cord. These devices could interrupt the grounding circuit.
- Make sure that your power supply is set to the correct voltage in your area. If you are not sure about the voltage of the electrical outlet you are using, contact your local power company.
- If the power supply is broken, do not try to fix it by yourself. Contact a qualified service technician or your retailer.

Operation safety

- Before installing the motherboard and adding devices on it, carefully read all the manuals that came with the package.
- Before using the product, make sure all cables are correctly connected and the power cables are not damaged. If you detect any damage, contact your dealer immediately.
- To avoid short circuits, keep paper clips, screws, and staples away from connectors, slots, sockets and circuitry.
- Avoid dust, humidity, and temperature extremes. Do not place the product in any area where it may become wet.
- Place the product on a stable surface.
- If you encounter technical problems with the product, contact a qualified service technician or your retailer.

About this guide

This user guide contains the information you need when installing and configuring the motherboard.

How this guide is organized

This user guide contains the following parts:

- **Chapter 1: Product introduction**

This chapter describes the features of the motherboard. It includes brief descriptions of the special attributes of the motherboard and the new technology it supports.

- **Chapter 2: Hardware installation**

This chapter lists the hardware setup procedures that you have to perform when installing system components. It includes description of the switches, jumpers, and connectors on the motherboard.

- **Chapter 3: Powering up**

This chapter describes the power up sequence and gives information on the BIOS beep codes.

- **Chapter 4: BIOS setup**

This chapter tells how to change system settings through the BIOS Setup menus. Detailed descriptions of the BIOS parameters are also provided.

- **Appendix: Reference information**

This appendix includes additional information that you may refer to when configuring the motherboard.

Conventions used in this guide

To make sure that you perform certain tasks properly, take note of the following symbols used throughout this manual.



WARNING: Information to prevent injury to yourself when trying to complete a task.



CAUTION: Information to prevent damage to the components when trying to complete a task.



IMPORTANT: Information that you **MUST** follow to complete a task.



NOTE: Tips and additional information to aid in completing a task.

Where to find more information

Refer to the following sources for additional information and for product and software updates.

1. ASUS websites

The ASUS websites worldwide provide updated information on ASUS hardware and software products. Refer to the ASUS contact information.

2. Optional documentation

Your product package may include optional documentation, such as warranty flyers, that may have been added by your dealer. These documents are not part of the standard package.

PSCH-SR Series specifications summary

CPU	Socket 478 for Intel® Pentium™ 4 Prescott processors with Hyper-Threading Technology On-die 1MB/512KB L2 cache
Chipset	Northbridge: Intel® E7210 Memory Controller Hub (MCH) Southbridge: Intel® 6300ESB I/O Controller Hub (ICH)
Front Side Bus (FSB)	800/533/400 MHz
Memory	Dual-channel memory architecture 4 x 184-pin DDR DIMM sockets for up to 4 GB memory supports PC3200/PC2700/PC2100 unbuffered ECC or non-ECC DDR DIMMs
Expansion slots	1 x 3.3 V/64-bit/66 MHz PCI-X with Zero Channel RAID (ZCR) support 2 x 5 V/32-bit/33 MHz PCI
Storage	<p>IDE model Intel® 6300ESB I/O Controller Hub (ICH) supports:</p> <ul style="list-style-type: none"> - 2 x IDE connectors (dual-channel bus master IDE for up to four UltraATA100/66/33 hard disk drives - 2 x Serial ATA connectors (for RAID 0 and RAID 1 configurations using two SATA hard disk drives and Windows® XP) <p>Serial ATA model IDE model storage + Adaptec® AIC-8110X support:</p> <ul style="list-style-type: none"> - 4 x Serial ATA connectors (for RAID 0, RAID 1, RAID 0+1, and RAID 5 configurations using four SATA hard disk drives and the optional Adaptec® SODIMM Zero Channel RAID card) <p>SCSI model IDE model storage + Adaptec® AIC-7901X support:</p> <ul style="list-style-type: none"> - Single channel Ultra320 SCSI connector (for RAID 0, RAID 1, RAID 0+1, and RAID 5 configurations using SCSI hard disk drives and the optional Adaptec® SODIMM Zero Channel RAID card)
Graphics	ATI Rage™ XL PCI graphics controller with 8 MB VRAM
LAN	Intel® 82547GI CSA Gigabit LAN controller Intel® 82541GI Gigabit LAN controller (32-bit)
ASUS unique features	ASUS Q-Fan Technology ASUS Update

(continued on the next page)

PSCH-SR Series specifications summary

Rear panel ports	<ul style="list-style-type: none"> 1 x Serial (COM1) port 2 x LAN (RJ-45) ports 1 x PS/2 keyboard port 1 x PS/2 mouse port 2 x USB 2.0 ports 1 x VGA port
Internal connectors	<ul style="list-style-type: none"> CPU/system/chassis fan connectors 20-pin ATX and 4-pin ATX 12V power connectors 20-pin front panel connectors USB 2.0/1.1 connector Chassis intrusion connector Serial port (COM2) connector (for server management use only) Baseboard Management Connector (BMC) for server management card SODIMM slot for Adaptec® Zero Channel RAID card (optional on SCSI/SATA models only) 68-pin Ultra320 SCSI connector (SCSI models only) 4 x horizontal Serial ATA connectors (SATA models only)
BIOS features	Firmware Hub Flash ROM (4 Mb for IDE models; 8 Mb for SCSI and SATA models), Award BIOS with enhanced ACPI, PnP, DMI2.0, Green
Industry standard	PCI 2.2, PCI-X 1.0a, USB 2.0
Manageability	WfM 2.0, DMI 2.0, WOL/WOR by PME, chassis intrusion
Power requirement	ATX power supply (with 4-pin 12V plug)
Form Factor	ATX form factor: 12in x 9.8in (30.5 cm x 25 cm)
Support CD contents	<ul style="list-style-type: none"> Device drivers Management software System utilities ASUS contact information

**Specifications are subject to change without notice.*

Chapter 1

This chapter describes the features of the motherboard. It includes brief descriptions of the special attributes of the motherboard and the new technology it supports.

Product introduction

Chapter summary

1.1	Welcome!	1-1
1.2	Package contents	1-1
1.3	Special features	1-2

1.1 Welcome!

Thank you for buying the ASUS® PSCH-SR series motherboard!

The ASUS PSCH-SR series motherboard delivers a host of new features and latest technologies making it another standout in the long line of ASUS quality motherboards!

The motherboard incorporates the Intel® Pentium™ 4 processor in 478-pin package coupled with the Intel® E7210/6300ESB chipset to provide a powerful server/workstation platform solution.

Supporting 800 MHz FSB, up to 4 GB of system memory with dual-channel PC3200/2700/2100 DDR SDRAM, high-resolution graphics through an onboard VGA, Serial ATA support, dual Gigabit LAN, PCI-X, and USB 2.0 interfaces, PSCH-SR is your perfect vehicle to get ahead in the world of power computing!

Before you start installing the motherboard, and hardware devices on it, check the items in your package with the list below.

1.2 Package contents

Check your PSCH-SR package for the following items.

Item Description	PSCH-SR models		
	IDE	SATA	SCSI
ASUS PSCH-SR motherboard	✓	✓	✓
ASUS PSCH-SR support CD	✓	✓	✓
SATA cables	2	6	2
SATA power cables	1	3	1
SCSI cable	•	•	✓
4-in-1 IDE/FDD cable set	✓	✓	✓
I/O shield	✓	✓	✓
User guide	✓	✓	✓
Optional items: CPU heatsink and thermal plate Adaptec® Zero Channel RAID card			



Contact your retailer if any of the above items is damaged or missing.

1.3 Special features

1.3.1 Product highlights

Latest processor technology



The motherboard supports the latest Intel® Pentium™ 4 processor via a 478-pin surface mount ZIF socket. The processor with 1 MB/512 KB L2 cache includes a 800/533/400 MHz system bus and features the Intel Hyper-Threading Technology and new power design that allow up to 3.4+ GHz core frequencies. The motherboard fully supports the new generation 90 nm Pentium® 4 processor.

Dual-channel DDR400 memory support



Employing the dual-channel DDR memory architecture, the motherboard provides a solution that doubles the system memory bandwidth to boost system performance. The motherboard supports up to 4 GB of system memory using PC3200/2700/2100 ECC or non-ECC DDR DIMMs to deliver up to 6.4 GB/s data transfer rate for various server applications.

Serial ATA technology



The motherboard supports the new Serial ATA technology through the SATA interfaces and the Intel® 6300ESB. The SATA specification allows for thinner, more flexible cables with lower pin count, reduced voltage requirement, and up to 150 MB/s data transfer rate. For Serial ATA models, the Adaptec® AIC-8110X chip supports four additional SATA connectors to give you six fully-compatible SATA interfaces. For IDE models, the Intel® 6300ESB ICH provides RAID 0 and RAID 1 solution for two Serial ATA interfaces using the Windows® XP operating system.

Zero Channel RAID (ZCR) solution (*optional on SATA and SCSI models only*)

The motherboard supports the optional Zero Channel RAID card in SODIMM package for a multi-RAID solution using Serial ATA150 hard disk drives or Ultra320 SCSI hard disk drives. The RAID 0 (striping), RAID 1 (mirroring), RAID 0+1, and RAID 5 provide a cost-effective, reliable and high-performance server system.

Single-channel Ultra320 SCSI support (on SCSI models only)

The Adaptec® AIC-7901X Ultra320 SCSI controller and single-channel SCSI connector are onboard to provide high-speed data transfers to and from SCSI hard disk drives.

Integrated graphics

The onboard ATI Rage™ XL graphics controller with 8 MB memory provides a reliable solution for server applications.

USB 2.0 technology

The motherboard implements the Universal Serial Bus (USB) 2.0 specification, dramatically increasing the connection speed from the 12Mbps bandwidth on USB 1.1 to a fast 480 Mbps on USB 2.0. USB 2.0 is backward compatible with USB 1.1.

Dual Gigabit LAN solution

The Intel® 82541GI and Intel® 82547GI Gigabit Ethernet controller allows full-duplex Gigabit performance on LAN on Motherboard (LOM) applications. Take the advantage of the Communication Streaming Architecture (CSA) with the Intel® 82547GI controller that connects to the dedicated CSA bus on the Memory Controller Hub (MCH). This reduces the PCI bottlenecks by freeing the PCI bus for other I/O operations. The Intel® 82541GI controller utilizes the PCI interface on the Southbridge to provide a faster and more efficient networking performance.

Server management

With the onboard Baseboard Management Connector (BMC) for the ASUS server management card, managing your server motherboard has never been this easy. ASUS server management cards fully conform to the IPMI1.5 or 2.0 versions.

Chassis intrusion detection

The motherboard supports chassis intrusion monitoring through the Winbond ASIC. A chassis intrusion event is retained in the CMOS for added protection.

1.3.2 ASUS unique features

ASUS Q-Fan technology



The ASUS Q-Fan technology smartly adjusts the fan speeds according to the system loading to ensure quiet, cool, and efficient operation.

ASUS Update



This utility allows you to update the motherboard BIOS through a user-friendly interface. Connect to the Internet then to the ASUS FTP site nearest you to obtain the latest BIOS version for your motherboard.

Chapter 2

This chapter describes the hardware setup procedures that you have to perform when installing system components. It includes details on the switches, jumpers, and connectors on the motherboard.

Hardware information

Chapter summary

2.1	Before you proceed	2-1
2.2	Motherboard installation	2-2
2.3	Central Processing Unit (CPU)	2-7
2.4	System memory	2-11
2.5	Expansion slots	2-14
2.6	Jumpers	2-17
2.7	Connectors	2-22

2.1 Before you proceed

Take note of the following precautions before you install motherboard components or change any motherboard settings.



1. Unplug the power cord from the wall socket before touching any component.
2. Use a grounded wrist strap or touch a safely grounded object or to a metal object, such as the power supply case, before handling components to avoid damaging them due to static electricity.
3. Hold components by the edges to avoid touching the ICs on them.
4. Whenever you uninstall any component, place it on a grounded antistatic pad or in the bag that came with the component.
5. **Before you install or remove any component, ensure that the ATX power supply is switched off or the power cord is detached from the power supply.** Failure to do so may cause severe damage to the motherboard, peripherals, and/or components.

Power LED

The motherboard has a green power LED (**SB_PWR1**). When lit, this LED indicates that the system is ON, in sleep mode, or in soft-off mode, a reminder that you should shut down the system and unplug the power cable before removing or plugging in any motherboard component.

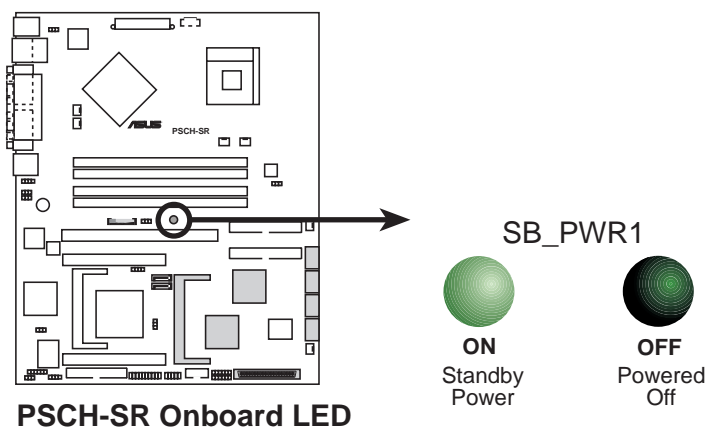

2.2 Motherboard installation

Before you install the motherboard, study the configuration of your chassis to ensure that the motherboard fits into it.



Make sure to unplug the power cord before installing or removing the motherboard. Failure to do so may cause you physical injury and damage motherboard components.

2.2.1 Placement direction

When installing the motherboard, make sure that you place it to the chassis in the correct orientation. The edge with external ports goes to the rear part of the chassis as indicated in the image below.

2.2.2 Screw holes

Secure the motherboard to the chassis with nine (9) screws on the holes indicated by the circles.



Do not overtighten the screws! Doing so may damage the motherboard.

Place this side towards
the rear of the chassis

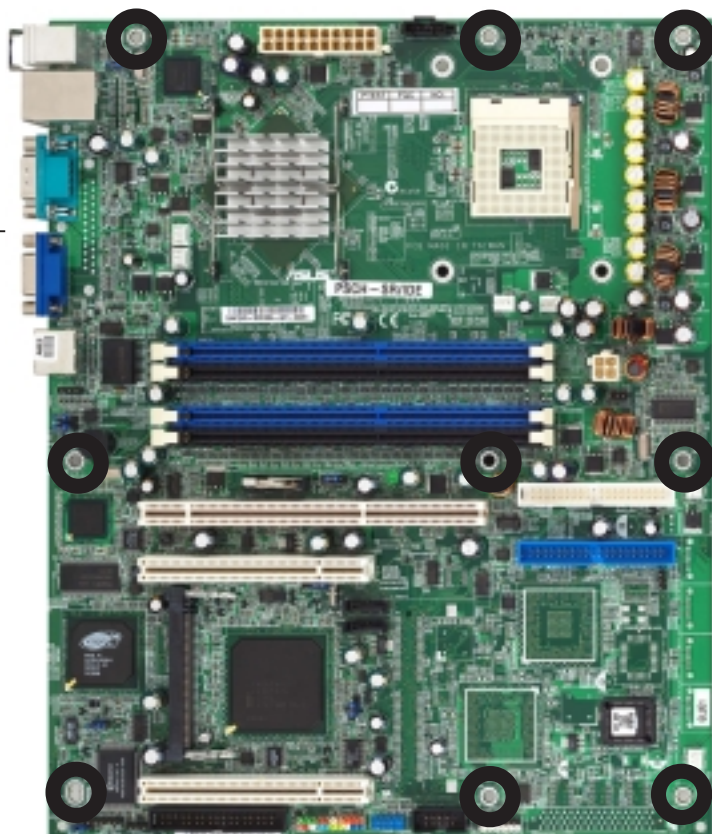

2.2.3 Motherboard layouts

IDE model

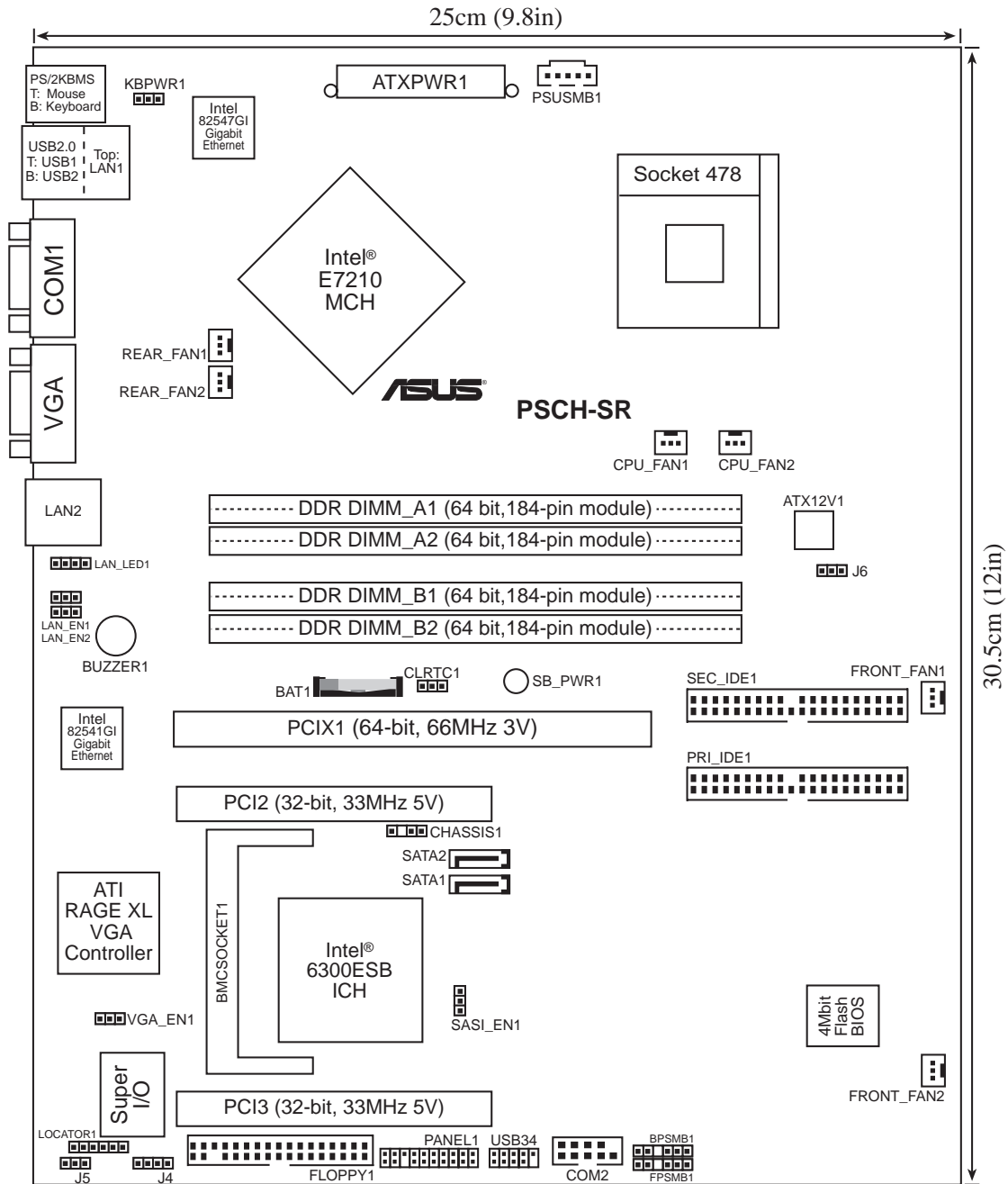

The BMC SOCKET1 slot is reserved for a server management card.

SATA model

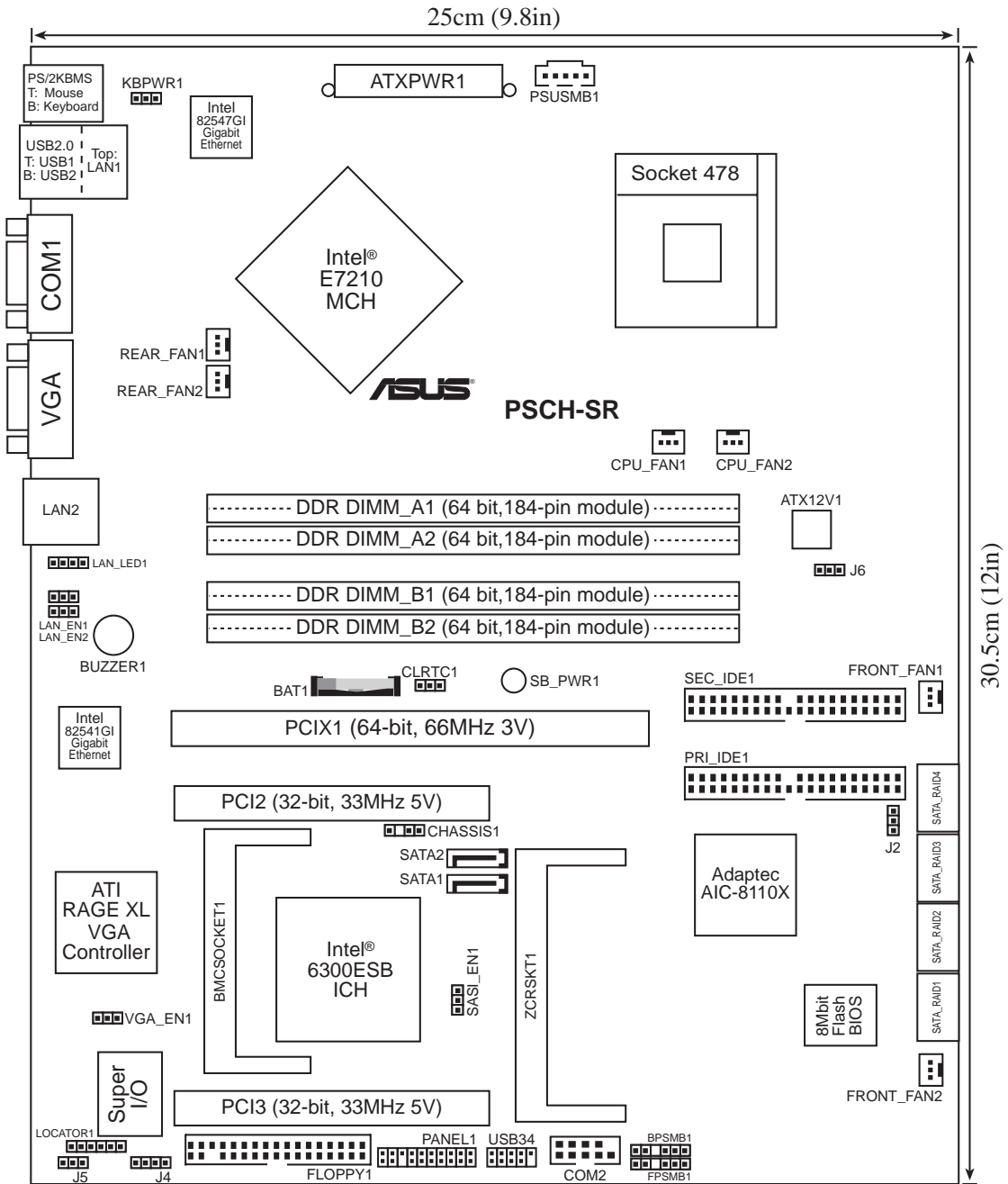

The BMC SOCKET1 slot is reserved for a server management card.

SCSI model

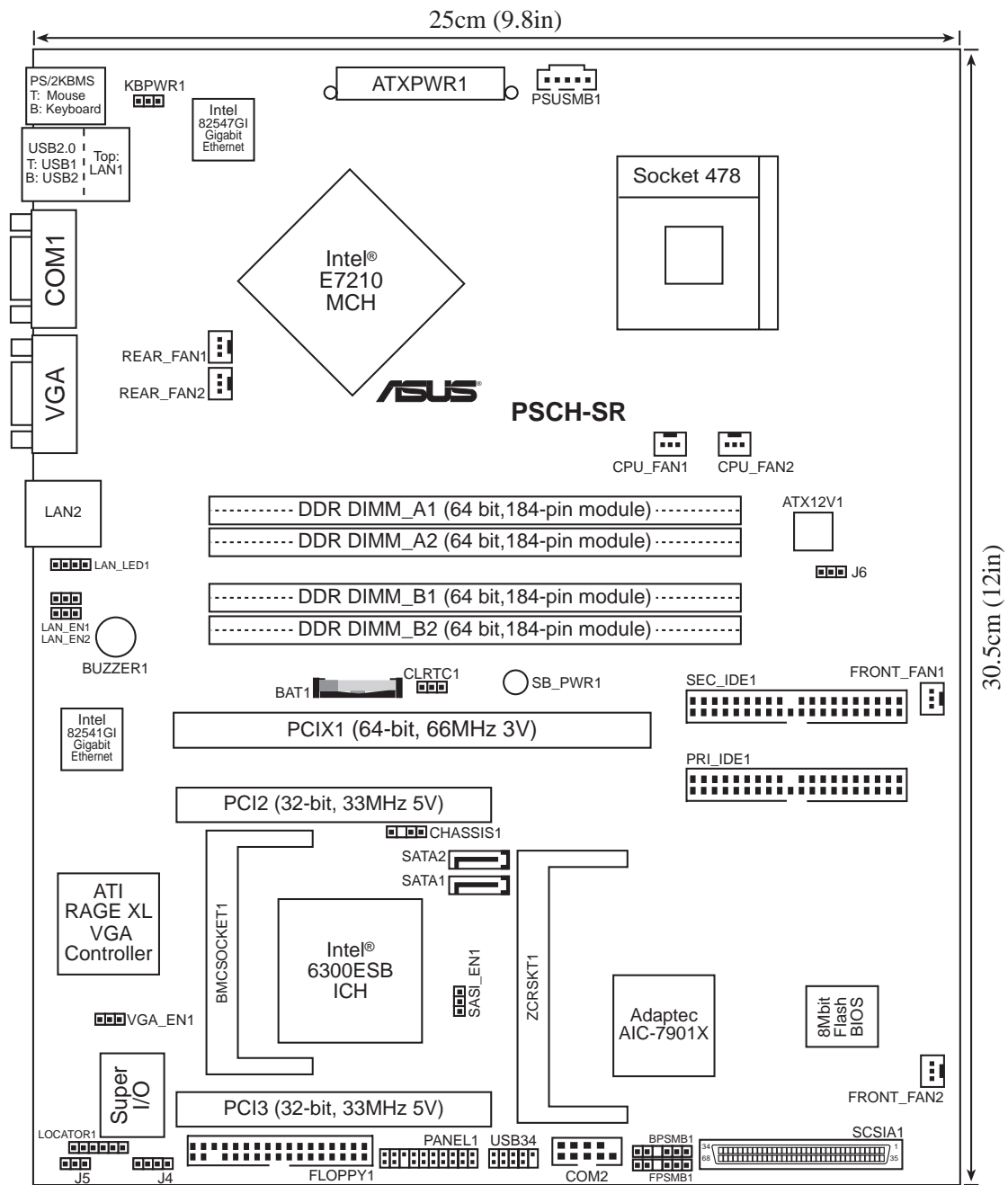

The BMC SOCKET1 slot is reserved for a server management card.

2.2.4 Layout contents

Slots	Page
1. DDR DIMM	2-11
2. PCI	2-16
Jumpers	
1. Keyboard power (3-pin KBPWR1)	2-17
2. Integrated LAN controllers (3-pin LAN_EN1; LAN_EN2)	2-17
3. Integrated graphics controller (3-pin VGA_EN1)	2-18
4. SATA/SCSI jumper controller (3-pin SASI_EN1)	2-18
5. Clear RTC RAM (3-pin CLRTC1)	2-19
6. Force BIOS recovery (3-pin J5)	2-20
7. Hard disk drive/SCSI LED switch (4-pin J4)	2-20
8. DDR voltage regulator (3-pin J6)	2-21
9. Serial ROM initialization jumper (3-pin J2)	2-21
Rear panel connectors	
1. PS/2 mouse port	2-22
2. LAN1 port	2-22
3. LAN2 port	2-22
4. VGA port	2-22
5. Serial port	2-22
6. USB 2.0 ports 1 and 2	2-22
7. PS/2 keyboard port	2-22
Internal connectors	
1. Power supply unit SMBus connector (5-pin PSUSMB1)	2-23
2. Front panel SMBus connector (6-1 pin FPSMB1 [white])	2-23
3. Backplane SMBus connector (6-1 pin BPSMB1 [black])	2-24
4. Chassis intrusion connector (4-1 pin CHASSIS1)	2-24
5. IDE connectors (40-1 pin PRI_IDE1 [blue], SEC_IDE1 [black])	2-25
6. Serial ATA connectors (7-pin SATA1, SATA2)	2-26
7. Serial ATA RAID connectors (7-pin SATA_RAID1, SATA_RAID2, SATA_RAID3, SATA_RAID4)	2-27
8. LAN LED connector (4-pin LAN_LED1)	2-27
9. ATX power connectors (20-pin ATXPWR1, 4-pin ATX12V1)	2-28
10. Floppy disk drive connector (34-1 pin FLOPPY1)	2-28
11. Ultra320 SCSI connector (68-pin SCSI1A1)	2-29
12. Locator connector (6-pin LOCATOR)	2-29
13. CPU, Front, and Rear Fan connectors (3-pin CPU_FAN1/2, FRONT_FAN1/2, REAR_FAN1/2)	2-30
14. Serial connector (10-1 pin COM2 for management use)	2-30
15. System panel connector (20-1 pin PANEL)	2-31

2.3 Central Processing Unit (CPU)

2.3.1 Overview

The motherboard comes with a surface mount 478-pin Zero Insertion Force (ZIF) socket. The socket is designed for the Intel® Pentium™ 4 processor in the 478-pin package with 1 MB/512 KB L2 cache.

Take note of the marked corner (with gold triangle) on the CPU. This mark should match a specific corner of the CPU socket.

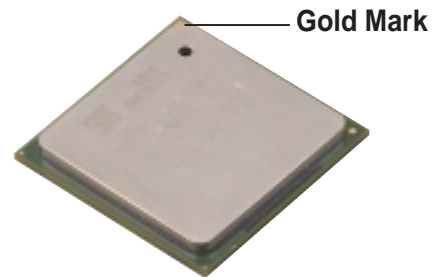

2.3.2 Installing the CPU

Follow these steps to install a CPU.

1. Locate the 478-pin ZIF socket on the motherboard.

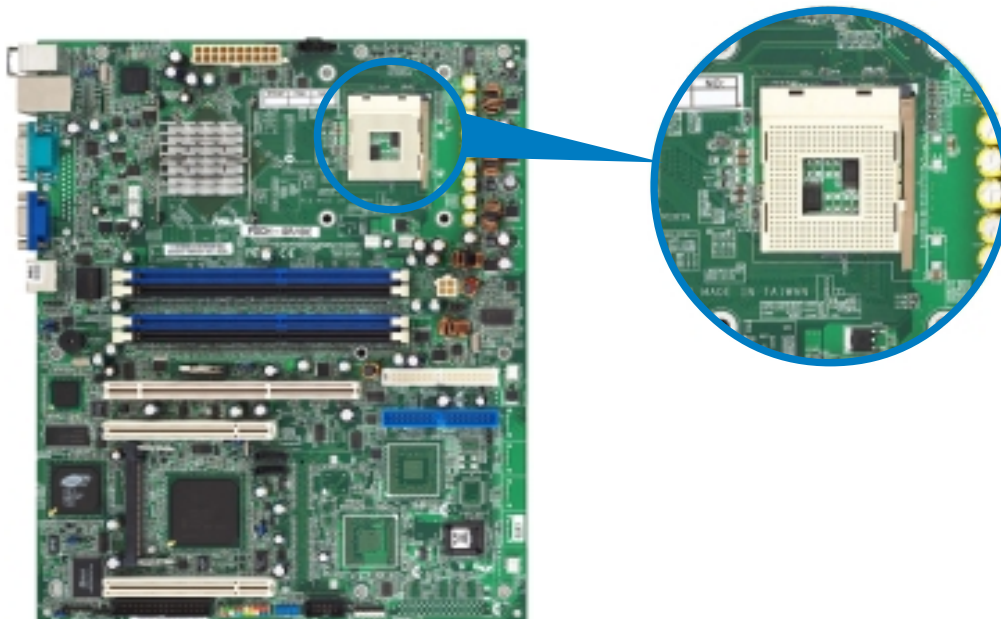

2. Unlock the socket by pressing the lever sideways, then lift it up to a 90°-100° angle.



Make sure that the socket lever is lifted up to 90°-100° angle; otherwise, the CPU does not fit in completely.

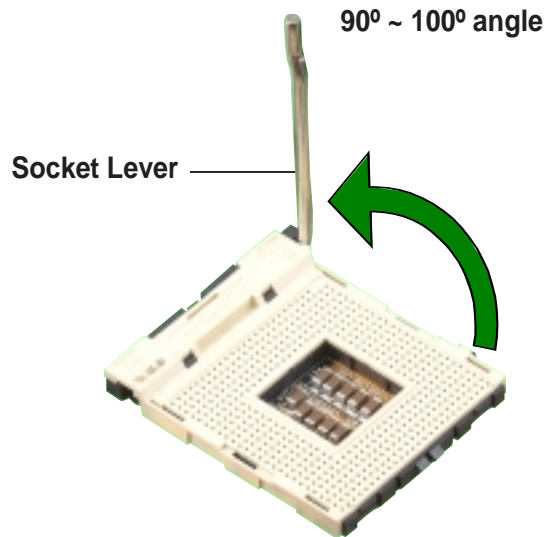

3. Position the CPU above the socket such that its marked corner matches the base of the socket lever.
4. Carefully insert the CPU into the socket until it fits in place.

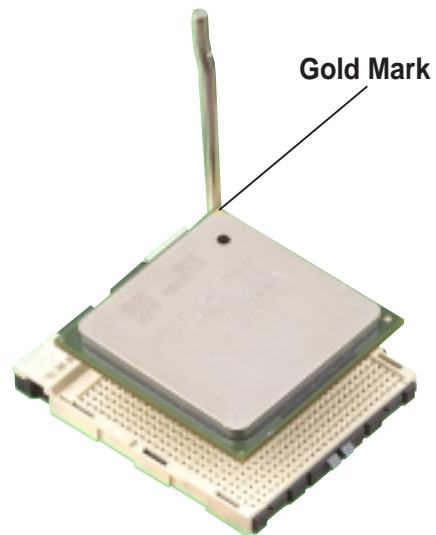

The CPU fits only in one correct orientation. DO NOT force the CPU into the socket to prevent bending the pins and damaging the CPU!

5. When the CPU is in place, push down the socket lever to secure the CPU. The lever clicks on the side tab to indicate that it is locked.

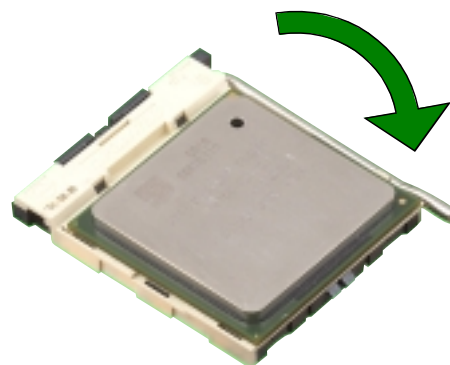

After installation, make sure to plug-in the 4-pin ATX power cable to the motherboard.

2.3.3 Installing the optional CPU heatsink and thermal plate



The passive CPU heatsink and a thermal plate is purchased separately. For optimum thermal solution, use the recommended CPU heatsink and thermal plate.

CPU thermal plate

This motherboard requires a thermal plate for the CPU. Place the thermal plate underneath the motherboard before you install the heatsink.

Refer to the picture below for the correct matching of the motherboard and thermal plate holes.

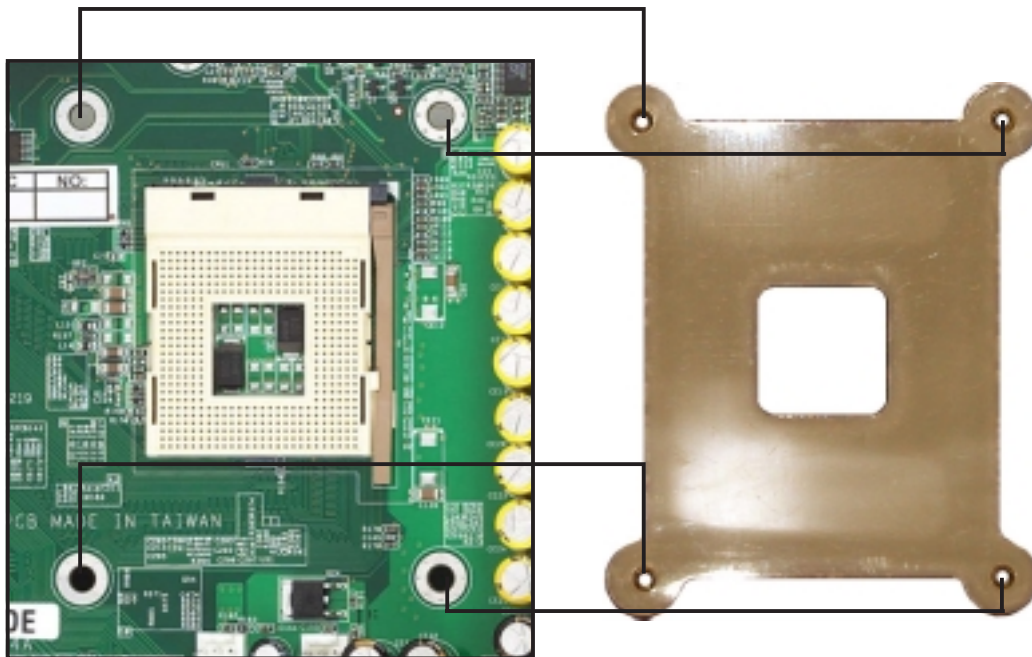

To install the CPU heatsink:

1. Carefully place the heatsink on top of the installed CPU.



2. Hold down the heatsink lightly and twist each of the four screws with a Philips (cross) screwdriver just enough to attach the heatsink to the motherboard.



3. When the four screws are attached, tighten them one by one to completely secure the heatsink.

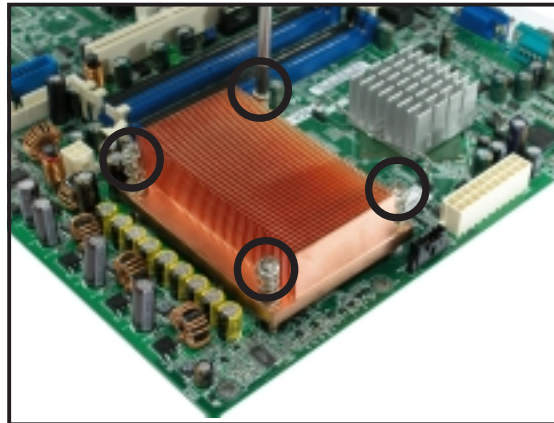

Do not overtighten the screws to avoid damaging the motherboard.

2.4 System memory

2.4.1 Overview

The motherboard comes with four Double Data Rate (DDR) Dual Inline Memory Module (DIMM) sockets.

The following figure illustrates the location of the sockets.

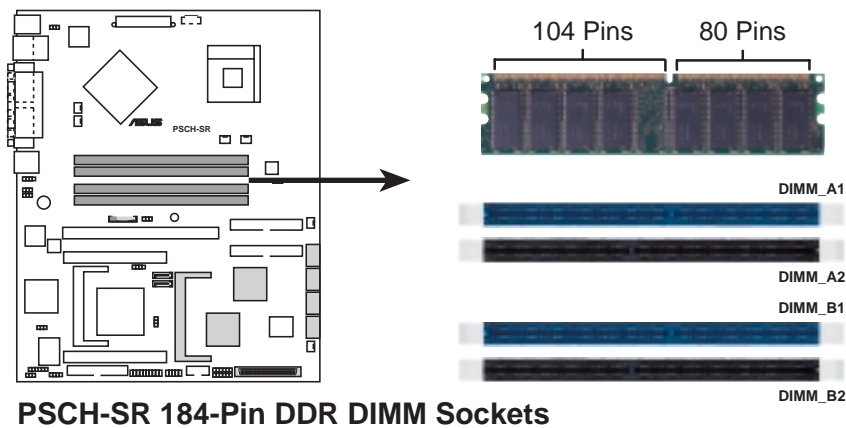

PSCH-SR 184-Pin DDR DIMM Sockets

2.4.2 Memory configurations

You may install 64 MB, 128 MB, 256 MB, 512 MB, and 1 GB DDR DIMMs into the DIMM sockets using the memory configurations in this section.

Important notes on memory configurations



- Installing DDR DIMMs other than the recommended configurations may cause memory sizing error or system boot failure. Use any of the recommended configurations in Table 1.
- Use the blue DIMM slots first.
- In Dual-channel configurations, install only identical (the same type and size) DDR DIMM pairs for each channel.
- Always install DIMMs with the same CAS latency, otherwise, the system may run in a lower frequency. For optimum compatibility, it is recommended that you obtain memory modules from the same vendor.
- When all four sockets are populated with 1 GB DIMMs (total 4 GB), the system may detect only 3583 MB due to the Southbridge resource allocation.
- Three DDR DIMMs installed into any three memory sockets will function in single channel mode.
- Make sure that the memory frequency matches the CPU FSB. Refer to Table 2 for configurations.

Table 1: Recommended memory configurations

Mode/DIMM Type		Sockets			
		DIMM_A1 (blue)	DIMM_A2 (black)	DIMM_B1 (blue)	DIMM_B2 (black)
Single-channel	(1)	Populated	—	—	—
(DDR400/DDR333/ DDR266)	(2)	—	Populated	—	—
	(3)	—	—	Populated	—
	(4)	—	—	—	Populated
Dual-channel	(1)	Populated	—	Populated	—
(DDR400/DDR333/ DDR266)	(2)	—	Populated	—	Populated
	(3)*	Populated	Populated	Populated	Populated

* For dual-channel configuration (3), you may:

- install identical DIMMs in all four sockets or
- install identical DIMM pair in DIMM_A1 and DIMM_B1 (blue sockets) and identical DIMM pair in DIMM_A2 and DIMM_B2 (black sockets)

Table 2: Memory frequency/CPU FSB synchronization

CPU FSB	DDR DIMM Type	Memory Frequency
800 MHz	PC3200/PC2700*/PC2100	400/333*/266 MHz
533 MHz	PC2700/PC2100	333/266 MHz
400 MHz	PC2100	266 MHz



*When using 800MHz CPU FSB, PC2700 DDR DIMMs may run only at 320MHz (not 333MHz) due to the Southbridge resource allocation.

2.4.3 Installing a DIMM



Make sure to unplug the power supply before adding or removing DIMMs or other system components. Failure to do so may cause severe damage to both the motherboard and the components.

Follow these steps to install a DIMM.

1. Unlock a DIMM socket by pressing the retaining clips outward.
2. Align a DIMM on the socket such that the notch on the DIMM matches the break on the socket.



A DDR DIMM is keyed with a notch so that it fits in only one direction. DO NOT force a DIMM into a socket to avoid damaging the DIMM.

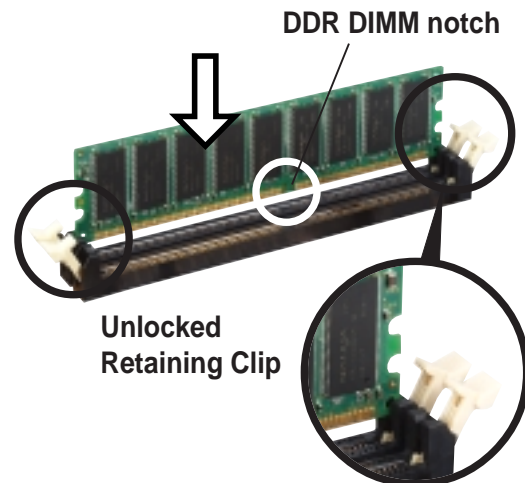

3. Firmly insert the DIMM into the socket until the retaining clips snap back in place and the DIMM is properly seated.

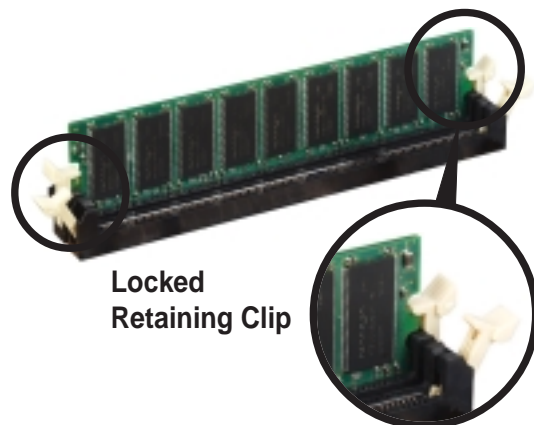

2.4.4 Removing a DIMM

Follow these steps to remove a DIMM.

1. Simultaneously press the retaining clips outward to unlock the DIMM.



Support the DIMM lightly with your fingers when pressing the retaining clips. The DIMM might get damaged when it flips out with extra force.

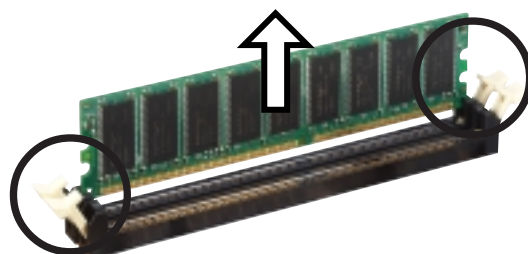

2. Remove the DIMM from the socket.

2.5 Expansion slots

In the future, you may need to install expansion cards. The motherboard has one 64-bit PCI-X slot and two 32-bit PCI slots. The following sub-sections describe the slots and the expansion cards that they support.



Make sure to unplug the power cord before adding or removing expansion cards. Failure to do so may cause you physical injury and damage motherboard components.

2.5.1 Installing an expansion card

Follow these steps to install an expansion card.

1. Before installing the expansion card, read the documentation that came with it and make the necessary hardware settings for the card.
2. Remove the system unit cover (if your motherboard is already installed in a chassis).
3. Remove the bracket opposite the slot that you intend to use. Keep the screw for later use.
4. Align the card connector with the slot and press firmly until the card is completely seated on the slot.
5. Secure the card to the chassis with the screw you removed earlier.
6. Replace the system cover.

2.5.2 Configuring an expansion card

After installing the expansion card, configure it by adjusting the software settings.

1. Turn on the system and change the necessary BIOS settings, if any. See Chapter 4 for information on BIOS setup.
2. Assign an IRQ to the card. Refer to the tables on the next page.
3. Install the software drivers for the expansion card.

Standard Interrupt Assignments

IRQ	Priority	Standard Function
0	1	System Timer
1	2	Keyboard Controller
2	N/A	Programmable Interrupt
3*	11	Communications Port (COM2)
4*	12	Communications Port (COM1)
5*	13	Sound Card (sometimes LPT2)
6	14	Floppy Disk Controller
7*	15	Printer Port (LPT1)
8	3	System CMOS/Real Time Clock
9*	4	ACPI Mode when used
10*	5	IRQ Holder for PCI Steering
11*	6	IRQ Holder for PCI Steering
12*	7	PS/2 Compatible Mouse Port
13	8	Numeric Data Processor
14*	9	Primary IDE Channel
15*	10	Secondary IDE Channel

* These IRQs are usually available for ISA or PCI devices.

IRQ assignments for this motherboard

	A	B	C	D	E	F	G	H	PXIRQ0	PXIRQ1	PXIRQ2	PXIRQ3
PCIX 1	—	—	—	—	—	—	—	—	shared	shared	shared	shared
PCI slot 2	—	—	—	—	shared	shared	shared	shared	—	—	—	—
PCI slot 3	—	—	—	—	shared	shared	shared	shared	—	—	—	—
Onboard Gigabit LAN	—	—	used	—	—	—	—	—	—	—	—	—
Onboard VGA controller	—	—	—	—	—	—	—	shared	—	—	—	—
BMC mini-PCI slot	—	—	—	—	shared	—	—	—	—	—	—	—
Zero Channel RAID slot*	—	—	—	—	—	—	—	—	—	—	shared	—
SODIMM RAID controller*	—	—	—	—	—	—	—	—	—	—	—	shared

* On SATA and SCSI models only.



When using PCI cards on shared slots, ensure that the drivers support “Share IRQ” or that the cards do not need IRQ assignments. Otherwise, conflicts will arise between the two PCI groups, making the system unstable and the card inoperable.

2.5.3 PCI slots

The PCI slots support PCI cards such as a LAN card, SCSI card, USB card, and other cards that comply with PCI specifications.

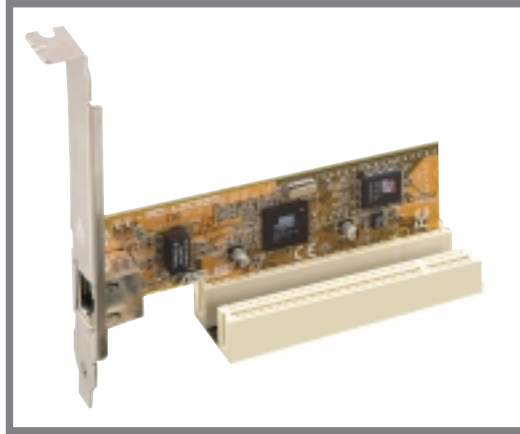

When installing long PCI cards, it is recommended that you install them in the PCIX1 and PCI3 slots. Long PCI cards installed in the PCI2 slot may interfere with the SATA connectors.

2.6 Jumpers

1. Keyboard power (3-pin KBPWR1)

This jumper allows you to enable or disable the keyboard wake-up feature. Set this jumper to pins 2-3 (+5VSB) if you wish to wake up the computer when you press a key on the keyboard. This feature requires an ATX power supply that can supply at least 1A on the +5VSB lead, and a corresponding setting in the BIOS. Refer to Chapter 4 for more information.

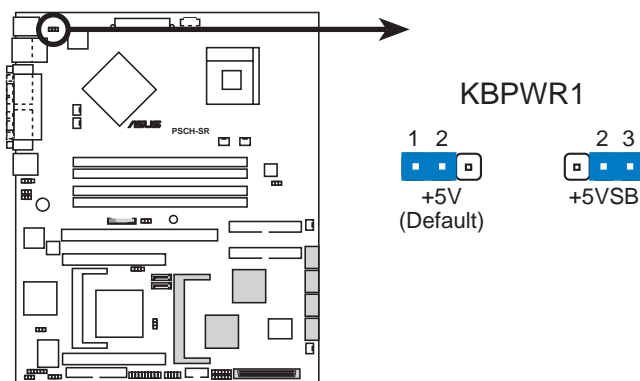

PSCH-SR Keyboard Power Setting

2. Integrated LAN controllers (3-pin LAN_EN1; LAN_EN2)

This jumper allows you enable or disable the onboard LAN controllers. The LAN_EN1 jumper is for the LAN1 port controlled by the Intel® 82547GI LAN controller while the LAN_EN2 jumper is for the LAN2 port controlled by the Intel® 82541GI LAN controller.

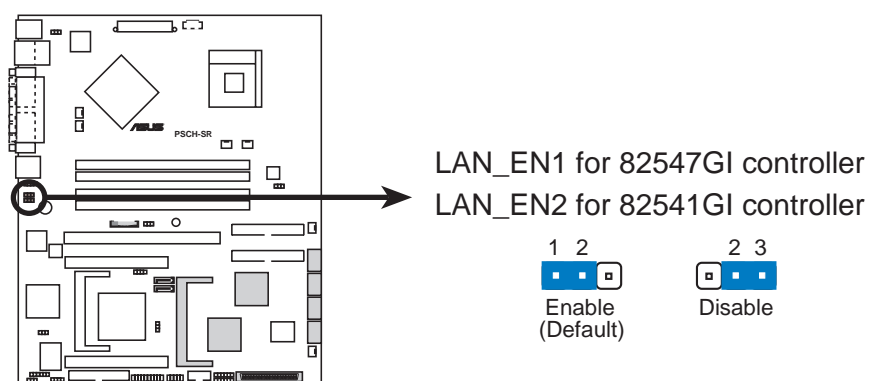

PSCH-SR LAN Controller Jumper

3. Integrated graphics controller (3-pin VGA_EN1)

This jumper allows you enable or disable the onboard graphics controller.

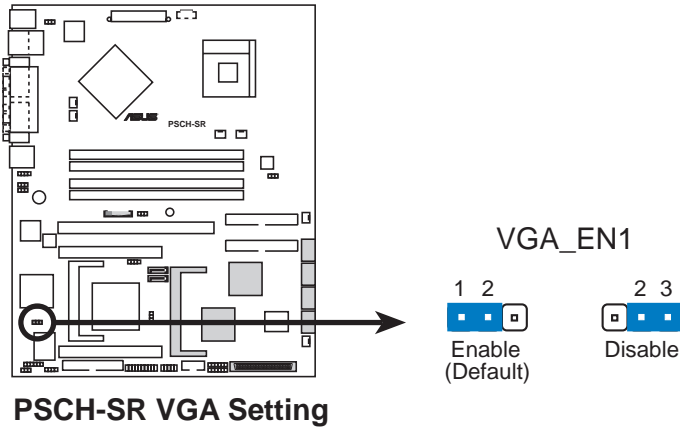

4. SATA/SCSI controller jumper (3-pin SASI_EN1)

This jumper allows you enable or disable the SATA controller (on SATA models) or the SCSI controller (on SCSI models).

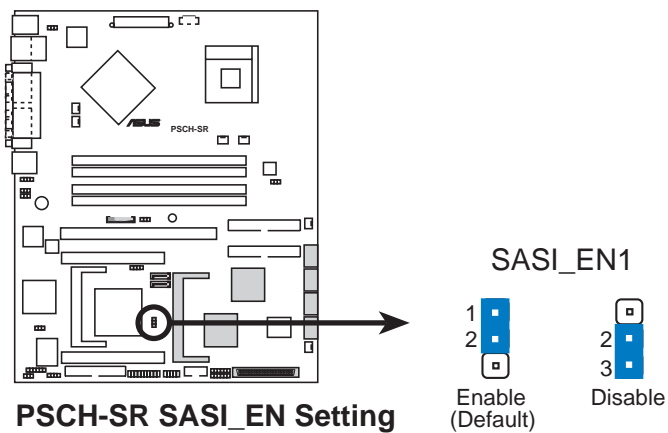

5. Clear RTC RAM (3-pin CLRTC1)

This jumper allows you to clear the Real Time Clock (RTC) RAM in CMOS. The RAM data in CMOS, that include system setup information such as system date, time, and system setup parameters, and passwords, is powered by the onboard button cell battery.

To erase the RTC RAM:

1. Turn OFF the computer and unplug the power cord.
2. Remove the onboard battery.
3. Move the jumper cap from pins 1-2 (default) to pins 2-3. Keep the cap on pins 2-3 for about 5~10 seconds, then move the cap back to pins 1-2.
4. Re-install the battery.
5. Plug the power cord and turn ON the computer.
6. Hold down the key during the boot process and enter BIOS setup to re-enter data.

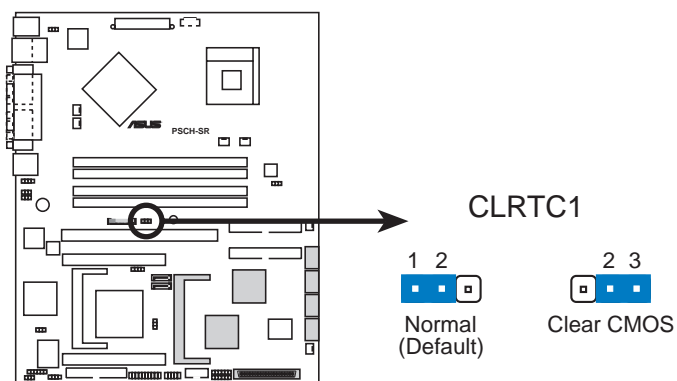

PSCH-SR Clear RTC RAM



Except when clearing the RTC RAM, never remove the cap on CLRTC jumper default position. Removing the cap will cause system boot failure!

6. Force BIOS recovery (3-pin J5)

This jumper allows you to update or recover the BIOS settings when it gets corrupted or destroyed.

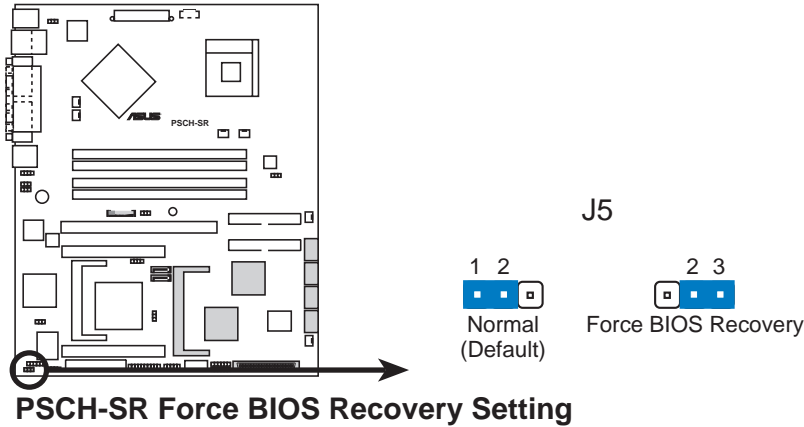

This jumper allows you to update/recover the BIOS quickly.

To update the BIOS:

1. Prepare a floppy disk that contains the latest BIOS for the motherboard (xxxx-xxx.BIN) and the AWDFLASH.EXE utility.
2. Set the jumper to pins 2-3.
3. Insert the floppy disk, then turn on the system to update the BIOS.
4. Shut down the system.
5. Set the jumper back to pins 1-2.
6. Turn on the system.

7. Hard disk drive/SCSI LED switch (4-pin J4)

This jumper allows you to enable or disable the front panel hard disk drive or SCSI LED. The HD/SCSI LED is enabled when no jumper cap is placed over the pins.

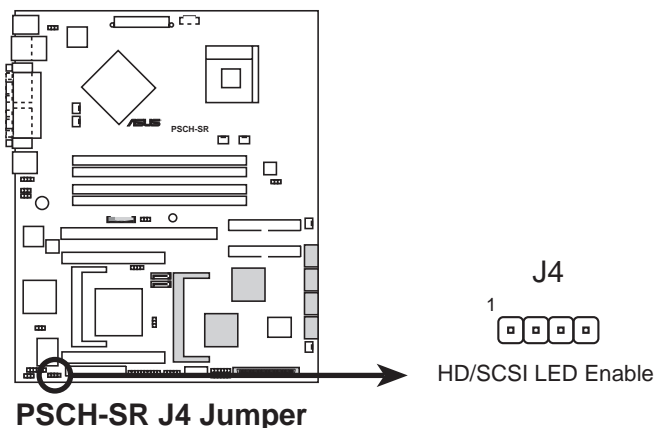

8. DDR voltage regulator (3-pin J6)

This jumper allows you adjust the DDR voltage to +5% or -5%. The DDR voltage is at its normal level when no jumper cap is placed over the pins.

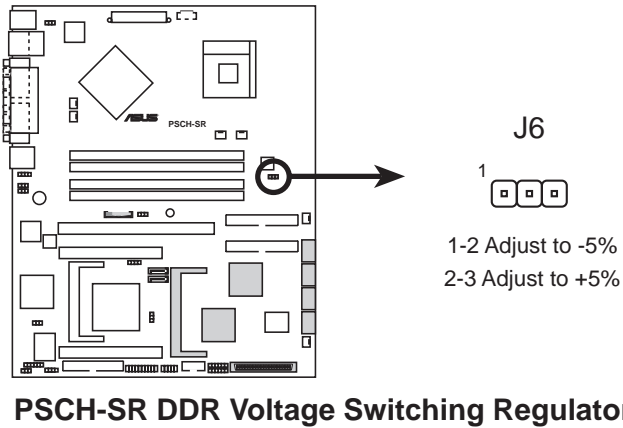

Observe caution when adjusting the DDR voltage.

9. Serial ROM initialization jumper (3-pin J2) *SATA models only.*

This jumper allows you to enable or disable the serial ROM for Serial ATA devices.

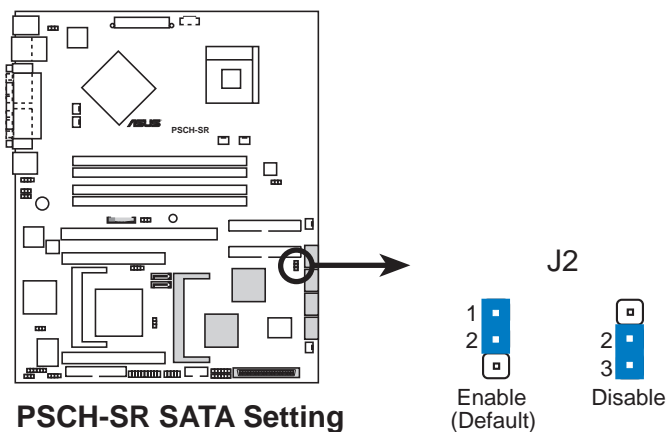

2.7 Connectors

2.7.1 Rear panel connectors

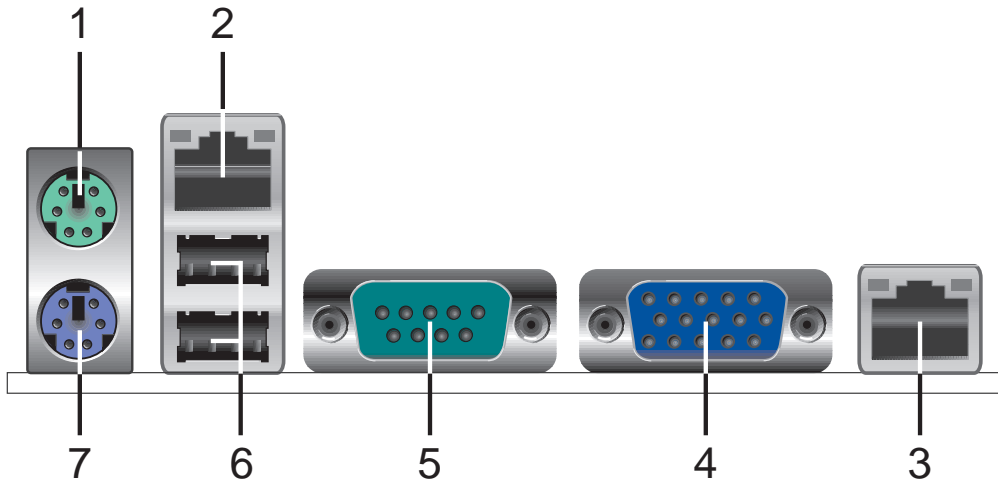

1. **PS/2 mouse port.** This green 6-pin connector is for a PS/2 mouse.
2. **LAN1 port.** This port allows Gigabit connection to a Local Area Network (LAN) through a network hub. This port is controlled by the Intel® 82547GI LAN controller. Refer to the table below for the LAN port LED indications.
3. **RJ-45 port.** This port allows Gigabit connection to a Local Area Network (LAN) through a network hub. This port is controlled by the Intel® 82541GI LAN controller. Refer to the table below for the RJ-45 port LED indications. Refer to the table below for the LAN port LED indications.

RJ45		ACT/LINK LED		SPEED LED	
		Status	Description	Status	Description
ACT/LNK		OFF	No link	OFF	10Mbps connection
		GREEN	Linked	ORANGE	100Mbps connection
		BLINKING	Acting	GREEN	1Gbps connection

4. **VGA port.** This port connects a VGA display device.
5. **Serial port.** This 9-pin COM1 port is for pointing devices or other serial devices.
6. **USB 2.0 ports 1 and 2.** These 4-pin Universal Serial Bus (USB) ports are available for connecting USB 2.0 devices.
7. **PS/2 keyboard port.** This purple connector is for a PS/2 keyboard.

2.7.2 Internal connectors

1. Power supply unit SMBus connector (5-pin PSUSMB1)

This connector allows you to connect SMBus (System Management Bus) devices to the power supply unit. Devices communicate with an SMBus host and/or other SMBus devices using the SMBus interface.

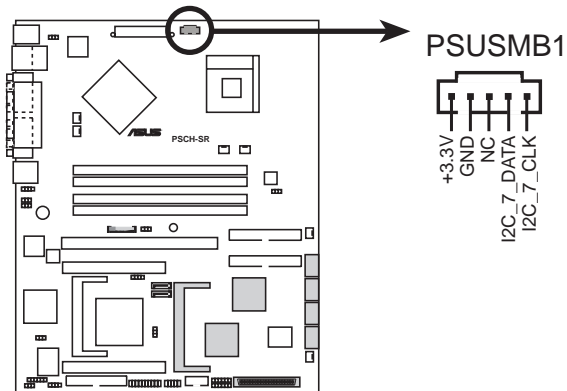

PSCH-SR Power Supply SMBus Header



Not all power supply units have SMBus connector for server management.

2. Front panel SMBus connector (6-1 pin FPSMB1 [white])

This connector allows you to connect SMBus (System Management Bus) devices to system front panel components. Devices communicate with an SMBus host and/or other SMBus devices using the SMBus interface.

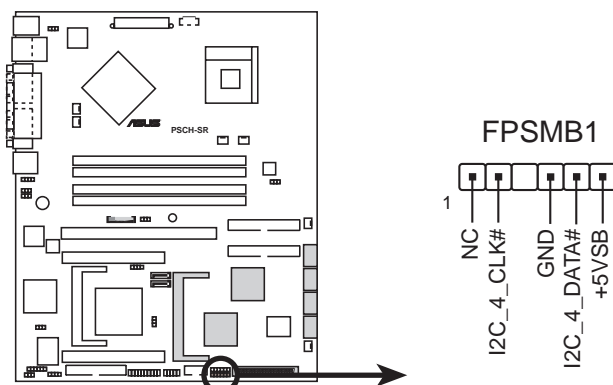

PSCH-SR Front Panel SMBus Connector

3. Backplane SMBus connector (6-1 pin BPSMB1 [black])

This connector allows you to connect SMBus (System Management Bus) devices to system backplane components such as SATA or SCSI backplanes. Devices communicate with an SMBus host and/or other SMBus devices using the SMBus interface.

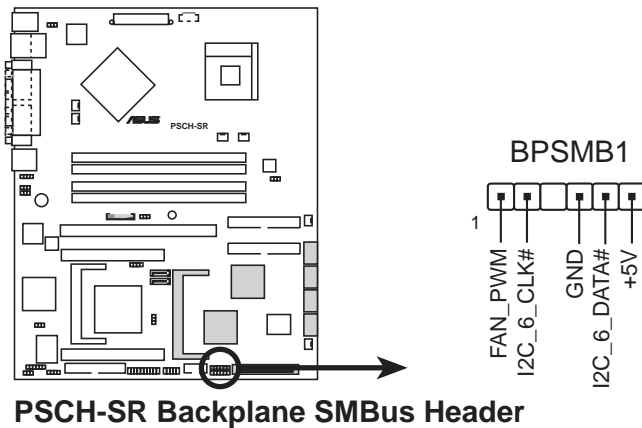

4. Chassis intrusion connector (4-1 pin CHASSIS1)

This lead is for a chassis designed with intrusion detection feature. This requires an external detection mechanism such as a chassis intrusion sensor or microswitch. When you remove any chassis component, the sensor triggers and sends a high-level signal to this lead to record a chassis intrusion event.

By default, the pins labeled “Chassis Signal” and “Ground” are shorted with a jumper cap. If you wish to use the chassis intrusion detection feature, remove the jumper cap from the pins.

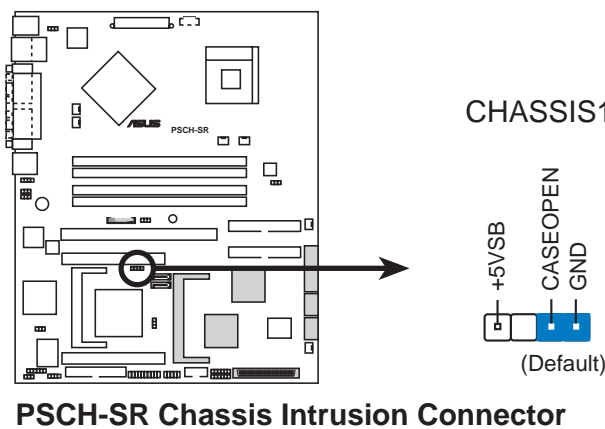

5. IDE connectors (40-1 pin PRI_IDE1 [blue], SEC_IDE1 [black])

This connector supports the provided UltraATA100 IDE hard disk ribbon cable. Connect the cable's blue connector to the primary (recommended) or secondary IDE connector, then connect the gray connector to the UltraATA100 slave device and the black connector to the UltraATA100 master device. It is recommended that you connect non-UltraATA100 devices to the secondary IDE connector. If you install two hard disks, you must configure the second drive as a slave device by setting its jumper accordingly. Refer to the hard disk documentation for the jumper settings. BIOS supports specific device bootup. You may configure two hard disks to be both master devices with two ribbon cables – one for the primary IDE connector and another for the secondary IDE connector.



- Pin 20 on each IDE connector is removed to match the covered hole on the UltraATA cable connector. This prevents incorrect orientation when you connect the cables.
- The hole near the blue connector on the UltraATA100 cable is intentional.
- For UltraATA IDE devices, use the 80-conductor IDE cable.

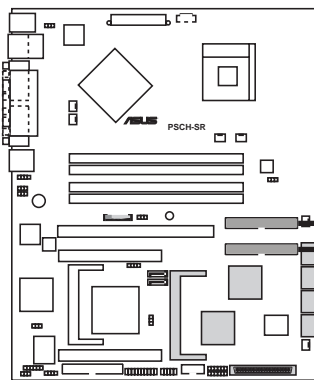

PSCH-SR IDE Connectors

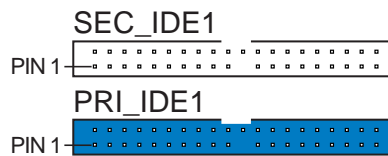

NOTE: Orient the red markings (usually zigzag) on the IDE ribbon cable to PIN 1.

6. Serial ATA connectors (7-pin SATA1, SATA2)

These next generation connectors support the thin Serial ATA cables for Serial ATA hard disks. The current Serial ATA interface allows up to 150MB/s data transfer rate, faster than the standard parallel ATA with 133MB/s (Ultra ATA/133).

If you installed Serial ATA hard disk drives and Windows® XP operating system, you can create a RAID 0 or RAID 1 configuration using the Adaptec HostRAID technology embedded in the Intel® 6300ESB.

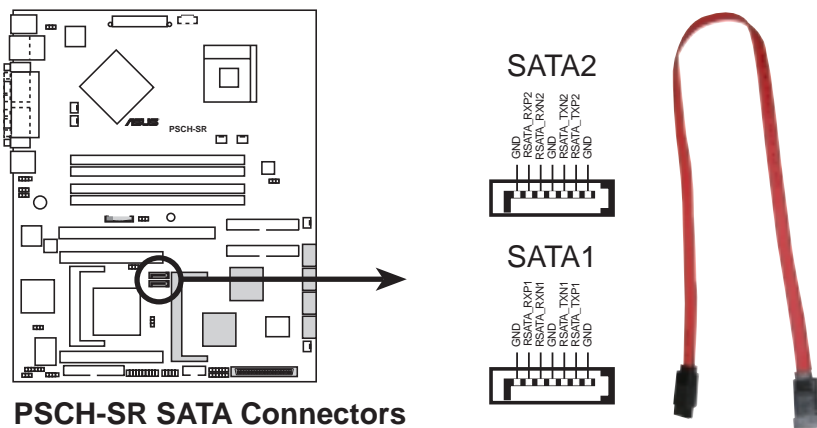

Important notes on Serial ATA

- In a legacy operating system (DOS) environment, using the Serial ATA connectors will disable the Southbridge support to one of the IDE channels (either primary or secondary channel).
- The Serial ATA RAID feature (RAID 0 and RAID 1) is only available under Windows® XP.

7. Serial ATA RAID connectors (7-pin SATA_RAID1, SATA_RAID2, SATA_RAID3, SATA_RAID4)



The Serial ATA RAID connectors are available on SATA models only.

These Serial ATA connectors support SATA hard disks that you can configure as a RAID set. Through the onboard Adaptec® AIC-8110X RAID controller, you may create a RAID0, RAID1, RAID0+1, or multi-RAID configuration.

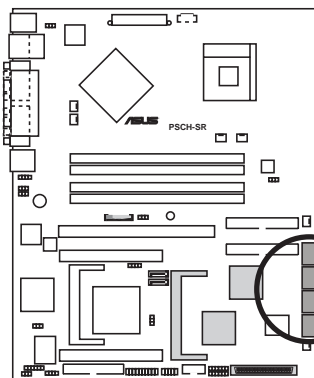

PSCH-SR SATA RAID Connectors

SATA_RAID4
SATA_RAID3
SATA_RAID2
SATA_RAID1

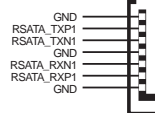

- If you wish to create a RAID set, make sure that you have connected the SATA cable and installed Serial ATA hard disk drives. You cannot enter the SATAraid™ utility and SATA BIOS setup during POST if there are no connected Serial ATA HDDs.
- The Adaptec® AIC-8110X RAID controller does not support ATAPI devices such as CD-ROMs, DVD-ROMs, etc.

8. LAN LED connector (4-pin LAN_LED1)

This connector is for the LAN activity LEDs in the system front panel.

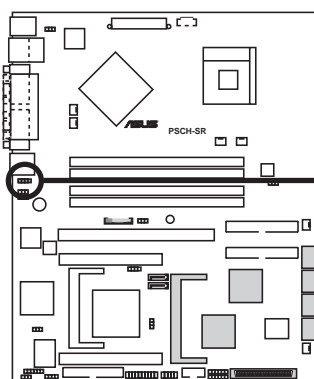

PSCH-SR LANLED Connector

LAN_LED1



9. ATX power connectors (20-pin ATXPWR1, 4-pin ATX12V1)

These connectors connect to an ATX 12 V power supply. The plugs from the power supply are designed to fit these connectors in only one orientation. Find the proper orientation and push down firmly until the connectors completely fit.

In addition to the 20-pin ATXPWR1 connector, connect the 4-pin ATX +12V power plug to provide sufficient power to the CPU.



1. Do not forget to connect the 4-pin ATX +12V power plug. Otherwise, the system does not boot up.
2. Make sure that your ATX 12 V power supply can provide 8A on the +12V lead and at least 1A on the +5-volt standby lead (+5VSB). The minimum recommended wattage is 300W. The system may become unstable or may not boot up if the power is inadequate.

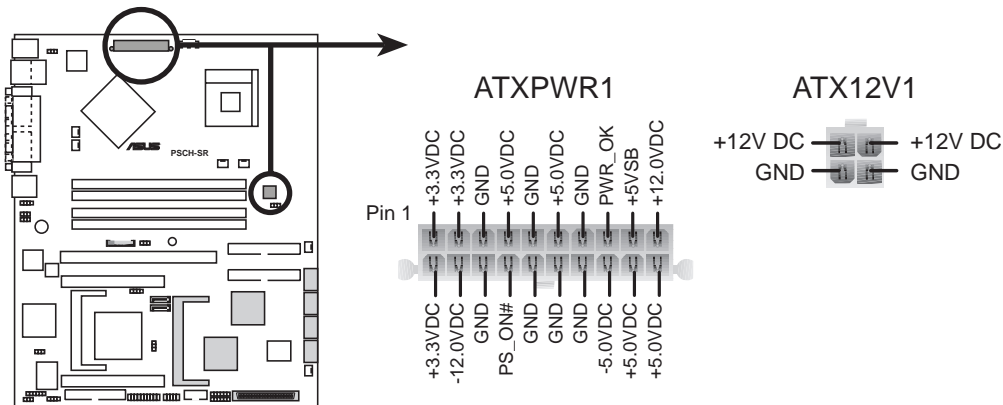

PSCH-SR ATX Power Connectors

10. Floppy disk drive connector (34-1 pin FLOPPY1)

This connector supports the provided floppy drive ribbon cable. After connecting one end to the motherboard, connect the other end to the floppy disk drive. (Pin 5 is removed to prevent incorrect insertion when using FDD cables with a closed pin 5 hole).

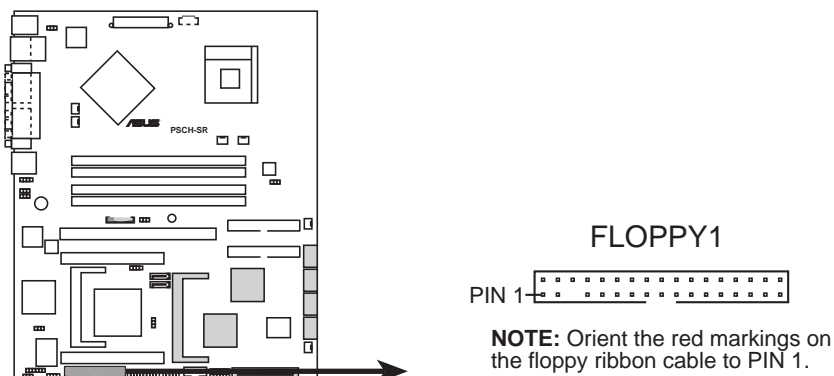

PSCH-SR Floppy Disk Drive Connector

11. Ultra320 SCSI connector (68-pin SCSIA1)



The Ultra320 SCSI connector is available on SCSI models only.

This single channel Ultra320 SCSI connector supports SCSI hard disk drives that you may configure as a RAID set through the onboard Adaptec® 7901 SCSI controller. The channel can support a maximum of 15 devices as specified by Ultra320 SCSI standards.

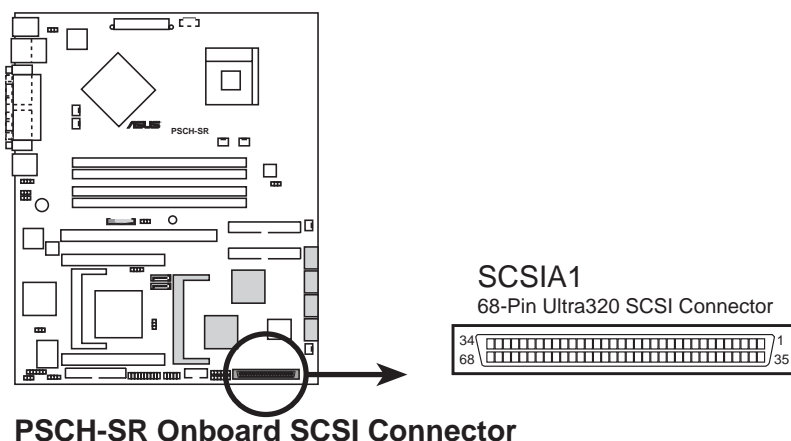

PSCH-SR Onboard SCSI Connector



If you wish to create a SCSI RAID set, make sure that you have connected the SCSI cable and installed SCSI devices.

12. Locator connector (6-pin LOCATOR)

This connector controls the locator LEDs in the system front or rear panel. By default, this connector comes without a jumper.

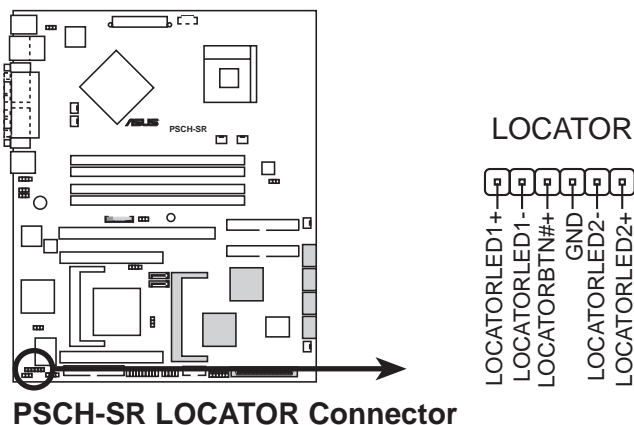

PSCH-SR LOCATOR Connector

13. CPU, Front, and Rear fan connectors (3-pin CPU_FAN1/2, FRONT_FAN1/2, REAR_FAN1/2)

The fan connectors on this motherboard support various server configurations. Use the rear fan connectors if you intend to install the motherboard in a tower/pedestal chassis. Use the front fan connectors when using a rackmount configuration.

The fan connectors support cooling fans of 350 mA ~ 740 mA (8.88 W max.) or a total of 1 A ~ 2.22 A (26.64 W max.) at +12 V. Connect the fan cables to the fan connectors on the motherboard, making sure that the black wire of each cable matches the ground pin of the connector.

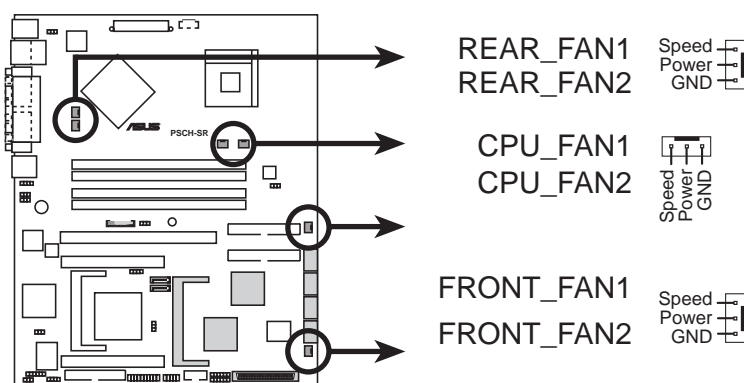

PSCH-SR Fan Connectors



Do not forget to connect the fan cables to the fan connectors. Lack of sufficient air flow within the system may damage the motherboard components. These are not jumpers! **DO NOT** place jumper caps on the fan connectors!

14. Serial connector (10-1 pin COM2 for management use)

This connector accommodates a server management card using the serial interface.

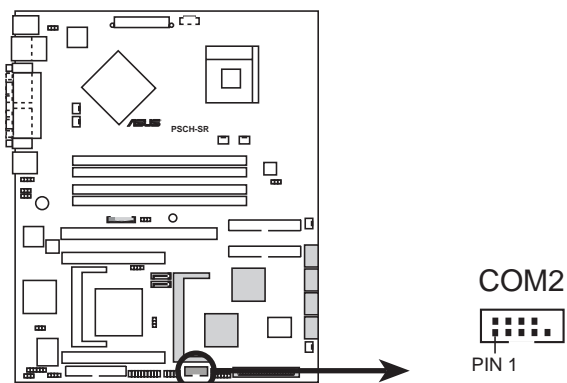

PSCH-SR Serial COM2 Bracket



Since this connector is dedicated for server management, you must use a null modem cable to make the connector operational.

15. System panel connector (20-1 pin PANEL)

This connector accommodates several system front panel functions.

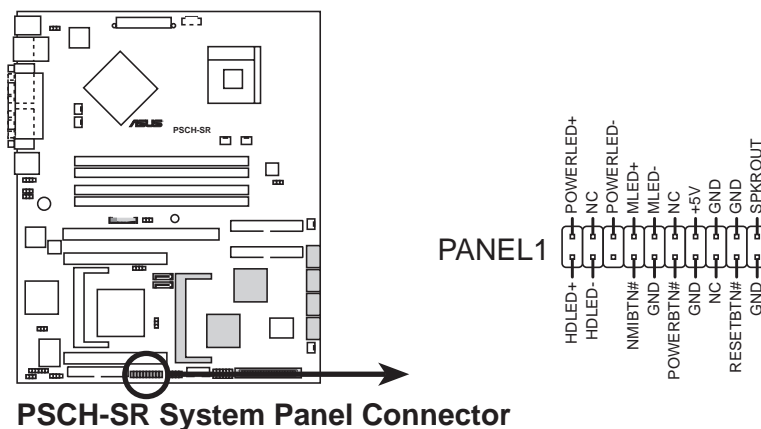

- **System Power LED (3-pin PLED)**

This connector is for the system power LED. The LED lights up when you turn on the system power, and blinks when the system is in sleep mode.

- **Message LED (2-pin MLED)**

This connector is for the front panel message LED that indicates the booting status. The LED blinks when the system is in the boot process until the operating system is loaded.

- **System Warning Speaker (4-pin SPKR)**

This connector is for the case-mounted speaker and allows you to hear system beeps and warnings.

- **Hard Disk Activity (2-pin HD_LED)**

This connects to the hard disk drive LED. The read or write activities of the hard disk drive connected to the any of IDE connectors cause the hard disk drive LED to light up.

- **ATX Power Switch/Soft-Off Switch (2-pin PWR_SW)**

This connector is for the system power switch. Pressing the power switch turns the system between ON and SLEEP, or ON and SOFT OFF, depending on the BIOS or OS settings. Pressing the power switch for more than 4 seconds when the system is on turns the system off.

- **Reset Switch (2-pin RESET)**

This connector is for the case-mounted reset switch for rebooting the system without turning off the system power.

Chapter 3

This chapter describes the power up sequence and gives information on the BIOS beep codes.

Powering up

Chapter summary

- 3.1 Starting up for the first time 3-1**
- 3.2 Powering off the computer 3-2**

3.1 Starting up for the first time

1. After making all the connections, replace the system case cover.
2. Be sure that all switches are off.
3. Connect the power cord to the power connector at the back of the system chassis.
4. Connect the power cord to a power outlet that is equipped with a surge protector.
5. Turn on the devices in the following order:
 - a. Monitor
 - b. External SCSI devices (starting with the last device on the chain)*
 - c. System power

* *SCSI models only*
6. After applying power, the power LED on the system front panel case lights up. For ATX power supplies, the system LED lights up when you press the ATX power switch. If your monitor complies with “green” standards or if it has a “power standby” feature, the monitor LED may light up or switch between orange and green after the system LED turns on. The system then runs the power-on tests. While the tests are running, the BIOS beeps (see BIOS beep codes table below) or additional messages appear on the screen. If you do not see anything within 30 seconds from the time you turned on the power, the system may have failed a power-on test. Check the jumper settings and connections or call your retailer for assistance.

Award BIOS beep codes

Beep	Meaning
One short beep when displaying logo	No error during POST
Long beeps in an endless loop	No DRAM installed or detected
One long beep followed by three short beeps	Video card not found or video card memory bad
High frequency beeps when system is working	CPU overheated; System running at a lower frequency

7. At power on, hold down <Delete> to enter BIOS Setup. Follow the instructions in Chapter 4.

3.2 Powering off the computer

3.2.1 Using the OS shut down function

If you are using Windows® 2000 Professional or Windows® 2000 Server:

1. Click the **Start** button then click **Shut Down...**
2. Make sure that the **Shut down** option button is selected, then click the **OK** button to shut down the computer.
3. The power supply should turn off after Windows® shuts down.

If you are using Windows® XP or Windows® Server 2003:

1. Click the **Start** button then select **Turn Off Computer.**
2. Click the **Turn Off** button to shut down the computer.
3. The power supply should turn off after Windows® shuts down.

3.2.2 Using the dual function power switch

While the system is ON, pressing the power switch for less than 4 seconds puts the system to sleep mode or to soft-off mode, depending on the BIOS setting. Pressing the power switch for more than 4 seconds lets the system enter the soft-off mode regardless of the BIOS setting. See section “4.5 Power Menu” in Chapter 4.

Chapter 4

This chapter tells how to change system settings through the BIOS Setup Menus. Detailed descriptions of the BIOS parameters are also provided.

BIOS information

Chapter summary

4.1	Managing and updating your BIOS	4-1
4.2	BIOS Setup program	4-6
4.3	Main menu	4-9
4.4	Advanced menu	4-14
4.5	Power menu	4-27
4.6	Boot menu	4-33
4.7	Exit menu	4-39

4.1 Managing and updating your BIOS



-
- The **original BIOS file** for this motherboard is in the support CD.
 - Copy the original BIOS to a **bootable floppy disk** in case you need to restore the BIOS in the future.
-

4.1.1 Creating a bootable floppy disk

1. Do either one of the following to create a bootable floppy disk.

DOS environment

Insert a 1.44 MB floppy disk into the drive. At the DOS prompt, type: **format a: /s**, then press the <Enter> key.

Windows® XP environment

- a. Insert a new 1.44 MB floppy disk in the floppy disk drive.
 - b. From the Windows desktop, click **Start > My Computer**.
 - c. In the **My Computer** window, click the **3 1/2 Floppy** icon.
 - d. From the Menu bar, click **File > Format**.
 - e. Select “**Create an MS-DOS Startup Disk**” in the **Format Options** field, then click **Start**.
2. Copy the original (or the latest) motherboard BIOS to the bootable floppy disk.

4.1.2 Updating the BIOS

The Basic Input/Output System (BIOS) can be updated using the AwardBIOS Flash Utility. Follow these instructions to update the BIOS using this utility.

1. Download the latest BIOS file from the ASUS web site. Rename the file to ***.BIN** and save it to a floppy disk.



Save only the updated BIOS file in the floppy disk to avoid loading the wrong BIOS file.

2. Copy the AwardBIOS Flash Utility (awdf flash.exe) from the Software folder of the support CD to the floppy disk with the latest BIOS file.
3. Boot the system in DOS mode using the bootable floppy disk you created earlier.
4. When the **A:>** appears, replace the bootable floppy disk with the floppy disk containing the new BIOS file and the Award BIOS Flash Utility.
5. At the prompt, type **awdf flash** then press <Enter>. The Award BIOS Flash Utility screen appears.

```
AwardBIOS Flash Utility for ASUS V1.01
(C) Phoenix Technologies Ltd. All Rights Reserved

For Canterwood - PSCHSR-IDE      DATE: 05/16/2004
Flash Type - SST 49LF004A/B /3.3V

File Name to Program : 

Message: Please input File Name!
```

6. Type the BIOS file name in the **File Name to Program** field, then press <Enter>.

```
AwardBIOS Flash Utility for ASUS V1.01
(C) Phoenix Technologies Ltd. All Rights Reserved

For Canterwood - PSCHSR-IDE      DATE: 05/16/2004
Flash Type - SST 49LF004A/B /3.3V

File Name to Program : 1001.bin

Message: Do You Want To Save BIOS (Y/N)
```

7. The utility prompts you to save the current BIOS file. Press <Y> to save the current BIOS file to the floppy disk, or <N> to continue.



If you intend to save the current BIOS file, make sure that the floppy disk has enough disk space to save the file. See the next section for details on saving the current BIOS file.

8. The utility verifies the BIOS file in the floppy disk and starts flashing the BIOS file.

```
AwardBIOS Flash Utility for ASUS V1.01
(C) Phoenix Technologies Ltd. All Rights Reserved

For Canterwood - PSCHSR-IDE      DATE: 05/16/2004
Flash Type - SST 49LF004A/B /3.3V

File Name to Program : 1001.bin

Program Flashing Memory - 0FE00 OK

[Progress bar with grid pattern]

Write OK      No Update      Write Fail

Warning: Don't Turn Off Power Or Reset System!
```



Do not turn off or reset the system during the flashing process!

- The utility displays a **Flashing Complete** message indicating that you have successfully flashed the BIOS file. Press <F1> to restart the system.

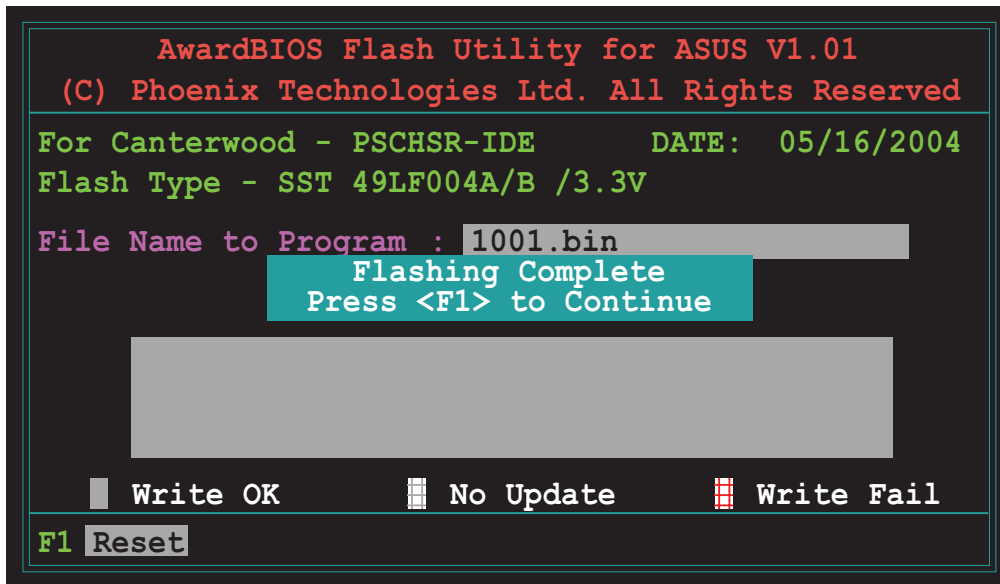

4.1.3 Saving the current BIOS file

You can use the AwardBIOS Flash Utility to save the current BIOS file. You can load the current BIOS file when the BIOS file gets corrupted during the flashing process.

To save the current BIOS file using the AwardBIOS Flash Utility:

- Follow steps 1 to 6 of the previous section.
- Press <Y> when the utility prompts you to save the current BIOS file. The following screen appears.

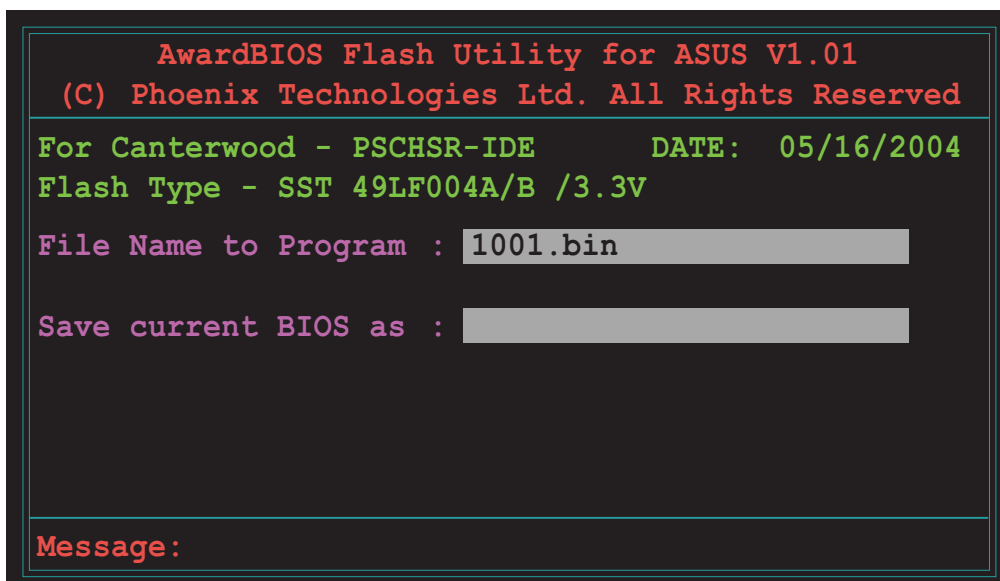

3. Type a filename for the current BIOS file in the **Save current BIOS as** field, then press <Enter>.

```
AwardBIOS Flash Utility for ASUS V1.01
(C) Phoenix Technologies Ltd. All Rights Reserved

For Canterwood - PSCHSR-IDE      DATE: 05/16/2004
Flash Type - SST 49LF004A/B /3.3V

File Name to Program : 1001.bin
Checksum : DAD6H
Save current BIOS as : old.bin

Message: Please Wait!
```

4. The utility saves the current BIOS file to the floppy disk, then returns to the BIOS flashing process.

```
AwardBIOS Flash Utility for ASUS V1.01
(C) Phoenix Technologies Ltd. All Rights Reserved

For Canterwood - PSCHSR-IDE      DATE: 05/16/2004
Flash Type - SST 49LF004A/B /3.3V

File Name to Program : 1001.bin
Now Backup System BIOS to
File!

Message: Please Wait!
```

4.2 BIOS Setup program

This motherboard includes a Flash ROM that you can update using the provided utility described in section “4.1 Managing and updating your BIOS.”

Use the BIOS Setup program when you are installing a motherboard, reconfiguring your system, or prompted to “Run Setup”. This section explains how to configure your system using this utility.

Even if you are not prompted to use the Setup program, you may want to change the configuration of your computer in the future. For example, you may want to enable the security password feature or make changes to the power management settings. This requires you to reconfigure your system using the BIOS Setup program so that the computer can recognize these changes and record them in the CMOS RAM of the Flash ROM.

The Flash ROM on the motherboard stores the Setup utility. When you start up the computer, the system provides you with the opportunity to run this program. Press <Delete> during the Power-On Self Test (POST) to enter the Setup utility, otherwise, POST continues with its test routines.

If you wish to enter Setup after POST, restart the system by pressing <Ctrl> + <Alt> + <Delete>, or by pressing the reset button on the system chassis. You can also restart by turning the system off and then back on. Do this last option only if the first two failed.

The Setup program is designed to make it as easy to use as possible. It is a menu-driven program, which means you can scroll through the various sub-menus and make your selections among the predetermined choices.



Because the BIOS software is constantly being updated, the following BIOS setup screens and descriptions are for reference purposes only, and may not exactly match what you see on your screen.

4.2.1 BIOS menu screen

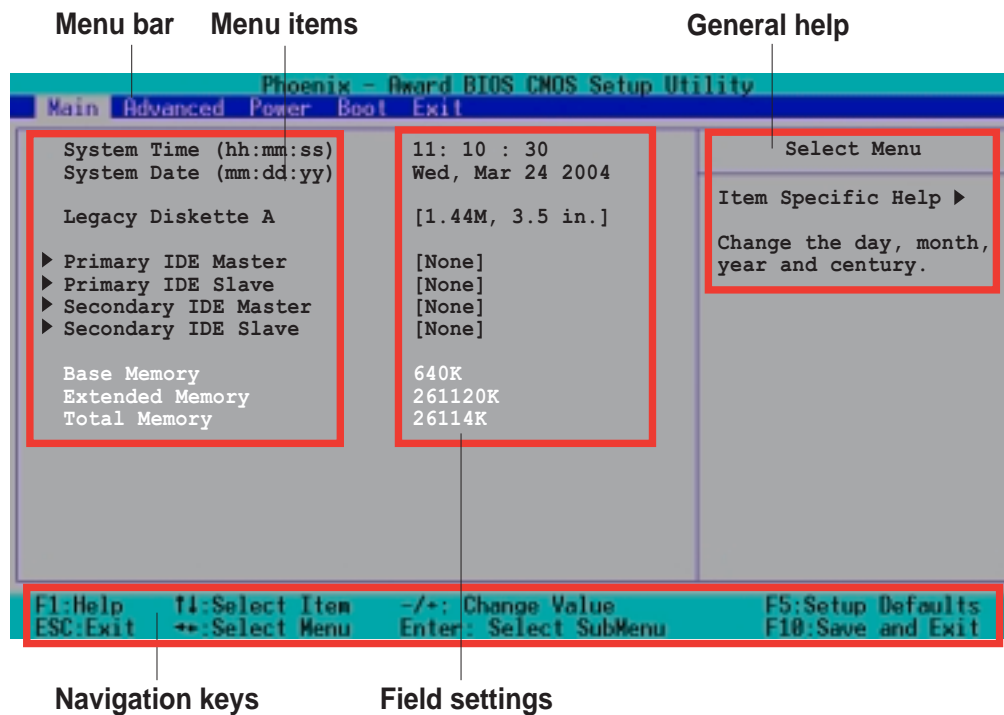

4.2.2 Menu bar

The menu bar on top of the screen has the following main items:

- Main** For changing the basic system configuration settings
- Advanced** For changing the advanced system settings
- Power** For changing the power configuration settings
- Boot** For changing the system boot configuration settings
- Exit** For selecting the exit options and loading default settings

To select the menu bar items, press the right or left arrow key on the keyboard until the desired item is highlighted.

4.2.3 Navigation keys

At the **bottom** of a menu screen are the navigation keys for that particular menu. Use the navigation keys to select items in the menu and change the settings.



The navigation keys differ from one screen to another.

4.2.4 General help

On the right side of the menu screen is a brief description of the selected item.

4.2.5 Sub-menu

An item with a sub-menu on any menu screen is distinguished by a solid triangle before the item. To display the sub-menu, select the item and press <Enter>.

4.2.6 Scroll bar

A scroll bar appears on the right side of a menu screen when there are items that do not fit on the screen. Press **Up/Down arrow keys** or **PageUp/PageDown keys** to display the other items on the screen.

4.2.7 Pop-up window

Select an item in the menu, then press <Enter> to display a pop-up window with the configuration options for that item.

4.3 Main menu

When you enter the BIOS Setup program, the Main menu screen appears giving you an overview of the basic system information.



Refer to section “4.2.1 BIOS menu screen” for information on the menu screen items and how to navigate through them.

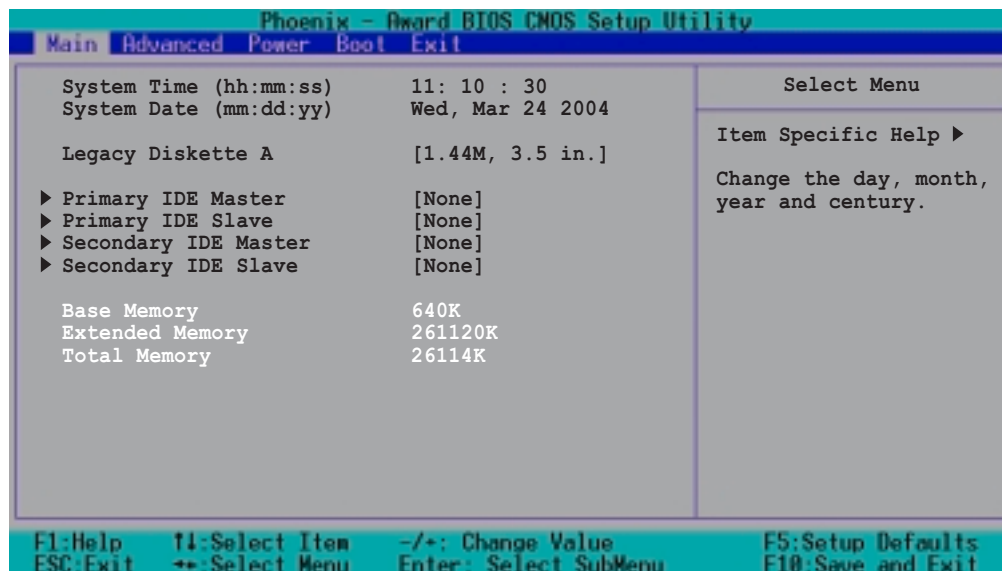

System Time (hh:mm:ss)

Sets the system to the time that you specify (usually the current time). The format is hour:minute:second. Valid values for hour, minute, and second are Hour: (00 to 23), Minute: (00 to 59), Second: (00 to 59). Use the <Tab> key to move between the hour, minute, and second fields.

System Date (mm:dd:yy)

Sets the system to the date that you specify (usually the current date). The format is month:day:year. Valid values for month, day, and year are Month: (1 to 12), Day: (1 to 31), Year: (1999 to 2099). Use the <Tab> key to move between the month, day, and year fields.

Legacy Diskette A [1.44M, 3.5 in.]

Sets the type of floppy drive installed. Configuration options: [None] [360K, 5.25 in.] [1.2M , 5.25 in.] [720K , 3.5 in.] [1.44M, 3.5 in.] [2.88M, 3.5 in.]

Base/Extended/Total Memory [xxxK]

The base memory, extended memory, and total memory values are auto-detected. These fields are not user-configurable.

4.3.1 Primary IDE Master

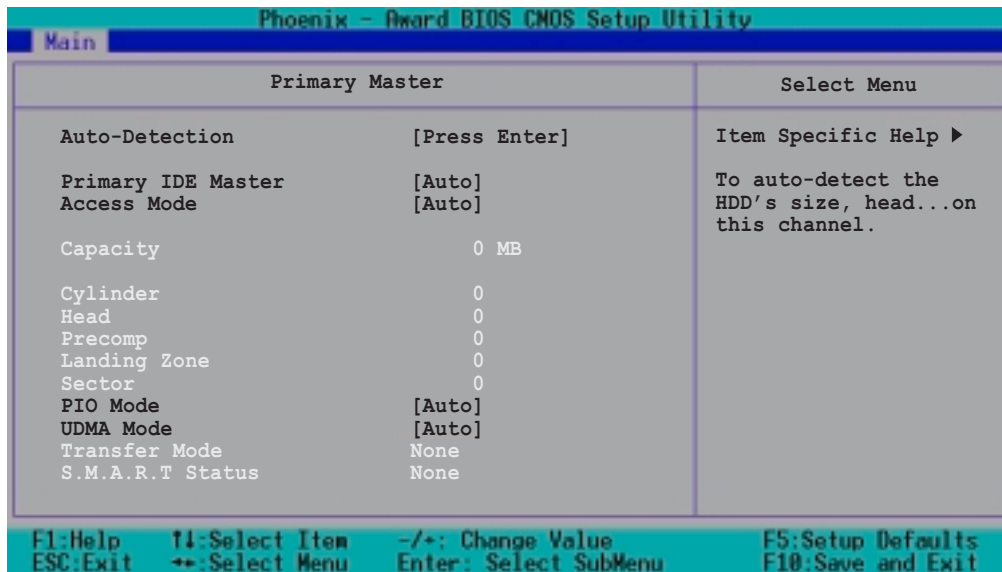

Auto-Detection [Press Enter]

Press <Enter> to automatically detect an IDE drive, if the drive is not yet detected. Upon pressing <Enter>, the message “Detecting Hard Drive...” appears as the BIOS attempts to detect the presence of a IDE drive.

Primary IDE Master [Auto]

Select [Auto] to automatically detect an IDE drive. If automatic detection is successful, the setup BIOS automatically fills in the correct values for the remaining fields on this sub-menu.

If automatic detection fails, this may be because the IDE drive is too old or too new. If the drive was already formatted on a previous system, the BIOS may detect incorrect parameters. In these cases, select [Manual] to manually enter the IDE drive parameters. Refer to the section “Manually detecting an IDE drive.”

If no drive is installed or if you are removing a drive and not replacing it, select [None]. Configuration options: [None] [Auto] [Manual]



The IDE drive information items are grayed out when this item is set to [Auto].

Access Mode [Auto]

Allows selection of the sector addressing mode. The default [Auto] allows automatic detection of an IDE drive. Set this item to [CHS] if the **Primary IDE Master** item is set to [Manual] so you can manually enter the drive values. Configuration options: [CHS] [LBA] [Large] [Auto]

PIO Mode [Auto]

Sets the PIO mode for the IDE drive. The settings Mode 0 to 4 allow successive increase in performance. Configuration options: [Auto] [Mode 0] [Mode 1] [Mode 2] [Mode 3] [Mode 4]

UDMA Mode [Auto]

When this item is set to [Auto], the UDMA capability allows improved transfer speeds and data integrity for supported IDE drives. Configuration options: [Disabled] [Auto]

Manually detecting an IDE drive

If you wish to manually enter the drive information, set the Primary IDE Master item to [Manual], and the Access Mode item to [CHS].

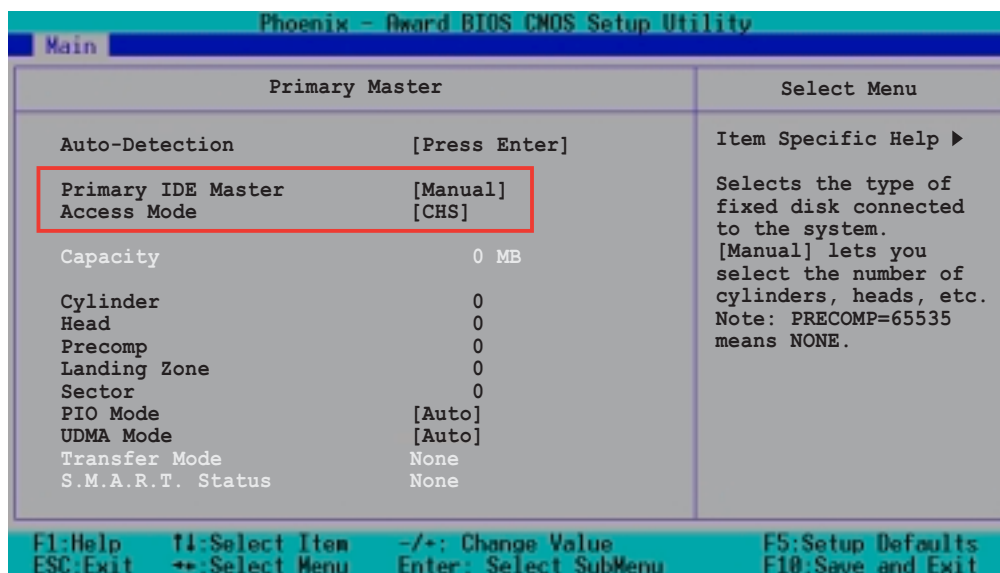

Before attempting to manually configure an IDE drive, make sure that you have the correct configuration information supplied by the drive manufacturer. Incorrect settings may cause the system to fail to recognize the installed IDE drive!

To manually enter the number of cylinder, head, precomp, landing zone, and sector per track for the drive, highlight an item, key-in the value that you obtained from the drive documentation, then press <Enter>. Refer to the drive documentation or the drive label for this information.

To enter a value, you may also highlight the item, then press <Enter> to display a pop-up menu. Type in the value from the drive documentation, then press <Enter>.

Capacity [xxxxx MB]

Displays the auto-detected hard disk capacity. The value is not user-configurable.

Cylinder

Shows the number of the hard disk cylinders.

Head

Shows the number of the hard disk read/write heads.

Precomp

Displays the precompressed volumes on the hard disk, if any, on the motherboard.

Landing Zone

Displays the drive's maximum usable capacity as calculated by the BIOS based on the drive information you entered.

Sector

Shows the number of sectors per track.

Transfer Mode

Shows the data transfer mode if the IDE hard disk drive supports the feature. Otherwise, this item is grayed out and shows the value [None].

S.M.A.R.T. Status

Shows the Smart Monitoring, Analysis, and Reporting Technology (S.M.A.R.T.) status if the IDE hard disk drive supports the feature. Otherwise, this item is grayed out and shows the value [None].



After entering the IDE hard disk drive information, use a disk utility, such as FDISK, to partition and format new IDE drives. This is necessary so that you can write or read data from the hard disk. Make sure to set the partition of the Primary IDE hard disk drive to "Active."

4.3.2 Primary IDE Slave

When configuring a drive as Primary IDE Slave, refer to section “4.3.1 Primary IDE Master” for the menu item descriptions.

4.3.3 Secondary IDE Master

When configuring a drive as Secondary IDE Master, refer to section “4.3.1 Primary IDE Master” for the menu item descriptions.

4.3.4 Secondary IDE Slave

When configuring a drive as Secondary IDE Slave, refer to section “4.3.1 Primary IDE Master” for the menu item descriptions.

4.4 Advanced menu

The Advanced menu items allow you to change the settings for the CPU, memory, chipset, and other system devices.



Take caution when changing the settings of the Advanced menu items. Incorrect field values may cause the system to malfunction!

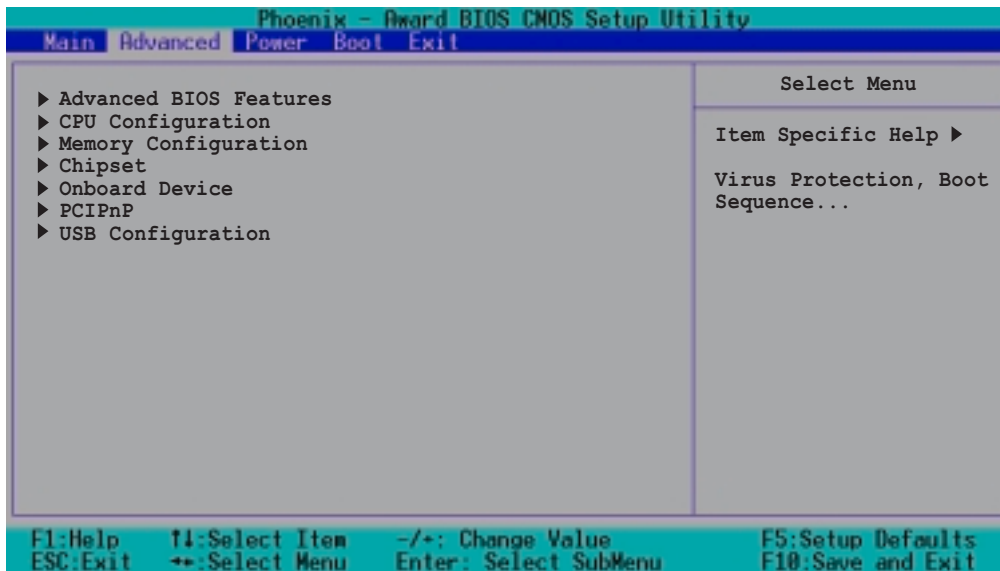

4.4.1 Advanced BIOS Features

This menu shows the console redirection and agent information. Select an item then press <Enter> to display a pop-up menu with the configuration options.

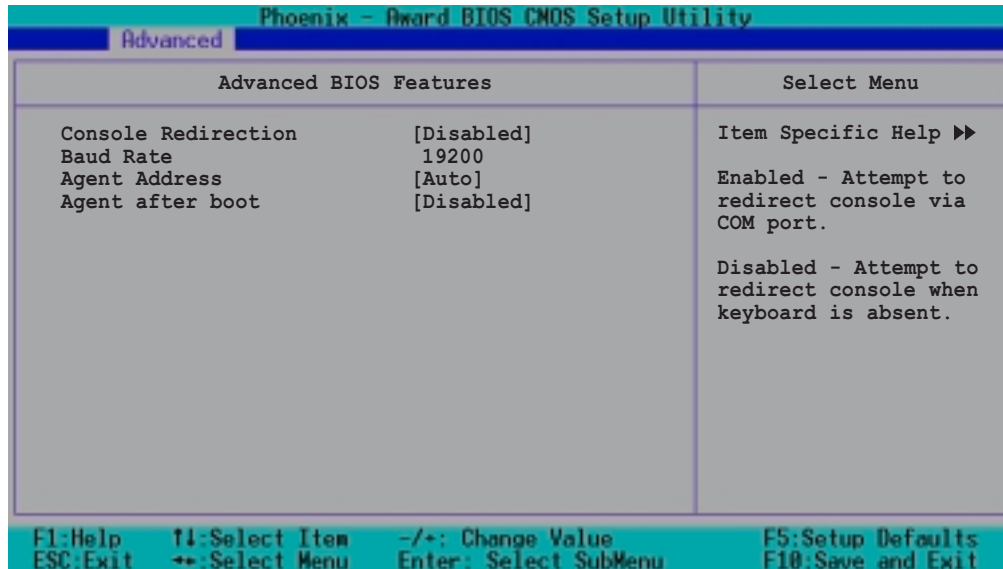

Console Redirection [Disabled]

This item allows you to redirect the console through the serial port. when set to [Enabled], the **Baud Rate** option is activated.

Configuration options: [Disabled] [Enabled]

Baud Rate [19200]

This item appears only when the **Console Redirection** option is set to [Enabled]. This parameter allows you to set the Baud rate of the console redirection to the serial port. Configuration options: [9600] [19200] [38400] [57600] [115200]

Agent Address [Auto]

This option allows you to delect the agent adress.

Configuration options: [3F8h] [2F8h] [3E8h] [2E8h] [Auto]

Agent after boot [Disabled]

This option allows you to enable or disable the agent after boot-up.

Configuration options: [Disabled] [Enabled]

4.4.2 CPU Configuration

This menu shows the CPU configuration settings. Select an item then press <Enter> to display a pop-up menu with the configuration options.

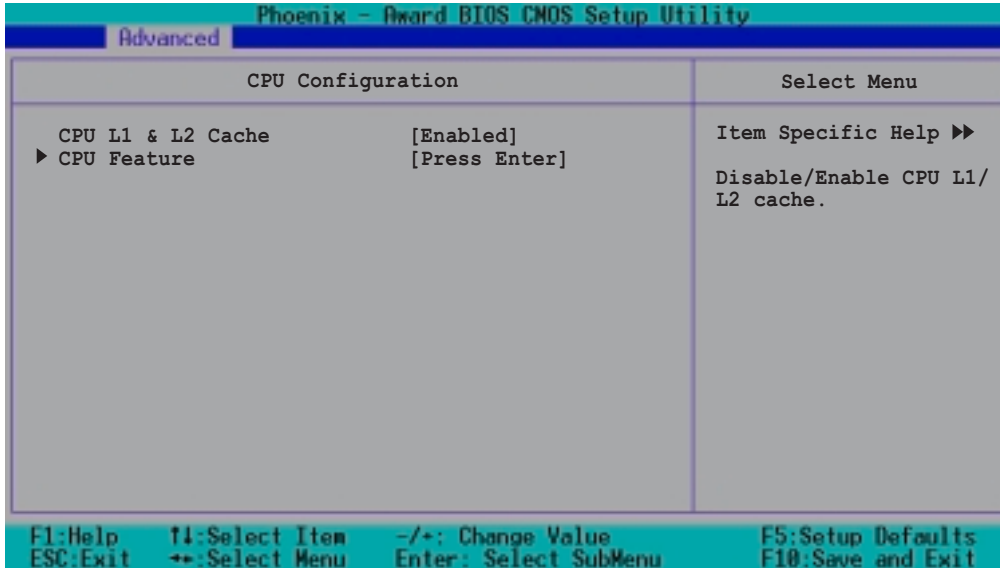

CPU L1 & L2 Cache [Enabled]

Allows you to enable or disable the CPU L1 and L2 cache. Configuration options: [Disabled] [Enabled]

CPU Feature

The CPU Feature window displays the thermal management and monitor feature of this motherboard.

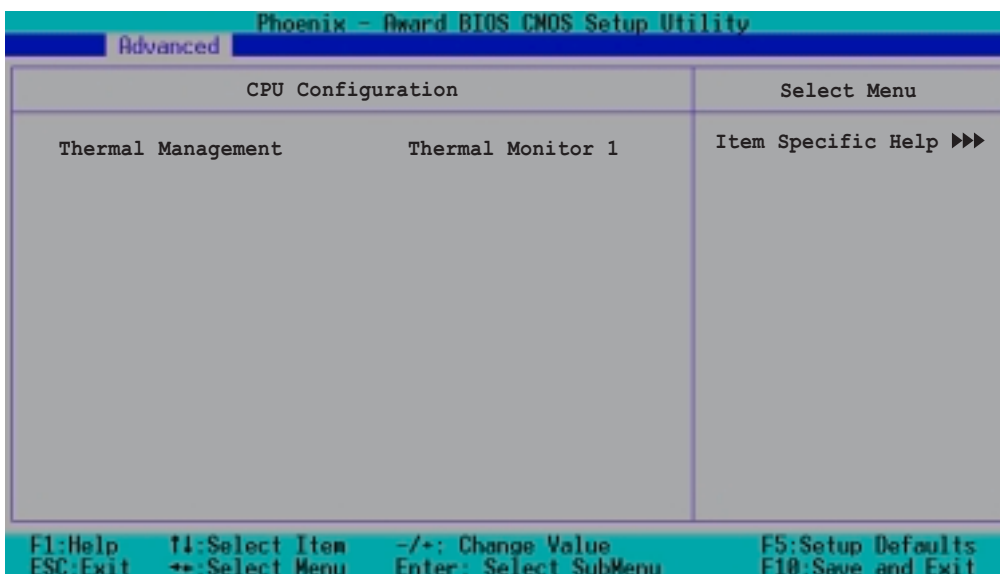

The Thermal Management item is not user-configurable

4.4.3 Memory Configuration

This menu shows the memory configuration settings. Select an item then press <Enter> to display a pop-up menu with the configuration options.

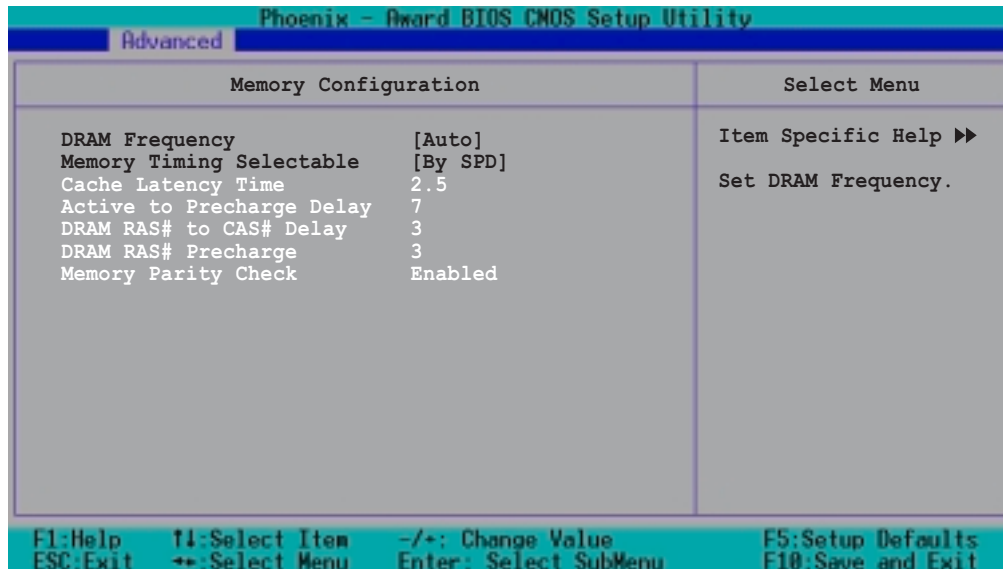

DRAM Frequency [Auto]

This item sets the DRAM operating frequency. Configuration options: [DDR266] [DDR333] [Auto]

Memory Timing Selectable [By SPD]

The DRAM clock are set according to the DRAM SPD (Serial Presence Detect). Select [By SPD] for automatic DRAM clock detection. Select [Manual] to allow setting the succeeding memory items to optimal timings. Configuration options: [Manual] [By SPD]



The items CAS Latency Time, Active to Precharge Delay, DRAM RAS# to CAS# Delay, and DRAM RAS# Precharge are configurable only when the Memory Timing Selectable item is set to [Manual].

CAS Latency Time [2.5]

This item sets the latency (in clocks) between the DRAM read command and the time the data actually becomes available. Configuration options: [2] [2.5] [3]

Active to Precharge Delay [7]

This item controls the number of DRAM clocks used for DRAM parameters. Configuration options: [8] [7] [6] [5]

DRAM RAS# to CAS# Delay [3]

Controls the latency between the DRAM active command and the read/write command. Configuration options: [4] [3] [2]

DRAM RAS# Precharge [3]

This item controls the idle clocks after issuing a precharge command to the DDR SDRAM. Configuration options: [4] [3] [2]

Memory Parity Check [Enabled]

Allows memory parity checking option. This item is not user-configurable and set to [Enabled] by default.

4.4.4 Chipset

This menu shows the chipset configuration settings. Select an item then press <Enter> to display a sub-menu with additional items, or show a pop-up menu with the configuration options.

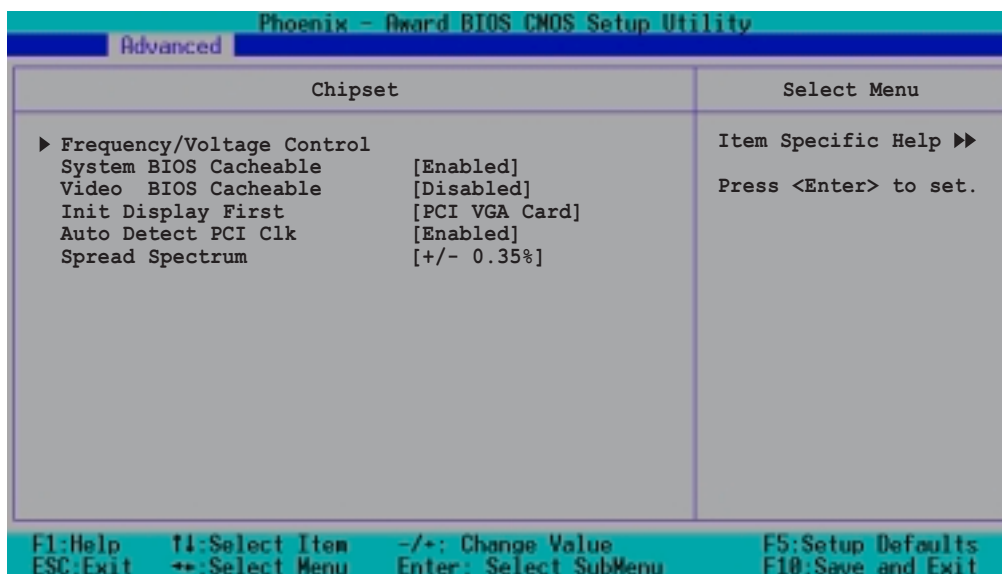

System BIOS Cacheable [Enabled]

Allows you to enable or disable the cache function of the system BIOS. Configuration options: [Disabled] [Enabled]

Video BIOS Cacheable [Disabled]

Allows you to enable or disable the cache function of the video BIOS. Setting to [Enabled] improves the display speed by caching the display data. Configuration options: [Disabled] [Enabled]

Init Display First [PCI VGA Card]

Allows you to select the graphics controller to use as primary boot device.
Configuration options: [PCI VGA Card] [AGP Slot]

Auto Detect PCI Clk [Enabled]

Allows you to select the maximum PCI bus speed to be programmed.
Configuration options: [Enabled] [Disabled]

Spread Spectrum [+/- 0.35%]

Allows you to select the clock generator spread spectrum.
Configuration options: [Disabled] [+/-0.35%] [+/- 0.50%] [+/- 0.75%]
[+/- 1.00%]

Frequency/Voltage Control

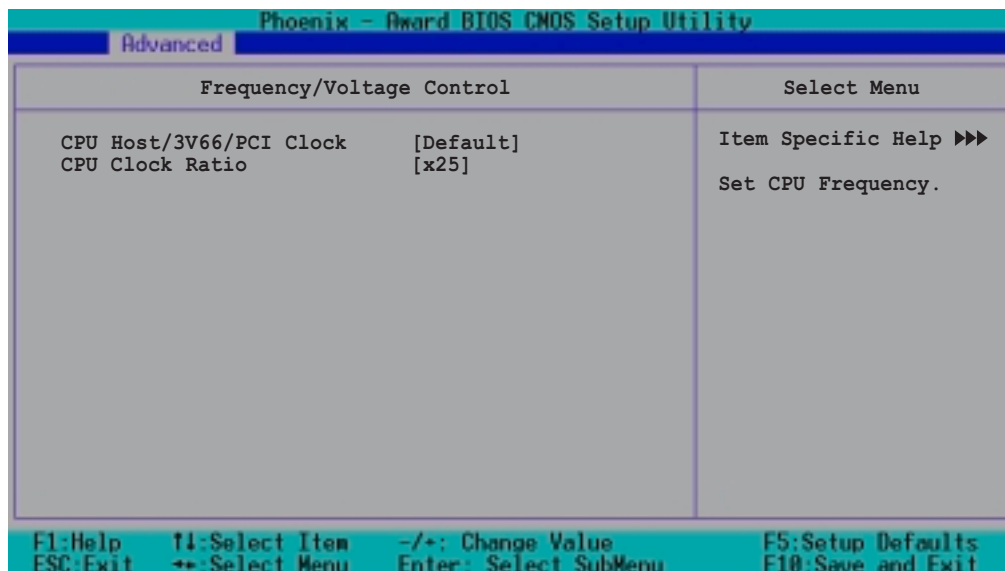

CPU Host/3V66/PCI Clock [Default]

Allows you to set the CPU, AGP, and PCI frequencies.
Configuration options: [Default] [100/66/33MHz] [105/70/35MHz]
[110/73/36MHz] [115/77/38MHz] [133/66/33MHz] [140/70/35MHz]
[147/73/37MHz] [153/77/38MHz] [200/66/33MHz] [210/70/35MHz]
[220/73/37MHz] [230/77/38MHz]

CPU Clock Ratio [x25]

This option allows you to set the ratio between the CPU core clock and the front side bus frequency. Highlight this item then press <Enter> to display a pop-up menu. Type in the value then press <Enter>.
Configuration options: [Min = 16; Max = 25]

4.4.5 Onboard Device

This menu shows the onboard device configuration settings. Select an item then press <Enter> to display a sub-menu with additional items, or show a pop-up menu with the configuration options.

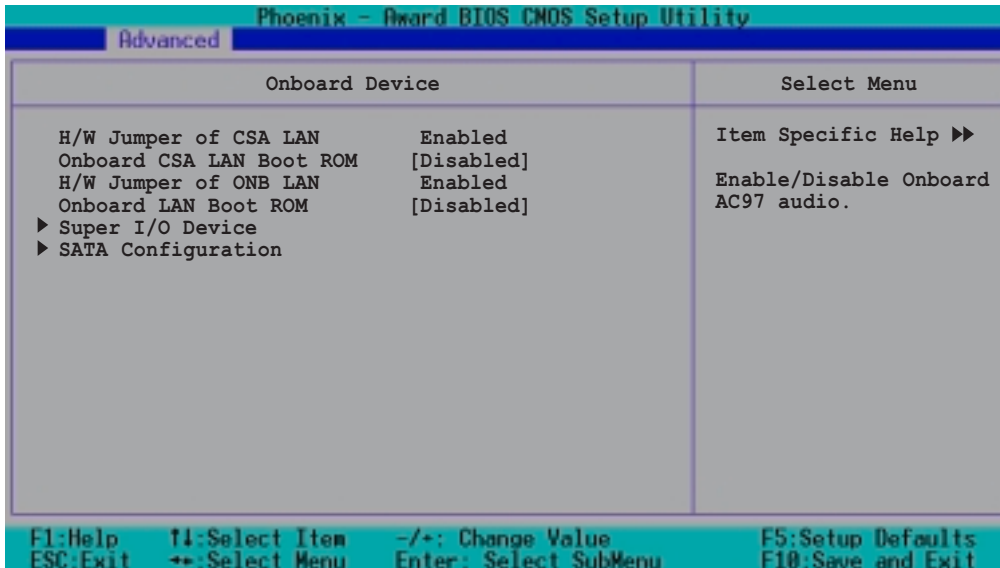

H/W Jumper of CSA LAN [Enabled]

This option tells whether the CSA LAN jumper labeled LAN_EN1 on the motherboard is enabled or disabled. See section “2.6 Jumpers” for details.

Onboard CSA LAN Boot ROM [Disabled]

Allows you to enable or disable the onboard CSA LAN boot ROM.
Configuration options: [Disabled] [Enabled]

H/W Jumper of ONB LAN [Enabled]

This option tells whether the onboard LAN jumper labeled LAN_EN2 on the motherboard is enabled or disabled. See section “2.6 Jumpers” for details.

Onboard LAN Boot ROM [Disabled]

Allows you to enable or disable the onboard LAN boot ROM.
Configuration options: [Disabled] [Enabled]

Super I/O Device

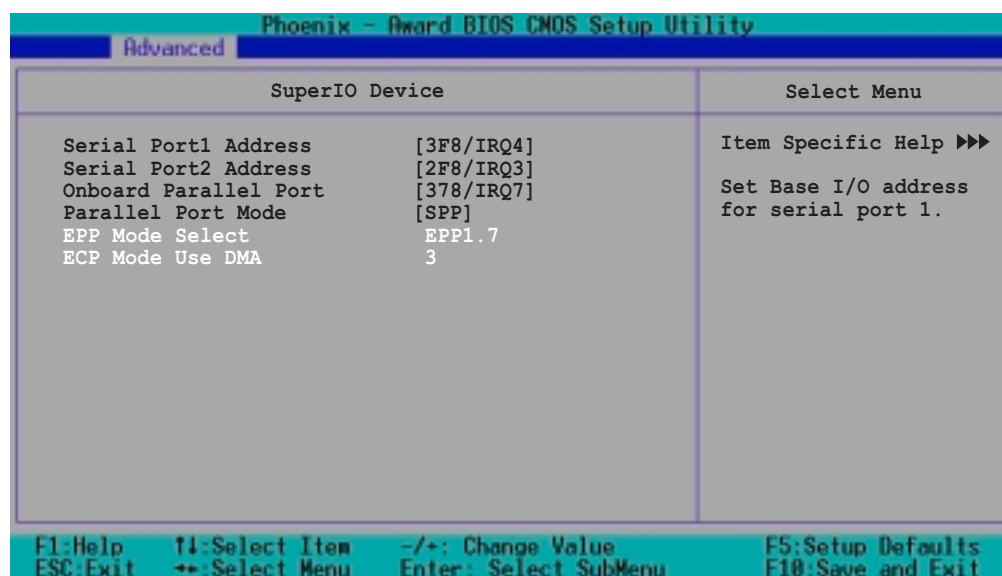

Serial Port 1 [3F8/IRQ4]

Serial Port 2 [2F8/IRQ3]

Allow you to select the serial port base addresses. Configuration options: [Disabled] [3F8/IRQ4] [2F8/IRQ3] [3E8/IRQ4] [2E8/IRQ3] [Auto]

Onboard Parallel Port [378/IRQ7]

Allows you to select the parallel port base address.

Configuration options: [Disabled] [378/IRQ7] [278/IRQ5] [3BC/IRQ7]

Parallel Port Mode [SPP]

Allows you to select the parallel port mode.

Configuration options: [SPP] [EPP] [ECP] [ECP+EPP] [Normal]

EPP Mode Select [EPP1.7]

Allows you to select the EPP mode. This item becomes configurable only if the **Parallel Port Mode** is set to [EPP] or [ECP+EPP].

Configuration options: [EPP 1.7] [EPP 1.9]

ECP Mode Use DMA [3]

Allows you to select the ECP mode. This item becomes configurable only if the **Parallel Port Mode** is set to [ECP] or [ECP+EPP].

Configuration options: [1] [3]

SATA Configuration

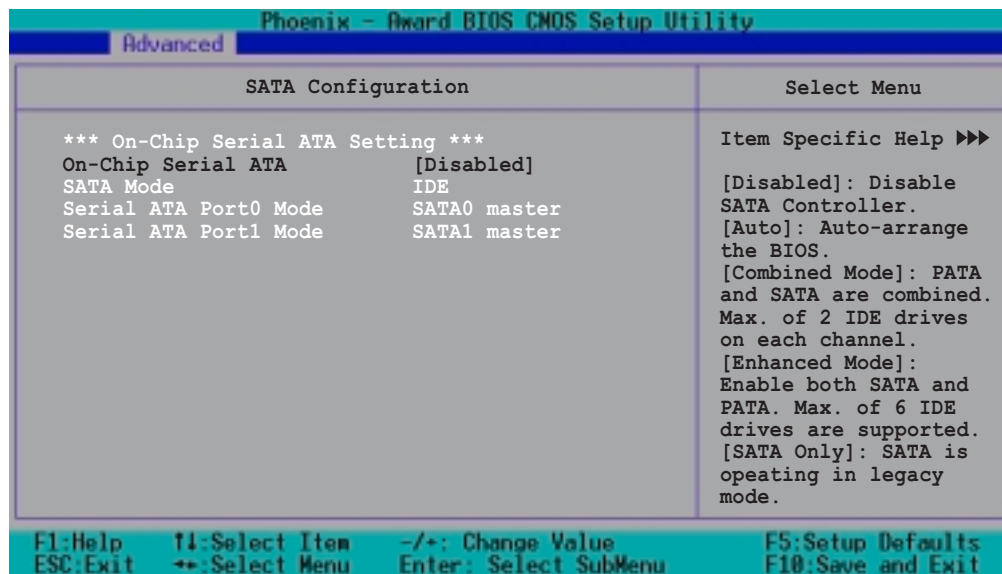

On-Chip Serial ATA Setting



The SATA Mode and Serial ATA Port0 Mode items are configurable only when the On-Chip Serial ATA item is set to [Combined Mode] [Enhanced Mode] or [SATA Only].

On-chip Serial ATA [Disabled]

This item allows you to configure your serial ATA devices, if present. Configuration options: [Disabled] [Auto] [Combined Mode] [Enhanced Mode] [SATA Only]

- Setting to [**Auto**] allows BIOS to automatically configure the SATA devices.
- Setting to [**Combined Mode**] allows you to install parallel ATA and serial ATA devices at the same time. You may install **two IDE devices on any of the parallel ATA channels**, and **one IDE device on each serial ATA channel** for a maximum of **four** devices. Use this option when you installed a legacy operating system like MS-DOS, Windows ME/98/NT4.0.
- Setting to [**Enhanced Mode**] allows you to install parallel ATA and serial ATA devices at the same time, with a maximum of **six** IDE devices on each channel. Use this option when you installed a native operating system like Windows 2000/XP.
- Setting to [**SATA Only**] allows you to install IDE devices on the Serial ATA channels only.

- e. Setting to **[Disabled]** disables the onboard SATA controller. The RAID feature is also disabled.

SATA Mode [IDE]

When set to [RAID], this item allows configuration of the installed IDE devices into a disk array. Refer to the software installation guide for details on RAID configuration. Configuration options: [IDE] [RAID]

Serial ATA Port0 Mode [SATA0 Master]

Serial ATA Port1 Mode [SATA1 Master]

Allow you to set the SATA Port0 and Serial ATA Port1 modes. The options for these items vary depending on the setting of the **On-Chip Serial ATA** item. Configuration options: [Primary Master] [Secondary Master] [SATA0 master] SATA1 master]

4.4.6 PCIPnP

This menu shows the PCIPnP configuration settings. Select an item then press <Enter> to display a pop-up menu with the configuration options.

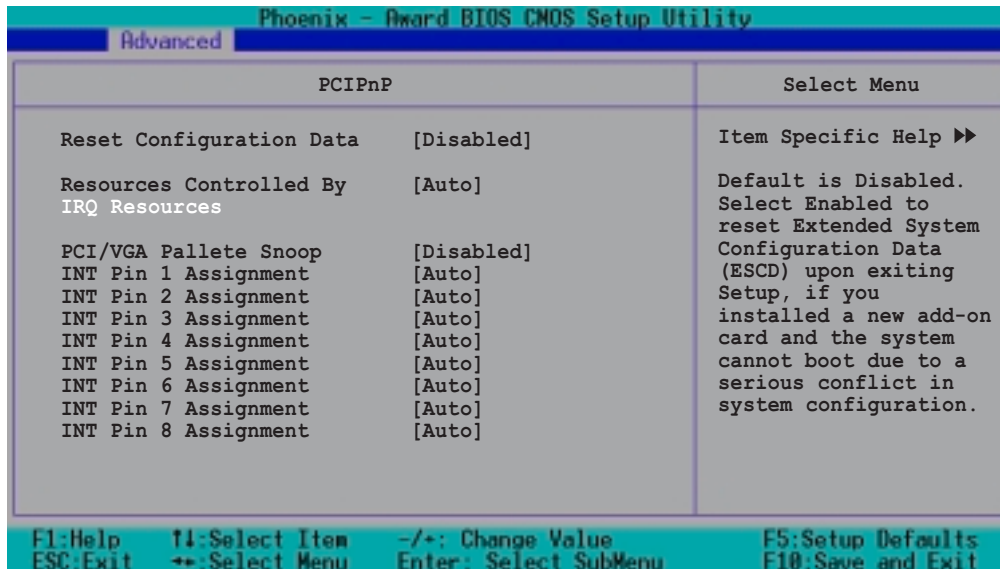

Reset Configuration Data [Disabled]

Allows you to enable or disabled resetting of the Extended System Configuration Data (ESCD) when you exit the Setup. The ESCD includes information on non-PnP devices. Set this item to [Enabled] if you installed an expansion card that conflicts with other devices and cause system boot failure. Configuration options: [Disabled] [Enabled]

Resources Controlled By [Auto]

When set to [Auto(ESCD)], allows BIOS to automatically configure of all boot and Plug and Play devices. When set to [Manual], you can assign the available IRQ Resources to the PCI devices.

Configuration options: [Auto] [Manual]



When the item **Resources Controlled By** is set to [Auto], the item IRQ Resources is grayed out and not user-configurable. Refer to the section "IRQ Resources" for information on how to enable this item.

PCI/VGA Pallete Snoop [Disabled]

Some non-standard VGA cards, like graphics accelerators or MPEG video cards, may not show colors properly. Setting this field to [Enabled] corrects this problem. If you are using a standard VGA card, leave this field to the default setting [Disabled]. Configuration options: [Disabled] [Enabled]

INT Pin 1~8 Assignment [Auto]

Allows you to select the appropriate interrupt to the specific devices to avoid conflict. Configuration options: [Auto] [3] [4] [5] [7] [9] [10] [11] [12] [14] [15]

IRQ Resources



Set the item **Resources Controlled By** is set to [Manual] to enable the item **IRQ Resources** and assign the interrupts depending on the type of installed PCI device.

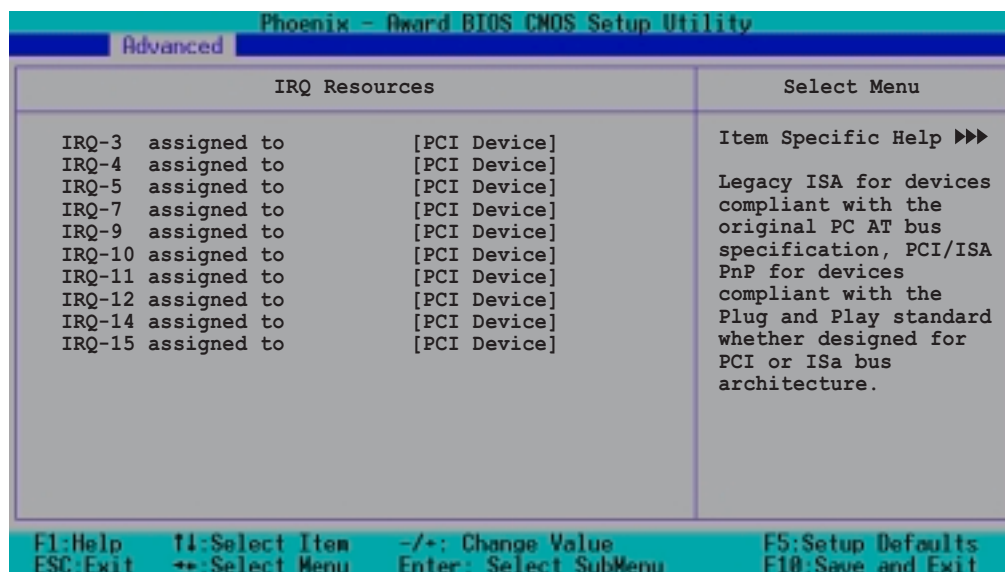
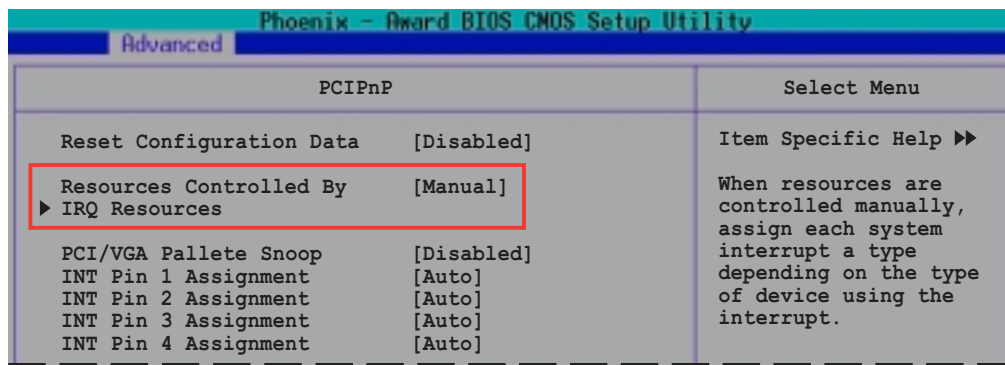

IRQ-xx assigned to [PCI device]

The IRQ Resources sub-menu is activated when the Resources Controlled by parameter is set to [Manual]. Select [PCI Device] to assign an IRQ address to a Plug and Play device. Setting to [Reserved] reserves the IRQ address. Configuration options: [PCI Device] [Reserved]

4.4.7 USB Configuration

This menu shows the USB configuration settings. Select an item then press <Enter> to display a pop-up menu with the configuration options.

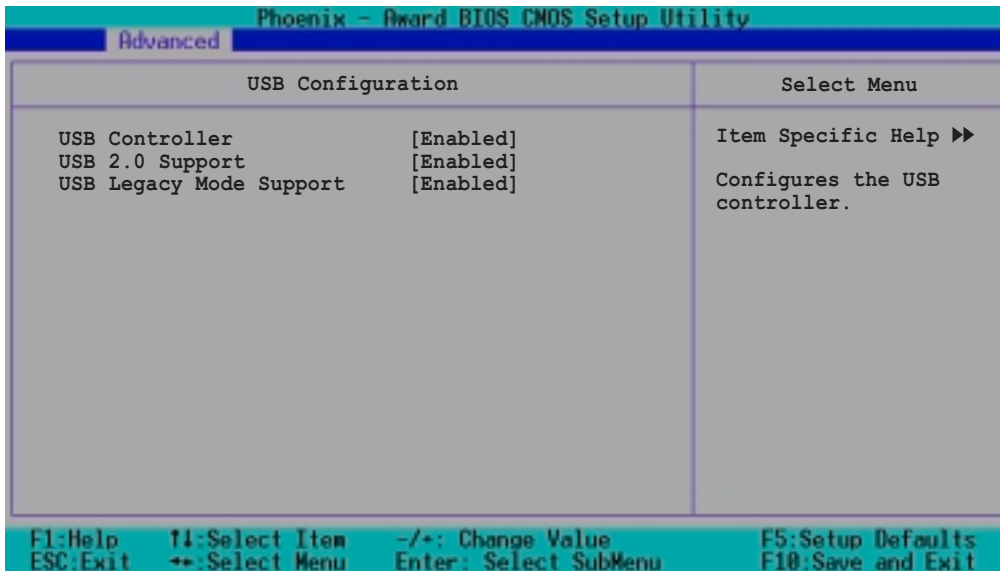

USB Controller [Enabled]

Allows you enable or disable the USB controller.

Configuration options: [Disabled] [Enabled]

USB 2.0 Support [Enabled]

Allows you to enable or disable the EHCI controller. Setting this item to [Enabled] allows the built-in high speed USB support in the BIOS to turn on automatically when you install high speed USB devices.

Configuration options: [Disabled] [Enabled]

USB Legacy Mode Support [Enabled]

Allows you enable or disable support for the legacy USB devices.

Configuration options: [Disabled] [Enabled]

4.5 Power menu

The Power menu items allow you to change the settings for the Advanced Power Management (APM). Select an item then press <Enter> to display the configuration options.

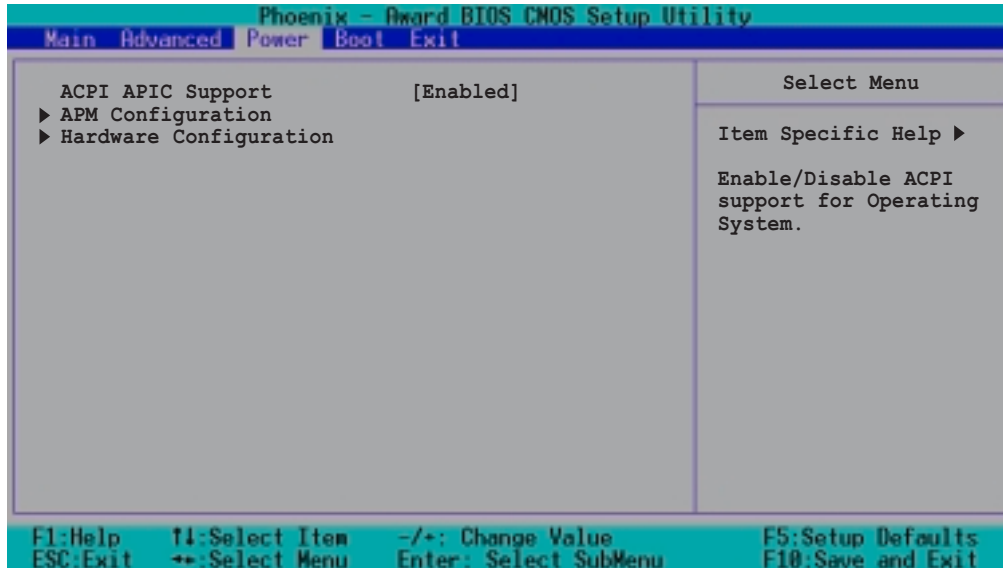

ACPI APIC Support [Enabled]

Allows you to enable or disable the ACPI feature on the operating system. Configuration options: [Disabled] [Enabled]

4.5.1 APM Configuration

This menu shows the Advanced Power Management (APM) configuration settings. Select an item then press <Enter> to display a pop-up menu with the configuration options.

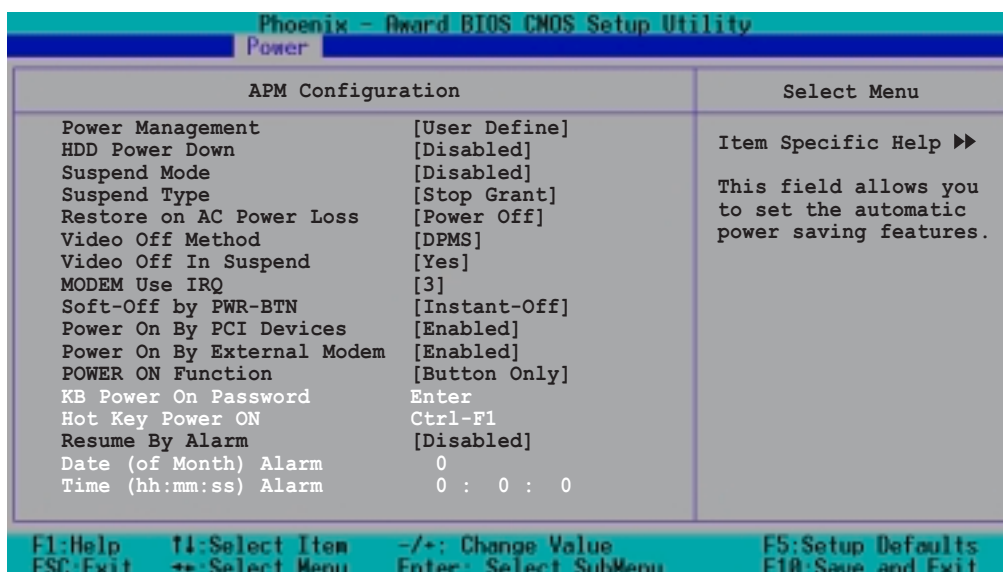

Power Management [User Define]

Allows you to set the automatic power saving features. Configuration options: [User Define] [Min. Saving] [Max. Saving]

HDD Power Down [Disabled]

Shuts down any IDE hard disk drives in the system after a period of inactivity as set in this user-configurable field. This feature does not affect SCSI hard drives. Configuration options: [Disabled] [1 Min] ... [15 Min]

Suspend Mode [Disabled]

Sets the time period before the system goes into suspend mode. Configuration options: [Disabled] [1 Min] [2 Min] [4 Min] [8 Min] [12 Min] [20 Min] [30 Min] [40 Min] [1 Hr]

Suspend Type [Stop Grant]

Allows you to select the suspend type. Configuration options: [Stop Grant] [PwrOn Suspend]

Restore on AC Power Loss [Power Off]

When set to [Power Off], the system goes into “off state” after an AC power interruption. When set to [Power On], the system turns on automatically after an power interruption. When set to [Last State], the system goes into whatever was the system state (on or off) before the power interruption. Configuration options: [Power Off] [Power On] [Last State]

Video Off Method [DPMS]

This item determines the video off features. The Display Power Management System (DPMS) feature allows the BIOS to control the video display card if it supports the DPMS feature. [Blank Screen] only blanks the screen. Use this for monitors without power management or “green” features. Configuration options: [Blank Screen] [V/H SYNC+Blank] [DPMS]

Video Off In Suspend [Yes]

This item determines when to activate the video off feature for monitor power management. Configuration options: [Yes] [No]

MODEM Use IRQ [3]

Allows you to select the IRQ assignment for the modem. Configuration options: [NA] [3] [4] [5] [7] [9] [10] [11]

Soft-Off by PWR-BTN [Instant-Off]

When set to [Instant-Off], the system goes to soft off when you press the power button for **less** than 4 seconds. When set to [Delay 4 Sec], press the power button for **more** than 4 seconds to power off the system.

Configuration options: [Instant-Off] [Delay 4 Sec.]

Power On By PCI Devices [Enabled]

Allows you to enable or disable the PME to generate a wake-up event.

Configuration options: [Disabled] [Enabled]

Power On By External Modem [Enabled]

Allows you to enable or disable system power up when the external modem receives a call while in soft-off mode.

Configuration options: [Disabled] [Enabled]

Power On Function [BUTTON ONLY]

Allows you to select a device to turn the system power on. Configuration options: [Password] [Hot Key] [Mouse Left] [Mouse Right] [Any KEY] [BUTTON ONLY] [PS/2 Mouse]

KB Power On Password [Enter]

Allows you to set a password to turn the system power on. Highlight this item then press enter to set a password.



To configure this item, you should set the **Power On Function** item to [Password].

Hot Key Power On [Ctrl-F1]

Allows you to set a hot key combination to turn the system power on.

Configuration options: [Ctrl-F1] ... [Ctrl-F12]



To configure this item, you should set the **Power On Function** item to [Hot Key].

Resume by Alarm [Disabled]

Allows you to enable or disable RTC to generate a wake event. When this item is enabled, you can set the date and time of alarm using the two following items. Configuration options: [Disabled] [Enabled]

Date (of Month) Alarm [0]

To set the date of alarm, highlight this item and press <Enter> to display a pop-up menu. Key-in a value within the specified range then press <Enter>. Configuration options: [Min=0] [Max=31]

Time (hh:mm:ss) Alarm [0 : 0 : 0]

To set the time of alarm:

1. Highlight this item and press <Enter> to display a pop-up menu for the hour field.
2. Key-in a value (Min=0, Max=23), then press <Enter>.
3. Press tab to move to the minutes field, then press <Enter>.
4. Key-in a minute value (Min=0, Max=59), then press <Enter>.
5. Press tab to move to the seconds field, then press <Enter>.
6. Key-in a value (Min=0, Max=59), then press <Enter>.

4.5.2 Hardware Monitor

This menu shows the hardware monitoring status. Select an item then press <Enter> to display a pop-up menu with the configuration options.

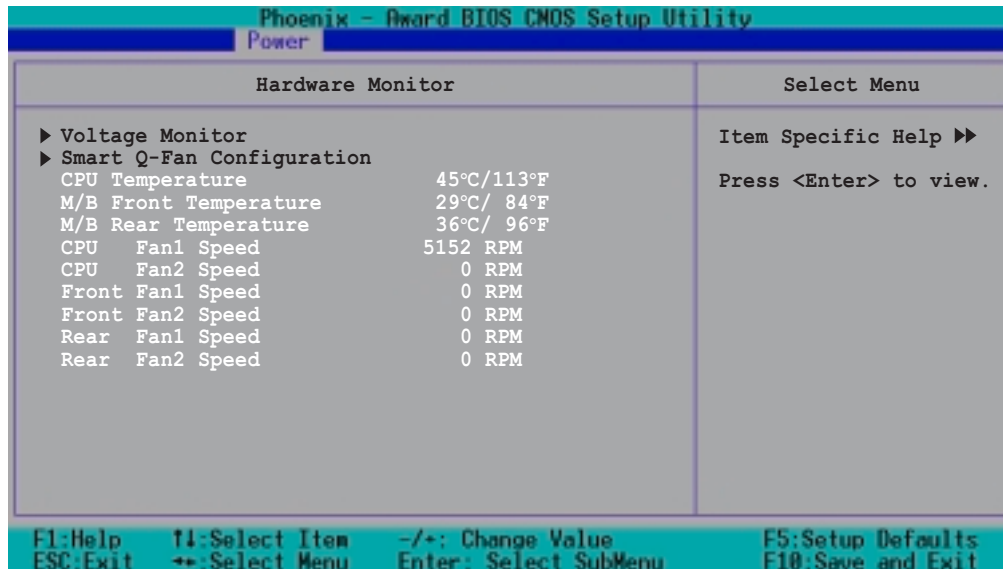

Voltage Monitor

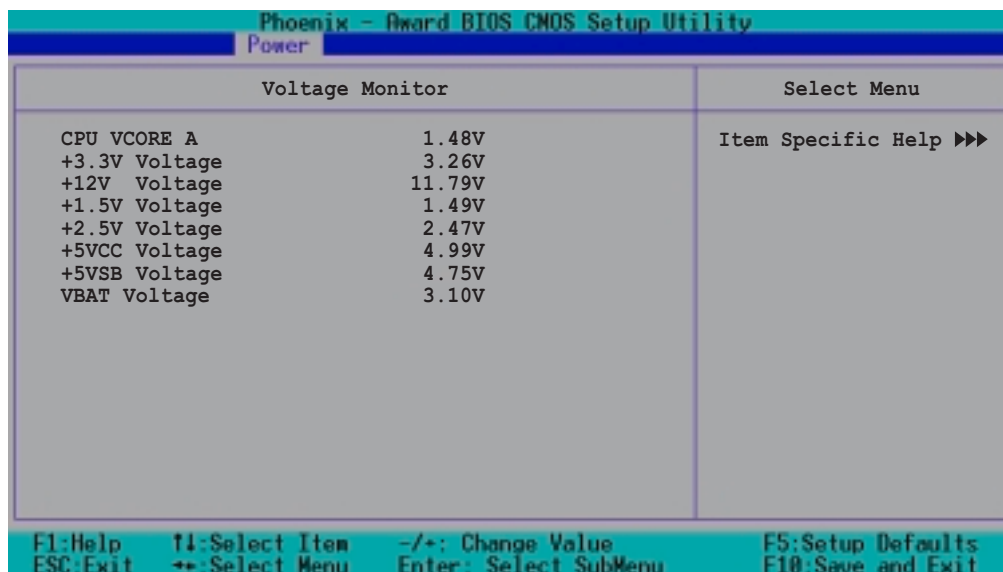

CPU VCORE A, +3.3V Voltage, +12V Voltage, +1.5V Voltage, +2.5V Voltage, +5VCC Voltage, +5VSB Voltage, VBAT Voltage,

These fields show the auto-detected voltages through the onboard voltage regulators.

Smart Q-Fan Configuration

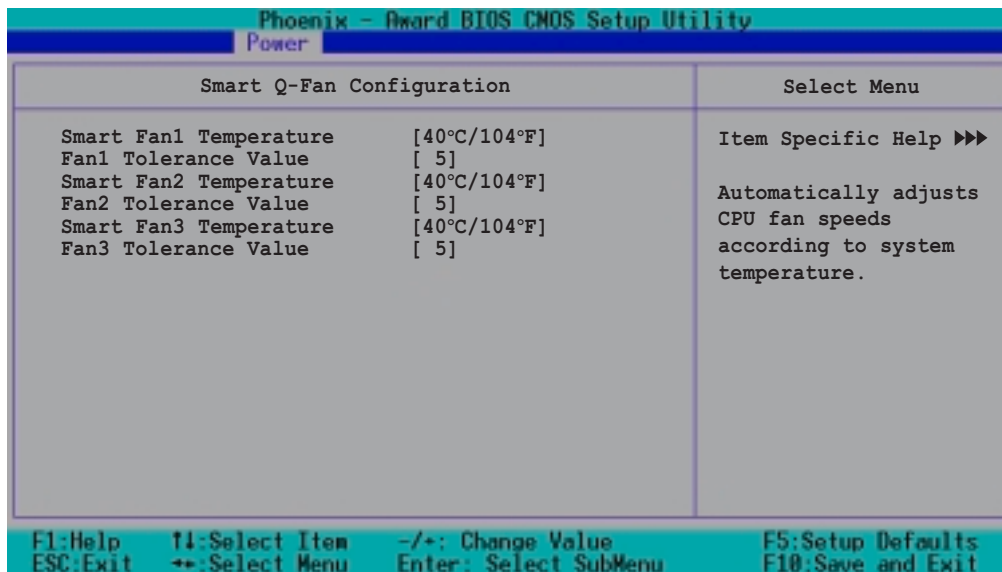

Smart Fan1 Temperature [40°C/104°F]

Smart Fan2 Temperature [40°C/104°F]

Smart Fan3 Temperature [40°C/104°F]

Allows automatic chassis, CPU, HDD, or power supply fan speed adjustment according to the system temperature.

Configuration options: [Disabled] [30°C/86°F] [35°C/95°F] [40°C/104°F]

Fan1 Tolerance Value [5]

Fan2 Tolerance Value [5]

Fan3 Tolerance Value [5]

Allows you to set the smart chassis, CPU, HDD, or power supply fan speed detection range. Configuration options: [Min = 1] [Max = 5]

4.6 Boot menu

The Boot menu items allow you to change the system boot settings. Select an item then press <Enter> to display a sub-menu with additional items, or show a pop-up menu with the configuration options.

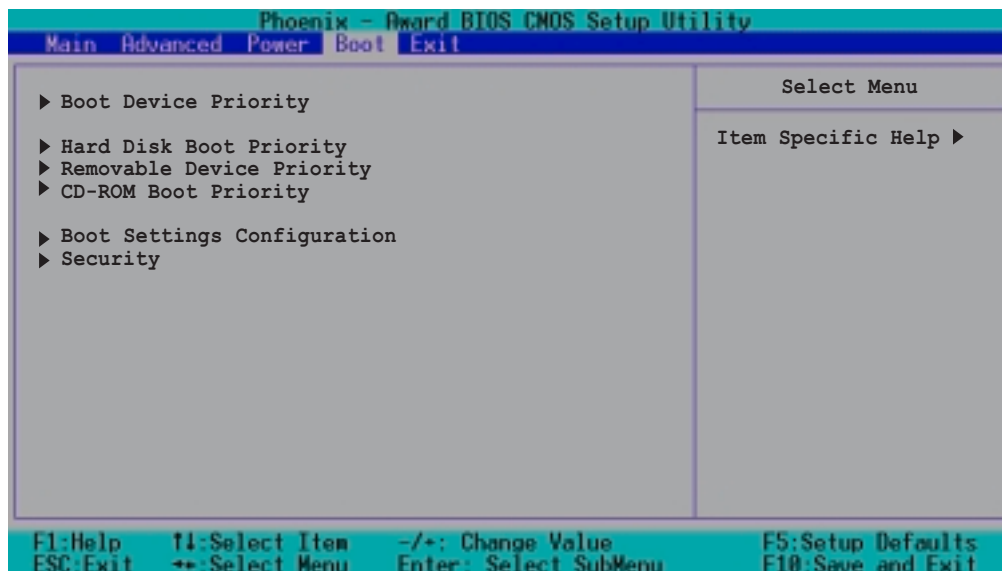

4.6.1 Boot Device Priority

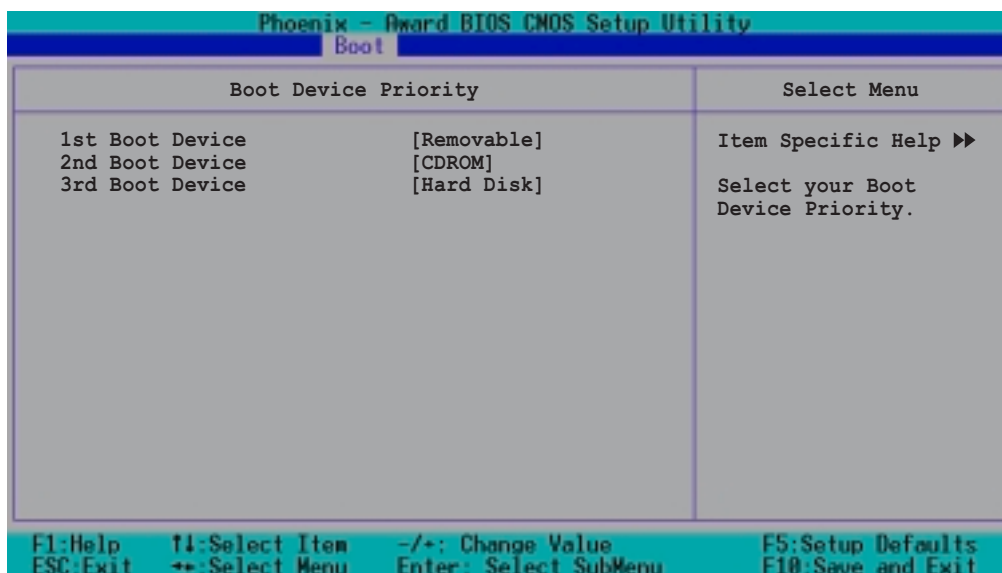

1st Boot Device [Removable]

2nd Boot Device [CDROM]

3rd Boot Device [Hard Disk]

These items allow you to select your boot device priority. Configuration options: [Removable] [Hard Disk] [CDROM] [Legacy LAN] [Disabled]

4.6.2 Hard Disk Boot Priority

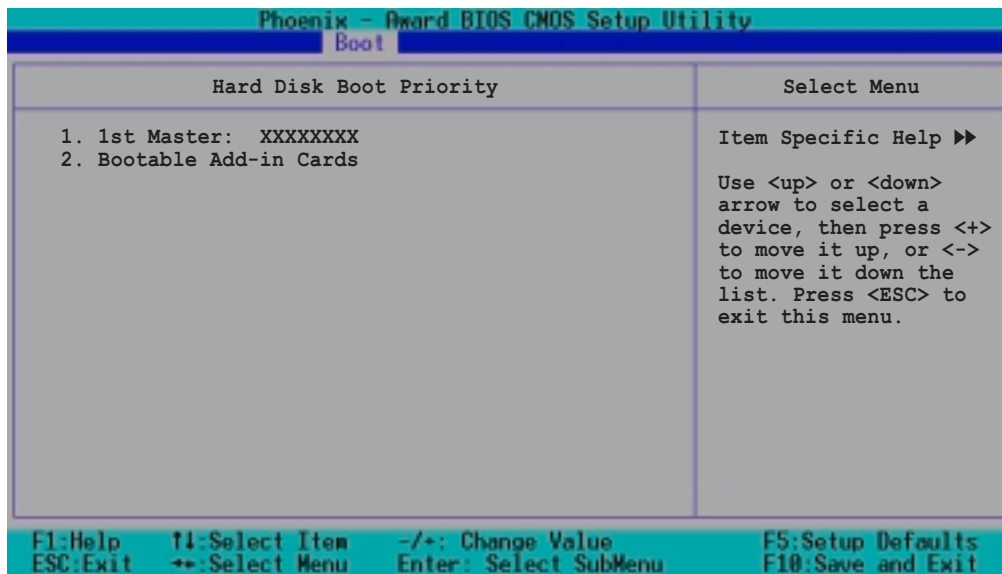

4.6.3 Removable Device Priority

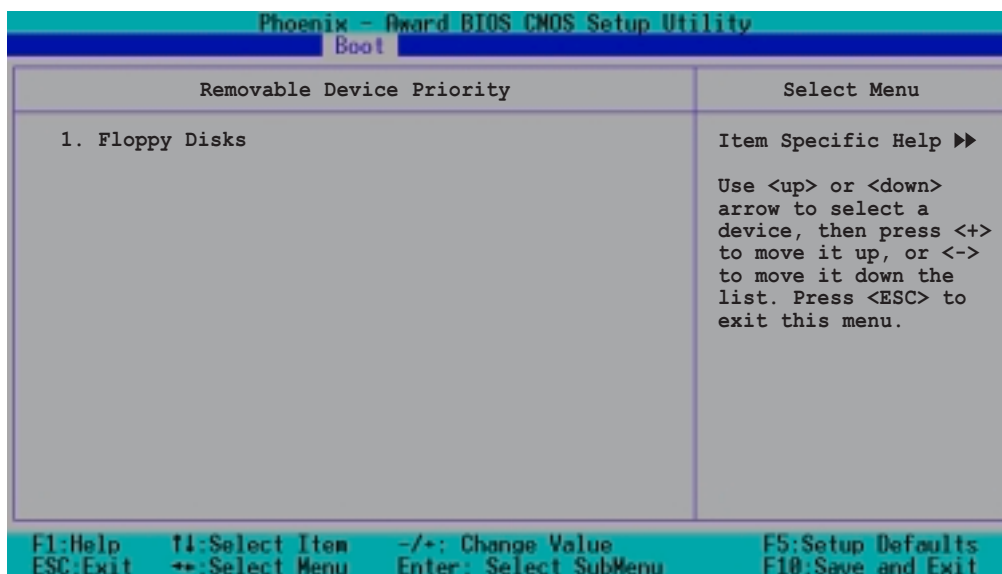

4.6.4 CD-ROM Boot Priority

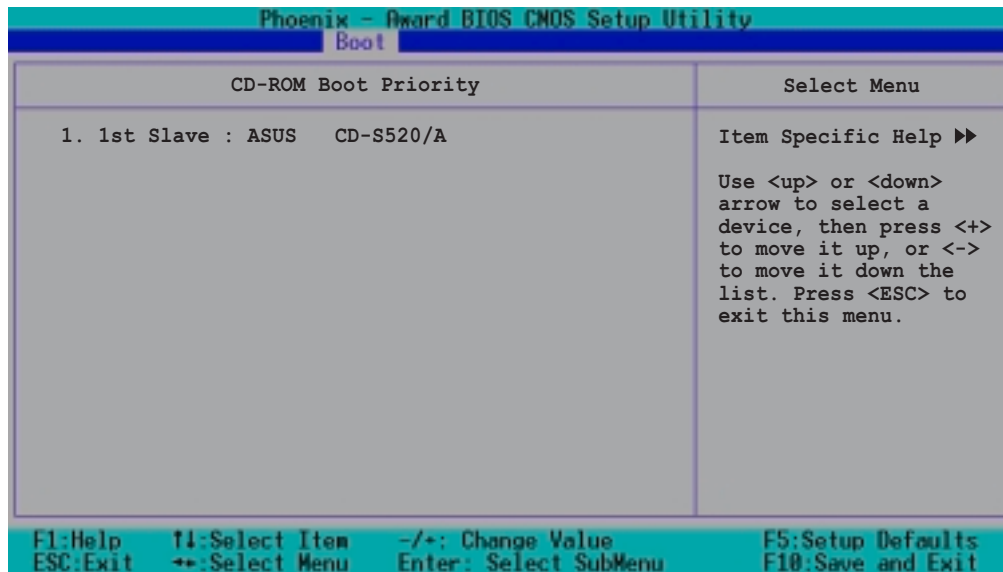

4.6.5 Boot Settings Configuration

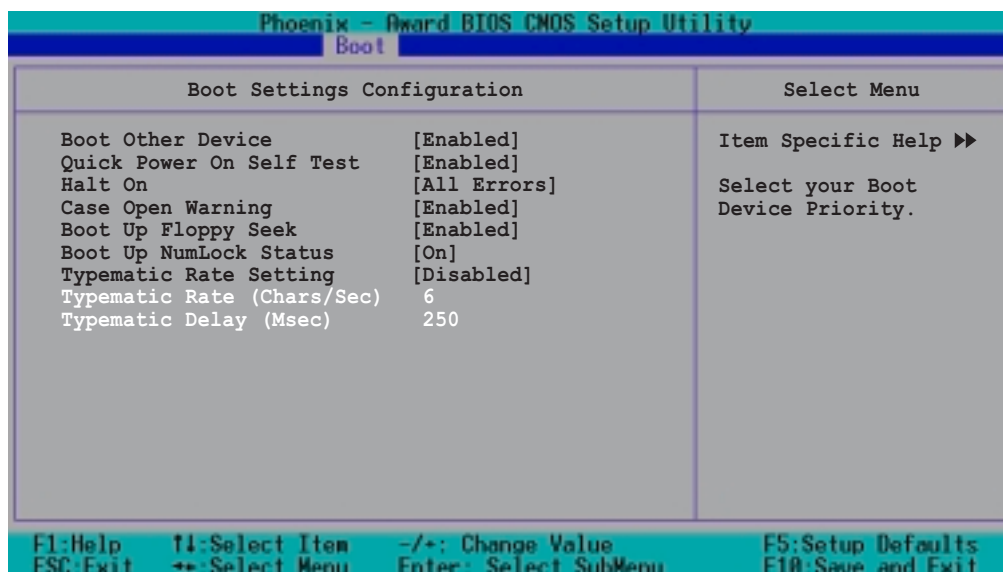

Boot Other Device [Enabled]

Allows you to enable or disable selection of other boot device.

Configuration options: [Disabled] [Enabled]

Quick Power On Self Test [Enabled]

This field speeds up the Power-On-Self Test (POST) routine by skipping retesting a second, third, and fourth time. Configuration options: [Disabled] [Enabled]

Halt On [All Errors]

Sets the system to halt on errors according to the system functions specified in each option. Configuration options: [All Errors] [No Errors] [All, But Keyboard] [All , But Diskette] [All, But Disk/Key]

Case Open Warning [Enabled]

Allows you to enable or disable the case open status feature. Setting to [Enabled] clear the case open status. Configuration options: [Disabled] [Enabled]

Boot Up Floppy Seek [Enabled]

When enabled, the BIOS will seek the floppy disk drive to determine whether the drive has 40 or 80 tracks. Configuration options: [Disabled] [Enabled]

Boot Up NumLock Status [On]

Allows you to select the power-on state for the NumLock. Configuration options: [Disabled] [Enabled]

Typematic Rate Setting [Disabled]

Allows you to enable or disable the keyboard typematic rate setting. Set to [Enabled] to configure the Type Rate and Type Delay items. Configuration options: [Disabled] [Enabled]



The items **Typematic Rate (Chars/Sec)** and **Typematic Delay** become configurable only when the item Typematic Setting is enabled.

Typematic Rate (Chars/Sec) [6]

Allows you to select the rate at which character repeats when you hold a key. Configuration options: [6] [8] [10] [12] [15] [20] [24] [30]

Typematic Delay (Msec) [250]

Allows you to set the delay before key strokes begin to repeat. Configuration options: [250] [500] [750] [1000]

4.6.6 Security

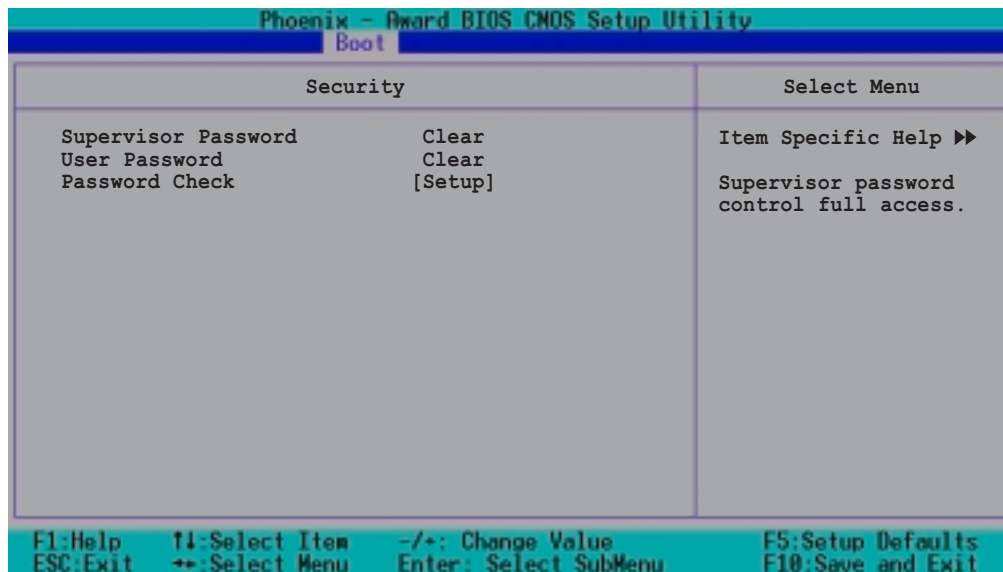

Supervisor Password [Enter] User Password [Enter]

These fields allow you to set passwords.

To set a password:

1. Highlight an item then press <Enter>.
2. Type in a password using eight (8) alphanumeric characters, then press <Enter>.
3. When prompted, confirm the password by typing the exact characters again, then press <Enter>. The password field setting is changed to [Set].

To clear the password:

1. Highlight the password field, and press <Enter> twice. The following message appears:
"PASSWORD DISABLED!!! Press any key to continue..."
2. Press any key to return to the menu.

A note about passwords

The Supervisor password is required to enter the BIOS Setup program preventing unauthorized access. The User password is required to boot the system preventing unauthorized use.

Forgot the password?

If you forget your password, you can clear it by erasing the CMOS Real Time Clock (RTC) RAM. The RAM data containing the password information is powered by the onboard button cell battery. If you need to erase the CMOS RAM, refer to section “2.6 Jumpers” for instructions.

Password Check [Setup]

This field requires you to enter the password before entering the BIOS setup or the system. Select [Setup] to require the password before entering the BIOS Setup. Select [System] to require the password before entering the system. Configuration options: [Setup] [System]

4.7 Exit menu

The Exit menu items allow you to load the BIOS setup default settings, save or discard any changes you made, or exit the Setup utility.

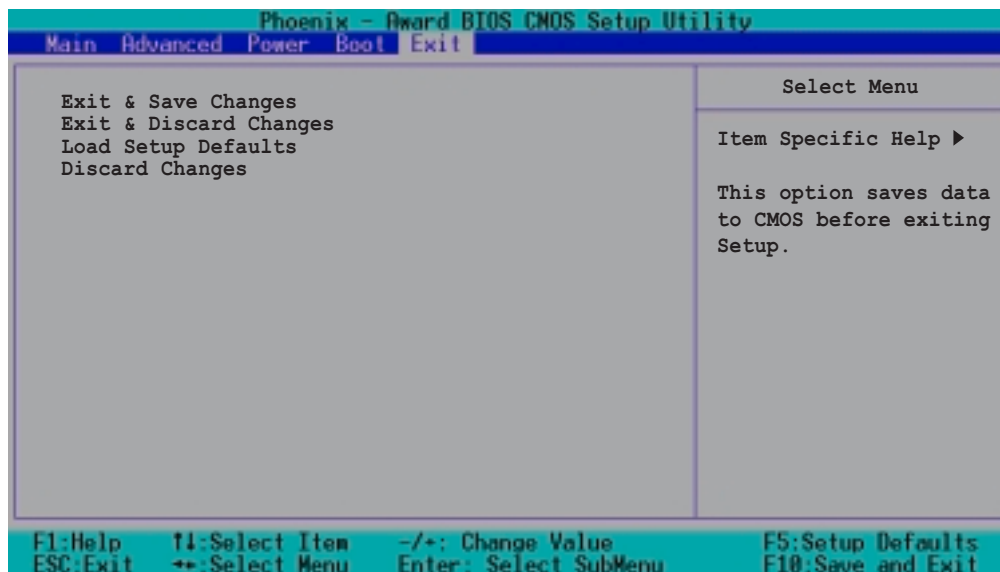

Exit & Save Changes

Select this option then press Enter, or simply press <F10>, to save your changes to CMOS before exiting the Setup utility. When a confirmation window appears, type [Y] to save and exit, or [N] to cancel and return to the menu.

Exit & Discard Changes

Select this option then press Enter if you wish to exit the Setup utility without saving your changes. When a confirmation window appears, type [Y] to exit and discard your changes, or [N] to cancel and return to the menu.

Load Setup Defaults

Select this option then press Enter, or simply press <F5>, to load the optimized values for each of the Setup menu items. When a confirmation window appears, type [Y] to load the default values, or [N] to cancel and return to the menu.

Discard Changes

Select this option to discard the changes that you made, and restore the previously saved values. When a confirmation appears, type [Y] to discard any changes and load the previously saved values, or [N] to cancel and return to the menu.

Appendix

This appendix includes additional information that you may refer to when configuring the motherboard.

Reference information

Appnedix summary

A-1 Block diagram A-1

A.1 PSCH-SR block diagrams

IDE model

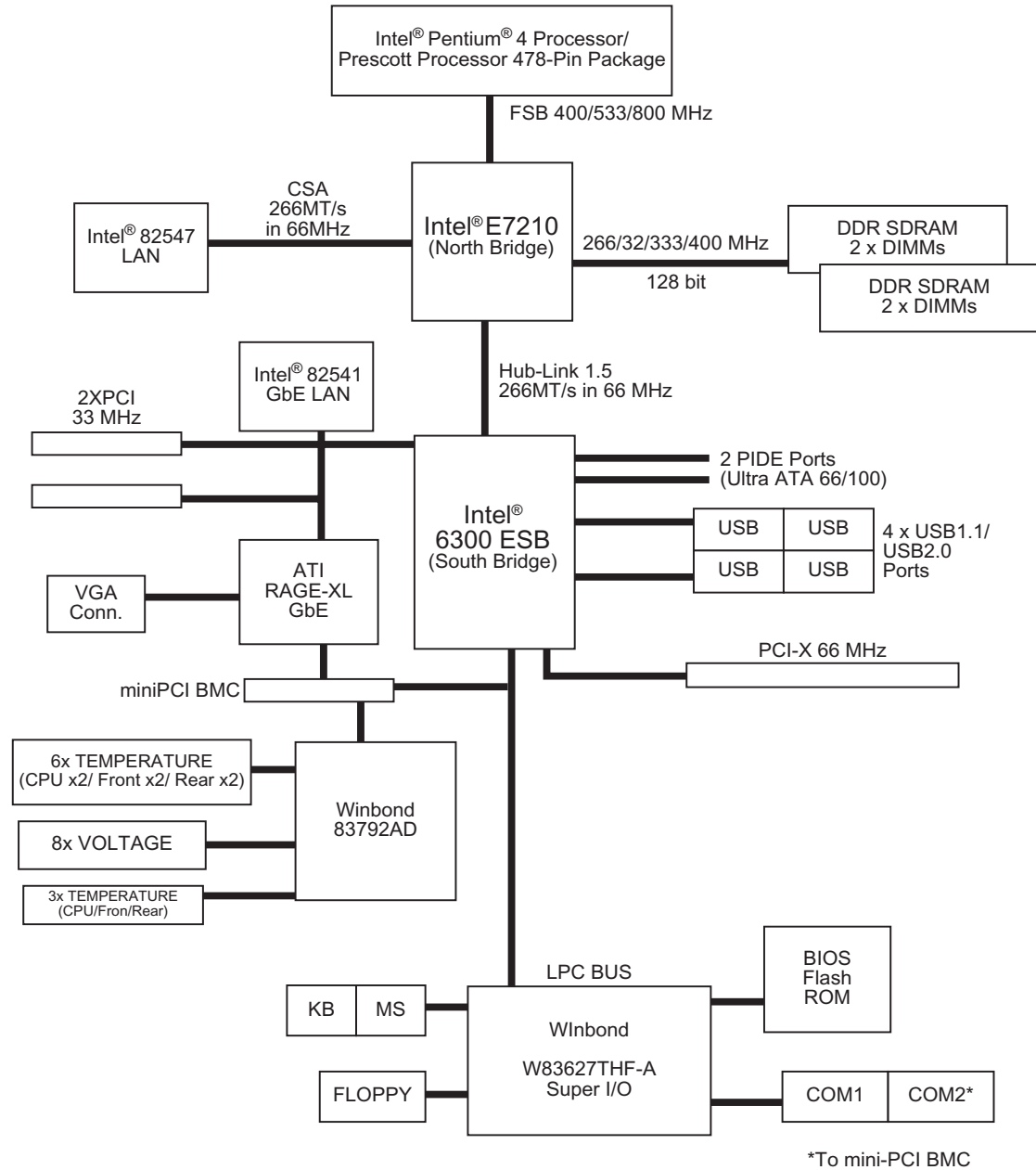

SATA model

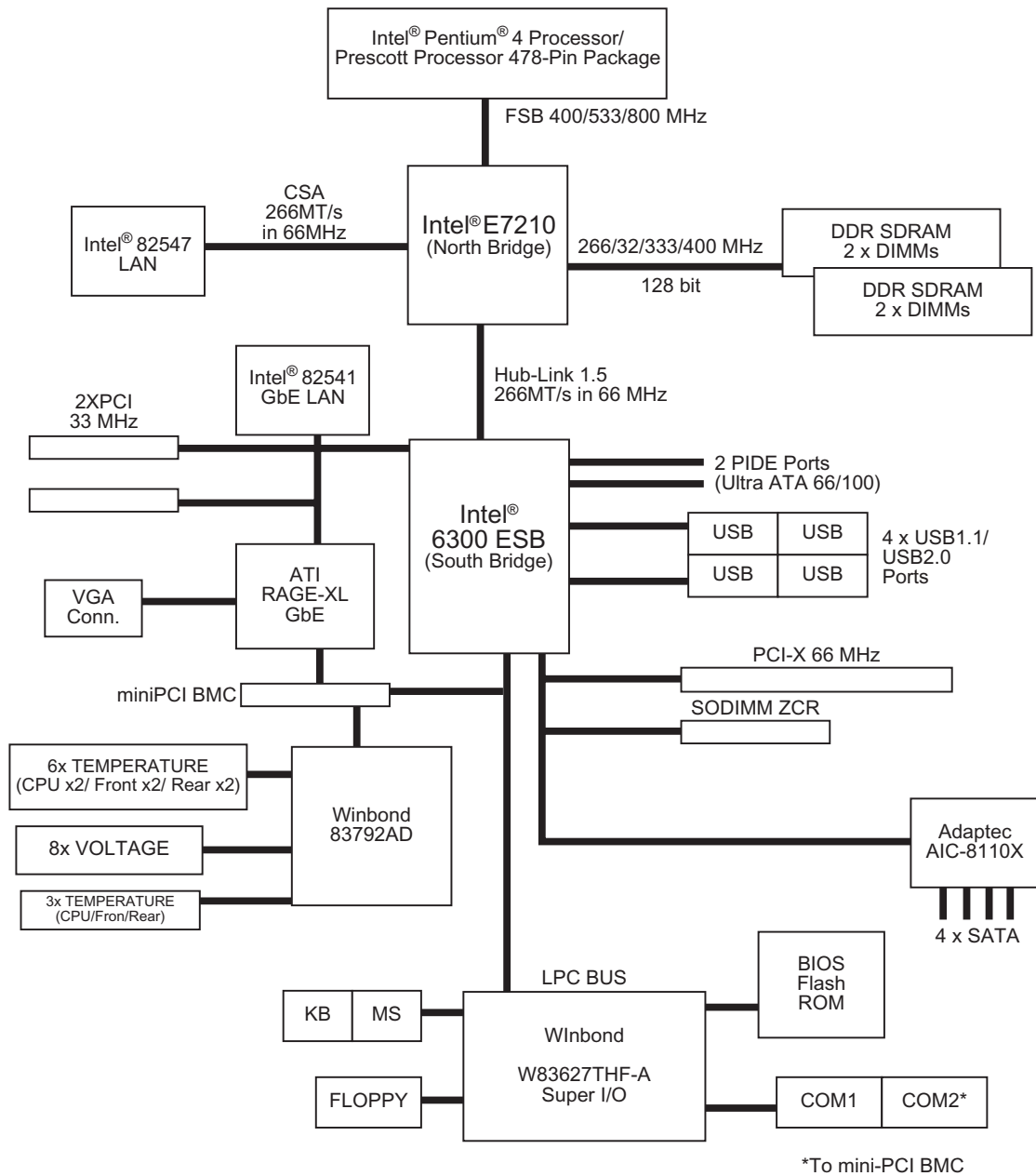

SCSI model

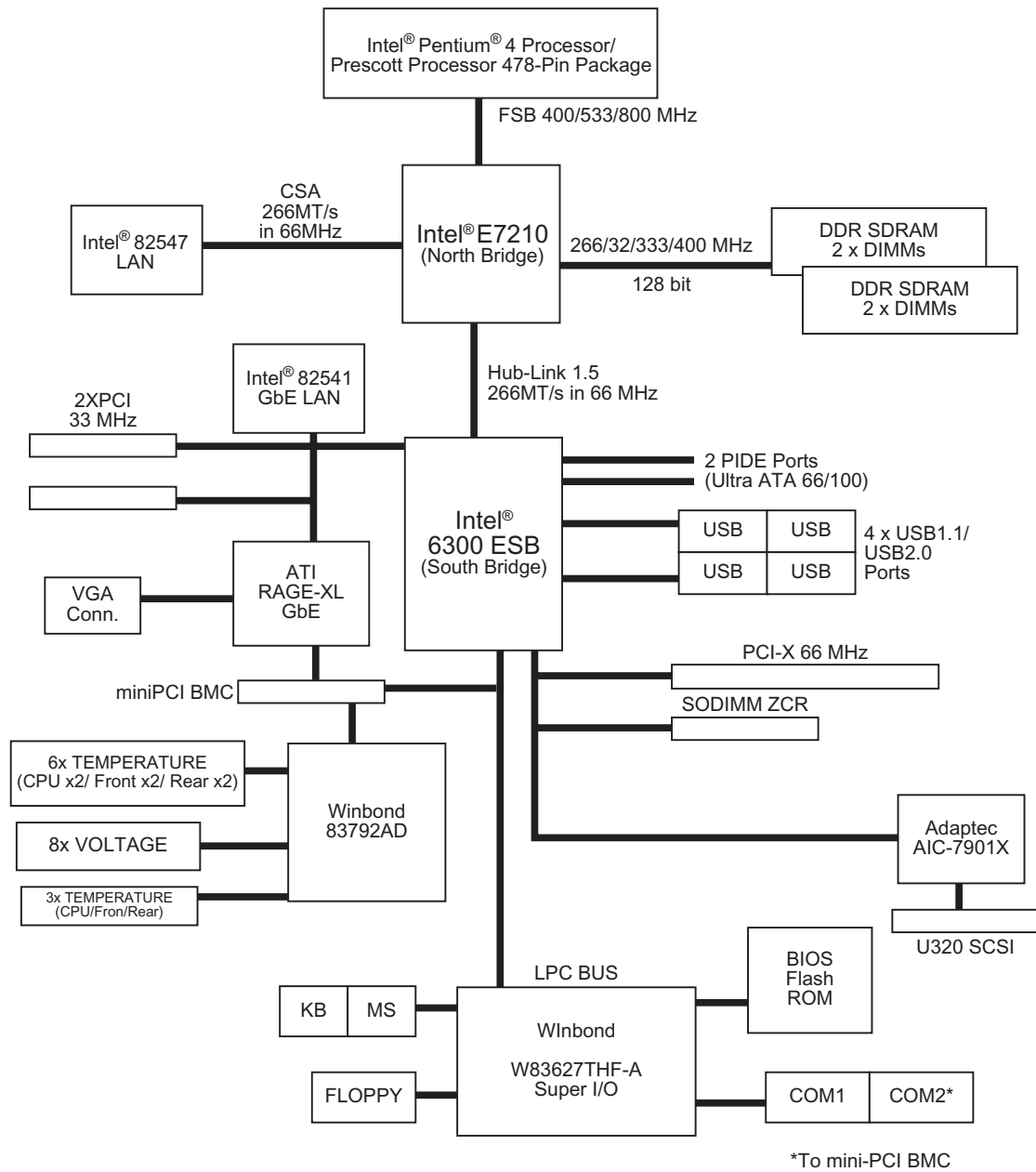

*To mini-PCI BMC

