

# Panasonic®

Operating Instructions  
使用说明书  
AC/Rechargeable Shaver  
交流 / 充电式剃须刀

Model No. ES8253  
型号

<b>English</b>	<b>2</b>
<b>中文</b>	<b>7</b>



Before operating this unit, please read these instructions completely and save them.  
在使用本产品前，请仔细阅读本说明书并妥善保管。

## Important

### ► Using the shaver

Caution - The outer foil is very thin and can be damaged if not used correctly. Check that the foil is not damaged before using the shaver. Do not use the shaver if the foil etc. is damaged as you will cut your skin.

### ► Charging the shaver

Do not use any power cord or AC adaptor other than one specifically designed for this model. Plug in the adaptor into a household outlet where there is no moisture and handle it with dry hands. The shaver may become warm during use and charging. However, this is not a malfunction. Do not charge the shaver where it will be exposed to direct sunlight or other heat sources. Hold the adaptor when disconnecting it from the household outlet. If you tug on the power cord, you may damage it. Contact an authorized service center if the power cord gets damaged.

Adequate ambient temperature for charging is 15-35 °C.

If the indicators on the LCD panel do not glow, wait for a short while until it glows.

### ► Cleaning the shaver

Warning - Disconnect the power cord from the shaver before cleaning it to prevent electric shock.

Keep both the inner blades inserted. If only one of the inner blades is inserted, the shaver may be damaged. If you clean the shaver with water, do not use salt water or hot water. Do not soak the shaver in water for a long period of time. Wipe it with a cloth dampened with soapy water. Do not use thinner, benzene or alcohol.

### ► Storing the shaver

Disconnect the power cord when storing the shaver. Do not bend the power cord or wrap it around the shaver. Do not leave this shaver within the reach of small children. Keep these operating instructions in a safe place.

## SPECIFICATIONS

Model: ES8253  
 Rated input: a.c 100-240 V, 150 mA  
 Rated output: d.c 5.7 V, 1.0 A  
 Charging time: 1 hour  
 This product is intended for household use only.

- The unit is applied to the Chinese standard GB4706.1 appendix B, GB4706.9 and Q/(GZ) PEWWBG 6.

## Parts identification

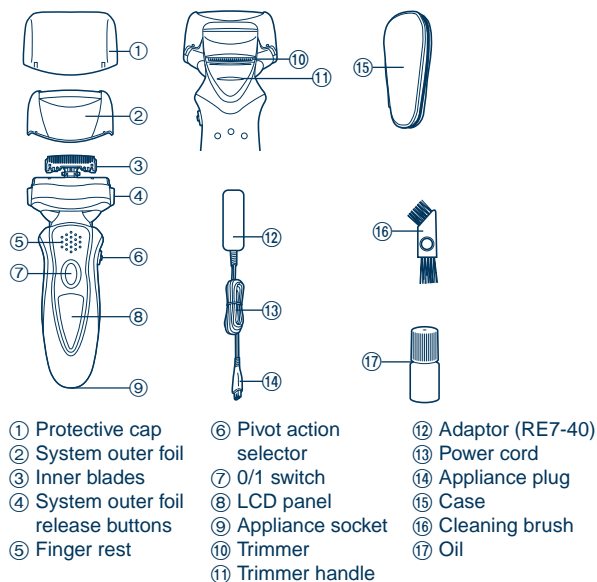

## Charging

- 1 Insert the appliance plug into the shaver.
- 2 Plug in the adaptor into a household outlet.

- The indicators on the LCD panel glow and charging starts.
- Charging is completed when the indicators on the LCD panel blink. (Max. 1 hour later)

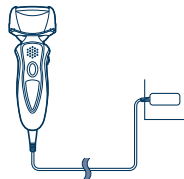

### ► Cord shaving

If you insert the appliance plug to the shaver and plug in the adaptor into a household outlet, you can use it even if the battery capacity is low.

- If the shaver does not work, continue charging it for approx. 1 minute.

## About the LCD panel

The LCD panel shows the remaining battery capacity from 0% to 100%, in 10% increments.

### While charging



The indicators glow.

### After charging is completed



The indicators blink once every second.

### 10 minutes after charging is completed



The indicators blink once every 2 seconds.

### During use



The used time is shown.

- The shown time returns to [0'00"] after 10 minutes.

### After use



The used time and the remaining battery capacity are shown alternately after turning off the shaver.

### When the battery capacity is low



- You can shave 1 to 2 times after "10%" appears. (This will differ depending on usage.)

"10%" appears and blinks.

- A full charge will supply enough power for approx. 14 shaves of 3 minutes each.

## Shave

## Using the shaver

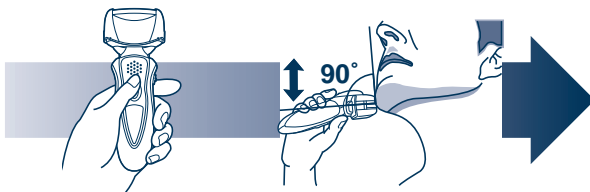

**1** Press the 0/1 switch.

**2** Hold the shaver as illustrated above and shave.

- Start out shaving by applying gentle pressure to your face. Stretch your skin with your free hand and move the shaver back and forth in the direction of your beard. You may gently increase the amount of pressure as your skin becomes accustomed to this shaver. Applying excessive pressure does not provide a closer shave.

▶ **Pivot action selector**

Use to select "SOFT" (soft) or "LOCK" (lock). You can change the pivot action whether the shaver is turned on or off.



▶ **Using the trimmer**

Slide the trimmer handle up. Place at a right angle to your skin and move downwards to trim your sideburns.





4

## Clean

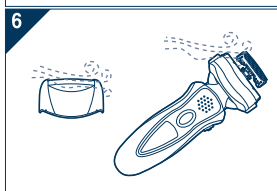
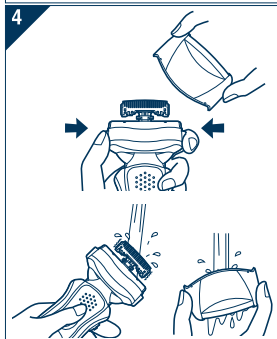
## Cleaning



We recommend that you clean your shaver with the "sonic" vibration turbo-cleaning mode when the faucet symbol  appears on the LCD panel.

1. Disconnect the power cord from the shaver.
2. Apply some hand soap and some water to the outer foil.
3. Press the 0/1 switch for more than 2 seconds to activate the turbo mode for "sonic" vibration cleaning.
  -  appears on the LCD panel.
  - After about 20 seconds, it will be automatically turned off, or you can turn it off by pressing the 0/1 switch.
4. Remove the system outer foil and press the 0/1 switch for more than 2 seconds to activate the turbo mode for "sonic" vibration cleaning and clean it with running water.
5. Wipe off any drops of water with a dry cloth.
6. Remove the system outer foil to allow it to dry completely.



The mark on the left is for a washable shaver and indicates it can be cleaned with water.

### Caution for turbo mode

- Shaving in turbo mode may damage your skin. Turn the shaver off and then on again to cancel turbo mode.
- Do not place your fingers on the 0/1 switch while using the shaver. This may cause the shaver to turn off or enter turbo mode. Place your fingers on the finger rest while using the shaver.

### Lubrication

To maintain shaving comfort for a long time, it is recommended that the oil provided with the shaver is used.

1. Switch off the shaver.
2. Apply one drop of oil to each of the outer foils.
3. Raise the trimmer and apply a drop of oil.
4. Switch the shaver on, and run it for approximately five seconds.
5. Switch off the shaver, and wipe off any excess oil from the outer foils with a soft cloth.

## Replacing the system outer foil and the inner blades

 appears on the LCD panel once a year. (This will differ depending on usage.) We recommend checking the system outer foil and the inner blades when it appears.

- Press the 0/1 switch for more than 30 seconds to delete .

system outer foil	once every year
inner blade	once every two years



1. Press the system outer foil release buttons and lift the system outer foil upwards as illustrated.

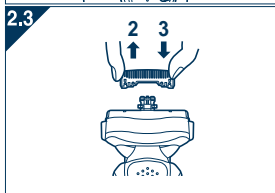

2. Remove the inner blades one at a time as illustrated.
  - Do not touch the edges (metal parts) of the inner blades to prevent injury to your hand.
3. Insert the inner blades one at a time until they click as illustrated.

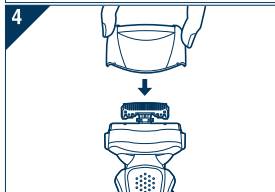

4. Insert the system outer foil by pushing it downwards until it clicks.

## Cleaning with the brush

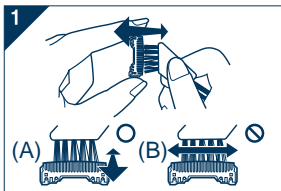

1. Clean the inner blades using the short brush by moving it in direction (A).

Clean the system outer foil, the shaver body and the trimmer using the long brush.

- Do not move the short brush in direction (B) as it will damage the inner blades and affect their sharpness.
- Do not use the short brush to clean the outer foils.

## Removing the built-in rechargeable battery

Remove the built-in rechargeable battery before disposing of the shaver. Please make sure that the battery is disposed of at an officially designated location if there is one. Do not dismantle or replace the battery so that you can use the shaver again. This could cause fire or an electric shock. Replace it at an authorized service center.

- Disconnect the power cord from the shaver when removing the battery.
- Perform steps ① to ⑦ and lift the battery, and then remove it.

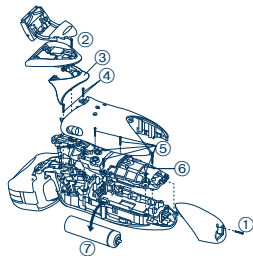

## For environmental protection and recycling of materials

This shaver contains a Lithium-ion battery.

Please make sure that the battery is disposed of at an officially assigned location, if there is one in your country.

## 重要事项

### ▶ 使用剃须刀

注意 - 外刀网很薄, 若使用不正确就可能造成损坏。使用剃须刀前, 请确认刀网是否损坏。如果刀网已损坏请不要使用该剃须刀, 因为这样会割伤皮肤。请勿用于修剪宠物的毛发。

### ▶ 给剃须刀充电

除了为本型号专门设计的充电器, 不要使用其它任何电源线、充电器进行充电。将充电器插入非潮湿的家用插座里, 拿时双手要保持干燥。剃须刀在使用和充电过程中可能会发热。但是, 这不是故障。不要在有阳光直射或其它热源的地方给剃须刀充电。从家用插座上拔出充电器时要抓住充电器。如果用力拉电源线, 可能会损坏电源线。电源软线不能更换, 如果软线损坏, 此充电器应废弃。

充电的合适环境温度为15至35摄氏度。

如液晶显示屏上的指示灯不亮, 稍等片刻直至其亮起。

### ▶ 清洁剃须刀

**警告 - 清洁剃须刀前请断开电源线, 以防触电。**

请在装有两个内刀头的状态进行清洗, 若在仅装有一个内刀头的状态进行清洗, 可能会损坏剃须刀。可用清水清洗剃须刀, 不要使用盐水或热水。不要将剃须刀长时间浸泡在水中。用蘸肥皂水的布擦拭剃须刀。不要使用稀释剂, 汽油或酒精擦拭剃须刀任何部位。

### ▶ 存放剃须刀

存放剃须刀时请拔出电源线。不要折弯电源线或将电源线绕在剃须刀上。请勿将剃须刀放在幼童可以接触到的地方。请妥善保管本产品说明书。请妥善处理本产品的包装袋, 避免婴幼儿窒息等意外发生。

### 规格

型号: ES8253  
额定输入: 交流100-240 V, 150 mA  
额定输出: 直流5.7 V, 1.0 A  
充电时间: 1小时

本产品仅限家庭使用。

• 本产品符合中国标准GB4706.1附录B和GB4706.9及企业标准Q/(GZ)PEWNBG 6。

## 各部分名称

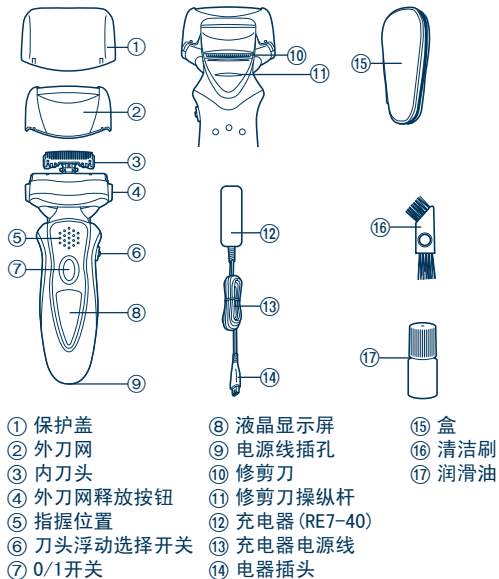

充电

## 充电中

**1** 将充电器电源线插头连接到剃须刀上。

**2** 将充电器插头插入家用电源插座里。

- 液晶显示屏上的指示灯亮，充电开始。
  - 液晶显示屏上的指示灯开始闪烁则表示充电完成。
- (最多1小时后)

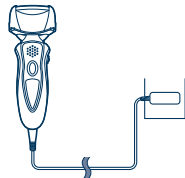

### ▶ 交流电剃须

当电池电量低时，您也可以将剃须刀通过充电器连接至家用电源插座，利用交流电进行剃须。

- 如果剃须刀不能工作，请充电约1分钟后使用。

## 关于液晶显示屏

液晶显示屏显示电池的剩余电量，从0%至100%，每10%一档。

充电时



指示灯亮

充电完成后



指示灯每秒闪烁一次。

充电完成10分钟后



指示灯每两秒闪烁一次。

使用中



显示已使用时间。

- 显示时间在满10分钟后归[0'00"]。

使用后



关闭剃须刀后，已使用时间和剩余电量交替显示。

电池电量不足时



- 电量显示“10%”后您还可以使用剃须刀1到2次。  
(根据使用情况而定。)

显示“10%”，开始闪烁。

- 充足电后大约可提供14次剃须所需的电量。  
(一次剃须约为3分钟)

中文



## 剃须

### 使用剃须刀

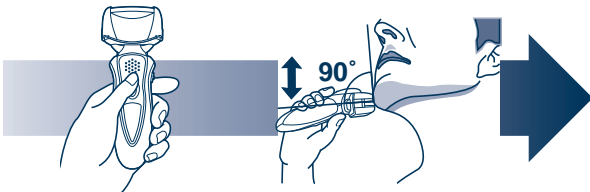

1 按下0/1开关。

2 如上图所示握住剃须刀剃须。

• 轻轻地压向面部开始剃须。用另一只手绷紧脸上皮肤，逆着胡须生长方向前后移动剃须刀。当皮肤适应剃须刀之后您可以稍稍增加压力。但是施加过多的压力不能为您带来更服贴的剃须效果。相反，对初次使用者可能会造成皮肤伤害。

#### ▶ 刀头浮动选择开关

用来选择“SOFT”（柔和）或“LOCK”（锁定）。不论剃须刀是否接通或关闭，你都可以改变刀头浮动模式。



#### ▶ 使用修剪刀

将修剪刀操纵杆往上推，以打开修剪刀。将修剪刀与皮肤成直角（90度）的位置向下移动以修剪鬓角。



## 清洁

### 清洁中

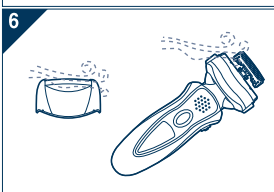

当液晶显示屏上出现时，建议您使用自动清洗·充电装置或“sonic”（声波）振动清洗模式来清洗您的剃须刀。

1. 断开剃须刀的电源线。
2. 在外刀网上涂抹少量洗手液和水。
3. 按下0/1开关2秒钟以上启动声波洗净模式进行“sonic”（声波）振动清洗。
  - 显示在液晶显示屏上。
  - 大约20秒钟后，它会自动关闭，或者按0/1开关关闭它。
4. 取下外刀网，按下0/1开关2秒钟以上启动声波洗净模式进行“sonic”（声波）振动清洗。使用流动水来清洁。
5. 用干布拭去水珠。
6. 取下外刀网使其彻底干燥。



左侧符号表示剃须刀可以全身水洗。

**警告：剃须刀需与电源软线分离后才能用水清洗。**

### 注意声波洗净模式



- 以声波洗净模式剃须可能会损伤皮肤。关闭剃须刀，再打开即可取消声波洗净模式。
- 使用剃须刀时不要将手指放在0/1开关上。这样会导致剃须刀关闭或进入声波洗净模式。使用剃须刀时将手指放在指握位置上。

### 润滑

为长期保持剃须的舒适度，建议使用随剃须刀一起提供的润滑油。

1. 关闭剃须刀。
2. 给每个外刀网涂一滴油。
3. 推起修剪刀并涂一滴油。
4. 接通剃须刀电源，运转约5秒钟。
5. 关闭剃须刀，使用软布从外刀网上拭去多余的润滑油。

### 更换外刀网和内刀头

液晶显示屏上的每年显示一次。（根据使用次数会有所不同。）  
当此信号开始显示时，我们建议您检查本产品的外刀网和内刀头。  
按住0/1按钮30秒以上以清除标识。  
建议外刀网每年更换一次，内刀头每两年更换一次，以维持剃须刀剃须性能。

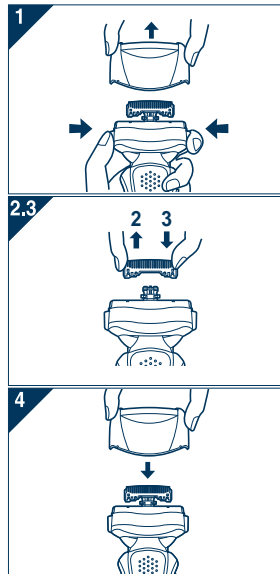

1. 按下按钮，如图示向上提起。
2. 如图示取下内刀头，每次取下一个。
  - 不要触摸内刀头的边沿（金属部分），防止您的手受到损伤。
3. 每次插入一只内刀头，如图所示直到它们卡嗒入位。
4. 向下推入外刀网直至它卡嗒入位。

## 使用刷子清洁

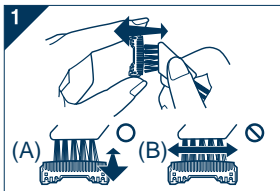

1. 使用短刷，沿图示(A)的移动方向移动，清洁内刀头。  
使用长刷，清洁外刀网，剃须刀机身和修剪刀。
  - 请勿沿(B)方向移动短刷，因为这样将损坏内刀头，影响刀片的锋利度。
  - 请勿使用短刷清洁外刀网。

## 取出内置的可充电电池

本机内藏有可充电的电池，在消费者决定废弃本机前，请务必将电池从机器中取出。

- 分解剃须刀，取出电池前，一定要断开电源。
- 建议消费者在决定废弃剃须刀前，事先征求经销商或本公司指定维修点的意见，尽量延长剃须刀的使用寿命。
- 当消费者决定废弃剃须刀又不想自行分解机器取出电池时，建议消费者将器具送往本公司指定的维修站，由维修店对电池进行分解和回收。
- 电池务必废弃于政府规定的地方或回收处理单位。
- 按右图所示的①~⑦的顺序拆开本体，卸下电池。

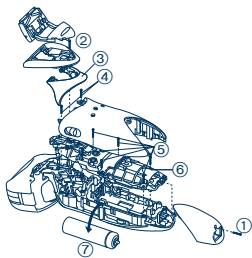

## 环境保护与资源回收

此剃须刀使用锂电池。

如果您的国家有相关规定，请务必在指定处对旧电池进行统一处理。

本机：日本制  
充电器：中国制

中文

**输入公司：松下电工（中国）有限公司**  
**地址：北京市东城区东长安街1号东方广场 东方经贸城西三办公楼201-204室**  
**电话：86-10-85185988**  
**原产地：日本制造**

**制造厂商：松下电工株式会社**  
**地址：日本大阪府门真市门真1048**

**Matsushita Electric Works, Ltd.**  
**1048, Kadoma, Osaka 571-8686, Japan**