

TOSHIBA Photointerrupter Infrared LED + Photo IC

# TLP1004A(F), TLP1005A(F)

Lead Free Product

Home Electric Equipment Such As VCR, CD Player

OA Equipment Such As Copying Machine, Printer, Facsimile, Etc.

Automatic service Equipment Such As Vending Machine,

Various Position Detection

TLP1004A(F) and TLP1005A(F) are digital output photo-interrupters combining GaAs infrared LED with high sensitive and high gain Si photo IC. Directly connectable to TTL, LSTTL and CMOS.

- Printed wiring board direct mounting type
- Gap: 3mm
- Resolution: Slit width 0.5mm
- Digital output (with a pull-up resistor)
  - TLP1004A(F): Low level output at shielding
  - TLP1005A(F): High level output at shielding
- Built-in schmitt circuit
- Threshold input current: 4mA (max.) at Ta = 25°C
- Operating supply voltage: VCC = 4.5V~17V
- High speed response
- Detector side is of visible light cut type

Unit in mm

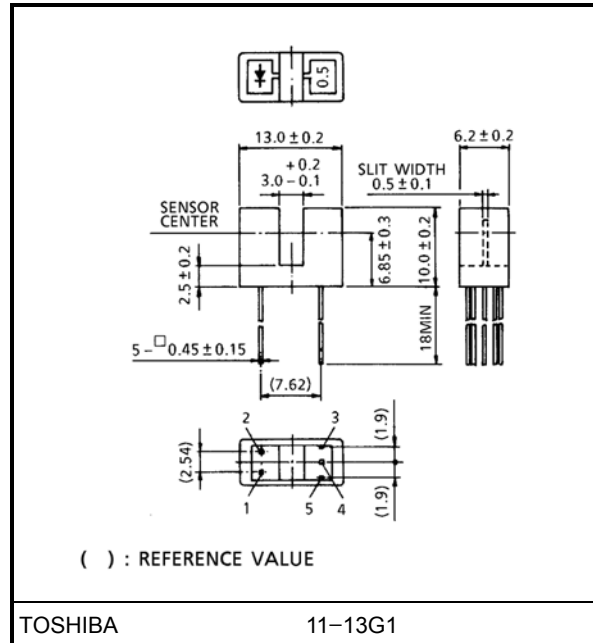

Weight: 0.8g (typ.)

## Pin Connection

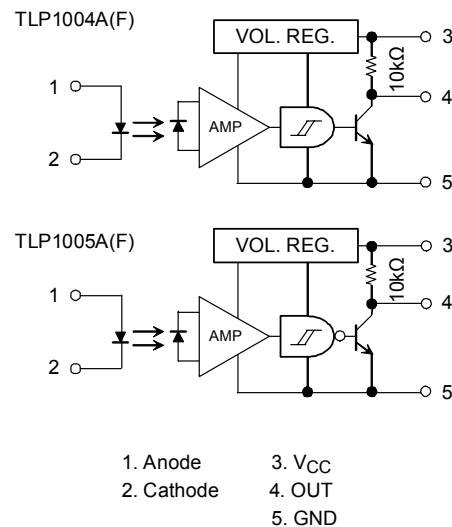

## Maximum Ratings (Ta = 25°C)

Characteristic		Symbol	Rating	Unit
LED	Forward current	$I_F$	50	mA
	Forward current derating (Ta > 25°C)	$\Delta I_F / ^\circ\text{C}$	-0.33	mA / °C
	Reverse voltage	$V_R$	5	V
Detector	Supply voltage	$V_{CC}$	17	V
	Output current	$I_O$	50	mA
	Power dissipation	$P_O$	250	mW
	Power dissipation derating (Ta > 25°C)	$\Delta P_O / ^\circ\text{C}$	-3.33	mW / °C
Operating temperature range		$T_{opr}$	-25~85	°C
Storage temperature range		$T_{stg}$	-40~100	°C
Soldering temperature (5 s)		$T_{sol}$	260	°C

## Recommended Operating Condition

Characteristic	Symbol	Min.	Typ.	Max.	Unit
LED forward current	$I_F$	14*	—	20	mA
Supply voltage	$V_{CC}$	4.5	5.0	17	V
Low level output current	$I_{OL}$	—	—	16	mA
Operating temperature	$T_{opr}$	-25	—	85	°C

\* 14mA is a value considering 50% LED deterioration.  
Initial value of the threshold input current is 7mA.

## Opto-Electrical Characteristics

(unless otherwise specified,  $T_a = -25\text{--}85^\circ\text{C}$ ,  $V_{CC} = 5V \pm 10\%$ )

Characteristic		Symbol	Test Condition	Min.	Typ.	Max.	Unit	
LED	Forward voltage	$V_F$	$I_F = 10\text{mA}$ , $T_a = 25^\circ\text{C}$	1.00	1.15	1.30	V	
	Reverse current	$I_R$	$V_R = 5V$ , $T_a = 25^\circ\text{C}$	—	—	10	$\mu\text{A}$	
	Peak emission wavelength	$\lambda_P$	$I_F = 15\text{mA}$ , $T_a = 25^\circ\text{C}$	—	940	—	nm	
Detector	Operating supply voltage	$V_{CC}$	—	4.5	—	17	V	
	Low level supply current	$I_{CCL}$	$I_F = *1$	—	—	6.0	mA	
			$I_F = *1$ , $V_{CC} = 17V$	—	—	7.5		
	High level supply current	$I_{CCH}$	$I_F = *2$	—	—	3.0	mA	
			$I_F = *2$ , $V_{CC} = 17V$	—	—	3.2		
	Low level output voltage	$V_{OL}$	$I_{OL} = 16\text{mA}$ , $I_F = *1$ $T_a = 25^\circ\text{C}$	—	0.07	0.3	V	
			$I_{OL} = 16\text{mA}$ , $I_F = *1$ $V_{CC} = 17V$	—	—	0.4		
High level output voltage	$V_{OH}$	$I_F = *2$	$0.9V_{CC}$	—	—			
Peak sensitivity wavelength	$\lambda_P$	$T_a = 25^\circ\text{C}$	—	900	—	nm		
Coupled	L → H threshold input current	$I_{FLH}$	$T_a = 25^\circ\text{C}$	TLP1004A(F)	—	—	4	mA
			$V_{CC} = 17V$		—	—	7	
	H → L threshold input current	$I_{FHL}$	$T_a = 25^\circ\text{C}$	TLP1005A(F)	—	—	4	mA
			$V_{CC} = 17V$		—	—	7	
	Hysteresis ratio	$I_{FHL} / I_{FLH}$	—	TLP1004A(F)	—	0.67	—	—
				TLP1005A(F)	—	1.5	—	
	Propagation delay time (L → H)	$t_{pLH}$	$V_{CC} = 5V$ $I_F = 15\text{mA}$ $R_L = 280\Omega$ $T_a = 25^\circ\text{C}$	TLP1004A(F)	—	3	—	$\mu\text{s}$
				TLP1005A(F)	—	6	—	
Propagation delay time (H → L)	$t_{pHL}$	TLP1004A(F)		—	6	—		
		TLP1005A(F)		—	3	—		
Rise time	$t_r$			(Note)	—	0.1	—	
Fall time	$t_f$			(Note)	—	0.05	—	

\*1. 0mA for TLP1004A(F). 15mA for TLP1005A(F)

\*2. 15mA for TLP1004A(F). 0mA for TLP1005A(F).

Note: Switching time test circuit

TLP1004A(F)

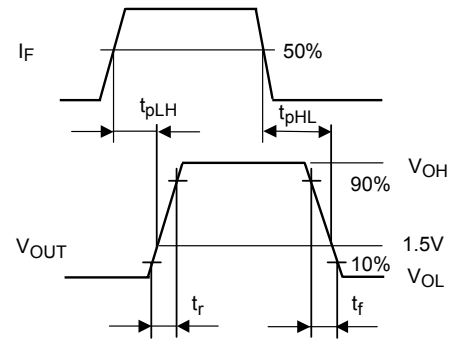
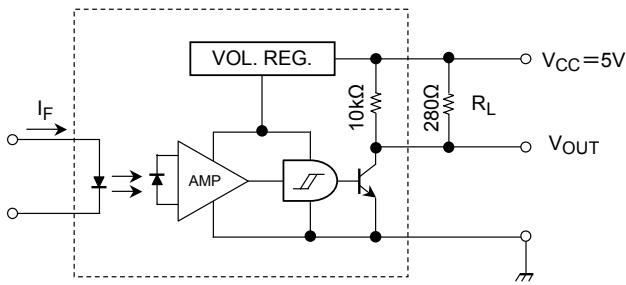

TLP1005A(F)

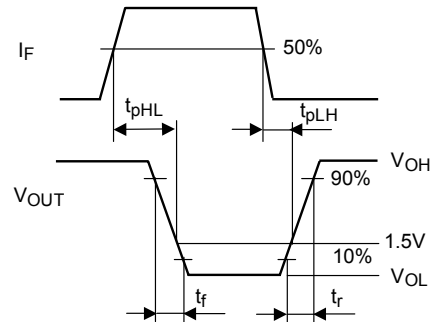
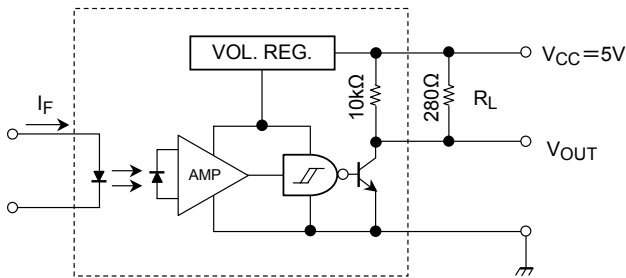

## Product Indication

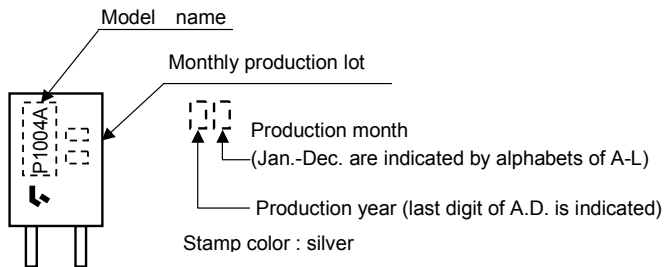

Abbreviation	Type
P1004A	TLP1004A(F)
P1005A	TLP1005A(F)

## Precaution

Please be careful of the followings.

1. Soldering should be performed after lead forming.
2. If chemicals are used for cleaning, the soldered surface only shall be cleaned with chemicals avoiding the whole cleaning of the package.
3. The container is made of polycarbonate. polycarbonate is usually stable with acid, alcohol, and aliphatic hydrocarbons however, with petrochemicals (such as benzene, toluene, and acetone), alkali, aromatic hydrocarbons, or chloric hydrocarbons, polycarbonate becomes cracked, swollen, or melted. Please take care when choosing a packaging material by referencing the table below.

### <Chemicals To Avoid With Polycarbonate>

	Phenomenon	Chemicals
A	Little deterioration but staining	<ul style="list-style-type: none"> <li>• Nitric acid (low concentration), hydrogen peroxide, chlorine</li> </ul>
B	Cracked, crazed, or swollen	<ul style="list-style-type: none"> <li>• Acetic acid (70% or more)</li> <li>• Gasoline</li> <li>• Methyl ethyl ketone, ethyl acetate, butyl acetate</li> <li>• Ethyl methacrylate, ethyl ether, MEK</li> <li>• Acetone, m-amino alcohol, carbon tetrachloride</li> <li>• Carbon disulfide, trichloroethylene, cresol</li> <li>• Thinners, oil of turpentine</li> <li>• Triethanolamine, TCP, TBP</li> </ul>
C	Melted ( ): Used as solvent.	<ul style="list-style-type: none"> <li>• Concentrated sulfuric acid</li> <li>• Benzene</li> <li>• Styrene, acrylonitrile, vinyl acetate</li> <li>• Ethylenediamine, diethylenediamine</li> <li>• (Chloroform, methyl chloride, tetrachloromethane, dioxane, 1, 2-dichloroethane)</li> </ul>
D	Decomposed	<ul style="list-style-type: none"> <li>• Ammonia water</li> <li>• Other alkali</li> </ul>

4. During 100 $\mu$ s after turning on VCC, output voltage changes for stabilizing the inner circuit.
5. Supply the by-pass condenser up to 0.01 $\mu$ F between VCC and GND near device to stabilize the power supply line.

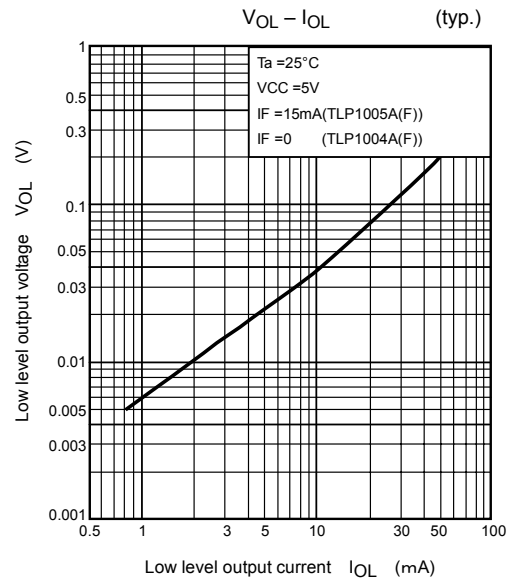
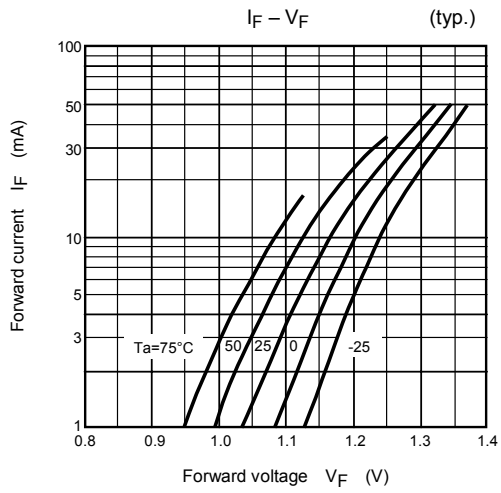
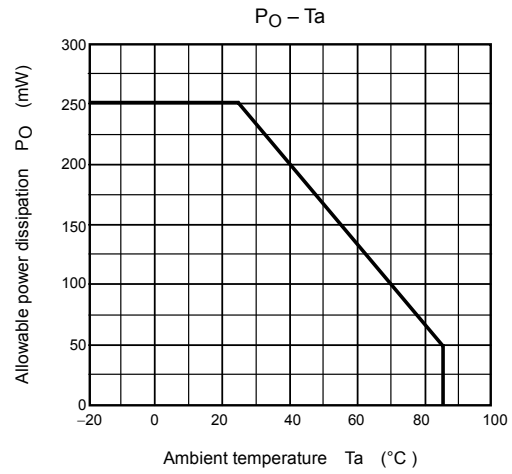
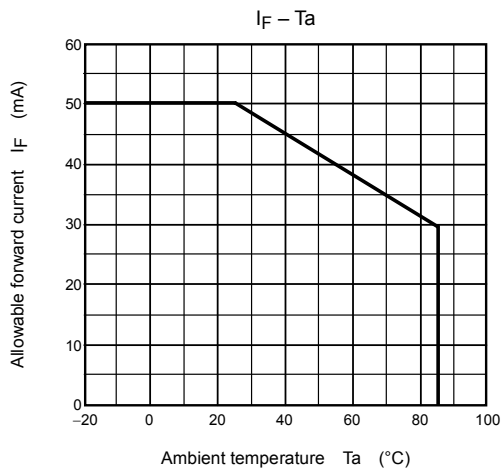

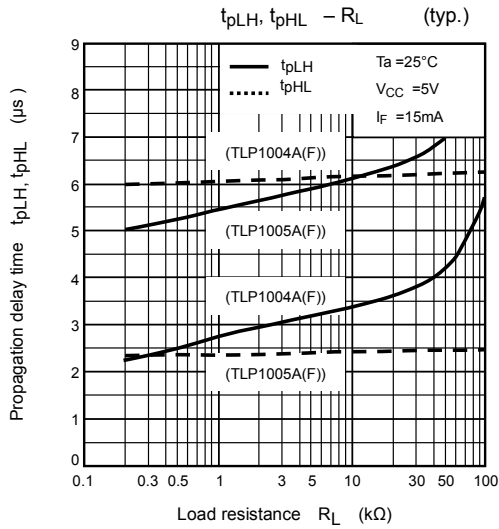
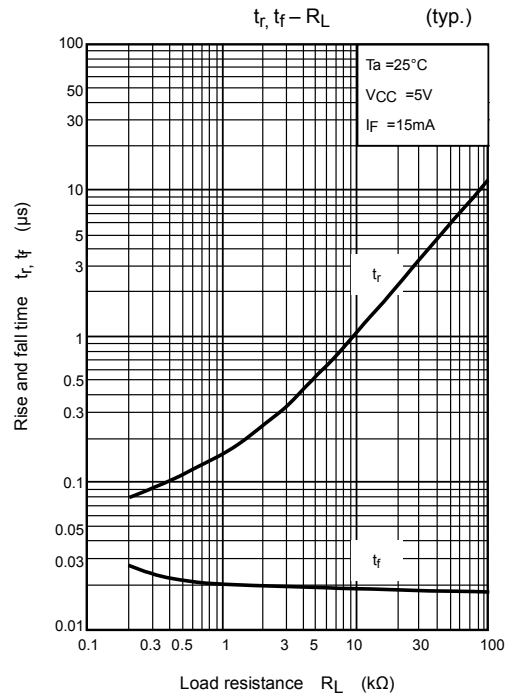
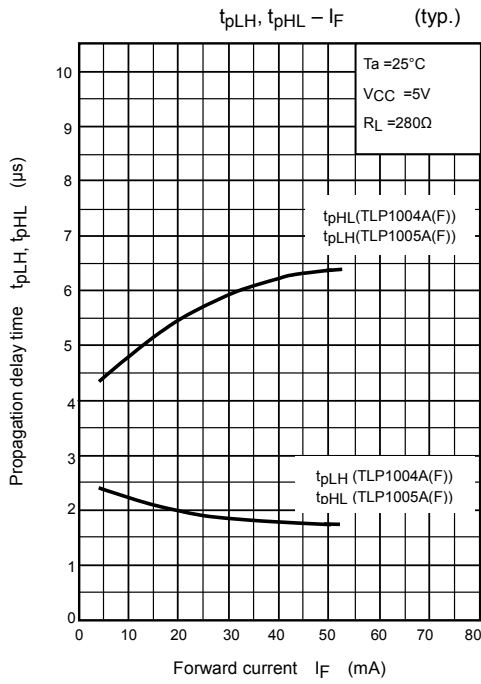

TLP1004A(F) Detecting Position Characteristics (1) (typ.)

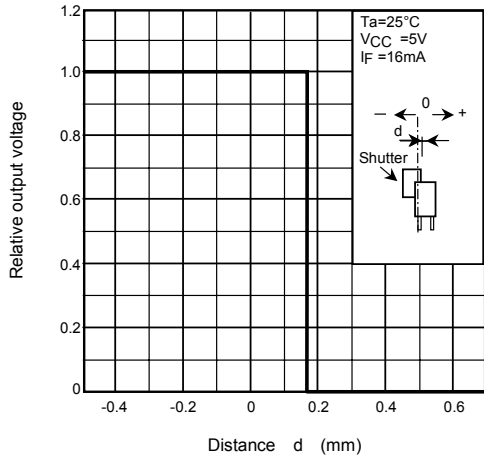

TLP1004A(F) Detecting Position Characteristics (2) (typ.)

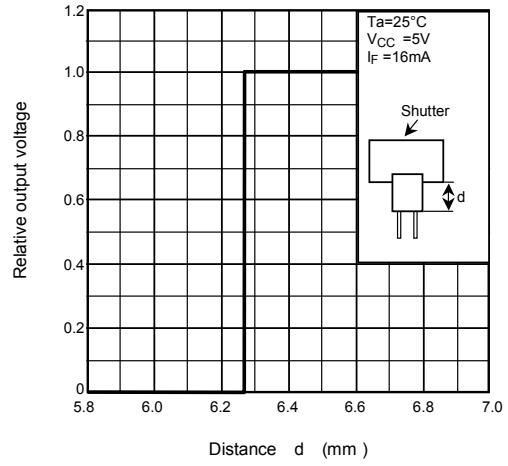

TLP1005A(F) Detecting Position Characteristics (1) (typ.)

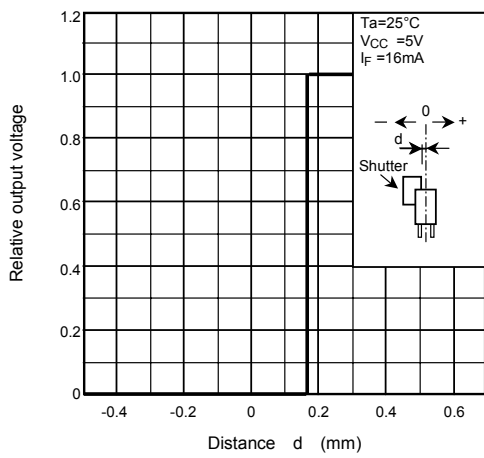

TLP1005A(F) Detecting Position Characteristics (2) (typ.)

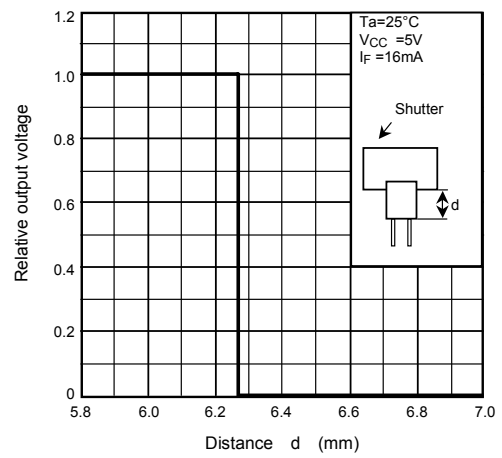



**Positioning Of Shutter And Device**

To operate correctly, make sure that the shutter and the device are positioned as shown in the figure below.  
The slit pitch of the shutter must be set wider than the slit width of the device.  
Determine the width taking the switching time into consideration.

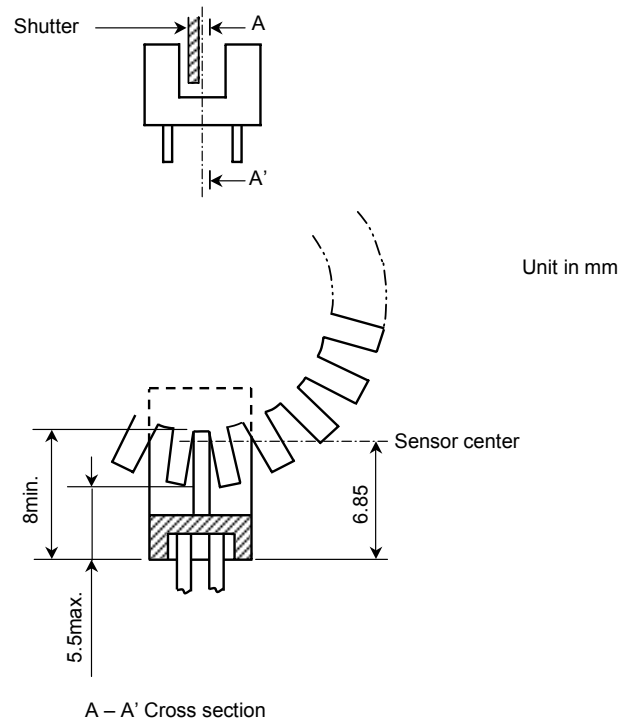

**RESTRICTIONS ON PRODUCT USE**

030619EAC

- The information contained herein is subject to change without notice.
- The information contained herein is presented only as a guide for the applications of our products. No responsibility is assumed by TOSHIBA for any infringements of patents or other rights of the third parties which may result from its use. No license is granted by implication or otherwise under any patent or patent rights of TOSHIBA or others.
- TOSHIBA is continually working to improve the quality and reliability of its products. Nevertheless, semiconductor devices in general can malfunction or fail due to their inherent electrical sensitivity and vulnerability to physical stress. It is the responsibility of the buyer, when utilizing TOSHIBA products, to comply with the standards of safety in making a safe design for the entire system, and to avoid situations in which a malfunction or failure of such TOSHIBA products could cause loss of human life, bodily injury or damage to property.  
In developing your designs, please ensure that TOSHIBA products are used within specified operating ranges as set forth in the most recent TOSHIBA products specifications. Also, please keep in mind the precautions and conditions set forth in the "Handling Guide for Semiconductor Devices," or "TOSHIBA Semiconductor Reliability Handbook" etc..
- The TOSHIBA products listed in this document are intended for usage in general electronics applications (computer, personal equipment, office equipment, measuring equipment, industrial robotics, domestic appliances, etc.). These TOSHIBA products are neither intended nor warranted for usage in equipment that requires extraordinarily high quality and/or reliability or a malfunction or failure of which may cause loss of human life or bodily injury ("Unintended Usage"). Unintended Usage include atomic energy control instruments, airplane or spaceship instruments, transportation instruments, traffic signal instruments, combustion control instruments, medical instruments, all types of safety devices, etc.. Unintended Usage of TOSHIBA products listed in this document shall be made at the customer's own risk.
- TOSHIBA products should not be embedded to the downstream products which are prohibited to be produced and sold, under any law and regulations.
- GaAs(Gallium Arsenide) is used in this product. The dust or vapor is harmful to the human body. Do not break, cut, crush or dissolve chemically.