

# JVC

ENGLISH

DIGITAL MEDIA CAMERA

## GZ-MC500E/EK

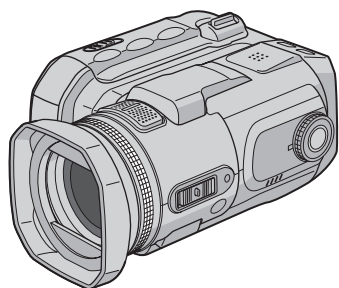

GETTING STARTED 7

---

VIDEO RECORDING &  
PLAYBACK 20

---

STILL IMAGE RECORDING  
& PLAYBACK 25

---

VOICE RECORDING &  
PLAYBACK 29

---

ADVANCED OPERATIONS 31

---

MENU SETTINGS 48

---

REFERENCES 52

---

To deactivate the demonstration,  
set "DEMO MODE" to "OFF".  
(☞ pg. 48)

### INSTRUCTIONS

LYT1424-001A

**EN**

## Major Features of this Camera

### Removable Hard Disk

In contrast to conventional digital video cameras that record to DV tapes, the removable hard disk is a new type of card media that enables extended hours of high-resolution, MPEG2 video recording. (☞ pg. 6)

### Various Recording Media and Modes

Video and still images can be recorded to CompactFlash card (CF card) and SD memory card. The removable hard disk (provided) or Microdrive® is a type of CF card compliant with CF+ Type II.

You can select the most suitable recording medium and mode for picture quality, image size, recording time, and computer environment. (☞ pg. 62)

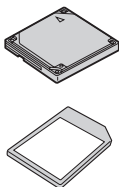

### Voice Recording Features

The camera can be used as a voice recorder for audio recordings. (☞ pg. 29)

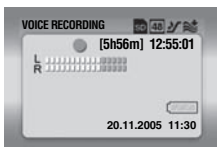

### Various Recording Features

The camera supports aperture-priority, shutter-priority, portrait, bracket shooting, and a wide range of other functions that you can select according to the scene you are shooting. (☞ pg. 31 – 36)

### Enjoying Various Playback Features

Unlike tape operation, playback is simple and easy in this camera since no time is needed for rewinding or fast forward operations.

Playlist, playback effects, and other functions are also available for enjoying many different types of playback.

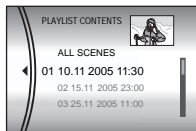

### Editing Files on your PC

USB 2.0 enables the smooth transfer of video and still images to a computer. With the bundled Cyberlink software, you can easily edit video and create your own DVDs. (Refer to the software installation and USB connection guide.)



### Direct Printing

If your printer is compatible with PictBridge, still images can be printed easily by connecting the camera with USB cable directly to the printer. (☞ pg. 47)

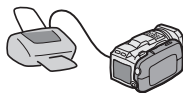

## Contents

### GETTING STARTED 7

Provided Accessories .....	7
Index .....	10
Power .....	14
Operation Mode .....	16
Language Setting .....	16
Date/Time Settings .....	17
Inserting/Removing a CF Card .....	17
Inserting/Removing an SD Card .....	18
Formatting a Recording Medium .....	19
Selecting Recording Medium .....	19

### VIDEO RECORDING & PLAYBACK 20

Video Recording .....	20
Zooming .....	21
Angle Adjustment .....	21
Video Playback .....	22
How to Use the Scroll Bar .....	22
Various Playback Operations .....	23
Playback Zoom .....	23
Connecting to a TV or VCR .....	24
Playback on a TV .....	24
Dubbing to a VCR .....	24

### STILL IMAGE RECORDING & PLAYBACK 25

Still Image Recording .....	25
Zooming .....	25
Continuous Shooting .....	26
Flash .....	26
Still Image Playback .....	27
Slide Show .....	27
Index Screen of Still Image Files .....	27
How to Use the Scroll Bar .....	28
Image Rotation .....	28
Playback Zoom .....	28

### VOICE RECORDING & PLAYBACK 29

Voice Recording .....	29
Voice Playback .....	30
Various Playback Operations .....	30

### ADVANCED OPERATIONS 31

#### RECORDING FEATURES 31

Backlight Compensation .....	31
Spot Exposure Control .....	31
Program AE .....	31
Bracket Shooting .....	33
Manual Focus .....	33
Manual Settings in MSET Menu .....	34
How to Select a Menu Item .....	34
Manual Exposure .....	35
White Balance .....	35
Effect .....	36

#### PLAYBACK FEATURES 37

Wipe or Fader Effects .....	37
Playback Effects .....	37

#### MANAGING FILES 38

Viewing File Information .....	38
Protecting Files .....	39
Deleting Files .....	40
Cleaning Up a Recording Medium .....	41
Copying/Moving Still Image Files .....	41
Resetting the File Number .....	42
Creating Play List .....	43
Playing Back Play List .....	44
DPOF Print Setting .....	46
Direct Printing with a PictBridge Printer .....	47

#### MENU SETTINGS 48

Changing the Menu Settings .....	48
Common Menus for All Modes .....	48
Video Recording Menus .....	50
Video Playback Menus .....	50
Still Image Recording Menus .....	51
Still Image Playback Menus .....	51
Voice Recording Menus .....	51
Voice Playback Menus .....	51

#### REFERENCES 52

Troubleshooting .....	52
Warning Indications .....	55
Cleaning the Camera .....	57
Cautions .....	57
Specifications .....	60

#### TERMS ..... Back cover

**Dear Customer,**

Thank you for purchasing this digital media camera. Before use, please read the safety information and precautions contained in the pages 4 – 5 to ensure safe use of this product.

**SAFETY PRECAUTIONS****IMPORTANT (for owners in the U.K.)  
Connection to the mains supply in the United Kingdom.****DO NOT cut off the mains plug from this equipment.**

If the plug fitted is not suitable for the power points in your home or the cable is too short to reach a power point, then obtain an appropriate safety approved extension lead or consult your dealer.

**BE SURE to replace the fuse only with an identical approved type, as originally fitted, and to replace the fuse cover.**

If nonetheless the mains plug is cut off be sure to remove the fuse and dispose of the plug immediately, to avoid possible shock hazard by inadvertent connection to the mains supply.

If this product is not supplied fitted with a mains plug then follow the instructions given below:

**DO NOT** make any connection to the Larger Terminal coded E or Green.

The wires in the mains lead are coloured in accordance with the following code:



If these colours do not correspond with the terminal identifications of your plug, connect as follows:

Blue wire to terminal coded N (Neutral) or coloured black.

Brown wire to terminal coded L (Live) or coloured Red.

If in doubt — consult a competent electrician.

**WARNING: TO PREVENT FIRE OR SHOCK HAZARD, DO NOT EXPOSE THIS UNIT TO RAIN OR MOISTURE.****CAUTIONS:**

- To prevent shock, do not open the cabinet. No user serviceable parts inside. Refer servicing to qualified personnel.
- When you are not using the AC adapter for a long period of time, it is recommended that you disconnect the power cord from AC outlet.

**CAUTION:**

To avoid electric shock or damage to the unit, first firmly insert the small end of the power cord into the AC Adapter until it is no longer wobbly, and then plug the larger end of the power cord into an AC outlet.

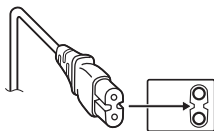
**CAUTIONS:**

- This camera is designed to be used with PAL-type colour television signals. It cannot be used for playback with a television of a different standard. However, live recording and LCD monitor playback are possible anywhere.
- Use the JVC BN-VM200U battery pack and, to recharge it or to supply power to the camera from an AC outlet, use the provided multi-voltage AC adapter. (An appropriate conversion adapter may be necessary to accommodate different designs of AC outlets in different countries.)

**NOTES:**

- The rating plate (serial number plate) and safety caution are on the bottom and/or the back of the main unit.
- The rating information and safety caution of the AC adapter are on its upper and lower sides.

Do not point the lens directly into the sun. This can cause eye injuries, as well as lead to the malfunctioning of internal circuitry. There is also a risk of fire or electric shock.

**CAUTION!**

The following notes concern possible physical damage to the camera and to the user.

Do not use a tripod on unsteady or unlevel surfaces. It could tip over, causing serious damage to the camera.

**CAUTION!**

Connecting cables (Audio/Video, S-Video, etc.) to the camera and leaving it on top of the TV is not recommended, as tripping on the cables will cause the camera to fall, resulting in damage.



When the equipment is installed in a cabinet or on a shelf, make sure that it has sufficient space on all sides to allow for ventilation (10 cm or more on both sides, on top and at the rear).

Do not block the ventilation holes.  
(If the ventilation holes are blocked by a newspaper, or cloth etc. the heat may not be able to get out.)

No naked flame sources, such as lighted candles, should be placed on the apparatus.

When discarding batteries, environmental problems must be considered and the local rules or laws governing the disposal of these batteries must be followed strictly.

The apparatus shall not be exposed to dripping or splashing.

Do not use this equipment in a bathroom or places with water.

Also do not place any containers filled with water or liquids (such as cosmetics or medicines, flower vases, potted plants, cups etc.) on top of this unit.  
(If water or liquid is allowed to enter this equipment, fire or electric shock may be caused.)

## SOME DO'S AND DON'TS ON THE SAFE USE OF EQUIPMENT

**This equipment has been designed and manufactured to meet international safety standards but, like any electrical equipment, care must be taken if you are to obtain the best results and safety is to be assured.**

**DO** read the operating instructions before you attempt to use the equipment.

**DO** ensure that all electrical connections (including the mains plug, extension leads and interconnections between pieces of equipment) are properly made and in accordance with the manufacturer's instructions. Switch off and withdraw the mains plug when making or changing connections.

**DO** consult your dealer if you are ever in doubt about the installation, operation or safety of your equipment.

**DO** be careful with glass panels or doors on equipment.

**DON'T** continue to operate the equipment if you are in any doubt about it working normally, or if it is damaged in any way — switch off, withdraw the mains plug and consult your dealer.

**DON'T** remove any fixed cover as this may expose dangerous voltages.

**DON'T** leave equipment switched on when it is unattended unless it is specifically stated that it is designed for unattended operation or has a standby mode. Switch off using the switch on the equipment and make sure that your family knows how to do this. Special arrangements may need to be made for infirm or handicapped people.

**DON'T** use equipment such as personal stereos or radios so that you are distracted from the requirements of road safety. It is illegal to watch television whilst driving.

**DON'T** listen to headphones at high volume, as such use can permanently damage your hearing.

**DON'T** obstruct the ventilation of the equipment, for example with curtains or soft furnishings. Overheating will cause damage and shorten the life of the equipment.

**DON'T** use makeshift stands and NEVER fix legs with wood screws — to ensure complete safety always fit the manufacturer's approved stand or legs with the fixings provided according to the instructions.

**DON'T** allow electrical equipment to be exposed to rain or moisture.

### ABOVE ALL

- NEVER let anyone especially children push anything into holes, slots or any other opening in the case — this could result in a fatal electrical shock;
- NEVER guess or take chances with electrical equipment of any kind — it is better to be safe than sorry!

## Before Using this Camera

**This camera is designed exclusively for CompactFlash Card (CF card) and SD Memory Card.**

**The removable hard disk (provided) or Microdrive® is a type of CF card compliant with CF+ Type II.**

**This camera records video in MPEG2 format compliant with SD-VIDEO format.**

**Remember that this camera is not compatible with other digital video formats.**

**Remember that this camera is intended for private consumer use only.**

Any commercial use without proper permission is prohibited. (Even if you record an event such as a show, performance or exhibition for personal enjoyment, it is strongly recommended that you obtain permission beforehand.)

### Before recording important video, be sure to make a trial recording.

Play back your trial recording to make sure the video and audio have been recorded properly.

### Make a backup of important recorded data

Protect your important recorded data by copying the files to PC. It is recommended to copy it from your PC to a DVD or other recording media for storage. Refer to the software installation and USB connection guide.

### Bring your camera together with the removable hard disk

When requesting repairs for breakdowns by your dealer or JVC service centre, be sure to bring your camera together with the removable hard disk. If one of them is not included, the cause cannot be diagnosed, and the repair cannot be made properly.

Also read "Cautions" on pages 57 to 59.

- Manufactured under license from Dolby Laboratories. "Dolby" and double-D symbol are trademarks of Dolby Laboratories.
- Microdrive<sup>®</sup> is a registered trademark of Hitachi Global Storage Technologies, Inc. in the United States and/or other countries.
-  MascotCapsule is registered trademark of HI CORPORATION in Japan. Copyright © 2001 HI CORPORATION. All rights reserved.
- Other product and company names included in this instruction manual are trademarks and/or registered trademarks of their respective holders.

## Removable Hard Disk

**The removable hard disk is a precision electronic device. Be careful when handling it.**

### Cautions for external jolt or stress

- After removing the disk from the camera, store it by inserting into the supplied protective case.
- Do not press on the cover.
- Do not subject the disk to vibrations or sudden jolts. Be especially careful to avoid sudden jolts when shooting or during playback.
- Do not affix stickers or write on the label.
- Do not apply strong pressure to the outside of the disk. Also, do not put it in your pants pocket or other location where it can be pressed on.



### Cautions for temperature

- The camera's protection circuit may work for the proper recording or playback when the camera's internal temperature rises or during usage in a cold location. (⇨ pg. 56)

- The camera and removable hard disk can heat up when used for an extended period. However, this is not a malfunction.
- The disk can heat up when used for an extended period. Therefore, do not remove it immediately from the camera.

### Other cautions

- Condensation can cause the drive to break down. If water is splashed on the drive, make sure that it is completely dried before usage.
- Do not use, replace, or store the disk in locations that are exposed to strong static electricity or electrical noise.
- Do not turn off the camera power or remove the battery or AC adapter during shooting, playback, or when otherwise accessing the recording medium.
- Do not bring the recording medium near objects that have a strong magnetic field or that emit strong electromagnetic waves.
- Since data must be read and written by the drive correctly, the camera may be unable to shoot when the camera heats up, such as during continuous shooting, or when the camera is cooled down during usage in a cold location. To fix this problem, follow the messages displayed on the screen. (⇨ pg. 56)
- Clean up the disk regularly to maintain high performance. (⇨ pg. 41, 49)

Also read "Recording Medium" on page 58.

### Be careful to completely delete data when discarding or giving away the removable hard disk.

When recording data is formatted or deleted on the camera, this only modifies the file management information, and the data is not completely erased. When discarding or giving away the removable hard disk, to prevent problems caused by the release of sensitive information, it is extremely important that the customer take responsibility to erase all recorded data. Some recommended methods of erasing data include using a commercial data removal program or using a hammer or strong magnet to physically or magnetically destroy the data on the hard disk so that it cannot be read. JVC shall not be responsible for any personal data that is released.

## Provided Accessories

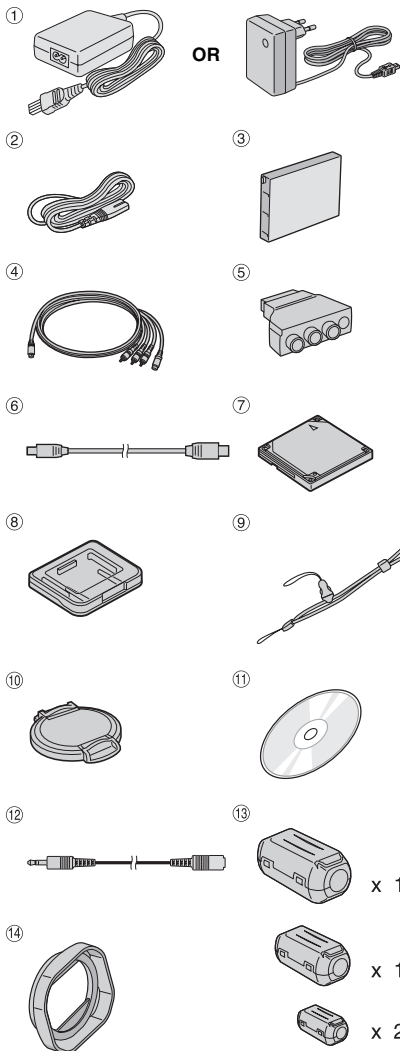

- ① AC Adapter AP-V14E or AP-V17E
- ② Power cord (AP-V14E only)
- ③ Battery Pack BN-VM200U
- ④ S-Video/Audio/Video Cable
- ⑤ Cable Adapter
- ⑥ USB Cable (Refer to the software installation and USB connection guide.)
- ⑦ Removable Hard Disk (4 GB)
- ⑧ Protective Case for Removable Hard Disk
- ⑨ Strap (See page 8 for attachment)
- ⑩ Lens Cap (See page 8 for attachment)
- ⑪ CD-ROM
- ⑫ Audio Extension Cable (for optional headphones, see page 9 for attachment)
- ⑬ Core Filter for Cables (See page 9 for attachment)
  - Large (x 1): S-Video/Audio/Video Cable
  - Medium (x 1): USB Cable
  - Small (x 2): Audio Extension Cable and AC Adapter's Cord
- ⑭ Lens Hood (Already attached to the camera,  pg. 8)

### NOTES:

- In order to maintain optimum performance of the camera, provided cables may be equipped with one or more core filter. If a cable has only one core filter, the end that is closest to the filter should be connected to the camera.
- Make sure to use the provided cables for connections. Do not use any other cables.

The removable hard disk and its protective case are packaged in a silver bag.

## Attaching the Strap

**1** Press and hold both sides as shown, then detach the fastener (large).

**2** Pass the strap ring through the eyelet on the lens side.

**3** Pass through the strap ring.

**4** Pass the fastener's ring through the eyelet on the LCD side.

**5** Pass through the fastener's ring.

**6** Connect the fastener.

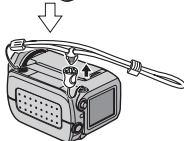
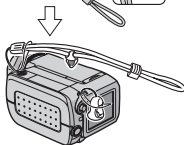
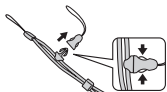

### When shooting

Hold the camera as shown in the illustration, grip it gently so that it feels secure, then adjust the strap.

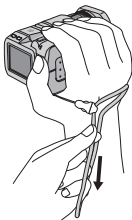

**Pull the strap.**

### To secure the camera so it cannot be dropped during shooting

Detach the fastener from the strap as shown in step 1.

Put your hand through the strap, then secure the strap to your wrist so that the camera cannot be dropped.

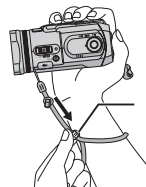

**Slide the fastener.**

## Attaching/Detaching the Lens Hood

The provided lens hood helps block out glare when shooting under bright sunlight, the same way professional photographers do.

### To attach

Align the lens hood with the camera's lens, and then turn the hood clockwise ①.

### To detach

Turn the hood counterclockwise ②.

- Detach the hood only when using the optional conversion lens or lens filter.

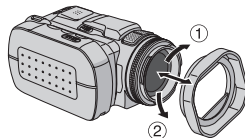

## Attaching the Lens Cap

To protect the lens, attach the provided lens cap to the camera as shown in the illustration.

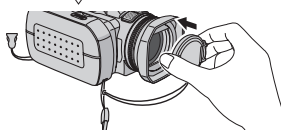
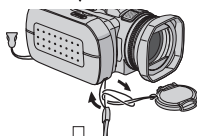
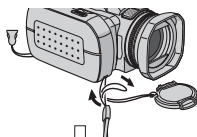

### NOTE:

To confirm the lens cap is on correctly, make sure the cap is flush to the camera.

## Attaching the Core Filter

Attach the core filters to the cables. The core filter reduces interference.

**1** Release the stoppers on both ends of the core filter.

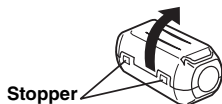

**2** Run the cable through the core filter, leaving approx. 3 cm of cable between the cable plug and the core filter.

Wind the cable once around the outside of the core filter as shown in the illustration.

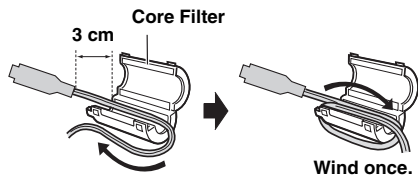

- Wind the cable so that it is not slack.

**3** Close the core filter until it clicks shut.

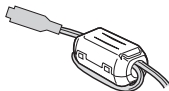

### NOTES:

- Take care not to damage the cable.
- When connecting a cable, attach the end with the core filter to the camera.

## How to Use the Audio Extension Cable

When using optional headphones, connect to the provided audio extension cable (with a core filter attached), then connect the audio extension cable to the camera. The core filter reduces interference.

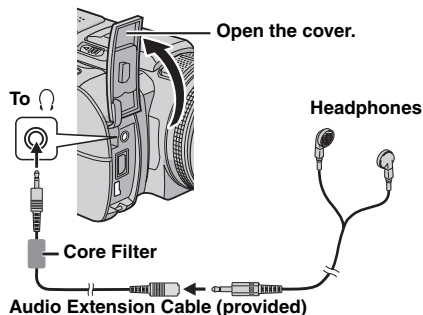



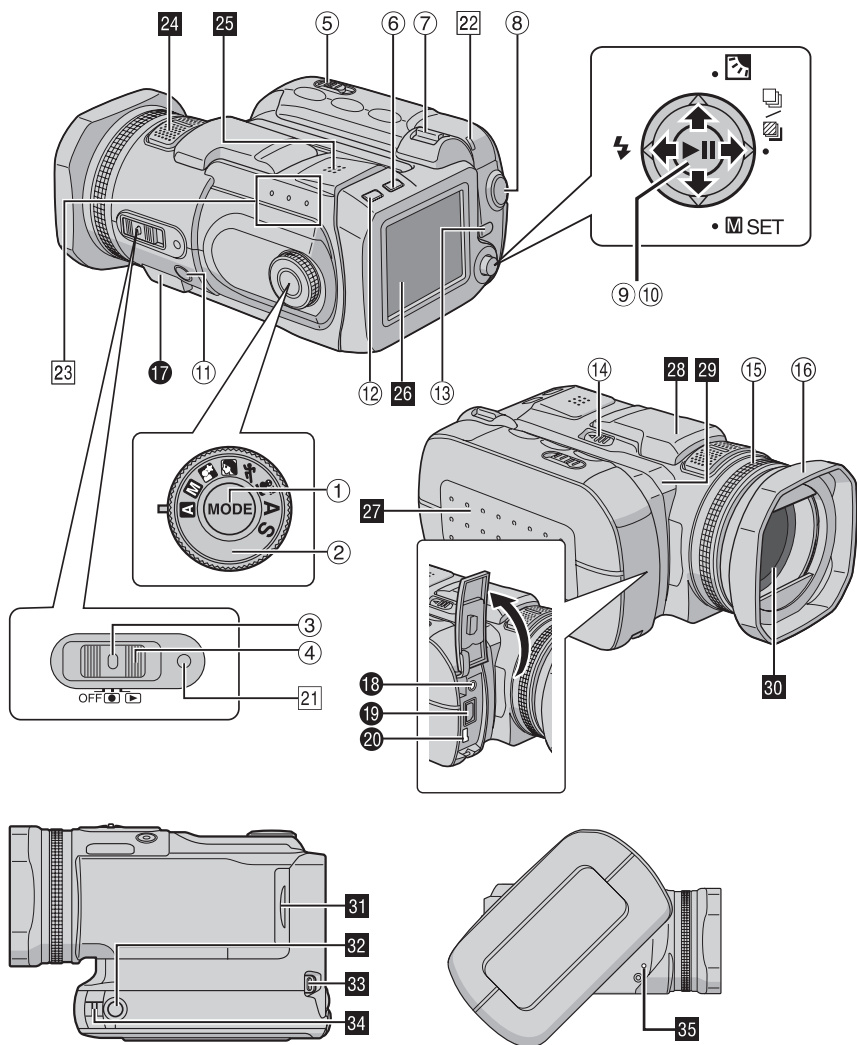

















## Index

**ATTENTION:**

- Be careful not to cover **24**, **29** and **30** during shooting.
- Be careful not to cover **25** during playback.

## Controls



- ① Mode Button [MODE] (⇨ pg. 16)
- ② Recording Mode Dial (⇨ pg. 16, 31 – 32)
- ③ Lock Button (⇨ pg. 16)
- ④ Power Switch [OFF, , ] (⇨ pg. 16)
- ⑤ Battery/CF Card Cover Open Switch [OPEN] (⇨ pg. 14, 17)
- ⑥ Delete Button [] (⇨ pg. 40)
- ⑦ Zoom Lever [T/W] (⇨ pg. 21, 25)  
Speaker Volume Control (⇨ pg. 22, 30)
- ⑧ Recording Start/Stop Button (⇨ pg. 20, 25, 29)
- ⑨ Play/Pause Button [] (⇨ pg. 22, 27, 30)
- ⑩ Multi-Controller
  - ◀: Reverse Search [ ()] (⇨ pg. 23)/Left [/Flash [] (⇨ pg. 26)
  - △: Reverse Skip [ ()] (⇨ pg. 23)/Up []/Backlight Compensation [] (⇨ pg. 31)/Spot Exposure Control (⇨ pg. 31)
  - ▷: Forward Search [ ()] (⇨ pg. 23)/Right []/Continuous Shooting/Bracket Shooting [/] (⇨ pg. 26, 33)
  - ▽: Forward Skip [ ()] (⇨ pg. 23)/Down []/Manual Set [ SET] (⇨ pg. 34)
- ⑪ Focus Button [FOCUS] (⇨ pg. 33)
- ⑫ Information Button [INFO] (⇨ pg. 38)
- ⑬ Menu Button [MENU] (⇨ pg. 48)
- ⑭ Flash Open Switch [FLASH OPEN] (⇨ pg. 26)
- ⑮ Manual Focus Ring (⇨ pg. 33)
- ⑯ Lens Hood (⇨ pg. 8)

## Connectors

The connectors are located beneath the covers.

- ⑰ USB (Universal Serial Bus) Connector (Refer to the software installation and USB connection guide.)
- ⑱ Headphone Connector [] (⇨ pg. 9)
- ⑲ S-Video/Audio/Video Output Connector [AV] (⇨ pg. 24)
- ⑳ DC Input Connector [DC] (⇨ pg. 14)

## Indicators

- ㉑ Power/Charge Lamp (⇨ pg. 14, 16)
- ㉒ Access Lamp (Lights up or blinks when you access to any files. Do not turn off the power or remove the battery pack/AC adapter while accessing to files during recording or playback.)
- ㉓ Mode Lamp [] (video),  (still image),  (voice)] (⇨ pg. 16)

## Other Parts

- ㉔ Stereo Microphone
- ㉕ Speaker (⇨ pg. 22)
- ㉖ LCD Monitor
- ㉗ Battery/CF Card Cover (⇨ pg. 14, 17)
- ㉘ Flash
- ㉙ Camera Sensor
- ㉚ Lens
- ㉛ SD Card Cover (⇨ pg. 18)
- ㉜ Tripod Mounting Socket
- ㉝ Strap Fastener Eyelet (⇨ pg. 8)
- ㉞ Strap Eyelet (⇨ pg. 8)
- ㉟ Reset Hole (⇨ pg. 52)

## Indications on LCD Monitor

### During both Video and Still Image Recording

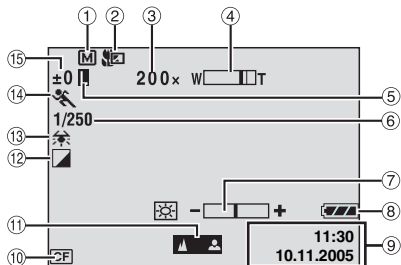

- ① Recording Mode Indicator (↗ pg. 16)  
**A**: Auto Mode  
**M**: Manual Mode
- ② Tele Macro Mode Indicator (↗ pg. 50)
- ③ Approximate Zoom Ratio (↗ pg. 21, 50)
- ④ Zoom Indicator (↗ pg. 21, 50)
- ⑤ Iris Lock Indicator (↗ pg. 31, 35)
- ⑥ Shutter Speed (↗ pg. 32)
- ⑦ Brightness Control Indicator (↗ pg. 49)
- ⑧ Battery Indicator (↗ pg. 55)
- ⑨ Date/Time (↗ pg. 49)
- ⑩ Selected Medium Indicator (↗ pg. 19, 49)
- ⑪ Manual Focus Adjustment Indicator (↗ pg. 33)
- ⑫ Effect Mode Indicator (↗ pg. 36)
- ⑬ White Balance Indicator (↗ pg. 35)
- ⑭ Program AE Mode Indicator (↗ pg. 31)
- ⑮ ±: Exposure Adjustment Indicator (↗ pg. 35)  
: Backlight Compensation Indicator (↗ pg. 31)  
: Spot Exposure Control Indicator (↗ pg. 31)

### During Video Recording only

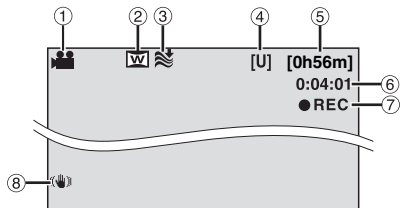

- ① Mode Indicator (↗ pg. 16)
- ② Wide Mode Indicator (↗ pg. 50)
- ③ Wind Cut Indicator (↗ pg. 50)

- ④ Picture Quality: [U] (ultra fine), [F] (fine), [N] (normal), [E] (economy) (↗ pg. 50)
- ⑤ Remaining Time (↗ pg. 20, 62)
- ⑥ Counter (↗ pg. 49)
- ⑦ ●REC: (Appears during recording.) (↗ pg. 20)  
 ●II: (Appears during record-standby mode.) (↗ pg. 20)
- ⑧ Digital Image Stabiliser (DIS) Indicator (↗ pg. 50)

### During Still Image Recording only

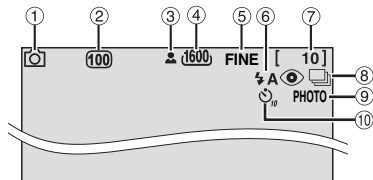

- ① Mode Indicator (↗ pg. 16)
- ② ISO sensitivity (GAIN) (↗ pg. 51)  
 (When set to [AUTO], there is no indication.)
- ③ Focus Icon (↗ pg. 25)
- ④ Image Size: 2560 (2560 x 1920), 2048 (2048 x 1536), 1600 (1600 x 1200), 1280 (1280 x 960), 640 (640 x 480) (↗ pg. 51)
- ⑤ Picture Quality: FINE (fine) or STANDARD (standard) (↗ pg. 51)
- ⑥ Flash Mode Indicator (↗ pg. 26)
- ⑦ Remaining Number of Shots (↗ pg. 63)
- ⑧ : Continuous Shooting Mode Indicator (↗ pg. 26)  
: Bracket Shooting Mode Indicator (↗ pg. 33)
- ⑨ Shooting Icon (↗ pg. 25)
- ⑩ Self-Timer Recording Indicator (↗ pg. 51)

#### NOTE:

For the indications on LCD monitor during voice recording, see page 29.



## During Video Playback

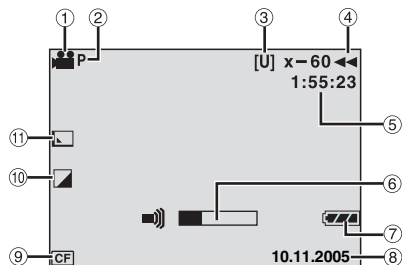

- ① Mode Indicator (☞ pg. 16)
- ② Play List Playback Indicator (Appears when play list is played back. ☞ pg. 44)
- ③ Picture Quality: [U] (ultra fine), [F] (fine), [N] (normal), [E] (economy) (☞ pg. 50)
- ④ Playback Mode (☞ pg. 22)
  - ▶ : Playback
  - || : Pause
  - ▶▶ : Forward High-Speed Search
  - ◀◀ : Reverse High-Speed Search
  - ||▶ : Forward Slow-Motion
  - ◀|| : Reverse Slow-Motion
 (The number on the left shows speed.)
- ⑤ Counter (☞ pg. 49)
- ⑥ Volume Level Indicator
- ⑦ Battery Indicator (☞ pg. 55)
- ⑧ Date (☞ pg. 49)
- ⑨ Selected Medium Indicator (☞ pg. 19, 49)
- ⑩ Effect Mode Indicator (☞ pg. 36)
- ⑪ Wipe/Fader Effect Indicator (☞ pg. 37, 50)

## During Still Image Playback

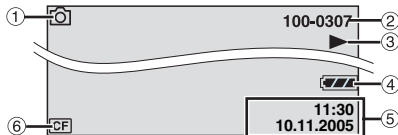

- ① Mode Indicator (☞ pg. 16)
- ② Folder/File Number
- ③ Slide Show Playback Indicator (☞ pg. 27)
- ④ Battery Indicator (☞ pg. 55)
- ⑤ Date/Time (☞ pg. 49)
- ⑥ Selected Medium Indicator (☞ pg. 19, 49)

### NOTE:

For the indications on LCD monitor during voice playback, see page 30.

## Power

This camera's 2-way power supply system lets you choose the most appropriate source of power. Do not use provided power supply units with other equipment.

### Charging the Battery Pack

#### Power Switch

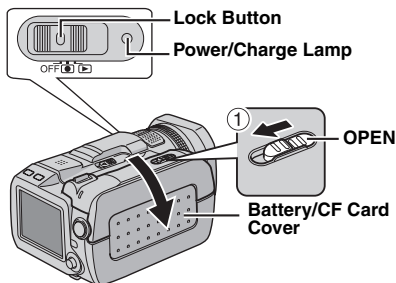

#### Protrusion

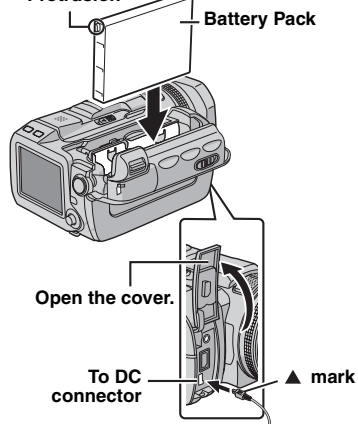

AC Adapter  
(ex. AP-V17E)

- 1 Set the power switch to **OFF** while pressing down the lock button located on the switch.
- 2 Slide and hold **OPEN** in the direction of the arrow ①, then open the battery/CF card cover.
- 3 Insert the battery pack firmly into the battery pack mount until it locks into space as shown in the illustration.
- 4 Close the battery/CF card cover firmly until it locks.
- 5 Connect the AC adapter to the camera.
- 6 Connect the power cord to the AC adapter. (AP-V14E only)
- 7 Plug the power cord into an AC outlet. The power/charge lamp on the camera blinks to indicate charging has started.
- 8 When the power/charge lamp goes out, charging is finished. Unplug the power cord from the AC outlet. Disconnect the AC adapter from the camera.

#### To detach the battery pack

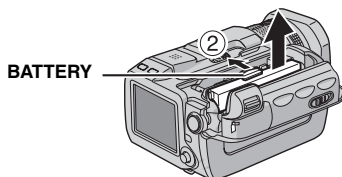

Open the battery/CF card cover, and remove the battery pack while sliding **BATTERY** in the direction of the arrow ②.



#### Required charging time

Battery pack	Charging time
BN-VM200U (provided)	Approx. 1 hr. 35 min.

**NOTES:**

- Charging times are for a fully discharged battery pack.
- When the battery/CF card cover is opened or the SD card is removed while the power is on, the power is automatically turned off to protect the data in the recording medium. To turn on the power again after opening the battery/CF card cover, close the cover. To turn on the power again after removing the SD card, close the cover and set the power switch to **OFF**, then to  or .
- It is recommended that only genuine JVC batteries are used in this camera. Using generic non-JVC batteries can cause damage to the internal charging circuitry.
- If the protective cap is attached to the battery pack, remove it first.
- When charging the battery pack for the first time or after a long storage period, the power/charge lamp may not light. In this case, remove the battery pack from the camera, then try charging again.
- If the battery operation time remains extremely short even after having been fully charged, the battery is worn out and needs to be replaced. Please purchase a new one.
- Using the optional AA-V200 battery charger, you can charge the BN-VM200U battery pack without the camera.
- Since the AC adapter processes electricity internally, it becomes warm during use. Be sure to use it only in well-ventilated areas.

**Using the Battery Pack**

Perform steps **2 – 4** in “Charging the Battery Pack”.

**Maximum continuous recording time**

Battery pack	Recording time
BN-VM200U (provided)	1 hr.

**NOTES:**

- Recording time is reduced significantly under the following conditions:
  - Zoom or record-standby mode is engaged repeatedly.
  - Playback mode is engaged repeatedly.
- Before extended use, it is recommended that you prepare enough battery packs to cover 3 times the planned recording time.

**Using AC Power**

Connect the AC adapter to the camera.

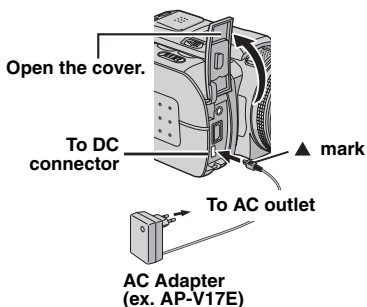
**NOTE:**

The provided AC adapter features automatic voltage selection in the AC range from 110 V to 240 V.

**ATTENTION:**

- Before detaching the power source, make sure that the camera's power is turned off. Failure to do so can result in a camera malfunction.
- If the camera is a subject to electrostatic discharge, turn the power off before using it again.

**About Batteries**

**DANGER!** Do not attempt to take the batteries apart, or expose them to flame or excessive heat, as it may cause a fire or explosion.

**WARNING!** Do not allow the battery or its terminals to come in contact with metals, as this can result in a short circuit and possibly start a fire.

**The Benefits of Lithium-Ion Batteries**

Lithium-ion battery packs are small but have a large power capacity. However, when one is exposed to cold temperatures (below 10°C), its usage time becomes shorter and it may cease to function. If this happens, place the battery pack in your pocket or other warm, protected place for a short time, then re-attach it to the camera.

## Operation Mode

To turn on the camera, set the power switch to or while pressing down the lock button located on the switch.

• The power/charge lamp turns on.

To turn off the camera, set the power switch to OFF.

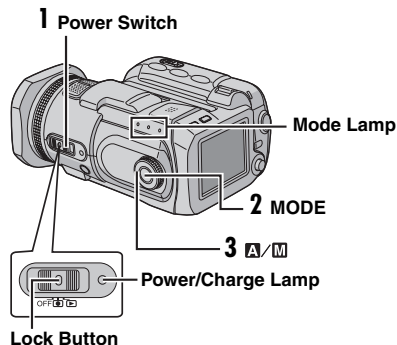

Set the appropriate operation mode according to your preference using the power switch, **MODE** button and the recording mode dial.

### 1 Power Switch Position

Set the power switch for recording () or playback () while pressing down the lock button.

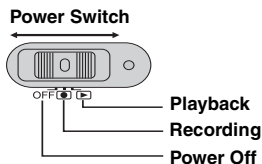

### 2 Recording/Playback Mode

Press **MODE** to select the recording/playback mode.

The selected mode lamp lights up.

: Video mode (☞ pg. 20, 22)

: Still image mode (☞ pg. 25, 27)

: Voice mode (☞ pg. 29, 30)

• To select the voice mode, press and hold **MODE**.

### 3 Auto/Manual Mode

Set the recording mode dial to the desired position to switch the auto/manual recording mode. The indicator or appears on the LCD monitor. (☞ pg. 12)

Auto mode ():

You can record using no special effects or manual adjustments.



Manual mode (other than ):

Manual recording is possible by setting various functions.

(☞ pg. 31 – 36)

### Language Setting (except GZ-MC500EK for U.K. model)

The language on the display can be changed. (☞ pg. 48, 49)

1 Set the power switch to or .

2 Press **MENU**. The menu screen appears.

3 Select [DISPLAY] with the multi-controller ( $\Delta/\nabla$ ), then press **▶II**.



4 Select [LANGUAGE] with the multi-controller ( $\Delta/\nabla$ ), then press **▶II**.

5 Select the desired language with the multi-controller ( $\Delta/\nabla$ ), then press **▶II**.







6 Press **MENU** to return to the normal screen.

## Date/Time Settings

The recording start date/time is recorded on the video/still image/voice file and it can be checked by pressing **INFO** during playback.

(☞ pg. 22, 27, 30)

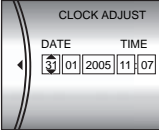
- 1 Set the power switch to  or .
- 2 Press **MENU**. The menu screen appears.
- 3 Select [DISPLAY] with the multi-controller ( $\Delta/\nabla$ ), then press **▶II**.
 
- 4 Select [CLOCK ADJUST] with the multi-controller ( $\Delta/\nabla$ ), then press **▶II**. The day is highlighted.
 
- 5 Input the day with the multi-controller ( $\Delta/\nabla$ ), then press **▶II**. Repeat to input the month, year, hour and minute.
 
- 6 Press **MENU** to return to the normal screen.

### Built-in Clock's Rechargeable Lithium Battery

If the camera is not used for approx. 3 months, the clock's lithium battery will become discharged and the date/time stored in memory will be lost. When this occurs, first connect the camera to an AC outlet using the AC adapter for over 24 hours to charge the clock's rechargeable lithium battery. Then perform the date/time setting before using the camera.

Note that the camera can be used without setting the date/time.

## Inserting/Removing a CF Card

You can use a CF card (CompactFlash card) as a recording medium in the CF slot. The removable hard disk (provided) or Microdrive<sup>®</sup> is a type of CF cards. See page 62 for the guaranteed media to work with this camera.

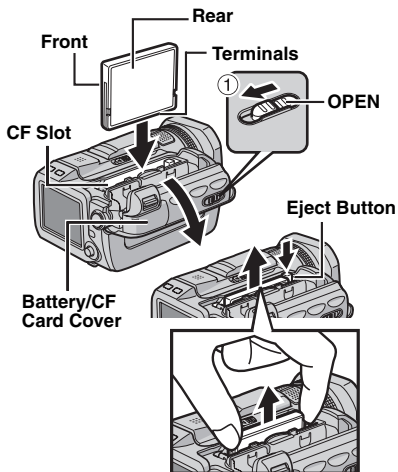



- 1 Make sure the camera's power is off.
- 2 Slide and hold **OPEN** in the direction of the arrow ①, then open the battery/CF card cover.
- 3 When the eject button is pulled out as shown in the illustration, push it once.
  - The button is pushed in.
- 4 **To insert a CF card**, firmly insert it as shown in the illustration.
 

**To remove a CF card**, push the eject button twice.

  - The eject button comes out by pushing it once. By pushing the eject button once again ejects the CF card.
- 5 Close the battery/CF card cover firmly until it locks.

**NOTES:**

- Read the cautions on CF card. (☞ pg. 58, “Recording Medium”)
- Before using the provided removable hard disk or a new CF card, it is necessary to format it. (☞ pg. 19)
- When the battery/CF card cover is opened or the SD card is removed while the power is on, the power is automatically turned off to protect the data in the recording medium. To turn on the power again after opening the battery/CF card cover, close the cover. To turn on the power again after removing the SD card, close the cover and set the power switch to **OFF**, then to  or .

**ATTENTION:**

- Do not insert or remove the CF card while the camera is turned on, as this may cause the CF card to be corrupted or cause the camera to become unable to recognise whether or not the CF card is installed.
- Do not squeeze the external covers of the CF card.

**Inserting/Removing an SD Card**

You can use an SD card as a recording medium in the SD slot. See page 62 for the guaranteed media to work with this camera.

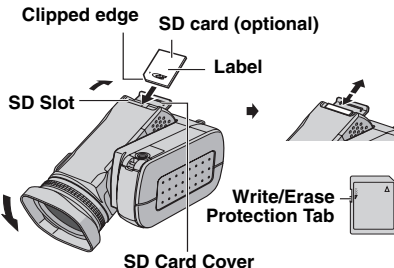

- 1** Make sure the camera's power is off.
- 2** Open the SD card cover.
- 3** To insert an SD card, firmly insert it with its clipped edge first.
- 3** To remove an SD card, push it once. After the SD card comes out of the camera, pull it out.
  - Do not touch the terminal on the reverse side of the label.
- 4** Close the SD card cover.

**To protect valuable files**

Slide the write/erase protection tab on the side of the SD card in the direction of “LOCK”. This prevents the SD card from being recorded over. To record on this SD card, slide the tab back to the position opposite to “LOCK” before inserting it.

**NOTE:**



Before using a new SD card, it is necessary to format the card. (☞ pg. 19)

**ATTENTION:**

Do not insert or remove the SD card while the camera is turned on, as this may cause the SD card to be corrupted or cause the camera to become unable to recognise whether or not the SD card is installed.

## Formatting a Recording Medium

You can format (initialise) a recording medium in the CF or SD slot. You have to format the provided removable hard disk or newly-purchased CF cards and SD cards with this camera before using them. This enables stable speeds and operation when accessing the recording medium. Be aware that all files and data including protected files will be erased. (pg. 39)

- 1 Set the power switch to  or .
- 2 Press **MENU**. The menu screen appears.
- 3 Select [MEMORY CARD SETTING] with the multi-controller ( $\Delta/\nabla$ ), then press **▶II**.

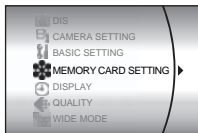

- 4 Select [FORMAT] with the multi-controller ( $\Delta/\nabla$ ), then press **▶II**.



- 5 Select [CF SLOT] or [SD SLOT] with the multi-controller ( $\Delta/\nabla$ ), then press **▶II**.
- 6 Select [EXECUTE] with the multi-controller ( $\Delta/\nabla$ ), then press **▶II**.
  - To cancel the formatting, select [CANCEL], then press **▶II**.

### CAUTION:

Do not remove the recording medium or perform any other operation (such as turning off the power) during format. Also, be sure to use the provided AC adapter, as the recording medium may be corrupted if the battery becomes exhausted during format. If the recording medium becomes corrupted, format it again.

### NOTE:

Do not format the recording medium on the PC. Make sure to format the recording medium on the camera.

## Selecting Recording Medium

Select the recording medium before starting recording or playback. (pg. 48, 49)  
Example: When recording still images to an SD card

- 1 Set the power switch to .
- 2 Press **MENU**. The menu screen appears.
- 3 Select [MEMORY CARD SETTING] with the multi-controller ( $\Delta/\nabla$ ), then press **▶II**.

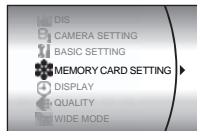

- 4 Select [IMAGE MODE] with the multi-controller ( $\Delta/\nabla$ ), then press **▶II**.



- 5 Select [SD SLOT] with the multi-controller ( $\Delta/\nabla$ ), then press **▶II**.
- 6 Press **MENU** to return to the normal screen.

## Video Recording

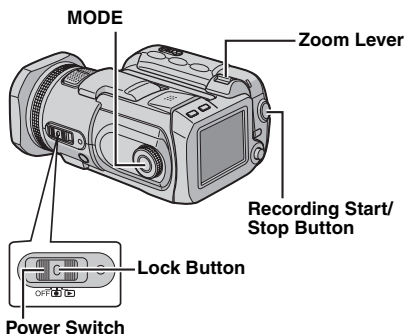

**1** Set the power switch to .

**2** Press **MODE** to select .

- The camera is programmed to record videos on the medium in the CF slot by the factory-preset. To switch the recording medium, see pages 19, 48 and 49.

- To change the picture quality, see pages 48 and 50.

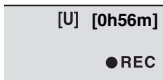

**3** Press the recording start/stop button to start recording.

- Approximate remaining time for recording appears on the display.



**4** To stop recording, press the recording start/stop button again.

### NOTES:

- If the camera is left without any operation during recording or playback (video, still image or voice) for 5 minutes when using the battery pack, the camera is turned off automatically to conserve power. To turn the camera on again, set the power switch to **OFF**, then to  or . When using the AC adapter, the camera enters the sleep mode (the access lamp lights and the LCD monitor turns off). To cancel the sleep mode, perform any operation such as zooming.
- When the camera heats up, the ●REC indicator flashes. If the camera continues to heat up, shooting may be stopped to protect the recording medium. In this case, turn off the camera power, and then wait until the camera cools down. (→ pg. 56)
- When shooting continuously, shooting is automatically stopped when a file size of 4 GB is reached.
- If data cannot be recorded or saved properly, the video files are not saved to the [SD\_VIDEO] folder for regular video. Instead, the files are saved to the [EXTMOV] folder. To play back these files, see "To play back files in the [EXTMOV] folder" (→ pg. 22).
- There may be differences in the brightness between the recorded video and still image, even if the same subject is shot.
- Video file names are assigned as sequential hexadecimal numbers.
- To turn the operation sounds off, see page 48.
- For approximate recording time, see page 62.



## Zooming

Use the zoom function for close-up or wide-angle shooting. You can zoom in up to 10x by using the optical zoom.

### To zoom in

Slide the zoom lever towards **T** (telephoto).

### To zoom out

Slide the zoom lever towards **W** (wide-angle).

**W: Wide angle**

**T: Telephoto**

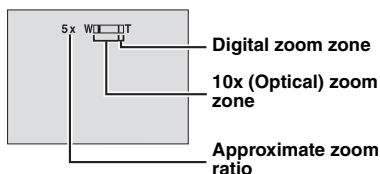
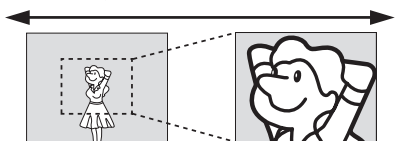

- The further you slide the zoom lever, the quicker the zoom action.
- Zoom magnification over 10x is done through digital image processing, and is therefore called digital zoom. Digital zooming is possible up to 200x. Set [ZOOM] to [40X] or [200X]. (☞ pg. 50)

## NOTES:

- Focusing may become unstable during zooming. In this case, set the zoom before recording and lock the focus by using the manual focus (☞ pg. 33), then zoom in or out during recording.
- During digital zoom, the quality of image may suffer.
- Macro shooting is possible as close as approx. 5 cm to the subject when the zoom lever is set all the way to **W**.
- When you zoom into a subject close to the lens, the camera may automatically zoom out depending on the distance to the subject. In this case, set [TELE MACRO] to [ON]. (☞ pg. 50)

## Angle Adjustment

Tilt the lens part at the most convenient angle. The lens part can rotate 45° upward and downward.

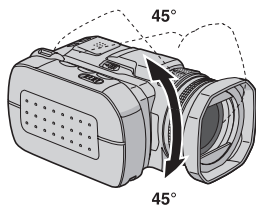

## Deleting Files

If you press  during recording mode, the file recorded most recently will be deleted.

(☞ pg. 40)

- However, if the recording mode (video, still image or voice) is switched or the power is turned off and on again after recording, you cannot delete the file.

## Video Playback

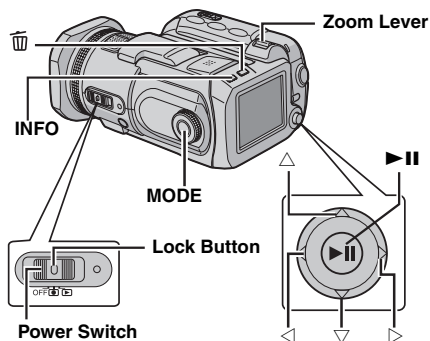

**1** Set the power switch to .

**2** Press **MODE** to select .

- The index screen for videos appears. The image on the index screen shows the first part of the shooting.
- To switch the medium to be played back, see pages 19, 48 and 49.

**3** Select the video file you want to play back with the multi-controller (.

**4** Press to start playback.

**5** To pause playback, press again.

### To return to the index screen

Slide the zoom lever to **W** when playback is paused.

### To adjust the speaker volume

During playback slide the zoom lever towards **T** to turn up the volume, or towards **W** to turn down the volume.

### To turn on/off the date display

Set [DATE/TIME] to [ON], [AUTO] or [OFF].  
( pg. 48, 49)

### To turn on/off the on-screen display

Press **INFO** repeatedly.

### To check the file information

Press **INFO** when playback is paused.

### To play back files in the [EXTMOV] folder

If the data cannot be recorded properly, the video files are saved to the [EXTMOV] folder.  
( pg. 20)

To play back the files in the [EXTMOV] folder, press the recording start/stop button while the index screen is displayed in step **2**, and then proceed to step **3** after [MPG] is displayed.

- The fast forward, rewind, slow, frame-by-frame playback, and playlist creation functions are not available for files in the [EXTMOV] folder.

### NOTES:

- The playback picture can be viewed in the LCD monitor or on a connected TV. ( pg. 24)
- At the junctions between scenes, the image may stop momentarily or the sound may be interrupted. However, this is not a malfunction.
- To join scenes without distortion, load the video files into the PC and use the provided software to combine the files. When the combined file is used to record a DVD, it will have the same joints without distortion between scenes as a commercial DVD. Refer to "How To Create DVDs simply" of software installation and USB connection guide for more about DVD creation.
- The date and counter can be displayed during playback. ( pg. 49)
- When the camera heats up, the indicator flashes. If the camera continues to heat up, playback may be stopped to protect the recording medium. In this case, turn off the camera power, and then wait until the camera cools down. ( pg. 56)
- When a cable is connected to the AV connector, the sound is not heard from the speaker or headphones.

## How to Use the Scroll Bar

You can use the vertical scroll bar on the index screen to find the desired files quickly. The scroll bar is useful when deleting files ( pg. 40), creating play list ( pg. 43), etc.

**1** Slide the zoom lever towards **W** to select the scroll bar on the index screen.

**2** Display the next or previous page with the multi-controller (.

- If you move and hold the multi-controller to , the high speed search starts.
- If you find the desired file, slide the zoom lever towards **T**, then select the file.

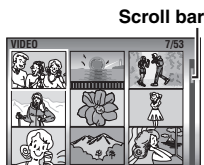

## Various Playback Operations

### Still playback (Pause)

Press ►II during normal playback.

- To resume normal playback, press ►II again.

### Search playback

During normal playback, move the multi-controller to ▷ for forward search, or ◁ for reverse search.

- Moving the multi-controller to ◁ or ▷ repeatedly increases the search speed for each direction. (-60x to +60x)
- To resume normal playback, press ►II.

### Locating the start point of the file or skip the file

Move the multi-controller to ▽ to locate the start point of the next file. Moving the multi-controller to ▽ repeatedly skips files in forward direction. Move the multi-controller to △ to locate the start point of the current file. Moving the multi-controller to △ repeatedly skips files in reverse direction.

- If the multi-controller is moved to ▽ or △ during normal playback or search, playback resumes after locating the start point of a file.

### Frame-by-frame playback

While playback is paused, move the multi-controller to ▷ or ◁.

- Moving the multi-controller to ◁ or ▷ repeatedly advances or reverses the still picture frame by frame.
- To resume normal playback, press ►II.

### Slow motion playback

While playback is paused, move and hold the multi-controller to ▷ or ◁ for over 2 seconds.

- To stop slow motion playback, press ►II.

## Playback Zoom

You can magnify the playback image up to 5x.

**1** During normal playback, at the point you want to zoom in, press ►II to pause playback.

**2** Slide the zoom lever towards **T** to zoom in.

- The full view of the image is displayed in the small screen on the lower right side. The \* mark indicates the centre point of the magnified area.

**3** Move to the magnified area you want to view with the multi-controller (△▽/◁▷).

**4** To zoom out, slide the zoom lever towards **W**.

- When the zoom is set all the way to **W** (wide-angle) side, sliding the zoom lever to **W** switches the display to the index screen. (☞ pg. 22)

## Deleting Video Files

Press , then select [EXECUTE] with the multi-controller (△▽) and press ►II.

- You can select the desired file to be deleted with the multi-controller (◁▷).
- To delete multiple files at once, see page 40.

## Connecting to a TV or VCR

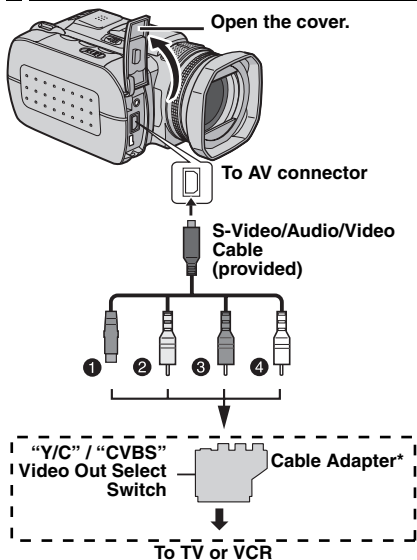

- ❶ Black to S-VIDEO IN (Connect when your TV/VCR has S-VIDEO IN and A/V input connectors. In this case, it is not necessary to connect the yellow video cable.)
- ❷ Yellow to VIDEO IN (Connect when your TV/VCR has only A/V input connectors.)
- ❸ Red to AUDIO R IN\*\*
- ❹ White to AUDIO L IN\*\*

\* If your TV/VCR has a SCART connector, use the provided cable adapter.

\*\* Not required for watching still images only.

### NOTES:

- It is recommended to use the AC adapter as the power supply instead of the battery pack. (⇨ pg. 15)
- Set the video out select switch of the cable adapter as required:  
**Y/C:** When connecting to a TV or VCR which accepts Y/C signals and uses an S-Video cable.  
**CVBS:** When connecting to a TV or VCR which does not accept Y/C signals and uses a video cable.
- Make sure you adjust the TV sound volume to its minimum level to avoid a sudden burst of sound when the camera is turned on.
- To connect the camera to a PC, refer to the software installation and USB connection guide.

## Playback on a TV

- ❶ Make sure all units are turned off.
  - ❷ Connect the camera to a TV or VCR as shown in the illustration.
- If using a VCR, go to step 3.**  
**If not, go to step 4.**
- ❸ Connect the VCR output to the TV input, referring to your VCR's instruction manual.
  - ❹ Turn on the camera, the VCR and the TV.
  - ❺ Set the VCR to its AUX input mode, and set the TV to its VIDEO mode.
  - ❻ Start playback on the camera. (⇨ pg. 22)

### To choose whether or not the following displays appear on the connected TV

- Date/Time  
Set [DATE/TIME] to [AUTO], [ON] or [OFF]. (⇨ pg. 48, 49)
  - Counter  
Set [SCENE COUNTER] to [ON] or [OFF]. (⇨ pg. 48, 49)
- (Pressing **INFO** button also turns on/off the displays.)

## Dubbing to a VCR

- ❶ Perform steps 1 to 6 above.
- ❷ At the point you want to start dubbing, start recording on the VCR. (Refer to the VCR's instruction manual.)
- ❸ To stop dubbing, stop recording on the VCR, then stop playback on the camera.

## Still Image Recording

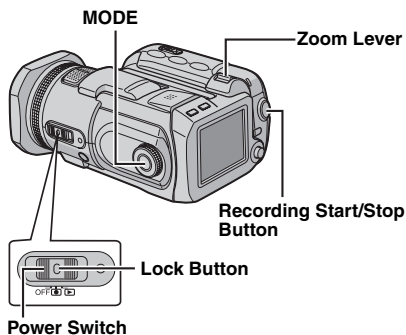

**1** Set the power switch to .

**2** Press **MODE** to select .

- The camera is programmed to record still images on the medium in the CF slot by the factory-preset. To switch the recording medium, see pages 19, 48 and 49.
- To change the image size and picture quality, see pages 48 and 51.
- To use the flash, see page 26.

**3** Press the recording start/stop button. **PHOTO** indicator appears during shooting. The still image is recorded.

- To check how the image looks before recording, press the recording start/stop button halfway and hold. The  indicator appears and stops blinking when the captured image is focused. To cancel the recording, release the recording start/stop button. To record it on the recording medium, press the recording start/stop button fully.

### NOTES:

- There may be differences in the brightness between the recorded video and still image, even if the same subject is shot.
- To turn the shutter sound off, see page 48.
- For approximate number of storable images, see page 63.

## Zooming

Use the zoom function for close-up or wide-angle shooting. You can zoom in up to 8x by using the optical zoom.

### To zoom in

Slide the zoom lever towards **T** (telephoto).

### To zoom out

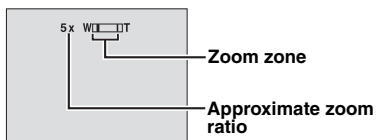
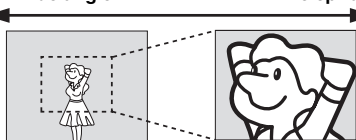

Slide the zoom lever towards **W** (wide-angle).

**W**: Wide angle                      **T**: Telephoto



- The further you slide the zoom lever, the quicker the zoom action.



### NOTES:

- Zooming is possible up to 8X regardless of the ZOOM setting in the still image recording mode.
- Focusing may become unstable during zooming. In this case, set the zoom before recording and lock the focus by using the manual focus ( pg. 33), then zoom in or out during recording.
- Macro shooting is possible as close as approx. 5 cm to the subject when the zoom lever is set all the way to **W**.
- When you zoom into a subject close to the lens, the camera may automatically zoom out depending on the distance to the subject. In this case, set [TELE MACRO] to [ON]. ( pg. 50)

## Continuous Shooting

If the continuous shooting mode is set to on, keeping the recording start/stop button pressed in step 3 in "Still Image Recording" (pg. 25) provides an effect similar to serial photography. (Interval between still images: approx. 0.5 seconds)



To use this function, set the recording mode dial to other than **A**, then move the multi-controller to **>** so that the  indicator appears on the display.

- To turn off this function, move the multi-controller to **>** so that  (or ) indicator disappears.
- Continuous shooting may not work well depending on the recording medium.
- The continuous shooting speed will drop when repeatedly making continuous shots.

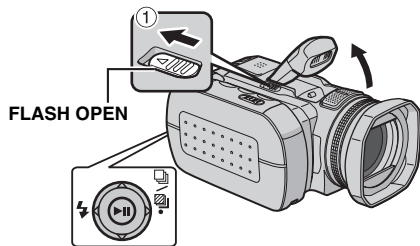

## Flash

You can use the flash for still image recording. The flash mode can be changed as required.



- 1 Set the power switch to .
- 2 Press **MODE** to select .
- 3 Slide **FLASH OPEN** in the direction of the arrow ① so that the built-in flash pops up.
  - The flash icon appears.
- 4 Select the desired flash mode with the multi-controller **<** ()

 **A [AUTO]**: The flash fires automatically when the surroundings are dark.

  **AUTO RED-EYE**: The flash fires automatically but reduces the red-eye phenomenon of the subject's eyes.

 **ON**: The flash fires regardless of the shooting condition.

 **S SLOW SYNCHRO**: The flash fires regardless of the shooting condition. The shutter speed becomes slower in this mode, so the background can be also brightened.

[ ] = Factory-preset

### When not using the flash

Push the flash down slightly.

### NOTES:

- The flash, continuous shooting or bracket shooting etc. cannot be used at the same time. An unusable mode indicator blinks or goes out.
- The flash icon also blinks while charging the flash.
- If the flash is not bright enough, set [GAIN] to [200] or [400]. (pg. 51)

## Deleting Files

If you press  during recording mode, the file recorded most recently will be deleted.

(pg. 40)

- However, if the recording mode (video, still image or voice) is switched or the power is turned off and on again after recording, you cannot delete the file.

## Still Image Playback

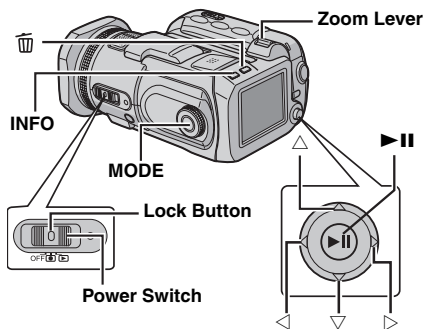

- 1 Set the power switch to .
- 2 Press **MODE** to select .
  - A still image is displayed.
  - To switch the medium to be played back, see pages 19, 48 and 49.
- 3 Move the multi-controller to to display the previous file. Move the multi-controller to to display the next file.

### To turn on/off the date/time display

Set [DATE/TIME] to [ON], [AUTO] or [OFF].  
( pg. 48, 49)

### To turn on/off the on-screen display / To check the file information ( pg. 38) / To display the histogram ( pg. 38)

Press **INFO** repeatedly.

### NOTES:

- Images shot and stored on the recording media with another device may not be played back correctly.
- You can zoom in/out or rotate still images. ( pg. 28)

## Slide Show

You can playback all the images stored in recording media automatically.

- 1 Set the power switch to .
- 2 Press **MODE** to select .
  - A still image is displayed.
  - To switch the medium to be played back, see pages 19, 48 and 49.
- 3 Press **▶||** to start the slide show.
  - If you move the multi-controller to during the slide show, files are displayed in descending order.
  - If you move the multi-controller to during the slide show, files are displayed in ascending order.
  - To end the slide show, press **▶||** again.

### To display the next image

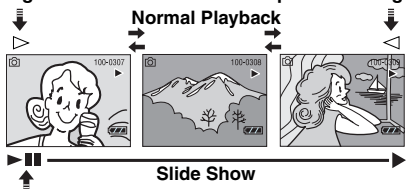

## Index Screen of Still Image Files

You can view multiple files stored in a recording medium at a time. This browsing capability makes it easy to locate a particular file you want.

- 1 Slide the zoom lever to **W** when a recorded image is displayed.
  - The display switches to the index screen.
- 2 Move the frame to the desired file with the multi-controller (/).
- 3 Press **▶||**. The selected file is displayed.



## How to Use the Scroll Bar

You can use the vertical scroll bar on the index screen to find the desired files quickly. The scroll bar is useful when deleting files (⇨ pg. 40), setting DPOF (⇨ pg. 46), etc.

**1** Slide the zoom lever towards **W** to select the scroll bar on the index screen.

**2** Display the next or previous page with the multi-controller ( $\Delta/\nabla$ ).

- If you move and hold the multi-controller to  $\Delta/\nabla$ , the high speed search starts.
- If you find the desired file, slide the zoom lever towards **T**, then select the file.



Scroll bar

## Image Rotation

You can rotate a still image clockwise or counterclockwise.

**1** Set the power switch to  $\blacktriangleright$ .

**2** Press **MODE** to select  $\blacksquare$ .

- A still image is displayed.
- To switch the medium to be played back, see pages 19, 48 and 49.

**3** Move the multi-controller to  $\nabla$  to rotate 90° clockwise.

- Each time you move the multi-controller to  $\nabla$ , the image rotates clockwise. (90° → 180° → 270° → 0°)

**4** Move the multi-controller to  $\Delta$  to rotate 90° counterclockwise.

- Each time you move the multi-controller to  $\Delta$ , the image rotates counterclockwise. (270° → 180° → 90° → 0°)

## Playback Zoom

You can magnify the playback image up to 5x.

**1** Set the power switch to  $\blacktriangleright$ .

**2** Press **MODE** to select  $\blacksquare$ .

- A still image is displayed.
- To switch the medium to be played back, see pages 19, 48 and 49.

**3** Slide the zoom lever towards **T** to zoom in.

- The full view of the image is displayed in the small screen on the lower right side. The \* mark indicates the centre point of the magnified area.

**4** Move to the magnified area you want to view with the multi-controller ( $\Delta/\nabla/\langle/\rangle$ ).

**5** To zoom out, slide the zoom lever towards **W**.

- When the zoom is set all the way to **W** (wide-angle) side, sliding the zoom lever to **W** switches the display to the index screen. (⇨ pg. 27)

## Deleting Still Image Files



Press  $\text{⏏}$ , then select [EXECUTE] with the multi-controller ( $\Delta/\nabla$ ) and press  $\blacktriangleright$ .

- You can select the desired file to be deleted with the multi-controller ( $\langle/\rangle$ ).
- To delete multiple files at once, see page 40.

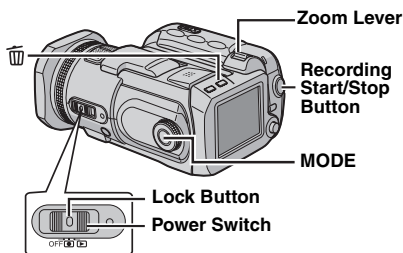

## Voice Recording







- 1 Set the power switch to .
- 2 Press and hold **MODE** to select .
  - The camera is programmed to record voice on the medium in the CF slot by the factory preset. To switch the recording medium, see pages 19, 48 and 49.
  - To change the sound quality and recording level, see pages 48 and 51.
- 3 Press the recording start/stop button to start recording.
- 4 To stop recording, press the recording start/stop button again. The camera re-enters the record-standby mode.

### NOTE:

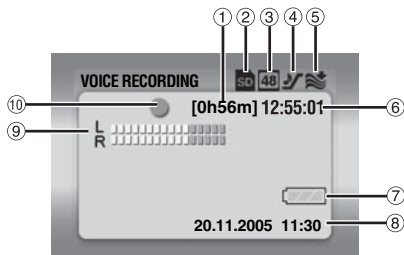
For approximate recording time, see page 63.

## Indication on LCD Monitor





- ① Remaining Time (☞ pg. 63)
- ② Selected Medium Indicator (☞ pg. 19, 49)
- ③ Sound Quality: 48 (fine), 16 (standard), 8 (economy) (☞ pg. 51)
- ④ Recording Level:  (high),  (middle),  (low) (☞ pg. 51)
- ⑤ Wind Cut Indicator (☞ pg. 50)
- ⑥ Counter
- ⑦ Battery Indicator (☞ pg. 55)
- ⑧ Date/Time
- ⑨ Microphone Input Level Indicator
- ⑩ Recording Mode
  - : Record
  - : Record-standby

## Deleting Files

If you press  during recording mode, the file recorded most recently will be deleted. (☞ pg. 40)

- However, if the recording mode (video, still image or voice) is switched or the power is turned off and on again after recording, you cannot delete the file.

## Voice Playback

- 1 Set the power switch to .
- 2 Press and hold **MODE** to select .
  - To switch the medium to be played back, see pages 19, 48 and 49.
- 3 Press **▶||** to start playback.
- 4 To pause playback, press **▶||** again.

### To adjust the speaker volume

During playback slide the zoom lever towards **T** to turn up the volume, or towards **W** to turn down the volume.

### To check the file information

Press **INFO** when playback is paused.

### To select the file on the playback list

Slide the zoom lever to **W** when playback is paused so that the playback list appears. Then select the file with the multi-controller ( $\Delta/\nabla$ ) and press **▶||**.

FILE No.	DATE	P.B. TIME
100-0001	15. 11. 2005 10:30	1h30m20s
	20. 11. 2005 11:30	1h15m10s
	23. 11. 2005 10:10	2h20m20s
	29. 11. 2005 11:00	2h50m30s

Scroll bar

- Scroll bar is available to be used as on the index screen of video and still image.

## Various Playback Operations

### Search playback

During normal playback, move the multi-controller to  $\triangleright$  for forward search, or  $\triangleleft$  for reverse search. To resume normal playback, press **▶||**.



### Locating the start point of the file or skip the file

Move the multi-controller to  $\nabla$  to locate the start point of the next file. Moving the multi-controller to  $\nabla$  repeatedly skips files in forward direction. Move the multi-controller to  $\Delta$  to locate the start point of the current file. Moving the multi-controller to  $\Delta$  repeatedly skips files in reverse direction.

- If the multi-controller is moved to  $\nabla$  or  $\Delta$  during normal playback or search, playback resumes after locating the start point of a file.

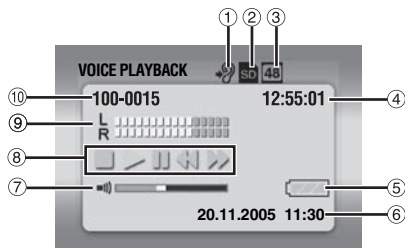
## Indication on LCD Monitor



- 1 Playback Speed:  (normal),  (fast),  (slow) ( $\Rightarrow$  pg. 51)
- 2 Selected Medium Indicator ( $\Rightarrow$  pg. 19, 49)
- 3 Sound Quality: 48 (fine), 16 (standard), 8 (economy) ( $\Rightarrow$  pg. 51)
- 4 Counter
- 5 Battery Indicator ( $\Rightarrow$  pg. 55)
- 6 Date/Time ( $\Rightarrow$  pg. 49)
- 7 Volume Level Indicator
- 8 Playback Mode
  - : Stop
  - ▶ : Playback
  - || : Pause
  - ◀◀ : Reverse High-Speed Search
  - ▶▶ : Forward High-Speed Search
- 9 Recording Level Indicator
- 10 Folder/File Number



## Deleting Voice Files

Press , then select [EXECUTE] with the multi-controller ( $\Delta/\nabla$ ) and press **▶||**.



- You can select the desired file to be deleted with the multi-controller ( $\triangleleft/\triangleright$ ).
- To delete multiple files at once, see page 40.

## Backlight Compensation

Backlight compensation brightens the subject quickly. With simple operation, dark portions of the subject are brightened by increasing the exposure.





- 1 Set the power switch to .
- 2 Set the recording mode dial to other than **A** so that **M** is displayed.
- 3 Move the multi-controller to  $\Delta$  () once so that the  indicator appears.

### To cancel backlight compensation

Move the multi-controller to  $\Delta$  () twice so that the  indicator disappears.

## Spot Exposure Control



Selection of a spot metering area enables more precise exposure compensation. You can select one of the three metering areas.

- 1 Set the power switch to .
- 2 Set the recording mode dial to other than **A** so that **M** is displayed.
- 3 Move the multi-controller to  $\Delta$  () twice so that the  indicator appears.
  - The spot metering area frame () appears at the centre.
- 4 Select the desired spot metering area frame with the multi-controller ( $\triangleleft/\triangleright$ ).
- 5 Press **▶II**. The setting is completed.

### To lock the exposure

After step 4, press and hold **▶II** for over 2 seconds. The  indicator appears.

### To cancel spot exposure control





Move the multi-controller to  $\Delta$  () once so that the  indicator disappears.

### NOTES:

- Spot exposure control may not be possible when some other functions are activated.
- Depending on the shooting location and condition, optimum result may not be attained.

## Program AE

You can use the program AE settings for specific shooting situations.

- 1 Set the power switch to .
- 2 Set the recording mode dial to the desired position.
  -  **Twilight:** Makes evening scenes look more natural.
  -  **Portrait:** The subject in the front is accentuated by blurring the background.
  -  **Sports:** Fast shutter speed allows fast-moving subject to be captured one frame at a time vividly. The shutter speed is set at 1/250 to 1/4000 second automatically.
  -  **Snow:** Compensates for subjects that may appear too dark when shooting in extremely bright surroundings such as in the snow.

### To turn off the program AE function

Set the recording mode dial to **A** or **M**.

### NOTE:

While recording is in progress, the program AE cannot be set even if the recording mode dial is set.

## Aperture-Priority

### Setting the aperture value manually (A)

You can set the aperture value (F-number) manually. The larger the aperture value (lower F-number), the more blurred the background will become. The smaller the aperture value (higher F-number), the clearer the focus will be both near and far object.

**1** Set the power switch to .

**2** Set the recording mode dial to **A**. The F-number is displayed.

**3** Select the desired F-number with the multi-controller ()

You can select F-number from the followings.

**F1.8\* / F1.9\*\* / F2.0 / F2.8 / F4.0 / F5.6 / F8.0\***

\* Not available for still image recording.

\*\* Not available for video recording.

● If you cannot change the value, press **▶II**.

**4** Press **▶II**. The setting is completed.

### To change the F-number

Press **▶II**, then select the F-number with the multi-controller () and press **▶II**.

### To turn off the aperture-priority

Set the recording mode dial to other than **A**.

### NOTE:

If it is too bright, set to the larger F-number. If it is too dark, set to the smaller.

## Shutter-Priority

### Setting the shutter speed manually (S)

You can set the shutter speed manually. A fast shutter speed can freeze the motion of a fast-moving subject and a slow shutter speed can blur the subject to give the impression of motion.

**1** Set the power switch to .

**2** Set the recording mode dial to **S**. The shutter speed is displayed.

**3** Select the desired shutter speed with the multi-controller ()

You can select the shutter speed from the followings.

● If you cannot change the value, press **▶II**.

1/2 1/4 1/8 1/15 1/25*	Slow shutter speed can blur the subject to give the impression of flowing motion.
1/50*	The shutter speed is fixed at 1/50 second. Black bands that usually appear when shooting a TV screen become narrower.
1/120*	The shutter speed is fixed at 1/120 second. The flickering that occurs when shooting under a fluorescent light or mercury-vapor lamp is reduced.
1/250 1/500 1/1000** 1/2000** 1/4000**	Fast shutter speed allows fast-moving subject to be captured one frame at a time vividly. Use these settings when an automatic adjustment does not work well by  (Sports) mode in Program AE. (▶ pg. 31)

\* The shutter speed is set to 1/30, 1/60, 1/125 during the still image recording.

\*\* Not available for still image recording. If the flash is used, 1/500 is also not available.

**4** Press **▶II**. The setting is completed.

### To change the shutter speed

Press **▶II**, then select the shutter speed with the multi-controller () and press **▶II**.

### To turn off the shutter-priority

Set the recording mode dial to other than **S**.

### NOTES:

● It is recommended to use a tripod when recording with a slow shutter speed.

● The shutter speed can be set separately in video and still image.

## Bracket Shooting



In addition to an image with the exposure set by the camera, two other images are recorded with exposure values shifted to the +0.3 EV and -0.3 EV sides. You can select the image that has a suitable exposure after shooting.

### Decreased exposure



### Standard exposure



### Increased exposure



- 1 Set the power switch to .
- 2 Press **MODE** to select .
- 3 Set the recording mode dial to other than **A** so that **M** is displayed.
- 4 Move the multi-controller to twice so that the indicator appears on the display.
- 5 Press the recording start/stop button for bracket shooting. Three still images are recorded.

### To cancel the bracket shooting

Move the multi-controller to so that the indicator disappears.

## Manual Focus



The camera's Full Range AF system offers continuous focusing ability from close-up to infinity. However, the correct focus may not be obtained depending on the shooting condition. In this case, use the manual focus mode.

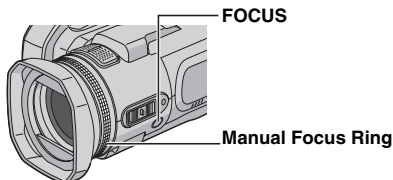

- 1 Set the power switch to .
- 2 Set the recording mode dial to other than **A** so that **M** is displayed.
- 3 Press **FOCUS**. The manual focus adjustment indicator appears.
- 4 To focus on a further subject, rotate the manual focus ring counterclockwise.

### Focusing on a further subject



To focus on a nearer subject, rotate the manual focus ring clockwise.

### Focusing on a nearer subject



**To return to automatic focus**

Press **FOCUS** again or set the recording mode dial to **M**.

**Manual focus is recommended in situations listed below;**

- When two subjects overlap in the same scene.
  - When illumination is low.\*
  - When the subject has no contrast (difference in brightness and darkness), such as a flat, one-colour wall, or a clear, blue sky.\*
  - When a dark object is barely visible in the display.\*
  - When the scene contains minute patterns or identical patterns that are regularly repeated.
  - When the scene is affected by sunbeams or light reflecting off the surface of a body of water.
  - When shooting a scene with a high-contrast background.
- \* The following low-contrast warnings appear blinking: ▲, ◀, ▶, and 👤.

## Manual Settings in MSET Menu



You can use manual recording functions easily by selecting items in the MSET menus.

**How to Select a Menu Item**

- 1 Set the power switch to **ON**.
- 2 Set the recording mode dial to other than **M** so that **M** is displayed.
- 3 Move the multi-controller to **▽** (**MSET**). The menu screen appears.
- 4 Select a desired item from the MSET menu with the multi-controller (**◀/▶**), then press **▶II**.

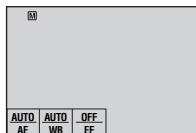

There are 3 items in the MSET menu.

**AE:** Manual Exposure (⇨ pg. 35)

**WB:** White Balance (⇨ pg. 35)

**EF:** Effect (⇨ pg. 36)

**Step 5 and 6 below are example of the manual exposure setting.**

- 5 Select a setting with the multi-controller (**◀/▶**), then press **▶II**. The setting is completed.
- 6 Close the MSET menu by moving the multi-controller to **▽** (**MSET**).

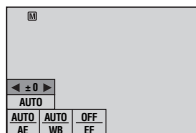
**NOTE:**

While recording is in progress, [EF] cannot be set even if the multi-controller is moved to **▽** (**MSET**).

## Manual Exposure

### Manual exposure is recommended in the following situations:

- When shooting using reverse lighting or when the background is too bright.
- When shooting on a reflective natural background such as at the beach or when skiing.
- When the background is overly dark or the subject is bright.

**1** Select [AE] in the MSET menu. (⇨ pg. 34)

**2** If [AUTO] is selected, move the multi-controller to  $\Delta$ . (video mode only)

**3** To brighten the image, move the multi-controller to  $\triangleright$ . To darken the image, move the multi-controller to  $\triangleleft$ .

- Adjustment range  
For video recording: -6 to +6 or AUTO (automatic exposure)

For still image recording: -2.0 to +2.0 (EV)

**4** Press **▶II**. The setting is completed.

**5** Close the MSET menu by moving the multi-controller to  $\nabla$  (MSET).

### To lock the exposure

After step **5**, press and hold **▶II** for over 2 seconds. The  $\square$  indicator appears.

### NOTES:

- You cannot use the manual exposure at the same time when the program AE function is set to  (Snow) (⇨ pg. 31), or with backlight compensation (⇨ pg. 31).
- If the adjustment does not cause any visible change in brightness, set [GAIN UP] to [ON]. (⇨ pg. 50)

## White Balance

The white balance is usually adjusted automatically for correctness of the colour reproduction under various lighting. However, you can also select the following modes according to the shooting situations.

**1** Select [WB] in the MSET menu. (⇨ pg. 34)

**2** Select the desired mode with the multi-controller ( $\Delta/\nabla$ ).

 **MWB**: For adjusting the white balance manually depending on the light source.

 "Manual White Balance Adjustment" (⇨ pg. 36)

 **FINE**: When shooting outdoors on a sunny day.

 **CLOUD**: When shooting outdoors on a cloudy day.

 **HALOGEN**: When a video light or similar type of lighting is used.

**3** Press **▶II**. The setting is completed.

**4** Close the MSET menu by moving the multi-controller to  $\nabla$  (MSET).

### To return to automatic white balance

Select [AUTO] in step **2**.

### Manual White Balance Adjustment

**1** Select [MWB] in WB menu.

**2** Hold a sheet of plain white paper in front of the subject. Adjust zoom or position yourself so that the white paper fills the screen.

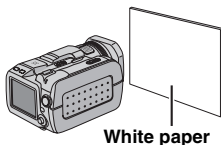

**3** Press and hold **▶II** until begins blinking then stops blinking.

#### NOTES:

- In step **2**, it may be difficult to focus on the white paper. In such a case, adjust with manual focusing. (▶ pg. 33)
- A subject can be shot under various types of lighting conditions indoors (natural, fluorescent, candlelight, etc.). Because the colour temperature is different depending on the light source, the subject tint will differ depending on the white balance settings. Use this function for a more natural result.
- Once you adjust white balance manually, the setting is retained even if the power is turned off or the battery is removed.

### Effect

You can add special effects to your recording images.

**1** Select [EF] in the MSET menu. (▶ pg. 34)

**2** Select the desired mode with the multi-controller ( $\Delta/\nabla$ ).

**SEPIA**: The image has a brownish tint like old photos.

B/W **MONOTONE**: The image becomes black and white like old movies.

**CLASSIC FILM**\*: The image has an old movie atmosphere by the effect of skipping frames.

**STROBE**\*: The image looks like a series of consecutive snapshots.

\* Not available for still image recording.

**3** Press **▶II**. The setting is completed.

**4** Close the MSET menu by moving the multi-controller to  $\nabla$  (**MSET**).



**To turn off the effect**  
Select [OFF] in step **2**.





## Wipe or Fader Effects





You can view videos with various effects of scene transition.

- 1 Set the power switch to .
- 2 Press **MODE** to select .
- 3 Press **MENU**. The menu screen appears.
- 4 Select [WIPE/FADER] with the multi-controller ( $\Delta/\nabla$ ), then press **▶II**.
- 5 Select a desired effect with the multi-controller ( $\Delta/\nabla$ ).

 **FADER-WHITE**: Fade in or out with a white screen.

 **FADER-BLACK**: Fade in or out with a black screen.

 **FADER-B.W**: Fade in to a colour screen from a black and white screen, or fade out from colour to black and white.

 **WIPE-CORNER**: Wipe in on a black screen from the upper right to the lower left corner, or wipe out from lower left to upper right, leaving a black screen.

 **WIPE-WINDOW**: The scene starts in the centre of a black screen and wipes in toward the corners, or comes in from the corners, gradually wiping out to the centre.

 **WIPE-SLIDE**: Wipe in from right to left, or wipe out from left to right.

 **WIPE-DOOR**: Wipe in as the two halves of a black screen open to the left and right, revealing the scene, or wipe out and the black screen reappears from left and right to cover the scene.

 **WIPE-SCROLL**: The scene wipes in from the bottom to the top of a black screen, or wipes out from top to bottom, leaving a black screen.

 **WIPE-SHUTTER**: Wipe in from the centre of a black screen toward the top and bottom, or wipe out from the top and bottom toward the centre leaving a black screen.

6 Press **▶II**. The setting is completed.

7 Press **MENU** to close the menu screen.

- The selected wipe or fader effect works when playback starts and ends.



### To turn off the effect

Select [OFF] in step 5.

## Playback Effects





You can view videos or still images with special image effects.

- 1 Set the power switch to .
- 2 Press **MODE** to select  or .
- 3 Press **MENU**. The menu screen appears.
- 4 Select [EFFECT] with the multi-controller ( $\Delta/\nabla$ ), then press **▶II**.
- 5 Select a desired effect with the multi-controller ( $\Delta/\nabla$ ).

 **SEPIA**: The image has a brownish tint like old photos.

B/W **MONOTONE**: The image becomes black and white like old movies.

 **CLASSIC FILM\***: The image has an old movie atmosphere by the effect of skipping frames.

 **STROBE\***: The image looks like a series of consecutive snapshots.

\* Not available for still image recording.

6 Press **▶II**. The setting is completed.

7 Press **MENU** to close the menu screen.

### To turn off the effect

Select [OFF] in step 5.

## Viewing File Information

You can view the file information in playback mode.

### Information on Video Files

Press **INFO** while video playback is paused. File information appears.

**FILE:** File name

**FOLDER:** Folder name

**DATE/TIME:** Date and time of the recording

**PB TIME:** Playback time (length of the file)

**QUALITY:** Image quality (⇄ pg. 50)

**PROTECT:** File protection status (⇄ pg. 39)

- If you press **INFO** on the index screen (⇄ pg. 22), information on the selected file is displayed.

#### To turn off the file information display

Press **INFO** repeatedly.

### Information on Still Image Files

Press **INFO** while a still image is displayed. File information appears.

**FILE:** File name

**FOLDER:** Folder name

**DATE/TIME:** Date and time of the recording

**SIZE:** Image size (⇄ pg. 51)

**QUALITY:** Image quality (⇄ pg. 51)

**PROTECT:** File protection status (⇄ pg. 39)

- If you press **INFO** on the index screen (⇄ pg. 27), information on the selected file is displayed.

#### To turn off the file information display

Press **INFO** repeatedly.

## Information on Voice Files

Press **INFO** while voice playback is paused. File information appears.

**FILE:** File name

**FOLDER:** Folder name

**DATE/TIME:** Date and time of the recording

**PB TIME:** Playback time (length of the file)

**QUALITY:** Sound quality (⇄ pg. 51)

**PROTECT:** File protection status (⇄ pg. 39)

- If you press **INFO** in the playback list (⇄ pg. 30), information on the selected file is displayed.

#### To turn off the file information display

Press **INFO** repeatedly.

## Histogram (for Still Image Files)

A histogram is a graph indicating the image's brightness. The horizontal axis indicates the brightness level (darker on the left and brighter on the right), while the vertical axis indicates how many pixels exist for each brightness level.

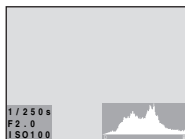

- The more pixels there are in centre position, the exposure is proper and the brightness is well-balanced.
- The more pixels there are toward the left, the darker the image.
- The more pixels there are toward the right, the brighter the image.

By checking the image and its histogram, you can see the exposure level pattern and the overall tone reproduction condition.

#### To display the histogram of still image files

Press **INFO** repeatedly while a still image is displayed.

#### To turn off the histogram display

Press **INFO** repeatedly.

### NOTE:

The shutter speed, F-number and ISO sensitivity (GAIN) are also displayed as recording information with histogram. The shutter speed displayed during shooting in auto mode is an approximation. It may not match the one displayed with histogram.

## Protecting Files



You can protect files from the accidental erasure.

- 1** Set the power switch to .
- 2** Press (and hold) **MODE** to select the file type (video, still image or voice).
- 3** Press **MENU**. The menu screen appears.
- 4** Select [PROTECT] with the multi-controller ( $\Delta/\nabla$ ), then press **►II**.

### To protect the currently displayed file

- 5** Select [CURRENT] with the multi-controller ( $\Delta/\nabla$ ), then press **►II**.
- 6** Select [EXECUTE] with the multi-controller ( $\Delta/\nabla$ ), then press **►II**.
  - You can select the previous or next file with the multi-controller ( $\triangleleft/\triangleright$ ).
  - To release protection, select the protected file, then perform step **5** and **6**.

### To protect by selecting multiple files

- 5** Select [FILE SELECT] with the multi-controller ( $\Delta/\nabla$ ), then press **►II**.
  - The index screen appears.
- 6** Select the file you want to protect with the multi-controller ( $\Delta/\nabla/\triangleleft/\triangleright$ ), then press **►II**.
  - The mark appears on the file.
  - To protect other files, repeat step **6**.
  - The scroll bar can also be used with the zoom lever and the multi-controller ( $\Delta/\nabla$ ). (☞ pg. 22, 27, 30)
  - If you slide the zoom lever towards **T**, the preview screen is displayed. Sliding the zoom lever towards **W** returns to the index screen.

**7** Press **MENU**.

- 8** Select [QUIT] with the multi-controller ( $\Delta/\nabla$ ), then press **►II**.
  - The selected files are protected.
  - To release protection, select the protected file in step **6**.

### To protect all files

- 5** Select [PROTECT ALL] with the multi-controller ( $\Delta/\nabla$ ), then press **►II**.
- 6** Select [EXECUTE] with the multi-controller ( $\Delta/\nabla$ ), then press **►II**.
  - All files are protected.

### To release protection of all files

- 5** Select [CANCEL ALL], then press **►II**.
- 6** Select [EXECUTE] with the multi-controller ( $\Delta/\nabla$ ), then press **►II**.

### CAUTION:



Do not remove the recording medium or perform any other operation (such as turning off the power) during protection. Also, be sure to use the provided AC adapter, as the recording medium may be corrupted if the battery becomes exhausted during protection. If the recording medium becomes corrupted, format it. (☞ pg. 19)

## Deleting Files



You can delete unnecessary files.

### Deleting by the Button

- 1 Set the power switch to .
- 2 Press (and hold) **MODE** to select the file type (video, still image or voice).
- 3 Display the desired file with the multi-controller ( $\Delta/\nabla/\langle/\rangle$ ), then press .
  - You can also select the file on the index screen (video or still image) or playback list (voice). (⇨ pg. 22, 27, 30)
- 4 Select [EXECUTE] with the multi-controller ( $\Delta/\nabla$ ), then press **▶II**.

#### NOTE:

If you press  during recording mode, the file recorded most recently will be deleted. However, if the recording mode (video, still image or voice) is switched or the power is turned off and on again after recording, you cannot delete the file.

### Deleting on the Menu Screen

- 1 Set the power switch to .
- 2 Press (and hold) **MODE** to select the file type (video, still image or voice).
- 3 Press **MENU**. The menu screen appears.
- 4 Select [DELETE] with the multi-controller ( $\Delta/\nabla$ ), then press **▶II**.

#### To delete the currently displayed file

- 5 Select [CURRENT] with the multi-controller ( $\Delta/\nabla$ ), then press **▶II**.
- 6 Select [EXECUTE] with the multi-controller ( $\Delta/\nabla$ ), then press **▶II**.
  - You can select the previous or next file with the multi-controller ( $\langle/\rangle$ ).

#### To delete by selecting multiple files

- 5 Select [FILE SELECT] with the multi-controller ( $\Delta/\nabla$ ), then press **▶II**.
  - The index screen (video or still image) or playback list (voice) appears.
- 6 Select the file you want to delete with the multi-controller ( $\Delta/\nabla/\langle/\rangle$ ), then press **▶II**.
  - To select other files, repeat step 6.
  - The scroll bar can also be used with the zoom lever and the multi-controller ( $\Delta/\nabla$ ). (⇨ pg. 22, 27, 30)
  - If you slide the zoom lever towards **T**, the preview screen is displayed. Sliding the zoom lever towards **W** returns to the index screen.
- 7 Press **MENU**.
- 8 Select [EXECUTE AND QUIT] with the multi-controller ( $\Delta/\nabla$ ), then press **▶II**.
  - The selected files are deleted.

#### To delete all files

- 5 Select [DELETE ALL] with the multi-controller ( $\Delta/\nabla$ ), then press **▶II**.
- 6 Select [EXECUTE] with the multi-controller ( $\Delta/\nabla$ ), then press **▶II**.
  - To cancel deletion, select [CANCEL], then press **▶II**.

#### NOTES:

- Protected files cannot be deleted. To delete them, release protection first. (⇨ pg. 39)
- Once files are deleted, they cannot be restored. Check files before deleting.

#### CAUTION:

Do not remove the recording medium or perform any other operation (such as turning off the power) during deletion. Also, be sure to use the provided AC adapter, as the recording medium may be corrupted if the battery becomes exhausted during deletion. If the recording medium becomes corrupted, format it. (⇨ pg. 19)

## Cleaning Up a Recording Medium



Writing speed of recording media tends to become slow after long period of repeated use. To regain the speed, execute cleanup periodically. The cleanup function is equivalent to "Defragmentation" of PC's function.

### NOTE:

Make sure to use the provided AC adapter for the power supply when cleaning up a recording medium. (☞ pg. 15)

- 1 Set the power switch to or .
- 2 Press **MENU**. The menu screen appears.
- 3 Select [MEMORY CARD SETTING] with the multi-controller ( $\Delta/\nabla$ ), then press **▶II**.
- 4 Select [CLEAN UP] with the multi-controller ( $\Delta/\nabla$ ), then press **▶II**.
- 5 Select [CF SLOT] or [SD SLOT] with the multi-controller ( $\Delta/\nabla$ ), then press **▶II**.
  - If the AC adapter is not connected to the camera, a warning message appears. In this case, connect the AC adapter.
- 6 Select [EXECUTE] with the multi-controller ( $\Delta/\nabla$ ), then press **▶II**.
  - To cancel cleanup, select [CANCEL], then press **▶II**.
- 7 When cleanup is finished, [CLEANING UP COMPLETED] appears. Press **▶II** to complete the operation.
  - It may take for a while until cleanup is completed.

### CAUTION:

Do not remove the recording medium or perform any other operation (such as turning off the power) during cleanup.

## Copying/Moving Still Image Files



You can copy or move still image files between recording media in CF and SD slots using the on-screen display.

### Before proceeding to following steps,

- Make sure that recording media are inserted in both CF and SD slots.
- Make sure that enough free space is left in the copy/move destination medium.

- 1 Set the power switch to or .
- 2 Press **MENU**. The menu screen appears.
- 3 Select [MEMORY CARD SETTING] with the multi-controller ( $\Delta/\nabla$ ), then press **▶II**.
- 4 Select [COPY/MOVE] with the multi-controller ( $\Delta/\nabla$ ), then press **▶II**.
- 5 Select [COPY] or [MOVE] with the multi-controller ( $\Delta/\nabla$ ), then press **▶II**.

**COPY:** Files are copied to the destination medium while leaving original files in the source medium.

**MOVE:** Files are moved to the destination medium while deleting original files (except read-only files) in the source medium.

- 6 Select the direction of copy/move with the multi-controller ( $\triangleleft/\triangleright$ ), then move the multi-controller to  $\nabla$ . (SD  $\rightarrow$  CF or CF  $\rightarrow$  SD)

**To copy or move by selecting files**

**7** Select [FILE] with the multi-controller (</>), then press ►II.

- The index screen appears.

**8** Select a desired file with the multi-controller (Δ/▽/</>), then press ►II.

- The check mark (✓) appears on the selected file.
- To select other files, repeat this step.
- The scroll bar can also be used with the zoom lever and Δ/▽. (→ pg. 28)

**9** Press **MENU** to return to the previous screen.

**10** Select [EXECUTE] with the multi-controller (Δ/▽), then press ►II.

**11** File transfer starts.

- To stop the file transfer, press ►II, then select [EXECUTE] and press ►II.

**12** When [COPYING (MOVING) COMPLETED] appears, press ►II to finish the operation.

**To copy or move all still image files in the recording medium**

**7** Select [ALL] with the multi-controller (</>).

**8** Select [EXECUTE] with the multi-controller (Δ/▽), then press ►II.

- If you want to cancel, select [CANCEL], then press ►II.

**9** File transfer starts.

- To stop the file transfer, press ►II, then select [EXECUTE] and press ►II.

**10** When [COPYING (MOVING) COMPLETED] appears, press ►II to finish the operation.

**Resetting the File Number**

By resetting the file number (name), a new folder will be made. The new files you are going to make will be stored in the new folder. It is convenient to separate the new files from previously recorded files.

**1** Set the power switch to or .

**2** Press **MENU**. The menu screen appears.

**3** Select [MEMORY CARD SETTING] with the multi-controller (Δ/▽), then press ►II.

**4** Select [NO. RESET] with the multi-controller (Δ/▽), then press ►II.

**5** Select the file type (video, still image or voice) with the multi-controller (Δ/▽), then press ►II.

**6** Select [EXECUTE] with the multi-controller (Δ/▽), then press ►II.



**7** Press ►II.

- The new folder (such as [101JVC50]) will be made and the file number will start again from the new number (such as "PIC\_0001.JPG").

## Creating Play List



You can create a play list by collecting the desired scenes from the previously recorded video files.

- 1** Set the power switch to .
- 2** Press **MODE** to select .
- 3** Press **MENU**. The menu screen appears.
- 4** Select [PLAY LIST] with the multi-controller ( $\Delta/\nabla$ ), then press **▶II**.
- 5** Select [EDIT] with the multi-controller ( $\Delta/\nabla$ ), then press **▶II**.
- 6** Select [NEW LIST] with the multi-controller ( $\Delta/\nabla$ ), then press **▶II**.
- 7** Scroll upward or downward the thumbnail images of recorded files with the multi-controller ( $\Delta/\nabla$ ), and select a file to be added to a play list.
  - The scroll bar can also be used with the zoom lever and the multi-controller ( $\Delta/\nabla$ ).

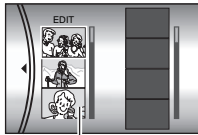

Thumbnail images of recorded files

- 8** Press **▶II**. The frame for selecting an inserting point appears.

- 9** Scroll upward or downward the thumbnail of images in a play list with the multi-controller ( $\Delta/\nabla$ ), and select a position where you want to insert the selected file.

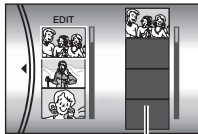

Play list

- The scroll bar can also be used with the zoom lever and the multi-controller ( $\Delta/\nabla$ ). (☞ pg. 22)
- 10** Press **▶II**. The selected file is added to a play list.
    - To add other files, repeat steps **7** to **10**.
  - 11** Press **MENU**. The confirmation screen appears.
  - 12** Select [SAVE AND QUIT] with the multi-controller ( $\Delta/\nabla$ ), then press **▶II**.
    - To return to the edit screen, select [CANCEL].
    - If you do not want to save the play list, select [DELETE AND QUIT].

## To check the play list by playing back the video

You can check the play list before saving it.

- 1** After step **10**, select a thumbnail image of the play list with the multi-controller ( $\triangleright$ ).
- 2** Select a scene you want to check with the multi-controller ( $\Delta/\nabla$ ).
- 3** Press **▶II**. The playback of the play list starts from the selected scene.
  - The playback stops at the end of the play list automatically.
  - To stop playback midway, press **▶II**, then slide the zoom lever towards **W**.

## To check only the scene transition

- 1** After step **10**, select a scene transition with the multi-controller ( $\triangleright$ ).
  - If a scene is selected, move the multi-controller to  $\triangleright$  once more to select the scene transition bar.
- 2** Select a scene transition you want to check with the multi-controller ( $\Delta/\nabla$ ).
- 3** Press **▶II** to start playback of the selected scene transition.

## To delete the added file from the play list

- 1** After step **10**, select a thumbnail image of the play list with the multi-controller ( $\triangleright$ ).
- 2** Select the file you want to delete with the multi-controller ( $\Delta/\nabla$ ), then press .



## NOTES:

- The play list can be created up to 99.
- If you delete the original files, the files also have been deleted from the play list.

## Playing Back Play List



By playing back the play list, you can view your original video clips. (To create play list, [⇨ pg. 43](#))

- 1** Set the power switch to .
- 2** Press **MODE** to select .
- 3** Press **MENU**. The menu screen appears.
- 4** Select [PLAY LIST] with the multi-controller ( $\Delta/\nabla$ ), then press **▶II**.
- 5** Select [PLAY LIST CONTENTS] with the multi-controller ( $\Delta/\nabla$ ), then press **▶II**. The table of play lists appears.
- 6** Select a list you want to play back with the multi-controller ( $\Delta/\nabla$ ). (The display format of date and time differs depending on the country where this camera is sold.)

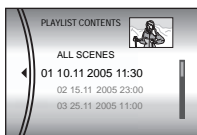

- The scroll bar can also be used with the zoom lever and the multi-controller ( $\Delta/\nabla$ ). ([⇨ pg. 22](#))



- 7** Press **▶II** to start playback.
  - During playback of play list, "P" mark appears on the top left corner of the screen.
  - If you slide the zoom lever towards **W** while playback is paused, the index screen for play list appears. You can see the contents of the play list and select the desired scene. To return to playback screen, slide the zoom lever to **T**.
  - You can use various playback functions during playback. ([⇨ pg. 23](#))
- 8** To stop playback, press **▶II**.
- To return to the normal playback mode, select [ALL SCENES] in step **6**.

### NOTE:

The on-screen display cannot be turned off during playback of play list.



## Add/Delete Files in Play List

You can edit existing play lists by adding or deleting files.

- 1** Set the power switch to .
- 2** Press **MODE** to select .
- 3** Press **MENU**. The menu screen appears.
- 4** Select [PLAY LIST] with the multi-controller ( $\Delta/\nabla$ ), then press **▶II**.
- 5** Select [EDIT] with the multi-controller ( $\Delta/\nabla$ ), then press **▶II**.
- 6** Select the play list you want to edit with the multi-controller ( $\Delta/\nabla$ ), then press **▶II**.
  - To add or delete files, follow the steps **7** to **12** in "Creating Play List" ([⇨ pg. 43](#)) or **1** to **2** in "To delete the added file from the play list" ([⇨ pg. 43](#)).

## Changing Play List Name



The default name of play list is its creation date and time. You can change the name on the keyboard screen as you like.

- 1** Set the power switch to .
- 2** Press **MODE** to select .
- 3** Press **MENU**. The menu screen appears.
- 4** Select [PLAY LIST] with the multi-controller ( $\Delta/\nabla$ ), then press **▶II**.
- 5** Select [RENAME] with the multi-controller ( $\Delta/\nabla$ ), then press **▶II**. The table of play lists appears.
- 6** Select a play list whose name you want to change with the multi-controller ( $\Delta/\nabla$ ).
  - The scroll bar can also be used with the zoom lever and the multi-controller ( $\Delta/\nabla$ ). ([⇨ pg. 22](#))
  - The thumbnail appears on the upper right side.
- 7** Press **▶II**. The keyboard screen appears.
- 8** Select the desired letter with the multi-controller ( $\Delta/\nabla/\langle/\rangle$ ), then press **▶II**.
  - Repeat this process to complete the name.
  - You can change the character types (capital letters, small letters or marks) by selecting [A/a/@].
  - To correct a letter, select [ $\leftarrow$ ] or [ $\rightarrow$ ] and press **▶II** to move the cursor to the letter, then select [CLEAR] and press **▶II**.
- 9** Select  $\leftarrow$  with the multi-controller ( $\Delta/\nabla/\langle/\rangle$ ), then press **▶II**.
  - To cancel the setting, select [CANCEL], then press **▶II**.





## Deleting Play List

You can delete unnecessary play lists.

- 1** Set the power switch to .
- 2** Press **MODE** to select .
- 3** Press **MENU**. The menu screen appears.
- 4** Select [PLAY LIST] with the multi-controller ( $\Delta/\nabla$ ), then press **▶II**.
- 5** Select [DELETE] with the multi-controller ( $\Delta/\nabla$ ), then press **▶II**. The table of play lists appears.
- 6** Select a play list you want to delete with the multi-controller ( $\Delta/\nabla$ ).
  - The thumbnail appears on the upper right side.
  - To delete all play lists at once, select [DELETE ALL].
- 7** Press **▶II**.
- 8** Select [EXECUTE] with the multi-controller ( $\Delta/\nabla$ ), then press **▶II**. The selected play list is deleted.
  - To cancel the setting, select [CANCEL], then press **▶II**.
  - Original files are not deleted even if you delete the play list.

## Dubbing Using Play List

Dubbing to an external device using a play list is possible.

- 1** Connect the camera and your VCR with the S-Video/Audio/Video cable. (→ pg. 24)
- 2** Set the VCR to VIDEO/AUXILIARY input and engage the recording standby mode.
  - For details how to set VIDEO/AUXILIARY input refer to VCR instructions.
- 3** Set the power switch to .
- 4** Press **MODE** to select .
- 5** Press **MENU**. The menu screen appears.
- 6** Select [PLAY LIST] with the multi-controller ( $\Delta/\nabla$ ), then press **▶II**.
- 7** Select [PLAY LIST CONTENTS] with the multi-controller ( $\Delta/\nabla$ ), then press **▶II**. The table of play lists appears.
- 8** Select a list you want to dub with the multi-controller ( $\Delta/\nabla$ ).
  - The scroll bar can also be used with the zoom lever and the multi-controller ( $\Delta/\nabla$ ). (→ pg. 22)
- 9** Move the multi-controller to  $\triangleright$ . Screen for dubbing appears.
- 10** Select [START PLAYBACK] with the multi-controller ( $\Delta/\nabla$ ), then press **▶II**. Playback on the camera starts.
  - The black screen is displayed for 5 seconds at the beginning and the end of the play list playback.
  - To cancel the setting, select [CANCEL] with the multi-controller ( $\Delta/\nabla$ ), then press **▶II**.
- 11** While the black screen is displayed for 5 seconds, start recording on the VCR. (Refer to your VCR's instruction manual.)
- 12** To stop dubbing, stop recording on the VCR while the black screen is displayed for 5 seconds.

## DPOF Print Setting



This camera is compatible with DPOF (Digital Print Order Format). You can set which images to be printed and the number of prints with this camera. This feature is useful to print with a DPOF-compatible printer or bring a recording medium to photo lab for print.

### To print by selecting a still image

- 1 Set the power switch to .
- 2 Press **MODE** to select .
- 3 Press **MENU**. The menu screen appears.
- 4 Select [DPOF] with the multi-controller ( $\Delta/\nabla$ ), then press **►II**. The DPOF menu screen appears.
- 5 Select [SELECT IMAGES] with the multi-controller ( $\Delta/\nabla$ ), then press **►II**.

6 Select the desired file with the multi-controller ( $\Delta/\nabla/\langle/\rangle$ ), then press **►II**.

- The scroll bar can also be used with the zoom lever and the multi-controller ( $\Delta/\nabla$ ). (⇨ pg. 28)
- If you slide and hold the zoom lever towards **T**, the preview screen of the still image is displayed.

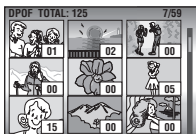

- 7 Select the number of prints (max. 15 prints) with the multi-controller ( $\langle/\rangle$ ), then press **►II**.
- To set print information for other images, repeat steps **6** and **7**.

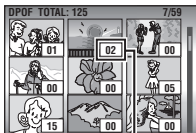

Number of prints

- 8 Press **MENU** to finish the setting.
- To cancel the selection, select the same image in step **6**.

### NOTE:

The DPOF setting is available up to 999 images.

### To print all still images (One print for each)

- 1 Display the DPOF menu screen. (⇨ “To print by selecting a still image”)
- 2 Select [ALL 1] with the multi-controller ( $\Delta/\nabla$ ), then press **►II**.
- 3 Select [EXECUTE] with the multi-controller ( $\Delta/\nabla$ ), then press **►II**.
- 4 Press **MENU** to finish the setting.

### To confirm the DPOF setting

- 1 Display the DPOF menu screen. (⇨ “To print by selecting a still image”)
- 2 Select [CHECK SETTINGS] with the multi-controller ( $\Delta/\nabla$ ), then press **►II**.
- 3 If necessary, change the number of prints for the desired file by following the steps **6** to **7** in “To print by selecting a still image”.
- 4 Press **MENU** to return to the previous menu.

### To reset the DPOF setting

- 1 Display the DPOF menu screen. (⇨ “To print by selecting a still image”)
- 2 Select [RESET] with the multi-controller ( $\Delta/\nabla$ ), then press **►II**.
- 3 Select [EXECUTE] with the multi-controller ( $\Delta/\nabla$ ), then press **►II**.
- 4 Press **►II** to finish the reset.

## Direct Printing with a PictBridge Printer



If your printer is compatible with PictBridge, still images can be printed easily by connecting the camera with the USB cable directly to the printer. DPOF setting can also be used.

(*☞* pg. 46)

### NOTE:

After selecting [DIRECT PRINT] in the menu, connect the USB cable.

### To print by selecting a still image

- 1 Set the power switch to .
- 2 Press **MODE** to select .
- 3 Press **MENU**. The menu screen appears.
- 4 Select [DIRECT PRINT] with the multi-controller ( $\Delta/\nabla$ ), then press **▶II**. A message [PLEASE CONNECT PRINTER] appears.
- 5 Connect the camera to the printer with the USB cable.
  - After a while, the print menu appears.
- 6 Select [SELECTED PRINT] with the multi-controller ( $\Delta/\nabla$ ), then press **▶II**.
- 7 Select the desired file with the multi-controller ( $\triangleleft/\triangleright$ ), then press **▶II**.
- 8 Set the number of prints with the multi-controller ( $\triangleleft/\triangleright$ ).
  - The number of prints can be set from 1 to 99.
- 9 Select [DATE] with the multi-controller ( $\Delta/\nabla$ ), then select [ON] or [OFF] with the multi-controller ( $\triangleleft/\triangleright$ ).
  - Select [ON] to print the date or [OFF] not to print.
- 10 Select [PRINT] with the multi-controller ( $\Delta/\nabla$ ), then press **▶II**. The image is printed.

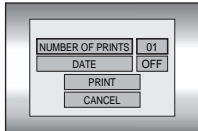

### To cancel print setting



Select [CANCEL] with the multi-controller ( $\Delta/\nabla$ ), then press **▶II**.

### To stop printing after printing starts

- 1 Press **▶II**. The confirmation screen appears.
- 2 Select [EXECUTE] with the multi-controller ( $\Delta/\nabla$ ), then press **▶II**.

### To print using the DPOF setting

If the printer is compatible with DPOF, you can use the DPOF setting. (*☞* pg. 46)

- 1 Set the power switch to .
- 2 Press **MODE** to select .
- 3 Press **MENU**. The menu screen appears.
- 4 Select [DIRECT PRINT] with the multi-controller ( $\Delta/\nabla$ ), then press **▶II**. A message [PLEASE CONNECT PRINTER] appears.
- 5 Connect the camera to the printer with the USB cable.
  - After a while, the print menu appears.
- 6 Select [DPOF PRINT] with the multi-controller ( $\Delta/\nabla$ ), then press **▶II**.
- 7 Select [PRINT] with the multi-controller ( $\Delta/\nabla$ ), then press **▶II**. The images are printed.
  - To confirm the DPOF setting, select [CHECK SETTINGS] with the multi-controller ( $\Delta/\nabla$ ), then press **▶II**. After that, press **MENU** to return to the previous menu.

### NOTE:

If the printer is not recognised, or to print again after direct printing with a PictBridge printer, remove the USB cable, select [DIRECT PRINT] in the menu again, and then reconnect the cable.

## Changing the Menu Settings

You can change the menu settings to customize your camera. Access the desired menu screen by following the steps below, then change the various settings.

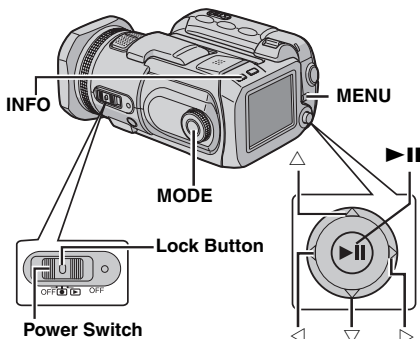

**1** Select the operation mode.

### For Recording Menus:

Set the power switch to .

### For Playback Menus:

Set the power switch to .

**2** Press **MODE** to select (video), (still image) or (voice).

**3** Press **MENU**. The menu screen appears.

**4** Select the desired sub menu and menu item with the multi-controller (, ) and .

- To return to the normal screen, press **MENU**.
- To display the operation guide, press **INFO** when the menu screen is displayed. (The operation guide is not displayed depending on the type of the menu.) To remove the operation guide, press **INFO** again.
- Even if the menu item is displayed, some item cannot be set depending on the selected mode (video/still image/voice, recording/playback). In this case, sub menu cannot be accessed or setting cannot be changed.

## Common Menus for All Modes

[ ] = Factory-preset

### BASIC SETTING

#### PRESET

**EXECUTE:** Resets all settings to the factory-preset.

**[CANCEL]:** Returns to menu screen without executing reset.

#### DEMO MODE

**OFF:** Disables the function.

**[ON]:** Activates demonstration mode and shows various features on the display.

Demonstration starts in the following cases:

- When the menu screen is closed after [DEMO MODE] is set to [ON].
- With [DEMO MODE] set to [ON], if there is no operation for about 3 minutes after the power switch is set to .
- Performing any operation during the demonstration stops the demonstration temporarily. If no operation is performed for more than 3 minutes after that, the demonstration will resume.

#### NOTES:

- If a recording medium is in the camera, demonstration will not take place even if it set to [ON].
- [DEMO MODE] remains [ON] even if the camera power is turned off.

#### OPERATION SOUND

**OFF:** Turns off operation sound.

**BEEP:** The beep sounds when the power is turned on or off, and at the beginning and end of recording.

**[MELODY]:** Instead of a beep, a melody sounds when any operation is performed.

## ✿ MEMORY CARD SETTING

### VIDEO MODE

[CF SLOT] / SD SLOT

### IMAGE MODE

[CF SLOT] / SD SLOT

### VOICE MODE

[CF SLOT] / SD SLOT

Media selection can be set for each recording and playback mode: video (📹), still image (📷) or voice (🎤).

CF SLOT: The CF card is selected as a recording medium.

SD SLOT: SD card is selected as a recording medium.

### FORMAT

[CF SLOT] / SD SLOT

You can format (initialise) a recording medium in the CF or SD slot. (⇨ pg. 19)

### CLEAN UP

[CF SLOT] / SD SLOT

Writing speed of recording media tends to become slow after long period of repeated use. To regain the speed, execute cleanup periodically. (⇨ pg. 41)

### COPY/MOVE

COPY / MOVE

You can copy or move still image files between recording media in CF and SD slots. (⇨ pg. 41)

### NO. RESET

VIDEO / IMAGE / VOICE

By resetting the file number (name), a new folder will be made. The new files you are going to make will be stored in the new folder. (⇨ pg. 42)

## ⊕ DISPLAY

### BRIGHT

When this item is selected, the brightness control indicator appears. Adjust the brightness of the display using the multi-controller (◀▶), then press ▶II.

### DATE/TIME

**OFF:** The date/time does not appear.

**[AUTO]:** Displays the date/time for approx. 5 seconds in the following cases.

- When the power switch is set from **OFF** to
- When playback starts
- When the date is changed during playback

**ON:** The date/time is always displayed.

### NOTES:

- The date/time is always displayed for voice mode and the only date is displayed for the video playback.
- You can set to different setting for each mode (video recording/playback and still image recording/playback).

### SCENE COUNTER

**[OFF]:** Disables the function.

**ON:** Displays the counter during video mode.

### LANGUAGE

(except GZ-MC500EK for U.K. model)

**[ENGLISH] / FRANÇAIS / DEUTSCH / ESPAÑOL / ITALIANO / NEDERLANDS**

The language setting can be changed. (⇨ pg. 16)

### CLOCK ADJUST

⇨ "Date/Time Settings" (⇨ pg. 17)

## Video Recording Menus

[ ] = Factory-preset

### QUALITY

Select the desired picture quality.

Mode (In order of the quality)	Size (pixels)	Bit rate
<b>[ULTRA FINE]</b>	720 x 576	8.5 Mbps
<b>FINE</b>	720 x 576	5.5 Mbps
<b>NORMAL</b>	720 x 576	4.2 Mbps
<b>ECONOMY</b>	352 x 288	1.5 Mbps

### WIDE MODE

[OFF]: Disables the function.

**16:9 WIDE:** For playback on TVs with an aspect ratio of 16:9. Naturally expands the image to fit the screen without distortion. The  indicator appears. When using this mode, refer to your wide-screen TV's instruction manual. During playback/recording on 4:3 TVs/LCD monitor, black bands are inserted at the top and bottom of the screen.

### NOTES:

- The 16:9 WIDE mode cannot be used when using ECONOMY mode.
- The provided software PowerDVD can automatically play back the image with an aspect ratio of 16:9.

### WIND CUT

[OFF]: Disables the function.

**ON:** Helps cut down on noise created by wind. The  indicator appears.

### GAIN UP

**OFF:** The image in the dark will be recorded with no picture brightness adjustment.

**[ON]:** The image in the dark will be brightened. But the overall appearance may become grainy.

### DIS

**OFF:** Disables the function.

**[ON]:** Compensates for unstable images caused by camera-shake, particularly at high magnification. The  indicator appears.

### NOTES:

- Accurate stabilization may not be possible if hand shake is excessive, or depending on the shooting condition. In this case, the  indicator blinks or goes out.
- Switch off this mode when recording with the camera on the tripod.

## CAMERA SETTING

### ZOOM

**10X:** Only optical zoom is available up to 10X.

**[40X]:** Digital zoom is available up to 40X.

**200X:** Digital zoom is available up to 200X.

### NOTE:

Zooming is possible up to 8X regardless of the ZOOM setting in the still image recording mode.

### TELE MACRO

[OFF]: Disables the function.

**ON:** You can shoot a subject as large as possible at a distance of approx. 70 cm. The  indicator appears.

## Video Playback Menus

[ ] = Factory-preset

### PLAY LIST

**PLAY LIST CONTENTS / EDIT / RENAME / DELETE**

You can create a play list and view your original video clips. (⇨ pg. 43 – 45)

### WIPE/FADER

⇨ "Wipe or Fader Effects" (⇨ pg. 37)

### EFFECT

⇨ "Playback Effects" (⇨ pg. 37)

### PROTECT

**[CURRENT] / FILE SELECT / PROTECT ALL / CANCEL ALL**

You can protect files from accidental erasure. (⇨ pg. 39)

### DELETE

**[CURRENT] / FILE SELECT / DELETE ALL**

You can delete unnecessary files. (⇨ pg. 40)

## Still Image Recording Menus

[ ] = Factory-preset

### QUALITY

[FINE] / STANDARD

Select the desired image quality.

### IMAGE SIZE

[2560 x 1920] / 2048 x 1536 / 1600 x 1200 /  
1280 x 960 / 640 x 480



Select the desired image size.

### NOTE:

In 2560 x 1920 mode, the data is converted and stored in its file size.

### SELF-TIMER

[OFF] / 2SEC / 10SEC

By setting the self-timer, a still image is recorded 2 or 10 seconds after pressing recording start/stop button. The  or  indicator appears.

### GAIN

[AUTO] / 100 / 200 / 400

Select the ISO sensitivity to the desired setting. When set to [AUTO], the sensitivity automatically increases in dark conditions.

### NOTE:

The amount of image noise increases as the setting level increases.

## CAMERA SETTING

### TELE MACRO

The menu item of TELE MACRO is the same as in the description on page 50.



## Still Image Playback Menus

[ ] = Factory-preset

### DPOF

 "DPOF Print Setting" ( pg. 46)

### DIRECT PRINT

 "Direct Printing with a PictBridge Printer" ( pg. 47)

### EFFECT

 "Playback Effects" ( pg. 37)

### PROTECT

### DELETE

The menu items of PROTECT and DELETE are the same as in the description on page 50.

## Voice Recording Menus

[ ] = Factory-preset

### QUALITY

Select the desired sound quality.

Mode (In order of the quality)	Recording mode	Bit rate
[48] FINE	48 kHz	1,536 kbps
[16] STANDARD	16 kHz	512 kbps
[8] ECONOMY	8 kHz	256 kbps

### RECORDING LEVEL

[] HIGH / [] MIDDLE / [] LOW

Select the desired voice recording level.

### WIND CUT

The menu item of WIND CUT is the same as in the description on page 50.

## Voice Playback Menus

[ ] = Factory-preset

### PLAYBACK SPEED

Select the desired voice playback speed.

[] NORMAL: Normal speed

[] FASTPLAY: Playback speed is 20% faster than normal speed.

[] SLOWPLAY: Playback speed is 20% slower than normal speed.

### PROTECT

### DELETE

The menu items of PROTECT and DELETE are the same as in the description on page 50.

## Troubleshooting

The camera is a microcomputer-controlled device. External noise and interference (from a TV, a radio, etc.) might prevent it from functioning properly.

→ To solve the problem, follow the Instructions below at first.

→ If the problem is not solved, reset the camera. (Refer to "To reset the camera" below.)

→ If the problem still exists, please consult your nearest JVC dealer.

### ■ To reset the camera

- ① Press the reset hole using a piece of wire or other such pointed instrument. The power is turned off once and turned on again automatically.

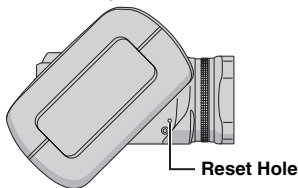

- ② If nothing happens, set the power switch to **OFF** and remove the power supply (battery pack or AC adapter) from the camera, then put it back again.

## Power

### No power is supplied.

- The power is not connected properly.
- Connect the AC adapter securely. (⇨ pg. 14)
- The battery pack is not attached firmly.
- Detach the battery pack once again and re-attach it firmly. (⇨ pg. 14)
- The battery is dead.
- Replace the dead battery with a fully charged one. (⇨ pg. 14)

## Recording

### Recording cannot be performed.

- [MEMORY CARD IS FULL] appears.
- Replace with new recording medium or delete unnecessary files. (⇨ pg. 17, 18, 40)
- Recording medium is not selected properly.
- Select the recording medium. (⇨ pg. 19, 48, 49)
- The battery/CF card cover is open.
- Close the cover.

### When shooting a subject illuminated by bright light, vertical lines appear.

- This is not a malfunction.

### When the screen is under direct sunlight during shooting, the screen becomes red or black for an instant.

- This is not a malfunction.

### During recording, the date/time does not appear.

- [DATE/TIME] is set to [OFF].
- Set [DATE/TIME] to [ON]. (⇨ pg. 49)

### The LCD monitor indications blink.

- Certain modes of program AE, effect, DIS and other functions that cannot be used together are selected at the same time.

### Digital zoom does not work.

- [ZOOM] is set to [10X] (optical zoom).
- Set [ZOOM] to [40X] or [200X]. (⇨ pg. 50)
- Digital zoom is not available in the still image recording mode.



## Playback

### Playback cannot be performed.

- Recording medium is not selected properly.
- Select the recording medium. (⇨ pg. 19, 48, 49)
- The battery/CF card cover is open.
- Close the cover.
- Playback starts, but there is no picture on the connected TV.
- Set the TV's input mode or channel appropriate for video playback.

### The same image is displayed for a long time during video playback, or motion is choppy. There are periods of silence during voice playback.

- If the surface of the removable hard disk is damaged, it makes difficult to read data and these phenomena will appear. This camera will make all possible efforts to read data, but when such a state continues for some time, and further playback is impossible, it will stop automatically.

## Advanced features

### The focus does not adjust automatically.

- Focus is set to the manual mode.
- Set focus to the automatic mode. (⇨ pg. 34)
- The lens is dirty or covered with condensation.
- Clean the lens and check the focus again. (⇨ pg. 57)

### The colour of the image looks strange.

- The light source or the subject does not include white. Or there are various different light sources behind the subject.
- Try manual white balance adjustment. (⇨ pg. 35)

### The recorded image is too dark.

- Shooting was performed under backlit conditions.
- Try backlight compensation (⇨ pg. 31) or manual exposure (⇨ pg. 35).

### The recorded image is too bright.

- The subject is too bright.
- Try manual exposure. (⇨ pg. 35)

### White balance setting cannot be activated.

- The sepia (SEPIA) or monotone (MONOTONE) mode is activated.
- Turn off the sepia (SEPIA) or monotone (MONOTONE) mode before setting white balance. (⇨ pg. 36)

### The black & white fader does not work.

- The sepia (SEPIA) or monotone (MONOTONE) mode is activated.
- Turn off the sepia (SEPIA) or monotone (MONOTONE) mode. (⇨ pg. 37)

### The image looks like the shutter speed is too slow.

- When shooting in the dark, the unit becomes highly sensitive to light when [GAIN UP] is set to [ON].
- If you want the lighting to look more natural, set [GAIN UP] to [OFF]. (⇨ pg. 50)

### The continuous shooting speed of still images is slow.

- The continuous shooting speed will drop when repeatedly making continuous shots, when using certain recording medium, or under certain recording conditions. (⇨ pg. 26)

## Other problems

### The power/charge lamp on the camera does not light during charging.

- Charging is difficult in places subject to extremely high/low temperatures.
- To protect the battery, it is recommended to charge it in places with a temperature of 10°C to 35°C. (☞ pg. 58)
- The battery/CF card cover is open.
- Close the cover. (☞ pg. 14)

### The data process is too slow after the power is switched on or the mode is changed.

- There is a large number of still images (approx. 1,000 or more) stored in the recording medium.
- Copy the stored files to a PC, and delete them from the recording medium.

### [SET DATE/TIME!] appears.

- The built-in clock's rechargeable lithium battery is discharged.
- The previously set date/time is erased.
- Connect the camera to an AC outlet using the AC adapter for over 24 hours to charge the clock's lithium battery. Then set the date/time. (☞ pg. 17)

### Files cannot be deleted.

- Files are protected.
- Remove protection from the files and delete them. (☞ pg. 39, 50)

### When the image is printed from the printer, a black bar appears at the bottom of the screen.

- This is not a malfunction.
- By recording with DIS activated, this can be avoided. (☞ pg. 50)

### Images on the LCD monitor appear dark or whitish.

- In places subject to low temperature, images become dark due to the characteristics of the LCD monitor. This is not a malfunction.
- Adjust the brightness and angle of the LCD monitor. (☞ pg. 21, 49)
- When the LCD monitor's fluorescent light reaches the end of its service life, images on the LCD monitor become dark.
- Consult your nearest JVC dealer.

### Coloured bright spots appear all over the LCD monitor.

- The LCD monitor is made with high precision technology. However, black spots or bright spots of light (red, green or blue) may appear constantly on the LCD monitor. These spots are not recorded on the picture. This is not due to any defect of the unit. (Effective dots: more than 99.99 %)

### The SD card cannot be removed from the camera.

- Push in the SD card a few more times. (☞ pg. 18)

### Picture does not appear on the LCD monitor.

- The LCD monitor's brightness setting is too dark.
- Adjust the brightness of the LCD monitor. (☞ pg. 49)

## Warning Indications

The following indications appear on the screen.

### (Battery indicator)

Displays the battery remaining power.

Remaining power level

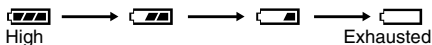

- As the battery power comes close to nil, the battery indicator blinks. When the battery power is exhausted, power turns off automatically.

### SET DATE/TIME!

- Appears when the date/time is not set. (⇨ pg. 17)
- Appears when the built-in clock (lithium) battery is discharged and the previously set date/time is erased. (⇨ pg. 17)

### LENS CAP

Appears for 5 seconds after power is turned on with the power switch set to , if the lens cap is attached or when it is dark.

### PLEASE INSERT MEMORY CARD

Appears when no recording medium is inserted in the selected slot. (⇨ pg. 17, 18)

### THIS CARD IS NOT FORMATTED

Appears when an unformatted recording medium is inserted.

### MEMORY CARD IS FULL

Appears when the recording medium is full and recording is not possible.

### CHECK CARD'S WRITE PROTECTION SWITCH

Appears when you attempt recording when the write protection tab on the SD card is set to the "LOCK" position. (⇨ pg. 18)

### THIS CARD IS NOT FOR RECORDING VIDEO

Appears when a recording medium which is not capable of video recording is inserted. Use the guaranteed recording medium to work with this camera. (⇨ pg. 62)

?

Appears when playing back a file that is not compatible with this camera's file format.

### NO VIDEO FILES STORED!

Appears if there are no video files when you attempt video playback.

### NO IMAGE FILES STORED!

Appears if there are no still image files when you attempt still image playback.

### NO VOICE FILES STORED!

Appears if there are no voice files when you attempt voice playback.

### CLOSE COVER

Appears when the battery/CF card cover or the SD card cover is opened during file copy/move operation. (⇨ pg. 41)

### NO MEMORY CARD

Appears when recording media are not inserted to both of slots for file copy/move operation. (⇨ pg. 41)

### NO SUPPORTED FILES

Appears when there is no JPEG (still image) files to be copied or moved in recording media. (⇨ pg. 41)

**NUMBER OF FOLDERS OVERFLOW**

Appears when the number of folders exceeds the limit for file copy/move operation.

**MEMORY CARD ERROR!****REINSERT CARD OR CHANGE CARD**

Appears when the camera does not recognise the loaded recording medium. Remove the medium once and insert it again or replace with another medium. (⇨ pg. 17, 18)

**FILE SYSTEM MAY HAVE PROBLEM  
FORMAT IS RECOMMENDED AFTER  
COPYING WANTED DATA**

The file system of the recording medium may have a problem. It is recommended to copy the data for backup, then format the medium. (⇨ pg. 19)

**VIDEO MANAGEMENT FILE IS BROKEN  
TO RECORD/PLAYBACK VIDEO, RECOVERY  
IS REQUIRED**

The video management file is broken. Recovery is required to record or play back video files. Select [YES] with the multi-controller (△/▽), then press ►|| to recover the video management file. If the desired video file is not displayed on the video index screen in spite of the file recovery, the file is moved to the [EXTMOV] folder. Press the recording start/stop button on the index screen to display [MPG], and then select the desired file.

**NO VIDEO MANAGEMENT FILE  
VIDEO FILES HAVE BEEN MOVED TO MPEG  
FOLDER**

The data cannot be recorded properly, or the video management file is deleted or not found. Video files have been moved to MPEG (EXTMOV) folder. (⇨ pg. 20)

**PLAY LIST'S MANAGEMENT INFORMATION  
IS BROKEN****REMAKE PLAY LIST AGAIN**

The management information of play list is broken. Create the play list again. (⇨ pg. 43)

**NO REGISTERED SCENES IN PLAY LIST  
SOME OF SCENES MAY NOT BE PLAYED  
BACK**

The video files registered in the play list do not exist. Some of the scenes may not be played back.

**REGISTERED SCENES IN PLAY LIST IS  
EMPTY****THIS PLAY LIST WILL BE DELETED**

There is no scenes registered in the play list. The play list will be deleted.

**CAMERA TEMPERATURE IS GOING UP  
TURN CAMERA OFF, PLEASE WAIT**

The temperature of the camera is too high. Turn off the power, then wait for a while.

**CAMERA TEMPERATURE IS TOO LOW  
KEEP CAMERA POWER ON, PLEASE WAIT**

The temperature of the camera is too low. Keep the power on and wait for a while.

**RECORDING FAILURE**

- Performance of recording medium is poor. Use the Cleanup function [CLEAN UP] in the menu. (⇨ pg. 41, 49)
- The writing speed of recording medium is slow, or the recording medium is corrupted. Use the recording medium to which the operation is guaranteed. See page 62 for the guaranteed media to work with this camera.
- The recording medium was subjected to vibrations or jolts. Be careful not to subject the recording medium to vibrations or jolts.

**RECORDING MAY NOT BE CORRECT ON  
THE MEMORY CARD**

The data may not be recorded on the recording medium correctly. Try recording again. Otherwise, clean up the recording medium. (⇨ pg. 41, 49)

**MEMORY CARD CANNOT BE PLAYED BACK  
CORRECTLY**

The recording medium cannot be played back correctly. Try playback again.

**CANNOT USE IN VIDEO MODE**

The operation is not available in the video mode.

## Cleaning the Camera

Before cleaning, turn off the camera and remove the battery pack and AC adapter.

### To clean the exterior

Wipe gently with a soft cloth. Put the cloth in diluted mild soap and wring it well to wipe off heavy dirt. Then wipe again with a dry cloth.

### To clean the LCD monitor

Wipe gently with a soft cloth. Be careful not to damage the monitor.

### To clean the lens

Wipe gently with lens cleaning paper.

### NOTES:

- Avoid using strong cleaning agents such as benzine or alcohol.
- Cleaning should be done only after the battery pack has been removed or other power units have been disconnected.
- Mould may form if the lens is left dirty.
- When using a cleaner or chemically treated cloth refer to the cautions of each product.

## Cautions

### Battery Packs

The supplied battery pack is a lithium-ion battery. Before using the supplied battery pack or an optional battery pack, be sure to read the following cautions:

- **To avoid hazards**
  - ... **do not** burn.
  - ... **do not** short-circuit the terminals. When transporting, make sure the provided battery cap is attached to the battery. If the battery cap is misplaced, carry the battery in a plastic bag.
  - ... **do not** modify or disassemble.
  - ... **do not** expose the battery to temperatures exceeding 60°C, as this may cause the battery to overheat, explode or catch fire.
  - ... use only specified chargers.

Terminals

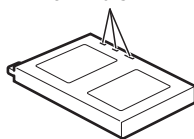

- **To prevent damage and prolong service life**
  - ...do not subject to unnecessary shock.
  - ...charge in an environment where temperatures are within the tolerances shown in the chart below.  
This is a chemical reaction type battery — cooler temperatures impede chemical reaction, while warmer temperatures can prevent complete charging.
  - ...store in a cool, dry place. Extended exposure to high temperatures will increase natural discharge and shorten service life.
  - ...fully charge and then fully discharge the battery every 6 months when storing the battery pack over a long period time.
  - ...remove from charger or powered unit when not in use, as some machines use current even when switched off.

### NOTES:

- It is recommended that only genuine JVC batteries are used in this camera. Using generic non-JVC batteries can cause damage to the internal charging circuitry.
- It is normal for the battery pack to be warm after charging, or after use.  
**Temperature range specifications**  
Charging: 10°C to 35°C  
Operation: 0°C to 40°C  
Storage: -20°C to 50°C
- The lower the temperature, the longer recharging takes.

## Recording Medium

---

- **Be sure to follow the guidelines below to prevent corruption or damage to your recorded data.**
  - Do not bend or drop the recording medium, or subject it to strong pressure, jolts or vibrations.
  - Do not splash the recording medium with water.
  - Do not use, replace, or store the recording medium in locations that are exposed to strong static electricity or electrical noise.
  - Do not turn off the camera power or remove the battery or AC adapter during shooting, playback, or when otherwise accessing the recording medium.
  - Do not bring the recording medium near objects that have a strong magnetic field or that emit strong electromagnetic waves.
  - Do not store the recording medium in locations with high temperature or high humidity.
  - Do not touch the metal parts.
- **Copy the recorded files to your PC. JVC shall not be responsible for any lost data. (It is recommended that you copy the data from your PC to DVD or other media for storage.)**
- **A malfunction may cause the recording medium to fail to operate properly. JVC shall not provide any compensation for any lost contents.**

## LCD Monitor

---

- **To prevent damage to the LCD monitor, DO NOT**
  - ...push it strongly or apply any shocks.
  - ...place the camera with LCD monitor on the bottom.
- **To prolong service life**
  - ...avoid rubbing it with coarse cloth.
- **Be aware of the following phenomena for LCD monitor use. These are not malfunctions.**
  - ...While using the camera, the surface around the LCD monitor may heat up.
  - ...If you leave power on for a long time, the surface around the LCD monitor becomes hot.

## Main Unit

- **For safety, DO NOT**
  - ... open the camera's chassis.
  - ... disassemble or modify the unit.
  - ... short-circuit the terminals of the battery pack. Keep it away from metallic objects when not in use.
  - ... allow inflammables, water or metallic objects to enter the unit.
  - ... remove the battery pack or disconnect the power supply while the power is on.
  - ... leave the battery pack attached when the camera is not in use.
- **Avoid using the unit**
  - ... in places subject to excessive humidity or dust.
  - ... in places subject to soot or steam such as near a cooking stove.
  - ... in places subject to excessive shock or vibration.
  - ... near a television set.
  - ... near appliances generating strong magnetic or electric fields (speakers, broadcasting antennas, etc.).
  - ... in places subject to extremely high (over 40°C) or extremely low (under 0°C) temperatures.
- **DO NOT leave the unit**
  - ... in places of over 50°C.
  - ... in places where humidity is extremely low (below 35%) or extremely high (above 80%).
  - ... in direct sunlight.
  - ... in a closed car in summer.
  - ... near a heater.
- **To protect the unit, DO NOT**
  - ... allow it to become wet.
  - ... drop the unit or strike it against hard objects.
  - ... subject it to shock or excessive vibration during transportation.
  - ... keep the lens directed at extremely bright objects for long periods.
  - ... expose the lens to direct sunlight.
  - ... swing it excessively when using the hand strap.
  - ... swing the soft camera case excessively when the camera is inside it.

## How to Handle a CD-ROM

- Take care not to soil or scratch the mirror surface (opposite to the printed surface). Do not write anything or put a sticker on either the front or back surface. If the CD-ROM gets dirty, gently wipe it with a soft cloth outward from the centre hole.
- Do not use conventional disc cleaners or cleaning spray.
- Do not bend the CD-ROM or touch its mirror surface.
- Do not store your CD-ROM in a dusty, hot or humid environment. Keep it away from direct sunlight.

### Serious malfunctioning

If malfunctioning occurs, stop using the unit immediately and consult your local JVC dealer.

When requesting repairs for malfunctioning by your dealer or JVC service centre, be sure to bring your camera together with the removable hard disk. If one of them is not included, the cause cannot be diagnosed, and the repair cannot be made properly.

The camera is a microcomputer-controlled device. External noise and interference (from a TV, a radio, etc.) might prevent it from functioning properly. In such cases, first disconnect its power supply unit (battery pack, AC adapter, etc.) and wait a few minutes and then re-connect it and proceed as usual from the beginning.

## Specifications

### Camera

#### For general

##### Power supply

DC 11 V (Using AC adapter)

DC 7.2 V (Using battery pack)

##### Power consumption

Approx. 5.5 W

Approx. 8.0 W (Maximum; when charging a battery)

##### Dimensions (W x H x D)

80 mm x 55 mm x 118 mm

(incl. lens hood)

##### Weight

Approx. 330 g

(without battery, removable hard disk, lens hood, lens cap and strap)

Approx. 400 g

(incl. battery, removable hard disk, lens hood, lens cap and strap)

##### Operating temperature

0°C to 40°C

##### Operating humidity

35% to 80%

##### Storage temperature

-20°C to 50°C

##### Pickup

1/4.5" (1,330,000 pixels) CCD x 3 (3 CCD)

##### Lens

Video: F 1.8 to 2.4, f = 3.2 mm to 32 mm, 10:1 power zoom lens

Still: F 1.9 to 2.4, f = 4.0 mm to 32 mm, 8:1 power zoom lens

##### Filter diameter

ø37 mm

(Detach the lens hood when using an optional conversion lens or lens filter. ➤ pg. 8)

##### LCD monitor

1.8" diagonally measured, LCD panel/TFT active matrix system

##### Speaker

Monaural

##### Flash

Within 2 m (recommended shooting distance)

#### For video/audio

##### Format

SD-VIDEO

##### Recording/Playback format

Video: MPEG-2

Audio: Dolby Digital (2 ch)

##### Signal format

PAL standard

##### Recording mode (video)

ULTRA FINE: 720 x 576 pixels, 8.5 Mbps (CBR)

FINE: 720 x 576 pixels, 5.5 Mbps (CBR)

NORMAL: 720 x 576 pixels, 4.2 Mbps (VBR)

ECONOMY: 352 x 288 pixels, 1.5 Mbps (VBR)

##### Recording mode (audio)

ULTRA FINE: 48 kHz, 384 kbps

FINE: 48 kHz, 384 kbps

NORMAL: 48 kHz, 256 kbps

ECONOMY: 48 kHz, 128 kbps

#### For still image

##### Format

JPEG

##### Image size

5 modes (2560 x 1920 / 2048 x 1536 /

1600 x 1200 / 1280 x 960 / 640 x 480)

##### Picture quality

2 modes (FINE/STANDARD)



**For voice****Format**

Linear PCM

**Recording mode**

FINE: 48 kHz, 1,536 kbps, 16 bit, stereo

STANDARD: 16 kHz, 512 kbps, 16 bit, stereo

ECONOMY: 8 kHz, 256 kbps, 16 bit, stereo

**For connectors****AV**

S-Video output:

Y: 1.0 V (p-p), 75  $\Omega$  analogue

C: 0.29 V (p-p), 75  $\Omega$  analogue

Video output: 1.0 V (p-p), 75  $\Omega$  analogue

Audio output: 300 mV (rms), 1 k $\Omega$  analogue, stereo

**Headphone output**

$\varnothing$ 2.5 mm, stereo

**USB**

Mini USB-B type, USB 1.1/2.0 compliant

**AC Adapter****Power requirement**

AC 110 V to 240 V $\sim$ , 50 Hz/60 Hz

**Output**

DC 11 V  $\text{---}$ , 1 A

Design and specifications subject to change without notice.

## Recording Time and Number of Images

The tables below show the approximate recording time and number of storable images.

- The number increases or decreases depending on the conditions such as image size and/or picture quality. The first column in the table indicates the conditions.
- The provided 4 GB removable hard disk is indicated with \* mark.

### Compatible recording media

The following recording media have been guaranteed to work with this camera. Others are not guaranteed to work, so buy such products with caution.

**Removable hard disks:** Microdrive<sup>®</sup> from Hitachi, JVC Microdrive<sup>®</sup> (CU-MD04)

**CompactFlash cards:** By LEXAR, SanDisk and Hagiwara Sys-Com

**SD memory cards:** By Panasonic, TOSHIBA, pqi (still image only) and SanDisk

- If other media are used, they may fail to record data correctly, or they may lose data that has already been recorded.
- Microdrive<sup>®</sup> of 1 GB or less are not supported.
- MultiMediaCards are not supported.
- For video recording, use a removable hard disk, high-speed CompactFlash card (at least 40x speed) or SD memory card (at least 10 MB/s).

 : Approximate recording time (for video)

(The numbers indicate "minutes".)

- Removable hard disk

Quality	2 GB	4 GB*	6 GB
ULTRA FINE	30	60	90
FINE	45	90	135
NORMAL	60	120	180
ECONOMY	150	300	450

- SD card/CompactFlash card

Quality	128 MB	256 MB	512 MB	1 GB
ULTRA FINE	2	4	8	16
FINE	3	6	12	24
NORMAL	4	7	15	31
ECONOMY	10	21	43	86

**📷 : Approximate number of storable images (for still image)**

• Removable hard disk

Image size/ quality	2 GB	4 GB*	6 GB
640 x 480/ FINE	9999	9999	9999
640 x 480/ STANDARD	9999	9999	9999
1280 x 960/ FINE	3285	6575	9865
1280 x 960/ STANDARD	5675	9999	9999
1600 x 1200/ FINE	2230	4460	6690
1600 x 1200/ STANDARD	3670	7345	9999
2048 x 1536/ FINE	1385	2775	4160
2048 x 1536/ STANDARD	2150	4305	6460
2560 x 1920/ FINE	900	1805	2715
2560 x 1920/ STANDARD	1415	2835	4255

• SD card

Image size/ quality	128 MB	256 MB	512 MB	1 GB
640 x 480/ FINE	780	1555	3140	6040
640 x 480/ STANDARD	1115	2225	4490	8635
1280 x 960/ FINE	210	420	845	1630
1280 x 960/ STANDARD	350	705	1425	2745
1600 x 1200/ FINE	140	280	570	1095
1600 x 1200/ STANDARD	225	455	920	1775
2048 x 1536/ FINE	85	170	350	675
2048 x 1536/ STANDARD	135	270	550	1055
2560 x 1920/ FINE	55	110	225	435
2560 x 1920/ STANDARD	85	175	355	685

• CompactFlash card

Image size/ quality	128 MB	256 MB	512 MB	1 GB
640 x 480/ FINE	705	1420	2840	5680
640 x 480/ STANDARD	1115	2235	4465	8930
1280 x 960/ FINE	210	420	840	1685
1280 x 960/ STANDARD	350	710	1420	2840
1600 x 1200/ FINE	135	275	555	1115
1600 x 1200/ STANDARD	225	455	915	1835
2048 x 1536/ FINE	85	175	350	700
2048 x 1536/ STANDARD	135	270	545	1095
2560 x 1920/ FINE	55	110	225	450
2560 x 1920/ STANDARD	85	175	350	705

**🎤 : Approximate recording time (for voice)**

(The numbers indicate "minutes".)

• Removable hard disk

Quality	4 GB*
FINE	350
STANDARD	1060
ECONOMY	2130

<b>A</b>		<b>M</b>	
AC Adapter .....	14, 15	Manual Exposure .....	35
Aperture-Priority .....	32	Manual Focus .....	33
<b>B</b>		Mode Lamp .....	16
Backlight Compensation .....	31	MSET Menu .....	34
Battery Pack .....	14	<b>O</b>	
Bracket Shooting .....	33	Operation Sound .....	48
Brightness Control .....	49	<b>P</b>	
<b>C</b>		Picture Quality .....	50, 51
CF Card .....	17	Play List .....	43 – 45, 50
Changing The Menu Settings .....	48 – 51	Playback Speed .....	51
Charging The Battery Pack .....	14	Portrait .....	31
Cleaning Up a Recording Medium .....	41, 49	Protecting Files .....	39, 50
Connection to a TV or VCR .....	24	<b>R</b>	
Continuous Shooting .....	26	Recording Level .....	51
Copying/Moving Still Image Files .....	41, 49	Recording Mode Dial .....	16, 31 – 32
<b>D</b>		Resetting The File Number .....	42, 49
Date/Time Settings .....	17	<b>S</b>	
Deleting Files .....	40	SD Memory Card .....	18
Demonstration Mode .....	48	Self-Timer .....	51
Digital Image Stabiliser (DIS) .....	50	Shutter-Priority .....	32
Direct Printing .....	47	Slide Show .....	27
DPOF Print Setting (Digital Print Order Format) .....	46	Slow Motion Playback .....	23
Dubbing .....	24, 45	Sound Quality .....	51
<b>E</b>		Speaker Volume .....	22, 30
Effect .....	36, 37	Spot Exposure Control .....	31
<b>F</b>		<b>T</b>	
File Information .....	38	Tally Lamp .....	20
Flash .....	26	Tele Macro .....	50, 51
Formatting a Recording Medium .....	19, 49	Troubleshooting .....	52
<b>G</b>		<b>W</b>	
Gain Up .....	50	Warning Indications .....	55
<b>H</b>		White Balance .....	35
Histogram .....	38	Wide Mode .....	50
<b>I</b>		Wind Cut .....	50
Image Rotation .....	28	Wipe or Fader Effects .....	37
Image Size .....	51	<b>Z</b>	
Index Screen .....	22, 27	Zooming .....	21, 23, 25, 28, 50
<b>L</b>			
Language Setting .....	16, 49		
LCD Monitor .....	12, 29, 30, 58		

# JVC