

- **95-mΩ Maximum (5-V Input) High-Side MOSFET Switch**
- **Short-Circuit Protection and Thermal Protection**
- **Logic Overcurrent Output**
- **4-V to 7-V Operating Range**
- **Enable Input Compatible With 3-V and 5-V Logic**
- **Controlled Rise and Fall Times Limit Current Surges and Minimize EMI**
- **Undervoltage Lockout Ensures That Switch is Off at Start-Up**
- **10-μA Maximum Standby Current**
- **Available in Space-Saving 8-Pin SOIC and 8-Pin PDIP**
- **0°C to 125°C Operating Junction Temperature Range**
- **12-kV Output, 6-kV Input Electrostatic-Discharge Protection**
- **UL Listed (TPS2014) – File No. E169910**

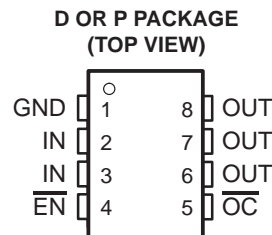

description

The TPS2014 and TPS2015 power distribution switches are intended for applications where heavy capacitive loads and short circuits are likely to be encountered. The high-side switch is a 95-mΩ n-channel MOSFET. The switch is controlled by a logic enable that is compatible with 3-V and 5-V logic. Gate drive is provided by an internal charge pump designed to control the power switch rise times and fall times to minimize current surges during switching. The charge pump requires no external components and allows operation from supplies as low as 4 V.

When the output load exceeds the current-limit threshold or a short is present, the TPS20xx limits the output current to a safe level by switching into a constant-current mode, and the overcurrent logic output is set to low. Continuous heavy overloads and short circuits will increase the power dissipation in the switch and cause the junction temperature to rise. A thermal protection circuit is implemented, which shuts the switch off to prevent damage when the junction temperature exceeds its thermal limit. An undervoltage lockout is provided to ensure the switch is in the off state at start-up.

The TPS2014 and TPS2015 differ only in short-circuit current limits. The TPS2014 is designed to limit at 1.2 A load and the TPS2015 limits at 2 A (see the available options table). The TPS20xx is available in 8-pin small-outline integrated circuit (SOIC) and 8-pin PDIP packages, and operates over a junction temperature range of 0°C to 125°C.

AVAILABLE OPTIONS

T _A	RECOMMENDED MAXIMUM CONTINUOUS LOAD CURRENT	TYPICAL SHORT-CIRCUIT CURRENT LIMIT AT 25°C	PACKAGED DEVICES		CHIP FORM (Y)
			SOIC (D) [†]	PDIP (P)	
0°C TO 85°C	0.6 A	1.2 A	TPS2014D	TPS2014P	TPS2014Y
	1 A	2 A	TPS2015D	TPS2015P	TPS2015Y

[†] The D package is available taped and reeled. Add an R suffix to device type (e.g., TPS2014DR).



Please be aware that an important notice concerning availability, standard warranty, and use in critical applications of Texas Instruments semiconductor products and disclaimers thereto appears at the end of this data sheet.

TPS2014, TPS2015 POWER DISTRIBUTION SWITCHES

SLVS159C – DECEMBER 1996 – REVISED MARCH 2004

functional block diagram

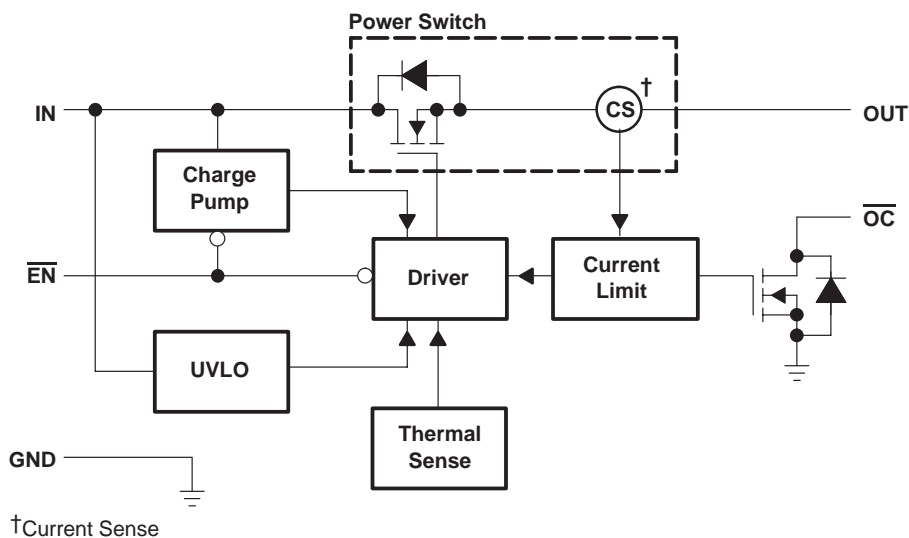

TPS20xxY chip information

This chip, when properly assembled, displays characteristics similar to those of the TPS20xx. Ultrasonic bonding may be used on the doped aluminium bonding pads. The chip may be mounted with conductive epoxy or a gold-silicon preform.

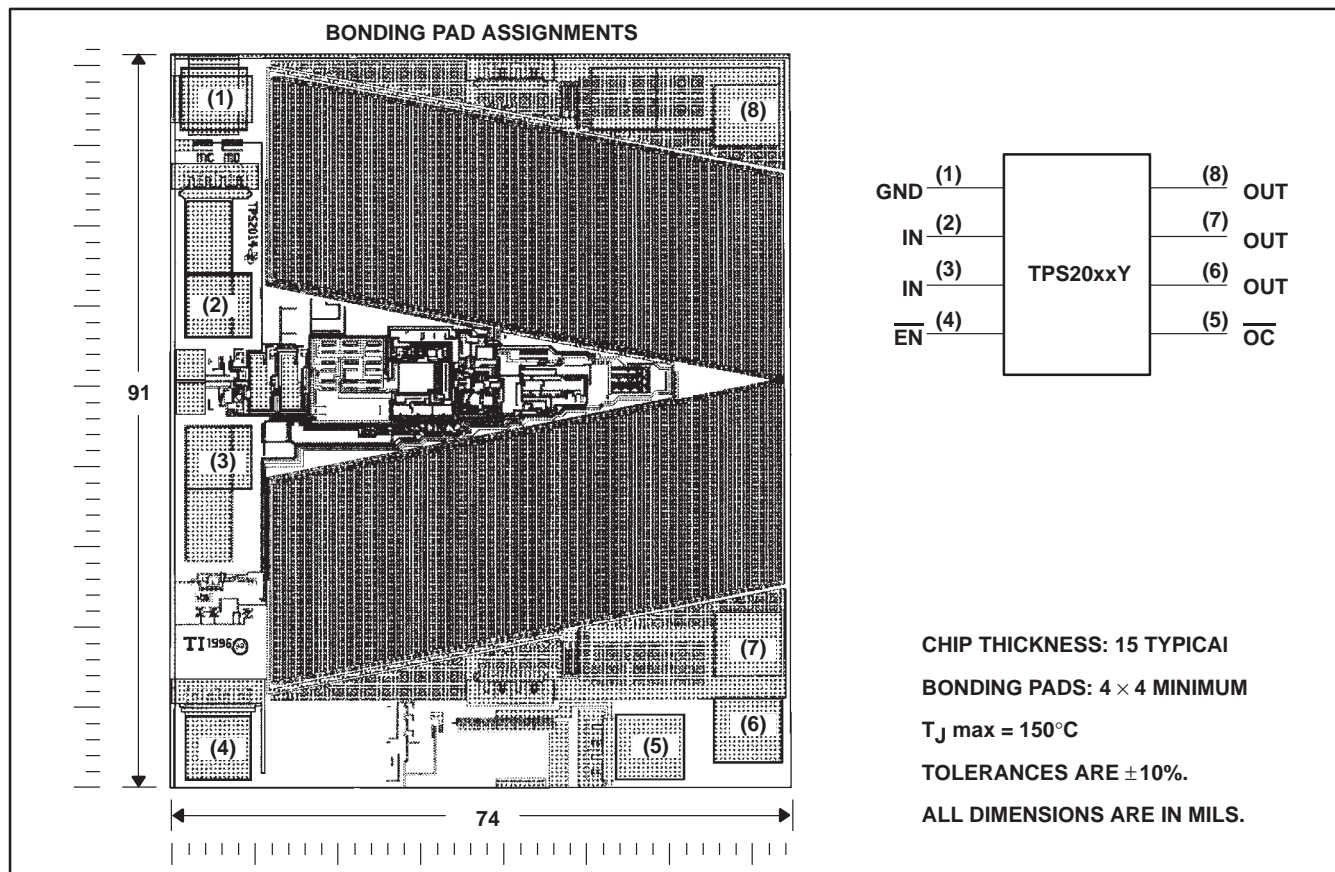

Terminal Functions

TERMINAL NAME	NO.	I/O	DESCRIPTION
$\overline{\text{EN}}$	4	I	Enable input. Logic low at $\overline{\text{EN}}$ turns the power switch on.
GND	1	I	Ground
$\overline{\text{IN}}$	2, 3	I	Input voltage
$\overline{\text{OC}}$	5	O	$\overline{\text{OC}}$ is asserted active low during a fault condition.
OUT	6–8	O	Power switch output

detailed description

power switch

The power switch is an n-channel MOSFET with a maximum on-state resistance of 95 m Ω ($V_{I(IN)} = 5 \text{ V}$), configured as a high-side switch.

charge pump

An internal 100-kHz charge pump supplies power to the driver circuit and provides the necessary voltage to pull the gate of the MOSFET above the source. The charge pump operates from input voltages as low as 4 V and requires very little supply current.

driver

The driver controls the gate voltage of the power switch. To limit large current surges and reduce the associated electromagnetic interference (EMI) produced, the driver incorporates circuitry that controls the rise times and fall times of the output voltage. The rise and fall times are typically in the 2-ms to 4-ms range instead of the microsecond or nanosecond range for a standard FET.

enable ($\overline{\text{EN}}$)

A logic high on $\overline{\text{EN}}$ turns off the power switch and the bias for the charge pump, driver, and other circuitry to reduce the supply current to less than 10 μA . A logic zero input restores bias to the drive and control circuits and turns the power on. The enable input is compatible with both TTL and CMOS logic levels.

overcurrent ($\overline{\text{OC}}$)

$\overline{\text{OC}}$ is an open-drain logic output that is asserted (active low) when an overload or short circuit is encountered. The output remains asserted until the overload or short-circuit condition is removed.

current sense

A sense FET monitors the current supplied to the load. The sense FET provides a much more efficient way to measure current than conventional resistance methods. When an overload or short circuit is encountered, the current-sense circuitry sends a control signal to the driver. The driver in turn reduces the gate voltage and drives the power FET into its linear region, which switches the output into a constant current mode and simply holds the current constant while varying the voltage on the load.

thermal sense

An internal thermal-sense circuit shuts off the power switch when the junction temperature rises to approximately to 180°C. Hysteresis is built into the thermal sense circuit. After the device has cooled approximately 20°C, the switch turns back on. The switch continues to cycle off and on until the fault is removed.

undervoltage lockout

An internal voltage sense monitors the input voltage. When the input voltage is below 3.2 V nominal, a control signal turns off the power switch.

TPS2014, TPS2015 POWER DISTRIBUTION SWITCHES

SLVS159C – DECEMBER 1996 – REVISED MARCH 2004

absolute maximum ratings over operating free-air temperature range (unless otherwise noted)†

Input voltage range, V_I (see Note1)	-0.3 V to 7 V
Output voltage range, V_O (see Note1)	-0.3 V to $V_{I(IN)} + 0.3$ V
Input voltage range, V_I at \overline{EN}	-0.3 V to 7 V
Continuous output current, I_O	internally limited
Continuous total power dissipation	See Dissipation Rating Table
Operating virtual junction temperature range, T_J	0°C to 125°C
Storage temperature range, T_{stg}	-65°C to 150°C
Lead temperature soldering 1,6 mm (1/16 inch) from case for 10 seconds	260°C

† Stresses beyond those listed under “absolute maximum ratings” may cause permanent damage to the device. These are stress ratings only, and functional operation of the device at these or any other conditions beyond those indicated under “recommended operating conditions” is not implied. Exposure to absolute-maximum-rated conditions for extended periods may affect device reliability.

NOTE 1: All voltages are with respect to GND.

DISSIPATION RATING TABLE

PACKAGE	$T_A \leq 25^\circ\text{C}$ POWER RATING	DERATING FACTOR ABOVE $T_A = 25^\circ\text{C}$	$T_A = 70^\circ\text{C}$ POWER RATING	$T_A = 125^\circ\text{C}$ POWER RATING
P	1175 mW	9.4 mW/°C	752 mW	235 mW
D	725 mW	5.8 mW/°C	464 mW	145 mW

recommended operating conditions

	MIN	MAX	UNIT	
Input voltage, V_I	4	5.5	V	
Input voltage, V_I at \overline{EN}	0	5.5	V	
Continuous output current, I_O	TPS2014	0	0.6	A
	TPS2015	0	1	
Operating virtual junction temperature, T_J	0	125	°C	

electrical characteristics over recommended operating junction temperature range, $V_{I(IN)} = 5.5$ V, $I_O =$ rated current, $\overline{EN} = 0$ V (unless otherwise noted)

power switch

PARAMETER	TEST CONDITIONS†	MIN	TYP	MAX	UNIT
r_{on} On-state resistance	$V_I = 5.5$ V, $T_J = 25^\circ\text{C}$		75	95	mΩ
	$V_I = 5$ V, $T_J = 25^\circ\text{C}$		80	95	
	$V_I = 4.5$ V, $T_J = 25^\circ\text{C}$		90	110	
	$V_I = 4$ V, $T_J = 25^\circ\text{C}$		96	110	
I_{lkg} Leakage current, output	$\overline{EN} = V_I$, $T_J = 25^\circ\text{C}$		0.001	1	μA
	$\overline{EN} = V_I$, $0^\circ\text{C} \leq T_J \leq 125^\circ\text{C}$			10	
t_r Rise time, output	$V_I = 5.5$ V, $T_J = 25^\circ\text{C}$ $C_L = 1$ μF		4		ms
	$V_I = 4$ V, $T_J = 25^\circ\text{C}$ $C_L = 1$ μF		3.8		
t_f Fall time, output	$V_I = 5.5$ V, $T_J = 25^\circ\text{C}$ $C_L = 1$ μF		3.9		ms
	$V_I = 4$ V, $T_J = 25^\circ\text{C}$ $C_L = 1$ μF		3.5		

† Pulse-testing techniques maintain junction temperature close to ambient temperature; thermal effects must be taken into account separately.

electrical characteristics over recommended operating junction temperature range, $V_{I(IN)} = 5.5\text{ V}$, $I_O = \text{rated current}$, $\overline{EN} = 0\text{ V}$ (unless otherwise noted) (continued)

enable input (\overline{EN})

PARAMETER		TEST CONDITIONS	MIN	MAX	UNIT
V_{IH}	High-level input voltage	$4\text{ V} \leq V_I \leq 5.5\text{ V}$	2		V
V_{IL}	Low-level input voltage	$4\text{ V} \leq V_I \leq 5.5\text{ V}$		0.8	V
I_I	Input current	$\overline{EN} = 0\text{ V}$ or $\overline{EN} = V_I$	-0.5	0.5	μA
t_{PLH}	Propagation (delay) time, low to high output	$C_L = 1\ \mu\text{F}$		20	ms
t_{PHL}	Propagation (delay) time, high to low output	$C_L = 1\ \mu\text{F}$		40	

current limit

PARAMETER		TEST CONDITIONS†	MIN	TYP	MAX	UNIT
I_{OS}	Short-circuit output current	$T_J = 25^\circ\text{C}$, $V_I = 5.5\text{ V}$	0.66	1.2	1.8	A
			1.1	2	3	

† Pulse-testing techniques maintain junction temperature close to ambient temperature; thermal effects must be taken into account separately.

supply current

PARAMETER		TEST CONDITIONS	MIN	TYP	MAX	UNIT
I_{DDL}	Supply current, low-level output	$\overline{EN} = V_I$		0.015	10	μA
		$T_J = 25^\circ\text{C}$				
I_{DDH}	Supply current, high-level output	$\overline{EN} = 0\text{ V}$		73	100	μA
		$0^\circ\text{C} \leq T_J \leq 125^\circ\text{C}$			100	

undervoltage lockout

PARAMETER		MIN	TYP	MAX	UNIT
V_{IL}	Low-level input voltage	2	3.2	4	V

\overline{OC}

PARAMETER		TEST CONDITIONS	MIN	TYP	MAX	UNIT
I_{OS}	Short-circuit output current	$0^\circ\text{C} \leq T_J \leq 125^\circ\text{C}$			5	mA
V_{OL}	Low-level output voltage	$0^\circ\text{C} \leq T_J \leq 125^\circ\text{C}$			0.3	

TPS2014, TPS2015 POWER DISTRIBUTION SWITCHES

SLVS159C – DECEMBER 1996 – REVISED MARCH 2004

electrical characteristics over recommended operating junction temperature range, $V_{I(IN)} = 5.5\text{ V}$, $I_O =$ rated current, $\overline{EN} = 0\text{ V}$ (unless otherwise noted)

power switch

PARAMETER	TEST CONDITIONS†	TPS2014Y, TPS2015Y			UNIT
		MIN	TYP	MAX	
r_{on} On-state resistance	$V_I = 5.5\text{ V}$, $T_J = 25^\circ\text{C}$	75			m Ω
	$V_I = 5\text{ V}$, $T_J = 25^\circ\text{C}$	80			
	$V_I = 4.5\text{ V}$, $T_J = 25^\circ\text{C}$	90			
	$V_I = 4\text{ V}$, $T_J = 25^\circ\text{C}$	96			
I_{lkg} Leakage current, output	$\overline{EN} = V_I$, $T_J = 25^\circ\text{C}$	0.001			μA
	$\overline{EN} = V_I$, $0^\circ\text{C} \leq T_J \leq 125^\circ\text{C}$	10			
t_r Rise time, output	$V_I = 5.5\text{ V}$, $T_J = 25^\circ\text{C}$ $C_L = 1\text{ }\mu\text{F}$	4			ms
	$V_I = 4\text{ V}$, $T_J = 25^\circ\text{C}$ $C_L = 1\text{ }\mu\text{F}$	3.8			
t_f Fall time, output	$V_I = 5.5\text{ V}$, $T_J = 25^\circ\text{C}$ $C_L = 1\text{ }\mu\text{F}$	3.9			ms
	$V_I = 4\text{ V}$, $T_J = 25^\circ\text{C}$ $C_L = 1\text{ }\mu\text{F}$	3.5			

† Pulse-testing techniques maintain junction temperature close to ambient temperature; thermal effects must be taken into account separately.

enable input (\overline{EN})

PARAMETER	TEST CONDITIONS	TPS2014Y, TPS2015Y			UNIT
		MIN	TYP	MAX	
V_{IH} High-level input voltage	$4\text{ V} \leq V_I \leq 5.5\text{ V}$	2			V
V_{IL} Low-level input voltage	$4\text{ V} \leq V_I \leq 5.5\text{ V}$	0.8			V
I_I Input current	$\overline{EN} = 0\text{ V}$ or $\overline{EN} = V_I$	0.5			μA
t_{PLH} Propagation (delay) time, low to high output	$C_L = 1\text{ }\mu\text{F}$	20			ms
t_{PHL} Propagation (delay) time, high to low output	$C_L = 1\text{ }\mu\text{F}$	40			

current limit

PARAMETER	TEST CONDITIONS†	TPS2014Y, TPS2015Y			UNIT
		MIN	TYP	MAX	
I_{OS} Short-circuit output current	$T_J = 25^\circ\text{C}$, $V_I = 5.5\text{ V}$	TPS2014	1.2		A
		TPS2015	2		

† Pulse-testing techniques maintain junction temperature close to ambient temperature; thermal effects must be taken into account separately.

supply current

PARAMETER	TEST CONDITIONS	TPS2014Y, TPS2015Y			UNIT
		MIN	TYP	MAX	
I_{DDL} Supply current, low-level output	$\overline{EN} = V_I$	$T_J = 25^\circ\text{C}$	0.015		μA
		$0^\circ\text{C} \leq T_J \leq 125^\circ\text{C}$	10		
I_{DDH} Supply current, high-level output	$\overline{EN} = 0\text{ V}$	$T_J = 25^\circ\text{C}$	73		μA
		$0^\circ\text{C} \leq T_J \leq 125^\circ\text{C}$	100		

undervoltage lockout

PARAMETER	TPS2014Y, TPS2015Y			UNIT
	MIN	TYP	MAX	
V_{IL} Low-level input voltage	3.2			V

electrical characteristics over recommended operating junction temperature range, $V_{I(IN)} = 5.5\text{ V}$, $I_O = \text{rated current}$, $\overline{EN} = 0\text{ V}$ (unless otherwise noted) (continued)

\overline{OC}

PARAMETER	TEST CONDITIONS	TPS2014Y, TPS2015Y			UNIT
		MIN	TYP	MAX	
I_{OS} Short-circuit output current	$0^\circ\text{C} \leq T_J \leq 125^\circ\text{C}$		5		mA
V_{OL} Low-level output voltage	$0^\circ\text{C} \leq T_J \leq 125^\circ\text{C}$		0.3		

PARAMETER MEASUREMENT INFORMATION

Table of Timing Diagrams

	FIGURE
Propagation Delay and Rise Time With 1- μF Load, $V_{I(IN)} = 5\text{ V}$	1
Propagation Delay and Fall Time With 1- μF Load, $V_{I(IN)} = 5\text{ V}$	2
TPS2014 Short-Circuit Current. Short is Applied to Enabled Device, $V_{I(IN)} = 5\text{ V}$	3
TPS2015 Short-Circuit Current. Short is Applied to Enabled Device, $V_{I(IN)} = 5\text{ V}$	4
TPS2014 Threshold Current, $V_{I(IN)} = 5\text{ V}$	5
TPS2015 Threshold Current, $V_{I(IN)} = 5\text{ V}$	6
TPS2014 (Enabled) into Short Circuit, $V_{I(IN)} = 5\text{ V}$	7
TPS2015 (Enabled) into Short Circuit, $V_{I(IN)} = 5\text{ V}$	8

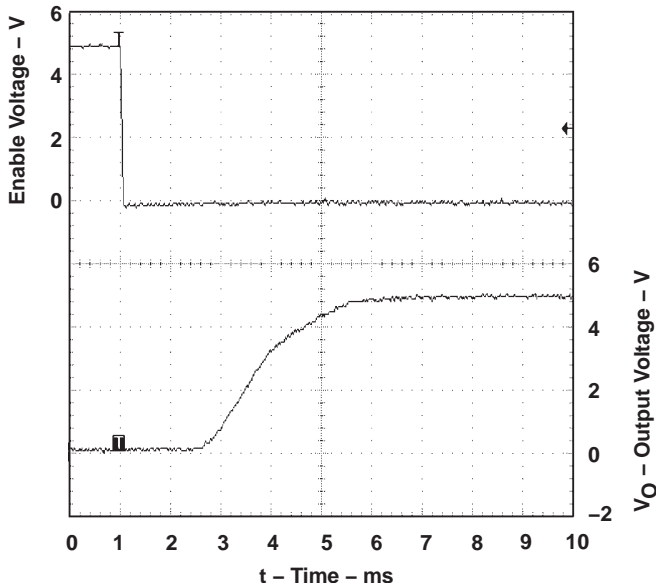

Figure 1. Propagation Delay and Rise Time With 1- μF Load, $V_{I(IN)} = 5\text{ V}$

PARAMETER MEASUREMENT INFORMATION

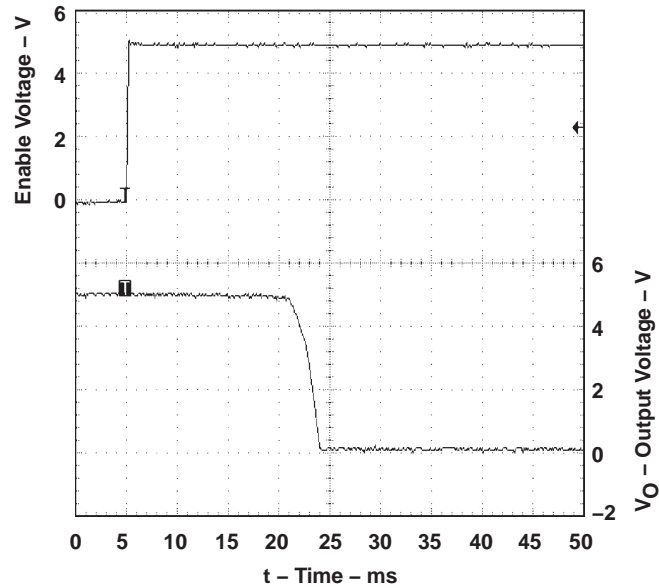

Figure 2. Propagation Delay and Fall Time With 1- μ F Load, $V_{I(IN)} = 5$ V

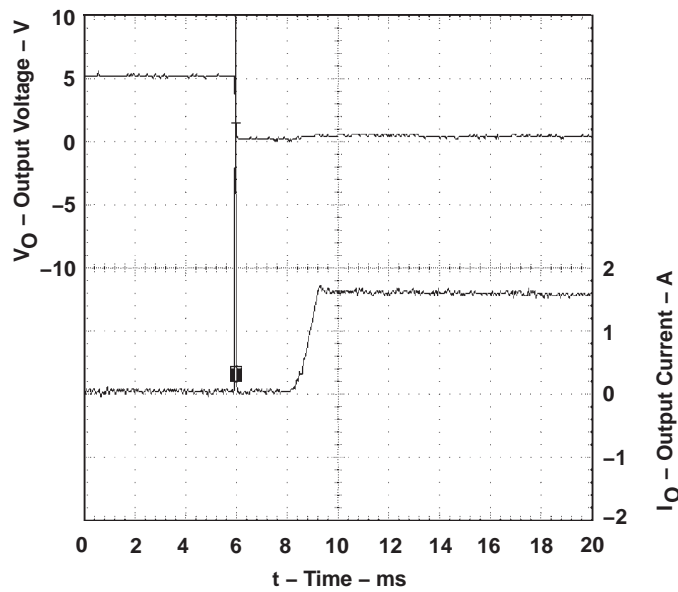

Figure 3. TPS2014 Short-Circuit Current. Short is Applied to Enabled Device, $V_{I(IN)} = 5$ V

PARAMETER MEASUREMENT INFORMATION

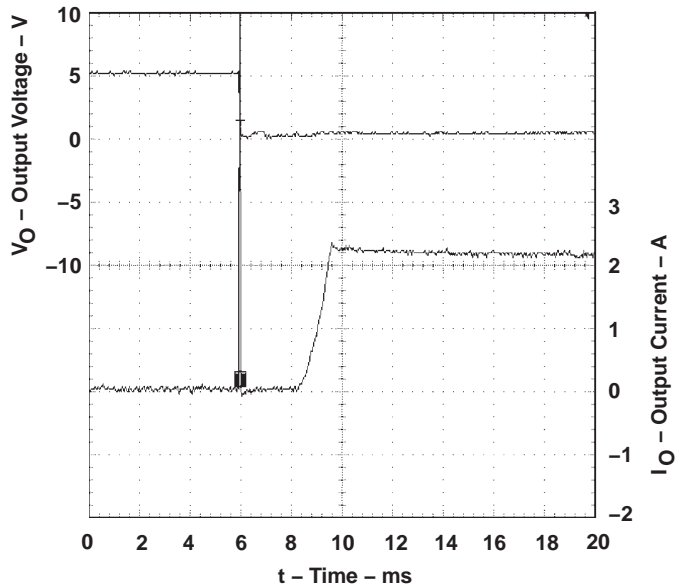

Figure 4. TPS2015 Short-Circuit Current. Short is Applied to Enabled Device, $V_{I(IN)} = 5\text{ V}$

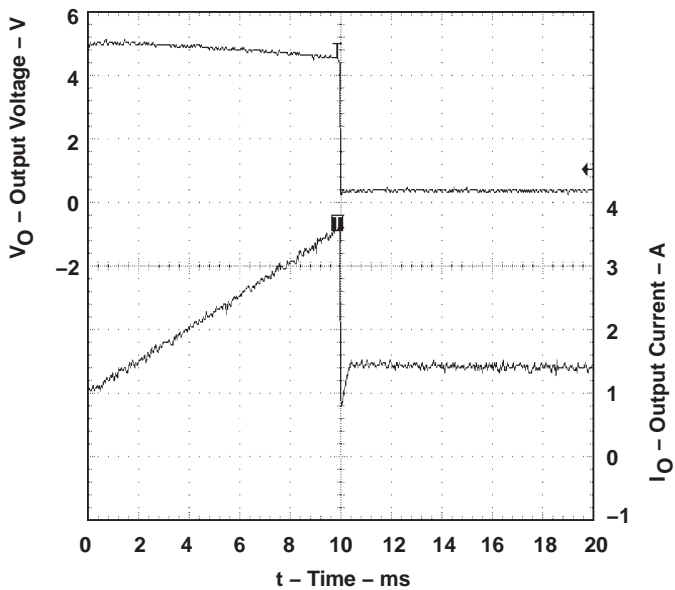

Figure 5. TPS2014 Threshold Current, $V_{I(IN)} = 5\text{ V}$

PARAMETER MEASUREMENT INFORMATION

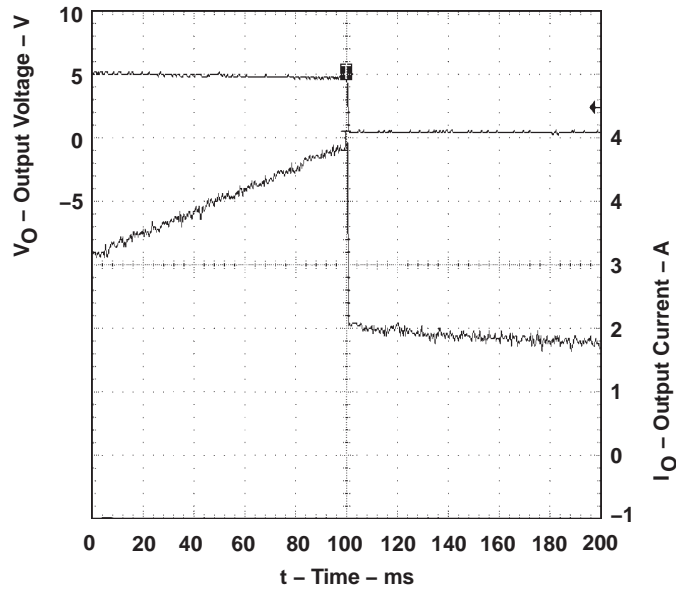

Figure 6. TPS2015 Threshold Current, $V_{I(IN)} = 5\text{ V}$

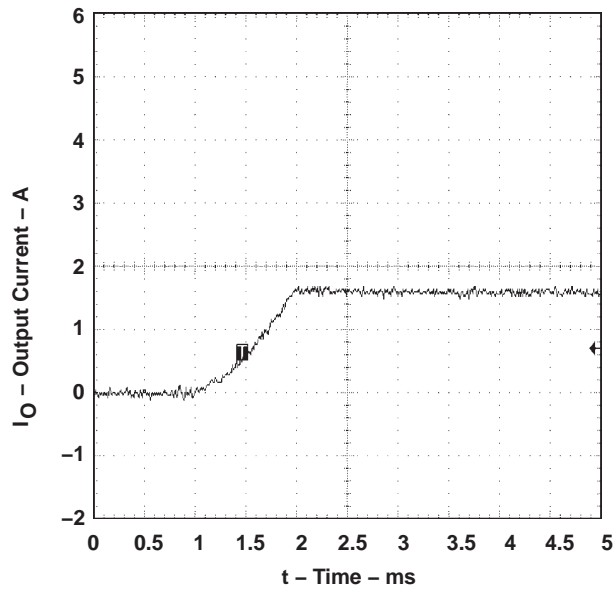

Figure 7. TPS2014 (Enabled) into Short Circuit, $V_{I(IN)} = 5\text{ V}$

PARAMETER MEASUREMENT INFORMATION

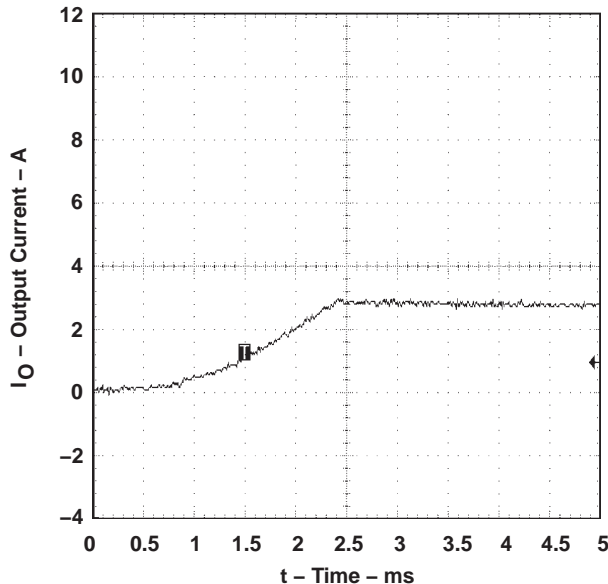

Figure 8. TPS2015 (Enabled) into Short Circuit, $V_{I(IN)} = 5\text{ V}$

TYPICAL CHARACTERISTICS

Table of Graphs

	FIGURE
Turn-On Delay Time vs Input Voltage	9
Turn-Off Delay Time vs Input Voltage	10
Rise Time vs Output Current	11
Fall Time vs Output Current	12
Supply Current, Output Enabled vs Junction Temperature	13
Supply Current, Output Enabled vs Junction Temperature	14
Supply Current, Output Enabled vs Input Voltage	15
Supply Current, Output Enabled vs Input Voltage	16
On-State Resistance vs Junction Temperature	17
On-State Resistance vs Input Voltage	18
Input Voltage to Output Voltage vs Input Voltage	19
Short-Circuit Output Current vs Input Voltage	20
Threshold Trip Current vs Input Voltage	21
Short-Circuit Output Current vs Junction Temperature	22
UVLO Trip Voltage vs Junction Temperature	23

TYPICAL CHARACTERISTICS

TURN-ON DELAY TIME
vs
INPUT VOLTAGE

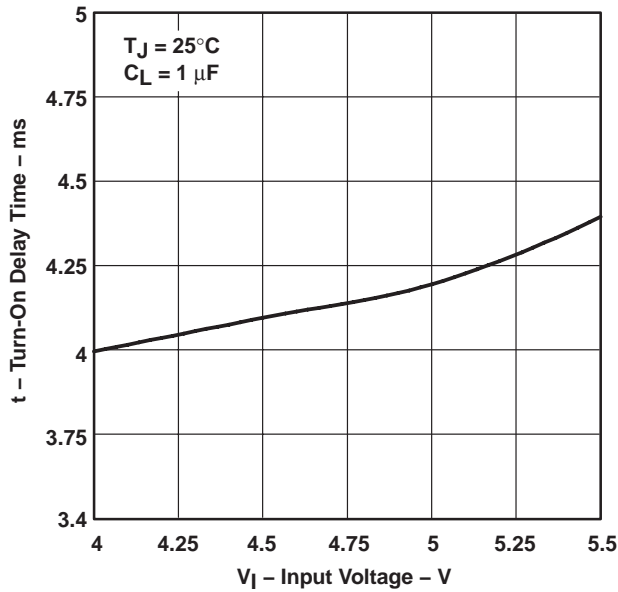

Figure 9

TURN-OFF DELAY TIME
vs
INPUT VOLTAGE

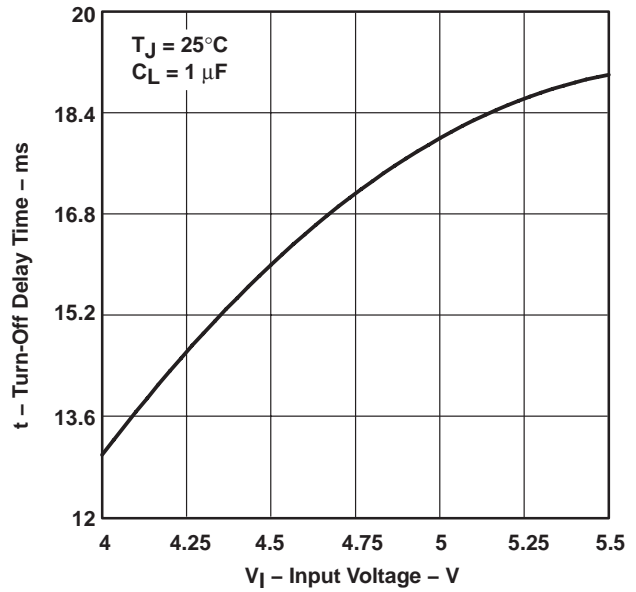

Figure 10

RISE TIME
vs
OUTPUT CURRENT

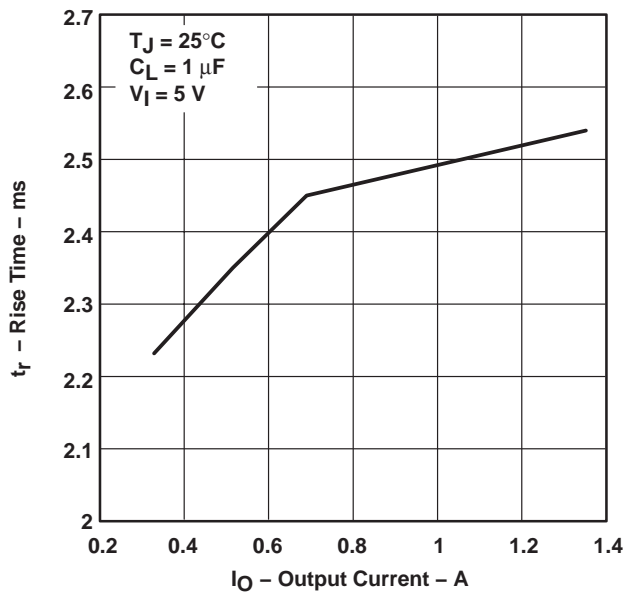

Figure 11

FALL TIME
vs
OUTPUT CURRENT

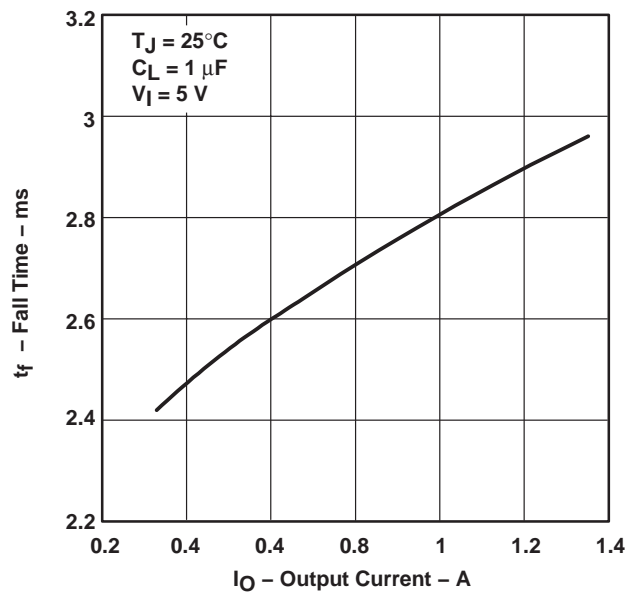

Figure 12

TYPICAL CHARACTERISTICS

SUPPLY CURRENT, OUTPUT ENABLED
vs
JUNCTION TEMPERATURE

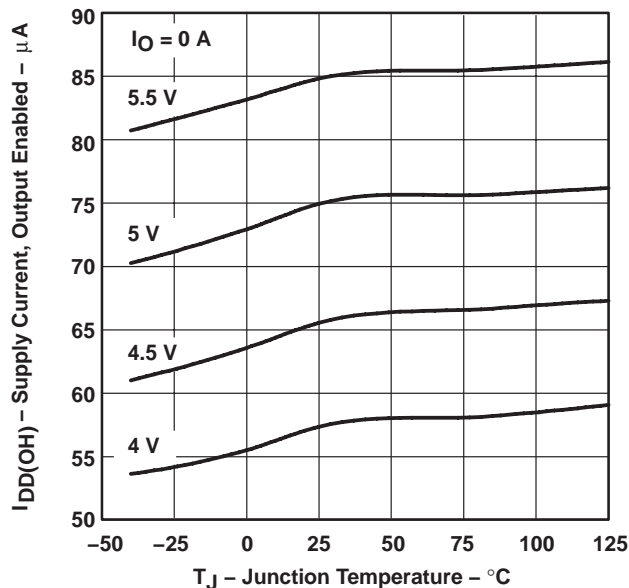

Figure 13

SUPPLY CURRENT, OUTPUT DISABLED
vs
JUNCTION TEMPERATURE

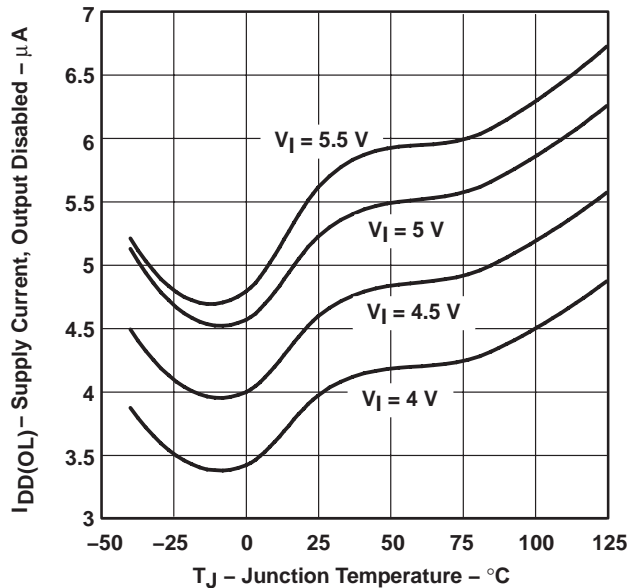

Figure 14

SUPPLY CURRENT, OUTPUT ENABLED
vs
INPUT VOLTAGE

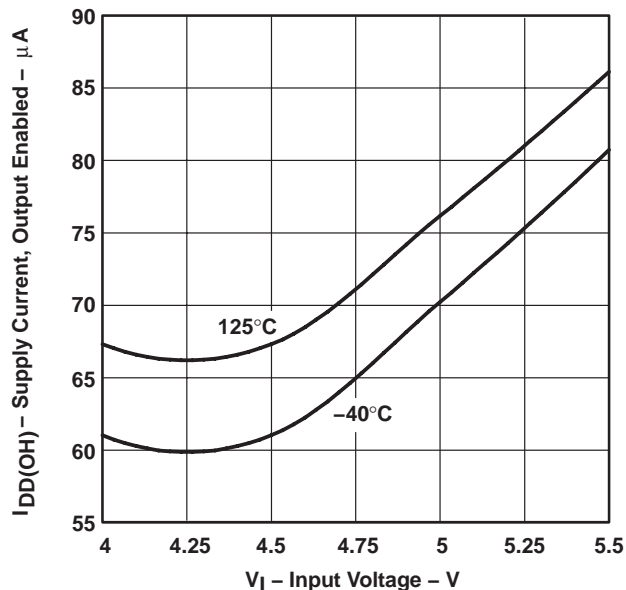

Figure 15

SUPPLY CURRENT, OUTPUT DISABLED
vs
INPUT VOLTAGE

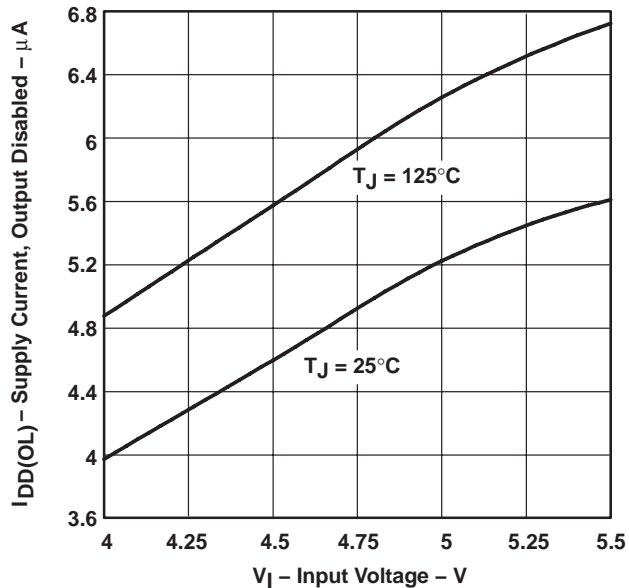

Figure 16

TYPICAL CHARACTERISTICS

ON-STATE RESISTANCE
vs
JUNCTION TEMPERATURE

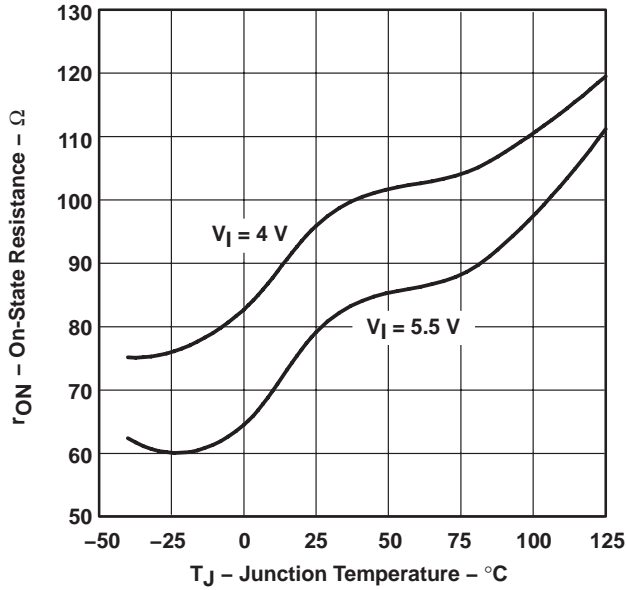

Figure 17

ON-STATE RESISTANCE
vs
INPUT VOLTAGE

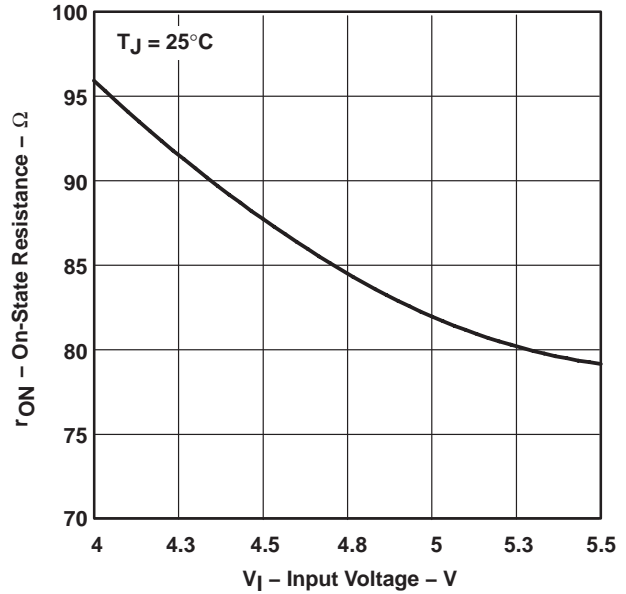

Figure 18

INPUT VOLTAGE TO OUTPUT VOLTAGE
vs
INPUT VOLTAGE

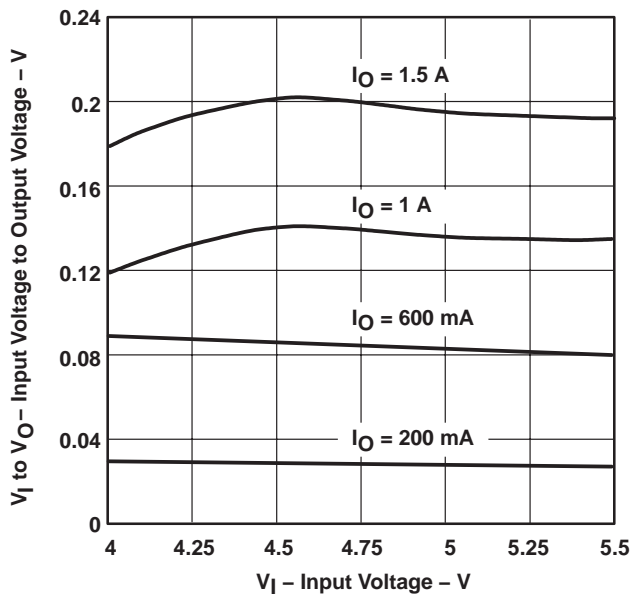

Figure 19

SHORT-CIRCUIT OUTPUT CURRENT
vs
INPUT VOLTAGE

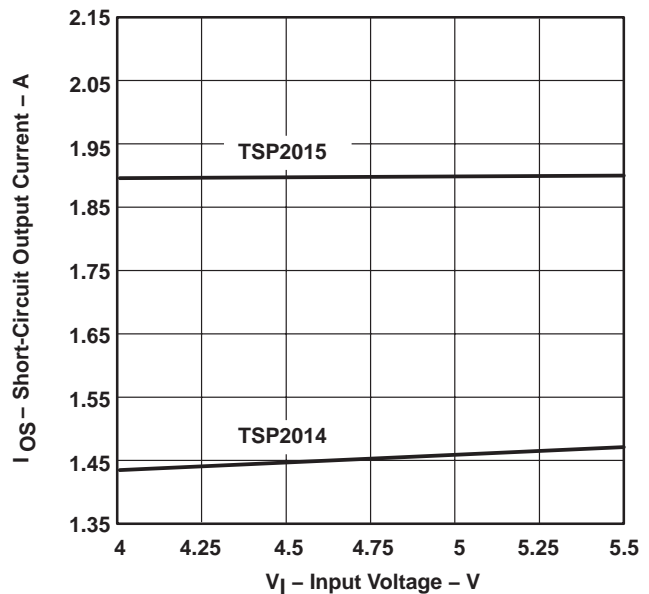

Figure 20

TYPICAL CHARACTERISTICS

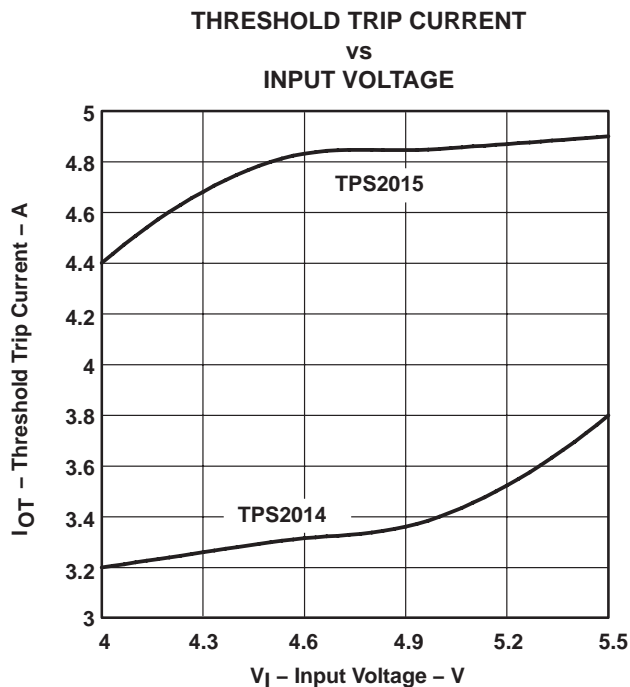

Figure 21

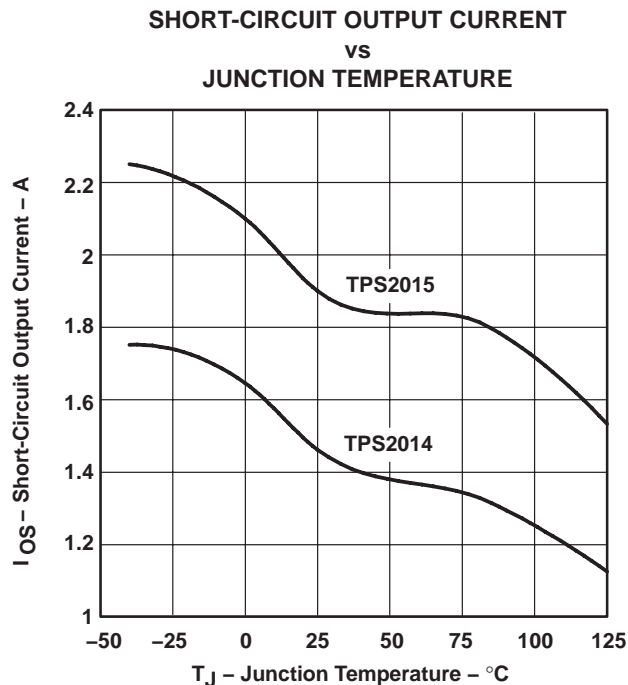

Figure 22

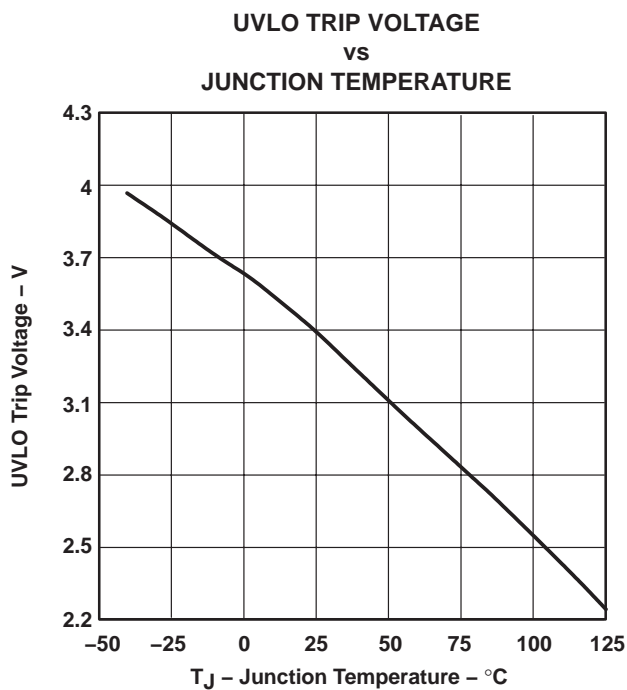

Figure 23

TPS2014, TPS2015 POWER DISTRIBUTION SWITCHES

SLVS159C – DECEMBER 1996 – REVISED MARCH 2004

APPLICATION INFORMATION

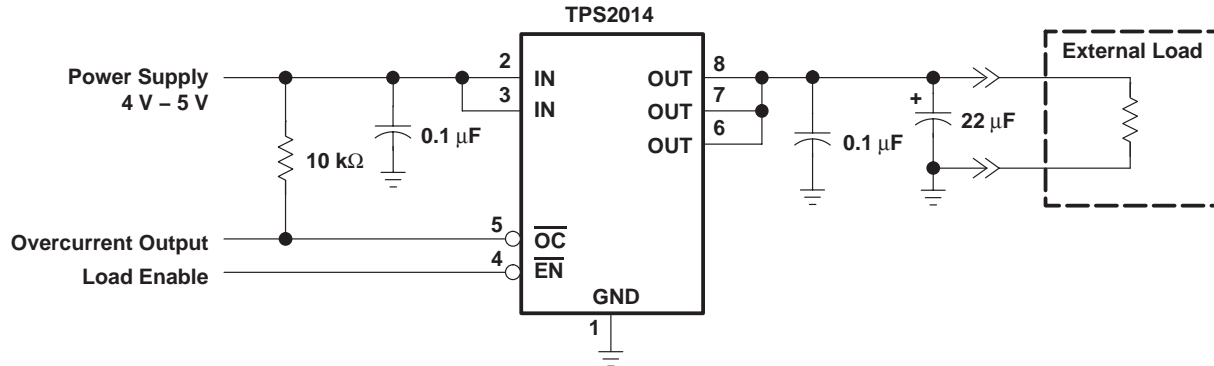

Figure 24. Typical Application

power supply considerations

The TPS20xx has multiple inputs and outputs that must be connected in parallel to minimize voltage drop and prevent unnecessary power dissipation.

A 0.1- μF ceramic bypass capacitor between IN and GND, close to the device, is recommended. A high-value electrolytic capacitor is also desirable when the output load is heavy or has large paralleled capacitors. Bypassing the output with a 0.1- μF ceramic capacitor improves the immunity of the device to electrostatic discharge (ESD).

overcurrent

A sense FET is employed to check for overcurrent conditions. Unlike sense resistors and polyfuses, sense FETs do not increase series resistance to the current path. When an overcurrent condition is detected, the device maintains a constant output current and reduces the output voltage accordingly. Shutdown only occurs when the fault is present long enough to activate thermal limiting.

Three possible overload conditions can occur. In the first condition, the output has been shorted before the device is enabled or before $V_{I(IN)}$ has been applied (see Figures 7 and 8). The TPS20xx senses the short and immediately switches into a constant-current output.

Under the second condition, the short occurs while the device is enabled. At the instant the short occurs, very high currents flow for a short time before the current-limit circuit can react (see Figures 3 and 4). After the current-limit circuit has tripped, the device limits normally.

Under the third condition, the load has been gradually increased beyond the recommended operating current. The current is permitted to rise until the current-limit threshold is reached (see Figures 5 and 6). The TPS20xx is capable of delivering current up to the current-limit threshold without damage. When the threshold has been reached, the device switches into its constant-current mode.

APPLICATION INFORMATION

power dissipation and junction temperature

The low on-resistance of the n-channel MOSFET allows small surface-mount packages, such as SOIC, to pass large currents. The thermal resistance of these packages is high compared to that of power packages; it is good design practice to check power dissipation and junction temperature. The first step is to find r_{on} at the input voltage and at the operating temperature. As an initial estimate, use the highest operating ambient temperature of interest and read r_{on} from Figure 17. Next calculate the power dissipation using:

$$P_D = r_{on} \times I^2$$

Finally, calculate the junction temperature:

$$T_J = P_D \times R_{\theta JA} + T_A$$

Where:

T_A = Ambient temperature

$R_{\theta JA}$ = Thermal resistance SOIC = 172°C/W, P = 106°C/W

Compare the calculated junction temperature with the initial estimate. If they do not agree within a few degrees, repeat the calculation using the calculated value as the new estimate. Two or three iterations are generally sufficient to get a reasonable answer.

thermal protection

Thermal protection is provided to prevent damage to the IC when heavy-overload or a short-circuit fault is present for an extended period of time. The fault forces the TPS20xx into constant current mode, which causes the voltage across the high-side switch to increase. Under short-circuit conditions, the voltage across the switch is equal to the input voltage. The increased dissipation causes the junction temperature to rise to dangerously high levels. The protection circuit senses the junction temperature of the switch and shuts it off. The switch remains off until the junction temperature has dropped approximately 20°C. The switch continues to cycle in this manner until the load fault or the input power is removed.

undervoltage lockout

An undervoltage lockout is provided to ensure that the power switch is in the off state at power up. Whenever the input voltage falls below approximately 3.2 V, the power switch quickly turns off. This facilitates the design of hot-insertion systems that may not have the ability to turn off the power switch before input power is removed. Upon reapplication of the input voltage (if enabled), the power switch turns on with a controlled rise time to reduce inrush current, EMI, and voltage overshoots.

For proper operation of the UVLO, the TPS20xx requires the voltage decay from 3 V to 2 V to take at least 200 μ s. Capacitance is added to the input or output of the TPS20xx to increase this decay rate. Capacitance is generally added to the output to lower inrush current due to input capacitance.

Universal Serial Bus (USB) applications

The USB specification provides for five different classes of devices based on their power sourcing and sinking requirements. These classes of devices are: bus-powered hub, self-powered hub, lower power bus-powered function, high power bus-powered function, and self-powered functions. The TPS20xx can provide power distribution solutions for many of these devices.

APPLICATION INFORMATION

bus-powered and self-power hubs

Hubs provide data and power for downstream functions through output ports. Self-power hubs have internal power supplies that furnish power to downstream functions. Each port is required to supply 500 mA continuous to a downstream function. Each port must have overcurrent protection to meet the regulatory safety limit that no single port can deliver more than 5 A. The self-power hub must also have a method to detect and report an overcurrent condition to the USB host. The TPS20xx provides the required current-limiting function and has an overcurrent logic output to inform the hub controller of the fault condition. The on-state resistance of the TPS20xx is low enough to meet all USB voltage regulation requirements. The switch also provides the capability to remove power from a faulted port.

Bus-powered hubs distribute power and data from an input port to downstream ports. Each output port is required to supply 100 mA continuous. A bus-powered hub is not required to provide overcurrent protection because it is provided by the upstream port. In order to power up in a low power state, the self-powered hub must be able to switch power to its output ports. The TPS20xx can also provide this function.

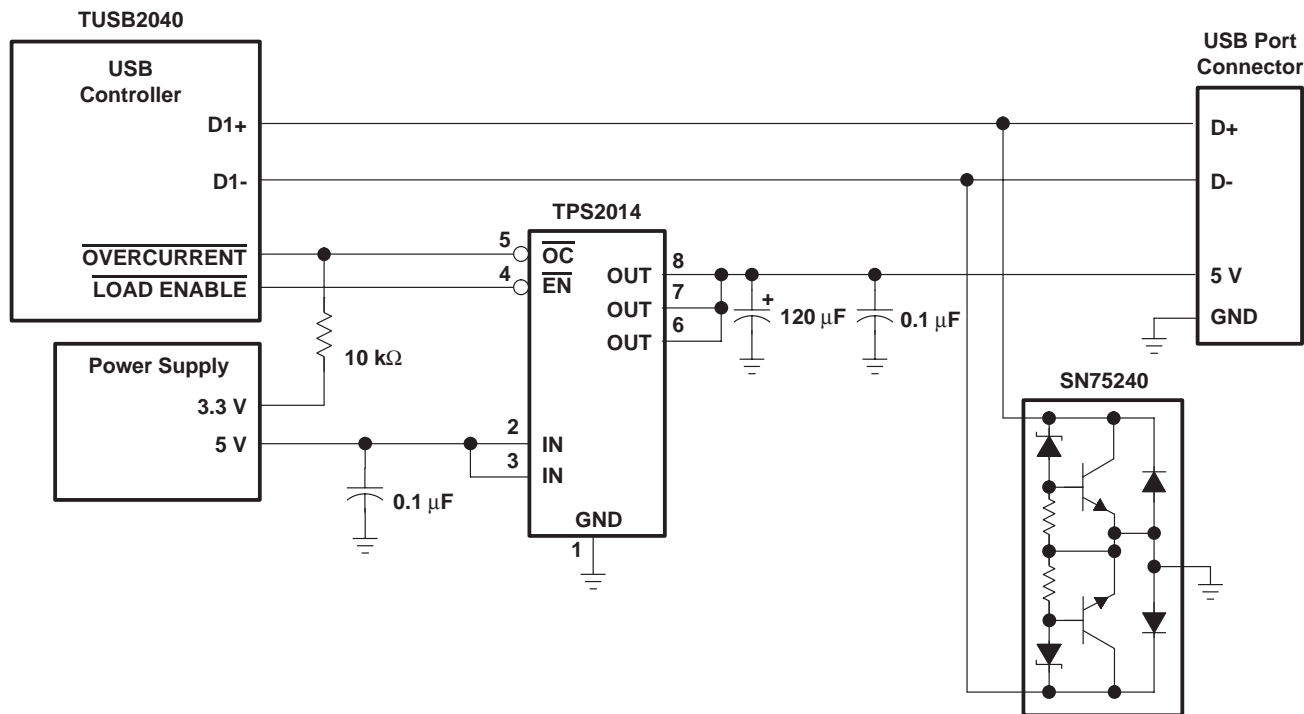

Figure 25. Typical USB Self-Powered Hub Application

low power bus-powered functions and high power bus-powered functions

Low-power and high-power bus-powered functions are powered by their input ports. If the load of the function is more than the parallel combination of 44 Ω and 10 µF, it must implement inrush current limiting. The TPS20xx provides this function with its controlled rise time during turn on.

APPLICATION INFORMATION

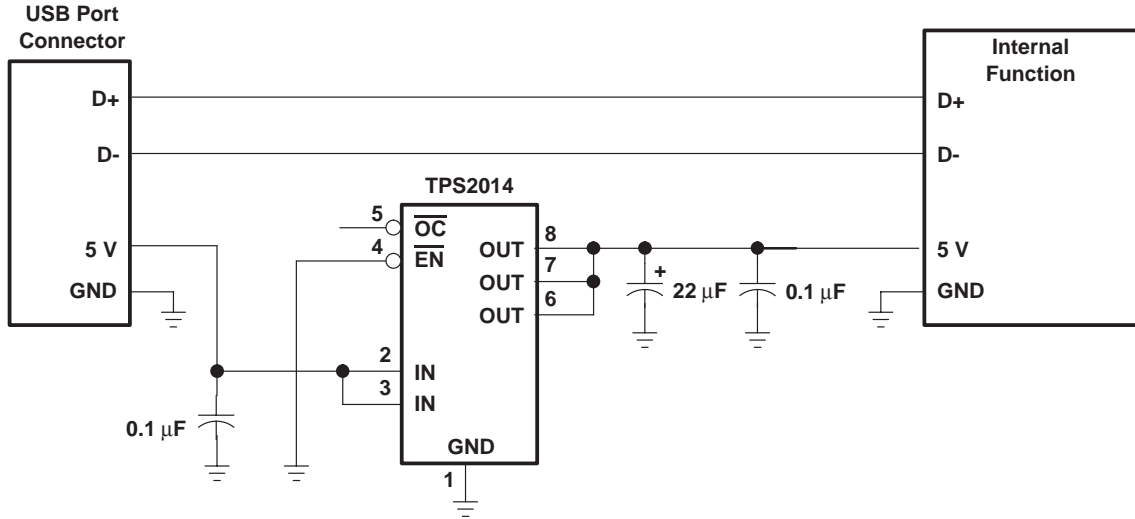

Figure 26. Typical USB Bus-Powered Function Application

ESD protection

All TPS20xx terminals incorporate ESD-protection circuitry designed to withstand a 6-kV human-body-model discharge as defined in MIL-STD-883C. Additionally, the output is protected from discharges up to 12 kV.

PACKAGING INFORMATION

Orderable Device	Status ⁽¹⁾	Package Type	Package Drawing	Pins	Package Qty	Eco Plan ⁽²⁾	Lead/Ball Finish	MSL Peak Temp ⁽³⁾
TPS2014D	NRND	SOIC	D	8	75	Green (RoHS & no Sb/Br)	CU NIPDAU	Level-1-260C-UNLIM
TPS2014DG4	NRND	SOIC	D	8	75	Green (RoHS & no Sb/Br)	CU NIPDAU	Level-1-260C-UNLIM
TPS2014DR	NRND	SOIC	D	8	2500	Green (RoHS & no Sb/Br)	CU NIPDAU	Level-1-260C-UNLIM
TPS2014DRG4	NRND	SOIC	D	8	2500	Green (RoHS & no Sb/Br)	CU NIPDAU	Level-1-260C-UNLIM
TPS2014P	NRND	PDIP	P	8	50	Pb-Free (RoHS)	CU NIPDAU	N / A for Pkg Type
TPS2014PE4	NRND	PDIP	P	8	50	Pb-Free (RoHS)	CU NIPDAU	N / A for Pkg Type
TPS2015D	NRND	SOIC	D	8	75	Green (RoHS & no Sb/Br)	CU NIPDAU	Level-1-260C-UNLIM
TPS2015DG4	NRND	SOIC	D	8	75	Green (RoHS & no Sb/Br)	CU NIPDAU	Level-1-260C-UNLIM
TPS2015DR	NRND	SOIC	D	8	2500	Green (RoHS & no Sb/Br)	CU NIPDAU	Level-1-260C-UNLIM
TPS2015DRG4	NRND	SOIC	D	8	2500	Green (RoHS & no Sb/Br)	CU NIPDAU	Level-1-260C-UNLIM
TPS2015P	NRND	PDIP	P	8	50	Pb-Free (RoHS)	CU NIPDAU	N / A for Pkg Type
TPS2015PE4	NRND	PDIP	P	8	50	Pb-Free (RoHS)	CU NIPDAU	N / A for Pkg Type

⁽¹⁾ The marketing status values are defined as follows:

ACTIVE: Product device recommended for new designs.

LIFEBUY: TI has announced that the device will be discontinued, and a lifetime-buy period is in effect.

NRND: Not recommended for new designs. Device is in production to support existing customers, but TI does not recommend using this part in a new design.

PREVIEW: Device has been announced but is not in production. Samples may or may not be available.

OBSOLETE: TI has discontinued the production of the device.

⁽²⁾ Eco Plan - The planned eco-friendly classification: Pb-Free (RoHS), Pb-Free (RoHS Exempt), or Green (RoHS & no Sb/Br) - please check <http://www.ti.com/productcontent> for the latest availability information and additional product content details.

TBD: The Pb-Free/Green conversion plan has not been defined.

Pb-Free (RoHS): TI's terms "Lead-Free" or "Pb-Free" mean semiconductor products that are compatible with the current RoHS requirements for all 6 substances, including the requirement that lead not exceed 0.1% by weight in homogeneous materials. Where designed to be soldered at high temperatures, TI Pb-Free products are suitable for use in specified lead-free processes.

Pb-Free (RoHS Exempt): This component has a RoHS exemption for either 1) lead-based flip-chip solder bumps used between the die and package, or 2) lead-based die adhesive used between the die and leadframe. The component is otherwise considered Pb-Free (RoHS compatible) as defined above.

Green (RoHS & no Sb/Br): TI defines "Green" to mean Pb-Free (RoHS compatible), and free of Bromine (Br) and Antimony (Sb) based flame retardants (Br or Sb do not exceed 0.1% by weight in homogeneous material)

⁽³⁾ MSL, Peak Temp. -- The Moisture Sensitivity Level rating according to the JEDEC industry standard classifications, and peak solder temperature.

Important Information and Disclaimer: The information provided on this page represents TI's knowledge and belief as of the date that it is provided. TI bases its knowledge and belief on information provided by third parties, and makes no representation or warranty as to the accuracy of such information. Efforts are underway to better integrate information from third parties. TI has taken and continues to take reasonable steps to provide representative and accurate information but may not have conducted destructive testing or chemical analysis on incoming materials and chemicals. TI and TI suppliers consider certain information to be proprietary, and thus CAS numbers and other limited information may not be available for release.

In no event shall TI's liability arising out of such information exceed the total purchase price of the TI part(s) at issue in this document sold by TI to Customer on an annual basis.

P (R-PDIP-T8)

PLASTIC DUAL-IN-LINE



- NOTES: A. All linear dimensions are in inches (millimeters).
 B. This drawing is subject to change without notice.
 C. Falls within JEDEC MS-001

For the latest package information, go to http://www.ti.com/sc/docs/package/pkg_info.htm



D (R-PDSO-G8)

PLASTIC SMALL-OUTLINE PACKAGE



- NOTES:
- A. All linear dimensions are in inches (millimeters).
 - B. This drawing is subject to change without notice.
 - C. Body length does not include mold flash, protrusions, or gate burrs. Mold flash, protrusions, or gate burrs shall not exceed .006 (0,15) per end.
 - D. Body width does not include interlead flash. Interlead flash shall not exceed .017 (0,43) per side.
 - E. Reference JEDEC MS-012 variation AA.

IMPORTANT NOTICE

Texas Instruments Incorporated and its subsidiaries (TI) reserve the right to make corrections, modifications, enhancements, improvements, and other changes to its products and services at any time and to discontinue any product or service without notice. Customers should obtain the latest relevant information before placing orders and should verify that such information is current and complete. All products are sold subject to TI's terms and conditions of sale supplied at the time of order acknowledgment.

TI warrants performance of its hardware products to the specifications applicable at the time of sale in accordance with TI's standard warranty. Testing and other quality control techniques are used to the extent TI deems necessary to support this warranty. Except where mandated by government requirements, testing of all parameters of each product is not necessarily performed.

TI assumes no liability for applications assistance or customer product design. Customers are responsible for their products and applications using TI components. To minimize the risks associated with customer products and applications, customers should provide adequate design and operating safeguards.

TI does not warrant or represent that any license, either express or implied, is granted under any TI patent right, copyright, mask work right, or other TI intellectual property right relating to any combination, machine, or process in which TI products or services are used. Information published by TI regarding third-party products or services does not constitute a license from TI to use such products or services or a warranty or endorsement thereof. Use of such information may require a license from a third party under the patents or other intellectual property of the third party, or a license from TI under the patents or other intellectual property of TI.

Reproduction of information in TI data books or data sheets is permissible only if reproduction is without alteration and is accompanied by all associated warranties, conditions, limitations, and notices. Reproduction of this information with alteration is an unfair and deceptive business practice. TI is not responsible or liable for such altered documentation.

Resale of TI products or services with statements different from or beyond the parameters stated by TI for that product or service voids all express and any implied warranties for the associated TI product or service and is an unfair and deceptive business practice. TI is not responsible or liable for any such statements.

Following are URLs where you can obtain information on other Texas Instruments products and application solutions:

Products		Applications	
Amplifiers	amplifier.ti.com	Audio	www.ti.com/audio
Data Converters	dataconverter.ti.com	Automotive	www.ti.com/automotive
DSP	dsp.ti.com	Broadband	www.ti.com/broadband
Interface	interface.ti.com	Digital Control	www.ti.com/digitalcontrol
Logic	logic.ti.com	Military	www.ti.com/military
Power Mgmt	power.ti.com	Optical Networking	www.ti.com/opticalnetwork
Microcontrollers	microcontroller.ti.com	Security	www.ti.com/security
Low Power Wireless	www.ti.com/lpw	Telephony	www.ti.com/telephony
		Video & Imaging	www.ti.com/video
		Wireless	www.ti.com/wireless

Mailing Address: Texas Instruments
Post Office Box 655303 Dallas, Texas 75265