

YAMAHA

Producer Series

OWNER'S MANUAL

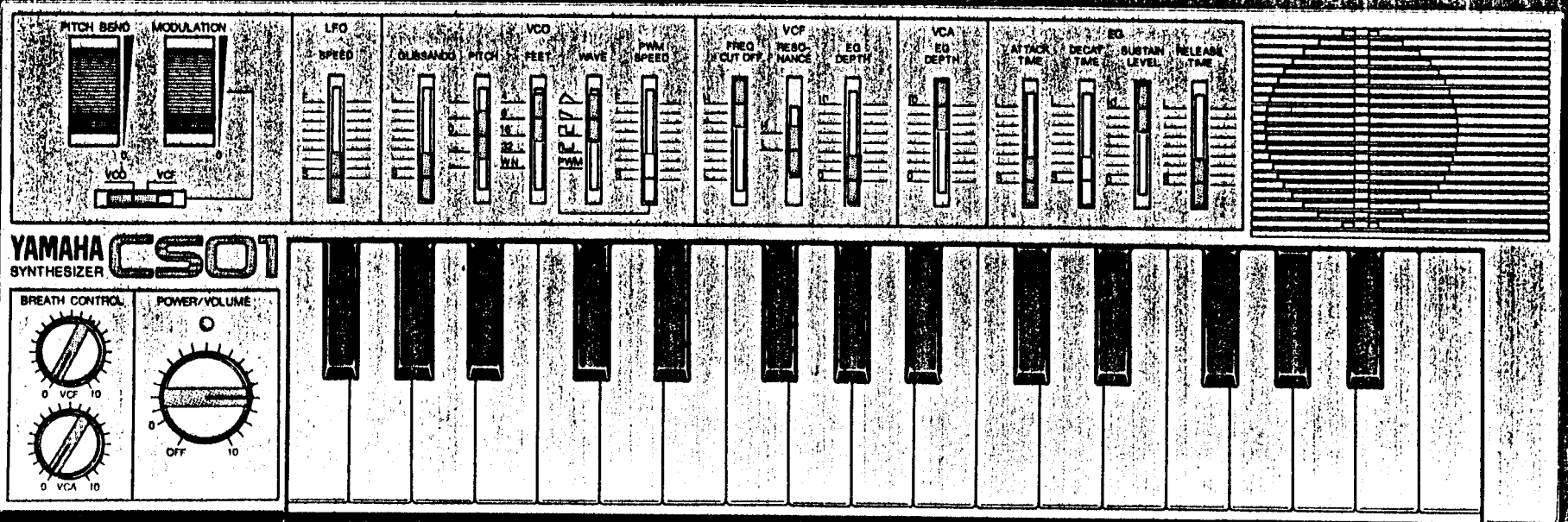



INTRODUCTION

Thank you for choosing a Yamaha CS01 Micro-Monophonic Synthesizer. The CS01 incorporates advanced synthesizer technology and features developed for the renowned Yamaha CS-series synthesizers with the added convenience and versatility of a lightweight, exceptionally compact format. Further, the CS01 has a built-in amp and speaker, and can be run on either batteries or an optional AC adaptor unit. The CS01 imposes no limitations on where or when you play. Outdoors, at home or on stage, the Yamaha CS01 gives you great Yamaha synthesizer sound and versatility.

We urge you to read this owner's manual thoroughly in order to make the most of your CS01 Micro-Monophonic Synthesizer.

CONTENTS

INTRODUCTION	1
CAUTIONS	2
SETUP PROCEDURE	3
BASIC SETTING	6
SOUND CREATION I/VCO	7
SOUND CREATION II/VCF	8
SOUND CREATION III/VCA	10
SOUND CREATION IV/EG	11
SOUND CREATION V/OTHER FUNCTIONS	12
SPECIFICATIONS	15
BLOCK DIAGRAM	16
SHOULDER STRAP PINS	17
OPTIONS	17
SOUND VARIATION	18

CAUTIONS

● INSTALLATION/LOCATION

Do not use this unit in any of the locations mentioned below, as this may impair the sound quality or result in failure or breakdown.

- * Location near a window where the unit may be exposed to direct sunlight or other extremely hot locations.
- * Locations with a particularly low temperature.
- * Locations exposed to high levels of moisture or dust.
- * Locations susceptible to vibration.

● DO NOT USE FORCE

Do not force when using the switches or knobs.

● TAKE CARE OF THE POWER CORD

In order to prevent cord breakage and shortcircuits, take hold of the plug, not the actual cord, when disconnecting it from the power outlet. If the unit is not to be used for prolonged periods of time, disconnect the plug from the power outlet.

● MOVING THE UNIT

Make sure that you disconnect the power cord and detach connecting cables to other equipment before moving the unit.

● CONNECTING AND DISCONNECTING OUTPUT CORDS

If the output cords are connected or disconnected when the volume level of the amplifier should always be set with care, as the application of excessive input to the amplifier may cause damage to the amplifier or speakers. Before connecting or disconnecting the output cords to the other equipments, make sure to switch off each power switch.

● MAINTAINING THE UNIT

Do not wipe the unit with benzine or thinner, and do not use aerosol sprays in its vicinity. Always use a soft cloth to wipe the unit.

● KEEP THIS MANUAL

Keep this manual in a safe place for future reference, and refer to it frequently until you are fully familiar with your CS01.

● THUNDER STORMS

Remember to disconnect the power plug from the power outlet whenever there is a thunderstorm in order to prevent accidents resulting from lightning.

● OTHER APPLIANCES

Since your CS01 incorporates a considerable amount of digital circuitry, it is advisable to use it where it will not be influenced by electromagnetic radiation from appliances such as televisions, radios, etc.

SETUP PROCEDURE

POWER SUPPLY

1. Open the battery compartment on the bottom of the unit.

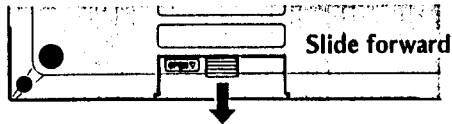

2. Observing polarity as shown in the illustration, insert six batteries into the battery compartment.

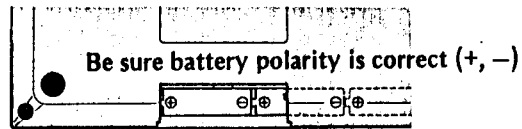

3. Close the battery compartment.

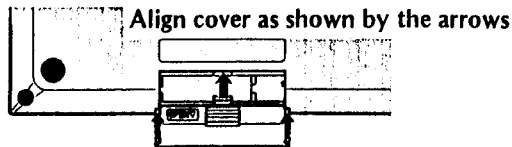

When you intend to run the CS01 on batteries, make sure the optional PA-1 AC adaptor is unplugged from the CS01 external power jack. The batteries are automatically disconnected when the PA-1 is plugged into the CS01 power jack.

BATTERY LIFE

Battery life depends to some degree on the type of batteries used and volume level, but generally, 6 hours of continuous use can be expected when using the built-in amp and speaker at maximum volume. Battery life is approximately 16 hours when using an external amplifier.

BATTERY REPLACEMENT

The CS01 features a built-in low-battery warning circuit. When battery voltage drops below the usable level, the CS01 power indicator LED will flash on and off. When this occurs, all the batteries should be replaced before battery operation is continued.

BATTERY OPERATION

Install batteries as shown in the illustrations.

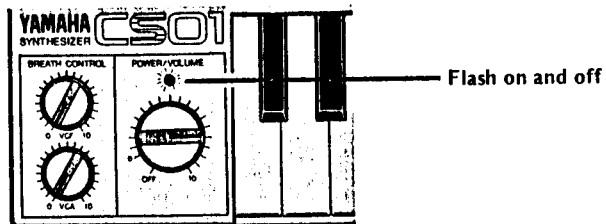

- * Be sure to replace all batteries with new ones at one time. Used batteries and new batteries must not be mixed.
- * If batteries are not to be used for an extended period of time, they should be removed from the battery compartment to prevent damage due to battery leakage.

1 AC ADAPTOR

The optional PA-1 AC adaptor plugs into the CS01 DC IN 12V jack.

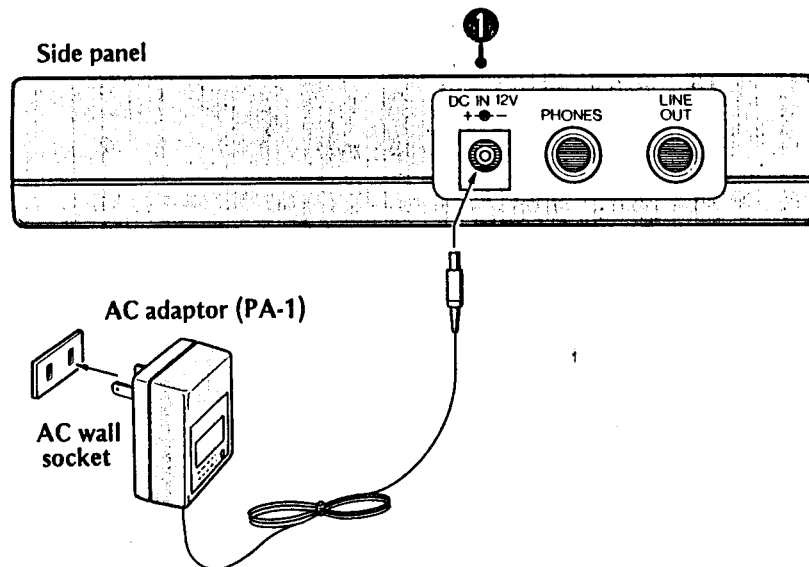

The batteries are disconnected when the PA-1 is in use, so no battery discharge will occur.

Using AC adaptors other than the PA-1 may result in damage to the CS01 due to incorrect polarity.

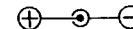

Polarity is reversed in some adaptors



CONNECTING TO AN EXTERNAL AMP

When using the CS01 with headphones or an external amplifier rather than the built-in amplifier and speaker, connections must be made via the CS01 side panel.

When a plug is inserted into either the PHONES or LINE OUT jack, the internal speaker is automatically shut off.

② PHONES (HEADPHONE JACK)

This jack accepts either a pair of monaural keyboard monitor headphones or any standard pair of stereo headphones (output is monaural).

③ LINE OUT

Provides output to an external amplifier or mixer. This output jack cannot be connected directly to an external speaker. A music instrument amplifier or audio amplifier must be used.

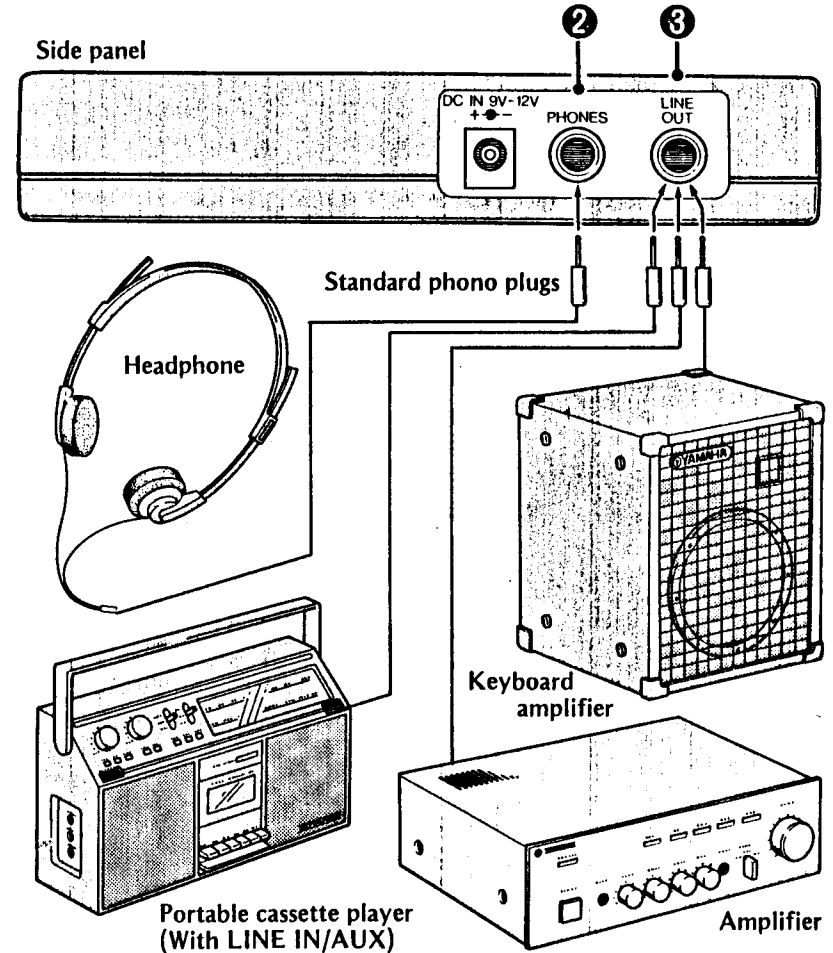

BASIC SETTING

TURNING THE INSTRUMENT ON

④ POWER/VOLUME

This control serves the dual function of power switch and volume control. If rotated clockwise the unit is turned ON and the indicator LED will light. Volume increases as the control is rotated towards the "10" end of its scale.

The CS01 is a monophonic synthesizer (high-note priority). If more than one key is pressed at a time, only the sound of the highest note played will be heard.

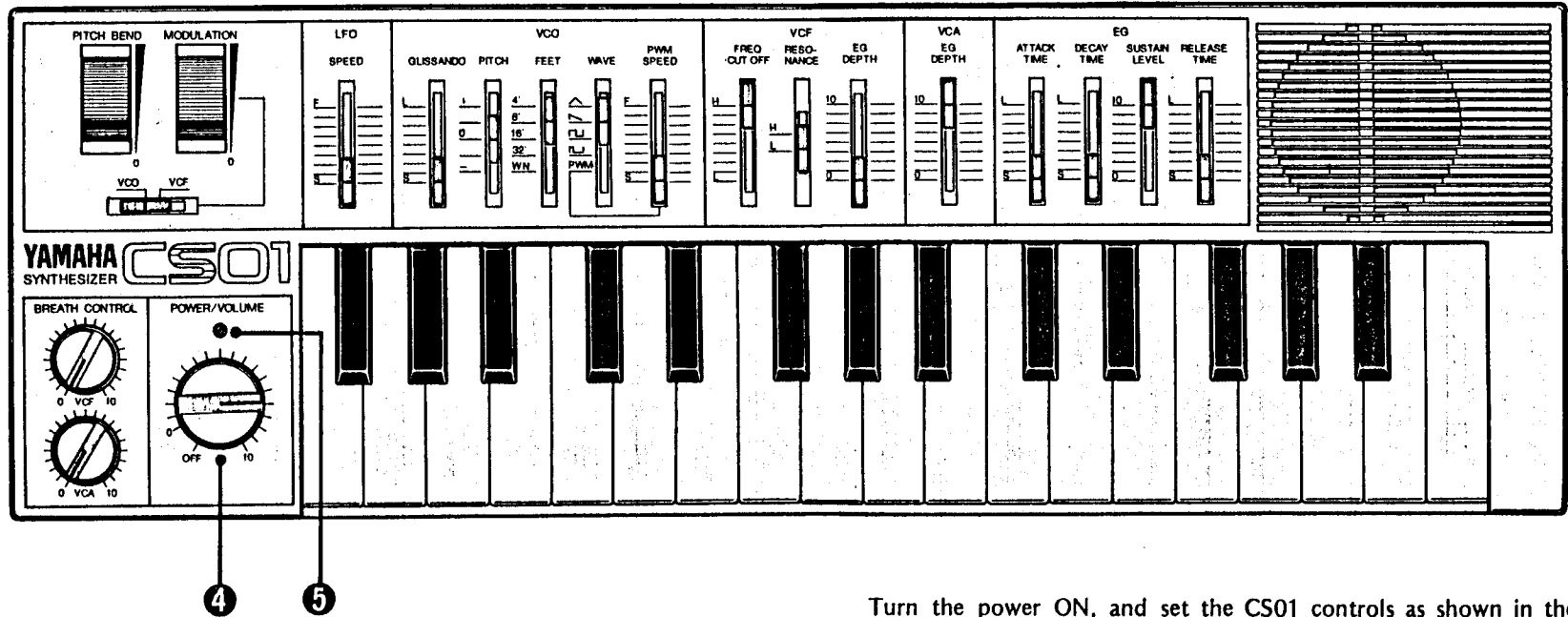

Turn the power ON, and set the CS01 controls as shown in the illustration. You should now be able to hear notes played via the CS01's speaker.

SOUND CREATION I/VCO

THE VCO BLOCK

The VCO (Voltage Controlled Oscillator) is the basic sound source of the CS01 producing a signal at the pitch determined by the keyboard.

RANGE SELECTION

① FEET SELECTOR

This selector determines the range of the CS01 keyboard. The CS01's 32-key keyboard covers a range of 2-1/2 octave (F₂-C₅ when the FEET selector is set to 8). The FEET selector permits shifting the keyboard range over a five octave range.

If this selector is set to WN, white noise is produced. By applying filtration to this white noise using the CS01 VCF, the sound of surf, wind or waves can be created.

Try switching the FEET selector through its settings while playing a note on the keyboard.

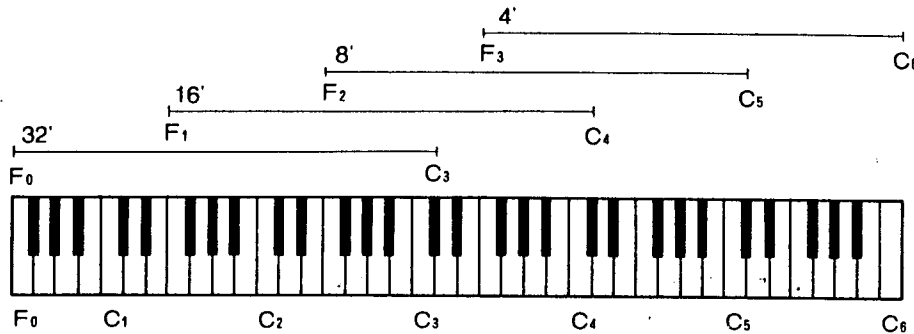

ADJUSTING PITCH

② PITCH LEVER

This is the CS01 "tuning" control. It permits you to match the CS01 pitch with that of other instruments.

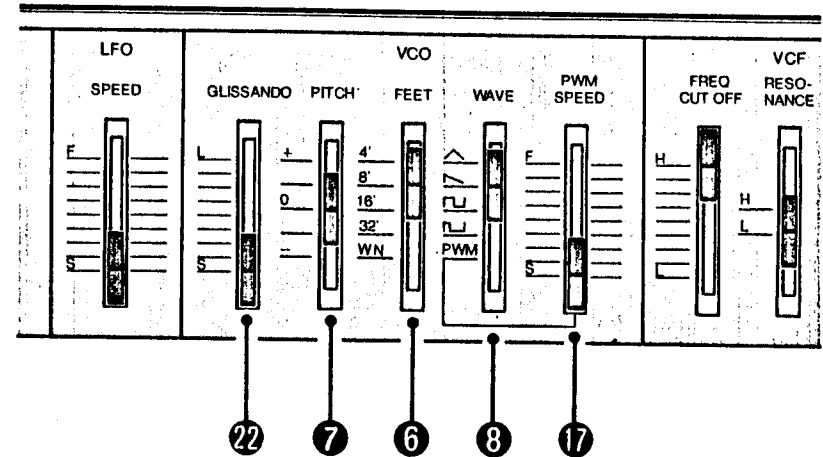

WAVEFORM SELECTION

③ WAVE SWITCH

Determines the waveform produced by the VCO. Different VCO waveforms have different types (odd or even) and different numbers of harmonics, and therefore different sounds.

SOUND CREATION II/VCF

The CS01 offers four different waveforms plus a pulse width modulation feature as shown in the chart below.

Waveform	Name	Characteristics
∧	Triangular wave	Subdued tone. Ideal for flute sounds.
∟	Sawtooth wave	Bright tone. Perfect for violin and other string sounds or brass instrument sounds.
□	Square wave	"Woody" tone. Great for clarinet.
▭	Rectangular wave	Vibrant tone. Trumpet, oboe, etc.
▭	PWM	Thick, rich sound. Chorus effect.

The PWM SPEED ⑰ and GLISSANDO ⑳ controls will be described in Sound Creation V/Other Functions.

All the controls described so far determine the basic CS01 sound. In order to fully understand the operation of the VCF (described next), return the controls to their Basic Settings (refer to the illustration on the previous page).

VCF BLOCK

The VCF (Voltage Controlled Filter) alters the tonality of sounds created by the VCO by cutting off certain harmonics.

CREATING THE DESIRED TONALITY

⑨ FREQ. CUT OFF LEVER

Determines the cut off frequency of the VCF.

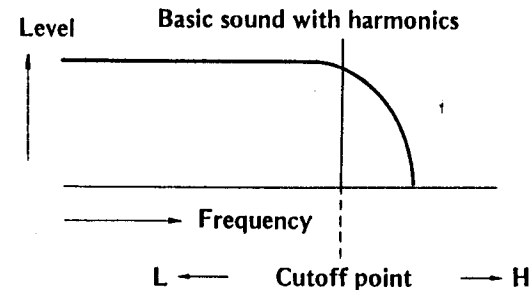

Setting this control at the "H" end of its scale permits all the upper harmonics of the basic sound to pass, thereby creating a bright tonality. Moving the control towards the "L" end of the scale gradually cuts off more and more upper harmonics, creating a rounder, softer tonality. If the FREQ. CUT OFF lever is set all the way to "L", the fundamental may be cut off and no sound will be heard.

10 RESONANCE SELECTOR

Set to the "H" position, frequencies near the filter cut off frequency are emphasized for a "sharper" sound.

Frequencies near the cutoff point are emphasized

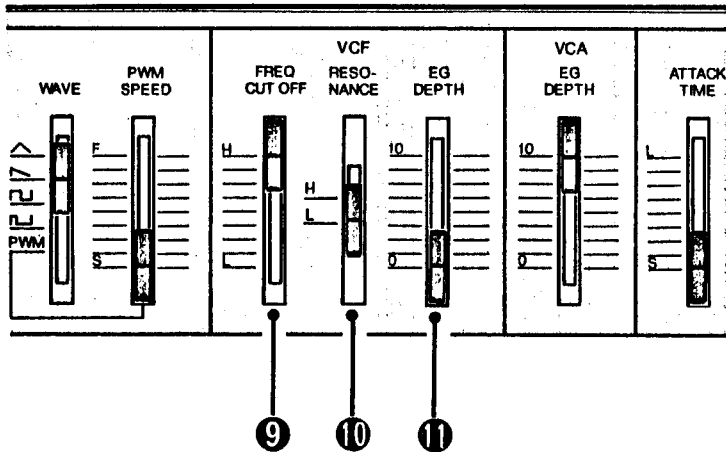
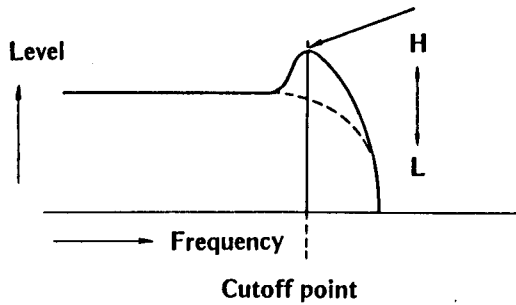

11 EG DEPTH LEVER

Determines to what degree the envelope set up at the EG (Envelope Generator) block affects the VCF cut off frequency. This permits creation of a broad range of interesting time-based tonal variation effects.

Maximum EG effect is achieved when this control is set all the way to the "10" end of its scale.

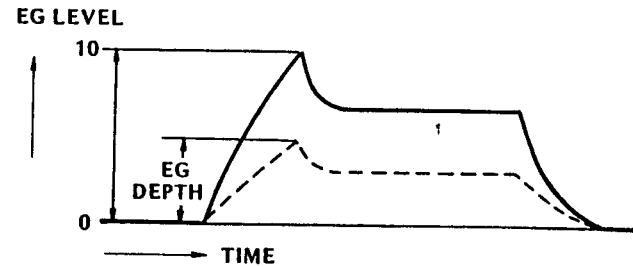

SOUND CREATION III/VCA

VCA BLOCK

The VCA (Voltage Controlled Amplifier) controls the level (shape) of the sound according to the shape of the envelope generator control voltage.

LEVEL VARIATION

12 EG DEPTH LEVER

Determines to what degree the envelope set up at the EG (Envelope Generator) block affects the level of the sound. The envelope generator control signal varies the gain (amount of amplification) of the VCA, permitting creation of a broad range of interesting time-based level variation.

Maximum EG effect is achieved when this control is set all the way to the "10" end of its scale.

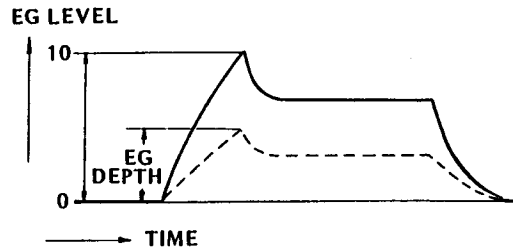
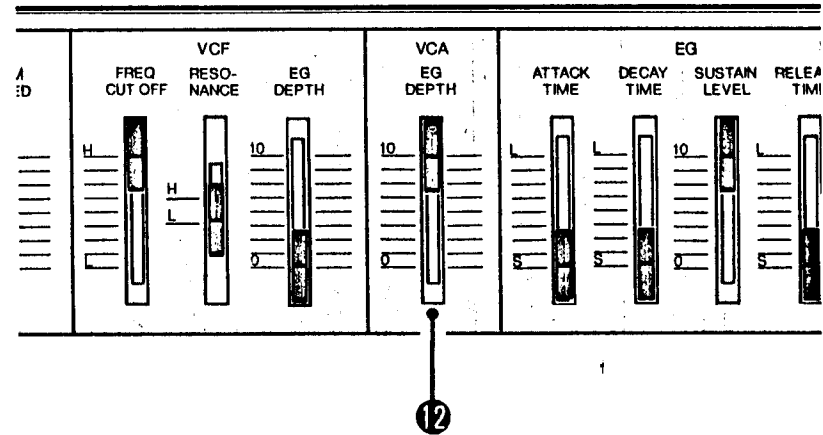

SOUND CREATION IV/EG

EG BLOCK

The EG block contains the CS01 envelope generator controls. The sound of an instrument is largely determined by its pitch, tone, volume and envelope. Piano and flute sounds, for example, consist of basically the same waveform, but have completely different level envelopes. A flute sound builds up a relatively slow attack and continues at a sustained level, while a piano note begins rapidly (fast attack) and then decays gradually.

The CS01 EG block lets you create an exceptionally broad range of level envelopes.

13 ATTACK TIME LEVER

Determines how long it takes for the sound to reach maximum level after a note is played on the keyboard. The more this control is set towards the "L" end of its scale, the longer the attack.

14 DECAY TIME LEVER

Determines how long it takes for the sound to decrease to sustain level after maximum attack level has been reached. The more this control is set to the "L" end of its scale, the longer the decay.

If the SUSTAIN LEVEL control (described next) is set to maximum, no decay effect will be produced.

15 SUSTAIN LEVEL LEVER

Determines the continuous level to be maintained after attack and decay are finished, as long as a key is held. The more this control is set towards the "10" end of its scale, the higher the sustain level.

When applied to the VCF, the sustain level determines the VCF cut off point.

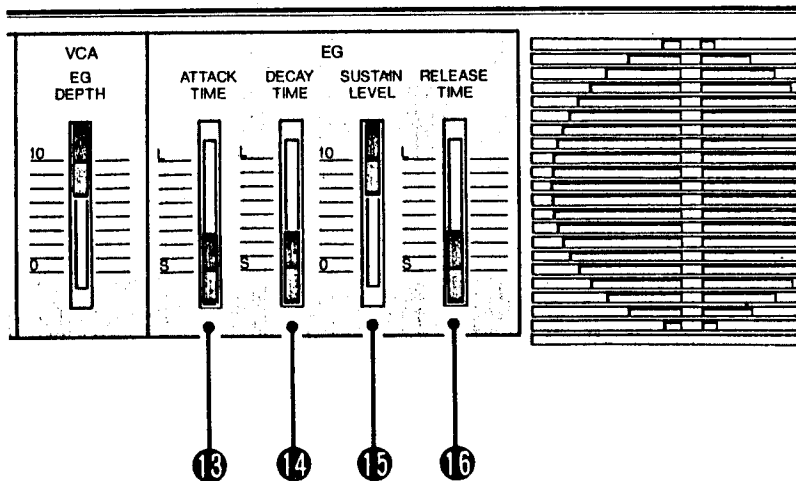

SOUND CREATION V/ OTHER FUNCTIONS

⑩ RELEASE TIME LEVER

Determines how long it takes for the sound to completely fade out after a key has been released. The more this control is set towards the "L" end of its scale, the longer the release.

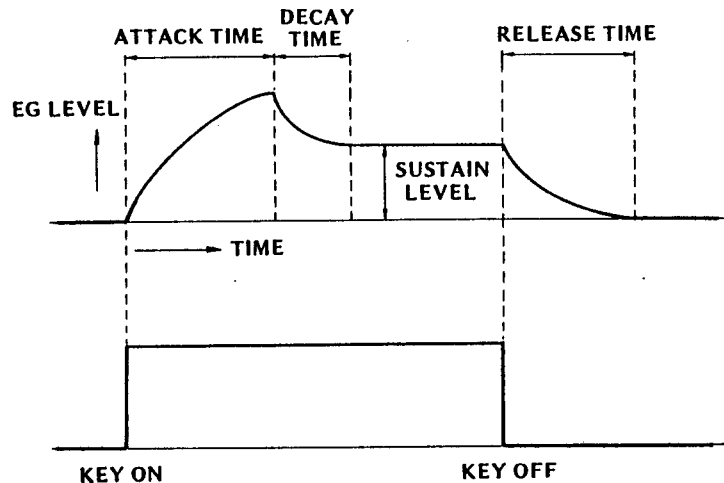

Experiment with the unlimited variety of effects that can be produced by application of the EG control signal to the VCF and VCA.

MODULATION

Modulation means to apply some form of periodic variation to a sound. The CS01 permits modulation via PWM (Pulse Width Modulation) and an LFO (Low Frequency Oscillator).

PWM (PULSE WIDTH MODULATION)

This function periodically varies the width of each pulse in each cycle of a rectangular wave at a speed determined by the setting of the PWM SPEED control ⑰. This function can be used to create a variety of chorus-like effects.

Rectangular wave

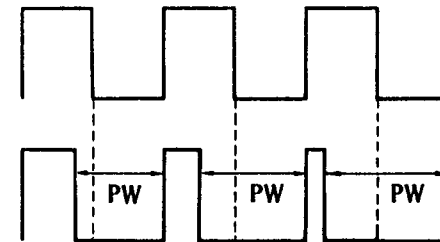

PW: Pulse width

17 PWM SPEED LEVER

Determines the speed of pulse width modulation when the WAVE selector 8 is set to PWM. The more this control is set towards the "F" end of its scale, the faster the PWM speed.

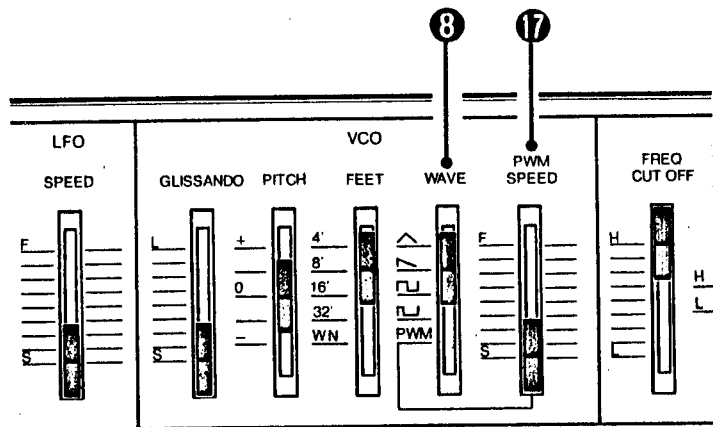

LFO (LOW FREQUENCY OSCILLATOR)

The LFO can be used to modulate the VCO or VCF to create periodic variations in pitch or tonality.

18 LFO SPEED LEVER

Determines the frequency of the LFO. The more this control is set towards the "F" end of its scale, the faster the LFO speed.

19 MODULATION WHEEL

Determines the degree of modulation applied to either the VCO or VCF. No modulation is applied when this wheel is set at "0". Rolling the wheel upward causes increasing modulation depth.

20 VCO/VCF SELECTOR

Determines whether modulation is applied to the VCO or VCF. Applying modulation to the VCO creates vibrato-like effects, while modulation the VCF can create wah-wah, growl, and an extensive variety of other effects.

Applying modulation to the VCF produces a periodic shift in the VCF cut off frequency. If the FREQ. CUT OFF 9 or EG DEPTH 11 controls are set too high, VCF modulation may not be effective.

PITCH VARIATION

21 PITCH BEND WHEEL

This control can be used to create sudden pitch variations as you play. This permits creation of effects similar to choking a guitar string. Pitch can be varied over approximately one octave.

22 GLISSANDO LEVER

Creates a step-wise (1/2-tone steps) glissando between notes played. Set towards the "L" end of its scale this control produces a slow, fowing glissando, while set towards the "S" end of the scale a more continuous portamento-like slide is produced.

Try pressing a low note on the keyboard and then, still holding the low note, play a high note. A step-wise glissando will run from the lower note to the higher note. Now release the high note and the sound will glissando down to the low note.

The glissando effect normally only functions while a key (or keys) is held. If the EG block RELEASE TIME 16 control is set to a long release time, glissando will function during the release of a note.

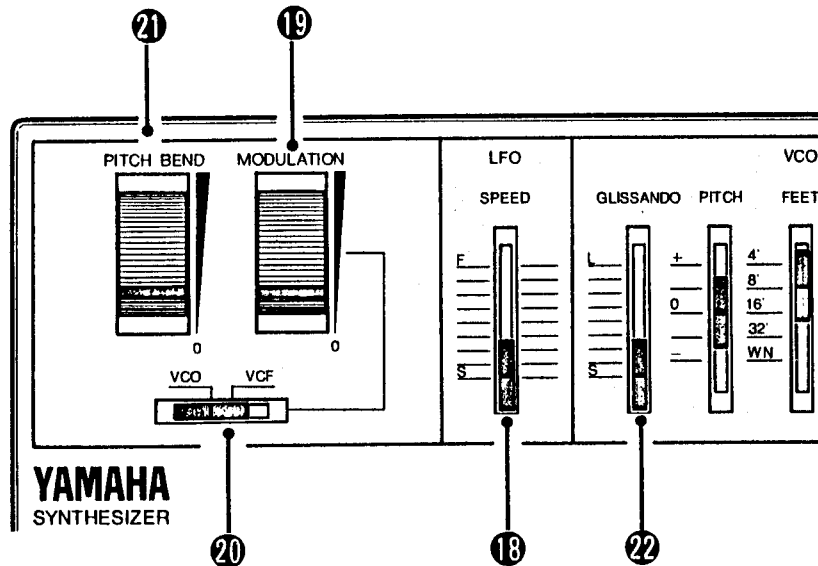

BREATH CONTROL

By connecting the optional Breath Controller unit (BC1) to the CS01, you can control the VCF and VCA according to how hard you blow into the Breath Controller mouthpiece. By permitting wind-instrument type tonguing, etc., this function makes it possible to create effects not possible with any other electronic instrument.

23 BREATH CONTROL JACK

The optional BC1 Breath Controller is connected here. When connecting the Breath Controller, be sure to turn the CS01 volume control all the way down.

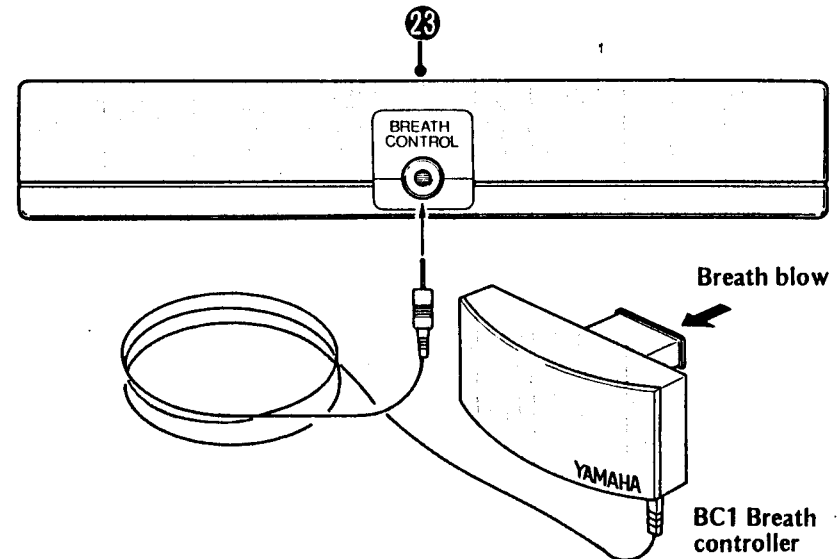

SPECIFICATIONS

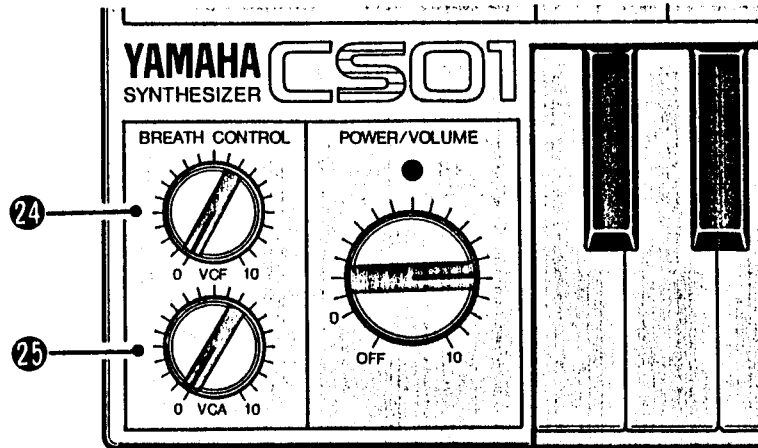

24 VCF SENSITIVITY

Determines to what degree breath control affects the VCF. Be sure that the VCF block **FREQ. CUT OFF** lever ① and **EG DEPTH** lever ② are not set too high or breath control of the VCF will be difficult.

25 VCA SENSITIVITY

Determines to what degree breath control affects the VCA. Be sure that the VCA block **EG DEPTH** lever ② is not set too high or breath control of the VCA will be difficult.

KEYBOARD	32 keys, F ₂ ~ C ₅
LFO	Speed 0.8 ~ 21Hz
GLISSANDO	Speed 0 ~ 6 ± 2 Sec.
VCO	PITCH - ~ 0 ~ +
	FEET 4', 8', 16', 32', NOISE
	WAVE ^, v, □, ▭, PWM
	PWM Speed 0.6 ~ 12Hz
VCF	CUT OFF L ~ H
	RESONANCE H/L
	EG DEPTH 0 ~ 10
VCA	EG DEPTH 0 ~ 10
EG	ATTACK TIME S ~ L
	DECAY TIME S ~ L
	SUSTAIN LEVEL 0 ~ 10
	RELEASE TIME S ~ L
WHEELS	PITCH BEND 1 oct
	MODULATION VCO/VCF
BREATH CONTROL	VCF 0 ~ 10
	VCA 0 ~ 10
POWER SWITCH/VOLUME	0 ~ 10
SIDE PANEL	LINE OUT 10kΩ
	PHONES 8 ~ 150Ω
	DC IN (use PA-1 adaptor)
	BREATH CONT. IN BC1
POWER SOURCE	"R6" or "AA" battery x 6 (9 V)
	AC Adaptor PA-1 (DC 12V, 300mA)
POWER CONSUMPTION	No Output, 550mW
	Maximum Output, 2700mW
DIMENSIONS (WxHxD)	489 x 36 x 160mm (19-1/4" x 1-1/2" x 6-3/8")
WEIGHT	1.5kg (3 lbs, 5 oz)
ACCESSORIES	Breath Controller BC1
	AC Adaptor PA-1
	Soft Case SC-01
	Stereo Headphone MH10

Specifications are subject to change without notice.

BLOCK DIAGRAM

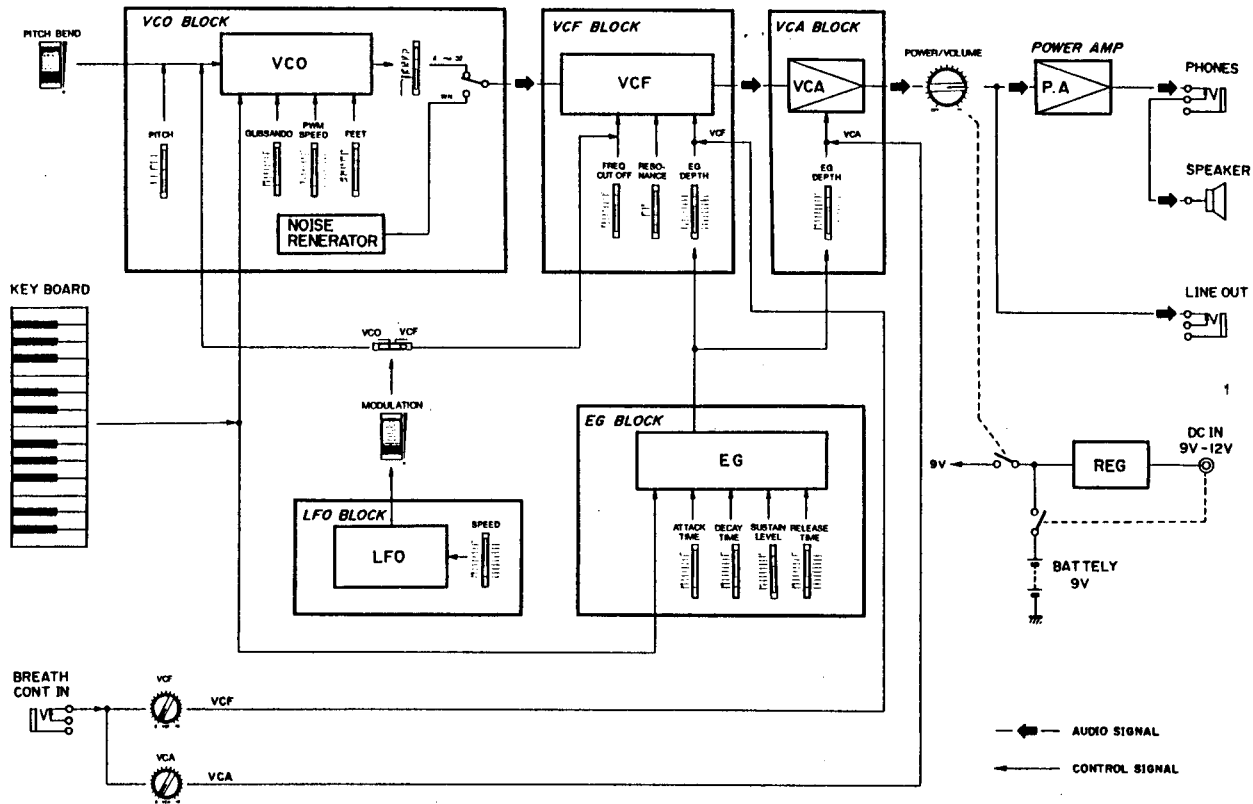

SHOULDER STRAP PINS

By screwing the strap pins (supplied) into each side of the CS01, a shoulder strap can be used letting you play the CS01 hanging from your shoulder--like a guitar. The strap pins are attached as shown below.

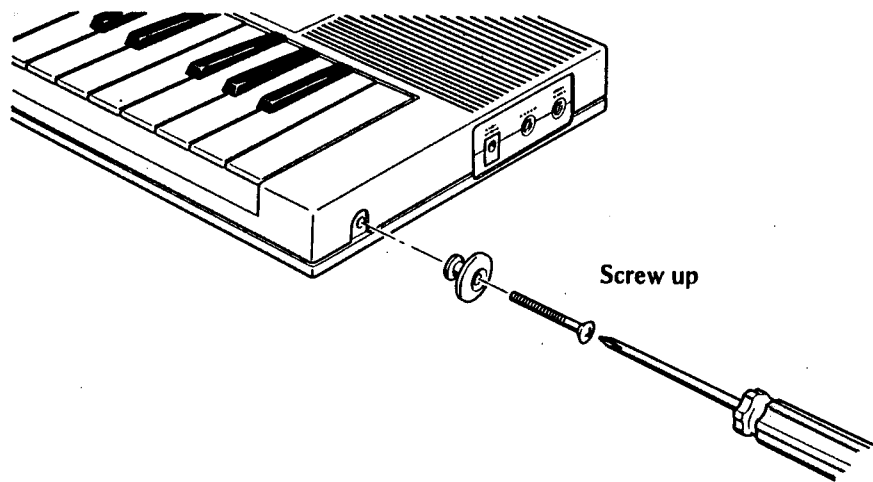

OPTIONS

The following options are available for the CS01

CARRYING CASE (SC-01)

This soft carrying case is indispensable when transporting or storing your CS01. The carrying case strap can be removed and used as a shoulder strap for the CS01. The CS01 is inserted and removed from the case as shown in the illustration.

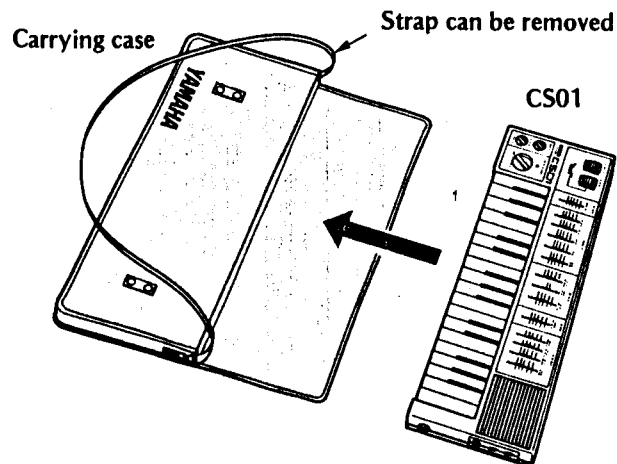

AC ADAPTOR (PA-1)

This handy adaptor lets you run your CS01 from the AC mains to minimize battery wear.

BREATH CONTROLLER (BC1)

Permits breath control of the CS01 VCA and VCF for a broad variety of exciting new electronic sounds.

SOUND VARIATION

The setting examples given in the following charts are but a mere fraction of the unlimited sound creation possibilities provided by the CS01. These settings should give you a good base from which you can go on

to create your own original sounds.

Once you've mastered operation of the CS01, the rest is up to your talent and imagination.

FLUTE

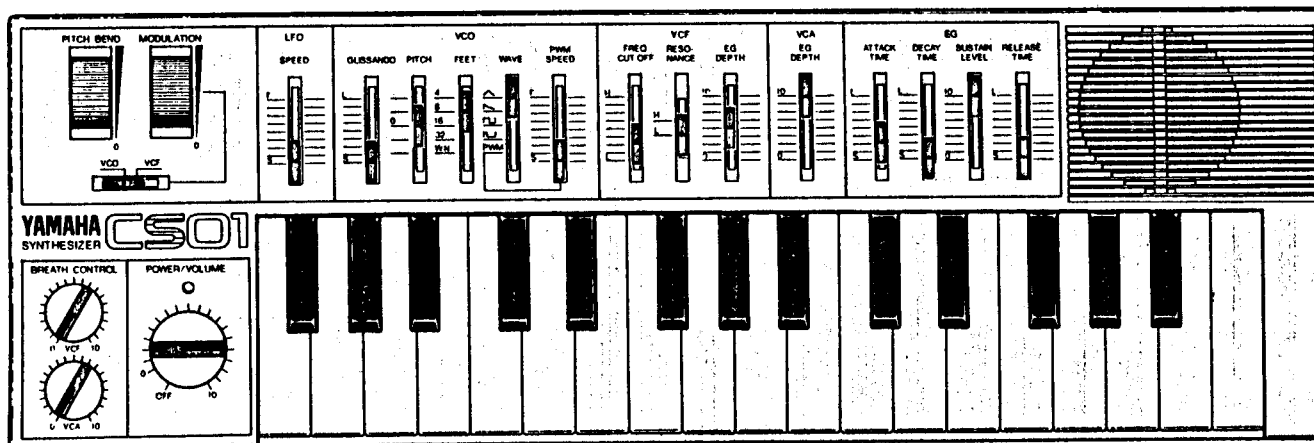

- * Set the LFO to any appropriate speed.
- * If you set the FEET selector to 4 you'll get a piccolo-like sound.
- * Set RESONANCE to "H" and VCF EG DEPTH to about the middle of its range and you'll get a synthesizer flute sound.

VIOLIN

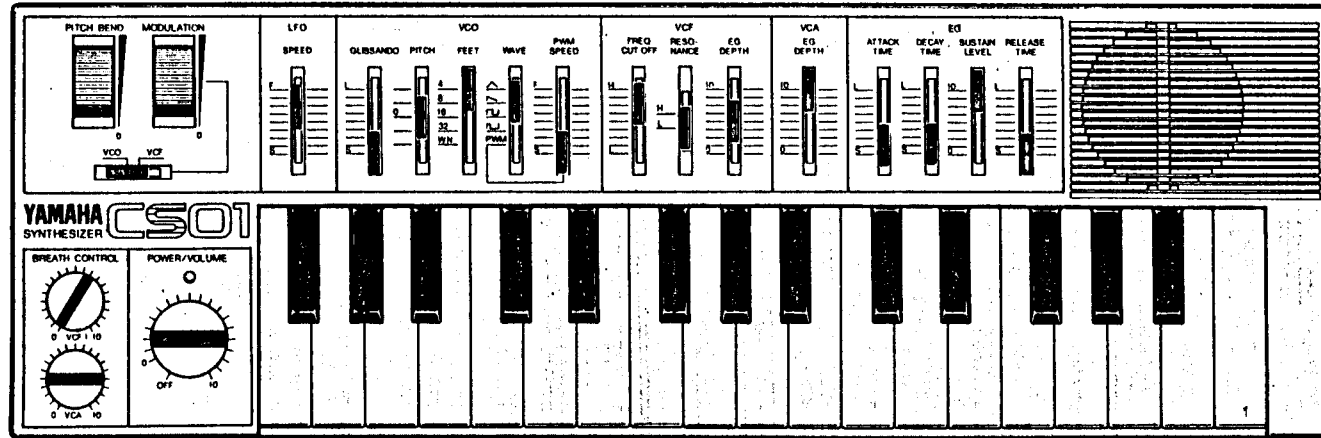

- * Set the LFO for a violin-like vibrato.
- * Setting WAVE to □ produces a recorder-like sound.
- * Extremely realistic violin effects can be created by using the optional Controller and setting the VCA EG DEPTH control to about the middle of its range.

TRUMPET

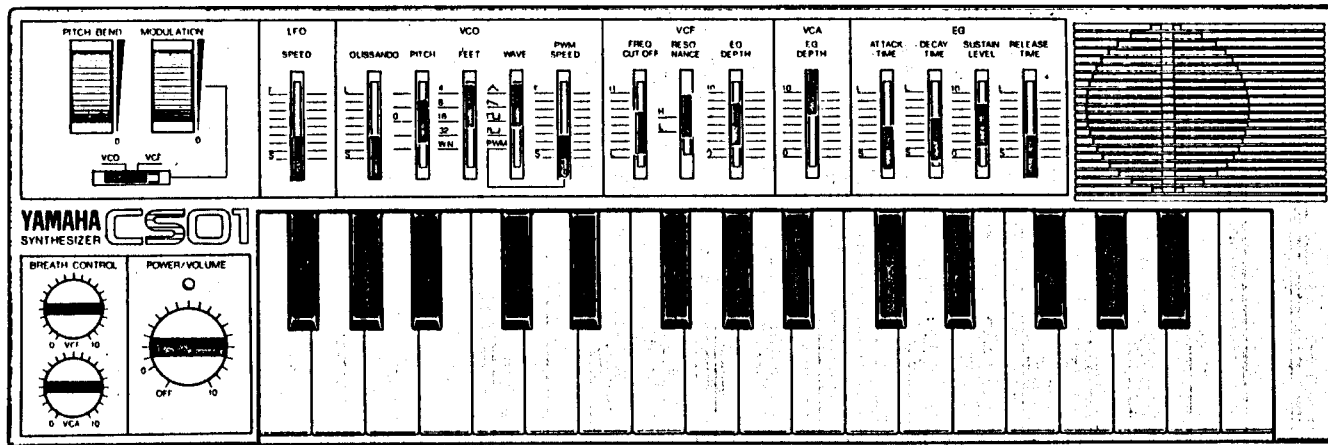

- * Add a slight vibrato with the LFO.
- * Good trumpet sounds can also be created with FEET set to 16.
- * With FEET at 16 and a light glissando you'll get realistic trombone sounds.
- * Try adding accents with the Breath Controller.

.....

.....

.....

.....

SYNTH-CLAVINET

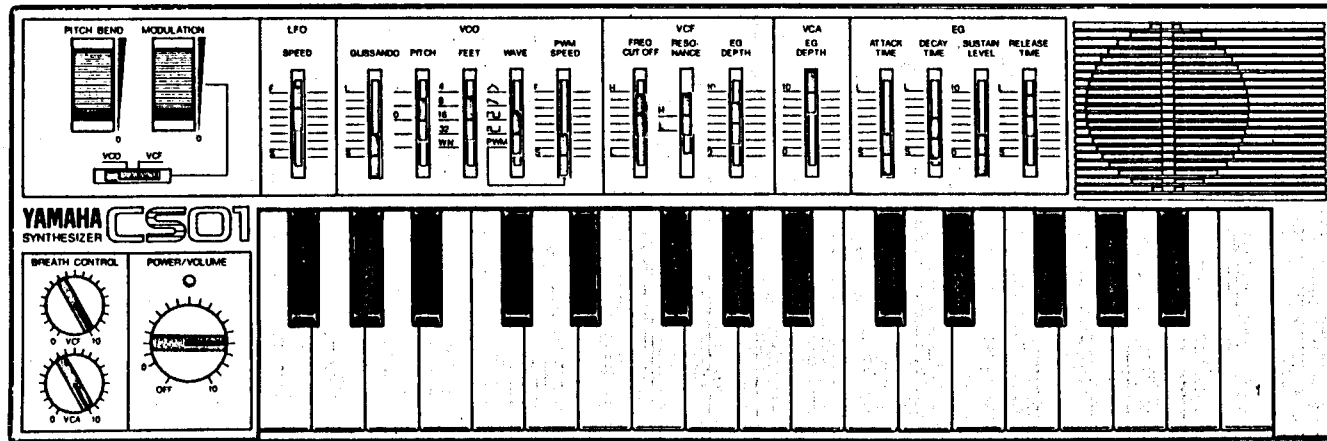

- * Set FEET to 32 rather than 16 for a slightly different sound.
- * Some fun sounds can be created by modulating the VCF.
- * Add tonguing accents with the Breath Controller.

SOLO LEAD SYNTHESIZER

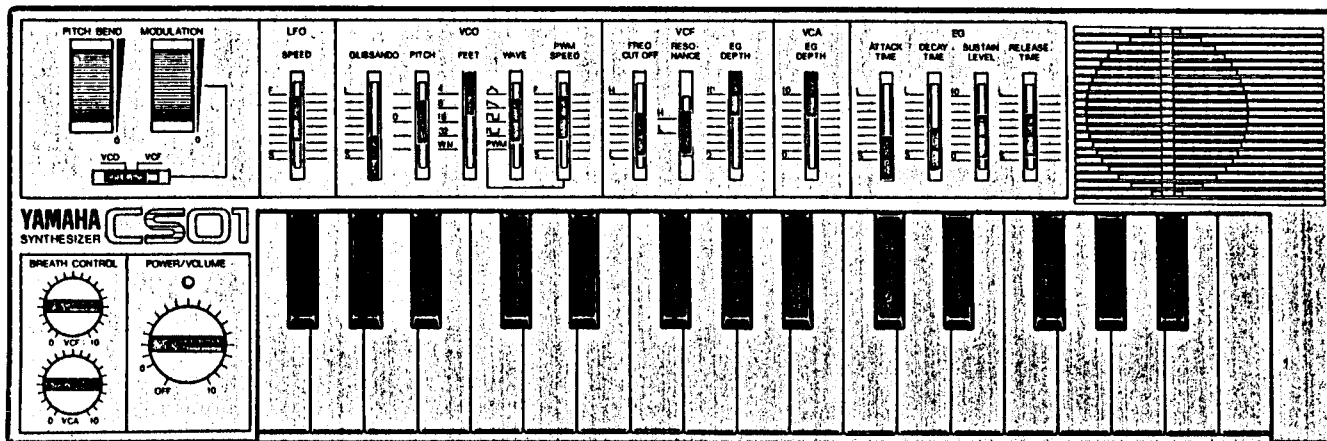

- * VCO modulation should be carefully applied.
- * Try setting WAVE to \sqcup or PWM.
- * The Breath Controller can be used for envelope control to provide broader expressive capability.

SYNTHESIZER BASS

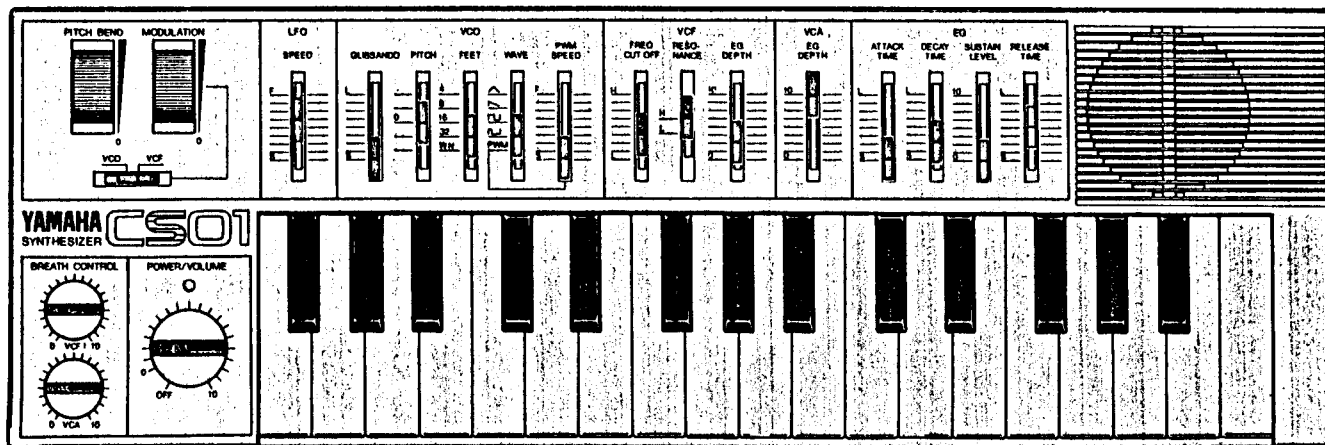

- * This is a unique electric bass sound.
- * Modulating the VCF creates a different sound.
- * Try adding accent with the Breath Controller.

SOUND MEMO

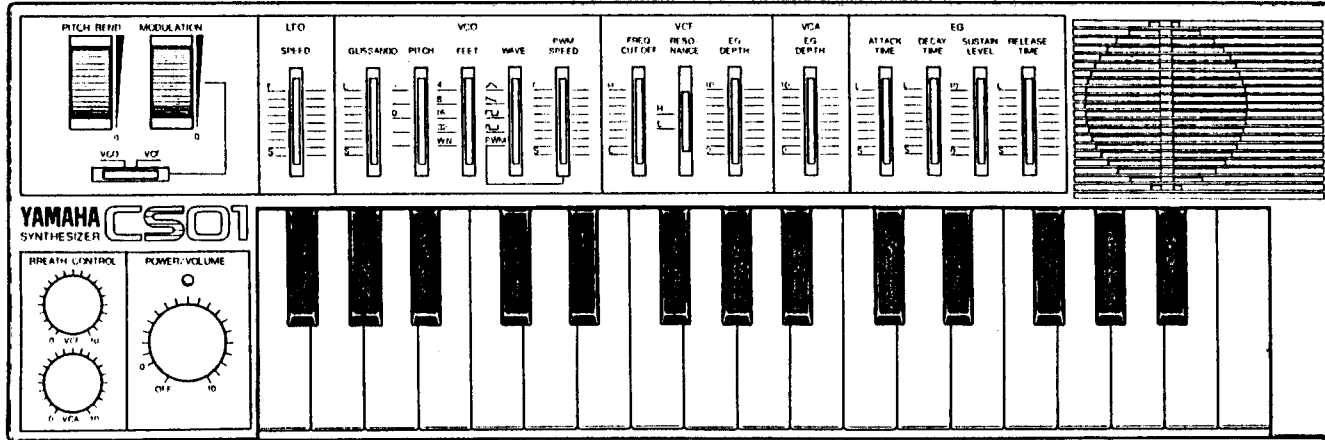

Use these blank charts to start your own sound library.

DATE: /

.....

.....

.....

.....

SOUND MEMO

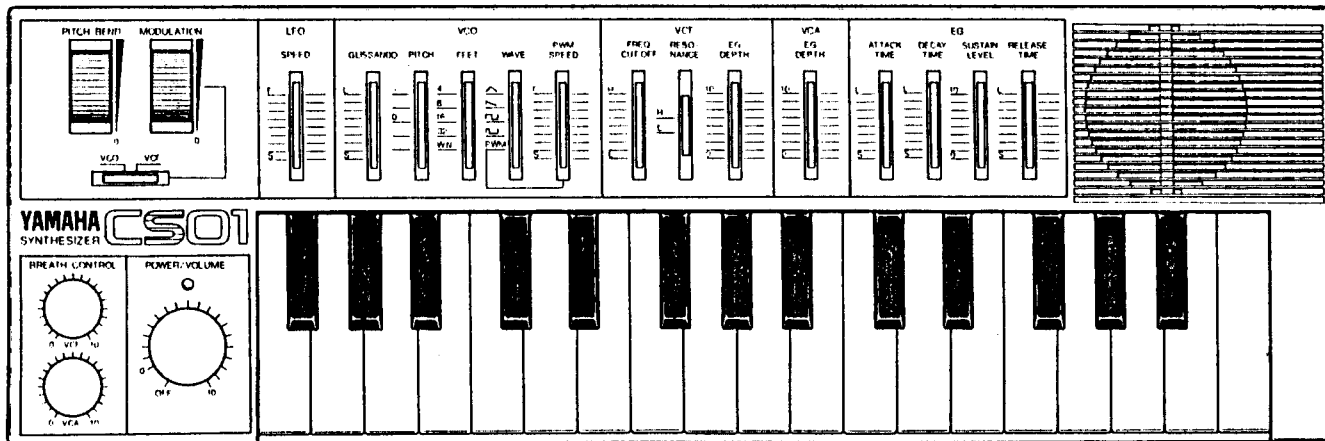

Use these blank charts to start your own sound library.

DATE: /

.....

.....

.....

.....

SOUND MEMO

The diagram shows the control panel of a Yamaha CS01 synthesizer. It includes the following sections:

- Pitch Bend / Modulation:** Two vertical sliders with 'PB' and 'MOD' labels.
- LFO:** A vertical slider labeled 'SPEED'.
- VCO:** A section with sliders for 'GLISSANDO', 'PITCH', 'FINE', 'WAVE', and 'PWM SPEED'. The 'WAVE' slider has a sawtooth waveform icon.
- VCF:** A section with sliders for 'FREQ CUT OFF', 'RESO MAINT', and 'EQ DEPTH'.
- VCA:** A vertical slider labeled 'EG DEPTH'.
- EG (Envelope Generator):** Four vertical sliders for 'ATTACK TIME', 'DECAY TIME', 'SUSTAIN LEVEL', and 'RELEASE TIME'.
- Keyboard:** A representation of the keyboard with 12 keys.
- Knobs:** Two circular knobs labeled 'BREATH CONTROL' and 'POWER/VOLUME'.
- Speaker Grille:** A rectangular area on the right with horizontal lines representing a speaker grille.

YAMAHA CS01 SYNTHESIZER

DATE: /

.....

.....

.....

.....

SOUND MEMO

PITCH BEND **MODULATION**

LFO **VCO** **VCF** **VCA** **EG**

SPEED **GLISSANDO** **PITCH** **FREQ** **WAVE** **FWA SPEED** **FREQ** **RESONANCE** **EQ DEPTH** **EG DEPTH** **ATTACK TIME** **DECAY TIME** **SUSTAIN LEVEL** **RELEASE TIME**

YAMAHA **CS01**
SYNTHESIZER

REPEAT RATE **POWER VOLUME**

DATE: /

.....

.....

.....

.....

This series of Yamaha combo Keyboards use frequencies that appear in the radio frequency range and if installed in the immediate proximity of some types of audio or video devices (within three meters), interference may occur.

This series of Yamaha Combo Keyboards has been type tested and found to comply with the specifications set for a class B computing device in accordance with those specifications listed in subpart J of part 15 of the FCC rules. These rules are designed to provide a reasonable measure of protection against such interference. However, this does not guarantee that interference will not occur. If your Combo Keyboards should be suspected of causing interference with other electronic devices, verification can be made by turning your Combo Keyboards off and on. If the interference continues when your Keyboard is off, the Keyboard is not the source of the interference. If your Keyboard does appear to be the source of the interference, you should try to correct the situation by using one or more of the following measures:

Relocate either the Keyboard or the electronic device that is being affected by the interference.

Utilize power outlets for the Combo Keyboard and the device being affected that are on different branch (circuit breaker or fuse) circuits, or install a/c line filters.

In the case of radio – T.V. interference, relocate the antenna or, if the antenna lead-in is 300 ohm ribbon lead, change the lead-in to co-axial type cable.

If these corrective measures do not produce satisfactory results, please contact your franchised Yamaha Combo Keyboard dealer for suggestions and/or corrective measures. If you can not locate a franchised Yamaha Combo Keyboard dealer in your general area contact the Combo Service Department, Yamaha International, 6600 Orangethorpe Ave., Buena Park, CA 90620.

If for any reason, you should need additional information relating to radio or T.V. interference, you may find a booklet prepared by the Federal Communications Commission helpful: "How to Identify and Resolve Radio – T.V. Interference Problems". This booklet is available from the U.S. Government printing office, Washington D.C. 20402 – Stock #004-000-00345.

SERVICE

The CS01 are supported by Yamaha's worldwide network of factory trained and qualified dealer service personnel. In the event of a problem, contact your nearest Yamaha dealer.

SINCE 1887



YAMAHA

NIPPON GAKKI CO., LTD. HAMAMATSU, JAPAN