

TOSHIBA LED DISPLAY

**TLG346S, TLG347S, TLS346S  
TLS347S, TLR346S, TLR347S**

- 10mm (0.4") Character Height Numerical Display.
- Application : Numerical Readout for Instrument and Consumer Product.
- Luminous Intensity Ranking Performed Uniform Display.
- Available Both Types of Package Colors.
  - TL□xxxS : Gray Color Coated Only on Surface.
  - TL□xxxT : Black Color Coated Only on Surface.

PRODUCT LINE UP

TLG346S / TLG347S	GaP GREEN
TLS346S / TLS347S	GaAsP RED
TLR346S / TLR347S	GaP RED

TYPE No. vs FULLY DISPLAY FONT

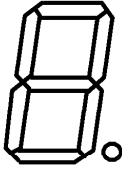
COMMON CATHODE	COMMON ANODE	FULLY DISPLAY FONT
TLG346S TLS346S TLR346S	TLG347S TLS347S TLR347S	

MAXIMUM RATINGS (Ta = 25°C)

CHARACTERISTIC	SYMBOL	RATING	UNIT
DC Forward Current / seg.	I <sub>F</sub> (DC) / seg	20	mA
Pulse Forward Current / seg. (Note)	I <sub>FP</sub> / seg	110	mA
Reverse Voltage / seg.	V <sub>R</sub>	6	V
Operating Temperature Range	T <sub>opr</sub>	-40~85	°C
Storage Temperature Range	T <sub>stg</sub>	-40~85	°C

Note : Pulse Width = 1ms, Duty Ratio = 1 / 10

961001EAC2

- TOSHIBA is continually working to improve the quality and the reliability of its products. Nevertheless, semiconductor devices in general can malfunction or fail due to their inherent electrical sensitivity and vulnerability to physical stress. It is the responsibility of the buyer, when utilizing TOSHIBA products, to observe standards of safety, and to avoid situations in which a malfunction or failure of a TOSHIBA product could cause loss of human life, bodily injury or damage to property. In developing your designs, please ensure that TOSHIBA products are used within specified operating ranges as set forth in the most recent products specifications. Also, please keep in mind the precautions and conditions set forth in the TOSHIBA Semiconductor Reliability Handbook.
- Gallium arsenide (GaAs) is a substance used in the products described in this document. GaAs dust and fumes are toxic. Do not break, cut or pulverize the product, or use chemicals to dissolve them. When disposing of the products, follow the appropriate regulations. Do not dispose of the products with other industrial waste or with domestic garbage.
- The information contained herein is presented only as a guide for the applications of our products. No responsibility is assumed by TOSHIBA CORPORATION for any infringements of intellectual property or other rights of the third parties which may result from its use. No license is granted by implication or otherwise under any intellectual property or other rights of TOSHIBA CORPORATION or others.
- The information contained herein is subject to change without notice.

ELECTRICAL-OPTICAL CHARACTERISTICS (Ta = 25°C)

TYPE No.	EMITTING WAVE LENGTH			LUMINOUS INTENSITY I <sub>V</sub> /seg			FORWARD VOLTAGE V <sub>F</sub> /seg				REVERSE CURRENT I <sub>R</sub> /seg		LUMINOUS INTENSITY MATCHING RATIO I <sub>V-M</sub>	
	λ <sub>p</sub>	Δλ	I <sub>F</sub> /seg	Min.	Typ.	I <sub>F</sub> /seg	Min.	Typ.	Max.	I <sub>F</sub> /seg	Max.	V <sub>R</sub> /seg	Max.	I <sub>F</sub> /seg
TLG Series	565	30	10	0.54	1.22	10	1.7	2.0	2.5	10	5	6	2.3	10
TLS Series	635	40		0.72	1.64		1.7	1.9	2.5					
TLR Series	700	100		0.23	0.52	5	1.4	2.0	2.5					
UNIT	nm		mA	mcd		mA	V			mA	μA	V	—	mA

PRECAUTION

Please be careful of the following.

- Soldering temperature should be less than 260°C for 3 seconds at 2.0mm from the seating plane.

$I_V / \text{seg} - I_F$

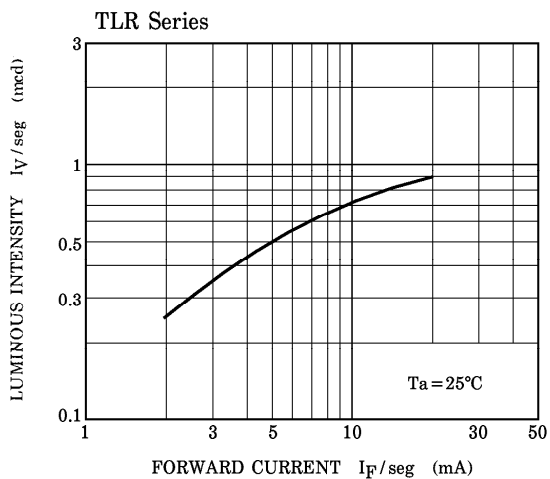
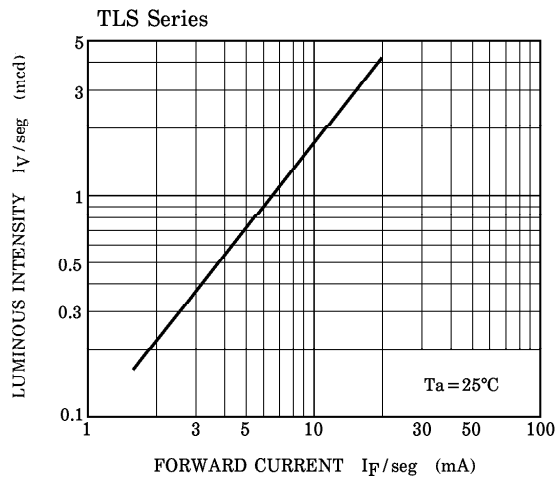
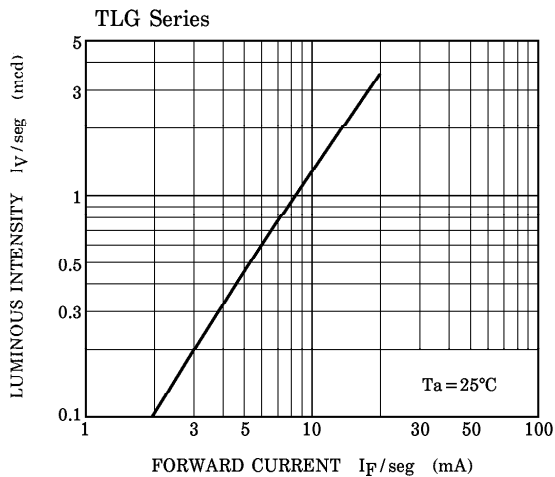

$I_V / \text{seg} - D_R$

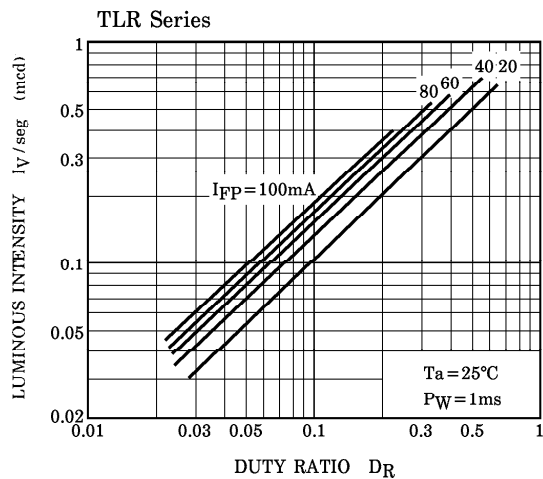
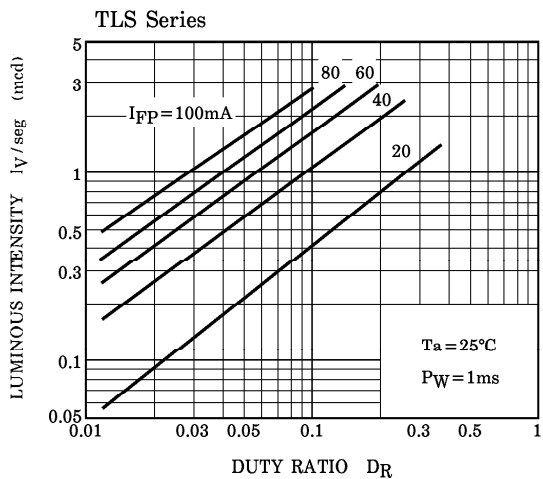
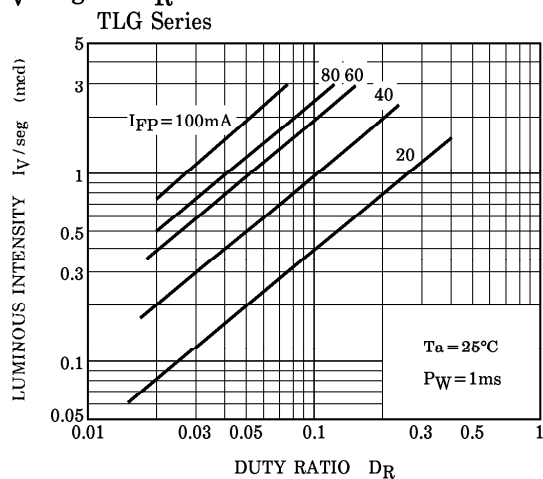

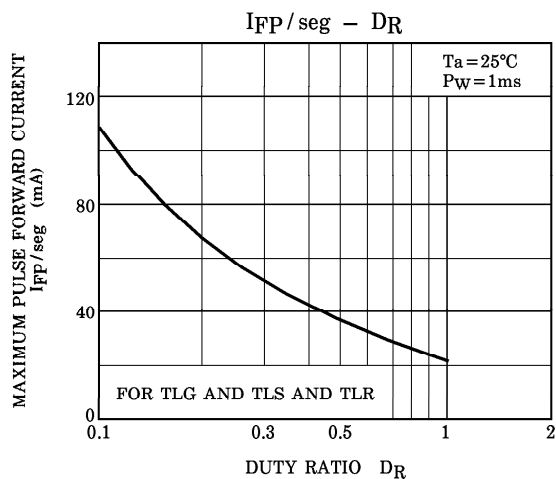
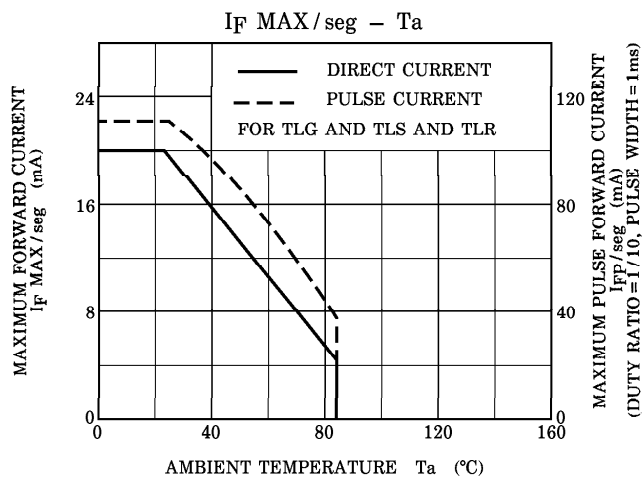
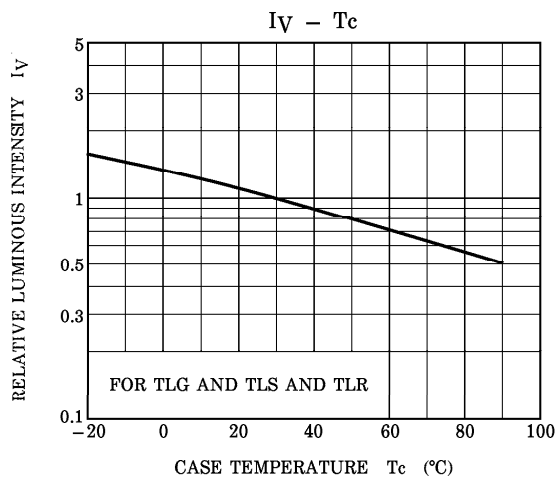
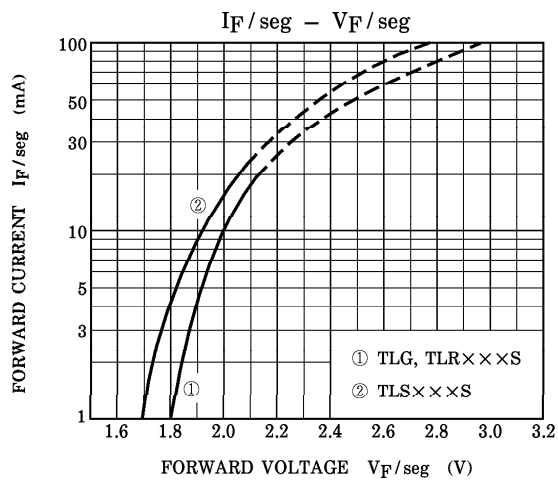

OUTLINE DIMENSIONS

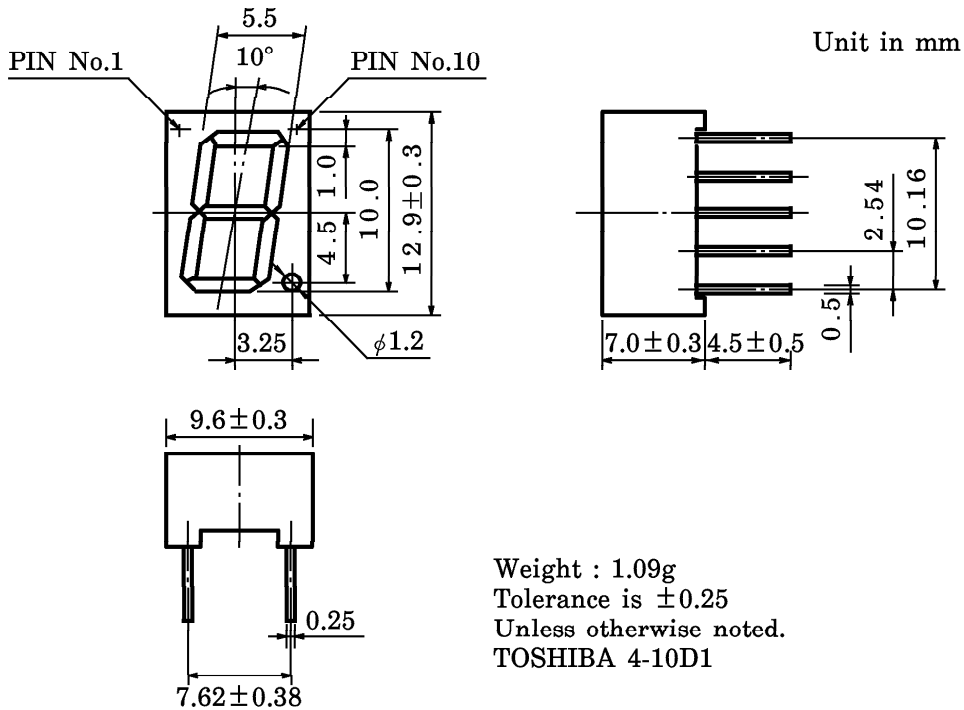

PIN CONNECTION

346S Series		347S Series	
PIN No.	CONNECTION	PIN No.	CONNECTION
1	Common Cathode	1	Common Anode
2	Anode F	2	Cathode F
3	Anode G	3	Cathode G
4	Anode E	4	Cathode E
5	Anode D	5	Cathode D
6	Common Cathode	6	Common Anode
7	Anode Dp (Right Hand)	7	Cathode Dp (Right Hand)
8	Anode C	8	Cathode C
9	Anode B	9	Cathode B
10	Anode A	10	Cathode A