

SHARP®

香港電器安全規格
(國際電工委員會規格適合)

LC-22D1H LC-26D1H LC-32D1H

液晶彩色電視機
LCD COLOUR TELEVISION

使用說明書
OPERATION MANUAL



FULL HD 1080P
(LC-32D1H Only)

DOLBY
DIGITAL

HDMI
HIGH-DEFINITION MULTIMEDIA INTERFACE

中文



ENGLISH

內容

安全及警告.....	2 – 3
介紹.....	4
安裝說明.....	5 – 8
遙控器.....	9 – 10
選項表操作.....	11 – 14
常見問題及解決方法.....	15
輪廓圖.....	16
規格.....	19

關於安全的重要注意事項

- 1、仔細閱讀安全注意事項。
- 2、保存好此注意事項。
- 3、留意所有警告。
- 4、嚴格執行安全注意事項。
- 5、請勿在靠近水的地方使用此機器。
- 6、只能用乾抹布拭擦機器。
- 7、不要堵塞任何散熱孔，按照注意事項安裝。
- 8、請勿在靠近熱源的地方使用機器，比如發熱器，電熱器，火爐或者其他可以產生熱量的東西（包括擴音器在內）。
- 9、請勿破壞電源插頭。如果隨機的插頭不適合您的插座，請向電工要求更換合適的插座。
- 10、請勿踩踏電源線，特別注意不要擠壓從電視機內延伸出來的插頭，插座。
- 11、只能使用製造商指定的附件。
- 12、雷電天氣或者長時間不使用時，請注意拔掉插頭。
- 13、請找合格的維修人員維修機器。只要機器有損壞，就需進行維修，比如電源線或者電源插頭的損壞，機器內部有液體進入，或者機器遭重物碰撞，遭雨淋或者受潮，機器運行不正常，或者掉落。
- 14、主插頭用作斷電設備，此設備需時常保持正常。
- 15、散熱孔不應被任何東西覆蓋，比如報紙，抹布，窗簾等。
- 16、任何火源，比如燃燒的蠟燭，都不能放在機器上。
- 17、注意保護環境，不要隨意丟棄廢棄的電池。
- 18、在適合的氣候中使用機器。
- 19、機器不應暴露在滴水或者有水花的地方。任何含有液體的物品，比如花瓶，都不能放在機器上。

	注意 有觸電危險，請勿打開！	
警告		
為了防止觸電，請勿拆除後殼，內部並沒有用戶可自行維修的部件，請聯絡合格的維修人員進行維修。		

 此標誌說明機器內含高壓部件，小心觸電。

 此標誌說明電視機附件中含有重要的操作以及維護說明。

警告： 為了防止火災和觸電，請勿將此機器置於雨中或潮濕的地方。



此標誌說明此產品在高壓以及用戶可接觸的物件中含有雙絕緣部件。只能使用相同的更換件。

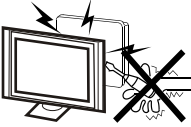

警告

機器內含高壓部分。請勿打開後殼。如需要維修，請聯絡合格的維修人員。

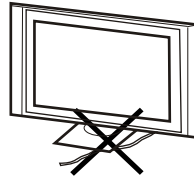

注意

請勿將電源線繞在機器底部。

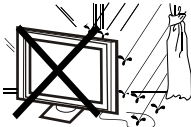

警告

為了防止火災或觸電，請勿將機器置於雨中或潮濕處。

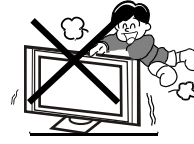

注意

請勿站在，靠在或者撞擊機器及其底座。應特別注意兒童。如果電視打翻，可能造成嚴重傷害。

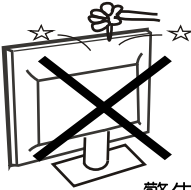

警告

請勿將任何物件置於或放進機器內部、散熱孔或其他開口處。不要將液體濺到機器上。



注意

不要將機器放在不穩定的凳子，底座，支架或桌子上。如果機器打翻，可能對人或者電視造成很大的損傷。

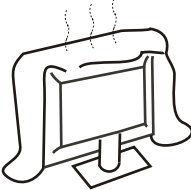

注意

請勿堵塞後殼上的任何散熱孔。良好的通風是防止電器故障的關鍵。



注意

當電視長時間不使用時，建議將電源線拔掉。

非常感謝您購買我們的電視。爲了讓你安全無憂的使用此產品，請仔細閱讀此說明書。請小心保存此說明書，以便隨時參考。

注意

請勿擅自改動電視內部的部件，或者其他說明書中沒有提到的控件。所有的液晶電視都含有高壓部件。在清潔機器之前，請先拔掉電源線，然後用乾軟布拭擦電視。在雷電天氣時，請拔掉電源線及外接天線，以免對電視造成損壞。只有合格的電視維修人員才能維修此機器。

安裝說明

將電視放在室內燈光不能直射屏幕的地方。

在暗室或者有反光的地方看電視會造成眼睛疲勞。柔和非直射的光線下看電視最適合。

在電視和牆壁之間應該留有空間以便散熱。

應將電視放在遠離熱源的地方，以免對機器或者部件造成損壞。當使用機器時，請勿堵塞散熱孔。

商標

- 由Dolby Laboratories授權製造。“杜比”、“Dolby”與雙D標誌是Dolby Laboratories的商標。

- “HDMI”，HDMI 標誌和“High-Definition Multimedia Interface”（高清晰度多媒體接口）是HDMI特許LLC的商標或註冊商標。

主要特點

- ① 可作爲電視，播放終端和個人電腦。
- ② 高亮度，可視角度大
- ③ HDMI接口
- ④ NICAM

主要參數

型號	LC-22D1H	LC-26D1H	LC-32D1H
模擬電視制式	PAL-B/G、I、D/K、SECAM-B/G、D/K NTSC-MN		
視頻信號制式	PAL/NTSC/SECAM		
電源電壓	交流 110V-240V 50/60Hz		
耗電量（備用時）	54 瓦 (0.6 瓦)	71 瓦 (0.6 瓦)	122 瓦 (0.6 瓦)
音頻輸出功率	2 x 3 瓦	2 x 3 瓦	2 x 7.5 瓦
輸入端子	USB x 1		
	VGA x 1, 音頻 x 1 (與 HDMI 共用) (ø3.5 毫米插孔)		
	HDMI x 2		
	視頻 x 1	視頻 x 2	
	色差 x 1		
	音頻 x 1	音頻 x 2	
輸出端子	天線 x 1 (UHF/VHF/75 歐姆類型)		
	視頻 x 1, 音頻 x 1		

前面板

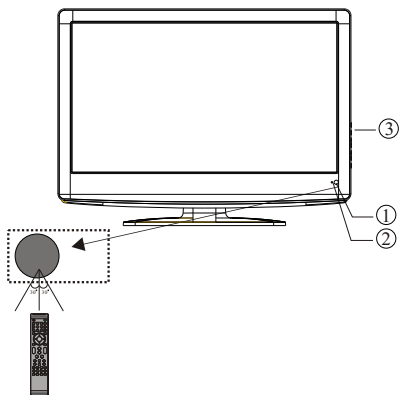

- 1: 遙控器感應器
- 2: LED指示燈
綠色 ● 開機
紅色 ● 待機
- 3: 控制面板

側面控制面板

LC-22D1H

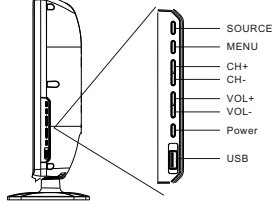

LC-26D1H / LC-32D1H

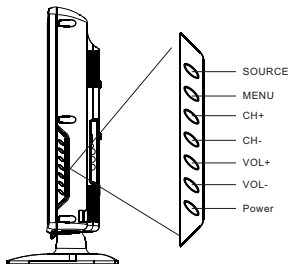

- 1、SOURCE 按此鍵顯示輸入源選項表。
- 2、MENU 按此鍵顯示設置選項表
- 3、CH+/CH- 在TV狀態下，按CH+/CH-，轉換頻道。在MENU模式下，按CH+/CH-，選擇選項表內項目。在備用狀態下，可以啟動電視。
- 4、VOL+/VOL- 按此鍵，調節音量大小。在MENU模式下，按此鍵，調節已選擇的項目。
- 5、POWER 電源開關按鈕。
- 6、USB插口。

背面端子插座

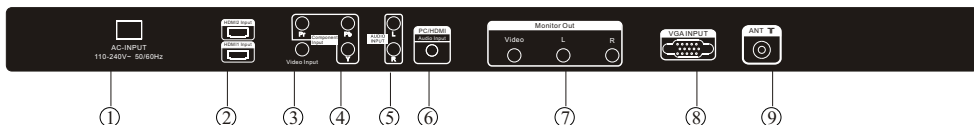

從左至右，所有的輸入端子分別是：

- 1: AC輸入 2: HDMI 3: 視頻 4: 色差 5: 音頻（視頻端子及色差端子共用） 6: 電腦音頻（與HDMI端子共用） 7: 顯示器輸出 8: 電腦輸入 9: 天線

側面端子插座

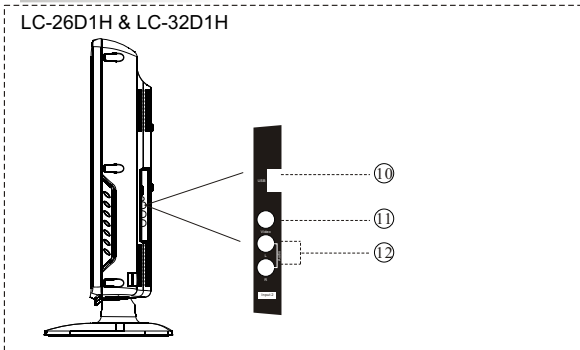

- 10: USB插口
- 11: 視頻輸入 (視頻2)
- 13: 音頻輸入

天線

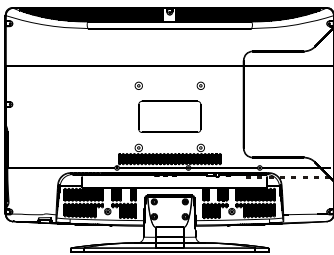

← 室外電視天線

← 室內天線端子
(75歐姆類型)

注意：
天線連接線：IEC (圓型連接線)
輸入阻抗：75歐姆不平衡輸入

如何連接到電腦

步驟：

確認電視和電腦都已經設置為開機。

- 1、連接VGA以及音頻線。
- 2、連接電源線。
- 3、打開電視，選擇電腦模式。
- 4、打開電腦。

這個順序非常重要。

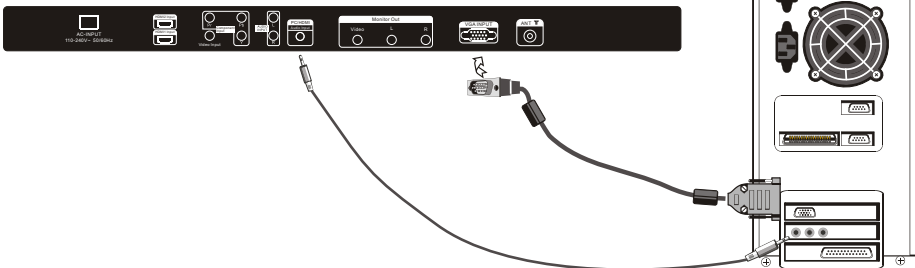

電腦兼容列表

	解像度	垂直頻率(Hz)	水平頻率(KHz)
1	640x480	60	31.47
2	800x600	60	37.88
3	1024x768	60	48.36
4	1360x768	60	47.7
5	1280x1024	60	63.98
6	1440x900	60	55.93
7	1920x1080 (只適用於 LC-32D1H)	60	66.64

HDMI 兼容信號格式

480i, 480p, 576i, 576p, 720p/50Hz, 720p/60Hz,
1080i/50Hz, 1080i/60Hz, 1080p/24Hz, 1080p/50Hz, 1080p/60Hz.

連接外部設備

此電視機設有兩組AV（LC-22D1H只設一組）。一組色差輸入端子連接錄影機，DVD影碟機以及其他視頻設備。連接時，請參考所連接的視頻設備的說明書。

請參照以下說明使用背板輸入端子。

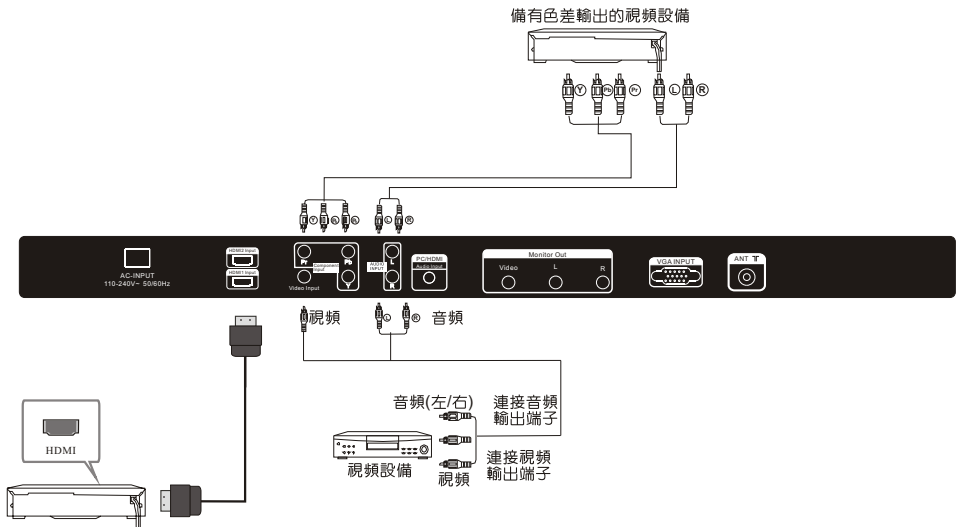

這些端子可以連接以下設備：錄影機，多碟式播放機，DVD影碟機，攝錄機，遊戲機或立體聲音響設備等。

色差端子可以兼容以下視頻格式：480i, 480p, 576i, 576p, 720p/50Hz, 720p/60Hz, 1080i/50Hz, 1080i/60Hz, 1080p/24Hz, 1080p/50Hz, 1080p/60Hz。

- 注意：
- 1、視頻和色差端子共用音頻輸入端子。
 - 2、在DVI模式下HDMI與電腦共用音頻輸入端子。

遙控器

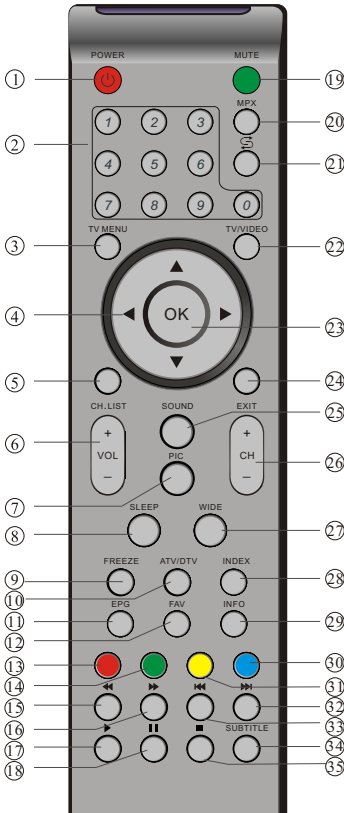

- 1: POWER**
打開電視或切換至待機模式
- 2: NUMERIC KEY**
選擇頻道
- 3: TV MENU**
顯示設置選項表(第11頁)
- 4: CURSOR**
在選項表內移動
- 5: CH LIST**
顯示頻道列表
- 6: VOL +/-**
調節音量
- 7: PIC**
改變圖像模式
- 8: SLEEP**
定時關機
- 9: FREEZE**
使活動影像靜止
- 10: ATV/DTV**
在ATV模擬電視和DTV數碼電視之間切換
- 11: EPG**
顯示電子節目指南畫面(第14頁)
- 12: FAV**
在ATV模擬電視或DTV數碼電視模式下, 直接切換至用戶喜歡的頻道列表(第12頁)
- 19: MUTE**
靜音或恢復音量
- 20: MPX**
選擇多重聲音模式
- 21: FLASHBACK (⏮)**
退回之前觀看的頻道。
- 22: TV/VIDEO**
選擇輸入源
- 23: OK**
確認選擇
- 24: EXIT**
返回上一個選項表或退出選項表
- 25: SOUND**
切換聲音模式
- 26: CH+/CH-**
上下選擇頻道
- 27: WIDE**
切換寬屏幕影像模式
- 28: INDEX**
在DTV數碼電視模式下電子節目指南列表中選擇時間(TIME)或者頻道(Channel)
- 29: INFO**
在DTV數碼電視模式下顯示當前觀看節目的信息以及將要播放的節目信息
- 34: SUBTITLE**
DTV數碼電視模式下, 切換字幕
- 13,14,30,31: 彩色按鍵**
彩色按鍵用於選項表中的特定操作(請參閱第12及第14頁)

將電池裝入遙控器中

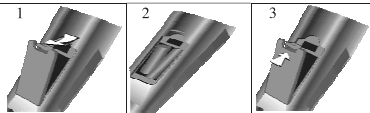

- 1、將電池蓋打開
- 2、將2個1.5V AAA電池裝入, 電池極性一定要與遙控器極性標誌對應。
- 3、裝上遙控器蓋子。當電視機出現以下症狀時, 請更換遙控器電池: 操作不穩定或者錯誤; 或遙控器操作不靈。

備注:

- 1、建議使用鹼性電池。
- 2、當電池的電量耗盡或長期不使用遙控器時, 請將電池取出。

媒體播放鍵

15、◀◀FW: 快退

16、▶▶FF: 快進

17、▶ 媒體播放模式下，進行播放

18、|| 媒體播放模式下，暫停播放

32、▶▶ 下一個

33、◀◀ 上一個

34、■ 媒體播放模式下，停止播放

安裝指導

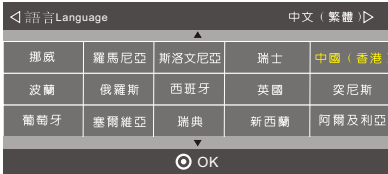

此屏幕顯示只有在機器第一次開啓或者恢復到出廠設置時才會出現。按確認鍵開始自動頻道搜索。搜索完畢，屏幕將顯示第一個數碼電視節目。

1. 頻道選項表

設置選項表的第一項是頻道選項表。（模擬電視或數碼電視模式）



用戶可以搜索頻道及編輯節目

1). 自動搜索

自動搜索所有頻道（用戶可以選擇模擬電視，數碼電視或者數碼+模擬電視）



首先按◀▶選擇數碼電視和模擬電視，然後按OK開始自動搜索。

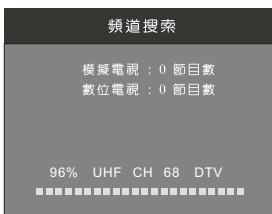

注意：

如果搜索模式是數碼+模擬電視，所有頻道包括數碼電視和模擬電視可以一次性搜索。

在自動調節之後，所有保存的頻道將會消失。

自動調節完成之後，電視會顯示第一個數碼電視頻道的內容。

2). 數碼電視手動搜索

用戶可以選擇一個數碼電視頻道，然後觀看此頻道的節目。

按◀▶切換頻道或者直接輸入頻道號碼。按OK鍵搜索節目。

注意：

“差”，“正常”，“好”表示信號強度。



3). 模擬電視手動搜索

按◀▶選擇開始手動調節的頻道。按▼▲選擇“搜索”或者“微調”。按◀▶確認此操作。



注意

在手動搜索後按紅色按鈕來儲存頻道。

4). 節目編輯

可以刪除, 重新命名, 跳過或編排您喜歡的節目。

● 刪除

按以上的紅色按鈕, 選擇的節目會被刪除。

● 更名 (重新命名)

只能重新命名模擬電視的節目。
將遊標移至需要重新命名的節目, 按綠色鍵來重新命名所選的節目。
按 **▼▲** 鍵來選擇字符, 按 **◀▶** 鍵來移動遊標。
按MENU鍵來退出編輯。按EXIT鍵來退出MENU。
注意: 模擬電視節目的名字只能包含五個字符。

● 跳過

按 **▼▲** 鍵來選擇節目, 按藍色按鈕來跳過此節目。Ⓢ 會出現在節目名稱的右邊。再按藍色按鈕可以取消跳過, 在節目右邊的Ⓢ 即會消失。

● FAV最喜愛的節目

按 **▼▲** 鍵選擇節目。按FAV鍵之後, 屏幕右上方會顯示 **♥**。再按一次FAV, 可以取消喜歡的節目, **♥** 自動消失。
您可以在此表內調節畫面效果, 如對比度, 亮度等等。
按 **▼▲** 來移動遊標, 按 **<OK>** 鍵來調節。

2. 影像調整選項表

設置選項表的第二項是影像調整選項表, 您可以在此表內調節畫面效果, 如對比度, 亮度等等。
按 **▼▲** 來移動遊標, 按 **<OK>** 鍵來調節。



注意:

- 1) 選項表裡有**四種**圖像模式可供選擇: 標準模式, 柔和模式, 用戶自定義模式以及動態模式。可以在用戶模式下調整畫面品質。
- 2) 色調選項只能在NTSC制式下才能調節。
- 3) 有**四種**色溫模式可以選擇: 冷色調, 標準色調, 暖色調和用戶自定義色調。
- 4) 螢幕項目只有在PC模式下可以使用, 在這種模式下可以調整屏幕的水平位置, 垂直位置, 大小和相位。

3. 聲音選項表

MENU裡的第三項是聲音選項表, 可以在這一項裡調整聲音的效果, 環繞聲, 平衡等等。按 **▼▲** 鍵移動遊標, 按OK後可以調節。



注意:

- 1) 此部電視有五種聲音模式: 標準, 音樂, 電影, 運動和用戶。只有在用戶模式下可以調整聲效。
- 2) 自動音效調節: 只有在輸入的音頻信號過大或失真時才會生效。

4. 時間選項表

在此選項裡可以調整電源開關的時間, 待機時間等等。按 **▼▲** 鍵來移動遊標, 按OK鍵後可以調整效果。



注意:

- 1) 如果自動休眠模式啟動後, 電視機會在15分鐘沒有信號輸入後自動關閉電源。
- 2) 在數碼電視頻道搜索完畢後系統會自動按照數碼電視的信號設置時鐘上的時間。

5. 項目設定選項表

設置選項表的第五項是項目設定選項表。可以使用這個選項調整選項表的語言、音頻語言以及字幕語言等等(只限數碼電視模式下)。



注意：如若選擇<恢復工廠設置>將會清除所有存儲的節目。

6. 控管選項表

設置選項表的第六項即是控管選項表。可以使用這項來鎖定系統，設置密碼，頻道鎖以及兒童安全鎖。一旦打開鎖定系統，就不能再搜索節目或者切換頻道。



注意：

- 1) 當<鎖定系統>被選取時，按遙控器上的<OK>鍵後輸入<6666>來啟動該功能。
- 2) 頻道鎖：按<▲>鍵來選擇節目，按<綠色>鍵來鎖定節目。如果想要解除頻道鎖，重複上述1,2項動作即可。
- 3) 兒童安全鎖：按<▼>鍵可以根據4-18的年齡限制級別來鎖定頻道。

若忘記已設定的密碼，可按如下操作來設置新的密碼：

- 1) 進入<鎖定>選項表。
- 2) 使用超級密碼<9527>進入選項表。
- 3) 選擇<設置密碼>
- 4) 輸入舊的密碼<9527>
- 5) 重新輸入新的密碼便可完成設置步驟，新的密碼即時生效。

7. 應用選項表

設置選項表的第七項是應用選項表。

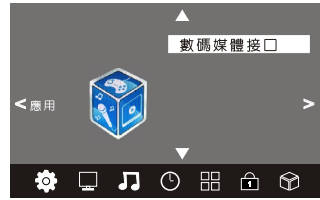

按<OK>鍵進入數碼媒體接口選項表。



在此選項下可以瀏覽儲存在外接USB設備內的圖片及收聽音樂。

按<◀▶>鍵選擇查看的媒體類型。按<OK>鍵進入下一個選項。

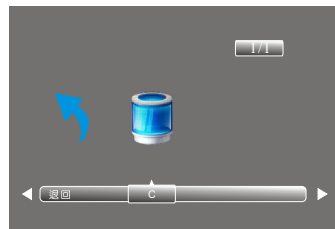

按<◀▶>鍵選擇USB設備內的驅動器，按<OK>鍵顯示儲存媒體檔案及文件夾，或者按<◀▶>選擇<返回>再按<OK>鍵以回到媒體類型選項表。按<◀▶>或<▲>鍵選擇，然後預覽欄會跳出來。



按▶按鈕以全屏模式播放媒體文件，以下的控制平台會顯示出來。



按遙控器上的▶鍵顯示控制平台的其他選項。



當從外接儲存裝置選擇<圖片>選項時，控制平台的選項會和上述不同。按遙控器上的◀▶鍵選擇功能遊標，按<OK>執行此功能。按遙控器上的▼或<EXIT>鍵可離開控制平台。按遙控器上的<INFO>或<OK>鍵來再次顯示控制平台。

注意：
選擇<信息>圖標再按<OK>鍵來顯示信息資料。

此電視支援以下的圖片格式：
JPEG（所有的JPEG格式或以.jpg為尾末的文件）
BMP（尾末為.bmp的文件）
PNG(尾末為.png的文件)
此電視支援以下的音頻格式：
MP3(尾末為.mp3的文件)
WAV(尾末為.wav的文件)

8. 電子節目指南(EPG)

電子節目指南是用於查看在數碼電視頻道所播放的節目。

按遙控器上的EPG鍵進入電子節目指南（EPG），進入後以下的列表會出現：

電子節目指南		時間
08/11月 15:14		
11 本港台	理財博客之投資多面睇(粵)	
12 亞洲高清台	理財博客之投資多面睇(HD)	
13 南方衛視	醒目生活至輕鬆	
14 中天亞洲台	新台灣星光大道	
15 中央4台	電視劇:鄭和下西洋	
16 國際台	教育電視	
81 翡翠台	今日VIP	
82 J2	東京o戲樓大作戰(韓)	
● 訊息 ● 時間表 ● 提醒		
OK		INDEX

1. 訊息

使用◀▶鍵來選擇節目，按INFO鍵可以顯示選擇節目的詳細信息。

2. 時間表

按下黃色按鈕，整個的電視節目提醒日程會出現在屏幕上。按▼▲鍵來選擇日程表內的項目，按●刪除鍵來刪除日程表內的項目。按EPG鍵返回電子節目指南。

時間表 04:55 28th 4月				刪除
時間	日期	節目表	頻道名	

3. 提醒















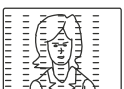

按下藍色按鈕來選擇節目並且設置提醒時間，選定的節目會在設置的時間裡自動播放。

提醒		
◀	11台	▶
15分		
16時		
8月		
16日		
★ 僅一次模式		
OK		返回

按<OK>鍵來儲存設置的提醒時間。

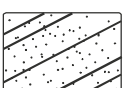
注意：

節目指南列表可以按照<時間>或<頻道>顯示。按遙控器上的<Index>鍵來選擇按<時間>還是<頻道>排列。

故障現象		可能的解決方案
圖像	聲音	
 圖像出現雪花點	 聲音為噪音	天線的位置，方向以及天線是否接觸不良。
 圖像混亂	 聲音正常	天線的位置，方向以及天線是否接觸不良。
 圖像干擾	 聲音為噪音	是否存在電子設備、摩托車或汽車的噪音或燈光以及閃光的干擾。
 圖像正常	 靜音	檢查是否按了遙控器上的靜音鍵或聲頻線沒有接好。
 沒有圖像	 靜音	是否沒有插好電源線。檢查對比度和亮度的設置是否正確；聲音設置是否正確。
 沒有顏色	 聲音正常	檢查色彩設置是否正確。
 畫面被切斷	 聲音正常或微弱	重新搜台。
 沒有顏色	 聲音為噪音	檢查電視制式設置是否正確。

液晶顯示屏是用非常高超的技術製造，能顯示出精細的畫面。由於像素數目極多，偶然也可能會有一些無效的像素出現在屏幕上，看上去是固定不變的藍色、綠色、紅色、黑色或白色的亮點。請注意，這是屬於產品規格範圍之內，並不是故障。

LC-22D1H

單位:毫米

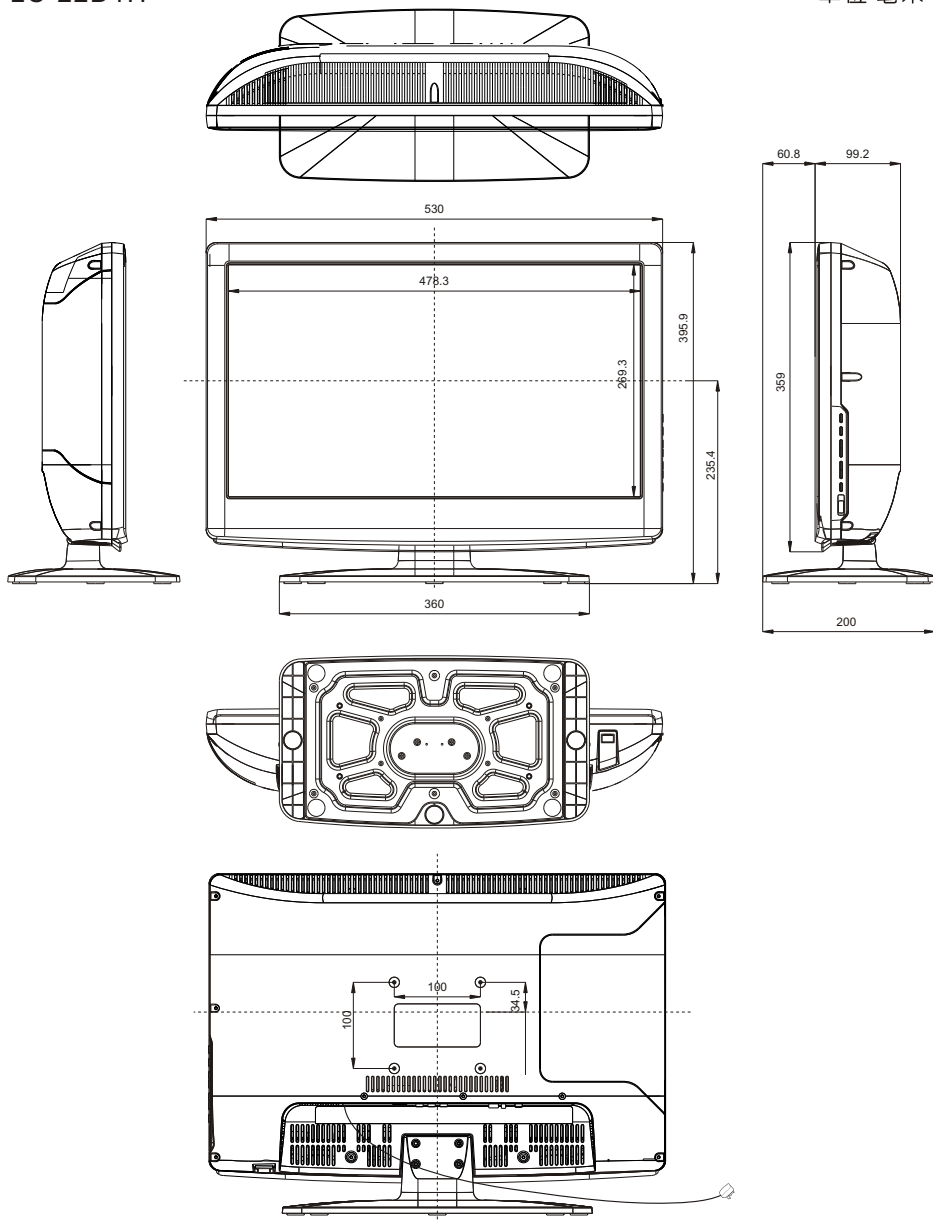

LC-26D1H

單位:毫米

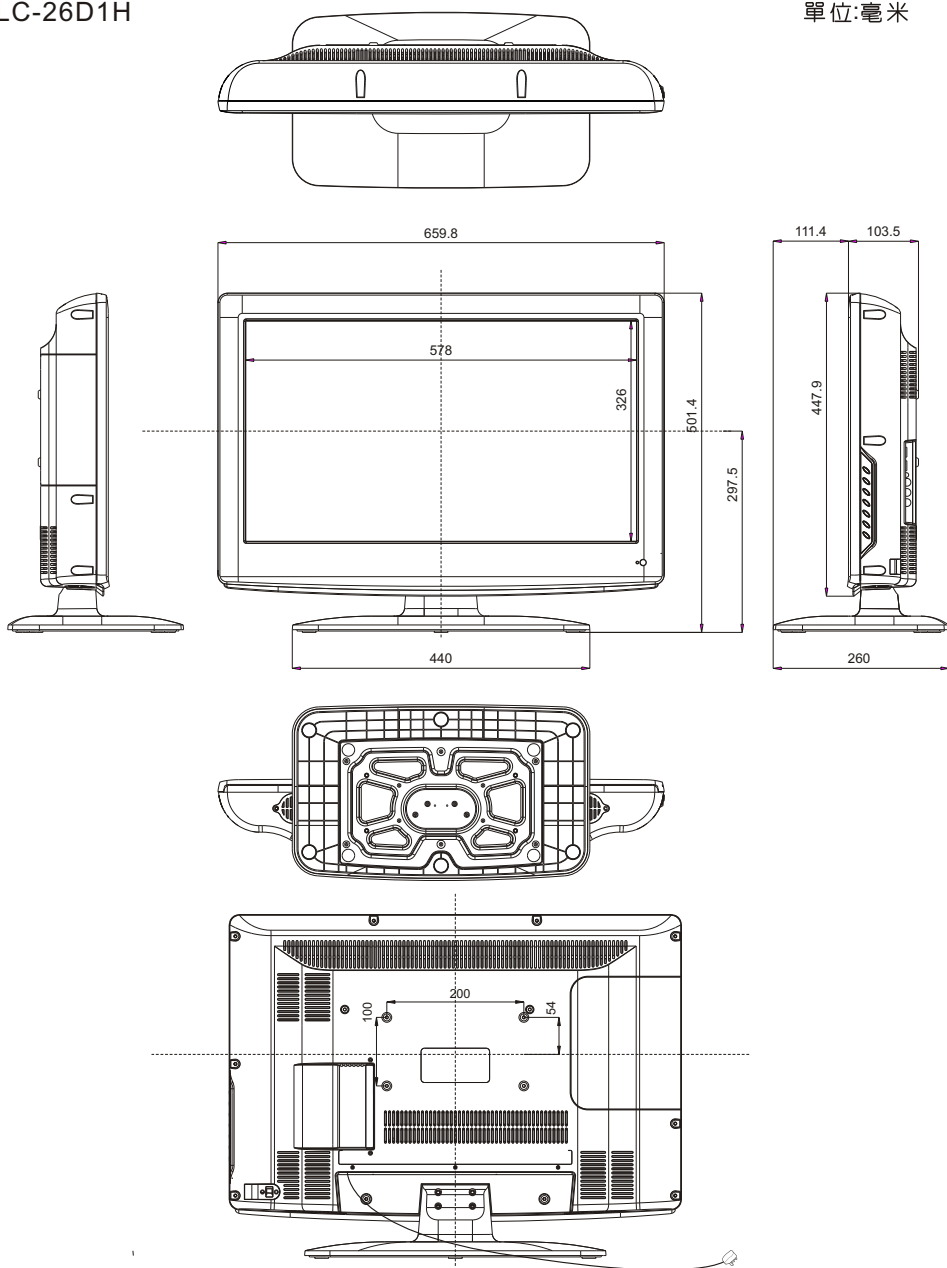

LC-32D1H

單位:毫米

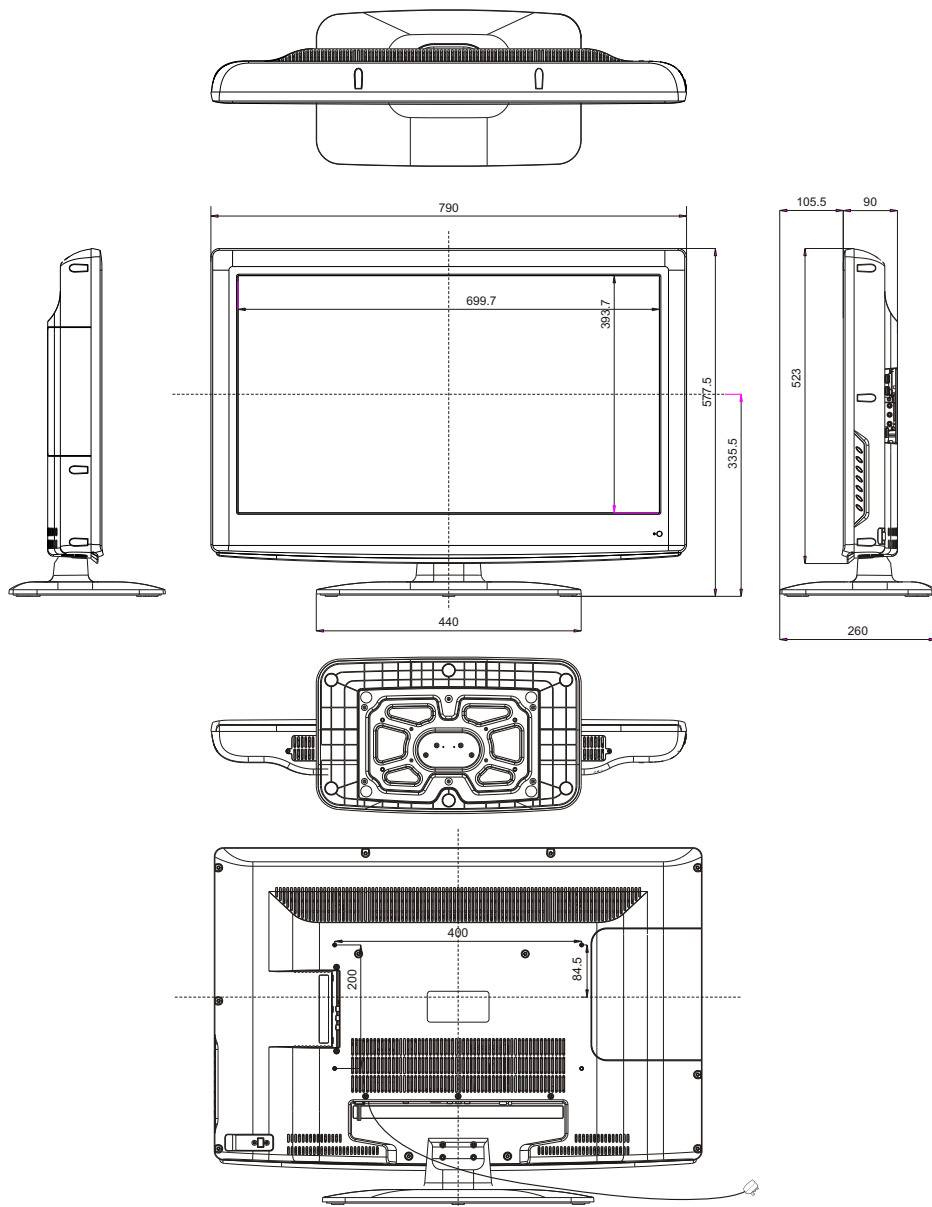

規格：

型號		LC-22D1H	LC-26D1H	LC-32D1H
電視制式	模擬制式	PAL-B/G, I, D/K, SECAM-B/G, D/K, NTSC-MN		
	數碼制式	DMB-T/H		
接收頻段	VHF/UHF	48MHz-858MHz		
數碼地面廣播		470-858MHz		
電視調諧系統		自動預設99個頻道		
立體聲制式		NICAM: B/G, I, D/K, A2 Stereo: B/G		
視頻輸入種類		YPbPr, CVBS, VGA, HDMI		
色差信號格式		480i/p, 576i/p, 720p/50Hz, 720p/60Hz, 1080i/50Hz, 1080i/60Hz, 1080p/24Hz, 1080p/50Hz, 1080p/60Hz		
HDMI信號格式		480i/p, 576i/p, 720p/50Hz, 720p/60Hz, 1080i/50Hz, 1080i/60Hz, 1080p/24Hz, 1080p/50Hz, 1080p/60Hz		
電源要求		110-240V ~ 50/60Hz		
耗電量(備用時)		54瓦 (0.6瓦)	71瓦 (0.6瓦)	122瓦 (0.6瓦)
音頻輸出功率		2 x 3瓦	2 x 3瓦	2 x 7.5瓦
工作溫度		0°C - 40°C		
附件		說明書, 遙控器, 電池 (AAA x 2)		

* 以上規格僅供參考
 偏差的出現可能由於產品的定期升級。
 本公司保留為改進產品而改變設計與規格不需事先通知的權利。



Contents

Safety and warnings.....	2-3
Introduction.....	4
Installation.....	5-8
Remote Control.....	9-10
Operation.....	11-14
Trouble Shooting.....	15
Dimensional Drawings.....	16
Specifications.....	19

IMPORTANT SAFETY INSTRUCTION

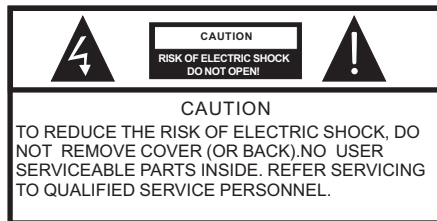
- 1) Read these instructions.
- 2) Keep these instructions.
- 3) Heed all warnings.
- 4) Follow all instructions.
- 5) Do not use this apparatus near water.
- 6) Clean only with dry cloth.
- 7) Do not block any ventilation openings, install in accordance with the instructions.
- 8) Do not install near any heat sources such as radiations, heat registers, stoves, or other apparatus (including amplifiers) that produce heat.
- 9) Do not defeat the safety purpose of the polarized plug. If the provided plug does not fit into your outlet, consult an electrician for replacement of the obsolete outlet.
- 10) Protect the power cord from being stepped on or pinched particularly at plugs, convenience receptacles, and the point where they extend from the apparatus.
- 11) Only use attachments/accessories specified by the manufacturer.
- 12) Unplug this apparatus during lightning storms or when unused for long periods of time.
- 13) Refer all servicing to qualified service personnel. Servicing is required when the apparatus has been damaged in any way, such as power-supply cord or plug is damaged, liquid has been spilled or objects have fallen into the apparatus, the apparatus has been exposed to rain or moisture, does not operate normally, or has been dropped.
- 14) Main plug is used as the disconnect device, the disconnect device shall remain readily operable.
- 15) The ventilation openings should not be covered by items, such as newspapers, table-cloth, curtains, etc.
- 16) No naked flame sources, such as lighted candles, should be placed on the apparatus.
- 17) Attention should be drawn to the environmental aspects of battery disposal.
- 18) The use of apparatus in moderate climate.
- 19) The apparatus shall not be exposed to dripping or splashing and that no objects filled with liquids, such as vases, shall be placed on the apparatus.



-  The symbol indicates that dangerous voltages constituting a risk of electric shock are present within this unit.
-  The symbol indicates that there are important operating and maintenance instructions in the literature accompanying this unit.

WARNING:
To prevent fire or shock hazard, do not expose this appliance to rain or moisture.



This symbol indicates that this product incorporates double insulation between hazardous main voltage and user accessible parts. Only use identical replacement parts. **WARNING:** To reduce the risk of fire or electric shock, do not expose this apparatus to rain.

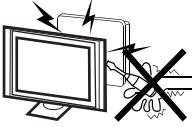

Warning ⚡

High voltages are used in the operation of this television. Do not remove the cabinet back from your set. If maintenance is required, contact qualified service personnel.

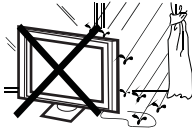

Warning ⚡

To prevent fire or electrical shock hazard, do not expose the television to rain or moisture.



Warning ⚡

Do not drop or push objects into the television cabinet, slots or openings. Never spill any kind of liquid on the television.

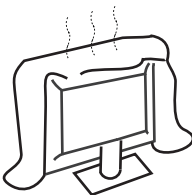

Caution ⚠

Do not block the ventilation holes at the back cover. Adequate ventilation is essential to prevent failure of electrical components.

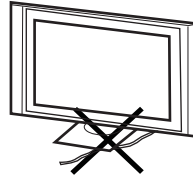

Caution ⚠

Do not trap the power supply cord under the television.

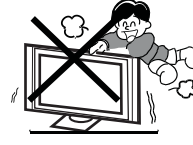

Caution ⚠

Never stand on, lean on, or suddenly push the television or its stand. You should pay special attention to children. Serious injury may result if the television overturns.



Caution ⚠

Do not place your television on an unstable cart, stand, shelf or table. Serious injury to an individual, and damage to the television, may result if the television overturns.



Caution ⚠

When the television is not used for an extended period of time, it is recommended to disconnect the AC power cord from the AC outlet.

Thank you very much for purchasing this television. To enjoy trouble-free operation of your product, please read this manual carefully and keep it handy for easy reference.

CAUTION

Never tamper with any components inside the TV, or any other adjustment controls not mentioned in this manual. All LCD-TVs are high voltage instruments. Unplug the AC cord from the AC outlet before cleaning the product, then wipe the TV with a dry soft cloth. During thunder and lightning, unplug the power cord and antenna cord to prevent damage to your TV. All repairs to this TV should only be performed by qualified TV service personnel.

INSTALLATION

- *Locate the TV in the room where light does not strike the screen directly.
- *Total darkness or a reflection on the picture screen can cause eyestrain. Soft and indirect lighting is recommended for comfortable viewing.
- *Allow enough space between the TV and the wall to permit ventilation.
- *Avoid excessively warm locations to prevent possible damage to the cabinet or premature component failure.
- *Do not cover the ventilation openings when using theTV.

Trademarks

- Manufactured under license from Dolby Laboratories, Dolby and the double-D symbol are trademarks of Dolby Laboratories.
- "HDMI, the HDMI logo and High-Definition Multimedia Interfaces are trademarks or registered trademarks of HDMI Licensing LLC.

Main features

- ① Used as Television, display terminal, PC display ③ HDMI interface
- ② High luminance, wide viewing angle ④ NICAM

Main parameter

Model	LC-22D1H	LC-26D1H	LC-32D1H
TV System	PAL-B/G、I、D/K、SECAM-B/G、D/K NTSC-MN		
Video Signal System	PAL/NTSC/SECAM		
Input Power Voltage	AC 110V-240V 50/60Hz		
Power Consumption(Standby)	54W(0.6W)	71W(0.6W)	122W(0.6W)
Audio Output Power	2 x 3W	2 x 3W	2 x 7.5W
Input Terminals	USB x 1		
	VGA x 1,AUDIO x 1(shared with HDMI)(ø3.5mm jack)		
	HDMI x 2		
	Video x 1	Video x 2	
	Component x1		
	Audio x 1	Audio x 2	
	Antenna x1 (UHF/VHF/75Ω Din type)		
Output Terminals	Video x 1, Audio x 1		

Front Panel

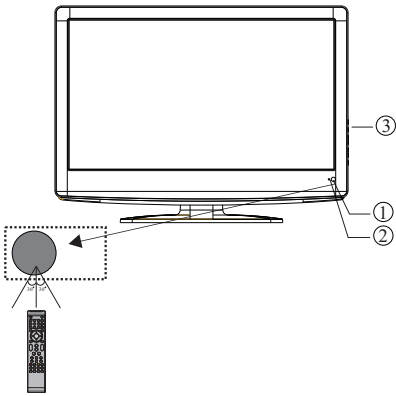

- 1: Remote control sensor
- 2: Indicator LED:
GREEN ● POWER ON
RED ● STANDBY
- 3: Control Panel

Control Panel

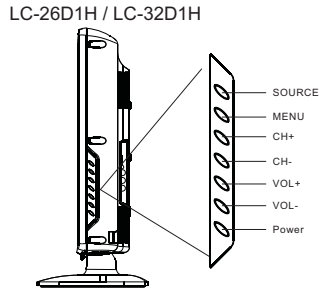
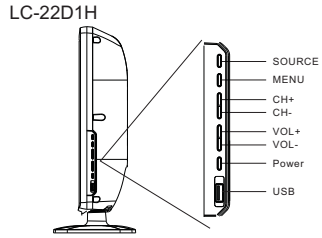

- 1. **SOURCE**
Display the input source menu.
- 2. **MENU**
Display main MENU.
- 3. **CH+/CH-**
In TV mode, press “CH+” or “CH-” to change the channel up and down. In MENU mode, press “CH+” or “CH-” to select items. In standby mode, it can turn on the TV.
- 4. **VOL+/VOL-**
Adjust sound level. In MENU mode, press “VOL+” or “VOL-” to adjust the item that you selected.
- 5. **POWER**
- 6. **USB**

Rear Panel

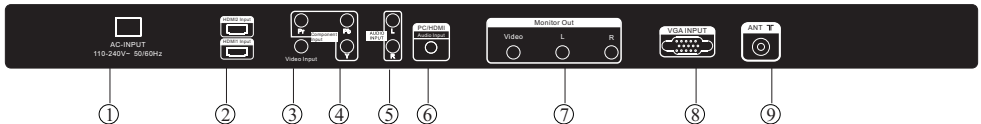

All the input terminals are(from left to right):
 1:AC INPUT, 2:HDMI,3:VIDEO, 4:COMPONENT, 5:AUDIO(Share between video and component terminals),6:PC AUDIO(Share with HDMI terminals), 7:MONITOR OUT, 8:VGA INPUT, 9:ANTENNA

Side Panel

For LC-26D1H & LC-32D1H

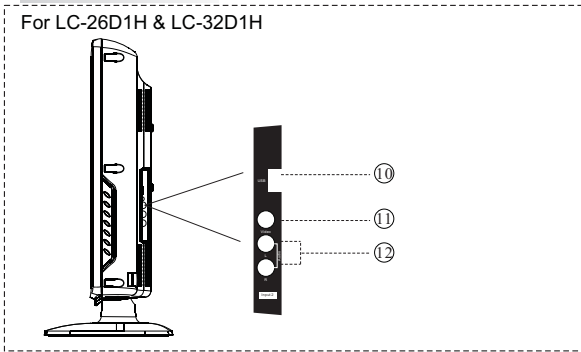

- 10: USB
- 11: VIDEO INPUT (VIDEO 2)
- 12: AUDIO INPUT

ANTENNA

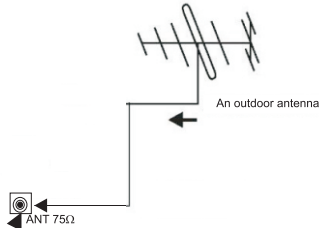
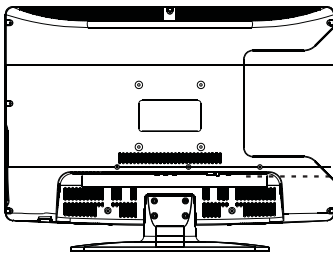

Note:
Aerial connections: IEC (female).
Input impedance: 75 Ω unbalanced.

Connecting a PC

STEPS:

- Be sure both the TV and computer are set to Power off.
1. Connect VGA and audio cable.
 2. Connect the power cord.
 3. Power on the TV, switch to PC mode.
 4. Power on the PC.
- This sequence is very important.

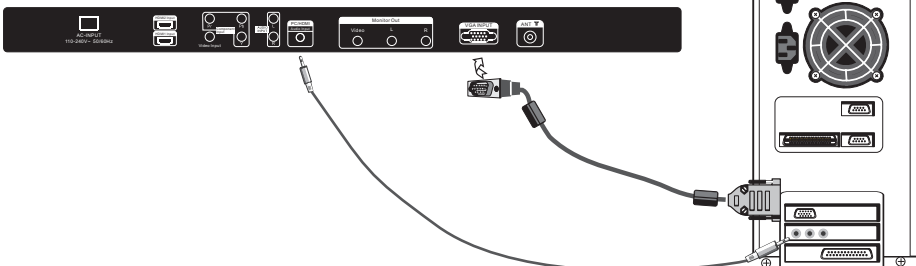

PC Compatibility Chart

	RESOLUTION	V.Freq.(Hz)	H.Freq.(KHz)
1	640x480	60	31.47
2	800x600	60	37.88
3	1024x768	60	48.36
4	1360x768	60	47.7
5	1280x1024	60	63.98
6	1440x900	60	55.93
7	1920x1080 (Only for LC-32D1H)	60	66.64

HDMI Compatible Signal Format

480i, 480p, 576i, 576p, 720p/50Hz, 720p/60Hz,
1080i/50Hz, 1080i/60Hz, 1080p/24Hz, 1080p/50Hz, 1080p/60Hz.

Connecting External Devices

This television provides two group of AV(LC-22D1H provides one group only), one group of component terminals for convenient connection to VCR, DVD or other video equipment. Please refer to the owner's manual of the equipment to be connected as well.

You can use the input terminals on the rear panel as follows.

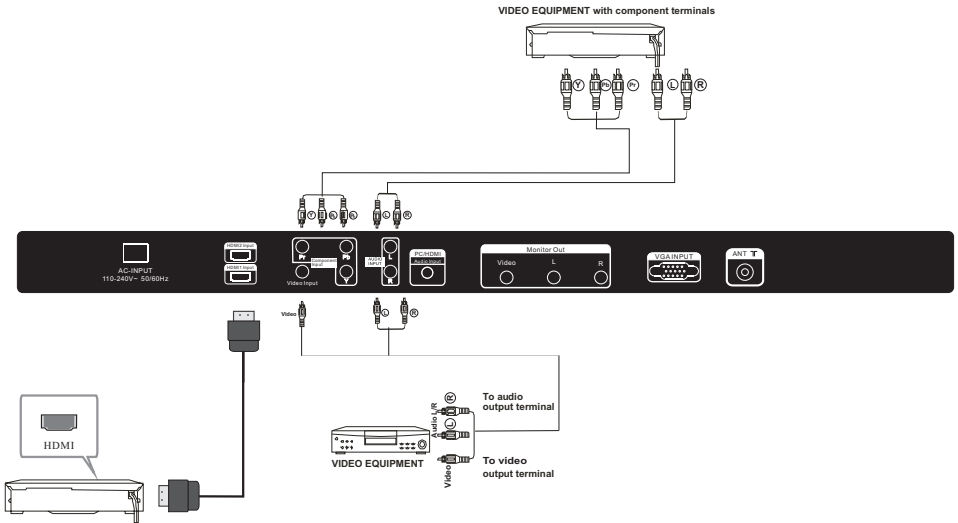

It can be connected to the following equipments: VCR, multi disc player, DVD, camcorder, video game console or stereo system, etc.

Component terminals can support these video formats: 480i, 480p, 576i, 576p, 720p/50Hz, 720p/60Hz, 1080i/50Hz, 1080i/60Hz, 1080p/24Hz, 1080p/50Hz, 1080p/60Hz.

- Note: 1.Video and component terminals share the same audio input terminal.
 2.HDMI in DVI mode share the same audio input terminal with PC.

REMOTE CONTROL

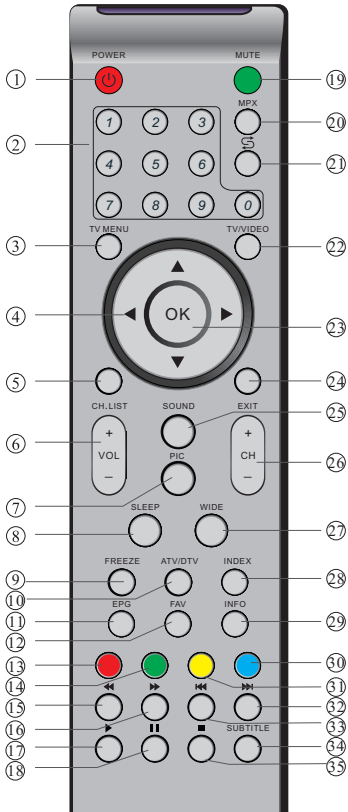

1: POWER

To set the TV to standby or power on.

2: NUMERIC KEY

For direct access to channels.

3: TV MENU

To display TV menu.(Page 11)

4: CURSOR

To move within the menu.

5: CH LIST

To display the channel list.

6: VOL+/-

To adjust sound level.

7: PIC

To switch picture mode.

8: SLEEP

Set timer to turn off the TV.

9: FREEZE

To freeze the picture.

10: ATV/DTV

To switch between ATV and DTV.

11: EPG

To display the Electronic Program Guide Screen. (Page 14)

12: FAV

To access your favourite channels list in ATV or DTV mode.(Page 12)

19: MUTE

To disable or enable the sound output.

20: MPX

To select the available audio language.

21: FLASHBACK (⏮)

To access the previously viewed channel.

22: TV/VIDEO

To select input source.

23: OK

To confirm selection.

24: EXIT

To return to the previous menu or exit menu.

25: SOUND

To switch sound mode.

26: CH+/CH-

To access the next or previous channels.

27: WIDE

To change picture aspect ratio.

28: INDEX

To select "Time" or "Channel" on the EPG table in DTV mode

29: INFO

To display information about the program being viewed and what's on next in DTV mode.

34: SUBTITLE

To switch between different subtitles in DTV mode.

13,14,30,31: COLOR KEY

4 coloured keys are used to access the item on corresponding pages.(Page 12 & 14)

Insert Batteries Into the Remote Control

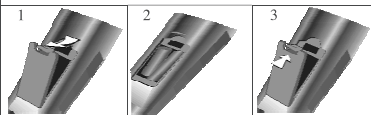

1. Remove the battery cover.
2. Insert 2 × AAA 1.5V batteries, make sure the polarity (+ or -) of the batteries matches the polarity marks inside the unit.
3. Mount the battery cover. Replace with new batteries when the TV set begins to show the following symptoms: Operation is unsteady or erratic. Sometimes the TV set does not function with Remote Control Unit.

Remark:

- 1) Alkaline Battery is recommended.
- 2) Remove batteries when they are exhausted or if the remote control is not to be used for a long period of time.

MEDIA PLAY key:

15: ◀◀ FW:Fast backward.

16: ▶▶ FF:Fast forward.

17: ▶ Play in media play mode.

18: || Pause in media play mode.

32: ▶▶ NEXT

33: ◀◀ PREVIOUS

35: ■ Stop in media play mode.

Installation Guide

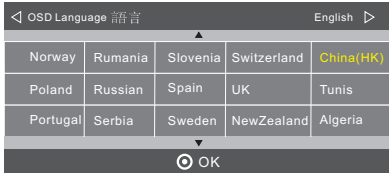

This screen only appear when the TV is first time turn on or reset to factory setting. Press OK key to start auto turning . And after turning, the screen will show the first DTV program.

1.CHANNEL MENU

The first item of the MENU is channel menu(for ATV or DTV only).

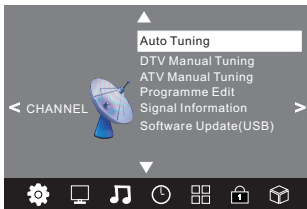

You can search channels and edit programs here.

1).Auto tuning

Search all the channels automatically(you can select ATV, DTV or DTV+ATV)

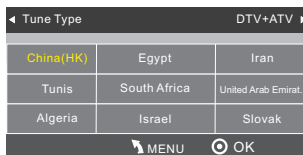

Press ◀▶ to select ATV and DTV at first , then press OK to start auto tuning .

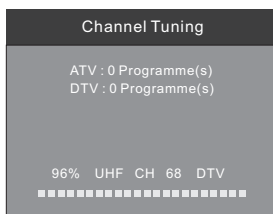

NOTE:

All the channels including ATV and DTV can be tuned at one time,if the Tune Type is DTV+ATV .

All the stored channels will be disappeared after auto tuning .

After auto tuning , the TV will show the contents of the first DTV channel.

2).DTV Manual tuning

You can select a DTV channel, then find the program in this channel.

Press◀▶ to change the channel number or input the channel number. Press OK to search the programs .

NOTE:

Bad, Normal and Good means signal intensity.

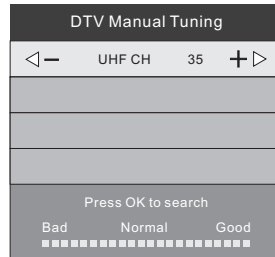

3). ATV Manual tuning

Press ◀▶ to select the channel number for manual tuning. Press ▼▲ to select "search" or "Fine tune" ,confirm the execution by pressing ◀▶ .



NOTE:

Press red button to store the channels after manual tuning .

4). Program edit

You can Delete, Rename, Skip, or assign any programs as your favourite programs.

Delete

Press red button, the highlighted program will be deleted.

Rename

Only can rename ATV programs.

Move the cursor to the program, press green button to rename the program.

Press ▼▲ to choose the character. Press ◀▶ to move the cursor.

Press MENU button to exit edit. Press EXIT to exit the menu.

Note: ATV programs name can only contain 5 characters.

Skip

Press ▼▲ to choose the program, press blue button to skip this program, The Ⓞ will show on the right side of the program.

Choose the skipped program, press blue button again, you can cancel the skip, The Ⓞ will disappear.

Favourite

Press ▼▲ to choose the program, press FAV button, it will show ♥ on the right side of the program. Choose the FAV program, press FAV button again, you can cancel the FAV, ♥ will disappear.

Once your favorite group is created, you can press the FAV key to quickly access your favorite channel.

2. PICTURE MENU

The second item of the MENU is PICTURE MENU.

You can adjust picture effect here, such as contrast, brightness, etc.

Press ▼▲ to move, press OK to adjust.

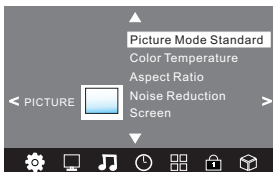

Picture Mode	User
Contrast	50
Brightness	50
Color	50
Sharpness	50
Tint	50
MENU	

Color Temperature	User
Red	40
Green	31
Blue	50
MENU	

NOTE:

1). There are 4 picture modes: Standard, Mild, User and Dynamic. You can only adjust the picture effect when "User" mode is selected.

2). Tint is available in NTSC system only.

3). There are 4 colors temperature modes: Cool, Medium, Warm and User.

4). Screen is available in PC mode only which, you can adjust horizontal position, vertical position, size and phase.

3. SOUND MENU

The third item of the MENU is the SOUND MENU.

You can adjust the sound effect here such as treble, bass, balance etc.

Press ▼▲ to move, press OK to adjust.

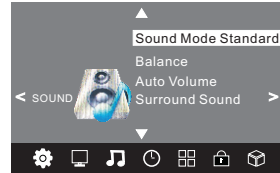

Note:

1). There are 5 sound modes:

Standard, Music, Movie, Sports and User. You can only adjust the sound effect when "User" mode is selected.

2). Auto volume: only available when the input signal volume is too large or with distortion.

4. TIME MENU

The forth item of the menu is the TIME MENU.

You can adjust the power on/off time, sleep time etc. Press ▼▲ to move, press OK to adjust.



NOTE:

1. If "Auto Sleep" is set to on, the TV will be automatically powered off if there is no signal within 15 minutes.

2. The clock time will be set automatically after the DTV channels are tuned.

5. OPTION MENU

The fifth item of the MENU is the OPTION MENU. You can adjust the Menu language, Audio language, Subtitle language etc (only for DTV).



NOTE:
Restore factory default will clear all the programs.

6. LOCK MENU

The sixth item of the MENU is the LOCK MENU. You can lock system, set password, block program and set parental guidance. Once you set the lock system on, you cannot search the channels or change any programs.

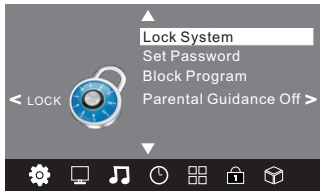

- NOTE:**
- 1) When "Lock system" is highlighted, press OK and enter the default password "6666" to activate it.
 - 2) Block program: Press ▼▲ to choose the program, press green button to block the program. If you want to unblock the program, simply repeat steps mentioned in 1 and 2.
 - 3) Parental guidance: Press ▼▲ to choose 4~18 years.

If you forget your password, you can clear it with the following steps:

- 1) Enter into the "Lock" menu.
- 2) Enter the super code: 9527.
- 3) Select "Set Password".
- 4) Input "9527" as old password.
- 5) Enter the new password, then the setting process is finished and the new password will be enabled.

7. APPLICATIONS MENU

The seventh item of the MENU is the APPLICATIONS MENU.

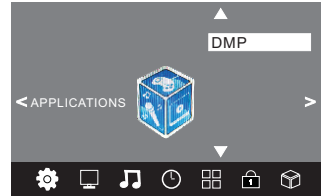

Press OK to enter the DMP menu.



You can enjoy viewing photos and listening music from external USB device. Select the media type by pressing ◀▶, press OK to enter the next selection menu.

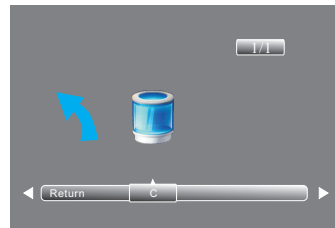

Press ◀▶ to select the right drive and press OK to display media files and folder list or choose "Return" to back to the media type selection menu. Select the media file by pressing ◀▶ or ▼▲, then the preview frame will pop up.

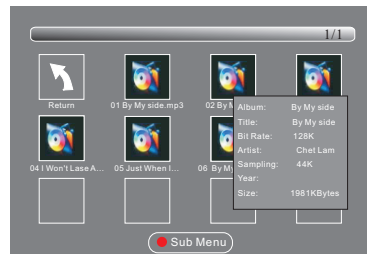

Press the button ► to play the media file in full screen, the following control bar will be displayed on the screen.



Press the ► cursor on the remote control to display the other options on the control bar.



The options available in the control bar will be different when "Photo" is selected from the external USB device.

Press ◀▶ to select the function icon, press OK to confirm the function.

Press ▼ or EXIT to exit the control bar.

Press "INFO" or "OK" to display the control bar again.

NOTE:

Choose the Info icon and press OK to display the Info MENU.

Below photo formats are supported:

- JPEG (JPEG format, files with the extension ".jpg")
- BMP (files with the extension ".bmp")
- PNG (files with the extension ".png")

Below music formats are supported:

- MP3 (files with the extension ".mp3")
- WAV (files with the extension ".wav")

8.EPG Menu(Electronic Program Guide)

The EPG menu is used to look at what is being broadcasted on DTV channel.

To access the EPG menu, press EPG button, the following menu will be displayed:

PROGRAMME GUIDE	TIME
24 / Sep 15:12	
11 Home	Wealth Blog(C)
12 HD a TV	Wealth Blog(HD)(C)
13 TVS	Afternoontea time show
14 CTI-Asia	New Talwan Star Avenue
15 CCTV 4	TV Drama
16 World	ETV
81 Jade	The Green Room
◆ 82 J2	Lovey Dovey My Fiji
● Info	● Schedule
● Reminder	◆ INDEX

1. ● INFO

Use ◀▶ to choose the programs , Press INFO key, you can display the highlighted program's information.

2. ● Schedule

Press yellow key, the entire reminder schedule will be listed. Press ▼▲ to choose the list, press red key ● DELETE to delete the schedule list. Press EPG to return to EPG menu.

Schedule List		04:55	28th Apr	● Delete
Time	Date	Programme Title	Channel Name	

3. ● Reminder

















Press the blue key to choose one program and set up one reminder time, the TV screen will show the selected program in the reminder time automatically.

Reminder		
◀	11 Home	▶
15 Minute		
16 Hour		
Aug Month		
16 Date		
★ Once Mode		
⊙ OK		● BACK

Press OK to save the reminder.

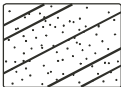
Note:

Programme Guide can be displayed according to "TIME" or "CHANNEL". You can select "TIME" or "CHANNEL" by pressing the ⊙ index key.

Phenomenon or Symptom		Inspection Check	
Picture		Audio	
 Snow	 Noise	Antenna position, direction or connection	
 Ghost	 Normal audio	Antenna position, direction or connection	
 Interference	 Noise	Electronic equipment, car/ motorcycle, fluorescent light	
 Normal Picture	 Mute	Volume (check if mute is activated or if the audio system connections are not correct)	
 No picture	 Mute	Power cord is not inserted Contrast and brightness/volume setup	
 No colour	 Normal audio	Colour control	
 Picture breaking up	 Normal audio or weak	Retune channel	
 No colour	 Noise	TV system	

The LCD TV panel is produced with very high precision technology giving you fine picture details in vibrant color. Occasionally, a few non-active pixels may appear on the screen as a fixed point of red, green, blue, black or white. Please note this does not affect the performance of the product.

LC-22D1H

Units:mm

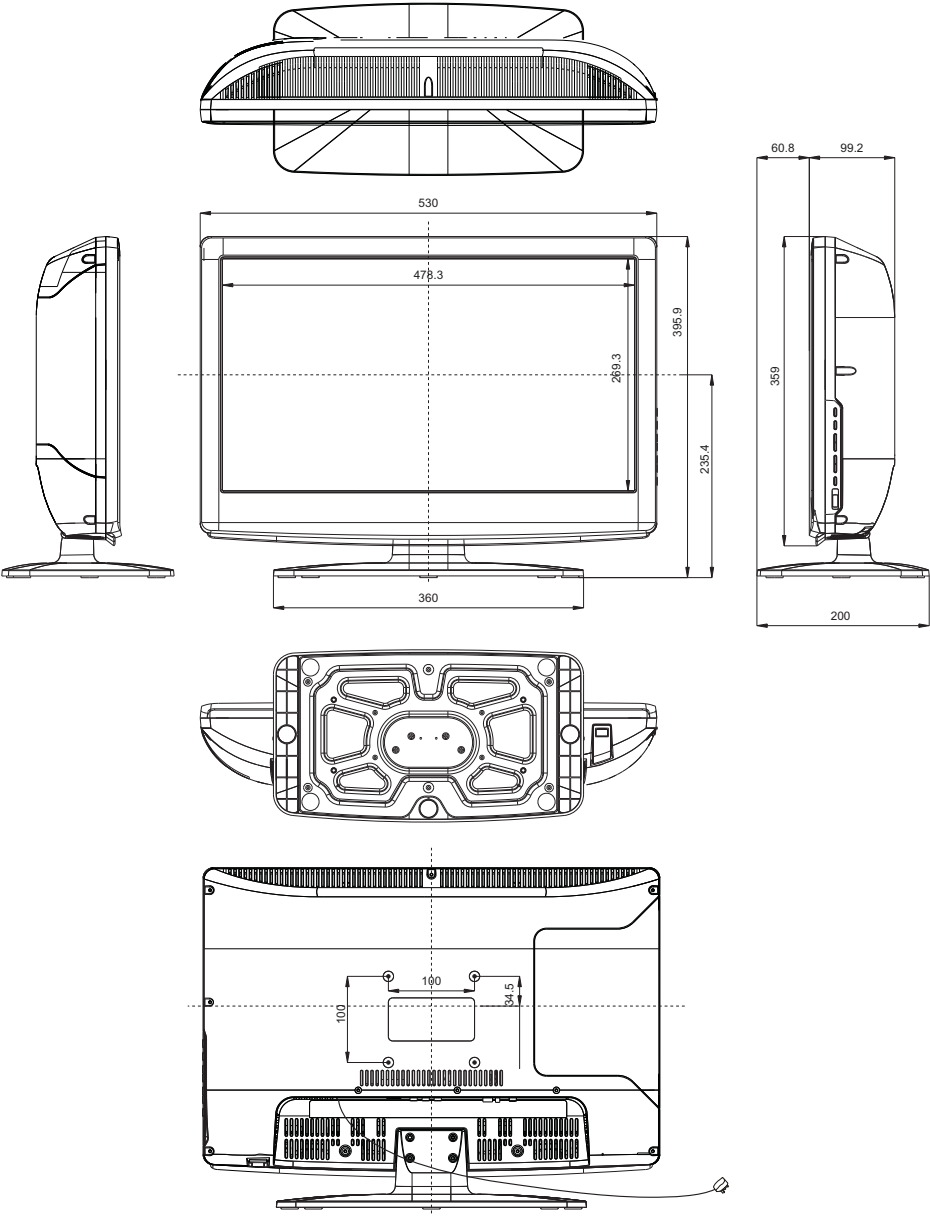

LC-26D1H

Units:mm

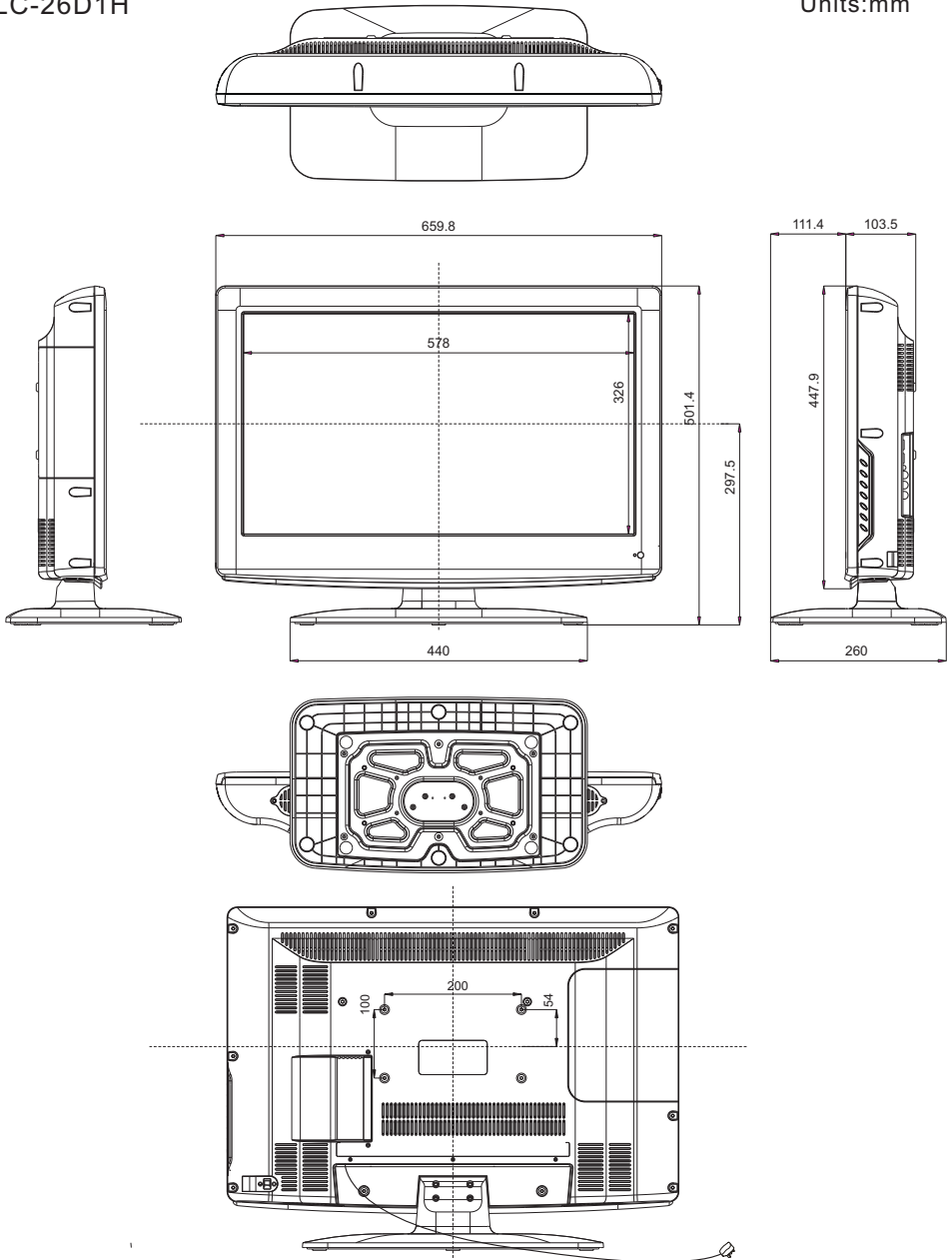

LC-32D1H

Units:mm

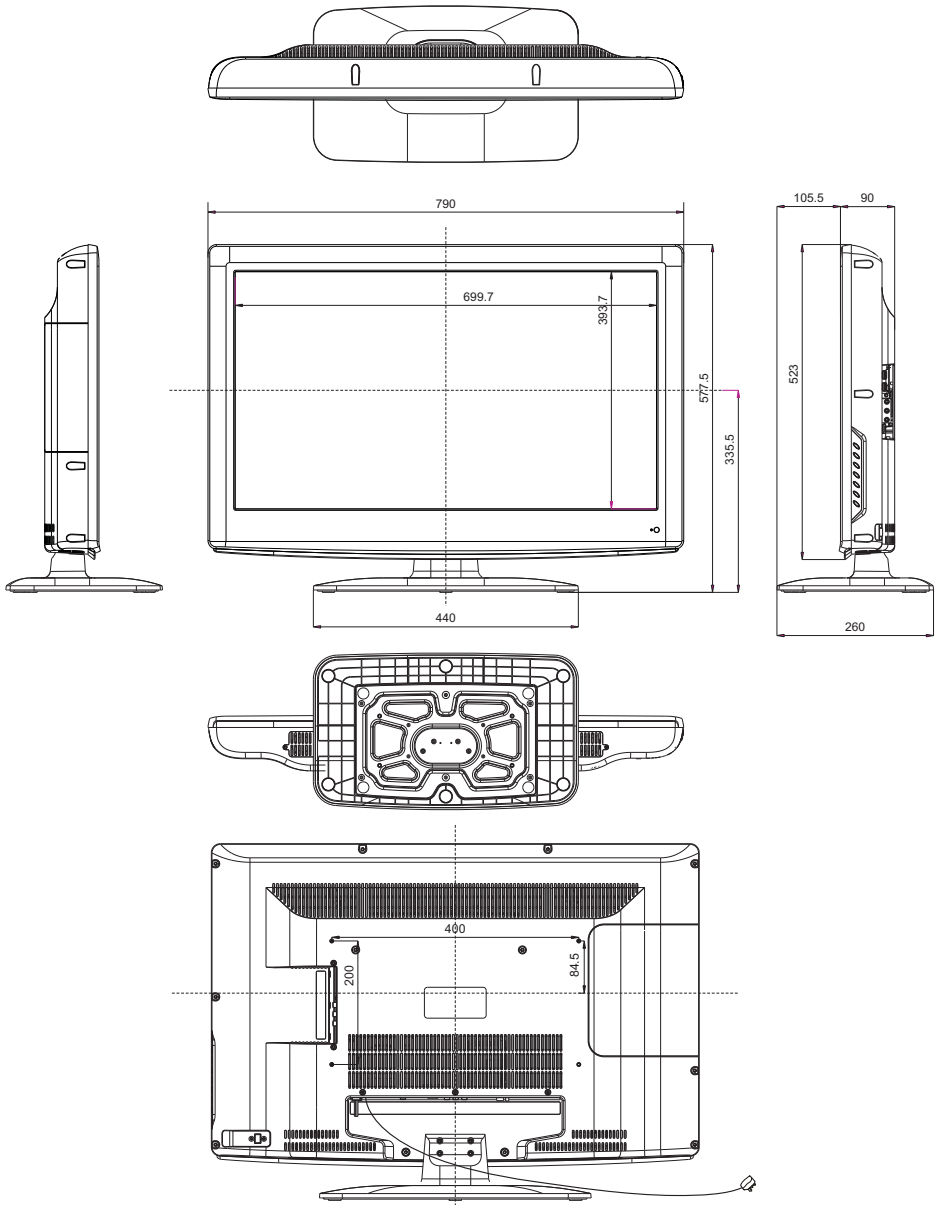

Specifications

Model		LC-22D1H	LC-26D1H	LC-32D1H
TV System	Analogue	PAL-B/G, I, D/K, SECAM-B/G, D/K, NTSC-MN		
	Digital	DMB-T/H		
Receiving Channel	VHF/UHF	48MHz-858MHz		
Digital Terrestrial Broadcast		470-858MHz		
TV-Tuning System		Auto Preset 99 CH		
Stereo / Bilingual		NICAM: B/G, I, D/K, A2 Stereo: B/G		
Video Input		YPbPr, CVBS, VGA, HDMI		
Component		480i/p, 576i/p, 720p/50Hz, 720p/60Hz, 1080i/50Hz, 1080i/60Hz, 1080p/24Hz, 1080p/50Hz, 1080p/60Hz		
HDMI		480i/p, 576i/p, 720p/50Hz, 720p/60Hz, 1080i/50Hz, 1080i/60Hz, 1080p/24Hz, 1080p/50Hz, 1080p/60Hz		
Power Requirement		110-240V ~ 50/60Hz		
Power Consumption (Standby)		54W (0.6W)	71W (0.6W)	122W (0.6W)
Audio Output		2 x 3W	2 x 3W	2 x 7.5W
Operating Temperature		0°C - 40°C		
Accessory		User manual, Remote control, Battery (AAA x 2)		

* The specifications provided here are for reference only.

Differences may occur as product technology will be updated occasionally.

Design and specifications are subject to change without notice.

SHARP[®]
SHARP CORPORATION

PART NO.:4031C221217