





# CONTENTS

PREFACE .....	4
FEATURES .....	4
PRECAUTIONS .....	5
MAJOR OPERATING CONTROLS AND THEIR FUNCTIONS .....	6
■ Front View .....	6
■ Rear View .....	7
INSTALLATION .....	9
■ Mounting in the Rack .....	9
CONNECTION .....	10
■ Basic Connection .....	10
■ Connections with PS-Data Equipment .....	11
■ Series Connection .....	12
■ Alarm Terminal Connection .....	13
■ RS-232C Connection .....	13
■ PS-Data Connection .....	13
■ Mode Switch Setting .....	14
SETUP PROCEDURES .....	15
■ Prior to Setup .....	15
■ Initializing .....	18
■ WJ-HD100 SETUP MENU .....	19
■ SYSTEM SETUP .....	21
■ REC SETUP .....	24
■ ALARM SETUP .....	27
■ INTERNAL TIMER REC .....	29
■ COMMUNICATION SETUP .....	30
■ SYSTEM INFORMATION .....	31
OPERATING PROCEDURES .....	32
■ Sequence of LCD Displays (in operation) .....	32
■ Recording .....	34
■ Playback .....	35
■ Alarm Operation .....	38
■ Copy to CompactFlash Card .....	39
■ Lock/Unlock Buttons .....	41
TROUBLESHOOTING .....	42
SPECIFICATIONS .....	43
APPENDIX .....	44
■ Remote Control From System Controller .....	44
■ SERIES RECORDING .....	45
■ Communication Protocol .....	47

The model numbers listed in this Operating Instructions have no suffixed attached to it.

## PREFACE

The Digital Disk Recorder WJ-HD100 records information on a large capacity hard disk and is designed for use within a surveillance system. It records up to 960 hours of surveillance images (in long-time mode) on a field basis. There are 10 selectable picture quality levels and the field rate can be selected as well. Besides recording and playback,

the WJ-HD100 features versatile interfaces with alarm sensors, a CompactFlash card, RS-232C devices and PS-Data equipment. Interactive menus are provided for system setup, recording setup, alarm setup and so forth.

## FEATURES

- **High quality still picture**

Still pictures are recorded on the disk after compression in the JPEG image file format.

- **No need to replace a video tape**

Thanks to the large disk capacity, there is no more need to replace the recording medium. The recording time can be extended to 16 times that of a single unit by operating multiple units in series.

- **Easy access to the desired record**

Time & Date search and alarm event search make retrieval easy.

- **CompactFlash card slot**

Pictures stored on the disk can be copied to a CompactFlash card in the card slot to browse through them on a personal computer.

- **Various alarm modes**

A different picture quality can be selected for alarm recording and for ordinary recording.

A buzzer can be set up to beep when an alarm input is received.

Besides the physically connected sensors, a built-in motion detector can be set up to generate alarm.

- **Remote control**

An RS-232C port enables the recorder to communicate with a personal computer or other RS-232C devices.

A modular terminal is equipped for communication with PS-Data devices in the RS-485 chain.

---

### TRADEMARKS

SanDisk and CompactFlash are trademarks of SanDisk Corporation.

Microsoft and Windows are either registered trademarks or trademarks of Microsoft Corporation in the United States and/or other countries.

# PRECAUTIONS

- Refer all work related to the installation of this product to qualified service personnel or system installers.
- Avoid condensation on the surface of the hard disk. Wait until the dew evaporates if any of the following case takes place.
  - The recorder is moved to a place significantly different in temperature or humidity.
  - The recorder is moved out of an air-conditioned room.
  - The recorder is placed in an extremely humid place.
  - The recorder is placed in a room where a heater has just been turned on.
- Consumable parts
  - Contact your dealer for replacement of the following parts when the time comes:
    - Built-in hard disk needs replacement after around 30 000 hours of operation.
    - Cooling fan also needs replacement after around 30 000 hours of operation.
    - Backup battery has a lifetime of around five (5) years in an ordinary environment.
- Do not block the ventilation opening or slots on the cover.
  - To prevent the appliance from overheating, place it at least 5 cm (2 inches) away from the wall.
- Do not drop metallic parts through slots.
  - This could permanently damage the appliance. Turn the power off immediately and contact qualified service personnel for service.
- Handle the appliance with care.
  - Do not strike or shake, as this may damage the appliance.
- Fully charge up the backup battery.
  - Keep the appliance turned on for at least 48 hours to recharge the backup battery. This procedure is necessary when using the appliance for the first time or after it has been unplugged for a long time from the AC outlet. Insufficient charging of the battery may cause erasure of settings if the AC power supply should fail.
- We recommend that you note down your settings and retain them. Power or battery failure may erase settings you entered.
- Do not expose the appliance to water or moisture, nor try to operate it in wet areas.
- Do not use strong or abrasive detergents when cleaning the appliance body.
  - Use a dry cloth to clean the appliance when it is dirty.
  - When the dirt is hard to remove, use a mild detergent and wipe gently.
- Do not operate the appliance beyond its specified temperature, humidity or power source ratings.
  - Do not use the appliance in an extreme environment where high temperature or high humidity exists. Use the appliance at temperatures within +5°C to +45°C (41°F to 113°F) and a humidity below 90 %.
  - The input power source for this appliance is 220 - 240 V AC 50 Hz.

# MAJOR OPERATING CONTROLS AND THEIR FUNCTIONS

## ■ Front View

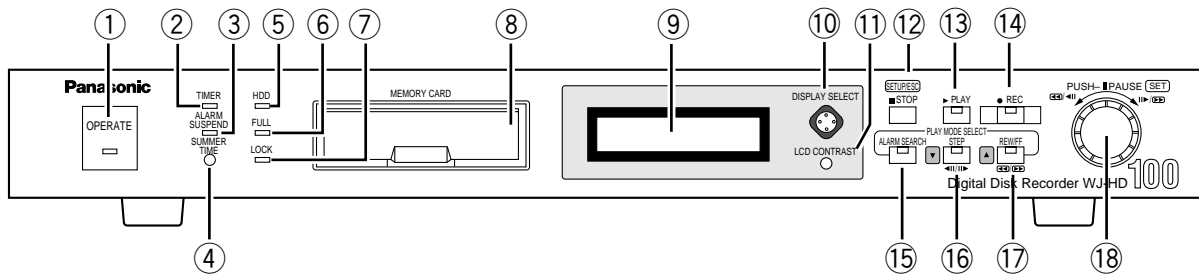

- ① **Operate Indicator [OPERATE]**  
Lights while the power switch on the rear is turned on.
- ② **Timer Record Reservation Indicator [TIMER]**  
Lights when a reservation is made for internal timer recording.
- ③ **Alarm Suspension Indicator [ALARM SUSPEND]**  
Lights when an alarm is activated while alarm suspension is selected. The alarm will be logged in the event history, but recording is suspended and the buzzer will not sound.
- ④ **Summer Time Button [SUMMER TIME]**  
Press the recessed button with a pin to advance the internal clock by one hour to summer time, or to set it back to normal time. While the clock is on summer time, an asterisk \* appears in the time and date display on the LCD and on the video monitor.
- ⑤ **HDD Access Indicator [HDD]**  
Lights while the disk is being accessed.
- ⑥ **Full Indicator [FULL]**  
Blinks when the remaining disk capacity reaches the preset value, and lights when the disk is full.
- ⑦ **Lock Indicator [LOCK]**  
Lights when buttons and JogDial on the front panel are disabled.
- ⑧ **Memory Card Slot [MEMORY CARD]**  
Open the lid to insert the CompactFlash card into the slot or to remove it from the slot. The card is used to store still pictures for browsing through them on a personal computer.
- ⑨ **LCD**  
Displays setup parameters while working with menus, or the operating status while recording or playing back.
- ⑩ **LCD Button [DISPLAY SELECT]**  
There are five positions to press; up, down, left, right and centre. Press the appropriate positions to select a parameter on the LCD.
- ⑪ **LCD Contrast Control [LCD CONTRAST]**  
Adjust the LCD contrast by rotating the control knob with a small screw driver.
- ⑫ **Stop and Setup/ Escape Button [■ STOP] [SETUP/ESC]**  
Pressing this button in any mode other than menu setup stops recording or playback.  
Holding down this button for 2 seconds calls up setup menus or escapes from the setup.  
Press this button to go back one step to the previous selection in the setup menu.
- ⑬ **Play Button [▶ PLAY]**  
Press this button to start playback. The LED lights while playing back, and blinks while pausing or searching.
- ⑭ **Recording Button [● REC]**  
Press this button to start recording. The LED lights while recording, and blinks while alarm recording.
- ⑮ to ⑰ are PLAY MODE SELECT buttons that also specify the JogDial performance in the selected play mode. See pages 35, 36 and 37 for further details.
- ⑮ **Alarm Search Button [ALARM SEARCH]**  
Press this button to search for a desired record in the alarm log. The LED lights in the alarm search mode.
- ⑯ **Step and Down Button [STEP AII/IIB] [C]**  
Press this button to start playing back still pictures field by field. The LED lights in the step playback mode.  
Press this button to move the cursor downward in a setup menu on the monitor.

- ⑰ **REW/FF and Up Button [REW/FF ◀▶] [D]**  
 Press this button to rewind or fast-forward the recorded field. The LED lights in the REW/FF mode.  
 Press this button to move the cursor upward in a setup menu on the monitor.

- ⑱ **JogDial [PUSH – II PAUSE] [SET]**  
 Press the JogDial to pause or restart playback.  
 Rotate the JogDial to access the desired field while rewinding, fast-forward and playing back.  
 Rotate the JogDial to search the oldest picture recorded on the disk for playing back in chronological order.  
 Rotate the JogDial to select a parameter in a setup menu.  
 Press the JogDial to enter the selected parameter and move the cursor to the next position on a setup menu.  
 Hold down the JogDial to copy still pictures to the CompactFlash card.

## ■ Rear View

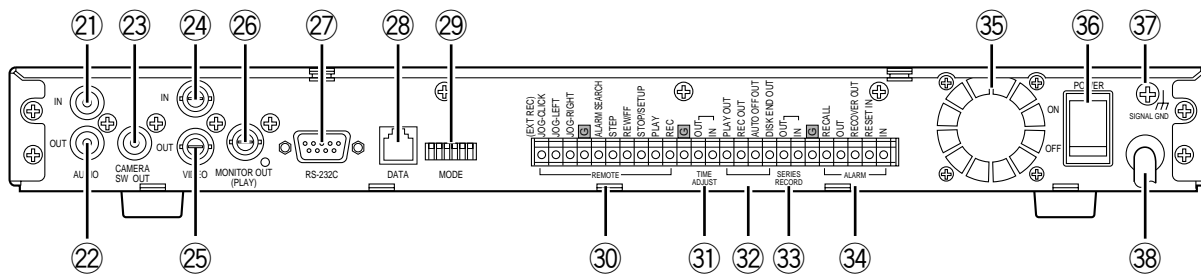

- ⑳ **Audio Input Connector [AUDIO IN]**  
 RCA standard jack accepts an unbalanced  $-10$  dB and  $10\text{ k}\Omega$  line input audio signal supplied from an external device.
- ㉑ **Audio Output Connector [AUDIO OUT]**  
 RCA standard jack supplies an unbalanced  $-10$  dB and  $600\ \Omega$  line output audio signal to an external device.
- ㉒ **Camera Switching Output Connector [CAMERA SW OUT]**  
 This jack is for connecting an external device such as a video multiplexer receiving multiple camera inputs. The switching signal supplied makes the connected device switch from one camera to the other. Use this terminal only when the recording field rate is lower than 10 fps.
- ㉓ **Video Input Connector [VIDEO IN]**  
 This BNC accepts a video signal supplied from a camera or video multiplexer. A  $75\ \Omega$  termination is made unless the video output terminal is connected.
- ㉔ **Video Output Connector [VIDEO OUT]**  
 This BNC supplies a video signal looped through the video input terminal. Connect with a video monitor to check the input picture, or the next WJ-HD100 in a SERIES connection.
- ㉕ **Monitor Output Connector [MONITOR OUT (PLAY)]**  
 This BNC supplies playback pictures stored on the hard disk, or setup windows. Connect with a video monitor.
- ㉖ **RS-232C Port [RS-232C]**  
 Through this 9-pin D-Sub connector the digital disk recorder communicates with the personal computer. Use a reverse type cable for connection with the personal computer. Protocol and commands are described in APPENDIX.
- ㉗ **Data Port [DATA]**  
 Connect with equipment in the PS·Data chain or a system controller.
- ㉘ **Mode Switch [MODE]**  
 Use this switch for setting unit addresses and initializing all disk contents and setup data.
- Terminal Board**
- ㉙ **Remote In Terminal**  
 These are connected with switches for external control of major operations on the front panel such as JOG-CLICK, JOG-LEFT, JOG-RIGHT, ALARM SEARCH, STEP, REW/FF, STOP/SETUP, PLAY and REC.
- ㉚ **Time Adjust Terminal**  
 IN and OUT terminals for synchronizing the internal clock with connected external devices.

**32 Status Out Terminal**

These terminals supply the following status information: PLAY OUT, REC OUT, AUTO OFF OUT, DISK END OUT.

AUTO OFF OUT: AUTO OFF OUT signal turns active (active when low), and playback or recording stops when a temperature error is detected inside the unit. Turn the power off and wait for a while until you turn it on again to reset the error.

**33 Series Record Terminal**

Connect these terminals when using multiple units in series or loop connection.

**34 Alarm Terminal**

These terminals supply and receive the following alarm related information: ALARM RECALL, ALARM OUT, ALARM RECOVER OUT, ALARM RESET IN, ALARM IN.

**35 Cooling Fan**

Do not block the air flow of this cooling fan through the openings on both sides of the top cover to prevent the appliance from overheating.

**36 Power Switch [POWER ON OFF]**

Turns the power on and off. The OPERATE indicator on the front panel lights while the power switch is turned on.

**37 Signal Ground [SIGNAL GND]**

Connect with the terminals of other devices as necessary to avoid grounding loop and noise.

**38 Power Cord**



# INSTALLATION

## ● Warning

This installation should be made by qualified service personnel or system installers.

## ● Caution Notes Regarding Installation

### Places to avoid

- Direct exposure to sunlight or near a source of heat such as a radiator.
- Very dirty and dusty places. Places subject to strong vibrations.
- Near a transformer, dimmer, video player, radio or monitor. These may cause humming noise, etc.

### Caution notes regarding mounting

- Do not block the ventilation openings or slots in the cover to prevent the appliance from overheating.
- Always keep the temperature in the rack within +45°C (113°F).
- Secure the rear of the appliance to the rack with additional mounting brackets (procured locally), if the rack is subject to vibration.

## ■ Mounting in the Rack

1. Remove the four rubber feet by removing the four screws on the bottom of the unit.

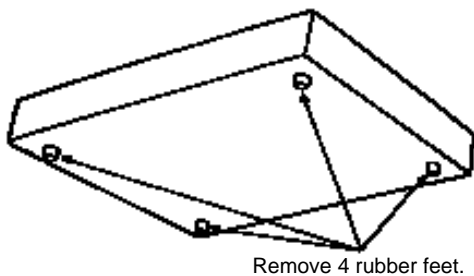

3. Install the unit with the rack mounting brackets in the rack by using four screws (not included).

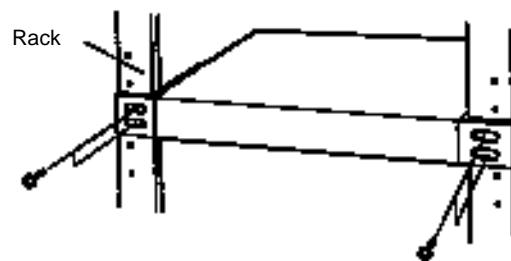

2. Place the rack mounting brackets on both sides of the unit and tighten with the six supplied screws (M3 x10).

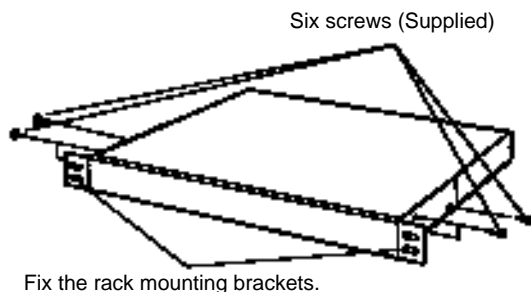

# CONNECTION

## Basic Connection

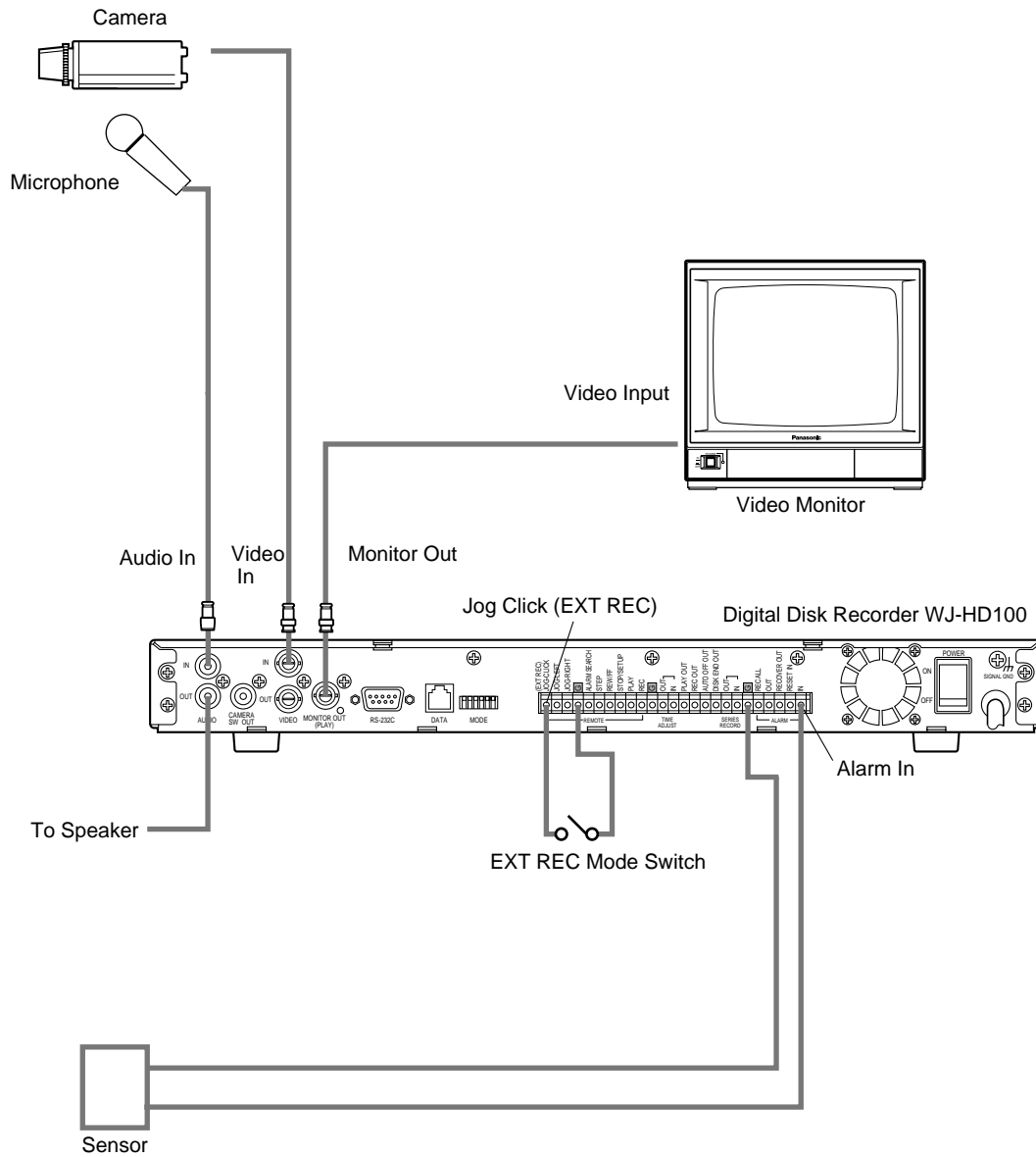

To select the recording mode from an external device connected to the EXT REC mode switch, the JOG/EXT REC parameter in the REC SETUP menu must be set to EXT REC.

# ■ Connections with PS·Data Equipment

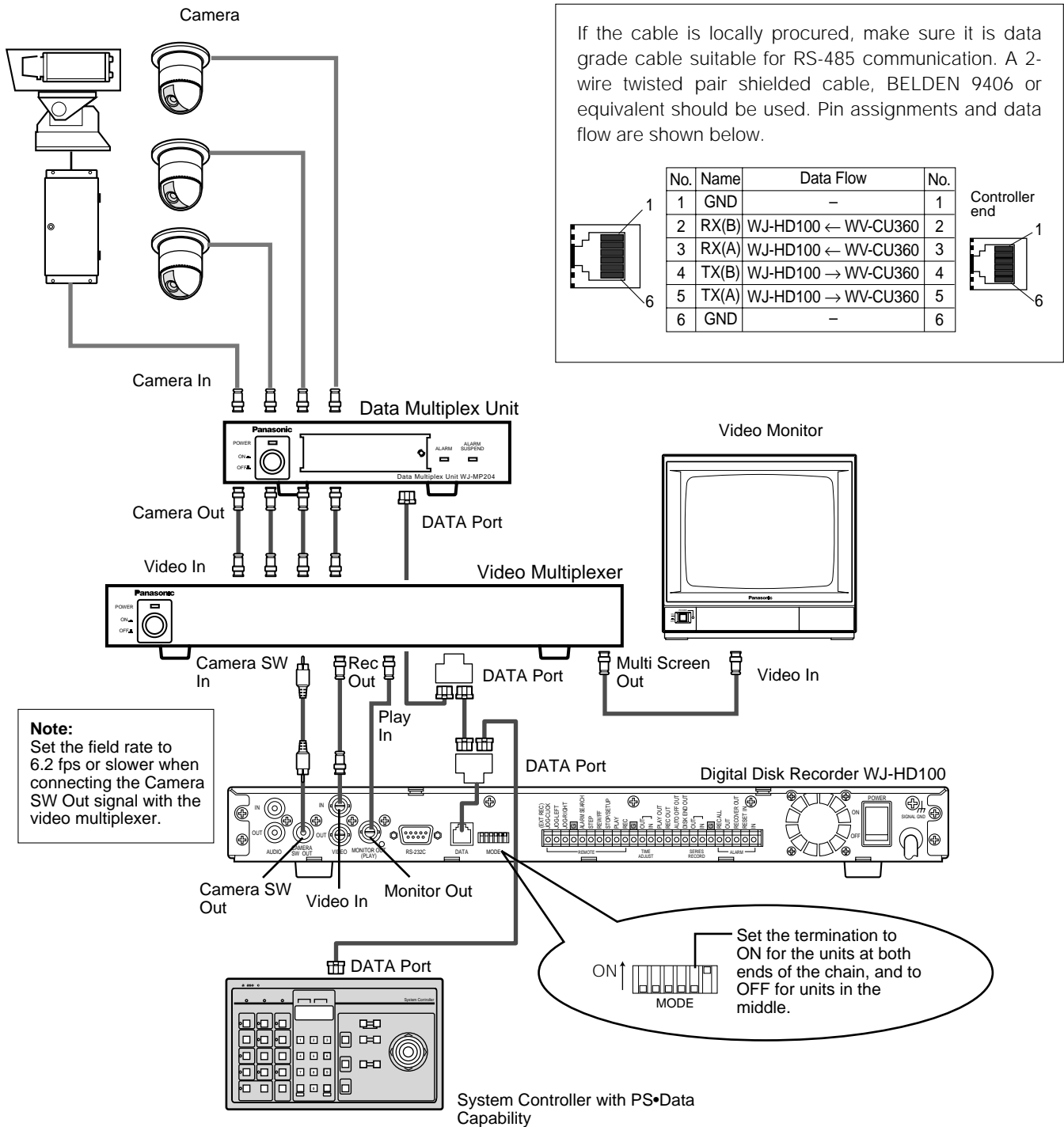

PS·Data equipment must be set up for communication as follows:

- Protocol selection: PS·DATA
- Unit Address: Set an address unique in the chain.
- Baud rate, data bit length, parity check, stop bit: Choose the same settings as used for the other equipment in the chain.

Recommended video multiplexers are Panasonic's WJ-FS series or similar models having specifications as follows.

- Switching recognition signal is located within 8H prior to the end of vertical blanking.
- A camera switching rate of 4/50 seconds or more is available.

## Series Connection

The diagram below shows an example where multiple disk recorders are connected in series or loop for long time recording, and a video multiplexer is used.

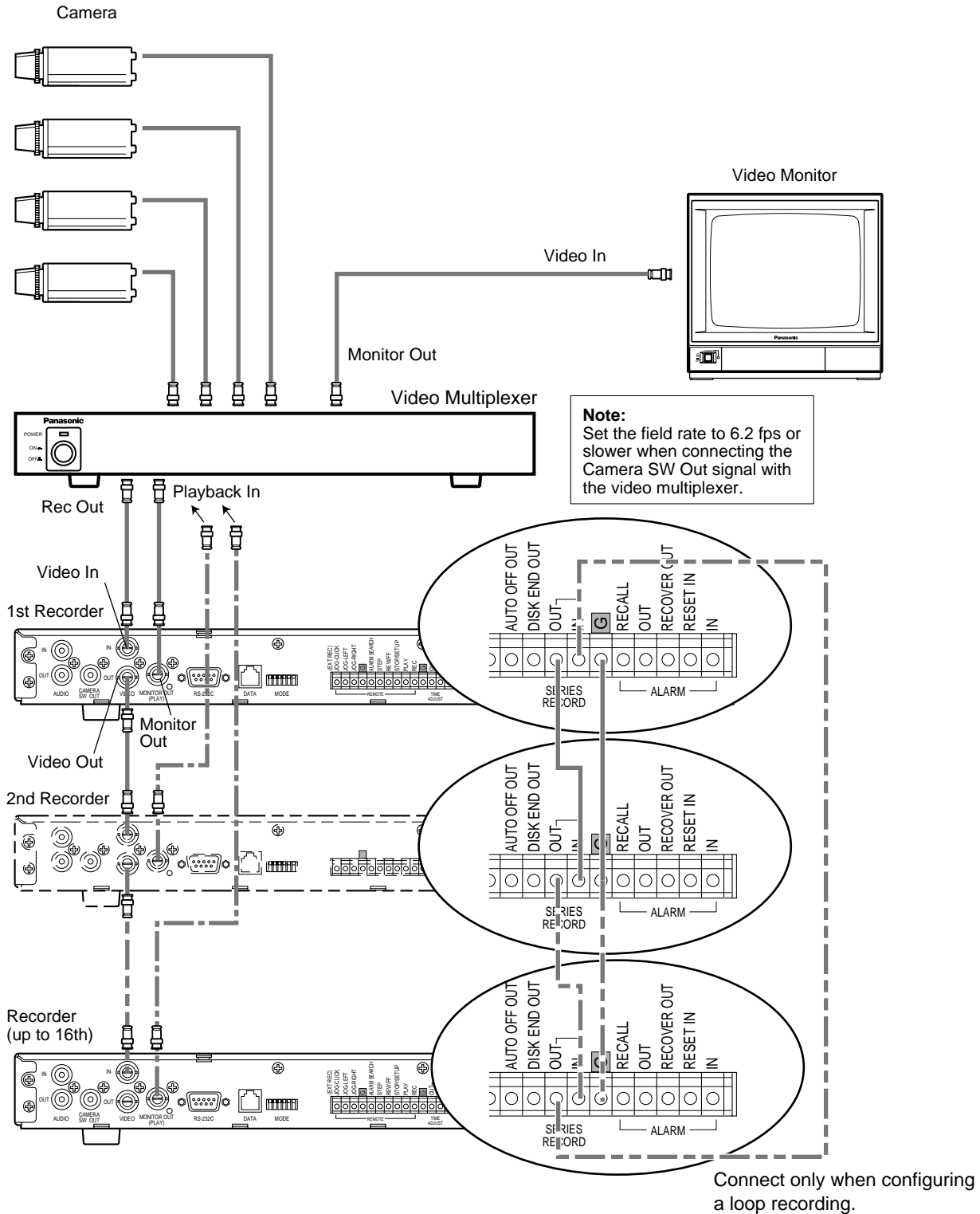

Recommended video multiplexers are Panasonic's WJ-FS series or similar models having specifications as follows.

- Switching recognition signal is located within 8H prior to the end of vertical blanking.
- A camera switching rate of 4/50 seconds or more is available.

See SERIES RECORDING in APPENDIX for setup and operating procedures.

## ■ Alarm Terminal Connection

A connection example is shown below.

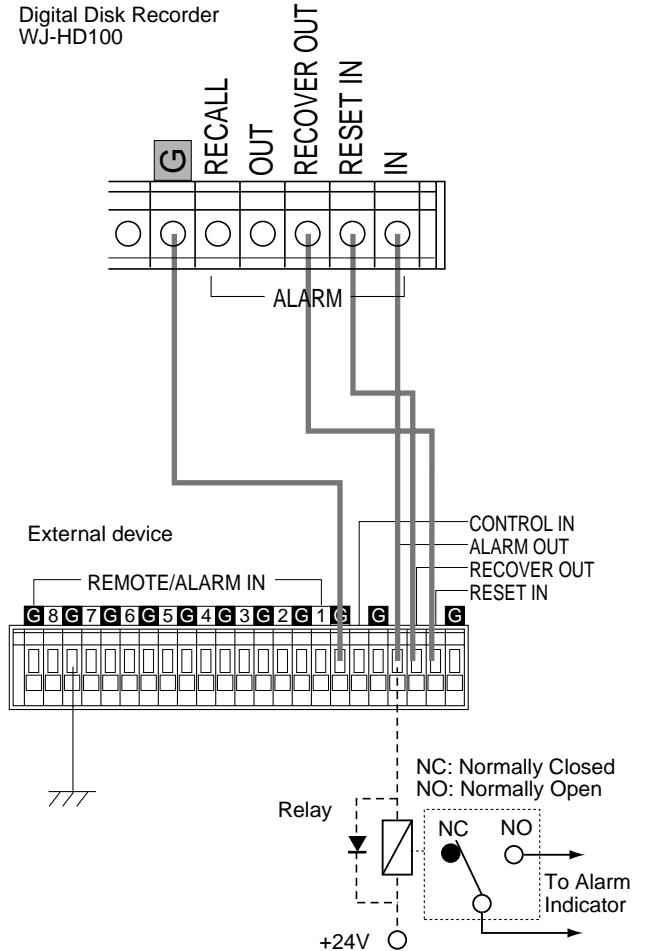

**IN:** Stands for Alarm Signal In. Connect directly with a sensor unit or indirectly with a unit having sensor output capability to the recorder. The recorder enters alarm recording mode when the alarm signal (active when low) comes in.

**RESET IN:** Receives the reset signal (active when low) from a connected device.

**RECOVER OUT:** Supplies the reset signal when the RESET IN is received, the [■ STOP] button is pressed, or the AUTO RESET time elapses.

**OUT:** Stands for the status output active until an alarm is reset.

**RECALL:** The alarm history is displayed on the Monitor every time the external switch is turned on.

**GND:** Signal ground

## ■ RS-232C Connection

Use an RS-232C cable (not included) as shown below to connect the RS-232C terminal with a personal computer or the like. The protocol selection in the COMMUNICATION SETUP must be set to VTR.

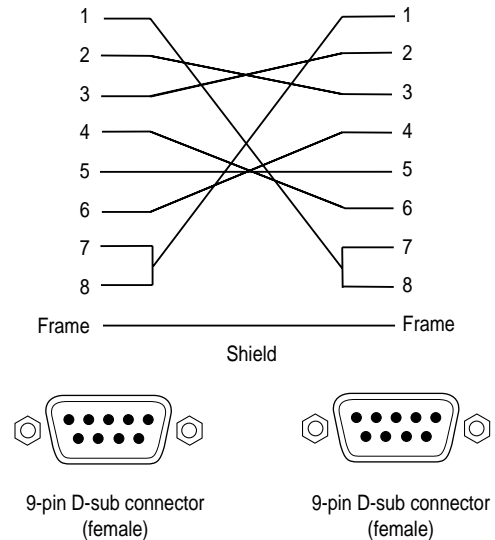

## ■ PS·Data Connection

Connect the DATA terminal on the rear panel to a system component with a modular cable (not included) in the PS·Data chain. The protocol selection in the COMMUNICATION SETUP must be set to PS·DATA. Follow the procedure for unit address setup (page 14, 30) and termination (page 14).

Panasonic part # WV-CA48 series, RS-485 cables and connectors are recommended for the connection.

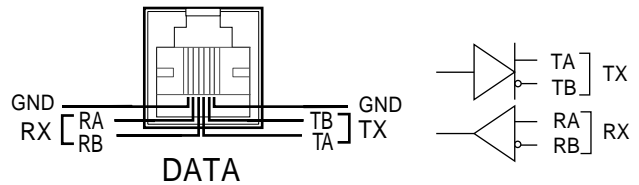

## ■ Mode Switch Setting

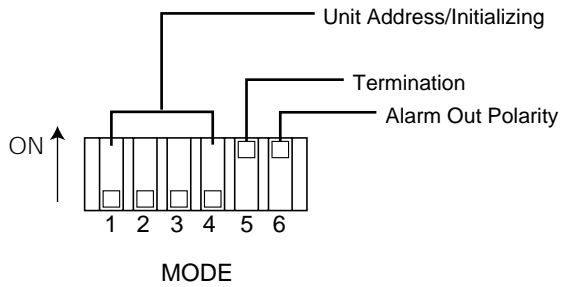

The 6-bit DIP switch on the rear panel is used as follows.

- #1 through #4:** For setting the unit address or initializing the setup data
- #5:** Termination for communication lines
- #6:** For setting the polarity of the alarm output signal

## ● Unit Address & Initialize

The unit address can be set either on the setup menu or by setting this DIP switch.

<p>ON ↑</p> <p>MODE</p>	Unit address is specified in the setup window.
<p>ON ↑</p> <p>MODE</p>	Unit address 1
<p>ON ↑</p> <p>MODE</p>	Unit address 2
<p>ON ↑</p> <p>MODE</p>	Unit address 3
<p>ON ↑</p> <p>MODE</p>	All disk contents and setup data are initialized.

**Note:** Do not use switch combinations other than shown above.

## ● Termination

Set DIP switch #5 to ON or OFF position depending on the type of connection and the unit's position within the daisy chain.

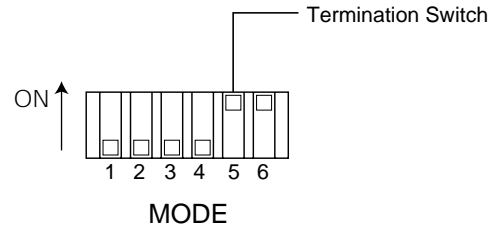

**Daisy Chain Connection:** Set the termination to ON for the units at both ends of the RS-485 chain (PS·Data), and to OFF for units in the middle.

System Component

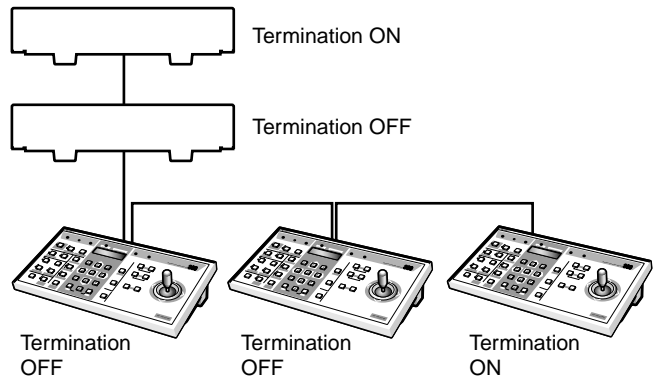

**Home run Connection:** For a one-to-one connection, set the termination to ON.

## ● Alarm Output Polarity

The DIP switch #6 specifies the polarity of ALARM OUT and ALARM RECOVER output signals. Select [active-low] or [active-high] depending on the type of the connected device. See the manual included in the connected device for acceptable signal polarity. The default setting is ON [active-high].

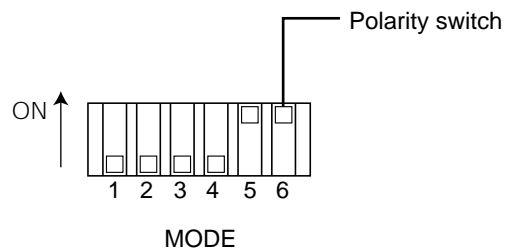

Switch #6 vs Polarity (when active)

	ON (active-high)	OFF (active-low)
ALARM OUT	+12 V DC	Open-collector low
ALARM RECOVER OUT	+5 V DC	Open-collector low

# SETUP PROCEDURES

## ■ Prior to Setup

### ● Turning On the Power

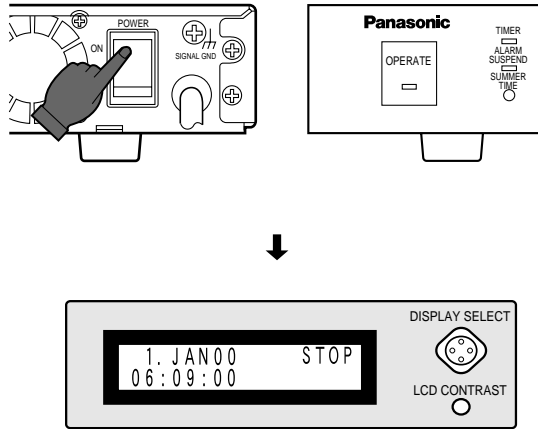

1. Plug the power cord into the AC outlet.
2. Turn on the power switch on the rear panel.  
The operate LED lights, and the date, time and operating status are displayed on the LCD.

Power-on recording will start if [Timer Rec] has been set to [EXT] with the LCD button.

**Note:** Avoid turning the power on and off within a short time. Allow at least 5 seconds from off to on and vice versa.

### ● Turning Off the Power

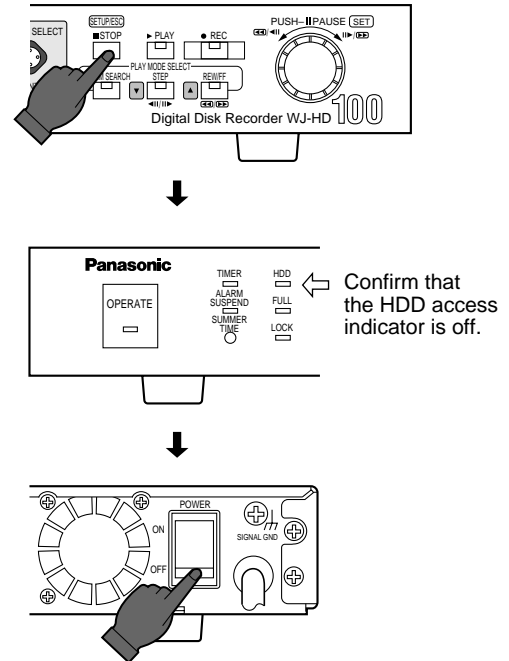

1. Press the stop button to quit recording or playback.  
Make certain that the HDD access lamp turns off.
2. Turn off the power switch on the rear panel.  
The operate LED goes out, and the operating status on the LCD disappears.

**Note:**

- Do not turn off the power while the HDD access lamp is on.
- Do not leave the unit turned off for a long time.  
Supply AC power to the unit and turn it on to charge up the backup battery.

## ● Displaying the SETUP MENU

1. Confirm that the camera and peripherals are connected correctly and securely.
2. Turn on the power switches of all system components.
3. Hold down the SETUP/ESC button for 2 seconds or more. The WJ-HD100 SETUP MENU appears on the monitor.

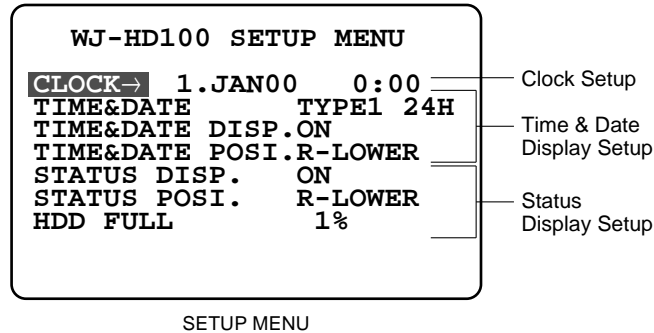

## ● Buttons and Dials Used for the Setup

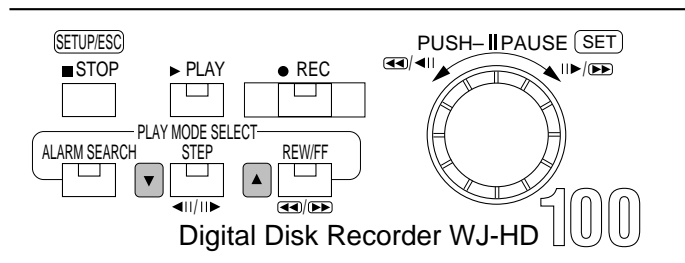

**[▲] button:** Moves the cursor upward in a menu, and opens the previous menu page.

**[▼] button:** Moves the cursor downward in a menu page, and opens the next page menu.

**JogDial (Clockwise):**

Increases the parameter value.

**JogDial (Counter-clockwise):**

Decreases the parameter value.

**JogDial (Pressing):**

Validates the selected parameter, and moves the cursor to the right.

**[SETUP/ESC] [■ STOP] button (pressing):**

Moves the cursor to the left.

**[SETUP/ESC] [■ STOP] button (holding down):**

Opens the setup window or escapes from it and switches back to normal operation.



## ● Setup Menu Sequence

The WJ-HD100 provides the following seven setup menus: WJ-HD100 SETUP MENU, SYSTEM SETUP, REC SETUP, ALARM SETUP, INTERNAL TIMER REC, COMMUNICATION SETUP and SYSTEM INFORMATION. Pressing the [▲] or [▼] button repeatedly will switch the menu as follows.

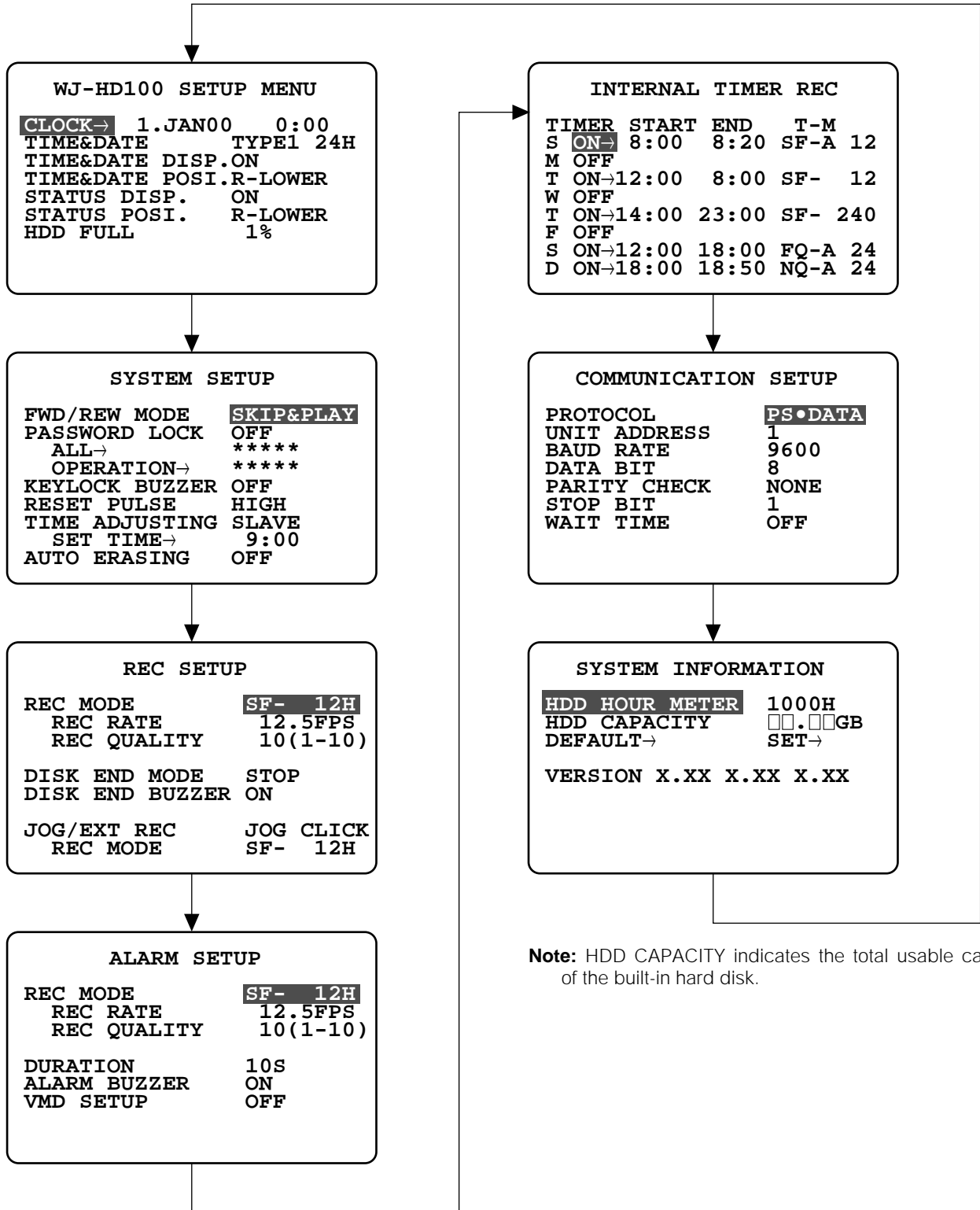

**Note:** HDD CAPACITY indicates the total usable capacity of the built-in hard disk.

The item or parameter selected and highlighted on the monitor menu is also displayed on the LCD.

## ■ Initializing

You can either initialize all disk contents including image data and setup data, or setup data only.

### ● Initializing All Contents & Setup Data

**Warning!** The following are irrevocable procedures. We strongly recommend that you copy important pictures from the hard disk to CompactFlash cards before initializing.

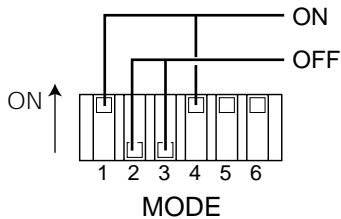

1. Press the [■ STOP] button to stop recording or playback.
2. Turn off the power.
3. Set MODE switches #1 through 4 on the rear panel as follows:

**#1:** ON  
**#2:** OFF  
**#3:** OFF  
**#4:** ON

4. Turn on the power.  
The disk contents and setup data are initialized.

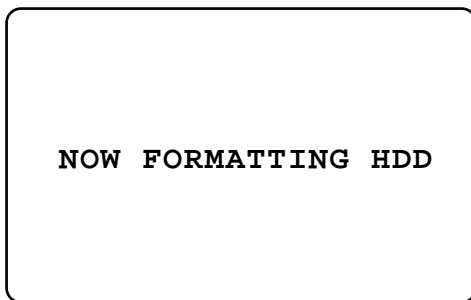

5. Turn off the power, and return the MODE switches to the previous positions.

### ● Initializing Setup Data

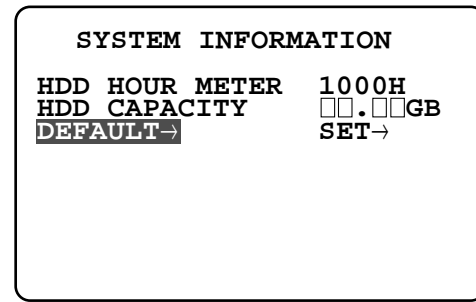

1. Open the SYSTEM INFORMATION window, then move the cursor to DEFAULT.
2. Press the JogDial to move the cursor to SET.
3. Press the JogDial.
4. Select YES with the JogDial.

**YES:** Initializing of setup data is enabled.

5. Press the JogDial.  
SET DONE appears on the monitor after initializing.
6. Press the [SETUP/ESC] button.  
The cursor moves to DEFAULT.
7. Hold down the [SETUP/ESC] button for 2 seconds to quit the setup.

## ■ WJ-HD100 SETUP MENU

### ● Clock Setup 001 CLOCK>

Set the internal timer to the present time and date.  
The default value is "1.JAN00 0:00".

1. Hold down the [SETUP/ESC] button for 2 seconds to display the setup menu on the monitor.
2. Move the cursor on the monitor to CLOCK with the [▲] or [▼] button. The selected item appears also on the LCD with item number (001 in this case), and parameters (1.JAN00 0:00, day-month-year and time) in the second line.

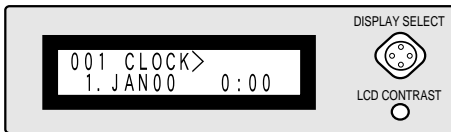
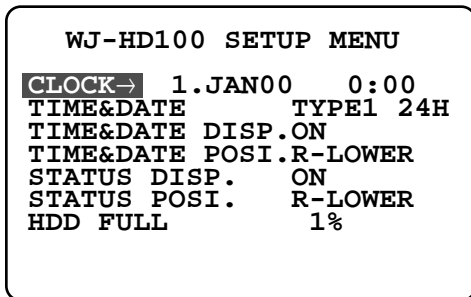
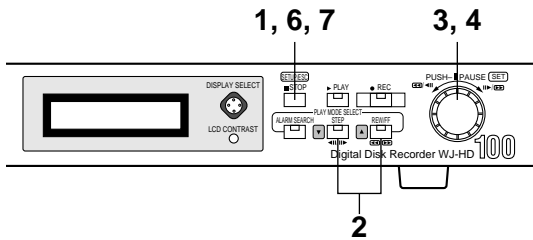

3. Move the cursor to the right by pressing the JogDial. The cursor highlights the item position (day digits).
4. Select the appropriate parameter (day) by rotating the JogDial.
5. Repeat the above steps 3 and 4 to set month, year and time.
6. Press the [SETUP/ESC] button.
7. Hold down the [SETUP/ESC] button for 2 seconds to quit the setup.

**Note:** Beside the JogDial the [▲] and [▼] buttons are also used to move the cursor for setting time and date.

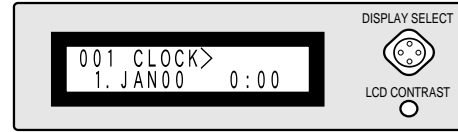
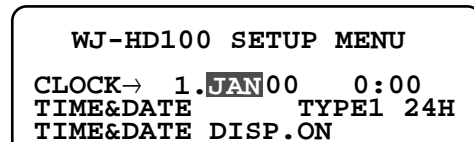

### ● Time & Date Type 002 TIME&DATE TYPE

Select the 24-hour or AM-PM time system. When AM-PM is selected, the time is followed by A or P, for example, 7:00 A.

You can also select display style TYPE1 or TYPE2 as shown below.

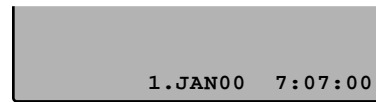

TYPE1



TYPE2

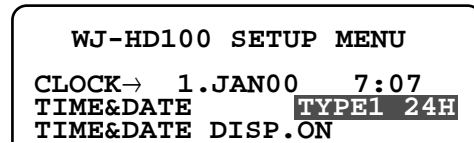

1. Move the cursor to TIME&DATE with the [▲] or [▼] button.
2. Select the parameter with the JogDial. The default value is TYPE1 24H.

**TYPE1 24H:** Time & date are displayed in one line in the 24-hour system.

**TYPE1 12H:** Time & date are displayed in one line in the AM-PM system.

**TYPE2 24H:** Time & date are displayed in two lines in the 24-hour system.

**TYPE2 12H:** Time & date are displayed in two lines in the AM-PM system.

## ● Time & Date Display 003 T&D DISPLAY

Select ON or OFF to show or hide the time and date display on the monitor. The LCD is not affected by this selection.

```
CLOCK→ 7.JAN00 8:09
TIME&DATE TYPE1 24H
TIME&DATE DISP. ON
TIME&DATE POSI. R-LOWER
STATUS DISP. ON
STATUS POSI. R-LOWER
HDD FULL 1%
```

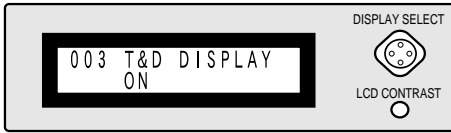

1. Move the cursor to TIME&DATE DISP. with the [▲] or [▼] button.
2. Select either ON or OFF with the JogDial. The default is ON.

**ON:** Shows time and date on the monitor.  
**OFF:** Hides time and date.

## ● Time & Date Position 004 T&D POSITION

Select one of six available positions (including OFF) for having the time & date displayed on the monitor. The LCD is not affected by this selection.

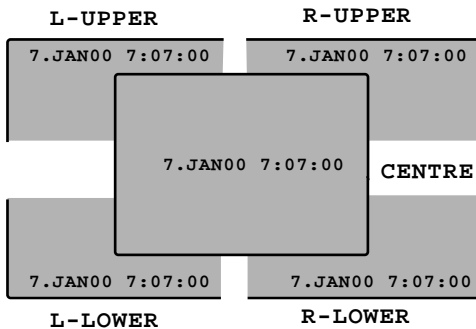

```
CLOCK→ 7.JAN00 8:09
TIME&DATE TYPE1 24H
TIME&DATE DISP. ON
TIME&DATE POSI. R-LOWER
STATUS DISP. ON
STATUS POSI. R-LOWER
HDD FULL 1%
```

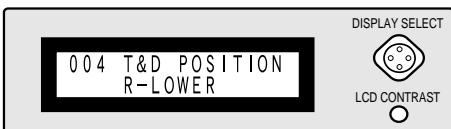

1. Move the cursor to TIME&DATE POSI. with the [▲] or [▼] button.

2. Select the desired position with the JogDial. The default is R-LOWER.

**L-UPPER:** Displays time & date in the left upper corner.  
**R-UPPER:** Displays time & date in the right upper corner.  
**CENTRE:** Displays time & date in the centre.  
**L-LOWER:** Displays time & date in the left lower corner.  
**R-LOWER:** Displays time & date in the right lower corner.  
**OFF:** Time & date display is disabled.

## ● Status Display 005 STATUS DISP.

Select ON or OFF to show or hide the status display on the monitor. The LCD is not affected by this selection.

```
CLOCK→ 7.JAN00 8:09
TIME&DATE TYPE1 24H
TIME&DATE DISP. ON
TIME&DATE POSI. R-LOWER
STATUS DISP. ON
STATUS POSI. R-LOWER
HDD FULL 1%
```



1. Move the cursor to STATUS DISP. with the [▲] or [▼] button.
2. Select either ON or OFF with the JogDial. The default is ON.

**ON:** Shows the operating status on the monitor.  
**OFF:** Hides the status.

## ● Status Position 006 STATUS POSI.

Select one of six available positions (including OFF) for having the status displayed on the monitor. The LCD is not affected by this selection. The status display appears right under the time & date display if the same position is selected for both.

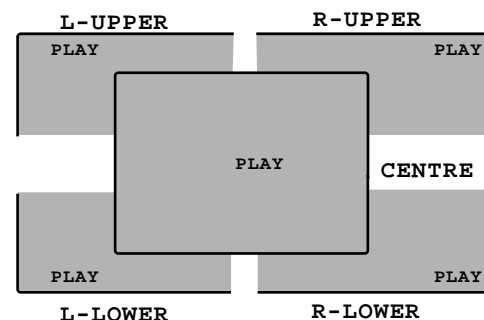

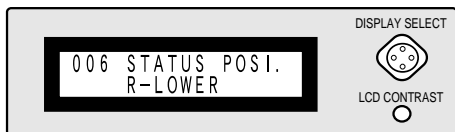
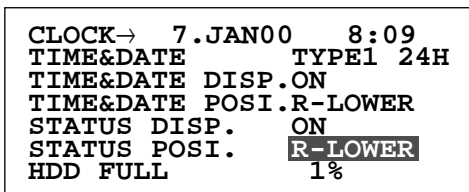

1. Move the cursor to STATUS POSI. with the [▲] or [▼] button.
2. Select the desired position with the JogDial. The default is R-LOWER.

**L-UPPER:** Displays the status in the left upper corner.  
**R-UPPER:** Displays it in the right upper corner.  
**CENTRE:** Displays it in the centre.  
**L-LOWER:** Displays it in the left lower corner.  
**R-LOWER:** Displays it in the right lower corner.  
**OFF:** Status display is disabled.

## ● HDD FULL Selection

### 007 HDD FULL

Set the disk capacity from 1 % to 99 % to warn the operator that the available capacity is nearing the end. There are two warning levels. First the FULL indicator on the front panel blinks when the remaining disk capacity has reached the preset value. Finally the buzzer beeps when the disk is full, provided that the DISK END BUZZER parameter in the REC SETUP menu is set to ON. At the same time the FULL indicator turns on.

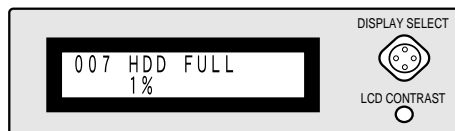
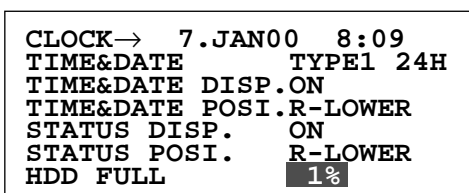

1. Move the cursor to HDD FULL with the [▲] or [▼] button.
2. Select the desired value with the JogDial. The default value is 1 %.

**1 % to 99 %:** The FULL indicator blinks when the remaining disk capacity reaches the selected value.

## ■ SYSTEM SETUP

### ● Quick Play Mode Selection

#### 101 FWD/REW MODE

Picture search is available in quick forward and backward playback. Set the playback picture rate (FWD/REW MODE) in the SYSTEM SETUP window to SKIP or SKIP&PLAY. The playback sequence for each mode is shown below.

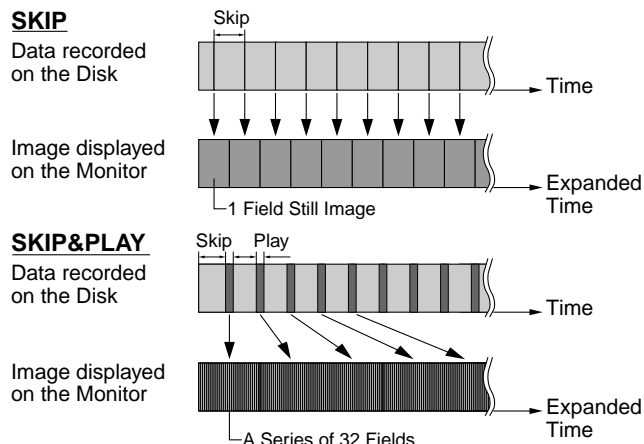

1. Hold down the [SETUP/ESC] button for 2 seconds to display the setup menu on the monitor.
2. Press the down [▼] button repeatedly until the SYSTEM SETUP window appears. (You can switch through the setup menus by repeatedly pressing the up [▲] or down [▼] button.)
3. Move the cursor to FWD/REW MODE with the up [▲] or down [▼] button.
4. Rotate the JogDial to select the desired parameter. The default is SKIP&PLAY.

**[SKIP]:** One field still picture is picked up from the disk and displayed on the monitor as shown above. This is quicker than skip and play.

**[SKIP&PLAY]:** A 32-field series of pictures is played back. We recommend that you select [SKIP&PLAY] when a video multiplexer is installed in the system.

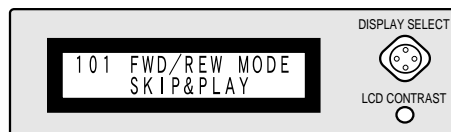
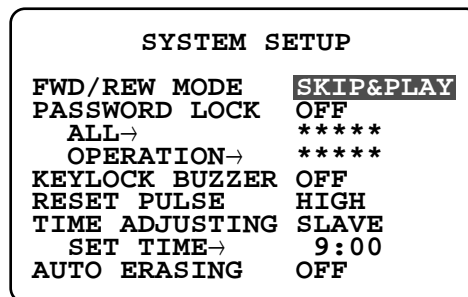

5. Press the [SETUP/ESC] button for 2 seconds to quit setup.

## ● Password Setup 102 PASSWORD LOCK

A 5-digit password is entered to protect all settings, recorded pictures, and operating status, or settings only from unauthorized access. While the LOCK indicator on the front panel is on, the LCD displays the message "Now Key Locked!" to warn unauthorized operators. If accessed in this condition, the buzzer beeps.

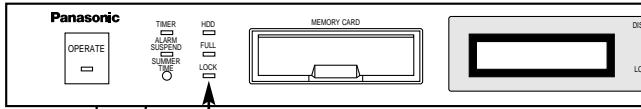

Turned on while the buttons are locked.

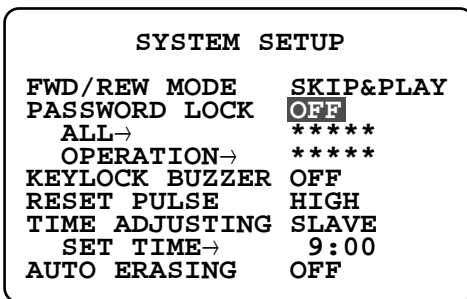

1. Move the cursor to PASSWORD LOCK with the up [▲] or down [▼] button.
2. Select either ON or OFF with the JogDial. The default is OFF.

**ON:** Buttons are password protected against erroneous operation and tampering. When set to ON, the recorder enters the button lock mode if neither a button nor the JogDial is operated within a period of five minutes.

**OFF:** No password protection is applied unless the button lock mode is enabled using the LCD button as described in the right column of this page.

**Note:** Select OFF when you do not need the button lock mode. When set to ON, the recorder enters the button lock mode if neither a button nor the JogDial is operated within a period of five minutes.

3. Move the cursor to ALL or OPERATION with the up [▲] or down [▼] button.

**ALL:** Both normal operations and setup operations are allowed.

**OPERATION:** Normal operations only are allowed.

4. Press the JogDial. The preset password appears. The default is "12345" for both ALL and OPERATION.
5. Select a number with the JogDial, then press it. The cursor moves one digit to the right.
6. Repeat step 5 above until all digits are entered.
7. Press the [SETUP/ESC] button to confirm the entered password. Go back to step 3 if you have not yet set the OPERATION password.

## ● Setting Buzzer ON/OFF 105 KEYLOCK BUZ

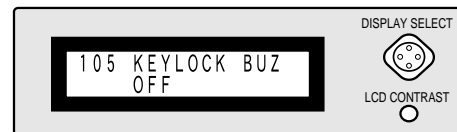
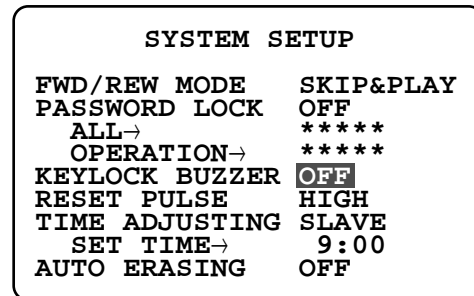

1. Move the cursor to KEYLOCK BUZZER with the up [▲] or down [▼] button.
2. Rotate the JogDial to select ON or OFF. The default is OFF.

**ON:** Buzzer beeps when unauthorized access takes place.

**OFF:** Buzzer does not sound.

## ● Reset Pulse Polarity 106 RESET PULSE

The polarity of the alarm reset pulse is selected in the SYSTEM SETUP window.

The reset pulse is supplied from an external device with high or low active signal form to the RESET IN terminal on the rear panel.

SYSTEM SETUP	
FWD/REW MODE	SKIP&PLAY
PASSWORD LOCK	OFF
ALL→	*****
OPERATION→	*****
KEYLOCK BUZZER	OFF
RESET PULSE	HIGH
TIME ADJUSTING	SLAVE
SET TIME→	9:00
AUTO ERASING	OFF

1. Open the system setup window, then move the cursor to RESET PULSE with the up [▲] or down [▼] button.
2. Select either HIGH or LOW with the JogDial. The default is HIGH.

**HIGH:** Stands for high-active. The recorder stops alarm recording when a positive pulse is supplied.

**LOW:** Stands for low-active.

## ● Time Adjusting 107 TIME ADJUSTING

IN and OUT terminals for a calibration signal are provided on the TIME ADJUST terminal board on the rear panel. The master unit supplies the calibration signal to the slaves. This is convenient for synchronizing the internal clock with other connected devices. Make certain to connect the IN and OUT terminals correctly.

SYSTEM SETUP	
FWD/REW MODE	SKIP&PLAY
PASSWORD LOCK	OFF
ALL→	*****
OPERATION→	*****
KEYLOCK BUZZER	OFF
RESET PULSE	HIGH
TIME ADJUSTING	SLAVE
SET TIME→	9:00
AUTO ERASING	OFF

1. Move the cursor to TIME ADJUSTING with the [▲] or [▼] button.
2. Select either MASTER or SLAVE with the JogDial. The default is SLAVE.

**MASTER:** The unit supplies the calibration OUT signal to the slave units.

**SLAVE:** The internal timer of the unit is supplied the calibration signal from the master.

## ● Set Time 108 SET TIME

This setting specifies the hour for the master unit to supply the Time Adjust OUT signal to the slave units once a day. You need not set the hour when SLAVE is selected. The slave unit accepts the signal through the IN terminal, and corrects its internal clock to the hour as far as the clock deviates within 15 minutes after or before the hour.

1. Move the cursor to SET TIME with the [▲] or [▼] button.
2. Select the desired time (00:00 to 23:00) with the JogDial.
3. Press the JogDial.

## ● Auto Erasing 109 AUTO ERASING

The redundant records on the disk can be erased every day at 24:00 mid night. Day numbers specified by this setting means that the records stored during the number of days from the present will be protected, while the older records than that of the protected day will be erased.

SYSTEM SETUP	
FWD/REW MODE	SKIP&PLAY
PASSWORD LOCK	OFF
ALL→	*****
OPERATION→	*****
KEYLOCK BUZZER	OFF
RESET PULSE	HIGH
TIME ADJUSTING	SLAVE
SET TIME→	9:00
AUTO ERASING	OFF

1. Move the cursor to AUTO ERASING with the [▲] or [▼] button.
2. Select the desired day number with the JogDial.

**OFF:** Auto erasing is not applied.

**1DAY:** Only today's records of 0:00 onward are protected. Records before 24:00 of yesterday are erased.

**2 to 10DAYS:** Records before the specified number of days are erased.

**14, 30, 45, 60, 90, 120, 150, 180DAYS:** Same as above.

### Notes:

- The day number includes today as 1 day, therefore 2DAYS counts today and yesterday in number.
- Auto Erasing is implemented at 24:00 mid night. Playing back will stop once when the time comes to 24:00, then will restart with different portion based on the renewed day count.

## ■ REC SETUP

Picture quality and field rate are selected as a set or individually.

### ● Recording Mode 201 REC MODE

Select one of the following 5 basic options: super fine (SF, level 10), fine (FQ, level 8), normal (NQ, level 7), long-time recording (EX, level 5) and optional (SP). If combined with audio (A) recording, the number or modes doubles as shown below. The selected recording mode determines the remaining recording time which is displayed on the monitor and on the LCD.

In the SP mode, the field rate and picture quality are variable and can be selected at option in the range of 0.1 to 12.5 fps and level 1 to 10, respectively. After the recording mode has been selected, the available time is calculated and displayed. "xxx" in the table is replaced with the calculated available time.

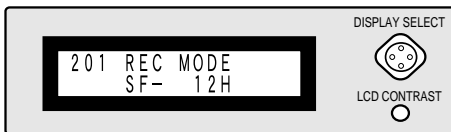
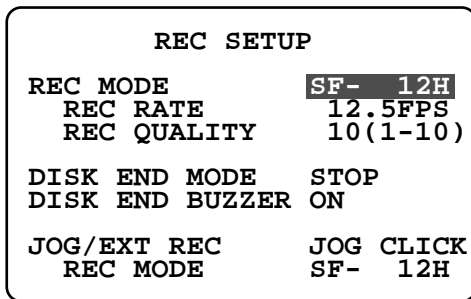

1. Move the cursor to REC MODE with the [▲] or [▼] button.
2. Select the desired mode with the JogDial.  
The default is SF-12H.

Rec Mode	Quality	Audio Record	Note
SF-xxxH	Super Fine (10)	N/A	
FQ-xxxH	Fine (8)	N/A	
NQ-xxxH	Normal (7)	N/A	
EX-xxxH	Long time (5)	N/A	
SF-AxxxH	Super Fine (10)	Available	
FQ-AxxxH	Fine (8)	Available	
NQ-AxxxH	Normal (7)	Available	
EX-AxxxH	Long time (5)	Available	
SP-AxxxH	Optional setup	Available	Field rate, quality selected optionally
SP-xxxH	Optional setup	N/A	Field rate, quality selected optionally

"xxx" in the table will be replaced by a calculated recording time of 6, 12, 18, 24, 48, 72, 96, 120, 170, 180, 240, 480 or 960 hours. "xxx" for SP is specified in REC MODE table in ADDENDUM attached to the manual.

### ● Recording Field Rate 202 REC RATE

The field rate or number of fields per second can be selected in SP mode. The higher the field rate, the more information the recording will contain.

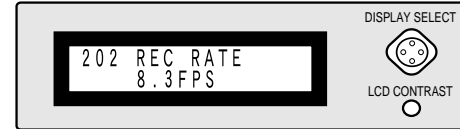
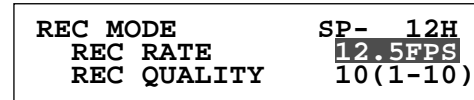

1. Move the cursor to REC RATE with the [▲] or [▼] button.
2. Select the desired rate (from **0.1FPS** to **12.5FPS**) with the JogDial. The default value is 12.5 fps.

### ● Recording Quality 203 REC QUALITY

A picture quality from level 1 to 10 can be selected in SP mode. The higher the level number, the better the picture quality will be.

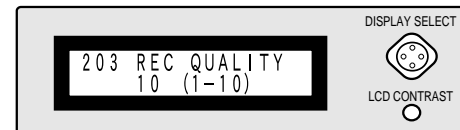
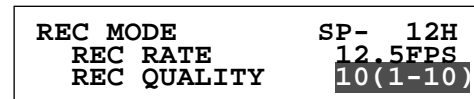

1. Move the cursor to REC QUALITY with the [▲] or [▼] button.
2. Select the desired quality (from level **1** to **10**) with the JogDial. The default value is level 10.



## ● Disk End Mode Setup 204 DISK END

The menu offers the following four options at the point where the available recording space on the disk is used up: **[STOP]**, **[CONTINUE]**, **[ALM CONTINUE]** and **[SERIES]**. See illustration for each sequence.

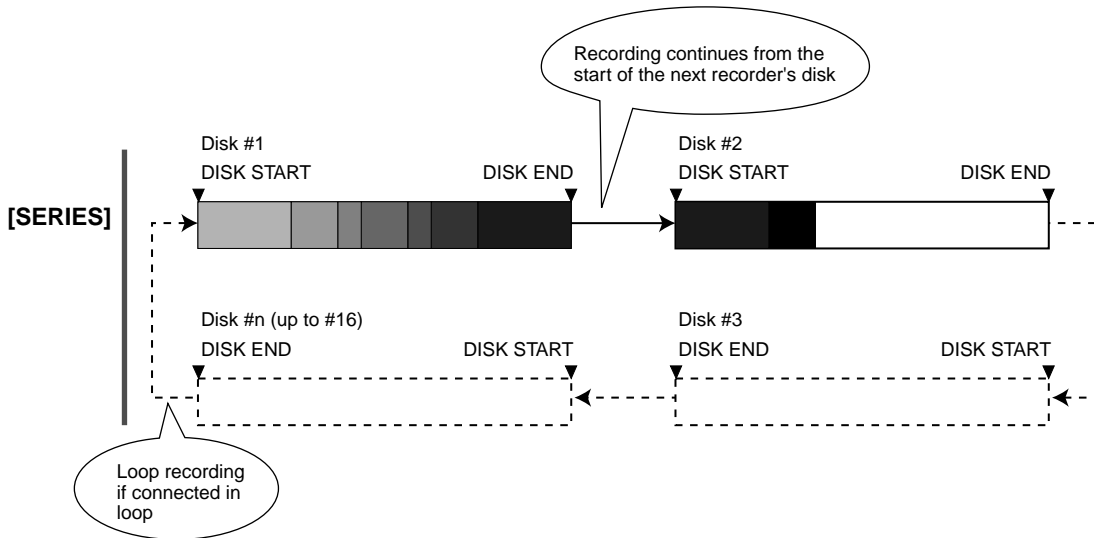
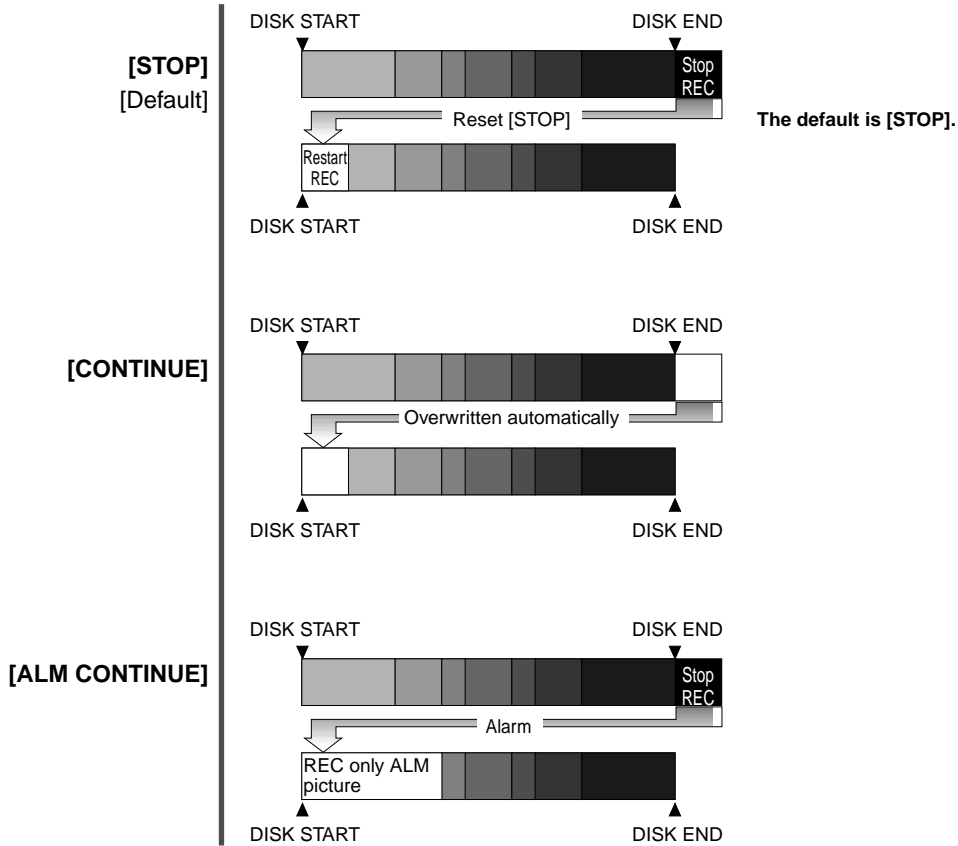

### Notes on SERIES connection

- See page 12 for physical connections.
- See SERIES RECORDING in APPENDIX for setup and operating procedures.

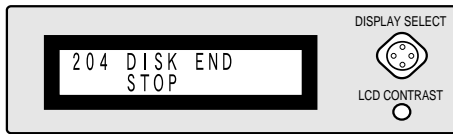
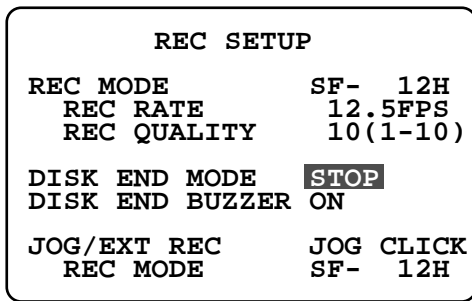

1. Move the cursor to DISK END MODE with the up [▲] or down [▼] button.
2. Rotate the JogDial to select the desired parameter. The default is STOP.

**[STOP]:** Stops recording until a mode other than [STOP] is selected.

**[CONTINUE]:** Old data is automatically overwritten from the disk start.

**[ALM CONTINUE]:** Recording is suspended until an alarm occurs. When an alarm occurs, alarm recording overwrites old data from the disk start.

**[SERIES]:** In series connection, new data is recorded from start to end of the next recorder's disk and so forth. In loop connection, new data continuously overwrites old data.

## ● Disk End Buzzer Setup 205 DISK END BUZZER

The buzzer can be set up to beep at the point where the disk is full (remaining space 0 %).

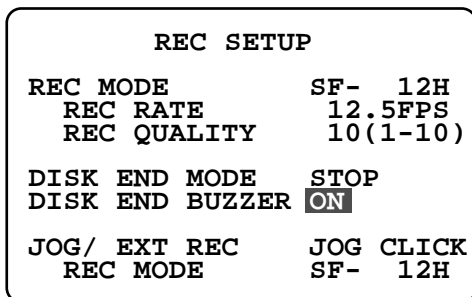

1. Move the cursor to DISK END BUZZER with the up [▲] or down [▼] button.
2. Rotate the JogDial to select the desired parameter. The default is ON.

**[ON]:** Enables the buzzer beep at the disk end (remaining space 0 %).

**[OFF]:** Disables the buzzer beep.

## ● Jog Click Terminal Definition 206 JOG/EXT REC

The JOG CLICK terminal on the rear panel is connected with an external switch. The switch is used either to remotely click the JogDial or to implement the preset mode for manual recording.

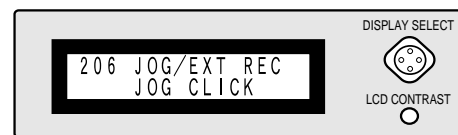
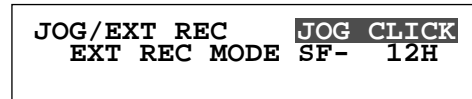

1. Move the cursor to the desired item with the [▲] or [▼] button.
2. Select the appropriate parameter by rotating the JogDial.

**JOG CLICK:** Turning on the external switch has the same effect as pressing the JogDial.

**EXT REC:** While the switch is turned on, the preset EXT REC mode is implemented.

## ● External Recording Mode 207 EXT REC MODE

Select the mode for manual recording after having set the JOG/EXT parameter to EXT REC.

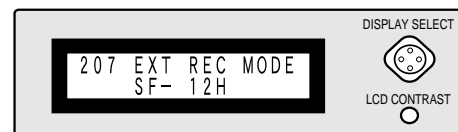
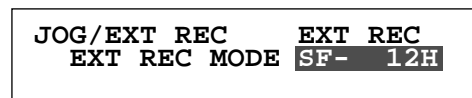

1. Move the cursor to EXT REC MODE with the [▲] or [▼] button.
2. Select the desired mode with the JogDial. Refer to page 24 for the recording mode parameters. The default value is SF-12H.

## ■ ALARM SETUP

The digital disk recorder accepts an alarm signal supplied from connected device such as a camera or camera site equipment. The recorder also generates an alarm signal itself when the preset motion detection activates.

Any alarm signal starts alarm recording with the preset recording mode, field rate and picture quality. Alarm recording stops when the preset time has elapsed, the [■ STOP] [SETUP/ESC] button on the front panel is pressed, or the alarm RESET IN is supplied from the connected device. The recorder outputs an alarm recovery signal from the rear panel.

### ● Alarm Recording Mode 301 REC MODE

ALARM SETUP	
REC MODE	SF- 12H
REC RATE	12.5FPS
REC QUALITY	10(1-10)
DURATION	10S
ALARM BUZZER	ON
VMD SETUP	OFF

This item specifies the recording mode to be applied exclusively to the sequence after an alarm input. The setting procedure and parameters are the same as for REC SETUP described earlier.

REC MODE	SF- 12H
REC RATE	12.5FPS
REC QUALITY	10(1-10)

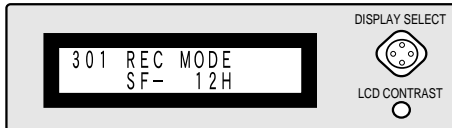

### ● Alarm Recording Duration 304 DURATION

This setting specifies the duration of alarm recording and related functions after an alarm input. Functions active during alarm recording are buzzer beeping, ALARM LED indication, "ALARM" status display, and the ALARM OUT signal.

DURATION	10S
ALARM BUZZER	ON
VMD SETUP	OFF

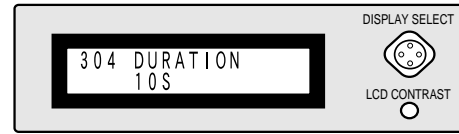

1. Move the cursor to DURATION with the [▲] or [▼] button.
2. Select the desired duration with the JogDial.  
The default value is 10 seconds.  
The unit will revert to the previous status when the time has elapsed.

**10S:** 10 seconds

**20S:** 20 seconds

**30S:** 30 seconds

**1M:** 1 minute

**2M:** 2 minutes

**3M:** 3 minutes

**6M:** 6 minutes

**MANUAL:** Recording continues for as long as there is alarm input or for at least 10 seconds, even if the alarm input turns off earlier.

**CONTINUE:** Recording continues until the stop button on the front panel is pressed, or the RESET IN signal is supplied.

**OFF:** Neither recording nor alarm logging is implemented.

### ● Alarm Buzzer 305 ALARM BUZZER

ALARM SETUP	
REC MODE	SF- 12H
REC RATE	12.5FPS
REC QUALITY	10(1-10)
DURATION	10S
ALARM BUZZER	ON
VMD SETUP	OFF



1. Move the cursor to ALARM BUZZER with the up [▲] or down [▼] button.

2. Rotate the JogDial to select ON or OFF.

**ON:** Buzzer beeps while alarm is active.

**OFF:** Buzzer does not beep.

## ● Motion Detector Setup 306 VMD SETUP

A VMD or Video Motion Detector senses changes in the video signals within a preset area and supplies alarm output. When a change is detected, the recorder starts recording. The detection sensitivity and area are selected on this menu.

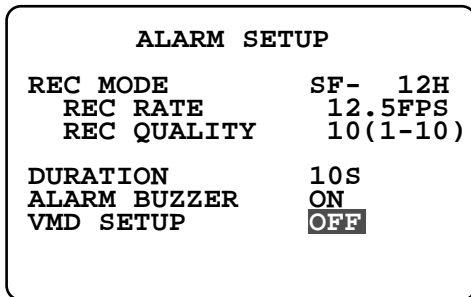

1. Move the cursor to VMD SETUP with the up [▲] or down [▼] button.
2. Rotate the JogDial to select the desired parameter, then press the JogDial. The default is OFF.

**[LOW 7]:** Low sensitivity motion detection is enabled.

**[MID 7]:** Medium sensitivity motion detection is enabled.

**[HIGH 7]:** High sensitivity motion detection is enabled.

**[OFF]:** Motion detection is disabled.

The area setup window appears with an asterisk when other than OFF is selected. The asterisk represents the upper-left or bottom-right of the detection area. The division lines are not actually displayed on the monitor.

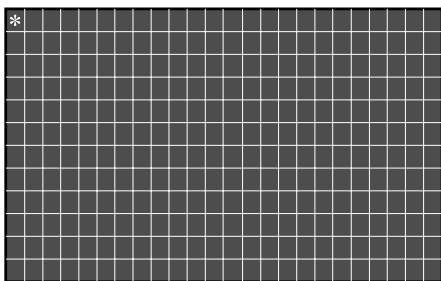

### Notes:

- VMD should be used with an ordinary camera input to the unit. Select [OFF] to avoid useless VMD when a video multiplexer or combination camera supplies the input to the unit.
- Make sure that the date and status displays are not located within the motion detection area on the monitor. Otherwise the motion detector could be misled.
- Set the ALARM SUSPEND to ON with the LCD button when VMD is unnecessarily activated during the VMD setup.
- VMD does not function while playing back.

3. Set the upper-left end of the detection area. Move the asterisk to the right or left with the JogDial, and up or down by pressing the up [▲] or down [▼] button.

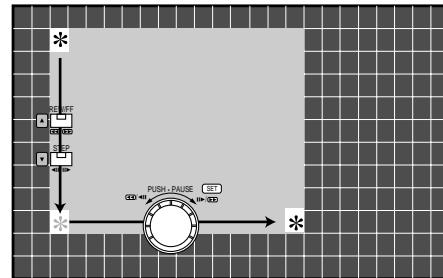

4. Press the JogDial to enter the upper-left end of the detection area. The asterisk position is highlighted.
5. Set the bottom-right end of the detection area similar to steps 3 and 4 above.
6. Press the JogDial. The area is highlighted. Up to 4 areas can be selected. These may partially overlap. Repeat steps 3 to 6 to select more areas. To unselect an area, move the cursor to the upper-left end of the area, and then press the JogDial.

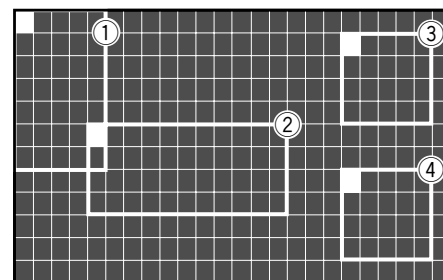

## INTERNAL TIMER REC

Reservations for recording are made in the INTERNAL TIMER REC window on a weekly or daily basis. The TIMER indicator lights on the front panel after a reservation has been made.

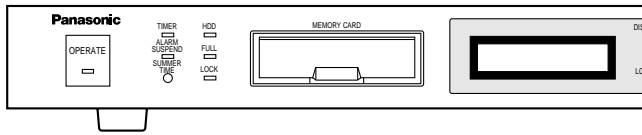

INTERNAL TIMER REC				
TIMER	START	END	T-M	
S ON→	8:00	8:20	SF-A	12
M OFF				
T ON→	12:00	8:00	SF-	12
W OFF				
T ON→	14:00	23:00	SF-	240
F OFF				
S ON→	12:00	18:00	FQ-A	24
D ON→	18:00	18:50	NQ-A	24

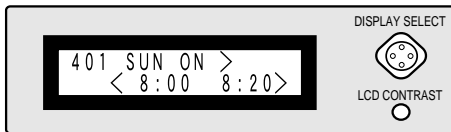

The column titles in the window denote the following:

- TIMER:** Stands for timer ON/OFF for a day of the week or a daily schedule. The default is OFF.
- START:** Stands for the start time of recording.
- END:** Stands for the end time of recording.
- T-M:** Stands for available time and recording mode.

The left end characters on each line represent the following.

- S:** Sunday
- M:** Monday
- T:** Tuesday
- W:** Wednesday
- T:** Thursday
- F:** Friday
- S:** Saturday
- D:** Daily

## Making Reservations

1. Move the cursor to the desired day line with the [▲] or [▼] button.  
Move the cursor to the D (bottom) line when a daily basis reservation is made.
2. Select an appropriate parameter (either ON or OFF for the first time) with the JogDial, then press it.  
The cursor moves to the next item position. Repeat the procedure to set START time, END time and recording mode setting.

TIMER	START	END	T-M	
S ON→	8:00	8:20	SF-A	12
M OFF				

3. Press the [SETUP/ESC] button to return the cursor to the TIMER position.

Repeat steps 1, 2 and 3 above until all applicable days are set.

After escaping from the setup, you can activate a reservation by operating the LED button. See page 34 for details.

## ■ COMMUNICATION SETUP

Communication parameters are set to match those of the connected devices and the system configuration.

COMMUNICATION SETUP	
PROTOCOL	<b>PS·DATA</b>
UNIT ADDRESS	1
BAUD RATE	9600
DATA BIT	8
PARITY CHECK	NONE
STOP BIT	1
WAIT TIME	OFF

PROTOCOL	<b>PS·DATA</b>
UNIT ADDRESS	1
BAUD RATE	9600
DATA BIT	8



1. Move the cursor to UNIT ADDRESS with the [▲] or [▼] button.
2. Select the address with the JogDial.  
The default value is 1.

From **1** to **96**: Set an address unique in the chain.

## ● Protocol 501 PROTOCOL

PROTOCOL	<b>PS·DATA</b>
UNIT ADDRESS	1
BAUD RATE	9600
DATA BIT	8
PARITY CHECK	NONE

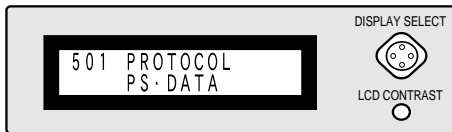

1. Move the cursor to PROTOCOL with the [▲] or [▼] button.
2. Select a suitable protocol with the JogDial.  
The default is PS·DATA.

**PS·DATA:** Select when the communication chain uses the PS·DATA protocol. This selection enables the DATA terminal on the rear panel for communication.

**VTR:** Select when other than PS·DATA is used.  
This selection enables the RS-232C terminal on the rear panel for communication.

**Note:** Parallel use of the DATA and RS-232C terminals is not possible.

## ● Unit Address 502 UNIT ADDRESS

The unit address can be set either from the setup menu on the monitor or using the DIP switch on the rear panel. The address setup with the DIP switch has priority over the setup on the monitor menu. Make certain to set DIP switches #1 through #4 to OFF before setting the unit address on the monitor.

## ● Baud Rate 503 BAUD RATE

UNIT ADDRESS	1
BAUD RATE	<b>9600</b>
DATA BIT	8
PARITY CHECK	NONE

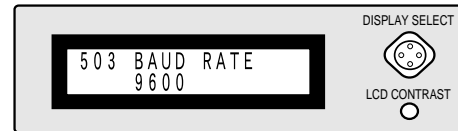

1. Move the cursor to BAUD RATE with the [▲] or [▼] button.
2. Select the rate with the JogDial.  
The default value is 9 600 bits per second.

**4800:** 4 800 bps  
**9600:** 9 600 bps  
**19200:** 19 200 bps

## ● Data Bit 504 DATA BIT

BAUD RATE	9600
DATA BIT	<b>8</b>
PARITY CHECK	NONE
STOP BIT	1



1. Move the cursor to DATA BIT with the [▲] or [▼] button.

- Select the bit length with the JogDial.  
The default value is 8 bits.

- 7:** 7 bits
- 8:** 8 bits; select 8 when using the PS·DATA protocol.

## ● Parity Check 505 PARITY CHECK

DATA BIT	8
PARITY CHECK	<b>NONE</b>
STOP BIT	1
WAIT TIME	OFF



- Move the cursor to PARITY CHECK with the [▲] or [▼] button.
- Select the check mode with the JogDial.  
The default is NONE.

- NONE:** No parity check
- EVEN:** Even parity
- ODD:** Odd parity

## ● Stop Bit 506 STOP BIT

DATA BIT	8
PARITY CHECK	NONE
STOP BIT	<b>1</b>
WAIT TIME	OFF



- Move the cursor to STOP BIT with the [▲] or [▼] button.
- Select the number of stop bits with the JogDial.  
The default is 1.

- 1:** 1 bit
- 2:** 2 bits

## ● Wait Time 507 WAIT TIME

The unit retransmits data after waiting the specified time if there is no response from the connected device. The default is OFF.

DATA BIT	8
PARITY CHECK	NONE
STOP BIT	1
WAIT TIME	<b>OFF</b>



- Move the cursor to WAIT TIME with the [▲] or [▼] button.
- Select the waiting time with the JogDial. The default is OFF.

- OFF** : Retransmission is disabled.
- 100 MS**: 100 m seconds
- 200 MS**: 200 m seconds
- 1 S** : 1 second

## ■ SYSTEM INFORMATION

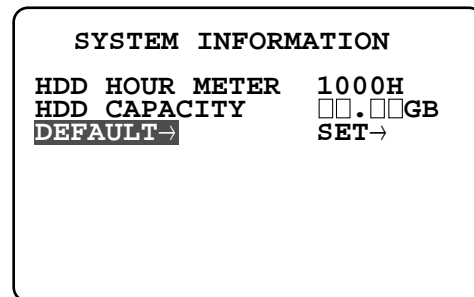

In the SYSTEM INFORMATION window, HDD HOUR METER shows how many hours the digital hard disk recorder has been operated in Playback, Recording and Idle. The built-in HDD needs replacement when the hour meter reads around 30 000 H. HDD CAPACITY indicates the total usable capacity of the built-in hard disk. DEFAULT enables the recorder to restore all setup data to the default values. See page 18 for details.

# OPERATING PROCEDURES

## ■ Sequence of LCD Displays (in operation)

There are about 30 LCD screens provided for operating the WJ-HD100. The sequence in which these screens appear is shown below. The uppermost LCD screens appear when the respective buttons are pressed on the front panel; for example the [■ STOP], [● REC] or [B PLAY] button; or alarm recording is triggered by activation of the connected sensor or built-in VMD (Video Motion Detector).

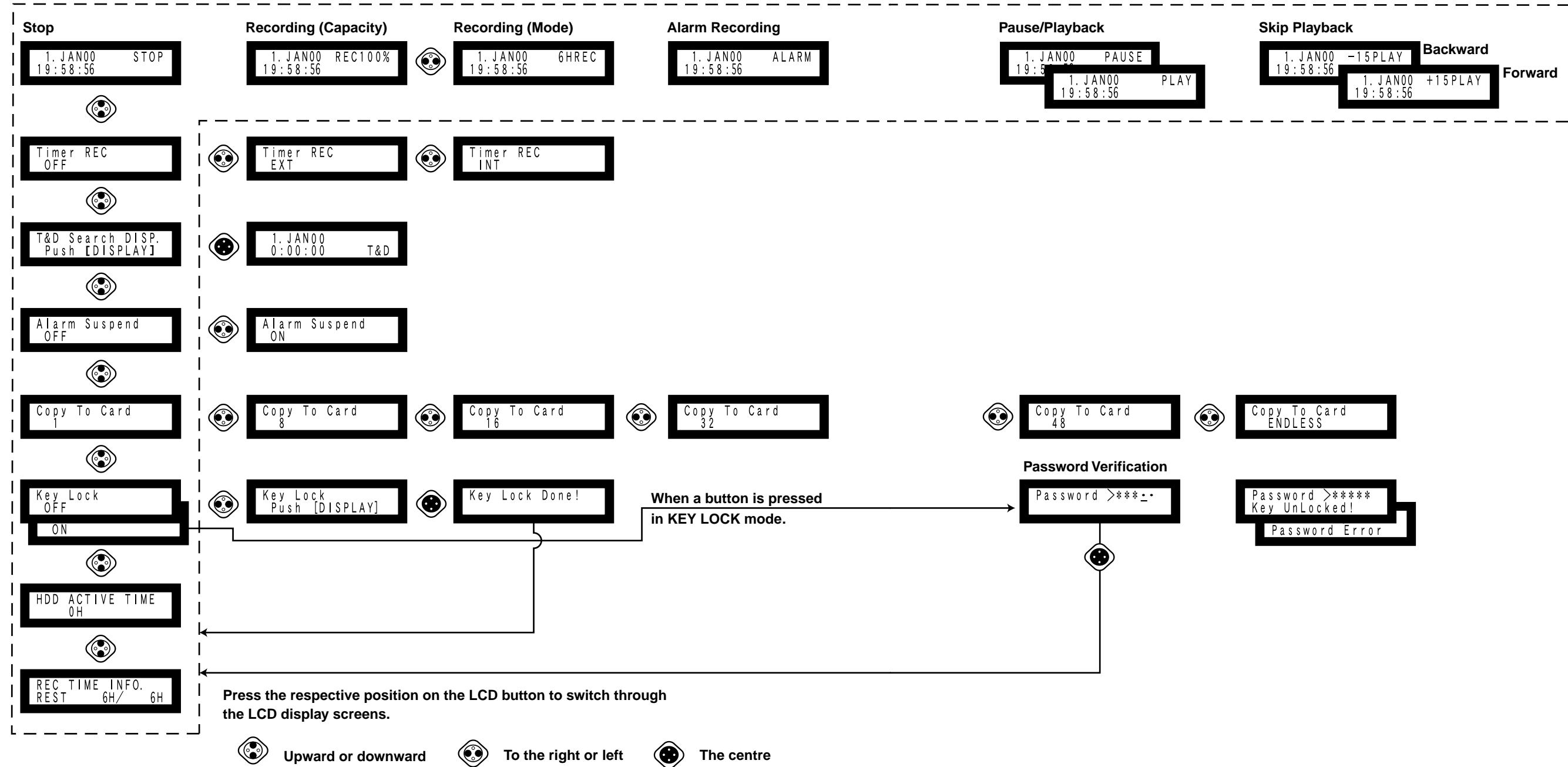



## ■ Recording

### ● Manual Recording

Recording is possible at any time except during the setup operation. The video supplied to the input terminal is recorded with the recording mode, field rate and picture quality preset in the REC SETUP menu.

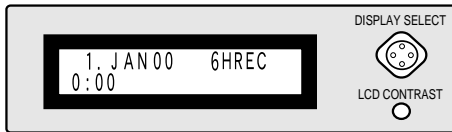
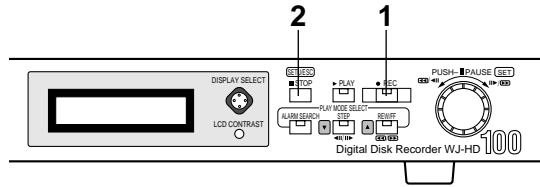

1. Press the **[● REC]** button to start recording.
2. Press the **[■ STOP]** button to stop recording.

Press the LCD button to the right or left to toggle between the mode and capacity displays. The displays change both on the LCD and on the monitor while recording.

Press the LCD button upward or downward to display the [REC TIME INFO.]. The remaining time and the total available recording time are displayed on the LCD.

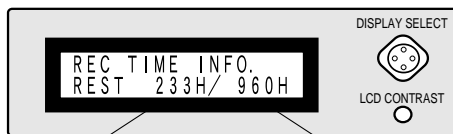

Remaining available time    Total available recording time

### ● Internal Timer Recording

Internal timer recording begins when the reserved start time comes, and continues until the reserved end time comes. The reservations are made in the INTERNAL TIMER REC menu (page 29).

1. Press the LCD button downward to display [Timer REC] on the LCD.
2. Press the LCD button to the right or left to select [INT], [EXT] or [OFF]. The default value is OFF.

**[OFF]:** Reservations are made but not implemented.

**[INT]:** The internal timer triggers recording at the reserved times.

**[EXT]:** Enables power-on recording with the use of an external timer switch. Power-on recording is detailed as follows.

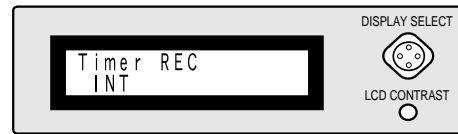

**Note:** A reserved recording will interrupt playback and start at the reserved start time.

### ● Power-on Recording

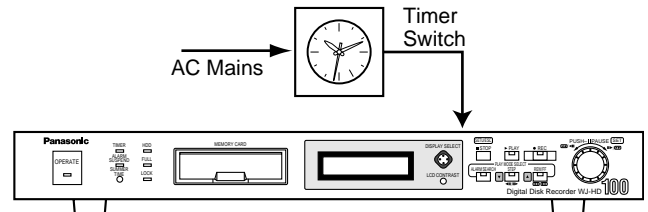

For power-on recording select [EXT] in the above procedures with the LCD button. This enables the unit to start recording every day at a specific time with use of a timer switch that controls the AC mains supplied to the unit. Make certain to keep the POWER switch on the rear of the unit set to ON.

**Note:** When [EXT] is selected for power-on recording, reserved recording is disabled.

### ● Alarm Recording

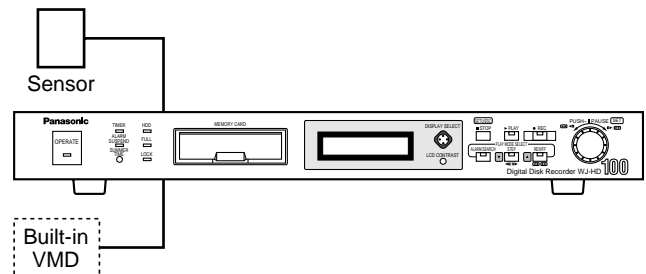

Alarm recording starts when an externally connected sensor is turned on, or the built-in VMD (Video Motion Detector) is activated.

Alarm recording stops depending on the settings made in the ALARM SETUP menu as follows:

- If DURATION is selected, recording stops when the preset time has elapsed.
- If MANUAL is selected, recording stops when the alarm input turns off.
- If CONTINUE is selected, recording stops when the [■ STOP] button is pressed.

You may need to press the [■ STOP] button on the front panel to stop alarm recording as the case may be. DURATION and VMD are preset in the ALARM SETUP menu (page 27).

## ■ Playback

### Notes:

- Alarm recording will interrupt playback in any mode. If acceptable, set ALARM SUSPEND to ON with the LCD button. See page 38 for details.
- Operation of the [B PLAY] button will be ignored if the disk is empty, for instance, when the recorder is used for the very first time or right after formatting of the disk.
- The latest recorded image is displayed on the monitor right after recording finishes. Search for the desired image by skip playback before starting playback.

## ● Normal Playback

The pictures recorded on the disk are played back sequentially.

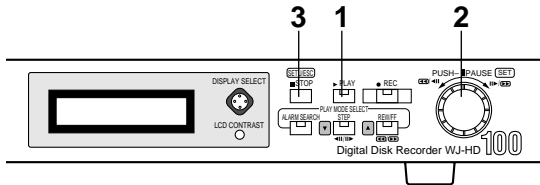

1. Press the [B PLAY] button to start playback.
2. Press the JogDial [■ PAUSE] to pause and to restart playback.
3. Press the [■ STOP] button to stop playback.

## ● Skip Playback

Picture search is available in quick forward and backward playback. The monitor and LCD display the skip speed as [\*06PLAY], [08PLAY] and so forth. The asterisk indicates that images are played back continuously without skipping.

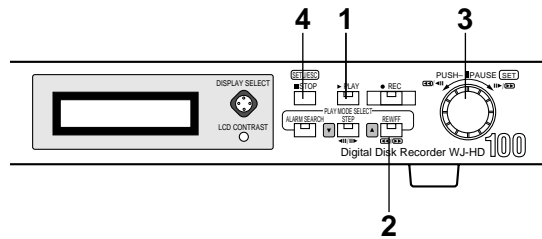
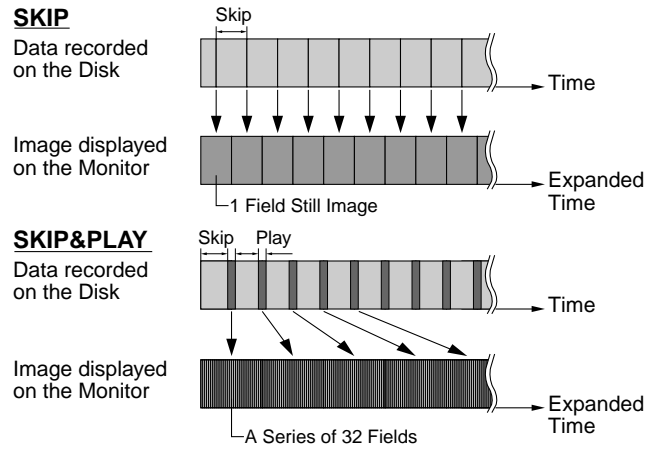

1. Press the [B PLAY] button to start playback.
2. Press the [REW/FF] button to start skip playback. The LED lights.
3. Rotate the JogDial clockwise to move forward in the recording (FF) or counter-clockwise to move backward (REW). The more turns you rotate the JogDial, the faster the pictures will change.
4. Press the [■ STOP] button to stop playback.

**Note:** SKIP may not perform perfectly when a video multiplexer is installed in the system.

## ● Step Playback

A minute search is made for a desired picture by displaying pictures field by field.

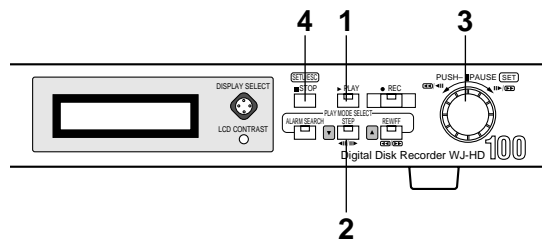

1. Press the [B PLAY] button to start playback.
2. Press the [STEP A/II/B] button to start step playback. The LED lights.

3. Rotate the JogDial clockwise to advance to the next later field or counter-clockwise to rewind to the next older.
4. Press the [■ STOP] button to stop playback.

## ● Playback Oldest/Latest Record

The oldest or latest record is played back. Procedures for the latest record are enclosed in parentheses).

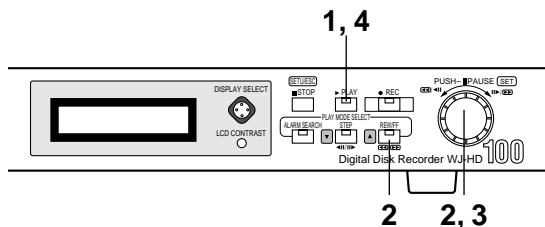

1. Press the [B PLAY] button.
2. Press the [REW/FF ◀▶▶▶] button, then rotate the JogDial counter-clockwise (clockwise). The LED lights, and REW (FF) mode starts.
3. Press the JogDial for 2 seconds. The oldest (latest) record is retrieved.
4. Press the [B PLAY] button. The oldest record starts playing back. The latest record will be kept in pause.

## ● Time & Date Search

A picture record of a specified time and date is played back.

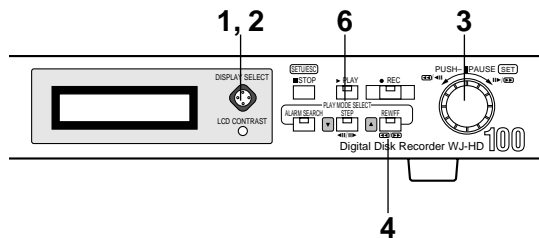
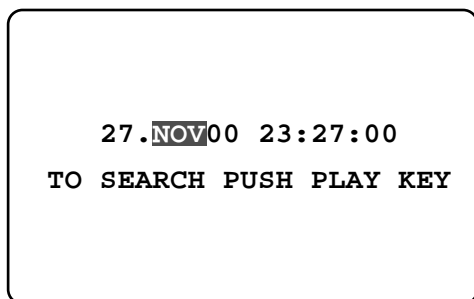
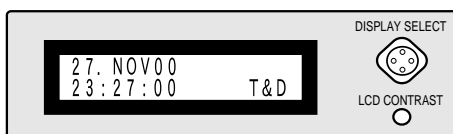

1. Press the LCD button downward to display [T&D Search DISP.].
2. Press the LCD button centre. Time and date appear both on the LCD and monitor.
3. Select an appropriate parameter (day for the first) with the JogDial or the LCD button.
4. Press the up [▲] button or the LCD button to the right. The cursor on the monitor moves to the next digits.
5. Repeat the above steps 3 and 4 for month, year, time, minute and second.
6. Press the [B PLAY] button. The record with the specified date and time is played back.

### Notes:

- If a record with the specified time and date was not found, the next closest record is played back.
- Time & date search is disabled while recording.

## ● Alarm Record Search

Alarm records are searched while viewing them on the monitor as follows.

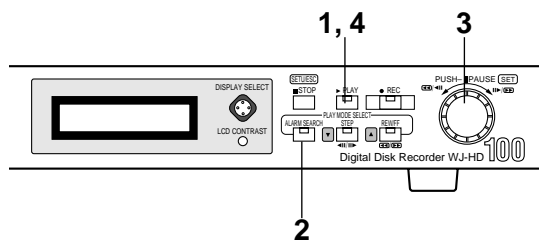

1. Press the [B PLAY] button.
2. Press the [ALARM SEARCH] button. The LED lights.
3. Rotate the JogDial one click to the right or left. The display advances to the next later or next older frame in the alarm records. Repeat until the desired alarm picture appears on the monitor.

4. Press the [B PLAY] button to play it back.

**Note:** Make certain to rotate the JogDial one click at a time.

## ● Alarm History Search

ALARM RECALL 1 OF 10			
NO	DATE	TIME	ALM
99	9.JUN00	00:00:00	* T
98	1.JUN00	02:34:56	T
97	1.JUN00	01:10:01	* V
96	31.MAY00	23:34:45	V
95	30.MAY00	02:00:20	* T
94	14.MAY00	05:30:31	* T
93	7.MAY00	23:00:59	T
92	6.MAY00	22:05:50	V
91	14.APR00	23:00:59	* T
90	14.APR00	16:06:34	* V

**T:** Alarm terminal was activated.

**V:** VMD was activated.

**Asterisk \*:** Corresponding alarm picture is recorded on the disk.

**No asterisk:** Alarm was logged, but no picture was recorded.

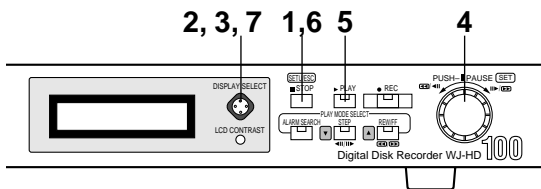

1. Press the [■ STOP] button.
2. Press the LCD button downward to display the date and time on the LCD.
3. Hold down the LCD button centre for 2 seconds.  
The monitor displays the ALARM RECALL list. The line highlighted on the monitor is also displayed on the LCD.
4. Select the desired alarm event by rotating the JogDial or pressing the up [▲] and down [▼] buttons.
5. Press the [B PLAY] button. The searched picture is played back.
6. Press the [■ STOP] button to stop playback.  
ALARM RECALL appears on the monitor.
7. Hold down the LCD button centre for 2 seconds to quit alarm history search.

# Alarm Operation

## Suspending Alarm Input

Suspending the alarm function may be convenient during setup procedures or when alarm recording is not needed. In ON position, any alarm input is ignored and the recorder performs as follows:

- The alarm event will be logged in the alarm history.
- The recorder does not enter alarm recording.
- The alarm buzzer does not sound.
- The ALARM SUSPEND indicator lights.

1. Press the LCD button downward to display [Alarm Suspend] on the LCD.

2. Select either ON or OFF by pressing the LCD button to the right or left.

**ON:** Alarm input is suspended.

**OFF:** Suspension is reset.

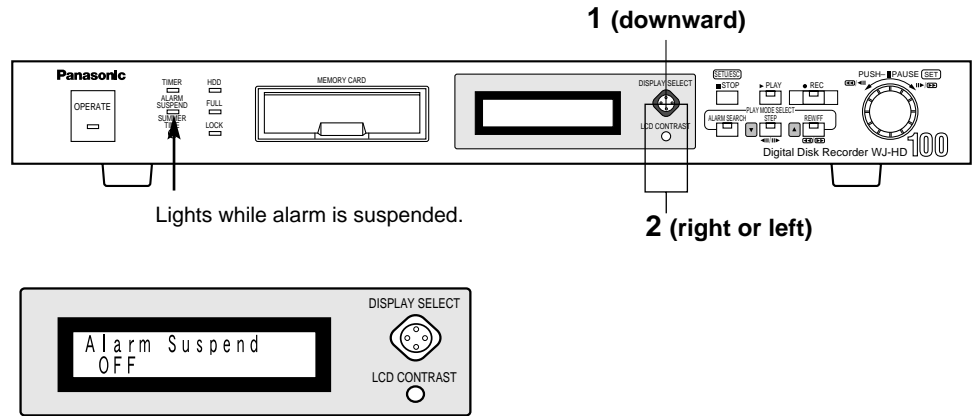

## Alarm History Search

The alarm history is listed on the monitor in chronological order with event number, date, time, availability of recorded picture, and the activation source.

ALARM RECALL 1 OF 10				
NO	DATE	TIME	ALM	
99	9.JUN00	00:00:00	*	T
98	1.JUN00	02:34:56		T
97	1.JUN00	01:10:01	*	V
96	31.MAY00	23:34:45		V
95	30.MAY00	02:00:20	*	T
94	14.MAY00	05:30:31	*	T
93	7.MAY00	23:00:59		T
92	6.MAY00	22:05:50		V
91	14.APR00	23:00:59	*	T
90	14.APR00	16:06:34	*	V

ALARM RECALL 10 OF 10				
NO	DATE	TIME	ALM	
4	20.FEB00	00:00:00	*	T
3	11.FEB00	02:34:56		T
2	15.JAN00	01:10:01	*	V
1	1.JAN00	23:34:45		V
PUSH JOG→ DATA CLEAR				

**T:** Alarm terminal was activated.

**V:** VMD was activated.

**Asterisk \*:** Corresponding alarm picture is recorded on the disk.

**No asterisk:** No picture is available.

### To browse through the history

1. Hold down the LCD button centre for 2 seconds. The monitor displays the ALARM RECALL list. The line highlighted on the monitor is also displayed on the LCD.
2. Rotate the JogDial to scroll up or down the list.
3. Hold down the LCD button centre for 2 seconds to go back to the previous status.

### To search for playback

1. Select the desired alarm event by rotating the JogDial.
2. Press the [B PLAY] button to play back the recorded picture. The LED lights. The ALARM RECALL list disappears.
3. Press the [■ STOP] button to stop playback. The ALARM RECALL List appears on the monitor.
4. Hold down the LCD button centre for 2 seconds to quit alarm history search.

### To erase the stored history

1. Move the cursor to "PUSH JOG→DATA CLEAR", then press the JogDial. All alarm event records on the list are erased.
 

**Note:** You can access the pictures recorded on the disk by time & date search after the erasure.

**Note:** In some cases the log displayed in the ALARM RECALL list may apply to the previous alarm record that was overwritten after selecting CONTINUE for the DISK END MODE. This is because the alarm history is updated later than the image data.

## ● Resetting Alarm

The activated alarm is reset by any of the inputs below.

- The preset time has elapsed.
- The [■ STOP] button on the front panel is pressed.
- The alarm reset signal is supplied from the connected device.

Resetting changes the status of the recorder as follows:

- The recorder stops alarm recording.
- The buzzer, if activated, stops beeping.
- The recorder outputs an alarm recovery signal from the rear panel.
- The Alarm Out signal on the rear panel is reset.

## ■ Copy to CompactFlash Card

The pictures recorded on the hard disk can be copied to a CompactFlash card for browsing on a personal computer. The picture quality depends on the card capacity and the quality in which the pictures were recorded.

The following card brand proved to be suitable in tests carried out at Panasonic:

Manufacturer	Capacity (in MB)
SanDisk	32, 48, 64, 96, 128, 160, 192

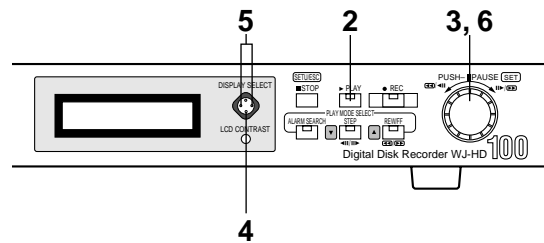
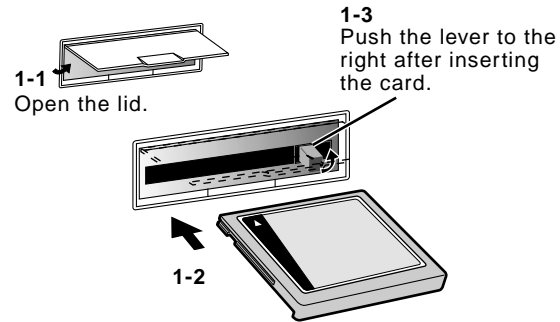

1. Insert a CompactFlash card.
  - 1-1 Open the card lid.
  - 1-2 Place a CompactFlash card into the slot.  
The card must be formatted for Windows 95 or Windows 98. Do not reverse the card when inserting.
  - 1-3 Make certain to push the lever to the right after inserting the card.
2. Display the desired picture on the monitor.  
Refer to Skip Playback and Step Playback on page 35 for search operations.
3. Press the JogDial to freeze the image just a few fields prior to where you wish to start copying.
4. Press the LCD button downward to display [Copy To Card].

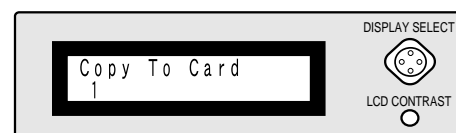

5. Press the LCD button to the right or left to specify the number of pictures to be copied.

- 1:** The picture frozen on the monitor is copied to the card.
- 8:** 8 pictures are copied.
- 16:** 16 pictures are copied.
- 32:** 32 pictures are copied.
- 48:** 48 pictures are copied.
- ENDLESS:** Pictures are copied until the card is full.

6. Press the JogDial for 2 seconds to start copying.

The monitor displays the picture that is being copied while the LCD indicates "Now Copying Data".

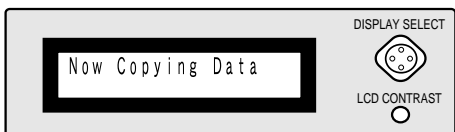

"Finished !" appears on the LCD when copying ends.

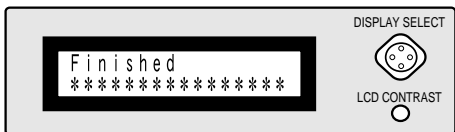

Replace with a new card when "Data Full" appears on the LCD, then repeat step 6.

7. Pull the card out from the slot as follows.

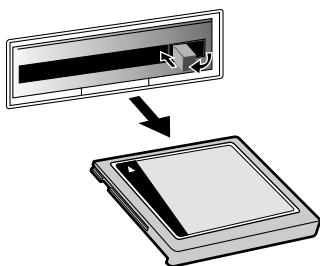

- 7-1 Pull out the lever.
- 7-2 Press the lever.

## ● Folders and Files

In each COPY TO CARD operation, a folder with a 6-digit name is created on the card, for example, 000001, 000002 and so forth. A folder contains files having the [.jpg] or [.htm] extension as shown below.

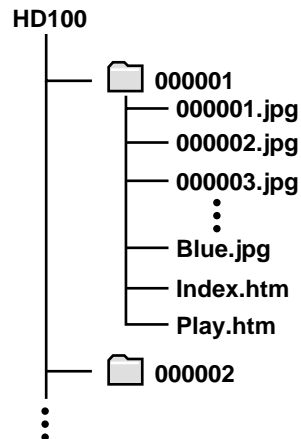

**HD100:** Root directory of the card

**000001:** Folder name

**000001.jpg to nnnnnn.jpg:** Copied picture files.  
The number of pictures is specified by operating the LCD button. "nnnnnn" is a 6-digit number.

**Blue.jpg:** A JPEG file to display a dummy screen when no picture is selected.

**Index.htm:** An HTML file to display thumbnails.

**Play.htm:** An HTML file to display copied pictures in order.

**000002:** Folder name

### Notes:

- Avoid overwriting!  
Back up any data contained on the card to which you want to copy the data from the WJ-HD100. The WJ-HD100 will overwrite any existing folders and their contents if their names coincide with those reserved for use by the WJ-HD100, for example, 000001 or 000002.
- Field deviations may take place between the displayed pictures on the monitor and the ones recorded on the card. When this happens, connect the video monitor directly with the WJ-HD100, not with the PLAY OUT of the video multiplexer.
- Use a browser software on the personal computer that is compatible with HTML version 4.0 or later.

## ■ Lock/Unlock Buttons

### ● Password Verification

The password prompt is displayed on the LCD and on the monitor when a locked button is pressed.

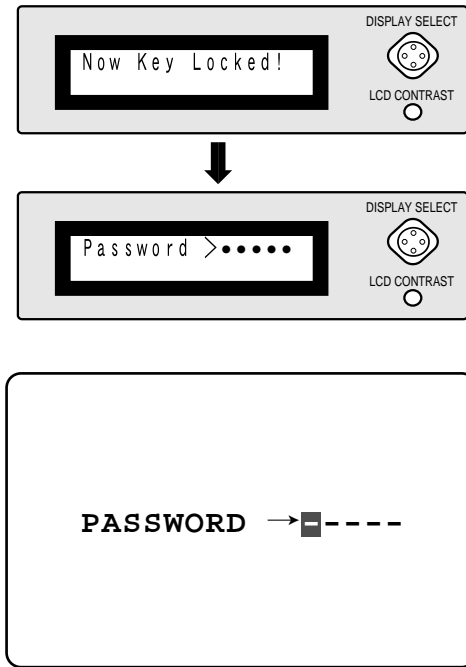

1. Enter your password with the JogDial while listening to the number of beeps because the password is hidden on the LCD or monitor. The rules are as follows:
  - Each password has an invisible leading "0".
  - 2 beeps stand for "2" when turning the JogDial clockwise.
  - 2 beeps stand for "0" when turning the JogDial counter-clockwise.
  - Turning the JogDial further counter-clockwise beyond "0", or clockwise from "9" will have no effect.
2. Press the JogDial to move the cursor to the next digit.
3. Repeat steps 1 and 2 for the remaining digits. The recorder allows access to the front panel controls if the correct password is entered and a button operation takes place within 5 minutes of password entry.

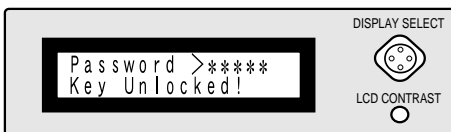

Try again when Password Error appears on the LCD, or press the LCD button to quit password verification.

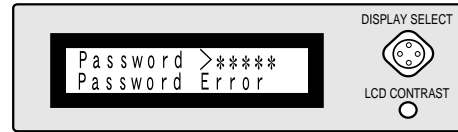

### ● Enabling Button Lock

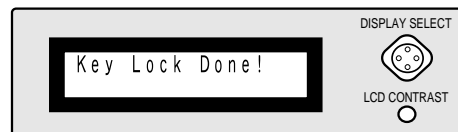
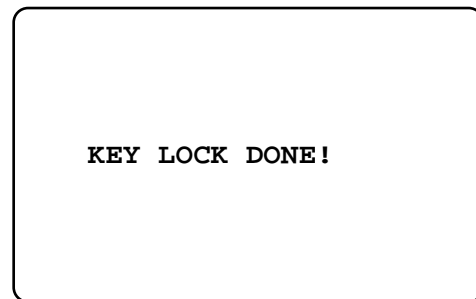
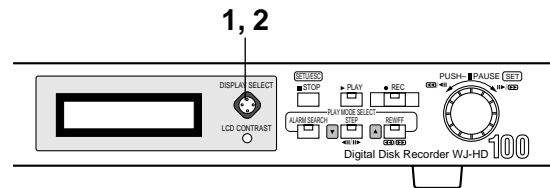

1. Press the LCD button downward to display [Key Lock] on the LCD.
2. Press the LCD button to the right or left to display "PUSH [DISPLAY]" on the LCD, then press the LCD button centre. This enables button lock mode.

**Note:** Set PASSWORD LOCK to OFF if you do not want the recorder to revert to button lock mode when no operation takes place within 5 minutes. See page 22 for details on PASSWORD LOCK.



# TROUBLESHOOTING

Phenomenon	Cause	What to do
The pictures copied to the CompactFlash card are not the ones displayed on the monitor.	The monitor receives the multiscreen-out signal from the video multiplexer.	Connect the video monitor directly with the WJ-HD100.
Setup menus supplied from the Matrix Switcher cannot be recorded.	The WJ-HD100 does not record non-interlace video.	
The recorded channel # differs from the original supplied from the video multiplexer.	This may happen when the video multiplexer is connected with CAMERA SW OUT, and the field rate is set to 10 fps or faster.	Set the field rate to 6.2 fps or slower.
VMD does not function.	VMD does not function in playback.	Stop playback.
T & D or status display is pushed out of the display range on the monitor.	This may happen with some monitors.	Adjust the scan size of the video monitor.
The bottom portion of the playback picture on the monitor is darker.	This may happen with some monitors, WJ-HD100 records up to 280H per field.	
Error message appears saying "TEMPERATURE ERROR SYSTEM STOPPED".	Ventilation is blocked.	Remove obstacles placed near ventilation openings and the fan.
	Failure of cooling fan	Contact your dealer for replacement of the fan.
Alarm recording does not function in a system including a video multiplexer.	The ALARM IN signal has the wrong polarity for the WJ-HD100.	Set the ALARM OUT switch (SW3) inside the video multiplexer to O.C. referring to the manual.

# SPECIFICATIONS

## General

Required Power:	220 - 240 V AC 50 Hz
Power Consumption:	22 W
Operating Temperature:	+5°C to +45°C (41°F to 113°F)
Dimensions:	420 mm (W) x 44 mm (H) x 350 mm (D), excluding rubber feet 16-9/16" x 1-3/4" x 13-13/16"
Weight:	5.2 kg (2.4 lbs)

## Input

Video Input:	Composite video or data multiplexed, 1 V[p-p], 75 $\Omega$ auto-termination, BNC
Audio Input:	-10 dBV, 10 k $\Omega$ , unbalanced, RCA pinjack
Alarm Input:	Non-voltage make contact, 100 ms or longer, terminal
Alarm Reset Input:	Non-voltage make contact, 100 ms or longer, terminal
Time Adjust Input:	Non-voltage make contact, 100 ms or longer, terminal
Series Recording Input:	Non-voltage make contact, 100 ms or longer, terminal
Alarm Recall Input:	Non-voltage make contact, 100 ms or longer, terminal
Remote Control Input:	REC, PLAY, STOP (SETUP), REW/FF, STEP, ALARM SEARCH, JOG-RIGHT, JOG-LEFT, JOG-CLICK (EXT REC): Non-voltage make contact, 100 ms or longer, terminal

## Output

Monitor Output:	Composite video, 1 V[p-p], 75 $\Omega$ , BNC
Video Output:	Looped through, BNC
Audio Output:	-10 dBV, 600 $\Omega$ , unbalanced, RCA pinjack
Camera Switching Output:	Open-collector, MAX 12 V DC 100 mA, RCA pinjack
Alarm Output:	Low-active (open-collector, MAX DC 24 V 100 mA)/High-active (12 V DC, 220 $\Omega$ ) switchable, terminal
Alarm Recover Output:	Low-active (open-collector, MAX 24 V DC 100 mA)/High-active (5 V DC, 220 $\Omega$ ) switchable, terminal
Recording Status Output:	Open-collector, MAX 24 V DC 100 mA, terminal
Playback Status Output:	Open-collector, MAX 24 V DC 100 mA, terminal
Time Adjust Output:	Open-collector, MAX 24 V DC 100 mA, terminal
Disk End Status Output:	Open-collector, MAX 24 V DC 100 mA, terminal
Auto OFF Output:	Open-collector, MAX 24 V DC 100 mA, terminal
Series Recording Output:	Open-collector, MAX 24 V DC 100 mA, terminal

## Serial Interface

RS-232C:	9-pin D-Sub
RS-485:	PS-Data protocol, Modular-6

## Alarm Function

Alarm Buzzer:	ON/OFF
Alarm Reset:	Auto reset/manual reset
Alarm Suspension:	ON/OFF
Button Lock Buzzer:	ON/OFF













































































## Standard Accessories

Rack Mounting Bracket:	2 pcs.
Fixing Screw (M3x10):	6 pcs.

Dimensions and weight are approximate.  
Specifications are subject to change without notice.

## Remote Control From System Controller

A system controller having PS·Data capability can control the WJ-HD100. The table compares operations of the WJ-HD100 and of the system controller WV-CU360. Make certain that the protocol selection for the WJ-HD100 is set to PS·Data.

Item	WJ-HD100	WV-CU360	Note
To Show/Hide SETUP MENU	Hold down  2 seconds	Hold down  2 seconds	Button lock is released automatically by opening the setup menu.
Setup Item Selection	 	 	
Parameter Selection		 	
To Move Cursor Back A Step			
To Show/Hide Alarm History	Operate LCD Button.	 → 	
To Search Alarm History		 	
To Play/Stop Selected Alarm Record	 	 	
Recording		 →  → 	
Stop		 →  → 	
To Stop Playback		 →  → 	Exclusive use to stop playback.
To Stop Recording		 →   → 	Exclusive use to stop recording.
Playback		 →  → 	
Pause		 →  → 	
Step Playback FWD.	 → 	 →  → 	
Step Playback REW.	 → 	 →  → 	
Skip Playback FWD.	 → 	 →   → 	
Skip Playback REW.	 → 	 →   → 	
Jump to Latest.	 →  → Press JogDial	 →  → 	The top of the latest record will be accessed.
Jump to Oldest.	 →  → Press JogDial	 →  → 	The top of the oldest record will be accessed.

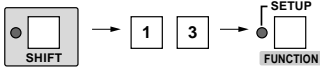
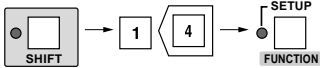
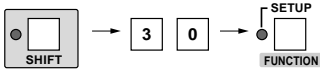
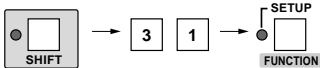
Item	WJ-HD100	WV-CU360	Note
SUMMER TIME			
Timer REC Mode Selection	Operate LCD Button.		OFF, INT or EXT selectable
Button Lock OFF	Operate LCD Button.		
Button Lock ON	Operate LCD Button.		

## ■ SERIES RECORDING

More than one Digital Disk recorder (unit) can be connected in series to increase the total disk capacity. Recording continues from the start of the next recorder's disk when the recording unit reaches its disk end. There are two ways of series recording: loop connection recording and series connection recording. Refer to page 12 and 13 of the Operating Instructions for connections.

**Loop Connection:** Recording continues endlessly.

**Series Connection:** Recording continues until the final unit reaches its disk end.

Recording starts and stops as described below.

**Manual:** Pressing the REC and STOP button will start and end recording.

**Internal Timer:** Recording starts and ends according to the preset START and END time.

### Notes:

- Alarm recording interrupts loop or series recording for the preset DURATION if the connected sensor or VMD on the current unit turns on. The unit reverts to loop or series recording after the duration.
- Alarm recording is carried out on a unit basis. The next unit will not continue alarm recording even when recording on the previous unit has ended before the duration has elapsed.

## ● Loop Connection Recording

### Setup

You need to set up each unit on the individual setup menu, because the settings made for one unit will not affect the other units.

1. Set DISK END MODE to SERIES for all units in each setup menu. (See page 25.)
2. Set INTERNAL TIMER REC for all units in each setup menu if you wish to preset specific times (See page 29). Skip this step if you are not using the timer function.
3. Close all setup menus.

### Operating Procedures

1. Enter the prompt mode.

The FULL indicators on all units will light when the setup menu is closed or the power is turned on right after the setup. At the same time the monitor displays a blinking "HDD FULL" message to prompt you to designate the first unit.

2. Escape from the prompt mode on the first unit.

Press the STOP button on the unit you wish to begin recording. The FULL indicator on the unit will go off, indicating that the unit is operable, and the prompt mode is released. The other FULL indicators will remain on. This indicates that the other units are still in the prompt mode waiting for activation of the SERIES IN signal on the rear panel.

**Note:** When the unit is full the FULL indicator does not go off even though the STOP button is pressed. If this happens enter REC SETUP and select other than SERIES for DISK END MODE, then close the setup menu. Reopen the REC SETUP and select SERIES, then close the setup menu. Try again to press the STOP button.

3. To start recording

- If manual operation is selected, press the REC button on the first unit to start recording.
- If internal timer is selected, press the LCD button downward to display [Timer REC] on the LCD. Then press the LCD button to the right or left to display [INT]. The TIMER indicator lights on the front panel. The unit starts recording at the preset START time.

4. To stop recording

- If manual operation is selected, press the STOP button on the current unit.
- If internal timer is selected, the unit stops recording at the preset END time.

The next unit will start recording when the current unit reaches its disk end. The FULL indicator of the current unit turns on and that of the next unit turns off.

The first unit will restart recording when the final unit reaches its disk end, and so on.

## ● Series Connection Recording

### Setup

1. Set DISK END MODE to STOP for the first unit, and to SERIES for other units in each setup menu. (See page 25)
2. Set INTERNAL TIMER REC for all units in each setup menu if you wish to preset specific times (See page 29). Skip this step if you are not using the timer function.
3. Close all setup menus.

### Operating Procedures

1. To start recording

- If manual operation is selected, press the REC button on the first unit to start recording.
- If internal timer is selected, press the LCD button downward to display [Timer REC] on the LCD. Then press the LCD button to the right or left to display [INT]. The TIMER indicator lights on the front panel. The unit starts recording at the preset START time.

2. To stop recording

- If manual operation is selected, press the STOP button on the current unit.
- If internal timer is selected, the unit stops recording at the preset END time.

The next unit will start recording when the current unit reaches its disk end. Recording ends when the final unit reaches its disk end.

Once the final unit reaches FULL, operate the first unit to restart series recording as follows.

1. Set DISK END MODE in the REC SETUP to other than STOP, then close the setup menu.
2. Return to the above step 1 in the **Setup**, and follow the procedures.

## ● Playback

To play back a series recorded image, press the PLAY button on the unit. Refer to page 12 of the Operating Instructions for the monitor connection.

# ■ Communication Protocol

The following pages detail the elements for communication between the Digital Disk Recorder and the personal computer. Make certain to select VTR for PROTOCOL in the COMMUNICATION SETUP window. For BAUD RATE, DATA BIT and PARITY settings, see page 30 COMMUNICATION SETUP. For cable connection refer to RS-232C CONNECTION on page 13.

## 1. Transmission Command

The PC sends messages to the Recorder in the format shown below. Also refer to the command table shown later.

Code	[STX] [Transmission Command] : [p1] : [p2] : : [pn] [ETX]
ASCII	(02H) ( ) ----- ( ) (03H)

[p] stands for parameter. Parameters are omitted when the command does not need to specify them.

## 2. Response Command

The Recorder returns messages in reply to the PC's messages with the following formats.

### (1) Reception Command

When the reception was completed successfully, the Recorder sends back the "ACK code 06H" to the PC, and then the response command below.

Code	[STX] [Response Command] : [p1] : [p2] : : [pn] [ETX]
ASCII	(02H) ( ) ----- ( ) (03H)

Parameters are omitted when the command format includes neither data nor status to send back.

### (2) Reception error

The recorder sends back the "NAK code 15H", followed by the parameters shown below. The Recorder then resets the reception buffer and enters waiting mode for the next message. Parameter "e" identifies the error status.

Code	[NAK] [e]
ASCII	(15H)

- "e" value
- 1: Parity error (31H)
  - 2: Framing error (33H)
  - 3: Overrun error (34H)

### (3) Parameter error

The Recorder returns the "ACK code 06H", if the transmission code was not processed properly for some reason, followed by an error code as shown below.

Code	[STX] ERE [ETX]
ASCII	(02H) (45H) (03H)

**Note:** The Recorder returns [ACK] or [NAK] to the PC within 20 ms after the reception of [ETX] in a transmission.

## ● Command Table

### Basic Operation

Item	Transmission Command (ASCII)	Response (ASCII)	Parameter (ASCII)
Fast Forward to the end	OFF	OFF	
Pause	OPA	OPA	
Play	OPL	OPL	
Recording	ORC	ORC	
Rewind to the top	ORW	ORW	
Skip&Play Forward	OSF:n	OSF	n = 0 to F 0 = Slowest F=Fastest
Stop	OSP:n	OSP	n = P stops PLAY n = R stops REC no parameter stops PLAY and REC
Skip&Play Rewind	OSR:n	OSR	n = 0 to F 0 = Slowest F=Fastest
Forward a field	OVF	OVF	
Rewind a field	OVR	OVR	

### Alarm Control

Item	Transmission Command (ASCII)	Response (ASCII)	Parameter (ASCII)
Alarm Suspension	MAD:n	MAD	n=0 Suspension disabled n=1 Suspension enabled
Alarm History Display	OAE:n	OAE	n=0 Display hides n=1 Display appears
Alarm Reset	OAL	OAL	
Alarm History Clear	OAR	OAR	
Alarm Picture Search	SAS:nnd (:p)	SAS	nn=01 - 99 (in decimal) d=F Search later d=B Search older p=L Search and PLAY p=A Search and PAUSE

### Setup Control

Item	Transmission Command (ASCII)	Response (ASCII)	Parameter (ASCII)
Cursor Moves	DCR:n1n2	DCR	n1=A Right n1=C Upward n1=E Left n1=G Downward n2=1 Move a step n2=2 Move multi steps n1n2=+1 Select parameter(+) n1n2=-1 Select parameter(-) n1n2=PD Move to lower layer n1n2=P+ Move to upper layer n1n2=P- Turn a newer page n1n2=PU Turn an older page
Key Lock	MKL:n	MKL	n=0 Lock OFF n=1 Lock ON
Recording Event Setup	MRM:n	MRM	n=0 Normal recording n=1 Internal timer recording n=2 External timer recording
Summer Time Setup	MST:n	MST	n=0 Standard time n=1 Summer time
Setup	MSU:n	MSU	n=0 End setup n=1 Begin setup
Date&Time Setup	TSU:yyyymmddhhnn	TSU	yyyy=Year mm=Month dd=Day hh=Hour (24-hour system) nn=Minute

## Miscellaneous Control

Item	Transmission Command (ASCII)	Response (ASCII)	Parameter (ASCII)
Playback Speed	LTM:n	LTM	n=0-F n=0 11 ..... Fastest n=1 10 n=2 9 n=3 8 n=4 7 n=5 6 n=6 5 n=7 4 n=8 3 n=9 2 n=A 1 n=B 1/2 n=C 1/4 n=D 1/8 n=E 1/16 n=F 1/32 .....Slowest
Data Copy Cancel	ZDC	ZDC	
Data Copy	ZDP:nn	ZDP	nn=00 Copy until the card is full nn=01 Copy 1 field nn=08 Copy 8 fields nn=16 Copy 16 fields nn=32 Copy 32 fields nn=48 Copy 48 fields
Time&Date Search	ZTS:yyymmddhnnss	ZTS	yyyy=Year mm=Month dd=Day hh=Hour (24-hour system) nn=Minute ss=second
Communication Check	RCK	RCK	

## Data Log Control

Item	Transmission Command (ASCII)	Response (ASCII)	Parameter (ASCII)
Log Total Size Inquiry	ILB:k	ILB:k:bbb	k=0 Alarm log bbb=001 to 099 (in decimal)
Log Erase	ILC:k	ILC:k	k=0 Alarm log
Log Recorded Size Inquiry	ILQ:k	ILQ:k:bbb:(:E)	k=0 Alarm log bbb=001 to 099 (in decimal) E=Overwrite
Log Readout	ILR:k:sss:mmm	ILR:k:<log data s1>s1 <log data s2>s2 <log data sn>F	k=0 Alarm log sss=001-099 Start Address mmm=001-099 Decimal # of log <log data sn>=yyymmddhnnss sn=0-9 and F Cyclic number (F is put at data end)

## Media Control

Item	Transmission Command (ASCII)	Response (ASCII)	Parameter (ASCII)
Disk End Notice Setup	MDE:n	MDE	n=0 End is not notified n=1 End is notified
Disk End Notice		HDE	



## Inquiry

Item	Transmission Command (ASCII)	Response (ASCII)	Parameter (ASCII)
Remaining Size Inquiry	QHR	QHR:nnn	nnn=000-100 Decimal %
ID Inquiry	QID	QID:WJ-HD100	
Key Lock Status Inquiry	QKM	QKM:n	n=0 Lock OFF n=1 Lock ON
Alarm Info Inquiry	QLD:n	QLD:n (Alarm Information)	<b>In Transmission command:</b> n=0 Event report n=1 Date&time report <b>In Response command:</b> n=0 No alarm event n=1 Alarm has been reset n=2 Alarm activated k=0 VMD n=2 PC alarm <b>Alarm Information:</b> k1:y1y1m1m1d1d1h1h1n1n1s1s1: k2:y2y2m2m2d2d2h2h2n2n2s2s2s...
Recording Mode Inquiry	QLR	QLR:n	n=0 2H n=1 6H n=2 12H n=3 18H n=4 24H n=5 48H n=6 72H n=7 96H n=8 120H n=9 170H n=A 180H n=B 240H n=C 480H n=D 960H n=E Not used n=F Not used n=S SP. Q and time are option.
Play Speed Inquiry	QLT	LTMn	n is the same as LTM.
Operating Status Inquiry	QOP	xxx (Operating command)	xxx=OPL Play xxx=OPA Pause or Copy to card xxx=OSR Rewind xxx=OSF Fast Forward xxx=SCP Search and Play xxx=SCS Search and Pause xxx=ORC Normal or Alarm REC xxx=LIT Internal timer recording xxx=OSP Stop
Recording Mode Inquiry	QRM	QRM:n	n is the same as MRM.
Software Version Inquiry	QRV	QRV: (Version Numbers)	Version Numbers consist of three parts, e.g., (1.00:1.00:1.00).

**Matsushita Electric Industrial Co., Ltd.**

Central P.O. Box 288, Osaka 530-91, Japan