

Specification

Power	AA-size batteries/AC adapter(100-240V/50-60Hz)
Display mode	Digital LCD
Measurement mode	Oscillographic testing mode
Measurement range	Pressure: 0kPa~37.3kPa(0mmHg~280mmHg) Pulse value: (30~160)times/minute
Accuracy	Pressure: 15℃~25℃ within ±0.4kPa(3mmHg) 5℃~40℃ (out of 15℃~25℃) within ±0.8kPa(6mmHg) Pulse value: within ±5%
Speed of pressure increasing	0.5kPa/s~1.1kPa/s(3.75mmHg/s~8.25mmHg/s)
Normal working condition	Temperature: 5℃~40℃ Relative humidity: ≤80%
Storage & transportation condition	Temperature: -20℃~55℃ Relative humidity: 10%~93%
Measurable perimeter of the upper arm	About 20cm~34cm
Weight	Approx. 240g(Excluding the dry cells)
External dimensions	Approx. 520mm×208mm×520mm
Classification of safety II	Internally powered equipment. Type B applied part
Pressure mode	Pressure regulating mode of septum-mode pump
Fast gas-discharging mode	Fast open gas-discharging valve mode
Pressure testing	Semiconductor pressure sensor
Pulse testing	Semiconductor pressure sensor



京制00000345号
京药监械(准)字2007第2210452号
YZB/京0058-2007
京药监械生产许20000034号

Panasonic®

电子血压计
Upper Arm Blood Pressure Monitor

使用说明书
Operating Instructions

型号:EW3109
Model No.EW3109

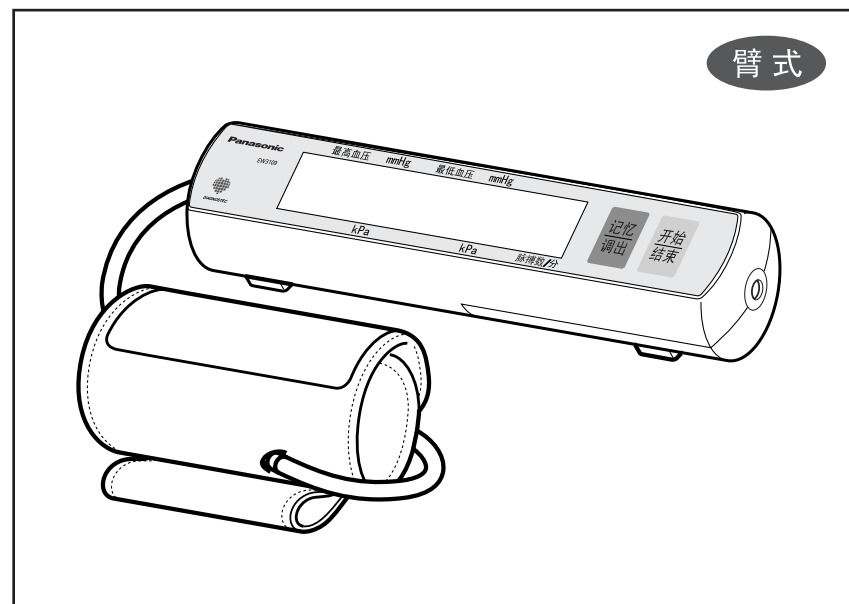

Certificate:



北京松下电工有限公司
Panasonic Electric Works(Beijing)Co.Ltd
地址:北京经济技术开发区同济北路1号
Add: 1#Tong Ji North Road,Beijing Economic
&Technological Development Zone,Beijing,CHINA
原产地:中国 (Made in China)
邮编: 100176 电话: (010)-67882437
Post: 100176 Tel: (010)-67882437

W90303109101
B1208-0
Printed in China

- 感谢您购买本公司产品。
- Thank you for buying our product(s).
- 使用前请您务必仔细阅读本使用说明书,并且要妥善保管。
- Before operating this device,Please read these instructions completely and save this manual for future use.

安全注意事项

- ※ 使用之前，请仔细阅读本“安全注意事项”，以便正确使用。
- ※ 为避免使用者因使用不当而遭受危害或损失，请参阅“安全注意事项”，正确使用本产品。

为安全起见，请务必遵守本安全注意事项。



表示注意内容。









表示 II 类设备。



表示禁止行为。







表示 B 型设备。

 警告	
 务必遵守	<ul style="list-style-type: none"> ● 腕部有重度血液循环障碍的人，请向医生咨询后再使用。否则有可能导致身体不适。 ● 修理时，务必将稳压电源从插座中拔出。另外，请勿用湿手插拔。否则有可能引起事故或发生故障。
 注意	
 务必遵守	<ul style="list-style-type: none"> ● 如果血压计不运行或感觉到异常时，请停止使用并委托检查修理。否则可能导致火灾、触电、灼伤等。
 禁止	<ul style="list-style-type: none"> ● 自己判断测量结果而进行治疗十分危险。 <ul style="list-style-type: none"> ● 请将测量结果交给了解您健康状况的医生并接受诊断。 ● 如果服用药剂请遵医嘱。 ● 请勿让婴幼儿使用。 ● 请勿让无法表达自我意识的人使用。否则将有可能引起事故。 ● 请勿用于测量血压以外的用途。否则将有可能引起事故或发生故障。 ● 请务必使用本产品的专用 AC 稳压电源。否则，有引起着火或触电的可能。 ● 专用 AC 稳压电源请务必使用交流 100V-240V，插座请务必单独使用。否则有引起着火或触电的可能。
 禁止分解	<ul style="list-style-type: none"> ● 请勿私自进行拆卸、修理和改造。否则将有可能发生事故或故障。

※ 请将本说明书妥善保管。

关于 AC 稳压电源使用注意事项

 注意	
 务必遵守	<ul style="list-style-type: none"> ● AC 稳压电源受损伤时禁止使用。否则会有导致触电或短路危险。 ● 请勿踩踏 AC 稳压电源。否则，可能引发事故或受伤害。 ● 请将 AC 稳压电源确实插入插座，避免插入过松。否则会有导致触电或短路危险。 ● 不动作或感觉异常时，请立即中止使用，并拔去 AC 稳压电源进行检查修理。否则会有导致事故、触电或着火的危险。 ● 请勿让 AC 稳压电源的导线受到损伤、扭曲、拉伸，避免被重物挤压。请勿将导线卷绑到主机和 AC 稳压电源上。请勿将 AC 稳压电源与变压器连接使用。否则有引发火灾或触电的危险。
 禁止	<ul style="list-style-type: none"> ● 请勿用水将主机、AC 稳压电源弄湿。否则会有触电、短路、发生故障的可能。 ● 维修保养时，请务必将 AC 稳压电源从插座拔出。禁止用湿手插拔。否则有触电的危险。 ● 防止水、灰尘或针状物附着到 AC 稳压电源上。否则会有导致触电、短路或着火的危险。 ● 不使用时，将 AC 稳压电源从插座拔出。否则会因灰尘、湿气而使绝缘性能劣化，可能引发火灾。 ● 拔出 AC 稳压电源时，请勿手持导线，必须手持 AC 稳压电源本体拔出。否则会有触电或短路危险。 ● AC 稳压电源为 Panasonic 电子血压计专用稳压电源，不得用于其它器械。
 禁止分解	<ul style="list-style-type: none"> ● 请勿对 AC 稳压电源私自进行拆卸、修理和改造。否则有引发火星和因误动作而受伤害的危险。

EW3109型血压计

- 本型号血压计为用于手臂测量的全自动电子血压计,应用示波法,能够快速、简便地测量血压值和脉搏数。
- 本型号血压计适用于人体无创式血压和脉搏的测量。
- 本型号血压计可测量的上臂周长约为20cm~34cm。

本公司承诺:

保修期内的血压计如发生故障,按照本公司所附《保修证》的规定进行修理。

产品清单

- | | |
|---------------------|----|
| ① 主机(含袖带) | 1台 |
| ② 使用说明书 | 1本 |
| ③ 保修证 | 1张 |
| ④ 合格证 | 1张 |
| ⑤ 血压测量记录表 | 1张 |
| ⑥ 5号锌锰电池 | 4节 |
| ⑦ 交流适配器
(AC稳压电源) | 1个 |

※ 随机电池为试机用电池。是为了在购买时确认商品的功能时使用的。

目录

安全注意事项 1

各部名称 4

使用之前 5

- 装入电池.....5
- AC稳压电源的使用方法.....6

使用方法 7

- 卷绑袖带.....7
- 正确测量须知.....8
- 测量方法.....9
- 存储测量值.....11
- 调出存储的测量值.....12
- 使用结束后.....13

其它 14

- 测量时的注意点.....14
- Q&A.....15
- 防止故障.....17
- 发生异常时.....18

规格 19

各部名称

请确认商品

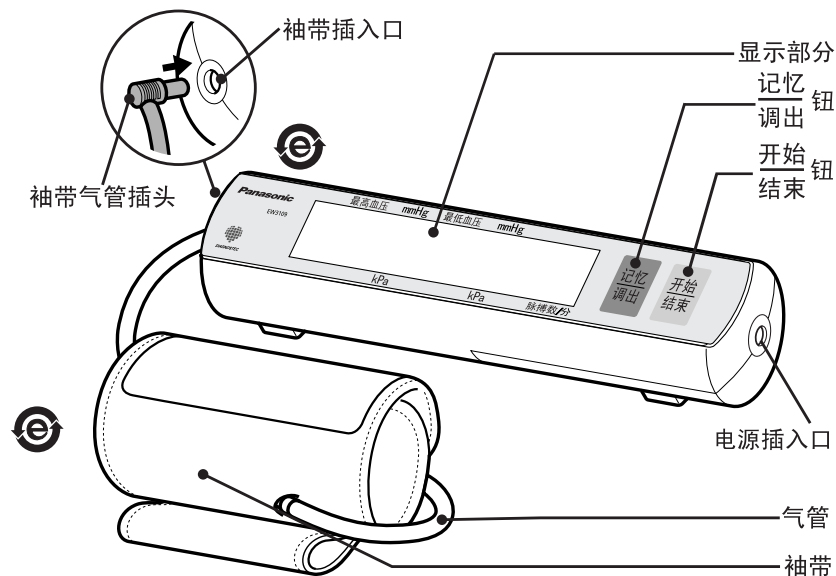

附带品:交流适配器(AC稳压电源)

型号: EW31225

输入/INPUT: 100-240V/50-60Hz

输出/OUTPUT: 6V



主机底面

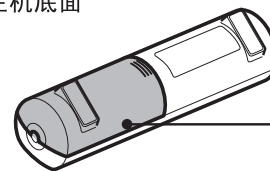

收纳袋

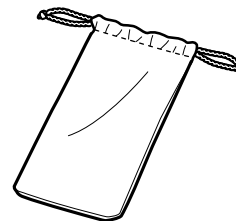

根据需要,有时会在没有事先声明的情况下,改变产品及零部件的规格。

使用之前

装入电池

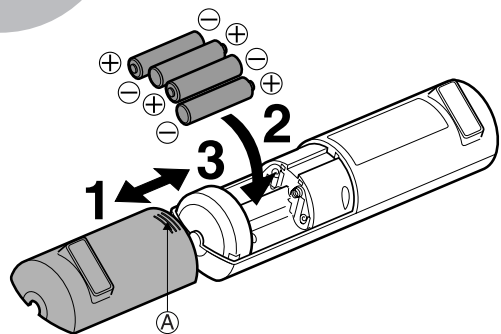

- 1 将主机翻过来, 轻按电池盖的(A)部位, 沿箭头指示方向取出 电池盖。
- 2 确认电池的 \oplus \ominus 极后, 将其装入
- 3 盖上 电池盖, 直至听见“咔哒”声。

⚠ 注意



务必遵守

- 务必遵守电池上所表述的注意内容。
 - 确认电池的 \oplus \ominus 极后装入。
 - 电量不足的电池立即取出。
 - 长时间不使用本血压计时, 应从血压计中取出电池。
 - 请使用有效期内的电池。
- 如不遵守上述事项可能因电池发热、破裂、漏液而发生伤害或破损。

更换电池

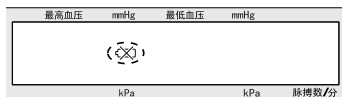

- 测量过程中, 显示屏出现左图显示时;
- 按下“开始/结束”按钮, 全显示后, 显示消失时;
- 即使按下“开始/结束”按钮, 也无任何显示时。

- 如果使用一组新的Panasonic碱性电池, 约可进行500次测量。
1日测量3次, 约可使用5个月(室温22℃、加压至170mmHg(22.7kPa), 上臂周长约30cm时)
- 如果环境温度较低, 则会缩短电池寿命。
- 使用碱性电池以外的电池时, 使用次数可能很短, 因此请务必使用碱性电池。
- 使用一组新的“Panasonic”的锌锰电池, 次数约为140次。
- 随机锌锰电池为试机用电池。是为了在购买时确认商品的功能时使用的。因此使用寿命可能达不到140次。
- 更换电池时, 必须使用同一类型的新电池, 4节电池应同时更换。
- 长时间不使用时, 请将电池取出。避免因电池漏液而导致主机出现故障。
- 废弃电池请勿乱扔, 注意回收。

准备

AC稳压电源的使用方法

※请务必使用专用AC稳压电源(EW31225)

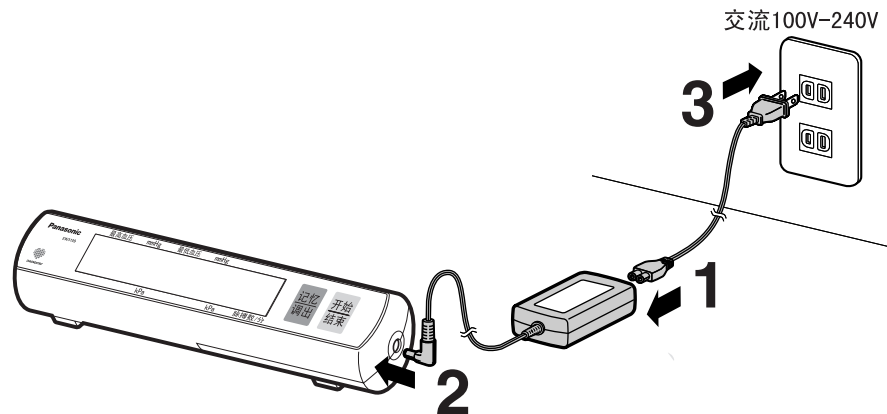

- 1 将电源导线紧紧地插入AC稳压电源本体。
- 2 将AC稳压电源的插头正确地插入血压计主机侧面的插入口。
- 3 将AC稳压电源正确地插入插座。

⚠ 注意



务必遵守

请务必使用专用AC稳压电源。
使用其他电源时, 会导致故障。

使用方法

卷绑袖带

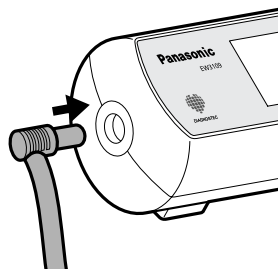

〈用左手测量时〉

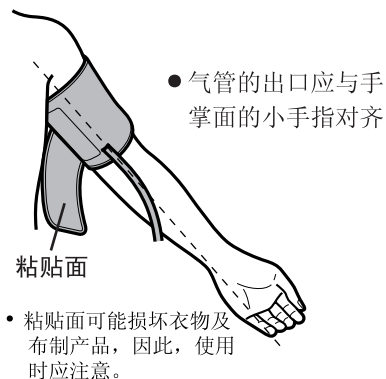

〈用右手测量时〉

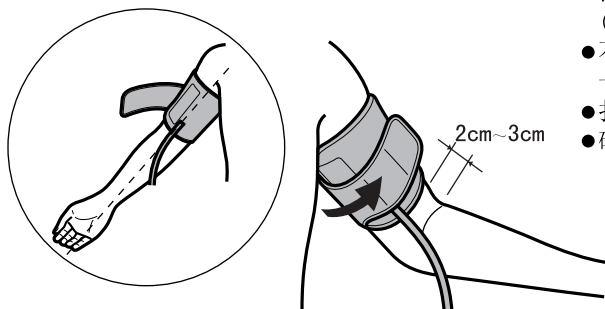

1 插入气管插头。

- 请将气管插头插至根部

2 将袖带卷绑在手臂上。

- 将袖带卷绑在裸露的手臂上。

左右手臂均可测量。但是，左右手臂的血压值相差10mmHg左右，因此每次测量时请用同侧手臂测量。

3 卷牢袖带

(注意不要卷的过紧)

- 请勿将衣服卷入袖带(否则会影响测量精度)
- 不能卷的过紧。能放进一根手指最为合适。
- 扎牢尼龙搭扣
- 确认气管没有脱落。

使用方法

正确测量须知

请在安静、身体放松的状态下进行测量。

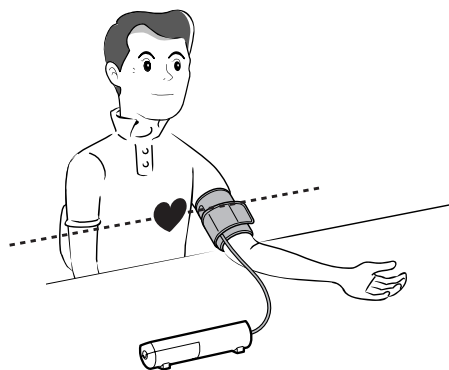

1 将胳膊肘放在桌子上

2 将袖带与心脏高度保持一致

3 手心向上 身体放松

♥ 每天在同一时间，用同一只手臂、相同姿势进行血压测量

- 袖带位置的高低会造成测量值的变动。
- 最好能够测量出您的基础血压(早晨刚醒过来后没有尿意时的血压)，但如果不能，请在吃饭之前，身体尚未剧烈活动的情况下进行测量。
- 测量中请勿触摸主机、袖带和气管。

♥ 测量时应保持安静，使身体处于自然放松状态。

- 测量前请务必安静4~5分钟。
- 使身体、手臂、手指放松，勿让肌肉活动。
- 测量时不能讲话，请保持安静。
- 连续测量时请间隔4~5分钟以上。
- 主机附近请勿使用手机等产生电磁波的仪器。否则可能造成血压计的误动作。

使用方法

测量方法

测量

开始
结束



1 按下开始/结束按钮

- 袖带自动加压测量。

袖带内残留空气时，全显示时间会变长。全显示约1秒钟。

加压过程中，如果检测到脉搏，「♥」标记闪烁。

由于在加压过程中进行测量，因此加压途中会出现动作的声音以及加压速度的变化，但并非异常。

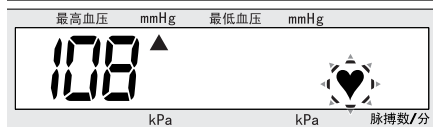

2 测量结束后显示血压值及脉搏数

- 袖带内空气自动排出
- 测量结果以mmHg(血压值)、kPa(血压值)交替显示。脉搏数与血压值同时显示。
- 测量值在高血压区域时，数字闪烁(约8秒钟)(血压指示的读法参照第10页)
- 「M」标记闪烁(存储测量值参照第11页)
- 测得的脉搏数以1分钟进行换算。



开始
结束



3 关闭电源时，按下开始/结束按钮

- 即使忘记关闭电源，约5分钟后，电源也会自动关闭。

使用方法

测量方法

「血压指示」的读法

对于最高·最低血压值，以WHO/ISH(世界卫生组织/国际高血压学会)的血压分类表为基准，来判断是属高血压区域还是正常区域，高血压时，测量值会闪烁。

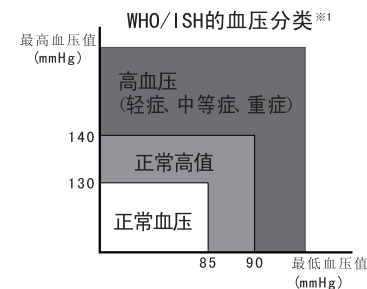

- 测量完了后，测量值在高血压区域时，数字闪烁。(约8秒钟)

- 最高血压 18.7kPa(140mmHg)以上
- 最低血压 12.0kPa(90mmHg)以上 (1kPa=7.5mmHg)

未能正确测量时

将显示再测量符号“E”

继续测量时，按下“开始/结束”按钮关闭电源，请务必安静4~5分钟后再进行测量。

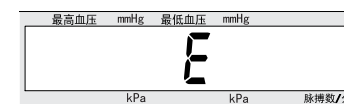

建议

与第一次相比，第二次测量时的状态更加平稳，血压也会有所回落。特别对于易紧张类型的人，两次记录更为有效。二次测量时，通常记录数值较小的测量值。第二次测量时，请在第一次测量后务必安静4~5分钟。

^{*1} 1999 World Health Organization-International Society of Hypertension Guidelines for the Management of Hypertension

使用方法

存储测量值

本产品可存储测量数据90组。

- 在电池电量不足时，更换电池时，取出电池的情况下记忆内容仍可以被保存。
测量结束后，显示部的 [M] 标记



存储完毕

- 可存储90次测量值。此后再记入新测量值时，将覆盖最先存入的测量值。
- 未能正确测量时(血压值显示“E”)，其测量值不能被存储。

※但只是脉搏值显示“E”时，血压值能被存储。



存储次数

删除已存储测量值

- 按记忆/调出钮，调出所存储的测量值。
- 再次按记忆/调出钮（约3秒钟以上），直至测量值消失。

※测量值不能逐个删除，进行上述操作，所存储的测量值会全部删除。

请特别注意。

- 所有的数据一旦被删除后 [M] 标记则显示为 00。

开始
结束

关闭电源时，按「开始/结束」钮

- 即使忘记关闭电源，约5分钟后，电源也会自动关闭。

使用方法

调出存储的测量值

测量结束后或在关闭电源的状态下，按记忆/调出钮可调出存储的测量值。
(未存储测量值时，上述操作无法显示。)

1 按记忆/调出钮

- 显示全部存储测量值的平均值。
- 画面中显示「Avg.」标记。
- 如存储了90个测量值，则显示90个数值的平均值。
(只存储1个测量值时，「Avg.」标记不显示。)

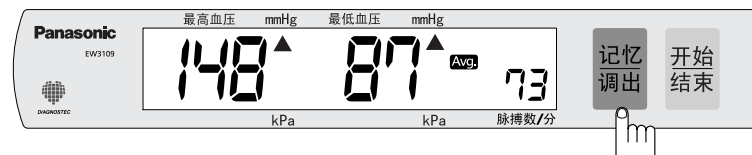

2 再按一次记忆/调出钮。

每按一次记忆/调出钮，显示最新测量值之后，测量值由新至旧逐个显示。

请每次都短促轻按记忆/调出钮。若持续按记忆/调出钮3秒以上，则存储的测量值将被全部删除。请特别注意。



开始
结束

3 关闭电源时，请按「开始/结束」钮。

- 在关闭电源的状态下调出测量值时，即使忘记关闭电源，约30秒钟后，电源也会自动关闭。

使用方法

使用结束后

收藏血压计时



1 从主机上
拔出袖带插头

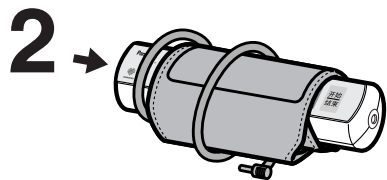

2 轻轻卷好袖带，将气管
收入袖带中。

- 请不要将气管卷在主机上。
- 请不要用力拉伸或弯折气管。否则会导致故障。

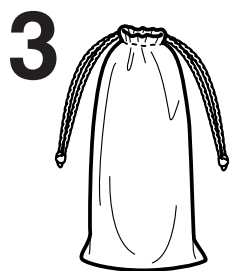

3 放入收纳袋中

注意不要折弯气管。

其它

测量时的注意点

如下场合时无法测得准确的血压

饭后1小时以内或饮酒以后

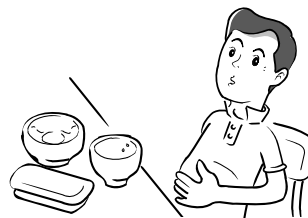

喝咖啡、红茶、吸烟后



运动或洗浴后



请安静20分钟以后再进行测量。

在运动的交通工具中

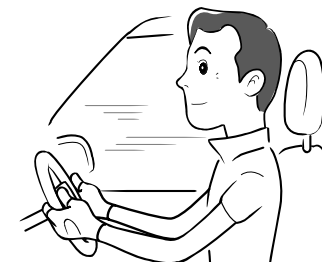

在寒冷的场所测量



请在20℃左右的室温中进行测量。

有尿意时



排尿后，请等待几分钟后再进行测量。

Q 在医院测量的血压值和在家里测量的血压值为何不同？

A. 血压在24小时之内都在变动，另外由于气候、情绪、运动等原因有时会有较大的变动。特别是在医院里有所谓的「白衣性高血压」现象，由于紧张或不安有时比在家里测量的血压值高。

在家里所测量的血压值比在医院高时，请注意以下几点：

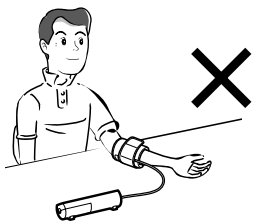

①袖带是否卷绑恰当。

- 袖带卷绑是否过松或过紧。
- 袖带是否卷绑在上臂部位。
正确的卷绑方法参照第7页。

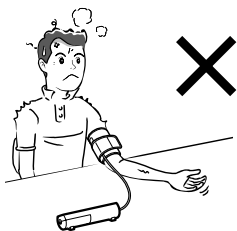

②是否感到不安或焦躁。

- 测量前请深呼吸2~3次，使身体放松，血压稳定。
建议：请安静4~5分钟后再进行测量。

Q 何时测量较好？

A. 一天测量3次比较好。
第1次 ●●● 起床时（因为最接近夜间的血压，且基本没有由于身体的活动造成的影响。）
第2次 ●●● 午餐前（因为没有饮食的影响，且最接近一天中血压最高的时候。）
第3次 ●●● 就寝前（能得到最接近一天中血压平均值的数据。）

通过早、中、晚的测量，掌握自己的血压模式，管理自己的血压。

Q 为什么每次测量的血压值都不一样？

A.

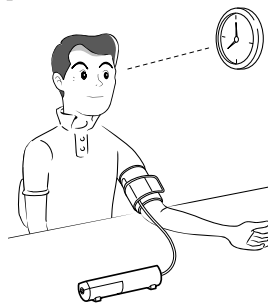

- ① 血压即使在一天之内也在不断地变化，同时也会因袖带的卷绑方法、测量姿势不同而不同。所以每次测量时，请在相同的条件下测量。
- ② 服用降压药的人，因药效的作用，血压值有时变化很大。
- ③ 连续2次测量时，中间必须安静4~5分钟以上。

Q 用左右手测量时，测量值是否相同？

A.

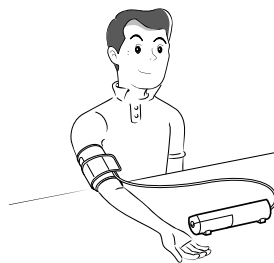

左右手臂均可测量。但是，左右手臂的血压差值可能约10mmHg，因此，每次都请用同侧手臂测量。

其它

防止故障

请勿将主机摔在地上，
避免受到碰撞或
强烈冲击。

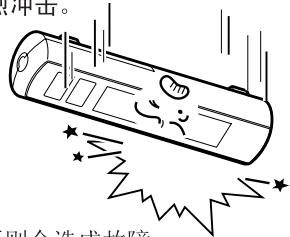

● 否则会造成故障

从0℃以下的场所取出后，
请勿马上使用。

至少要在温暖
环境下保暖1
小时以上



● 否则会造成不能正常加压

请勿使灰尘或异物进入。

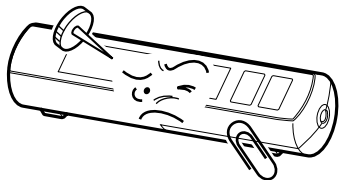

● 否则会造成故障

表面有污渍时，请用沾有温水或
肥皂水的布擦拭。
(请勿使用酒精、汽油、稀释剂)

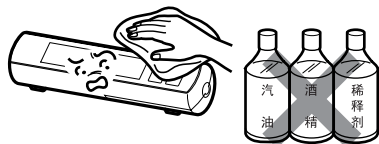

● 否则会导致破裂或变色

避免把血压计存放在高温、
潮湿以及阳光直接
照射的场所。

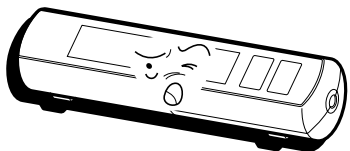

● 否则会造成故障

请勿冲洗袖带



● 否则会造成故障

其它

发生异常时

显示	异常现象	原因及处置
「E」显示时 	▶ 加压至280mmHg以上	▶ 测量方法或姿势是否正确? (参照第7~8页)
	▶ 压力急速下降，显示出“E”。	▶ 是否正确卷绑袖带 (参照第7页)
	▶ 测定至20mmHg时，显示出“E”。	▶ 气管是否连接好了? (参照第7页)
	▶ 心脏标记「♥」仅闪烁数次或完全不闪烁。	
	▶ 等待数10秒仍不加压	
症状	可能的原因	仍存在异常时 请接受医生的指导
最高血压值或最低血压值偏高或偏低	● 袖带位置低 ● 袖带没有正确卷绑 ● 袖带位置高 ● 测量时出现动作或讲话 (参照第7~8页)	
血压值异常高或低	● 每次测量姿势有无改变 (参照第8页)	
与医生测量的血压值不一致	● 在医师面前心理状态的微妙变化，反映在血压计上产生变化。 ● 安静4~5分钟以后再重新进行测量。 (参照第8页)	
每次测量的血压值都不一致		
即使按“开始/结束”钮也无显示	● 电池⊕/⊖极安装错误 (参照第5页)	
按“开始/结束”钮全显示后，显示消失	● 电池电力不足 (参照第5页)	
血压计发生故障	敬请协作 请勿自行修理，并请务必委托本公司指定的电子血压计技术服务代理店进行检查、修理。	

规格

电 源	DC6V 5号碱性电池4节/AC稳压电源(100-240V/50-60Hz)
显示方式	数字式液晶显示
测量方式	示波法检测方式
测量范围	压 力: 0kPa~37.3kPa (0mmHg~280mmHg) 脉搏数: (30~160)次/分
准 确 度	压 力: 15℃~25℃ ±0.4kPa(3mmHg) 以内 5℃~40℃ (15℃~25℃ 以外) ±0.8kPa(6mmHg) 以内 脉搏数: ±5%以内
加 压 速 度	0.5kPa/s~1.1kPa/s (3.75mmHg/s~8.25mmHg/s)
正常工作环境	温 度: 5℃~40℃ 相 对 湿 度: ≤80%
贮存运输环境	温 度: -20℃~55℃ 相 对 湿 度: 10%~93%
可测量的上臂周长	约20cm~34cm
重 量	约240克 (不含电池)
外形尺寸 (主机)	长520mm×宽208mm×厚520mm
安 全 分 类	II类内部电源B型
加 压 方 式	隔膜式泵的加压调整方式
快速排气方式	急速排气阀开放式
压 力 检 测	半导体压力传感器
脉 搏 检 测	半导体压力传感器
企业标准号	Q/DXBSX006-2007
注册标准号	YZB/京0058-2007
医疗器械生产企业许可证号	京药监械生产许20000034号

*如果在规定的温度和湿度范围外储存和使用, 可能无法达到规定的性能规格

合格证:



EW3109 Upper Arm Blood Pressure Monitor

- This instrument is an automatic electronic sphygmomanometer for measuring upper arm blood pressure. The values of blood pressure and pulse can be easily measured by using oscillography.
- Applicable to the measurement of human body's blood pressure and pulse without traumatism.
- The wrist circumference that can be measured with this wrist blood pressure monitor is about 20 cm - 34 cm.

Our promise:

Any malfunction occurring within of purchase will be dealt with according to the rules in Repair Card attached to the product.

Packing list

- ① Main unit (with pressure cuff) 1
- ② User manual 1
- ③ Repair card 1
- ④ Certificate 1
- ⑤ Record card for blood pressure measurement 1
- ⑥ AA-size batteries 4
- ⑦ AC adapter 1

Included batteries are for device testing. Please to verify the functions of the device during purchase.

Content

Important Safety Instructions	21
Parts Identification	23
Preparation	24
• Cased Battery 24~25
• When using the AC adapter26
How to Use	27
• Positioning the cuff27
• Instructions for correct measurement28
• Methods of measurement29~30
• Storing measurement values31
• Recalling stored Measurement values32
• After use 33
Other	34
• Cautions During Measurements34
• Q&A35~37
• Care And Maintenance	...37
• Troubleshooting38

IMPORTANT SAFETY INSTRUCTIONS

- * Before using this instrument, please read the "IMPORTANT SAFETY INSTRUCTIONS" and be sure to use the instrument properly.
- * The cautions in this section are intended to instruct you in the proper use of this instrument and prevent danger or injury to yourself or other people.

All of the cautions contain important information regarding safety and must be followed.

WARNING: Failure to follow the caution may result in death or serious injury of people.

CAUTION: Failure to follow the caution may result in injury to people, or in damage to property.

WARNING:

Persons with serious obstructions of blood flow in the arm should consult a doctor before using this instrument. Failure to do so may result in deterioration of physical condition.

CAUTION:

- Do not make judgements yourself regarding the measurement results or self-treat yourself.
- If the product does not work or seems strange, stop use immediately and request inspection and service. Failure to do so could result in the risk of fire, electric shock, or burns.
 - There will be large differences between wrist blood pressure values and upper-arm blood pressure values for persons with periphery circulatory obstruction due to diabetes, liver disease, kidney disease, arteriosclerosis, high blood pressure, etc.
 - Take measurements according to your doctor's instructions and have your doctor do the diagnosis.
 - Take medicine according to your doctor's instructions.
- Do not use for purposes other than the measurement of blood pressure. Doing so may result in an accident or malfunction.
- Do not use this instrument on infants or on people who cannot express their feelings. Doing so may result in problems or an accident.
- Do not disassemble this instrument, or attempt to repair or modify it yourself. Doing so may result in an accident or malfunction.

SAVE THESE INSTRUCTIONS

AC ADAPTER NOTES

- When cleaning, unplug the AC adapter from the AC outlet before cleaning. Also, do not plug in or unplug the AC adapter with wet hands. Doing so may result in electric shock or fire.
- Do not spill water on the main body or AC adapter. Doing so may cause electric shock, short-circuiting, or product damage.
- Do not use the AC adapter if it is damaged or if it plugs into the AC outlet loosely. Doing so may result in electric shock or short-circuiting.
- If the product does not operate properly or seems strange, stop use and unplug the AC adapter immediately, and request inspection and service. Failure to do so could result in the risk of an accident, electric shock, or fire.
- When using the AC adapter, make sure it is fully inserted into the AC outlet. Failure to do so could result in electric shock or short-circuiting.
- When the product is not in use, unplug the AC adapter from the AC outlet. Failure to do so could result in deterioration of the insulation due to dust or moisture, causing a leakage electricity fire.
- When unplugging the AC adapter, do not pull on the cord. Always grasp the AC adapter body and unplug it. Failure to do so could result in the risk of electric shock, short-circuiting, or fire.
- Do not insert any object in the AC adapter or allow debris to collect on it. Doing so could result in the risk of electric shock, short-circuiting, or fire.
- Do not scratch, damage, modify, forcibly bend, pull, or twist the AC adapter cord. In addition, do not place heavy objects on top of the cord or pinch it with objects. Do not wrap the cord around the main body and the AC adapter. Doing any of these things may result in the risk of fire or electric shock.
- Do not step on the AC adapter. Doing so may cause an accident or injury.
- The AC adapter is designed for use only with Panasonic Blood Pressure Monitor, model EW3109. Use with other electrical devices may result in death or serious personal injury.
- ALWAYS unplug the AC adapter from the power outlet before performing maintenance.
- Do not allow any material to drape over the AC adapter. Doing so could result in the risk of fire.
- Do not modify or attempt to repair the product or AC adapter by yourself. Doing so could result in the risk of fire, electric shock, or personal injury.

PARTS IDENTIFICATION

Please check the instrument.

Main Body

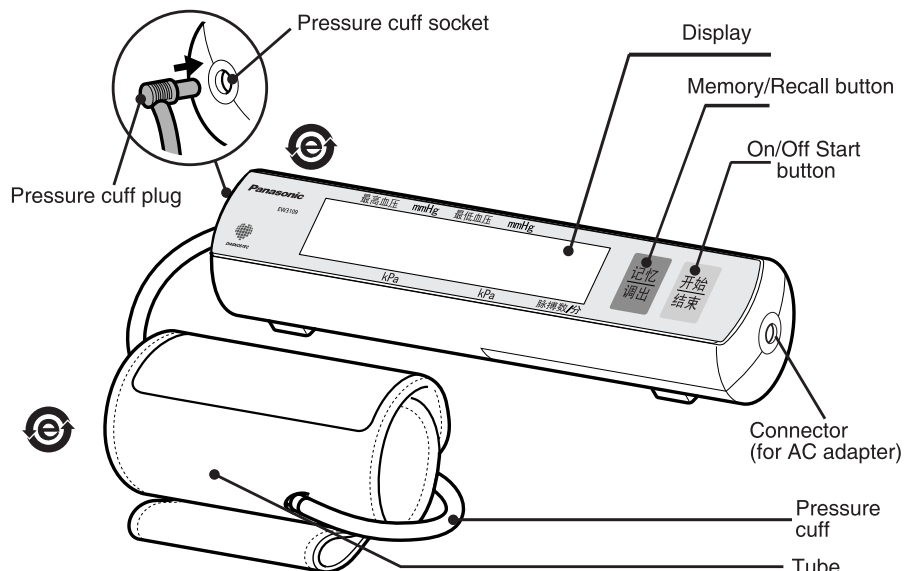

Optional Accessory: AC adapter

Modelo No. EW31225

INPUT: 100-240V / 50-60Hz
OUTPUT: 6V

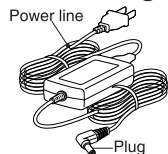

Battery of main body

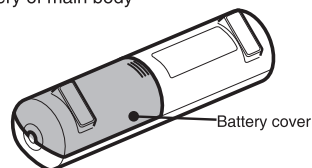

Storage pouch

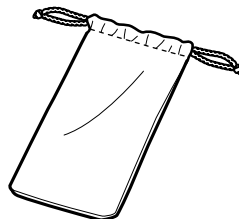

Specifications of products and accessories are subject to change without notice.

INSTALLING BATTERIES

* Always use alkaline batteries.

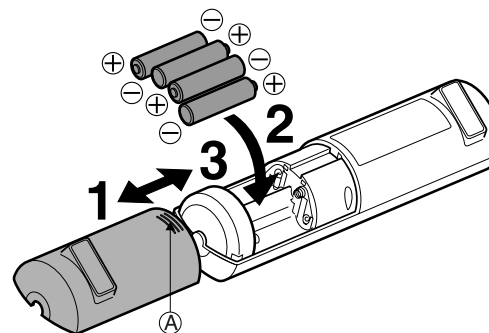

1 Turn the main body over, press lightly on the area indicated by (A) on the battery cover, as shown at right and

remove the cover by sliding it in the direction of the arrow.

2 Check the polarities of the batteries and **install** them correctly.

3 **Close** the battery cover until a click heard.

CAUTION:

- Always follow the cautions printed on the batteries.
- Check the polarities of the batteries and install them correctly.
- Promptly remove exhausted batteries.
- If the product will not be used for a long time, remove the batteries.
- Batteries should be used before their expiration date.

Use after the expiration date may result in injury or staining of the surrounding area due to generation of heat, bursting, or leakage.

Replace batteries when:

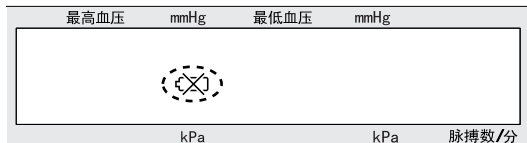

- The mark shown above appears during use.
- All displays are lit for a moment after the 开始/结束 button is pressed, and then the display goes blank.
- No display appears even if the 开始/结束 button is pressed.

- Approximately 500 measurements (approximately 5 months when measurements are taken 3 times per day) can be taken with a set of fresh Panasonic alkaline batteries (four AA-size LR6 batteries). (Measurement conditions: Room temperature: 23°C ; Pressurized to 170 mmHg; Upper arm circumference: 30 cm)
- When room temperature is low, battery life may become shorter.
- Batteries are included only for testing purposes and with no guarantee of battery life. (In some areas batteries are not included with the unit.)
- A set of new "Panasonic" Zn-Mn batteries will provide about 140 measurements.
- Included Zn-Mn batteries are for instrument testing. Since these batteries are used to ensure the functions of the instrument at the time of purchase, their lifetime may be less than 140 measurements.
- When replacing batteries, always use four fresh alkaline batteries of the same type from the same manufacturer.
- If the instrument will not be used for a long period of time, remove the batteries. Leaving the batteries installed may result in battery leakage and damage to instrument.
- Do not discard batteries with normal garbage. Take to recovery center.

WHEN USING THE AC ADAPTER

Use only the exclusive AC adapter(EW31225)

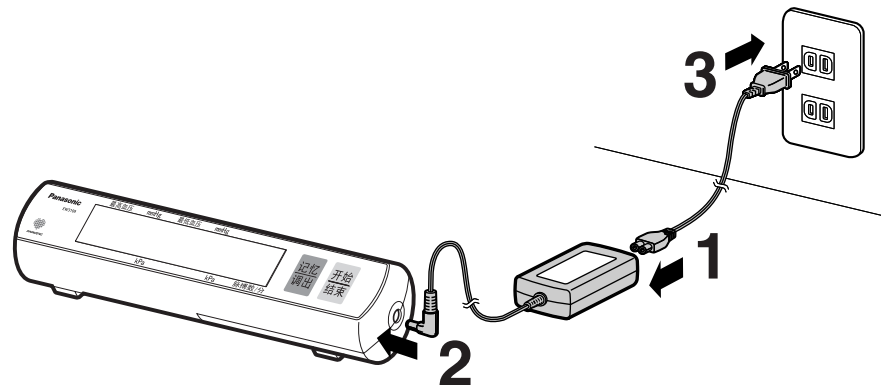

- 1 Insert tightly the wire in the body of AC adapter.
- 2 Insert the AC adapter plug into the connector on the right side of the main unit.
- 3 Plug the AC adapter fully into the AC outlet.

Be sure to use only the exclusive AC adapter.
Use of other AC adapters could cause an accident.

POSITIONING THE PRESSURE CUFF

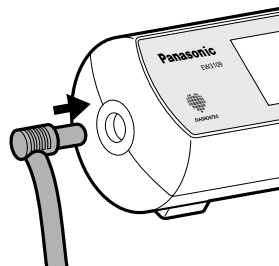

- 1 Insert** the plug into the socket.
 - Insert the pressure cuff plug all the way in.

<When wrapping around left arm>

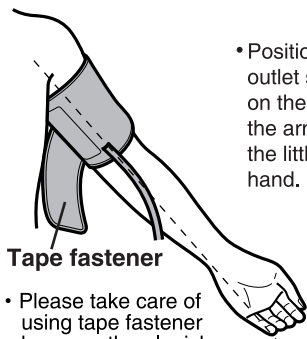

- Position the tube outlet so that it is on the palm side of the arm in line with the little finger of the hand.

Tape fastener

- Please take care of using tape fastener because there's risk of damaging clothes and fabric products.

<When wrapping around right arm>

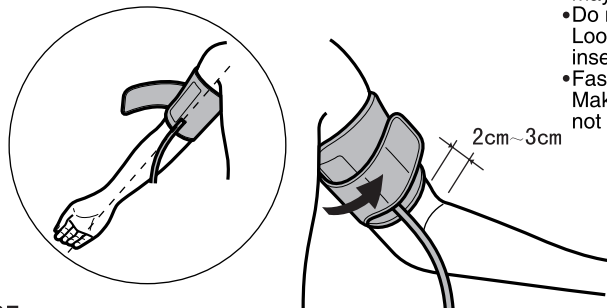

- 2 Wrap** around upper arm.
 - Wrap around bare arm.

The blood pressure monitor can be used by wrapping the cuff on either upper arm. However, since it has been said that the difference in blood pressure between the left and right arms may be around 10 mmHg, be sure to always use the same arm for measurements.

- 3 Wrap** the sleeve strap. (do not fasten too tightly)
 - Do not wrap clothes into the sleeve strap (otherwise the accuracy of measurement may be affected).
 - Do not wrap too tightly. Loose enough for one finger insertion is appropriate.
 - Fasten the nylon fastener. Make sure the air tube dose not fall out.

FOR ACCURATE MEASUREMENTS

Take measurements while sitting quietly and relaxing.

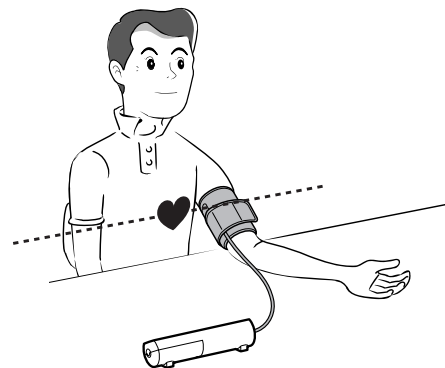

- 1 Rest your arm elbow** on a table, etc.

- 2** Position your arm so that the pressure cuff is **at the same height** as your heart.

- 3** Position your palm upward, and **relax your hand.**

- ♥ **Take measurements using the upper arm in the same position at the same time every day.**

- Measurement values will vary according to the height of the pressure cuff.
- **It is better to measure your basic blood pressure (the blood pressure when you get up in the morning without pee feeling). If not available, please measure your blood pressure before eating and before intense physical exercise.**
- During measurement, do not touch the main body or the tube.

- ♥ **Relax and sit in a natural posture when taking measurements.**

- Always sit quietly for approximately 4 to 5 minutes before taking measurements.
- Relax your body, arm, and fingers and do not move their muscles.
- Do not talk while taking measurements.
- Please ensure 4 to 5 minutes of intermission between measurements.
- Do not use mobile phone or any other apparatus that may generate electromagnetic wave near the main unit. Otherwise, it may cause misoperation of the blood pressure monitor.

TAKING A READING

Measurement

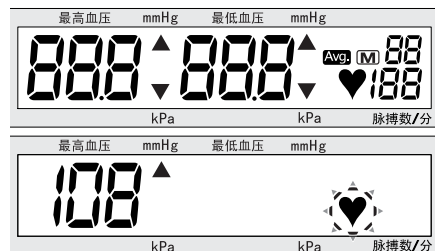

- Press** the 开始/结束 button.
 - The pressure cuff will automatically be pressurized and a measurement will be taken.
 - The entire display will light for approximately 1 second. If there is air left in the pressure cuff, the fully lit time will be longer.

The heart mark ♥ will blink when pulse is detected during pressurization.

Since measurements are performed during pressurization, there may be changes in operating sounds or the pressurization rate may change during pressurization. This is normal and is not a malfunction

- When measurement has been completed, the blood pressure value and pulse rate will be displayed.



- Pressure will be automatically released from the pressure cuff.
- The blood pressure values and pulse number are displayed at the same time. Blood pressure values are displayed alternately in mmHg and kPa units.
- If the measured value is in the high blood pressure region, the values will blink (for approximately 8 seconds). (For how to read the blood pressure display, see p 30)
- The (M) mark will blink. (For storing measurement values, see p 31)
- *The pulse rate value is the beats per minute calculated based on the pulse rate during measurement.



- To switch off the blood pressure monitor, **press** the 开始/结束 button.
 - If you forget to switch off the blood pressure monitor, it will switch off automatically after approximately 5 minutes.

Reading the blood pressure display

Whether the systolic and diastolic blood pressure values are in the high blood pressure region or normal blood pressure region are judged based on the WHO/ISH (World Health Organization/International Society of Hypertension) blood pressure classifications, and the blood pressure value blinks if required.

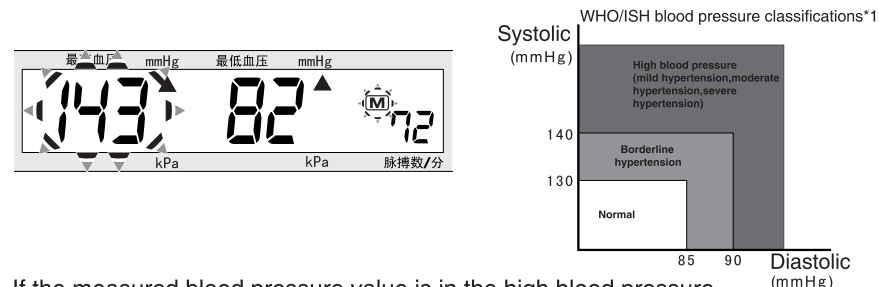

If the measured blood pressure value is in the high blood pressure region, the values will blink for approximately 8 seconds.

- Systolic blood pressure: 18.7kPa (140mmHg) or higher (Only immediately after measurement)
- Diastolic blood pressure: 12.0kPa (90mmHg) or higher (1kPa=7.5mmHg)

If measurements could not be taken properly

The remeasure mark "E" will be displayed.

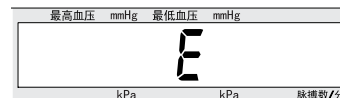

When taking successive measurements, press the 开始/结束 button to switch off the blood pressure monitor once and stay quiet for 4 to 5 minutes, and then take the next measurement.

Advice:

Often with the second measurement, there is less tension and you feel more relaxed, so the blood pressure value is lower. For people who easily get tense, measuring twice each time is very effective. When two measurements are taken, normally the smaller measurement is stored. When taking two measurements, always stay quiet for 4 to 5 minutes after the first measurement before taking the second measurement.

*1 1999 World Health Organization-International Society of Hypertension Guidelines for the Management of Hypertension

STORING MEASUREMENT VALUES

This product can store up to 90 measurement values.

- Stored data will remain in memory even if batteries become exhausted or batteries are removed.

After measurement, **press** the 记忆/调出 button while the (M) mark is blinking.



Storing is completed.

- Up to 90 measurement values can be stored. When the memory is full and additional values are stored, the oldest value in memory will be deleted and the new value will be stored.
- If measurements could not be taken properly (the E mark is shown instead of the blood pressure value), measurement values cannot be stored.
- * However, even if the E mark is shown for the pulse value, the blood pressure value will be stored.

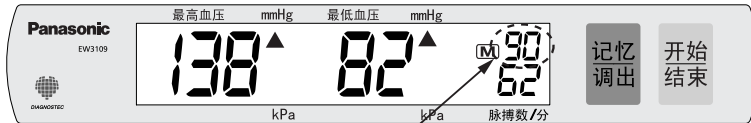

Number of stored data

To erase all measured values stored in memory:

1. Press the 记忆/调出 button to recall stored measurement values.
2. Press the 记忆/调出 button again and hold it pressed until the measurement values disappear (longer than approximately 3 seconds).

* It is not possible to erase single measurement values.

开始
结束

To switch off the blood pressure monitor,

press the 开始/结束 button.

- If you forget to switch off the blood pressure monitor, it will switch off automatically after approximately 5 minutes.

RECALLING STORED MEASUREMENT VALUES

Measurements can be recalled after measurement is completed or after the power has been switched off.

If no measurement values are stored, no value will be shown.

1 Press the 记忆/调出 button. The average of all measured values in memory will be shown.

- Avg. will be shown at the top right of the display.
- For example, if 90 measured values are stored, the average of 90 measurements will be shown. (If only 1 measurement is stored, the Avg. mark will not be shown.)



2 Press the 记忆/调出 button again. Each time you press the 记忆/调出 button, the previously stored measurement values will be **shown** in order, starting with the newest data.

Press the 记忆/调出 button lightly for only a short time. If you hold the button pressed for approximately 3 seconds or longer, all data in memory will be erased, so please be careful.



3 To cancel measurement value recall, **press** the 开始/结束 button.

- If you forget to switch off the blood pressure monitor, it will switch off automatically after approximately 30 seconds.

开始
结束

AFTER USE

Storage



1 Unplug the plug from the main body.

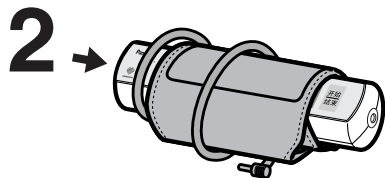

2 Roll the cuff loosely around the main body.

- Please do not wrap the air tube around the main unit.
- Please do not pull or bend the air tube forcibly. Doing so may cause malfunction.

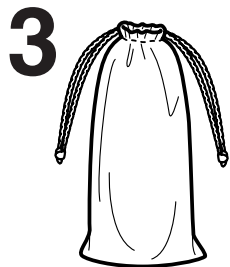

3 Place in the storage pouch.

- Be careful not to bend the tube.

CAUTIONS DURING MEASUREMENTS

In the following situations, accurate measurements cannot be taken.

Within 1 hour of eating or drinking alcohol

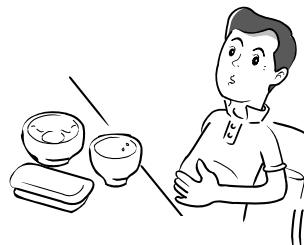

Immediately after drinking coffee or tea, or smoking



Immediately after exercising or taking a bath



In a moving vehicle



Wait at least 20 minutes and take a measurement while staying quiet.

In cold places



Take measurements at ambient temperatures of 10°C to 40°C.

When you need to urinate

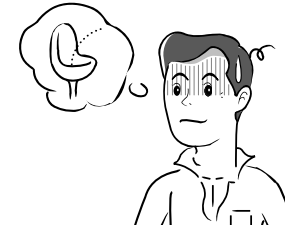

Wait several minutes after urinating before taking measurements.

Q & A

Q Why are the blood pressure values measured at home different from those measured at the doctor's office?

A. Blood pressure varies 24 hours a day. In addition, it can change greatly depending on the weather, your mental state, exercise, etc. In particular, there is the phenomenon of "White uniform hypertension" at doctor's offices, where the blood pressure measured in a doctor's office is higher because of stress or worry.

In addition, if the blood pressure measured at home is higher than that measured at the doctor's office, the following points should be considered and care should be observed where necessary:

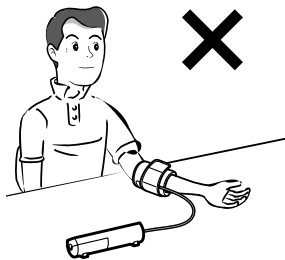

① **Is the pressure cuff wrapped correctly?**

- Make sure that the pressure cuff is not wrapped too loosely or too tightly.
- Is the pressure cuff wrapped around the upper arm?

For how to wrap the pressure cuff correctly, refer to p.27.

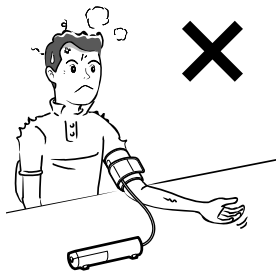

② **Do you feel worried or irritated?**

- Before taking measurements, take 2 or 3 deep breaths and relax to stabilize blood pressure. In addition, it is recommended that you sit quietly for about 4 to 5 minutes before taking measurements

Q & A

Q When should I measure my blood pressure?

A. We recommend that you measure your blood pressure 3 times a day.

First time: **When you get up in the morning.** (This is when your blood pressure is most typical of its value during the night and when the movements of your body have had hardly any effect on it.)

Second time: **Before eating lunch.** (This is when your blood pressure is not affected by food and when it is most typical of the highest level of the day.)

Third time: **When you go to bed at night.** (This data value is roughly typical of the average blood pressure value for the day.)

Get to know your blood pressure pattern by measuring your blood pressure in the morning, at midday and in the late evening, and use the data you obtain to manage your blood pressure.

Q Why are measured blood pressure values different each time I take a measurement?

A.

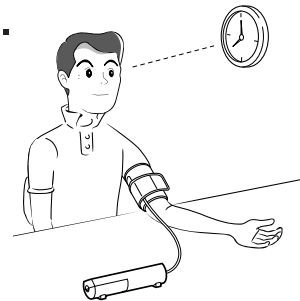

① Blood pressure varies throughout the day, and can also vary depending on how the pressure cuff was wrapped or your posture. Because of this, measurements should be taken at the same time and under the same conditions every day.

② For persons taking blood pressure medication, blood pressure may change greatly due to the effects of the medication.

③ When taking 2 measurements in succession, be sure to stay quiet for 4 to 5 minutes after the first measurement before taking the next measurement.

Q & A /CARE AND MAINTENANCE

Q Why are the measured values different for the left and right wrist?

A.

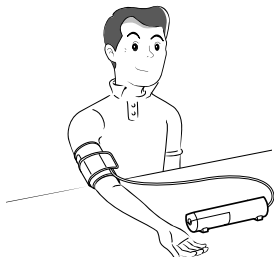

It is said that differences in blood pressure values between the left and right arms may be around 10 mmHg. The blood pressure can be measured in either the left or right arm, but all measurements should be taken using the same arm.

Care and maintenance

Do not apply excessive force to the instrument or drop the instrument.

- Doing so may cause damage.

If the instrument is stored at temperatures below the freezing point, do not use it immediately. Leave it in a warm place for at least an hour before use.

- If the instrument is not allowed to warm up, it may not pressurize.

Please keep it away from foreign bodies or erosive liquid.

- Doing so may result in damage.

If the instrument becomes dirty, clean it with a soft cloth moistened with warm water or soapy water. (Do not use alcohol, benzene, or paint thinner.)

- Use of such chemicals may result in cracking or discoloration.

For storage, avoid high temperatures, high humidity, and direct sunlight.

- Storage under such conditions may result in damage.

The pressure cuff cannot be washed.

TROUBLESHOOTING

Display	Status before error	Cause and solution
Remeasure E mark is displayed. 	Pressurization to more than 280 mmHg was performed.	Were measurements taken according to the proper procedure and in the correct posture? See pp.27 and 28.
	Pressure decreased suddenly and the remeasure mark E appeared.	
	Measurement was taken to 20 mmHg and then the remeasure mark E appeared.	Was the pressurization cuff wrapped properly? See p.27.
	The heart mark \heartsuit blinked only a few times or not at all. Pressurization doesn't occur even after waiting several dozen seconds.	Tube may not be connected sufficiently. Check the tube connection. See p.27.

Symptom	Possible cause
Systolic or diastolic blood pressure value is high or low.	<ul style="list-style-type: none"> • Position of pressure cuff is low. • Pressure cuff is not wrapped correctly. • Position of pressure cuff is high. • You moved or talked while measurements were being taken. See pp.27 and 28.
Blood pressure value is abnormally high or low.	<ul style="list-style-type: none"> • Posture is different for each measurement. See p.28.
Value is different from that measured by the doctor.	<ul style="list-style-type: none"> • Blood pressure varies in response to minute changes in your mental state, such as your reaction to a doctor's presence. • Sit quietly for 4 to 5 minutes and then take another measurement. See p.28.
Measurement values are different with each measurement.	
No display appears even when the 开始/结束 Start button is pressed.	<ul style="list-style-type: none"> • Batteries are exhausted. • Batteries are installed with the polarities wrong. See pp.24 and 25.
When the 开始/结束 Start button was pressed, the display became lit and then the display disappeared.	
Damage of the main part	<ul style="list-style-type: none"> • Do not repair it yourself. Please contact our designated service agency for electronic sphygmomanometer to examine and repair the device.

***The warranty of this product is only valid in the PRC. (Not available in Hongkong, Macao and Taiwan for the time being.)**