

MAKO™ TKA

stryker

Surgical Guide

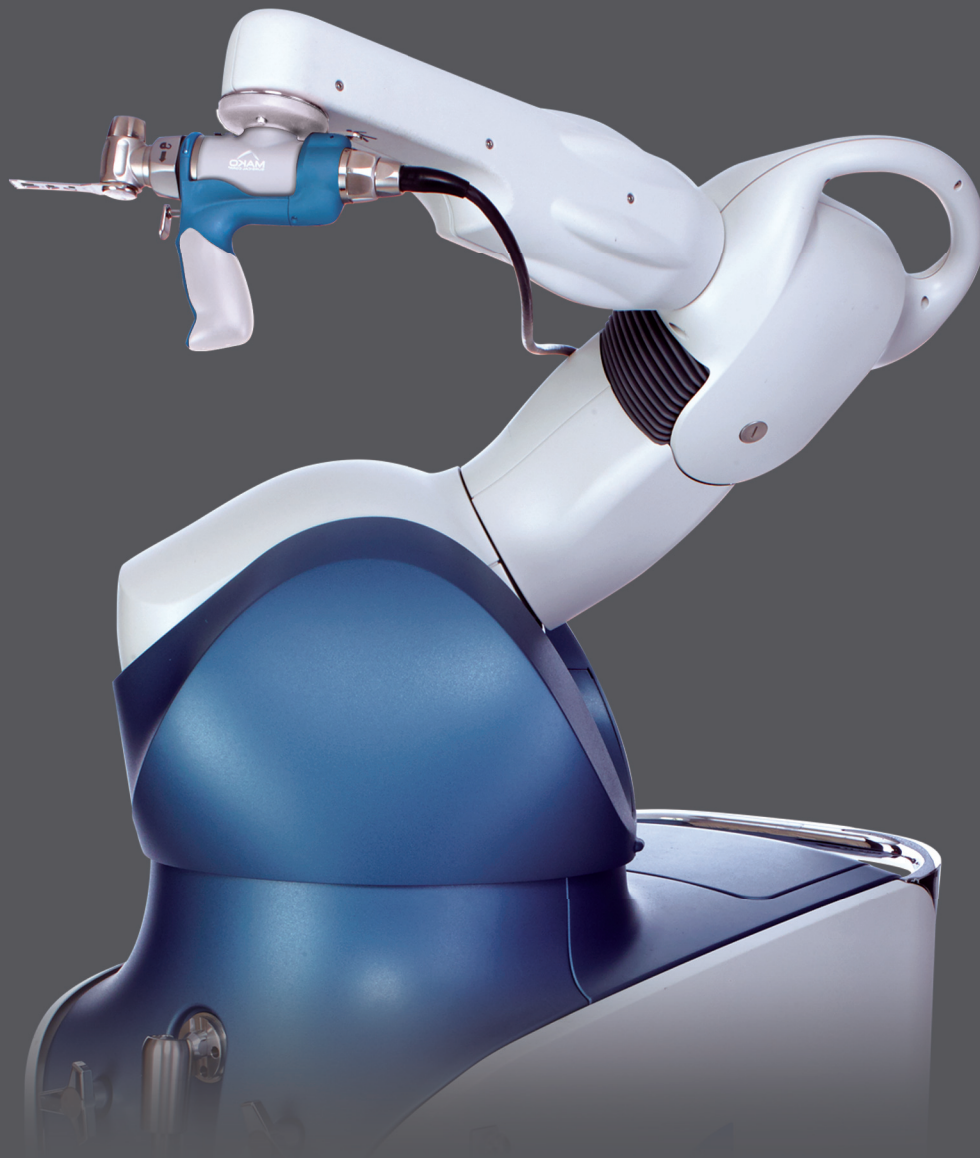

TABLE OF CONTENTS

INTRODUCTION.....	1
SYSTEM OVERVIEW.....	3
A. MAKO TKA SYSTEM	3
B. TKA IMPLANT SYSTEMS.....	4
INDICATIONS FOR USE	4
PATIENT SELECTION	4
MAKO TKA IMPLEMENTATION.....	5
A. CT SCAN	5
B. INSTRUMENTATION	5
C. MAKO TKA TERMINOLOGY	5
D. SURGEON PREFERENCES	6
PRE-OPERATIVE PLANNING.....	7
A. CT LANDMARKS REVIEW	7
B. RESECTION LANDMARKS REVIEW	8
C. IMPLANT PLANNING (PRE-OPERATIVE).....	8
MAKO TKA SURGICAL TECHNIQUE	17
A. PATIENT POSITIONING	17
B. MAKO SYSTEM SETUP	17
C. EXPOSURE	22
D. BONE ARRAY PLACEMENT	24
E. BONE REGISTRATION	27
F. INTRA-OPERATIVE PLANNING	30
G. RIO SETUP - OPTIMIZE POSITION.....	42
H. BONE PREPARATION	44
I. TRIAL REDUCTION AND JOINT ASSESSMENT.....	53
J. POST-RESECTION IMPLANT ADJUSTMENTS	54
K. FINAL COMPONENT PREPARATION	55
L. PATELLAR PREPARATION	55
M. FINAL COMPONENT IMPLANTATION	55
N. CASE COMPLETION	56

INTRODUCTION

User Manual Terms of Use

This manual is provided by MAKO Surgical Corp. (Stryker) and may be used for informational purposes only. Terms and Conditions related to the use of the Stryker Robotic Arm System (Mako) can be found in the placement agreement with the system user.

About This Manual

This manual describes the Mako Total Knee Arthroplasty (TKA) surgical technique assisted by the Stryker Robotic Arm System (Mako). The procedure will be identified as Mako (MAKOplasty) TKA in this manual.

Manufacturer Support/Feedback

MAKO Surgical Corp.
2555 Davie Rd.
Ft. Lauderdale, FL 33317 USA
Customer Service +1 (855) 303-6256
makosurgical.com

Medical and Product Information

This manual is informational only and is not intended as medical advice or a substitute for medical advice. As the manufacturer of medical devices in the field of orthopedics, Stryker does not practice medicine and does not recommend the surgical techniques referenced or discussed in this manual or any other surgical techniques for use on a particular patient. Stryker is not responsible for selection of the appropriate surgical technique to be utilized for an individual patient.

Patents

Reference: U.S. Patents <http://patents.makosurgical.com/15>

Indications for Use

The Stryker Robotic Arm System (Mako) is intended to assist the surgeon in providing software defined spatial boundaries for orientation and reference information to anatomical structures during orthopedic procedures.

The Mako is indicated for use in surgical knee procedures in which the use of stereotactic surgery may be appropriate, and where reference to rigid anatomical bony structures can be identified relative to a CT based model of the anatomy. These procedures include:

- Total Knee Arthroplasty (TKA).

The implant systems compatible with this system:

- Triathlon Total Knee System (CR/CS/PS Cemented Primary)
- KINETIS Total Knee System (CR/UC).

Copyrights and Trademarks

The content of this manual is protected under applicable copyright and trademark laws. You agree that you will not copy, distribute, republish, display, post, transmit or modify any content in this manual without Stryker's prior permission. Any images displayed in this manual are the property of their respective copyright owners. Any reproduction, replication, modification or distribution of any art images in this manual is prohibited. The third-party trademarks in this manual are proprietary to their respective owners. These companies or their agents have granted Stryker the right to use their trademarks.

Governing Law

Any legal action or proceeding related to this manual or the information contained in it shall be brought exclusively in a court in Bergen County, New Jersey, and shall be governed by the laws of the State of New Jersey, without regard to conflicts of laws principles.

Software Version TKA 1.0



There are no user serviceable parts in the Mako System, refer to your Stryker authorized personnel for service.

SYSTEM OVERVIEW

A. MAKO TKA SYSTEM

The Mako TKA System is used to consistently and reproducibly plan and execute a primary Total Knee Arthroplasty (TKA). Using patient specific information from a pre-operative CT scan, the surgeon has the ability to pre-operatively and intra-operatively adjust the plan to achieve proper biomechanical reconstruction of the knee for patients who satisfy the criteria for indications for use.

The Mako TKA System is comprised of the following components:

- The Mako System
 - Robotic Arm
 - Camera Stand
 - Guidance Module
- Mako (MAKOplasty) TKA Application software
- Mako Knee Instrumentation
 - Mako Knee Array/Balancing Kit
 - Mako Power System and Attachment Kit (Cutting System)
 - Leg Positioner Kit
- Sterile Disposables



Figure 1. Mako TKA System

B. TKA IMPLANT SYSTEMS

The Mako TKA System is used to plan and execute Triathlon and KINETIS implant systems. For detailed implant information for the selected implant, refer to the appropriate Instructions for Use and Surgical Technique of the selected implant system.

- Triathlon Instructions for Use (PN QIN 4376)
- Mako TKA with Triathlon Surgical Protocol (PN TRIATH-SP-21)
- KINETIS Instructions for Use (PN PI-004)
- Mako TKA with KINETIS Surgical Technique (PN 210468).

INDICATIONS FOR USE

For indications and contraindications for the selected implant system, please reference the implant specific Instructions for Use.

- Triathlon Instructions for Use (PN QIN 4376)
- KINETIS Instructions for Use (PN PI-004).

Familiarity with and attention to appropriate surgical technique for total knee replacement is essential for success of the procedure. Only surgeons who have reviewed the literature regarding total knee replacement surgery and have had training in the technique using the Mako should perform this procedure.

For additional details relating to Warnings and Precautions, Possible Adverse Effects and Packaging/Sterilization (if applicable), refer to the Instructions for Use of the selected implant system.

- Triathlon Instructions for Use (PN QIN 4376)
- KINETIS Instructions for Use (PN PI-004).

PATIENT SELECTION

Patient selection for Mako TKA depends on the judgment of the surgeon with regard to the requirements of the patient. Prior to Mako TKA, the surgeon should consider the following:

- Articulation of the hip joint is necessary to complete bone registration.
- Metal in the operative or non-operative leg can lead to the creation of accuracy reducing artifacts in the CT scan which can adversely affect the operative plan.
- The presence of infection (including history of infection), acute or chronic, local or systemic should be ruled out.
- Poor bone quality may affect the stability of the implant.
- Patient size may complicate the resection procedure. Body Mass Index should be considered.
- Poor integrity and/or lack of ligament structures may prevent the restoration of a stable joint.
- The type and significance of the deformity (hyperextension, flexion contracture, or fixed varus/valgus) must be considered.



The surgeon has final decision authority in choosing patients for the Mako TKA procedure. The effectiveness of all knee implants can be reduced by poor patient selection.

MAKO TKA IMPLEMENTATION

A. CT SCAN

Each patient requires a pre-operative CT scan for the Mako TKA procedure. This scan must follow the protocol in the *Mako Knee CT Scanning Protocol (PN 200004)*.

B. INSTRUMENTATION

The Mako TKA Instrumentation and Disposables:

- Mako Knee Instrumentation
 - Mako Knee Array/Balancing Kit
 - Mako Power System and Attachment Kit
 - Leg Positioner Kit
- Sterile Disposables:
 - Mako Drape Kit
 - Leg Positioner Disposable Kit
 - Silicone Retractor Cords
 - VIZADISC Knee Procedure Tracking Kit
 - Checkpoints
 - Bone Pins
 - MICS Saw Blades (Standard or Narrow)
- Implant System Instrumentation
 - For specific implant system instrumentation required, refer to the Instructions for Use and Surgical Technique of the selected implant system.
 - Mako TKA with Triathlon Surgical Protocol (PN TRIATH-SP-21)
 - Manual TKA Surgical Technique for KINETIS (PN 210468).

C. MAKO TKA TERMINOLOGY

- **Approach Zone**

A volume in space around the knee joint where surgeon enabled motorized alignment to the stereotactic boundary cutting plane is permitted when the MICS Handpiece trigger is depressed.
- **Approach Mode**

Approach Mode assists the user in guiding the cutting system to the stereotactic boundary for bone resection.
- **Bone Registration**

The process of collecting points on the bony anatomy to enable the system to track patient anatomy in real-time.
- **Checkpoint**

Bone: A metal divot inserted into the femur or tibia to confirm that the respective bone array has not shifted since bone registration.
Cutting tool: A feature in the saw blade to confirm that the Robotic Arm Base Array has not shifted since RIO Registration.
- **Cutting Mode**

Cutting Mode enables power to the cutting system while constraining the cutting system to the stereotactic boundary for bone resection.
- **Engage Line**

The Engage Line is where the MICS Handpiece cutting tool is moved to during surgeon enabled motorized alignment. It is a mediolateral line segment located approximately 20 mm from the bone.

- **Free Mode**

Free Mode (Unlock) disables Approach Mode and Cutting Mode. If pressed while in Cutting Mode, power to the MICS Handpiece is disabled and then the stereotactic control is disabled.

- **MICS: MAKO Integrated Cutting System**

The MAKO Integrated Cutting System consists of a MICS Handpiece, Right Angle Saw Attachment, Sagittal Saw Attachment, Standard Saw Blade, and Narrow Saw Blade.

- **MPS: Mako Product Specialist**

The Mako Product Specialist, or the Stryker Representative helps operate the Mako (MAKOplasty) TKA Application software during the surgical procedure.

- **PCA**

Posterior Condylar Axis is defined by a line connecting the two most posterior points of the medial and lateral condyles.

- **Mako Centerline**

The mid-plane that bisects the Robotic Arm base into symmetrical halves (parallel to the long side panels on either side of the Mako).

- **Stereotactic Recovery**

Stereotactic Recovery re-engages stereotactic control if it has been disabled while cutting.

- **TEA**

Transepicondylar Axis is defined by a line connecting the surgical medial and lateral epicondyles.

- **Whiteside's Line**

Anterior-posterior axis of the femur as defined by a line through the deepest groove of the trochlea.

- **Velocity Limit**

While in Cutting Mode, if an array moves (e.g., array is loose or patient leg moves) with excessive velocity, power is shut off to the cutting system, an audio warning is sounded, and stereotactic control is disabled until the leg stabilizes.

- **VIZADISC**

Reflective markers that attach to the tracking arrays, allowing the camera to track their location in real-time.

D. SURGEON PREFERENCES

The surgeon can customize the Mako (MAKOplasty) TKA Application in Surgeon Preferences. The preferences listed below are important in selecting the desired workflow:

- 'Measured Resection' or 'Ligament Balancing' workflow. 'Measured Resection' workflow utilizes resection depths to finalize the implant plan, whereas 'Ligament Balancing' workflow utilizes gap balancing to finalize the implant plan.
- 'Distal/Tibia Cut First' or 'Pre-Resection Balancing'. If 'Ligament Balancing' workflow is selected, 'Distal/Tibia Cut First' enables bone resection to set the extension gap before balancing the flexion gap, whereas 'Pre-Resection Balancing' allows the surgeon to balance gaps before any bone resections are made.
- 'Perform RIO Setup and RIO Registration before Bone Preparation'. Selecting this preference moves these steps from their default position of after 'Probe Check' to before 'Bone Preparation'.
- 'Bone Resection' or 'Estimated Cartilage'. 'Bone Resection' displays resection depth based on bone landmarks, whereas 'Estimated Cartilage' displays resection depth based on estimated cartilage thickness (Bone Resection + 2 mm).
- 'Display Total Combined Resection Depth'. Displays the addition of the femur and tibia resections depths for each compartment in extension and flexion.
- 'TKA Cutting Sequence'. Sets the order of the cutting steps for the femur and tibia.

PRE-OPERATIVE PLANNING

The Mako (MAKOplasty) TKA Application enables the user to perform pre-operative implant planning using a patient-specific CT-based bone model and virtual implant templates. The primary purpose of pre-operative planning is to size, align, and position the implant to bony anatomy. Fine tuning of the implant plan using additional clinical information such as patient specific kinematics, fixed deformities, and soft tissue tension will be completed during Intra-operative Planning.

A. CT LANDMARKS REVIEW

Surgeon/Mako Product Specialist

Accurate and precise definition of bony landmarks is critical as they define the femur and tibia mechanical axes, anteroposterior (AP) axes, and mediolateral (ML) axes. Implant alignment is displayed with respect to these axes. These landmarks are collected by the MPS and reviewed by the surgeon pre-operatively. For a complete description of landmark definition, refer to the *Mako TKA Application User Guide (PN 210467)*.

Femur Axes Definition

1. Femur Mechanical Axis: The Femur Mechanical Axis is defined by a line connecting the 'Hip Center' to the 'Femur Knee Center'.
 - a. 'Hip Center' is defined as the center point of a circle fit to the femoral head in the coronal, sagittal, and transverse planes.
 - b. 'Femur Knee Center' is defined at the most distal point of the trochlear groove in the coronal and sagittal views.
2. Transepicondylar Axis (TEA): The mediolateral TEA is defined by a line connecting the 'Medial Epicondyle' to the 'Lateral Epicondyle'. The Femur Mediolateral (ML) Axis is parallel to the TEA in the transverse plane.
 - a. 'Medial Epicondyle' is defined by a point in the bony sulcus, which is called the surgical medial epicondyle. It is not the clinical medial epicondyle, which is the most proud (or prominent) bony protuberance that can be palpated clinically.
 - b. 'Lateral Epicondyle' is defined by the most proud (or prominent) point on the lateral bony protuberance.
3. Femur Anteroposterior (AP) Axis: The 'Femur AP Axis' is naturally perpendicular to the 'Femur ML Axis'. The 'Femur AP Axis' is approximately parallel to Whiteside's line, which is the line through the deepest groove of the trochlea.

Tibia Axes Definition

1. Tibia Mechanical Axis: The Tibia Mechanical Axis is defined by a line connecting the 'Tibia Knee Center' to the 'Ankle Center'.
 - a. 'Tibia Knee Center' is defined as the proximal exit location of the anatomic tibial shaft in both the coronal and sagittal views.
 - b. 'Ankle Center' is computed from the collection of the medial and lateral malleoli landmarks. The line connecting the two malleoli will appear externally rotated (approximately 20°) from the Tibia Mediolateral (ML) Axis. The malleoli landmarks are located on the outermost bony protuberances, halfway from the most anterior and most posterior edges when viewed by an externally rotated plane. The 'Ankle Center' is computed as 44% from the medial malleolus and 56% from the lateral malleolus.
2. Tibia Anteroposterior (AP) Axis: The 'Tibia AP Axis' is set using the 'Rotational Landmark' and is defined by a line connecting the 'PCL Center' to the medial 1/3 of the tibial tubercle.
 - a. 'PCL Center' is defined as the center of the PCL insertion region, which is characterized by a bright dense region of bone in the transverse view. Place the center of the blue rotation bar (ML

axis) there. The PCL insertion can be best visualized in the transverse view by setting the crosshair below the lowest compartment in the coronal view be it medial or lateral.

- b. Medial 1/3 of the tubercle is defined as the approximate anterior-medial corner of the tubercle as visualized by a transverse cross-section at the level of the tibial tubercle. Rotate the green arrow bar (AP axis) until it intersects the medial 1/3 of the tibial tubercle.

- 3. Tibia Mediolateral (ML) Axis: The ‘Tibia ML Axis’ is naturally perpendicular to the ‘Tibia AP Axis’.



The malleoli landmarks should match the location as palpated during the bone registration process using the ‘Patient Landmark’ page. Because the malleoli landmarks do not lie in a plane parallel to the coronal plane, they should not be located as the outermost protuberance in the coronal plane.

B. RESECTION LANDMARKS REVIEW

Surgeon/Mako Product Specialist

The resection landmarks are used to compute the medial and lateral resection thicknesses of the distal femur, posterior femur, and proximal tibia. These initial points are automatically calculated based on a software algorithm. Ensure that the resection landmarks are not located on osteophytes and are located where a caliper would normally be used to measure condyle resection thickness. If the default resection landmarks appear incorrect, they can be modified on this page by manually selecting the correct point.

C. IMPLANT PLANNING (PRE-OPERATIVE)

Surgeon/Mako Product Specialist

The Mako (MAKOplasty) TKA Application allows the surgeon flexibility regarding the sequence of planning steps and selected anatomic reference points. The sequence of planning steps below represents one such sequence designed to achieve the desired deformity correction, ligamentous balance, and knee kinematics.

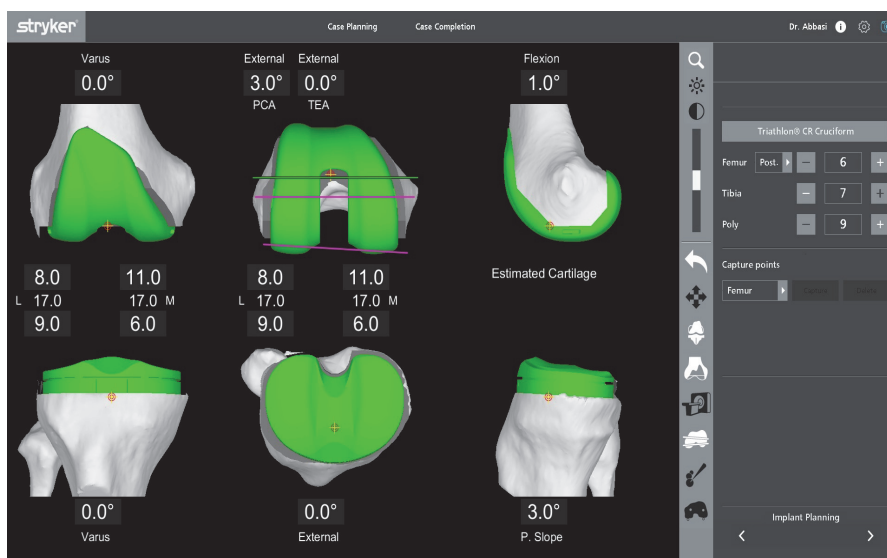

Figure 2. ‘Implant Planning’ Page

Table 1 , Table 2 , and Table 3 provide the recommended implant planning guidelines. The default compartment reference is the least diseased side because the bone and cartilage are expected to have less wear (i.e., to be a more reliable reference) than the diseased side.

- Varus knee: lateral compartment (least diseased)
- Valgus knee: medial compartment (least diseased)

To predict if the knee is in varus or valgus, set both the femoral and tibial component varus rotations to 0°, compute the total combined coronal (extension) resections for medial and lateral compartments, and identify which compartment has the least resection. The compartment with the least combined resection is expected to have more wear and disease.

- Varus knee: total medial resection depth < total lateral resection depth (i.e. medial wear)
- Valgus knee: total lateral resection depth < total medial resection depth (i.e. lateral wear)

The surgeon has the ability to deviate from the default references and positioning values based on the clinical needs of the patient.



All varus/valgus and flexion/extension values are displayed with respect to the mechanical axis of the applicable bone while internal/external rotation values are displayed with respect to the AP/ML axes of the applicable bone.

Femoral Component

1. Establish Coronal Rotation

In the coronal plane, the femur anatomic axis is approximately 5-7° valgus with respect to the femur mechanical axis. The Mako (MAKOplasty) TKA Application displays coronal rotation values with respect to the femur mechanical axis. Set the coronal rotation to the desired value.

2. Establish Axial Rotation

In the transverse plane, the transepicondylar axis (TEA) is approximately 3° externally rotated from the posterior condylar axis (PCA). The Mako (MAKOplasty) TKA Application displays axial rotation values with respect to the TEA. The rotation angle of the component with respect to the PCA can be toggled on in the side bar, if desired. Set axial rotation to the desired value.

3. Establish Sagittal Rotation

In the sagittal plane, the femur typically exhibits a natural anterior bow. During conventional surgical procedures, the femoral intramedullary rod approximates the distal 1/3 of the femur, which due to the sagittal bow of the femur creates approximately 4° of flexion with respect to the femur mechanical axis in the sagittal plane. The Mako (MAKOplasty) TKA Application displays sagittal rotation values with respect to the femur mechanical axis. To replicate referencing with an IM rod, the femoral component should be rotated $\geq 0^\circ$ flexion. Set component flexion to the desired value.



Sagittal rotation of the femoral component can be adjusted to fine tune the size, avoid anterior overhang, and avoid anterior notching.



If anterior femur notching is expected, a warning will be displayed in the Information Box.



The Mako (MAKOplasty) TKA Application predicts anterior femur notching by identifying if any part of the superior edge of the anterior cut stereotactic boundary is inside the bone. If the CT scan or femur segmentation is too short to include this region, then notching cannot be predicted. Edit the femur segmentation or obtain another CT scan that includes femur bone at least 20 mm above the superior femoral component flange tip.

4. Establish Resection Depth

The Mako (MAKOplasty) TKA Application displays resection depth as the distance from the planar cut to the selected resection depth landmark. Set the resection depth to the desired value. The surgeon can select from multiple resection depth options in Surgeon Preferences:

- 'Bone Resection' represents the measured resection thickness of the bone only. It does not include the thickness of the cartilage (if present).
- 'Estimated Cartilage' adds an estimated 2 mm of cartilage to the bone resection value. This may more closely represent the resection thickness on the non-diseased side as would be measured by a caliper.



For both varus and valgus knees, note the depth of the distal trochlear groove. If desired, distal condyle resection depth can be modified from the default plan to resect to the level of the native depth of the trochlear groove. Distal femur resection at the depth of the trochlear groove will create what is commonly referred to as a "butterfly" cut.



For a typical knee, the medial condyle extends more distally and posteriorly than the lateral condyle. The default plan will usually resect more medial condyle than lateral condyle.



Verify that the minimum resection depth on the diseased side is greater than or equal to the values recommended in Table 1 . Make adjustments as necessary.

5. Establish Size & Position

The optimal femoral component size is the largest component that does not overhang the anterior femur, does not notch the anterior femur, does not overhang the medial and lateral resected bone edges, and does not overstuff the patellofemoral compartment. Rotate any 3D View or use 'Slicer View' to check for overhang and overstuffing. Set the component to the desired size and center the component between the resected medial and lateral cortical edges.



Sagittal rotation of the femoral component can be adjusted to fine tune the size, avoid anterior overhang, and avoid anterior notching.



Both anterior and posterior referencing is supported via the drop down menu on the side panel. Posterior referencing will maintain the location of the posterior cut when upsizing/downsizing. Anterior referencing will maintain the location of the anterior flange cut when upsizing/downsizing.



The patellofemoral compartment can be best visualized in 'Slicer View' by moving the sagittal slice to the lowest depth of the trochlear groove.



The implant plan displays the desired component position. Mediolateral position of the femoral component is ultimately determined post-resection by the surgeon with the femoral trial during manual femoral peg preparation. The Sharp Probe (Blue) or Blunt Probe (Green) can be placed on the medial and lateral edges of the trial and compared to the planned placement to help guide final mediolateral component position.



The Mako (MAKOplasty) TKA Application will only allow the user to plan femoral and tibial component size combinations that are compatible with each other.



If anterior femur notching is expected, a warning will be displayed in the Information Box.



The Mako (MAKOplasty) TKA Application predicts anterior femur notching by identifying if any part of the superior edge of the anterior cut stereotactic boundary is inside the bone. If the CT scan or femur segmentation is too short to include this region, then notching cannot be predicted. Edit the femur segmentation or obtain another CT scan that includes femur bone at least 20 mm above the superior femoral component flange tip.



Osteophytes can give the appearance of a wider bone. Avoid centering the component using 'Resected View' only. The medial and lateral cortical bone edges at the planned resection depth are best visualized in 'Slicer View' by scrolling through the coronal and transverse views.

Table 1. Recommended femoral component planning guidelines

Femoral Component				
Positioning	Reference	Default / Range	KINETIS	Triathlon
Rotational Alignment				
Varus / Valgus Rotation	Mechanical Axis	Default	0° varus	0° varus
		Range	2° varus - 2° valgus	2° varus - 2° valgus
External Rotation	Transepicondylar Axis (TEA)	Default	0° external	0° external
		Range	PCA < 3° from TEA: <ul style="list-style-type: none"> • 0-3° external from TEA PCA > 3° from TEA: <ul style="list-style-type: none"> • Min 3° external from PCA • Max 3° external from TEA 	PCA < 3° from TEA: <ul style="list-style-type: none"> • 0-3° external from TEA PCA > 3° from TEA: <ul style="list-style-type: none"> • Min 3° external from PCA (for neutral tibia cut)* • Max 3° external from TEA
Flexion Rotation	Mechanical Axis	Default	4° flexed	2° flexed
		Range	2-6° flexed	0-5° flexed
Resection Depths				
Varus Knee	Distal and posterior lateral	Default	7 mm bone (9 mm estimated cartilage)	6 mm bone (8 mm estimated cartilage)
		Range	5-9 mm bone (7-11 mm estimated cartilage)	4-8 mm bone (6-10 mm estimated cartilage)
	Distal and posterior medial	Min	4 mm bone (6 mm estimated cartilage)	4 mm bone (6 mm estimated cartilage)
Valgus Knee	Distal and posterior medial	Default	9 mm bone (11 mm estimated cartilage)	8 mm bone (10 mm estimated cartilage)
		Range	7-11 mm bone (9-13 mm estimated cartilage)	6-10 mm bone (8-12 mm estimated cartilage)
		Distal and posterior lateral	Min	4 mm bone (6 mm estimated cartilage)
Size and Position				
Size	Posterior Referencing	Default	Largest size that does not: <ul style="list-style-type: none"> • Overhang anterior femur • Notch anterior femur • Overhang ML bone edges • Overstuff the PF joint 	Largest size that does not: <ul style="list-style-type: none"> • Overhang anterior femur • Notch anterior femur • Overhang ML bone edges • Overstuff the PF joint
Position	ML Cortical Bone Edges	Default	Center between ML cortical bone edges	Center between ML cortical bone edges

* If the tibial cut is placed in varus, then < 3° external rotation of the femur can be considered.

** The surgeon has the ability to deviate from the default references and positioning values based on the clinical needs of the patient.

Tibial Component

1. Establish Coronal Rotation

In the coronal plane, the tibia anatomic and mechanical axes are nearly collinear. The Mako (MAKOplasty) TKA Application displays coronal rotation values with respect to the Tibia Mechanical Axis. Set the coronal rotation to the desired value.

2. Establish Axial Rotation

In the transverse plane, the Mako (MAKOplasty) TKA Application displays axial rotation values with respect to the 'Tibia AP Axis'. Set axial rotation to the desired value.



Symmetric tibial components will typically leave uncovered bone in the posterior-medial region. Avoid attempting to maximize posterior-medial coverage because this could lead to excessive internal rotation of the tibial component.

3. Establish Tibial Slope

In the sagittal plane, the Mako (MAKOplasty) TKA Application displays slope values with respect to the Tibia Mechanical Axis. Set posterior slope to the desired value.



Native medial and lateral compartment slopes can be best visualized in 'Slicer View' by moving the sagittal slice to the medial and lateral resection landmarks, respectively.

4. Establish Resection Depth

The Mako (MAKOplasty) TKA Application displays resection depth as the distance from the planar cut to the selected resection depth landmark. The surgeon can select from multiple resection depth options in Surgeon Preferences.

- 'Bone Resection' represents the measured resection thickness of the bone only. It does not include the thickness of the cartilage (if present).
- 'Estimated Cartilage' adds an estimated 2 mm of cartilage to the bone resection value. This may more closely represent the resection thickness on the non-diseased side as would be measured by a caliper.



For a varus knee, the lateral plateau is typically more prominent relative to the diseased medial plateau; therefore, the default plan will likely resect more bone from the lateral plateau. For a valgus knee, the typically more prominent lateral plateau is diseased; therefore, the default plan might resect approximately equal amounts of bone on the lateral and medial plateaus.



Verify that the minimum resection depth on the diseased side is greater than or equal to the values recommended in Table 2 . Make adjustments as necessary.

5. Establish Size & Position

The optimal tibial component size is the largest component that does not overhang the perimeter of the tibial plateau. Rotate any 3D View or use 'Slicer View' to check for overhang. Set the component to the desired size. Center the component between the resected medial and lateral cortical edges. Center the component between the resected anterior and posterior cortical edges on the lateral side.



The implant plan displays the desired component position. Anteroposterior (AP) and Mediolateral (ML) position and axial rotation of the tibial component is ultimately determined post-resection by the surgeon with the baseplate trial during manual tibial keel preparation. The Sharp Probe or Blunt Probe can be placed on the medial, lateral, and anterior edges of the trial and compared to the planned placement to help guide final component position.



Use the thinnest tibial insert thickness when pre-operatively planning. If necessary, additional bone can be resected.



The Mako (MAKOplasty) TKA Application will only allow the user to plan femoral and tibial component size combinations that are compatible with each other.



Symmetric tibial components will typically leave uncovered bone in the posterior-medial region. Avoid attempting to maximize posterior-medial coverage because this could lead to excessive internal rotation of the tibial component.



Osteophytes can give the appearance of a larger tibial plateau. Avoid centering the component using 'Resected View' only. The cortical bone edges at the planned resection depth are best visualized in 'Slicer View' by scrolling through the coronal, transverse, and sagittal views.

Table 2. Recommended tibial component planning guidelines

Tibial Component				
Positioning	Reference	Default / Range	KINETIS	Triathlon
Rotational Alignment				
Varus / Valgus Rotation	Mechanical Axis	Default	0° varus	0° varus
		Range	2° varus - 2° valgus	2° varus - 2° valgus
External Rotation	Tibia AP Axis	Default	0° external	0° external
		Range	0-5° external	0-5° external
Posterior Slope	Mechanical Axis	Default	CR: 5° posterior slope UC: 5° posterior slope	CR: 3° posterior slope CS (PCL retaining): 3° posterior slope CS (PCL sacrificing): 0° posterior slope PS: 0° posterior slope
		Range	CR: 2-8° posterior slope UC: 2-8° posterior slope	CR: 0-3° posterior slope CS: 0-3° posterior slope PS: 0-1° posterior slope
Resection Depths				
Varus Knee	Lateral	Default	7 mm bone (9 mm estimated cartilage)	7 mm bone (9 mm estimated cartilage)
		Range	5-9 mm bone (7-11 mm estimated cartilage)	5-9 mm bone (7-11 mm estimated cartilage)
	Medial	Min	2 mm bone (4 mm estimated cartilage)	2 mm bone (4 mm estimated cartilage)
Valgus Knee	Medial	Default	5 mm bone (7 mm estimated cartilage)	5 mm bone (7 mm estimated cartilage)
		Range	3-7 mm bone (5-9 mm estimated cartilage)	3-7 mm bone (5-9 mm estimated cartilage)
	Lateral	Min	2 mm bone (4 mm estimated cartilage)	2 mm bone (4 mm estimated cartilage)
Size and Position				
Size	Best Coverage	Default	Largest size that does not overhang AP and ML	Largest size that does not overhang AP and ML
Position	AP and ML Cortical Bone Edges	Default	Center between AP and ML cortical bone edges	Center between AP and ML cortical bone edges

** The surgeon has the ability to deviate from the default references and positioning values based on the clinical needs of the patient.

Confirm Plans

1. Overall Limb Alignment

Confirm that the sum of the femoral and tibial component coronal rotations are less than or equal to the values recommended in Table 3 . Make adjustments as necessary.



Same rotation labels add together, whereas opposite rotation labels subtract from each other. For example, if the femoral component is in 1° of varus and the tibial component is also in 1° of varus, the overall limb alignment will be 2° of varus. On the other hand, if the femoral component is in 1° of valgus and the tibial component is in 2° of varus, the overall limb alignment will be 1° of varus.

2. Combined Sagittal Rotation

Confirm that the sum of the femoral and tibial component sagittal rotations are less than or equal to the values recommended in Table 3 . Make adjustments as necessary.



If the combined sagittal rotation is over the maximum threshold per Table 3 , a warning will be displayed in the Information Box.

3. Total Combined Resection

Confirm that the sum of the femur and tibia resections on the least diseased side are equal to the sum of the femoral and tibial component condyle thicknesses as recommended in Table 3 . Make adjustments as necessary.

Table 3. Recommended combined implant planning guidelines.

Combined Positioning				
Positioning	Reference	Default / Range	KINETIS	Triathlon
Overall Limb Alignment	Femoral + Tibial coronal rotation	Default	0° varus	0° varus
		Range	3° varus - 3° valgus	3° varus - 3° valgus
Combined Tibiofemoral Hyperextension	Femoral flexion + Tibial slope	Max	14° combined rotation	8° combined rotation
Combined Tibiofemoral Resection	Femur + Tibia resection depth (least diseased compartment)	Minimum	14 mm bone (18 mm estimated cartilage)	13 mm bone (17 mm estimated cartilage)

** The surgeon has the ability to deviate from the default references and positioning values based on the clinical needs of the patient.

MAKO TKA SURGICAL TECHNIQUE



The work flow described in this section can be implemented by a standard OR team (Surgeon, Physician Assistant, Surgical Technologist and Circulating Nurse) with the addition of a Mako Product Specialist (MPS). The Mako (MAKOplasty) Total Knee Application software is designed to be operated from the Guidance Module by the MPS under the direction of the operative surgeon.

A. PATIENT POSITIONING

Sterile Staff Member

It is possible for the surgical staff to complete all steps of Patient Positioning and Mako System Setup without the surgeon. This can greatly improve the efficiency of the Mako TKA procedure.

1. Patient position: Orient the patient in the supine position on the surgical table and align the patient with the long axis of the surgical table. Ensure that the operative leg can be maximally flexed when the heel is aligned with the end of the table. Confirm that the non-operative knee can freely drop off the end of the table when flexed to 90°. Use a stirrup or alternate device to protect the non-operative leg from soft tissue damage due to the weight of the overhanging leg during the case.
2. Drape the patient.



For best results, bias the medial/lateral patient position such that the hip, knee and ankle on the operative side are close to the edge of the surgical table.

3. Leg Positioner setup: Stryker provides a Leg Positioner for the Mako TKA procedure. Secure the patient's foot and proximal tibia into the leg holder boot. Securing the tibia tightly in the boot will help to stabilize the knee during bone resection (refer to the *Leg Positioner User Guide (PN 210470)* for detailed instructions)

B. MAKO SYSTEM SETUP

This section briefly describes how to setup the Mako System for use in the operating room. Reference the *Mako TKA Application User Guide (PN 210467)* and the *Mako System User Guide (PN 210711)* for detailed information.

1. OR layout

Sterile Staff Member

Setup the Mako System for a right or left leg, as depicted in Figure 3. Based on surgeon preference, the surgeon may stand on the operative side or at the end of the surgical table, between the patient's legs.

2. Start the Mako (MAKOplasty) TKA Application

Mako Product Specialist

To start the application, click 'TKA' from the 'Startup' page of the Mako (MAKOplasty) TKA Application.

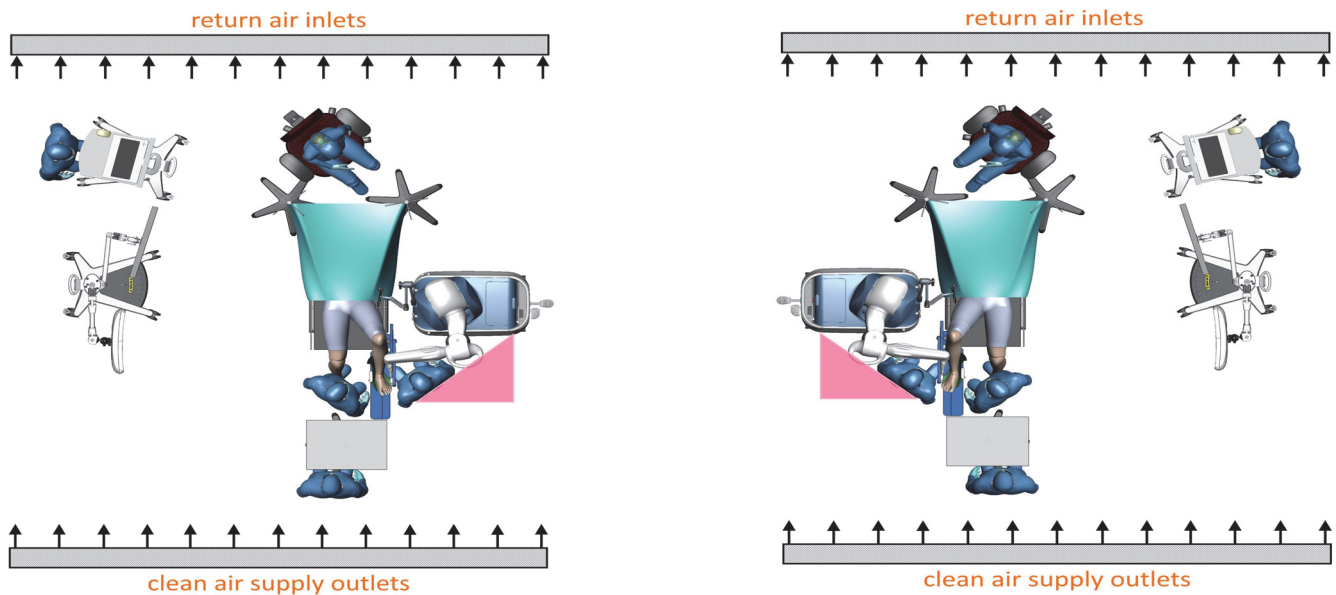

Figure 3. OR Layout (Left Knee and Right Knee)



To prevent injury to the surgeon, surgical staff, and/or the patient, move the cutting tool to a safe location when not in use. If the cutting tool is placed in a high risk region (triangle region above), a chime will play to prompt the user to move the cutting tool.

The Robotic Arm is located on the operative side, and the Camera Stand is located opposite the Robotic Arm. Since direct-line-of-sight is required for all tracking arrays, the non-operative side must be free of camera obstruction during steps of the procedure that require real-time tracking (e.g., ‘Bone Registration’, ‘Bone Preparation’). It is recommended to place the camera directly across from the Robotic Arm, or slightly towards the patient’s head, to allow a surgical assistant to assist in the procedure without blocking direct-line-of-sight between the camera and the bone arrays or probes. Aim the camera toward the knee joint using the laser alignment guide on the camera.

Place the Surgeon Monitor in a comfortable viewing location for the surgeon. The Guidance Module should be located where the MPS can maintain direct observation of the surgeon.

3. Robotic Arm draping

Sterile Staff Member

To drape the Robotic Arm, click ‘Draping Mode’ under the ‘Options’ menu, and install the sterile drape per standard draping instructions (refer to the *Mako TKA Application User Guide (PN 210467)* and *Mako System User Guide (PN 210711)*).

4. MICS Handpiece assembly to Robotic Arm

Sterile Staff Member

While still in ‘Draping Mode’, attach the MICS Handpiece to the Robotic Arm. Ensure the Mako (MAKOplasty) TKA Application is started before draping the Robotic Arm. This will ensure that when ‘Draping Mode’ is released, ‘Standby Mode’ will engage and prevent the Robotic Arm from dropping below sterile height.

To maintain sterility and to keep the weight at the end of the Robotic Arm consistent for ‘Standby Mode’, route the MICS Handpiece cable along the Robotic Arm and secure the cable using the supplied Velcro tabs.

5. MICS Saw blade assembly

Sterile Staff Member

Assemble the appropriate MICS Saw Blade to the MICS Attachment used for the first resection in the selected cutting sequence.



Press the Information Icon in the upper right corner of the screen to identify the saw blade types (standard or narrow) required for the pre-operatively planned components.



Only Stryker supplied MICS Saw Blades specific for a Mako TKA procedure may be used in conjunction with the MICS System.

6. VIZADISC assembly

Sterile Staff Member

Assemble VIZADISC to all tracking arrays and probes.

7. Probe Check

Sterile Staff Member

While holding the Knee End Effector Array near the knee joint, place the Blunt Probe tip into the Knee End Effector Array divot. When both the Knee End Effector Array and probe tip are visible to the camera, the system will automatically check probe tip accuracy. Repeat for the Sharp Probe.

8. RIO Setup -- Initial Position

Sterile Staff Member/Mako Product Specialist

- Center the Robotic Arm base at the patient's hip, perpendicular to the surgical table, and about 3-5 feet from the surgical table.
- Move the Robotic Arm into the alignment zone (the displayed image on the surgeon monitor will have a yellow outline).

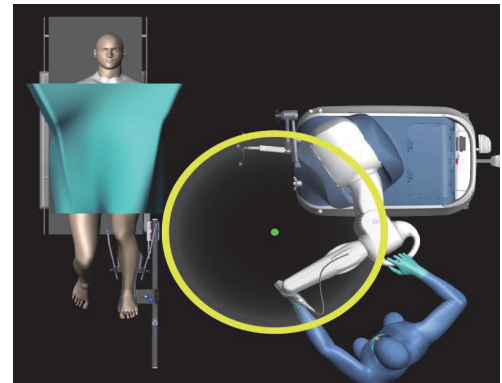

Figure 4. RIO Setup Initial Position

- c. Press and hold the trigger on the MICS Handpiece. The Robotic Arm will perform surgeon enabled motorized alignment to the setup position. Once the Robotic Arm is aligned, release the trigger on the MICS Handpiece (the displayed image on the surgeon monitor will have a green outline).

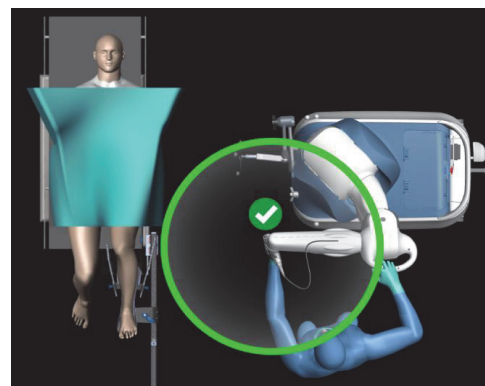

Figure 5. RIO Setup Motorized Alignment



If it appears that the Robotic Arm or MICS Handpiece will collide with the patient or another object during surgeon enabled motorized alignment, release the MICS Handpiece trigger to stop motorized alignment. Once the space is cleared, re-press the MICS Handpiece trigger to initiate motorized alignment again.



Ensure that the MICS Handpiece handle is locked into its neutral position prior to performing 'RIO Setup'.

- d. Flex the knee to 90° flexion, and roll the Robotic Arm into position such that:
- Mako Centerline (refer to red line in adjacent image) is perpendicular to the table rail. The front of the Mako is parallel with the table rail.
 - The MICS handle is directly above knee center.
 - There is a fist width of space between the bottom of the MICS handle and the knee joint. Adjust the table height to accommodate this space.
 - Lower the Robotic Arm onto its feet.

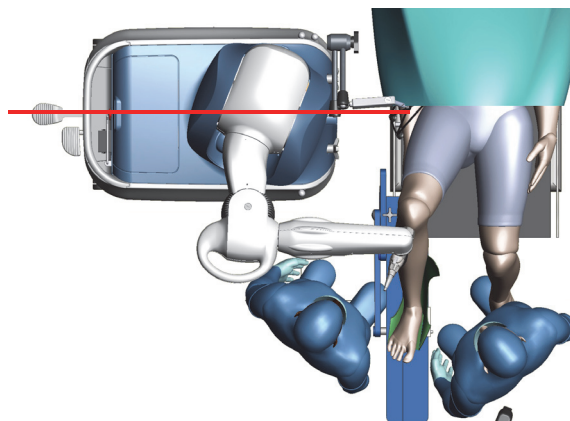

Figure 6. Mako Centerline

- e. Note the position of the MICS Handpiece handle. The Knee Center Point (optimal surgery center) will be approximately 100 mm (4 inches, or one fist width) below the handle.



The region surrounding the Knee Center Point is where bone resection will occur.

9. RIO Registration

Sterile Staff Member/Mako Product Specialist

The RIO Registration process registers the end of the Robotic Arm to the Robotic Arm Base Array. The steps below assume that the patient is already on the surgical table, the surgeon has not yet made the incision, and the sterile surgical staff completes these steps.



The MICS Handpiece must be connected to the Robotic Arm prior to 'RIO Registration.' Failure to do so may prevent the cutting system from starting in the 'Bone Preparation' page. 'RIO Registration' should begin with the Robotic Arm in the same position and orientation as used during bone resection.



Registering the Robotic Arm while lifted onto its feet can create instability and lead to inaccurate registration. Prior to RIO Registration, lower the Robotic Arm onto its feet by pressing on the release pedal. If the Robotic Arm is not seated on the floor an icon will appear in the Main Window.



- a. Before proceeding, ensure the Robotic Base Array arm is positioned, oriented, and secured as described in the *Mako TKA Application User Guide (PN 210467)*.
- b. The MICS Handpiece serial number is automatically uploaded onto the Mako. If the upload is successful, the MICS serial number will appear in grey text. However, if the upload is unsuccessful, perform the following steps:
 - Select the MICS Handpiece serial number from the drop down list
 - Select the 'Reset Cutter' option from the 'Options' menu.

If the MICS Handpiece is changed intra-operatively, refer to the *Mako TKA Application User Guide (PN 210467)* section titled 'MICS Handpiece Not Powering ON' for trouble-shooting suggestions.

- c. Attach the Registration Tool and Knee End Effector Array to the MICS Handpiece. Ensure that the Knee End Effector Array is fully seated on the ball tip of the Registration Tool.
- d. Move the Robotic Arm such that the Knee End Effector Array is near the Knee Center Point as noted in the RIO Setup step above. Ensure the Knee End Effector Array is pointed toward the camera. Place the leg into extension if it is in proximity to the Knee End Effector Array or if it appears it will block line of sight to the camera.
- e. Perform RIO Registration by collecting points at each corner of the registration cube. The Robotic Arm must be steady at each corner prior to point collection. Ensure that the Knee End Effector Array is consistently facing the camera during this step. Moving the Robotic Arm elbow left or right or rotating the MICS Handpiece about the Robotic Arm wrist joint can keep the Knee End Effector Array consistently facing the camera.
- f. Perform RIO Verification. Point the MICS Handpiece and Knee End Effector Array toward the floor and start verification. Once prompted, rotate the MICS Handpiece 120° toward the ceiling and hold the MICS Handpiece steady. Ensure that the Knee End Effector Array is consistently facing the camera during this step.
- g. Remove the Registration Tool and Knee End Effector Array from the MICS Handpiece.



Some surgeons prefer to have the Mako next to the surgical table only during 'Bone Preparation'. To accommodate this workflow, move the Mako away from the surgical table after completing 'RIO Registration'. Prior to 'Bone Preparation', return to the 'RIO Setup' page and complete the 'RIO Setup' steps listed above.

C. EXPOSURE

Patient Time Out

Surgeon/Mako Product Specialist

The surgeon must confirm with the MPS that the correct Patient Name, Patient ID, Operative Side, and Implant System are selected. It is recommended that this step is included in the required operative time out at the beginning of the procedure.

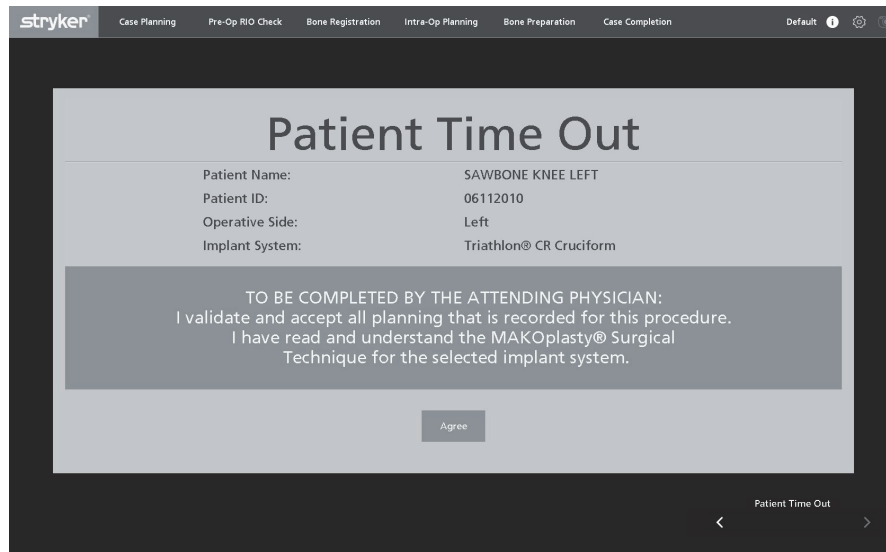

Figure 7. Patient Time Out

Incision and Arthrotomy

Surgeon

Once the patient is draped and the tourniquet is inflated, the incision and arthrotomy can be made. The mid-vastus surgical approach will be defined below; however, the surgeon should dictate the incision size and the type of surgical approach. Management of the patella, removal of the fat pad, and associated retractor placement is also based on surgeon preference.

1. Make a midline skin incision starting just proximal and medial to the superior aspect of the patella and extending to the patellar tendon insertion on the tibial tubercle. The proximal extent of the incision should be as long as necessary to obtain adequate exposure, and should be centered on the joint line to enable adequate visualization of the anatomy, insertion of the femoral component into the joint, and bone registration.
2. Make a medial parapatellar arthrotomy through the medial retinaculum, capsule, and synovium. Proximally dissect the superficial fascia proximally (4-8 cm). Dissect the oblique fibers of the vastus medialis proximally (1-2 cm).
3. Mobilize the patella by dissecting soft tissue circumferentially around the patella.
4. If performing a posterior cruciate ligament (PCL) retaining procedure, evaluate and confirm the integrity of the PCL.
5. Resect the anterior cruciate ligament.
6. Resect the anterior horns of the meniscus, where possible.

Retraction

Surgeon/Sterile Staff Member

Tissue retraction and protection can be managed according to surgeon preference. Based on the footprint of the Robotic Arm in the operating room as well as the line of sight required between the bone arrays and the camera. Multiple surgical assistants may not be able to work in a conventional manner; therefore, the Leg Positioner Self-Retractor System should be considered.



The Leg Positioner Self-Retractor System is an optional system. The surgeon may elect to use other retractors based on preference.



The stereotactic boundary used to constrain the saw blade is generated based on the implant size, shape and plan. The Robotic Arm does not have the ability to track the patient's soft tissue structures. It is recommended to use standard retraction techniques during cutting.



Use caution when using the Leg Positioner Self-Retractor System. Over tensioning of the self-retractors can cause ligament or soft tissue damage.

1. Place a Smiley or Z-retractor laterally to protect the patella tendon, iliotibial band, popliteus tendon, and lateral collateral ligament.
2. Place a Smiley or Z-retractor medially to protect the medial collateral ligament.
3. Place the Patella Retractor or a bent collateral retractor to retract and protect the patella.
4. If desired, secure the Leg Positioner Self-Retractor System with Silicone Retractor Cords or the standard retractors using sterile Velcro or lap sponges.
5. During preparation of the tibia, place the PCL Retractor anterior to the ligament for increased protection.

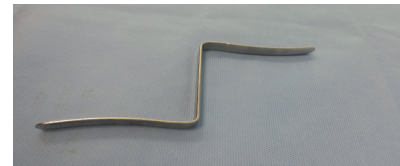

Figure 8. Z-retractors can be used to protect the collateral ligaments.



Figure 9. Bent collateral retractors can be used to retract the patella.



Stereotactic boundaries help protect the cutting tool from injuring soft tissues; however, patient anatomy, implant plan, and surgeon specific techniques are variable. The surgeon is responsible for properly retracting soft tissues during bone resection, including but not limited to: collateral ligaments, patellar tendon, quadriceps mechanism, and PCL.



Figure 10. Retractors can be self-retaining to minimize the number of surgical assistants required

D. BONE ARRAY PLACEMENT

Surgeon/Sterile Staff Member

For additional information regarding bone pin placement, reference the *Mako TKA Application User Guide (PN 210467)*.

The Femur and Tibia require 2 Bone Pins for each array clamp construct.

- For the 4.0 mm Bone Pin, use the Square Drill Adapter.
- For the 3.2 mm Bone Pin, use a Pin Driver (not provided).



A Pin Driver (not provided) can be used to insert either 4.0 mm and 3.2 mm Bone Pins



The Square Drill Adapter can be used with any surgical drill.

Bone Pin Insertion (Tibia only)

Surgeon/Sterile Staff Member



For proper use of the Array Stabilizer, ensure that only 3.2 mm diameter bone pins are used with the 3.2 mm Array Stabilizer and 4.0 mm diameter bone pins are used with the 4.0 mm Array Stabilizer. Bone Pin diameter selection is at the discretion of the operative surgeon based on patient variables and surgeon technique.

1. Using a scalpel, make one incision through the skin and fascia a minimum of 10 cm (approximately four finger breadths) inferior to the tibial tubercle and 1-1.5 cm medial to the tibial crest.
2. The second incision can be completed by using either of the following methods:
 - a. Make the second stab incision approximately 15 mm distal to the previous incision, or
 - b. Place the most proximal sleeve of the Array Stabilizer through the first incision and make an incision where the distal sleeve rests on the skin.
3. Fully seat the Array Stabilizer through both incisions so that the barrels are on the bone surface.
4. Drive one of the bone pins through the first cortex and pierce the second cortex.
5. While holding the Array Stabilizer in place, drive the second bone pin through the first cortex and pierce the second cortex.

Bone Pin Insertion (Femur only)

Surgeon/Sterile Staff Member



For proper use of the Array Stabilizer, ensure that only 3.2 mm diameter bone pins are used with the 3.2 mm Array Stabilizer and 4.0 mm diameter bone pins are used with the 4.0 mm Array Stabilizer. Bone Pin diameter selection is at the discretion of the operative surgeon based on patient variables and surgeon technique.

1. Flex the knee to > 90° to elongate the quadriceps muscles.

2. Using a scalpel, make one incision through the skin and the fascia a minimum of 10 cm (approximately four finger breadths) proximal to the superior edge of the patella and 30-35° medial of the midline.



Surgeon Tip: Sublux the patella prior to pin incision.



Placing the bone pins approximately 30-35° medial of midline avoids “spearing” the quadriceps muscle group which may apply pressure and potentially move the bone pins when the knee is flexed.



To minimize the risk of post-operative femoral stress fractures, avoid placing the femur bone pins in the diaphysis of the femur.

3. The second incision can be completed by using either of the following methods:
 - a. Make the second stab incision approximately 15 mm proximal to the previous incision, or
 - b. Place the most distal sleeve of the Array Stabilizer through the first incision and make an incision where the proximal sleeve rests on the skin.
4. Fully seat the Array Stabilizer through both incisions so that the barrels are on the bone surface.
5. Drive one of the bone pins through the first cortex and pierce the second cortex.
6. While holding the Array Stabilizer in place, drive the second bone pin through the first cortex and pierce the second cortex.

Array Assembly (Femur and Tibia)

Surgeon/Sterile Staff Member

1. Loosely assemble the Pelvic Array Adaptor and 2-Pin Clamp.
2. Sliding the clamp over the bone pins seat the clamp against the top of the Array Stabilizer. Orient the assembly such that the clamp’s screw points away from the camera and the Pelvic Array Adaptor’s screw points away from the incision.
3. Attach the Knee Femoral Array to the Pelvic Array Adaptor.

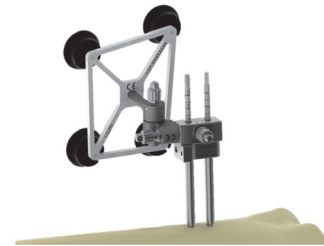

Figure 11. Array Assembly

4. Position the array as desired.
5. Using the Square Driver, sufficiently tighten the screws in this order:
 - a. Array screw
 - b. Pelvic Array Adaptor screw
 - c. Clamp screw.



It is important to tighten the clamp screw last. If the other screws are tightened last (especially the array screw), the torque applied can twist the bone pins slightly, and the tightened clamp can hold the pins in this twisted orientation. Vibration from bone resection can rotate the pins back into neutral position, creating errors in bone registration.



To reduce the amount of torque applied to the bone during assembly, hold the array assembly stationary when tightening the three thumb screws.

6. Verify the assembly is rigid.
7. Repeat steps 1-6 for the Knee Tibial Array.



Ensure that the arrays are aligned such that both the Knee Tibial and Knee Femoral arrays are parallel to each other, the sagittal plane, and the camera. This will ensure the arrays are visible throughout range of motion.



The connections within the Array Assembly must be aligned properly engaging the apposed serrations to prevent loss of bone registration during the case. The below image to the left shows proper assembly, the image to the right shows improper assembly.

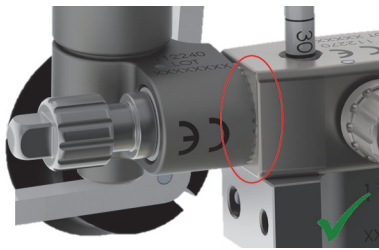
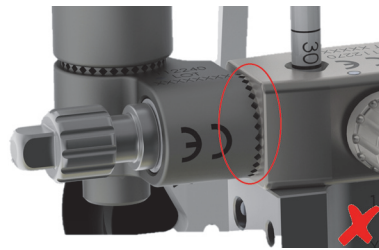

Figure 12. Proper Assembly



Improper Assembly

Camera View

Mako Product Specialist

Adjust the camera such that all tracking arrays are visible from full extension to full flexion.

E. BONE REGISTRATION

'Bone Registration' is comprised of three distinct steps: Patient Landmarks, Bone Checkpoints, and Bone Registration and Verification.

Patient Landmarks

Surgeon/Mako Product Specialist

The Patient Landmarks are at the extreme ends of the limb (proximal femur and distal tibia). These landmarks (points) are critically important to setting the mechanical axes of the bones, which are used to compute coronal (varus/valgus) and sagittal (flexion/extension) alignment.

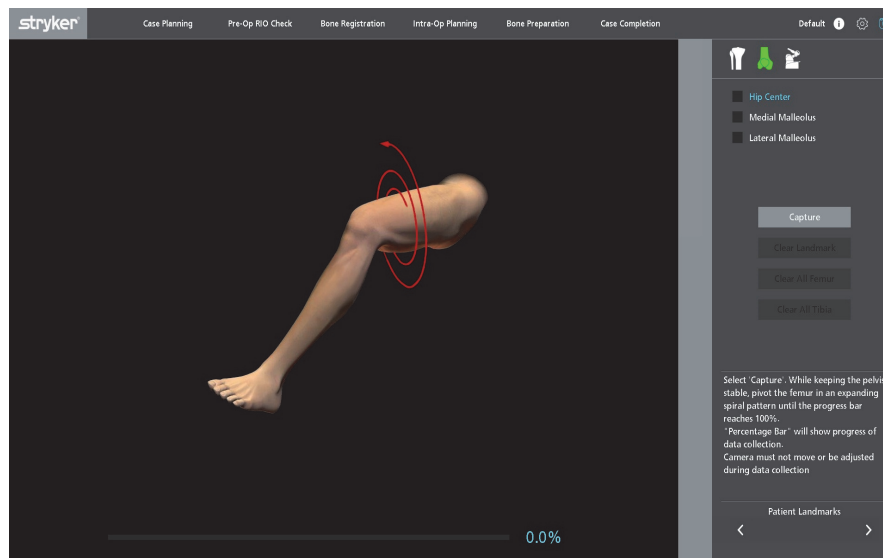

Figure 13. 'Patient Landmarks' Page

1. 'Hip Center'. While keeping the pelvis stable, pivot the femur (circumduct hip) in an expanding spiral pattern until the progress bar reaches 100%.



The camera must not move during collection of the 'Hip Center'.

2. Medial Malleolus. Collect this point on the skin surface as closely as possible to the same location as identified in the 'CT Landmarks' page. Palpate the anterior and posterior corners of the medial malleolus. Place the Blunt Probe (Green) tip halfway between these two corners and select 'Capture' button to collect the landmark.
3. Lateral Malleolus. Collect this point on the skin surface as closely as possible to the same location as identified in the 'CT Landmarks' page. Palpate the anterior and posterior corners of the lateral malleolus. Place the probe tip halfway between these two corners and select 'Capture' button to collect the landmark.

Bone Checkpoints

Surgeon

1. Femur Checkpoint. The grey region and black dashed line represent the approximate region of bone that will be removed during bone preparation. Ensure that the Femur Checkpoint is placed in hard bone and located approximately 10 mm away from the nearest femur cut. Collect and verify the Femur Checkpoint.

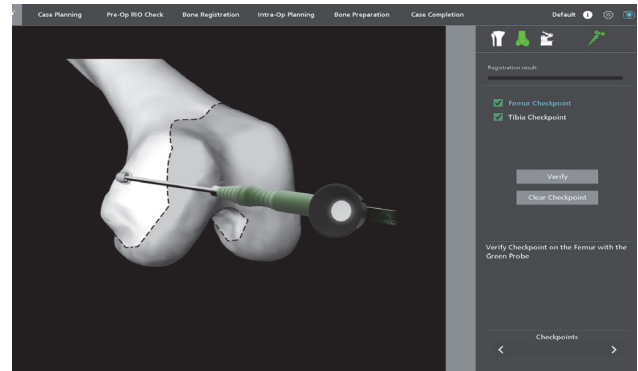

Figure 14. Femur Checkpoint

2. Tibia Checkpoint. The grey region and black dashed line represent the approximate region of bone that will be removed during bone preparation. Ensure that the Tibia Checkpoint is placed in hard bone and located approximately 10 mm away from the tibia cut. Collect and verify the Tibia Checkpoint.

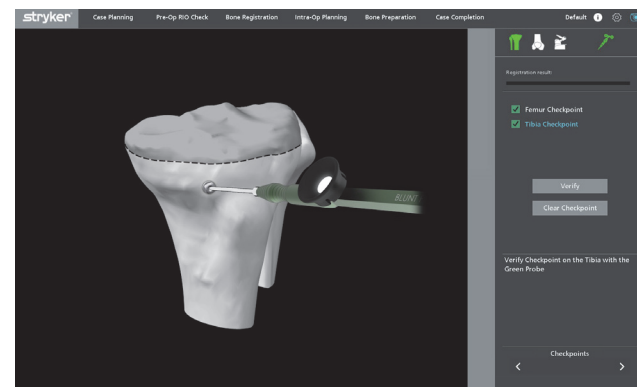

Figure 15. Tibia Checkpoint





Place checkpoints as far as reasonably possible from the resection planes to avoid inadvertent resection during 'Bone Preparation'. In the event the checkpoint is placed too close to the planned resection, a warning message will appear.

Bone Registration & Verification

Surgeon

Each of the femur and tibia bone registration patterns consist of 40 points (10 groups of 4 points each). The points are critically important in setting the AP, ML, proximal/distal directions, and the axial rotation (internal/external) alignment of each bone.

The patient specific model is derived from a CT scan, and only the bony anatomy is segmented. Therefore, bone registration points must be collected on bone. When points are collected in regions that are covered in cartilage, use the Sharp Probe to penetrate the cartilage and stop on the bone surface.

	Large blue sphere: represents the point to collect
	Small blue sphere: represents remaining points to be collected within the current group
	Small white sphere: represents remaining points to be collected outside the current group

Femur

1. Femur bone registration. Collect all 40 bone registration points, and attempt to place the Sharp Probe tip in the same location as displayed on the screen. Ensure that the Sharp Probe tip is resting on bone for each point and press 'Capture' to collect each registration point. If a point is partially or completely occluded by an osteophyte, collect the point on the bone slightly away from the osteophyte.

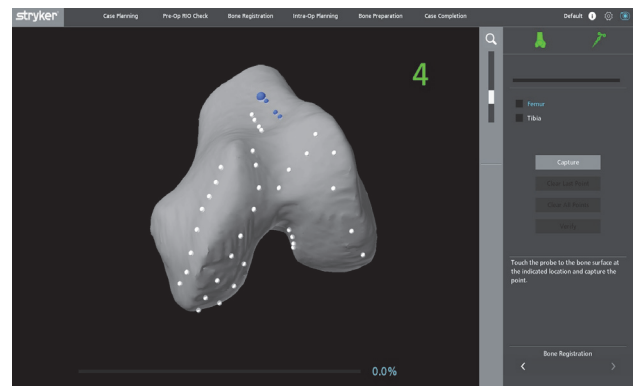

Figure 16. Femur Bone Registration



If cartilage is still present on the articular surface, pierce it with the Sharp Probe tip to reach bone.

2. Femur bone verification. Collect all 6 verification points. When the Sharp Probe tip is within 6 mm from a verification sphere, the sphere will turn transparent enabling point collection. If a point is partially or completely occluded by an osteophyte, collect the point as closely as possible to the verification point.

Tibia

1. Tibia bone registration. Collect all 40 bone registration points, and attempt to place the Sharp Probe tip in the same location as displayed on the screen. Ensure that the Sharp Probe tip is resting on bone for each point and press 'Capture' to collect each registration point. If a point is partially or completely occluded by an osteophyte, collect the point on the bone slightly away from the osteophyte.

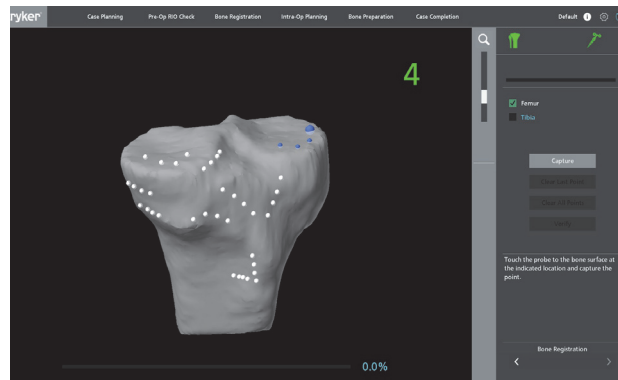

Figure 17. Tibia Bone Registration



If cartilage is still present on the articular surface, pierce it with the Sharp Probe tip to reach bone.

2. Tibia bone verification. Collect all 6 verification points. When the Sharp Probe tip is within 6 mm from a verification sphere, the sphere will turn transparent enabling point collection. If a point is partially or completely occluded by an osteophyte, collect the point as closely as possible to the verification point.



Surgeon Tip. An alternate method to verify tibia axial rotation is to place thumb and index finger on either side of the tibial tubercle, place Sharp Probe tip between the 2 fingers, visually confirm on-screen that the probe tip is centrally located on the tibial tubercle.



Surgeon Tip. An alternate method to verify tibia coronal alignment is to place the Sharp Probe on the medial and lateral malleoli, visually confirm on-screen that the tip is the same distance from the medial malleolus as from the lateral malleolus.

F. INTRA-OPERATIVE PLANNING

Depending on the procedure workflow selected in Surgeon Preferences, the Mako (MAKOplasty) TKA Application will follow one of the following two workflows:

- Measured Resection
- Ligament Balancing.

Measured Resection

The 'Measured Resection' workflow utilizes planned resections of the distal femur, posterior femur, and proximal tibia. Ligament tension is not directly considered, but instead will be assessed later during trialing.

Selection of the 'Measured Resection' workflow utilizes the 'Joint Balancing' and 'Implant Planning' pages.

Joint Balancing

- The 'Joint Balancing' page provides real-time limb alignment tools to facilitate assessment of the knee joint. Biomechanical issues such as flexion contracture, recurvatum, fixed varus/valgus deformity, and limited flexion may require intra-operative changes to the implant plan.

- Overall limb alignment (varus/valgus), knee flexion/extension, and knee internal/external rotation are all displayed in real-time and continuously update throughout range of motion knee assessment. The surgeon assesses the knee and utilizes the information displayed on-screen as desired.

Implant Planning

- The intra-operative 'Implant Planning' page provides a set of tools to customize the implant plan to the patient's bony anatomy. This page utilizes a resection based approach because force based gaps are not directly considered. Information collected or observed on the 'Joint Balancing' page might require intra-operative adjustments to the implant plan.

Workflow

Surgeon

1. While in the 'Joint Balancing' page, bring the leg into extension and note if there is flexion contracture or recurvatum.
2. Attempt to correct the varus or valgus deformity to the desired overall limb alignment. Note the corrected angle.
3. Throughout the range of motion, assess the laxity of the knee joint.
4. Flex the knee to maximum and note the angle.



The 'Joint Balancing' page can also be used during trialing to determine if the biomechanical issues described above were corrected prior to implantation.

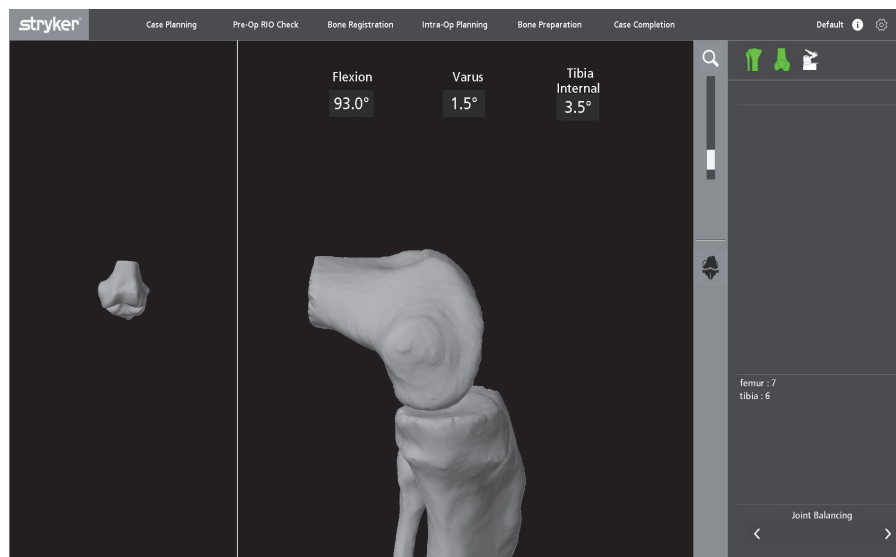

Figure 18. 'Joint Balancing' Page

5. Advance to the 'Implant Planning' page. If biomechanical issues were observed in 'Joint Balancing' (such as flexion contracture, recurvatum, fixed deformity, laxity, or limited flexion), make planning changes as desired.

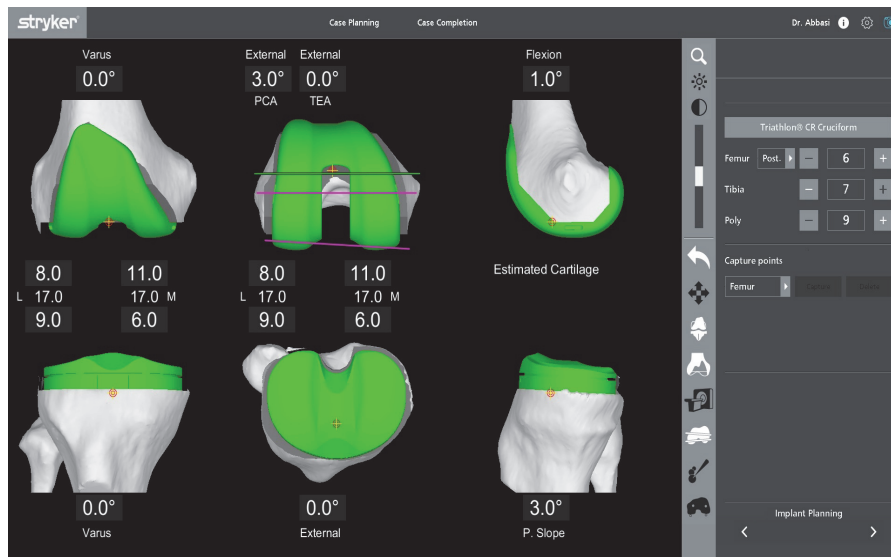

Figure 19. 'Implant Planning' Page

6. To establish the actual cartilage thickness and joint line, cartilage points can be collected near the Resection Points by using the 'Point Mapping' feature. The implants can then be planned with respect to these collected cartilage points. Examples include:
 - Map the sulcus pathway of the trochlear groove to align the femoral component trochlear groove to the patient's trochlear groove.
 - Mark the location of etched lines on the implant visual onto the bone with methylene blue. These markings can be used during trialing to match the trial position to the planned position.



Points captured intra-operatively are displayed in yellow.

7. Confirm that the total combined resections in extension and flexion are at the desired level.
8. Review each 3D view for overhang and underhang. 'Slicer View' is effective at being able to visualize the cortical bone edges if an osteophyte is present. Make planning changes as necessary.
9. Femoral component adjustments can affect the position of the anterior flange. Confirm that the femoral component is sized correctly, not overhanging the anterior femur, not notching the anterior femur, and not overstuffing the patellofemoral joint.



Sagittal rotation of the femoral component can be adjusted to fine tune the size, avoid anterior overhang, and avoid anterior notching.



If anterior femur notching is expected, a warning will be displayed in the Information Box.



The Mako (MAKOplasty) TKA Application predicts anterior femur notching by identifying if any part of the superior edge of the anterior cut stereotactic boundary is inside the bone. If the CT scan or femur segmentation does not include this region, then the warning cannot be displayed. Edit the femur segmentation or obtain another CT scan that includes femur bone at least 20 mm above the superior femoral component flange tip.

10. Using 'Resection View', identify regions where the standard stereotactic boundaries might not be sufficient to resect all bone. In these regions, the Extended (Stereotactic) Boundary might be necessary. Refer to 'Resection View' section under 'Planning Features' on page 40.
11. Once the implant plan is finalized, proceed to 'Bone Preparation'.

Ligament Balancing

The ‘Ligament Balancing’ workflow (also known as gap balancing) applies proper tension to the knee joint in extension and flexion. The surgeon can then finalize the implant plan to obtain near equal medial and lateral gaps, as well as balanced extension and flexion gaps. There are two ligament balancing techniques described below:

- Distal/Tibia Cut First
- Pre-Resection Balancing

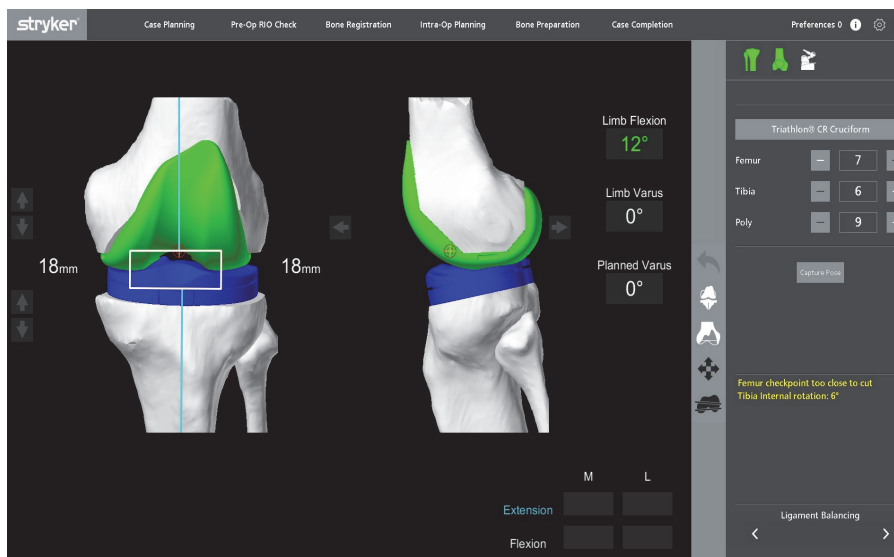

Figure 20. ‘Ligament Balancing’ Page

Distal/Tibia Cut First

The Distal/Tibia Cut First workflow is a technique in which both the distal femur and proximal tibia resections are made prior to using a Knee Tensioner to balance the extension and flexion gaps.

With this workflow, only femoral component position adjustments are permitted because the proximal tibia has already been resected. However, resizing of both femoral and tibial components are permitted.



If changes to the tibial component plan are required, the user must go to the main ‘Implant Planning’ page under the ‘Case Planning’ navigation tab.



Point Mapping and Resection Depth functionality is available on the ‘Implant Planning’ page under the ‘Case Planning’ navigation tab.

Workflow

Surgeon

1. Perform distal femur and proximal tibia resections in the preferred order.



Following tibia preparation, a small portion of unresected bone may remain near the PCL, preventing the plateau from being removed. Carefully use an osteotome to release the resected plateau.

2. Trim all visible and overhanging osteophytes, particularly those in the posterior structures of the knee.
3. Remove all retractors from the knee joint.

Extension Gap Assessment

4. Place the leg in extension, preferably between 5-10° of flexion, although -3 to 20° of flexion is allowable.
5. Insert the Knee Tensioner into the joint ensuring that both paddles properly engage the resected surfaces of the proximal tibia and distal femur. Ensure that the paddles do not interfere with the collateral ligaments or the posterior capsule. The Knee Tensioner can expand up to 22 mm. For expansions greater than 20 mm, a 5 mm Spacer Shim is required. The Spacer Shim may be assembled to the upper paddle to achieve an expansion of up to 27 mm; however, use of the Knee Tensioner at distractions greater than 25 mm is not recommended due to the inability of the Knee Tensioner to transfer load to the joint at its upper limit. Distractions may be viewed on the 'Ligament Balancing' page. If the upper distraction limit is reached, a MAX indicator line will be visible on the Knee Tensioner as a precaution to the user.

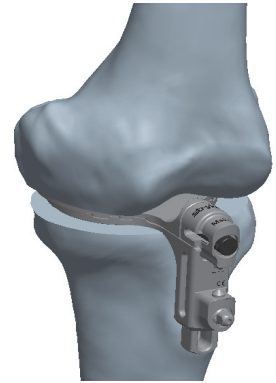

Figure 21. Knee Tensioner



To allow sufficient space to accommodate the thickness of the Knee Tensioner, the resected gap must be 6 mm or greater. When using the Spacer Shim, the resected gap must be 11 mm or greater (assembled thickness of the Knee Tensioner and Spacer Shim).



Distraction to 25 mm is representative of an insert thickness of approximately 15-16 mm.



The balancer reaches its functional limit at a distraction of 20 mm. If the distraction limit is reached, a MAX indicator line will be visible on the Knee Tensioner as a precaution to the user. For distractions greater than 20 mm, a 5 mm shim is required.

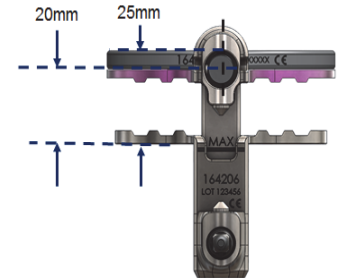

Figure 22. MAX Indicator Line

6. Remove the Leg Positioner Boot from the Sled.

- Attach the Lamina Spreader to the Knee Tensioner and distract the joint to properly tension the knee and ensure ligaments are near equally tensioned. Use caution not to apply external forces to the leg, as these may restrict the leg from reaching rotational equilibrium. The tension applied by the Lamina Spreader should be maintained within the scale of 1-5. If 5 is reached on the scale bar, stop applying force to the Lamina Spreader so as not to over-distract the joint.

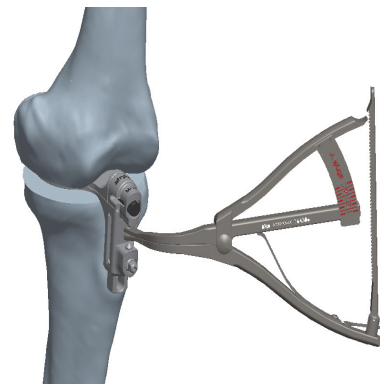

Figure 23. Lamina Spreader

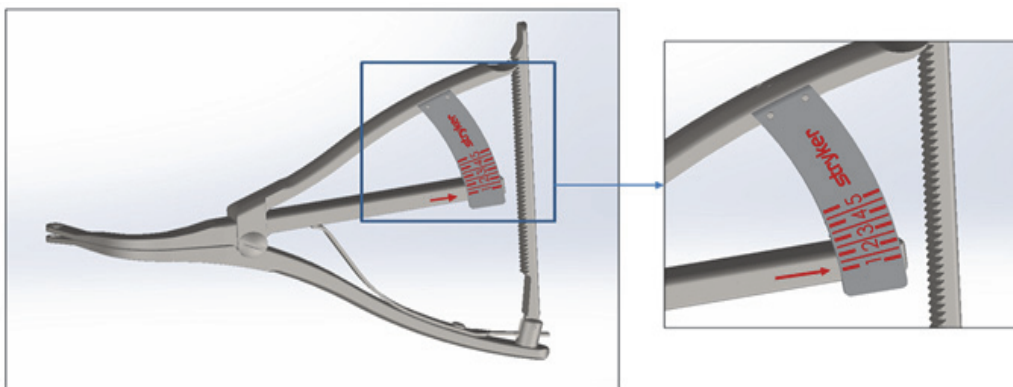

Figure 24. Lamina Spreader Scale Bar



When using the Knee Tensioner, remove all retractors and reduce the patella so as to not artificially tension the joint.

- Assess overall limb alignment and extension gaps using the “real-time” values. Release ligaments and adhesions as necessary to achieve the planned limb alignment. Alternatively, adjust the femoral component implant positions to nearly equalize the medial and lateral extension gaps. When the medial and lateral gaps are near equal, the planned limb alignment and the actual limb alignment should be near equal.



Before performing a ligament release in extension or readjusting the distal femoral cut, it may be advantageous to also assess the knee balance in flexion and consider alternate implant positional adjustments or re-cut options.



Optional: Lock the Knee Tensioner by tightening the square nut on the front of the device with the Square Driver, and remove the Lamina Spreader. This sets the gap distance without committing to the final, balanced rotational position. Moreover, it provides a window to assist in ligamentous releases.



Equalizing the medial and lateral gaps by implant planning adjustments can change overall limb alignment from the original plan.



Ensure that the translational and/or rotational adjustments to address imbalances (e.g., releasing a tight compartment) do not result in a significant shift of the knee joint line.



Ensure that no external forces are applied to the leg, as these can change the gap values and create an imbalance in ligament tension. When the ligaments are equally tensioned, ligaments should be released and/or the implant plan changed to nearly equalize the gap values.



When making implant adjustments, ensure that the new implant position removes additional bone (i.e., do not translate the femoral component distal because this will result in a space between the resected bone and the implant).



If the square nut was tightened and ligaments were released, loosen the square nut and re-tension the joint with the Lamina Spreader.

9. When satisfied with the overall limb alignment and the extension gap, capture the pose, and note the distraction force (scale reading) on the Lamina Spreader which will be used as a reference later when performing flexion balancing
10. Unlock the square nut (if locked from a previous step) on the front of the Knee Tensioner and carefully remove it from the joint.

Flexion Gap Assessment

11. Place the leg in flexion (85-95° of flexion).
12. Insert the Knee Tensioner into the joint in the unlocked position.
13. Ensure the Leg Positioner Boot is removed from the Sled.



If the Spacer Shim was used in extension, it should be removed in flexion as the posterior condyles have not yet been resected and the gap space will be less.

14. While manually supporting the underside of the femur, attach the Lamina Spreader to the Knee Tensioner and distract the joint to the same tension noted during the extension gap assessment.

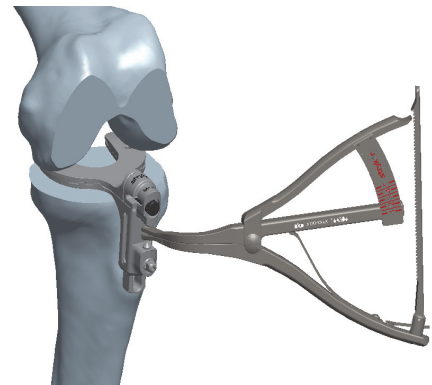

Figure 25. Lamina Spreader attached to Knee Tensioner



If the leg is not removed from the Leg Positioner or if the underside of the femur is not supported, the weight of the upper leg will add compressive force to the Knee Tensioner. When the same force level is applied as in extension, the actual force applied to the ligaments will be less.



Optional: Lock the Knee Tensioner by tightening the square nut on the front of the device with the Square Driver, and remove the Lamina Spreader. This sets the gap distance without committing to the final, balanced rotational position. Moreover, it provides a window to assist in ligamentous releases.

15. Assess the flexion gaps using the “real-time” values. Adjust the femoral component AP placement and/or axial rotation to nearly equalize the medial and lateral flexion gaps and to match the extension gaps. Alternatively, release ligaments and adhesions as necessary to achieve the desired flexion gaps.



When making implant adjustments, ensure that the new implant position removes additional bone (i.e., do not translate the femoral component distal because this will result in a space between the resected bone and the implant).



If the square nut was tightened and ligaments were released, loosen the square nut and re-tension the joint with the Lamina Spreader.

16. Confirm that the femoral plan does not notch or overhang the anterior femur. If a notching warning is displayed, flex the femoral or upsize the component. If the anterior flange is overhanging the bone, extend the femoral or downsize the component.
17. When satisfied with the flexion gap, capture the pose, unlock the square nut (if locked from a previous step) on the front of the Knee Tensioner, and carefully remove it from the joint.
18. Proceed to Bone Preparation and resect all remaining femoral cuts (anterior, posterior, anterior chamfer and posterior chamfer). If changes to the femoral component plan affected the existing resections, perform the required re-cuts of the distal femur.

Pre-Resection Balancing

The ‘Pre-Resection Balancing’ workflow is a technique in which the planned gaps are balanced prior to making any bone resections. There are several pre-resection joint tensioning methods, including:

- Paddle to apply tension to one or both compartments
- Osteotomes to apply tension to one or both compartments
- Varus or valgus movement at the ankle to apply tension to a single compartment.



Figure 26. Bone Paddles

This technique should only be used when the following conditions are met:

- Osteophytes are removed
- Adhesions are released
- Limb can be passively corrected to desired limb alignment
- No flexion contracture or recurvatum
- Ligaments are properly tensioned during pose captures
- Healthy cartilage in the unaffected compartment (lateral for varus, medial for valgus).

With this workflow, both femoral and tibial component position adjustments are permitted because neither bone has been resected. Resizing of both femoral and tibial components are also permitted.



Point Mapping and Resection Depth functionality is available on the 'Implant Planning' page under the 'Case Planning' navigation tab.

Workflow

Surgeon

1. Trim all accessible osteophytes and release ligamentous adhesions.
2. Remove all retractors from the knee joint.

Extension Gap Assessment

3. Place the leg in extension, preferably between 5-10° of flexion, although -3 to 20° of flexion is allowable.
4. Remove the Leg Positioner Boot from the Sled.
5. Properly tense the ligaments using one of the tensioning methods above.
6. Assess overall limb alignment using the “real-time” values. If the leg is not in the post-operatively desired limb alignment, release ligaments and adhesions as necessary to achieve the desired alignment.
7. When satisfied with the overall limb alignment and that the joint is properly tensed, capture the pose.
8. Adjust the femoral and/or tibial component implant positions to nearly equalize the medial and lateral extension gaps. When the medial and lateral gaps are equal, the planned limb alignment and the actual limb alignment (at time of pose capture) should be equal.

Flexion Gap Assessment

1. Place the leg in flexion (85-95° of flexion).
2. Remove the Leg Positioner Boot from the Sled.
3. While manually supporting the underside of the femur, properly tense the ligaments using one of the tensioning methods above.
4. When satisfied that the joint is properly tensed, capture the pose.
5. Adjust the femoral and/or tibial component implant positions to nearly equalize the medial and lateral flexion gaps and to match the extension gaps.
 - Balancing criteria: When applying equal extension/flexion distraction force, it is recommended that the flexion gaps be 0-1 mm greater than extension gaps.
 - Balancing criteria: When setting equal extension/flexion gaps, it is recommended that the tension applied in flexion is equal to or slightly less than tension applied in extension (flexion gap is equally or slightly more lax).
6. Confirm that the femoral plan does not notch or overhang the anterior femur. If a notching warning is displayed, flex the femoral or upsize the component. If the anterior flange is overhanging the bone, extend the femoral or downsize the component.
7. Proceed to Bone Preparation and resect all cuts in the desired order.

Planning Features

The 'Implant Planning' and 'Ligament Balancing' pages provide a robust set of tools to customize the implant plan to the patient's bony and soft tissue anatomy.

Resection View

Prior to bone resection, 'Resection View' provides an indication of how bones will appear after all cuts are complete. This is used to assess the presence of femoral notching. Notching can be seen in the sagittal view and/or by rotating the other views.



The Mako (MAKOplasty) TKA Application predicts anterior femur notching by identifying if any part of the superior edge of the anterior cut stereotactic boundary is inside the bone. If the CT scan or femur segmentation does not include this region, then the warning cannot be displayed. Edit the femur segmentation or obtain another CT scan that includes femur bone at least 20 mm above the superior femoral component flange tip.

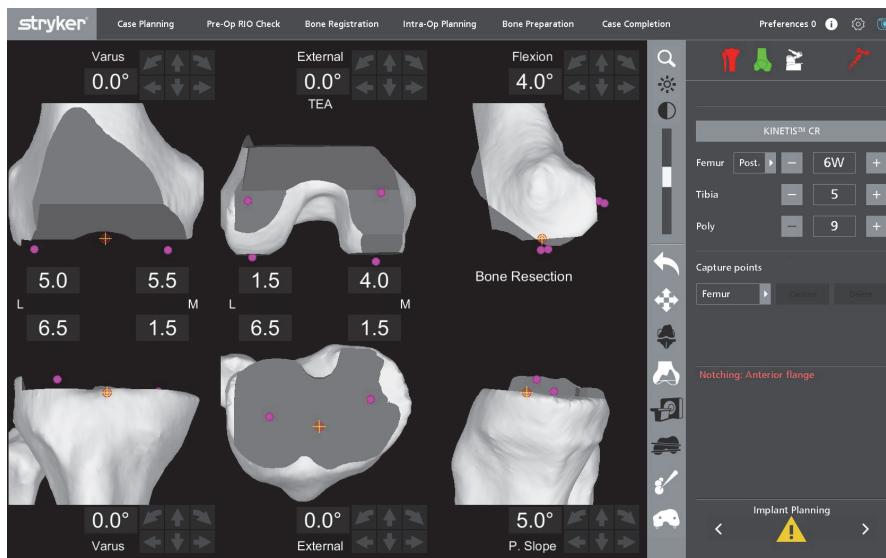

Figure 27. 'Implant Planning' Page with 'Resection View'

'Resection View' displays what the Standard Stereotactic Boundary will remove. In Figure 28, a portion of the medial edge of the bone appears to be left intact. Remaining bone at the edges provides an indication of where the Extended (Stereotactic) Boundary will be necessary in 'Bone Preparation'.



Figure 28. Virtual Resection

Implant View

Implant view allows the implant components to be turned on and off to better visualize the resections. Upon entering the page, 'Implant View' is on.



PCA View

The Posterior Condylar Axis can be toggled on which also displays the axial rotation of the femoral component from the PCA. External rotation of the femoral component from the PCA is a commonly used planning method.



Slicer View ('Implant Planning' page only)

Slicer view creates a cross-section of the bone and implant. This view is useful to see the cortical bone edge and to identify implant overhang and underhang.



Point Mapping ('Implant Planning' page only)

The surgeon may elect to intra-operatively collect points. Points may be collected along a line representing the trochlea, which is an approximation of the anteroposterior axis of the femur. This trochlear line can then be compared with the trochlear groove of the implant. Rotation and mediolateral position of the femoral component may be modified to restore the intact trochlear groove.



This trochlear line or approximate anteroposterior axis, can also be compared with the transepicondylar axis of the implant. Rotation of the femoral component may be modified to establish perpendicularity between the approximate anteroposterior axis and the transepicondylar axis of the implant.

The planned tibial baseplate rotation can be translated from the software to the anatomy. Place the Blunt Probe or Sharp Probe on the anterior tibia at the location of the mid sagittal plane of the implant (displayed by an engraved line on the implant visual). Using methylene blue or an alternate marking device, mark this point and others which are relevant with the probe on the patient's tibia. This marked point (or line) can be referenced during trialing and final tibial preparation.



Points captured intra-operatively are displayed in yellow.

Resection Depth Points ('Implant Planning' page only)

The Resection Depth Points represent the medial and lateral femur (both distal and posterior), as well as, medial and lateral tibial plateau. These points are used to compute the Bone Resection values, and the accuracy of the resection value is dependent on the location of these points (they can be updated in the 'Resection Landmarks' page). If 'Estimated Cartilage' is selected in Surgeon Preferences, 2 mm of cartilage thickness is automatically added to the resection depth value.



Warnings

Anterior Flange Notching

If the planned femoral component's anterior flange is seated deep in the supracondylar region of the femur creating a potential for femur notching, the application will play an audio warning and display a warning message in the Information Box (*'Notching: Anterior flange'*).



The Mako (MAKOplasty) TKA Application predicts anterior femur notching by identifying if any part of the superior edge of the anterior cut stereotactic boundary is inside the bone. If the CT scan or femur segmentation does not include this region, then the warning cannot be displayed. Edit the femur segmentation or obtain another CT scan that includes femur bone at least 20 mm above the superior femoral component flange tip.

Combined Flexion

If the combined sagittal rotations of the planned implant components are greater than the implant system's recommended threshold, the application will play an audio warning and display a warning message in the Information Box (*'Combined component flexion >X°'*, where X is the threshold value for the selected implant system).

Checkpoint Too Close to Cut

If the femur or tibia checkpoints are in close proximity to any of the cutting planes (≤ 5.5 mm) and at risk of being bumped or cut off by the cutting tool, the application will play an audio warning and display a warning message in the Information Box (*'Femur/Tibia checkpoint too close to cut'*). This provides an opportunity to move the checkpoint farther away from the cutting planes prior to resection.

Tibia Internal/External Rotation ('Ligament Balancing' page only)

During Ligament Balancing, the tibia must be within $\pm 5^\circ$ of axial rotation. Outside this rotation, the collateral ligaments might provide artificial tension due to twisting of the knee joint. If the tibia is beyond 5° of axial rotation, the application will play an audio warning and display a warning message in the Information Box (*'Tibia Internal/External rotation: X°'*, where X is the actual rotation value).

G. RIO SETUP - OPTIMIZE POSITION

The Robotic Arm is capable of performing bone cuts within a finite volume based on the range of motion of the joints in the Robotic Arm. Therefore, the setup position of the base of the Robotic Arm relative to the patient's knee is critical. The optimal setup for the knee is at 110° flexion and 0° rotation with the knee center height at 48" from the floor.



If the Robotic Arm was previously registered and moved away from the surgical table, return to the 'RIO Setup' page and complete the 'RIO Setup' steps again to align the Robotic Arm to the patient.



Ensure the Mako lift mechanism has been lowered and the Mako is down on its feet. An icon will appear in the Main Window if the Mako has not been lowered onto the feet.



Bone resection can be accomplished with the knee at different flexion angles; however, depending on the knee center height, rotation may need to be adjusted. There is a region around the ideal setup position that the knee center can be without having to rotate the leg between cuts. As a rule of thumb, the knee can be adjusted 75 mm higher/lower from ideal position, or it can be adjusted 75 mm towards/away from the patient's feet. Patient height, knee flexion angle, knee rotation angle, surgeon height, and surgical table height all contribute to the final height of the knee center.

Once the Robotic Arm and the bones have been registered, the 'RIO Setup' page provides real-time guidance for optimizing the position of the Robotic Arm relative to the patient. This page should be used in two different scenarios, otherwise it can be bypassed.

1. The surgeon experiences issues entering and executing the bone cuts. For example, under extreme Robotic Arm or patient setup conditions, the saw may be unable to access all areas of the stereotactic boundary.
2. The software prompts the surgeon to slightly rotate the leg towards or away from the Robotic Arm and the surgeon prefers to have no leg rotation while cutting. For example, under extreme Robotic Arm or patient setup conditions, the leg may need to be rotated to ensure that the saw blade is able to access all areas of the stereotactic boundary.

If the stereotactic boundary is inaccessible or rotation of the leg is undesired, enter the 'RIO Setup' page to display the numeric guidance for RIO Setup and adjust the knee to $90^{\circ} \pm 2^{\circ}$ flexion and $0^{\circ} \pm 2^{\circ}$ rotation. Flexion and rotation values will appear white until the ideal knee position has been achieved, at which point they will turn green.

RIO (Mako) positioning values will be displayed only when the flexion and rotation conditions are met. Each RIO Setup value will appear white until the ideal Mako position has been achieved, at which point the number will turn green. If the bone arrays or the Robotic Arm Base Array are not visible to the camera, all of the positioning data will appear greyed out.

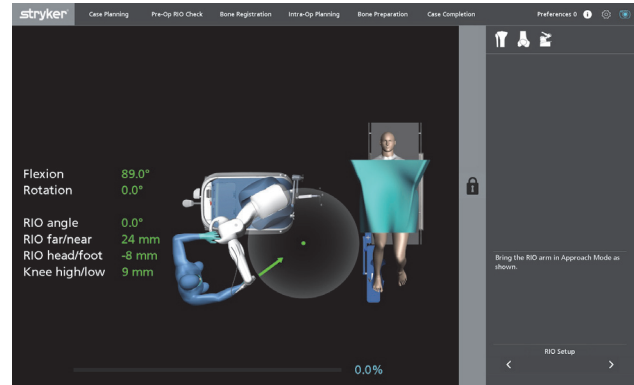

Figure 29. 'RIO Setup' Page

Surgeon/Sterile Staff Member/Mako Product Specialist

To optimize RIO Setup, use the following steps:

1. Use the hydraulic foot pedal to raise the Mako off of the floor onto its feet to enable it to move freely. This should be done by the MPS or alternate non-sterile individual.
2. The 'RIO Angle' refers to the angle of the front surface of the Mako with respect to the sagittal plane of the patient. A value of $\pm 2^{\circ}$ is considered optimal and will be displayed green. Angle the back of the Mako until a 'RIO Angle' of 0° is achieved.
3. The 'RIO Head/Foot' distance refers to the position of the Mako with respect to the patient's head or foot. A positive or negative value means that the Mako is positioned toward the patient's head or foot, respectively, by an amount equal to the displayed value. A 'RIO Head/Foot' value of ± 25 mm is considered optimal and will be displayed green. If the Mako is outside the optimal range, adjust the position of the Mako using an iterative "parallel parking" method to move the Mako along the length of the surgical table.
4. Repeat steps 2 and 3 until both 'RIO Angle' and 'RIO Head/Foot' values are green.
5. The 'RIO Far/Near' distance refers to the mediolateral position of the Mako with respect to the patient's knee. A positive or negative value means that the Mako is positioned too far from or too close to the knee joint, respectively, by the displayed value. A 'RIO Far/Near' value of ± 25 mm is considered optimal and will be displayed green. While maintaining acceptable (green) 'RIO Angle' and 'RIO Head/Foot' values, roll the Mako toward or away from the knee joint until the value of 'RIO Far/Near' is 0 mm.
6. The 'Knee High/Low' distance refers to the height of the knee joint relative to optimal operating height for the Mako. A positive or negative value means that the knee joint is too high or too low relative to the knee, respectively, by the displayed value. A 'Knee High/Low' value of ± 25 mm is considered optimal and will be displayed green. Adjust the surgical table height until the 'Knee High/Low' value is 0 mm.
7. Carefully lower the Mako back onto the ground, and make sure the Robotic Base Array arm and/or calibration knobs on the front of the Mako do not collide with the surgical table or leg positioner.



If the Mako is dropped abruptly, the Robotic Arm Base Array can be displaced and 'RIO Registration' may be compromised which will require re-registration prior to bone preparation.



In order to view RIO Setup values, the knee must be at $90^{\circ} \pm 2^{\circ}$ of flexion and $0^{\circ} \pm 2^{\circ}$ of rotation. Once this acceptable knee orientation is achieved, the numerical values on the screen will turn green and additional RIO Setup values will become visible.

H. BONE PREPARATION



Ensure the Mako lift mechanism has been lowered and the Mako is down on its feet. An icon will appear in the Main Window if the Mako has not been lowered onto the feet.



Cutting Workflow

Surgeon/Mako Product Specialist

1. Select the desired bone cut for the desired cutting workflow. The order in which the bone cuts are made can be customized for each surgeon in the 'Surgeon Preferences' page. The following cutting order is recommended for 'Measured Resection' workflow for maximum efficiency where the number of checkpoints and saw attachment changes are minimized.
 - Distal femur cut
 - Posterior chamfer femur cut
 - Posterior femur cut
 - Anterior femur cut
 - Anterior chamfer femur cut
 - Tibial cut



User must ensure that the MICS Handpiece trigger is not depressed during the transition to the 'Bone Preparation' page.



Press the Information icon in the upper right corner of the screen to identify the saw blade types (standard or narrow) required for the planned components.

2. Pass Checkpoint Verification by using the Blunt Probe to verify the checkpoint requested on the display.
3. Flex the knee to the desired angle and secure the leg by tightening the ball lock handle on the Leg Positioner Sled.
4. Using standard retractors or the optional Leg Positioner self-retractors, ensure all soft tissue is retracted away from the joint prior to the following step (*reference Section C. Incision and Arthrotomy for recommended retraction techniques*).



Use caution when using the Leg Positioner Self-Retraction System. Over tensioning of the self-retractors can cause ligament or soft tissue damage.



Stereotactic boundaries help protect the cutting tool from injuring soft tissues. However, patient anatomy, implant plan, and surgeon specific techniques are variable. The surgeon is responsible for properly retracting soft tissues during bone resection, including but not limited to: collateral ligaments, patellar tendon, quadriceps mechanism, and PCL.

5. Align the saw blade of the MICS Handpiece to the midline of the knee. Move the saw blade to within 100 mm or less of the desired cut to activate Approach Mode. Once in the Approach Zone, the yellow stereotactic boundary will be displayed in the software and a yellow icon will appear in the upper left corner of the screen, prompting the surgeon to depress the trigger of the cutting system.
6. Press and hold the trigger. While the trigger is pressed, the Robotic Arm performs surgeon enabled motorized alignment to align the saw blade to the cutting plane within the stereotactic boundary and to position the saw blade at the Engage Line (mediolateral line located approximately 20 mm from the edge of the bone). Once motorized alignment is completed, the system mode changes from Approach Mode to Cutting Mode, in which the saw is constrained to the stereotactic boundary and is ready to cut the bone. This change from Approach Mode to Cutting Mode is indicated by the following:
 - The stereotactic boundary changes from yellow to green
 - Audible chime played
 - Icon changes from yellow bordered icon to a green bordered icon.



In extreme cases of rotational deformity (e.g., extreme tibial plateau varus), the Robotic Arm may be unable to align the saw blade to the stereotactic boundary. To enable alignment, it may be necessary to remove the boot from the Leg Positioner and rotate it such that the tibia stereotactic boundary ML axis is parallel to the floor. Ensure the leg is stable prior to resection.



It is possible during use for the MICS Handpiece trigger to become stuck in the 'pressed' position. If this situation occurs while the system is in cutting mode, the cutting tool will continue to cut, but the arm will be locked within the stereotactic boundaries. Do not leave the MICS Handpiece unattended. Select 'Free'. Then, to correct a stuck trigger, release it by applying gentle pressure to the trigger from the side.



If it appears that the saw blade will impinge on bone or soft tissue during surgeon enabled motorized alignment, release the trigger to cease all motion of the Robotic Arm. Move the saw blade away from the knee joint, and return to Step 5.

7. Once in Cutting Mode, release the trigger. Releasing the trigger switches the trigger's function from motorized alignment to powering the saw.
8. Press the trigger to power the saw.
9. Complete the resection using the on-screen guidance to resect all bone that appears green. Use 'Extended Boundary' if all the bone that should be resected cannot be reached.



The Robotic Arm performs best when the knee joint is stable. Stabilize the knee joint with the opposite hand that is holding the MICS Handpiece handle.

10. Once the cut is complete, move the saw blade away from the knee joint. When the saw blade passes the Exit Line, approximately 35-45 mm from the bone, stereotactic control is disabled. The saw blade will once again be in Approach Mode.



To minimize blade skiving, carefully score the bone with the saw blade as you enter the cut. If the blade is deflected when it initially enters the bone, it will be difficult to ensure an accurate cut unless the saw blade is removed and entry point into the bone is corrected.



To ensure accuracy, do not exert strong forces on the Robotic Arm, particularly as the blade initially contacts the bone. Large forces applied to the cutting system handle may result in flexing of the blade. For best results, minimize outside forces through the Robotic Arm or MICS Handpiece and gently resect the bone.



The Robotic Arm cannot calculate the skiving of the blade (most commonly due to sclerotic bone). The screen may show that all green bone has been removed; however, due to blade skiving, this may not be true. Once the cut is complete, move the saw blade to just in front of the cut, and then run the saw blade over the cut again to remove proud bone. Confirm the resection is to plan by using the Planar, Blunt, or Sharp Probe.



It is recommended to confirm accuracy of bone resection with the Planar Probe to establish accurate alignment (target varus/valgus position) and the Blunt Probe to establish accurate bone resection depth. Inadequate bone resection is most often seen in areas with sclerotic bone resulting in saw blade deflection. This is best addressed by re-resection of the planned bone and re-confirmation with Planar and Blunt probes that accurate bone resections have been achieved.



Following tibia preparation, a small portion of unresected bone may remain near the PCL, preventing the plateau from being removed. Carefully use an osteotome to release the resected plateau.



To prevent injury to the surgeon, surgical staff, and/or the patient, move the cutting tool to a safe location when not in use. If the cutting tool is placed in a high risk region, a chime will play to prompt the user to move the cutting tool.

11. Remove the resected bone from the knee joint. If there is visible bone remaining or visible skiving, repeat steps 3-10. Power the saw and run the saw blade over the cut again. If the blade previously skived upwards, this final pass will remove any remaining bone.

Checkpoint Verification

The 'Checkpoint Verification' page provides final confirmation that the bones and Robotic Arm have maintained registration, and the system is ready to cut bone. Both bone and cutting tool checkpoints must be verified each time:

- The 'Bone Preparation' page is entered from another page
- The cutting tool changes between the Right Angle and Sagittal Saw Attachments
- The cut bone changes between the femur and tibia.

These checkpoints can be voluntarily checked at any other point during the procedure.

Bone checkpoints confirm the following:

- Bone arrays have not moved since bone registration.

The saw blade checkpoint confirms the following:

- The Robotic Arm Base Array has not moved since RIO Registration
- The correct saw attachment is assembled and oriented correctly to the cutting system
- The saw blade is securely locked to the attachment
- The correct saw blade is installed.

Checkpoint Verification Workflow

Surgeon/Sterile Staff Member

1. If not already complete, assemble saw blades to the saw attachments and attach the required attachment into the cutting system.



The Right Angle Saw Attachment can be assembled in two orientations for left and right knees. The Right Angle Saw Attachment must be biased towards the Robotic Arm to best accommodate the required approach angle. This will ensure safety and efficiency with respect to soft tissues in a medial arthrotomy.

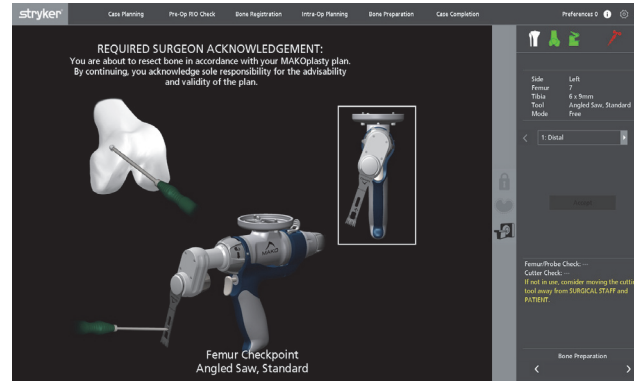

Figure 30. Right Angle Saw/Femur Checkpoint



The Sagittal Saw Attachment is always oriented such that the blade is below the tightening knob.

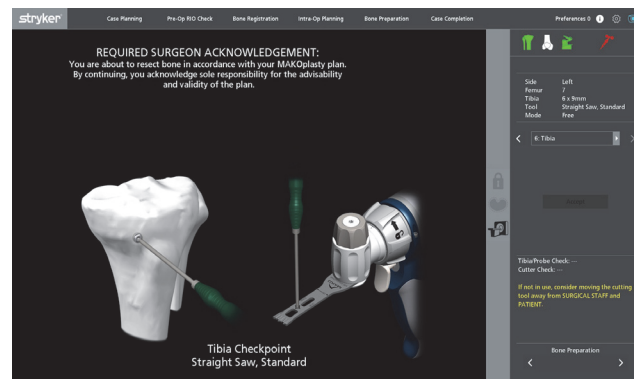

Figure 31. Sagittal Saw/Tibia Checkpoint

2. Place the Blunt Probe into the bone checkpoint that is planned to be cut. Next, place the Blunt Probe into the saw blade checkpoint.



The Blunt Probe can be placed into the blade checkpoint from either side of the blade. Sometimes it will be easier to take the Right Angle Saw Attachment blade checkpoint from the underside surface.



Ensure that the blade is not deflecting when the checkpoint is collected as this will lead to inaccuracies in the blade position, making it difficult to pass the blade checkpoint.



Move the Robotic Arm to within 100 mm of the cut for most accurate results.

- Once the bone and saw blade checkpoints pass (≤ 1.0 mm and ≤ 1.4 mm, respectively, indicated by green checks), the system will automatically proceed to the 'Bone Preparation' page. If the checkpoint value is indicated with a yellow warning triangle, the user can elect to manually accept and enter the 'Bone Preparation' page. If the checkpoint value is indicated with a red X symbol, the surgeon will be required to recollect the bone checkpoint, re-register the bone, and/or re-register the Robotic Arm.

Robotic Arm Modes

Approach Mode

In Approach Mode, a region around the knee called the Approach Zone becomes active. Within this zone, surgeon enabled motorized alignment of the saw blade can occur. This region extends approximately 100 mm from the knee. There are 2 safety planes at the back of the Approach Zone, closest to the anatomy. These safety planes serve as virtual walls which protect the saw blade from contacting the anatomy prior to entering the stereotactic boundary. The orientation of these safety planes changes with each cut to protect the anatomy accordingly; however, all safety planes are offset approximately 20 mm from the bone.

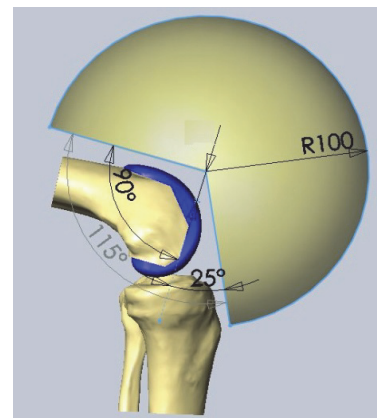

Figure 32. Approach Zone

Once in the Approach Zone, the application displays a yellow border icon which instructs the user to depress the cutting system trigger (Figure 33).

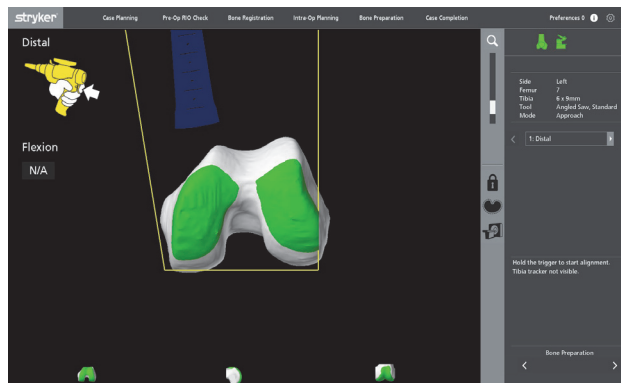

Figure 33. Approach Mode

Cutting Mode

Cutting Mode is indicated by a green stereotactic boundary and a green bordered icon. Cutting Mode can be entered through 2 methods:

- Surgeon enabled motorized alignment through the Approach Zone. To activate the saw, release and repress the trigger.
- Stereotactic Recovery (see below). To activate the saw, press the trigger.

Cutting Mode can be disabled by:

- Exiting the cut past the Exit Line. The Exit Line is 15-25 mm beyond the Engage Line. After the saw blade passes beyond the Exit Line, stereotactic control is released, and the system transitions to Approach Mode.
- Switching to another cut.
- Switching to Extended Boundary stereotactic control.
- Pressing the 'Free' button.
- Entering 'CT View'.

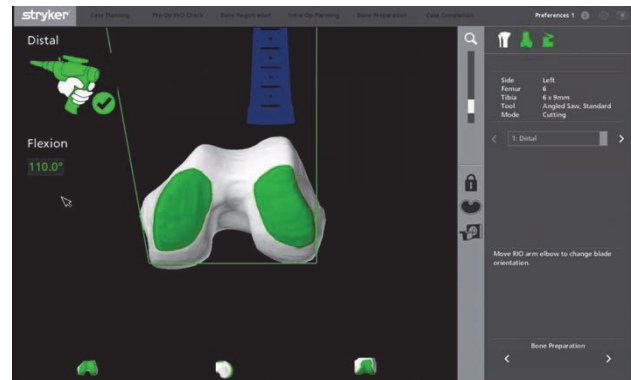

Figure 34. Cutting Mode

- Blocking a bone array (the bone being cut) or the Robotic Arm Base Array for more than 2 seconds. If an array is blocked for less than 2 seconds, Cutting Mode will be maintained.
- Exceeding the velocity limit. A velocity limit is triggered when the knee moves more than 200 mm/s.

Free Mode

There are 2 types of Free Mode:

1. Standby. The saw blade tip is not in the Approach Zone or in Cutting Mode.
2. Unlock. When the 'Free' button is depressed, no other modes are available. This is indicated by the unlock icon in the upper left corner of the screen.

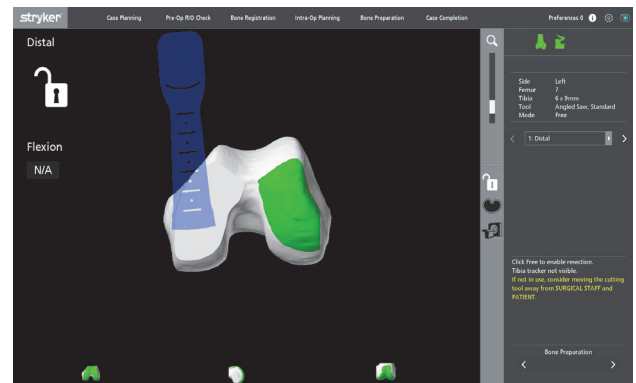

Figure 35. Free (Unlock) Mode







Transitioning from Cutting Mode to Approach Mode, and then to Free Mode (standby) can all be done without the involvement of the MPS. However, Free Mode (unlock) must be selected by the MPS. While in Approach Mode or Free Mode, the surgeon can place the Robotic Arm at any desired position and the Robotic Arm will remain stationary.



When the Robotic Arm is not in use, ensure that the saw blade is oriented in such a way that it does not pose harm or risk to the operating staff.

Bone Preparation Features

Icons

ICONS	
	PRESS TRIGGER: In Approach Mode, the stereotactic boundary will appear yellow and this icon will appear instructing surgeon to press the trigger to initiate surgeon enabled motorized alignment.
	ALIGNING: In Approach Mode during surgeon enabled motorized alignment, the stereotactic boundary will appear yellow and this icon will appear indicating the trigger is pressed and the Robotic Arm is moving.
	SAW ON: In Cutting Mode, the stereotactic boundary will appear green and this icon will appear indicating that the saw is powered.
	SAW OFF: In Cutting Mode when the saw blade exceeds 0.75 mm from plan, the stereotactic boundary will appear red and this icon will appear indicating that the saw is not powered.
	FREE: In Free Mode (Unlock), the Robotic Arm is free to move. Approach Mode and Cutting Mode are disabled.
	ROTATION: The Rotation icon is displayed when the Robotic Arm cannot enter the cut. Adjust the leg until the icon disappears.



If the saw blade is in the Approach Zone and the Rotation icon is displayed, the Robotic Arm is unable to find an arm pose to align the cutting tool to the cutting plane, rotate the leg until the Rotation icon disappears.

If the orientation is unacceptable, the surgeon may 1) modify knee flexion until the Rotation icon disappears (110° of knee flexion is optimal), 2) modify the knee rotation angle until the icon disappears, or 3) revisit the 'RIO Setup' page and reposition the Mako using the on screen guidance.



Both the Knee Tibial Array and Knee Femoral Array must be visible in order for the application to provide guidance regarding knee rotation.

Extended Boundary

Surgeon/Mako Product Specialist

The stereotactic boundary perimeter shapes are designed based on the geometry of the implant, prior knowledge of the location of soft tissue structures, and the minimum width requirements necessary to accommodate the saw blade. The stereotactic boundaries are not based on the patient specific bone contour. In general, for bone cuts near the collateral ligaments, the standard boundaries are offset from the implant by 3 mm, and the extended boundaries are offset from the implant by 6 mm (or offset 3 mm from the standard boundaries).

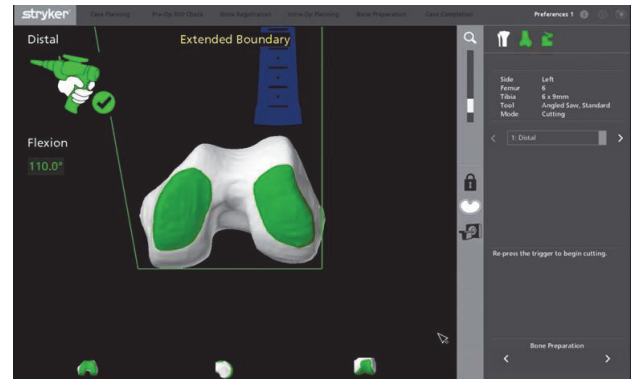

Figure 36. Extended Boundary



When switching stereotactic control to extended boundary, a decision box is displayed occluding the view of the bone. During this time, stereotactic control (and power to the saw) is still enabled. Exercise caution during this transition.



When 'Extended Boundary' is active, care should be taken to protect surrounding soft tissues to avoid inadvertent injury.

- For the posterior femur cut and the tibia cut, the posterior-lateral perimeter of the extended boundary matches that of the standard boundary (0 mm offset) to protect the popliteal artery.
- For the tibia cut, the PCL perimeter for the extended boundary is only offset 1.5 mm from the standard boundary to minimize additional bone resection so as to protect the PCL.

When remaining bone exists beyond the standard stereotactic boundary, the 'Extended Boundary' can be selected. Once the button is selected, a warning dialog box is displayed, and consent must be made to extend the boundaries (Figure 36). Once consent is made, an audible warning is sounded. While 'Extended Boundary' is active, a label is displayed in the upper center of the screen.

Stereotactic Recovery

If stereotactic control is disabled (e.g., switching to 'Extended Boundary'), stereotactic control can be recovered automatically via Stereotactic Recovery if the following conditions are met:

1. The saw blade tip is ≤ 0.5 mm from the stereotactic boundary.
2. The saw blade plane is $\leq 2^\circ$ from the stereotactic boundary plane.
3. The saw blade tip is completely contained within the perimeter of the stereotactic boundary.
4. The saw blade tip is in front of the Exit Line.

If any of these 4 conditions are not met, the saw must be positioned in the Approach Zone and realigned through the surgeon enabled motorized alignment process described above, prior to the continuance of bone resection.

Bone Resection Layers

During the bone resection process, the intact white bone will appear one of three colors: green, white or red. The color is dependent on how much bone has been removed (Figure 37).

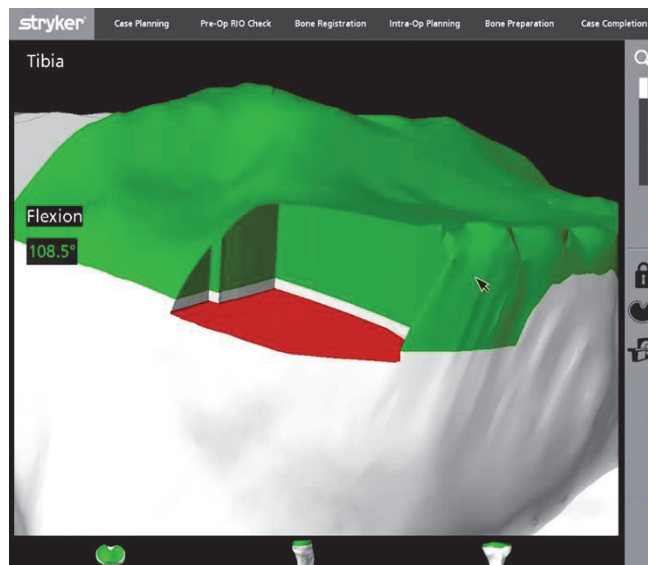

Figure 37. Native bone appears white, planned resected bone appears green, resected bone appears white and over-resected bone appears red

- Green: The volume of bone planned to be resected is colored green. This green region is located 0.25 mm above the implant plan. If green is visible, the resection is not complete.
- White: The volume of bone that appears after a successfully completed cut. The white layer is 1 mm thick: 0.25 mm above the implant plan and 0.75 mm below the implant plan.
- Red: The volume of bone that appears when the white volume has been removed indicating an over resected bone. The red layer is 0.75 mm away from the implant plan. When a red surface visual appears, the resulting resection is too deep.



Applying a transverse force to the Robotic Arm can move the cutting tool off-plan and affect accuracy. The only force that should be applied to the Robotic Arm should be in the direction of the cut in the plane of the resection as the saw is advanced. If the cutting tool moves 0.5 mm deeper than the planned resection, the system will provide an audio warning, alerting the user to apply less transverse force. If the cutting tool moves 0.75 mm deeper than the planned resection, power to the cutting system will be disabled, the upper left status icon will change to Saw OFF, and the color of the over-resected bone and stereotactic boundary will turn red

- Visually confirm all bone resections are complete. Remove unresected bone as needed.
- Remove Tibial and Femoral osteophytes. The occurrence of osteophytes on the posterior femur and tibia can be difficult to see and may limit ROM. Palpate the bone to ensure all posterior osteophytes are removed.

Velocity Limit

While in Cutting Mode, if an array moves (e.g., array is loose or patient leg moves) with excessive velocity, power is shut off to the cutting system, an audio warning plays, and stereotactic control is disabled.



The Robotic Arm performs best when the knee joint is stable. Stabilize the knee joint with the opposite hand that is holding the MICS Handpiece handle.

CT View (Resection Error Measurement)

Surgeon/Mako Product Specialist

Once a bone cut has been made, resection error can be measured.

1. Assemble the Planar Probe to the Knee End Effector Array, if not already assembled.
2. Enter 'CT View'.
3. Place the Planar Probe foot onto a bone resection and ensure that the Knee End Effector Array is visible. If the Knee End Effector Array is not visible, rotate the Knee End Effector Array about the Planar Probe shaft axis until it is visible. Resection depth error and two angular errors are displayed. Alternatively, the Blunt Probe or Sharp Probe may also be used, but only resection depth will be displayed.



The top of the Planar Probe foot can be used to measure the resection error of the posterior cut.



The Blunt Probe or Sharp Probe can also be used to measure the resection error, but only resection depth error will be displayed.



The Planar Probe measures depth at the location where the shaft axis meets the probe foot bottom. For the posterior cut, however, resection depth is measured on the probe foot top at a location approximately 29 mm from the shaft axis to better match the desired contact point on the posterior condyles. Blunt and Sharp probes measure depth at the probe's tip position (local), so the depth values can be different between the Planar Probe and the Blunt/Sharp probe.



If using the Blunt Probe to assess implant placement accuracy, it is recommended to use 2 hands, where one hand holds the probe and a finger of the other hand is used to stabilize the probe tip to prevent scratching the implant. It is not recommended to use the Sharp Probe to assess implant placement accuracy.

I. TRIAL REDUCTION AND JOINT ASSESSMENT

Surgeon

Joint laxity and ligament tension can be assessed using 2 methods:

1. Spacer Block
2. Component Trials.

Spacer Block

At any time after the proximal tibia resection coupled with the distal and/or posterior femoral resections an assessment of the resulting joint gap balance may be performed with the Spacer Block. The ideal knee gap balance generally has near equal joint tension in extension and flexion for medial and lateral compartments. The Spacer Block set of instruments help assess this intra-operatively.

1. Select the Spacer Block thickness that best matches the combined component thickness of the selected implant system.
2. Carefully place the Spacer Block with the proper orientation (Right or Left knee) into the joint space created between the resected bony ends at full extension.
 - a. If the joint space is too tight, select a Spacer Block thickness that is 2 mm thinner, which may indicate that post-resection implant adjustments are necessary (*refer to Section I. TRIAL REDUCTION AND JOINT ASSESSMENT*).



Figure 38. Spacer Block

- b. If the joint space is too loose, select a Spacer Block thickness that is 2mm thicker, which may indicate that a thicker insert is necessary. This can be accomplished by using the opposite end of the same Spacer Block or switching up to the next size.
3. Assess whether the gap balance between medial and lateral compartments are symmetrical. Non-symmetric gaps may indicate that soft tissue releases or post-resection implant adjustments are necessary (*refer to Section J. POST-RESECTION IMPLANT ADJUSTMENTS*).
 4. Repeat steps 2 and 3 for the flexion gap. If the flexion gap differs from the extension gap more than desired, soft tissue releases or post-resection implant adjustments may be necessary (*refer to Section J. POST-RESECTION IMPLANT ADJUSTMENTS*).



During use of the Spacer Block, ensure there is no over-tensioning of ligaments which could damage the soft tissues.

Component Trials

For component trialing, reference the applicable Surgical Technique for the selected implant system.

- Mako TKA with Triathlon Surgical Protocol (PN TRIATH-SP-21)
- Mako TKA with KINETIS Surgical Technique (PN 210468).

J. POST-RESECTION IMPLANT ADJUSTMENTS

Surgeon

If the post resection balance is not as desired, the implant plan (position, orientation, and/or size) can be modified after initial bone resections have been made via the 'Implant Planning' or 'Ligament Balancing' pages. Examples include:

- In the event of tight flexion and extension gaps, the surgeon may opt to increase the resection depth of the tibial component and recut the tibia.
- In the event of a tight flexion gap and a balanced extension gap, the surgeon may opt to increase the posterior slope of the tibial component and recut tibia.
- In the event of a flexion contracture (tight extension gap) and a balanced flexion gap, the surgeon may opt to increase the resection depth of the distal femoral component and recut the femur.

However, the following issues should be considered before modifying a component plan after initial resection:

- The software will not save the previous plan once a change to the plan is made. The initial plan will be overwritten. The 'Undo' button may be used, but only the latest (new) plan will be applied when returning to the 'Bone Preparation' page.
- Any change which causes the implant to become more proud of the initial resection will not be represented in the software (i.e., resected bone cannot be restored).



Care must be taken when choosing to adjust an implant plan after resection has taken place. The application does not display resected bone on the 'Implant Planning' or 'Ligament Balancing' pages. A plan can be created which overlaps a previous resection. To prevent implant malalignment, the surgeon should check the resected surface with the Blunt Probe and compare it to the implant plan. The surgeon should also enter each cut in Bone Preparation to determine if additional bone needs to be resected.

K. FINAL COMPONENT PREPARATION

Surgeon

For final component preparation, reference the applicable Surgical Technique for the selected implant system.

- Mako TKA with Triathlon Surgical Protocol (PN TRIATH-SP-21)
- Mako TKA with KINETIS Surgical Technique (PN 210468).

L. PATELLAR PREPARATION

For patella preparation, reference the applicable Surgical Technique for the selected implant system.

- Mako TKA with Triathlon Surgical Protocol (PN TRIATH-SP-21)
- Mako TKA with KINETIS Surgical Technique (PN 210468).

M. FINAL COMPONENT IMPLANTATION

Surgeon

For final component implantation, reference the applicable Surgical Technique for the selected implant system.

- Mako TKA with Triathlon Surgical Protocol (PN TRIATH-SP-21)
- Mako TKA with KINETIS Surgical Technique (PN 210468).

N. CASE COMPLETION

Archive and Exit

Surgeon/Mako Product Specialist

Once the user has reached the last page of the workflow, the application will display a 'Patient Time Out' to remind the healthcare professional to remove the mechanical checkpoints. Remove the femoral and tibial checkpoints using the Checkpoint Driver tool. Acknowledge the reminder to remove checkpoints before selecting the 'Archive and Exit' button.



It is recommended to include the following in the surgical instrument count: 2 femur bone pins, 2 tibia bone pins, 1 femur checkpoint, and 1 tibia checkpoint

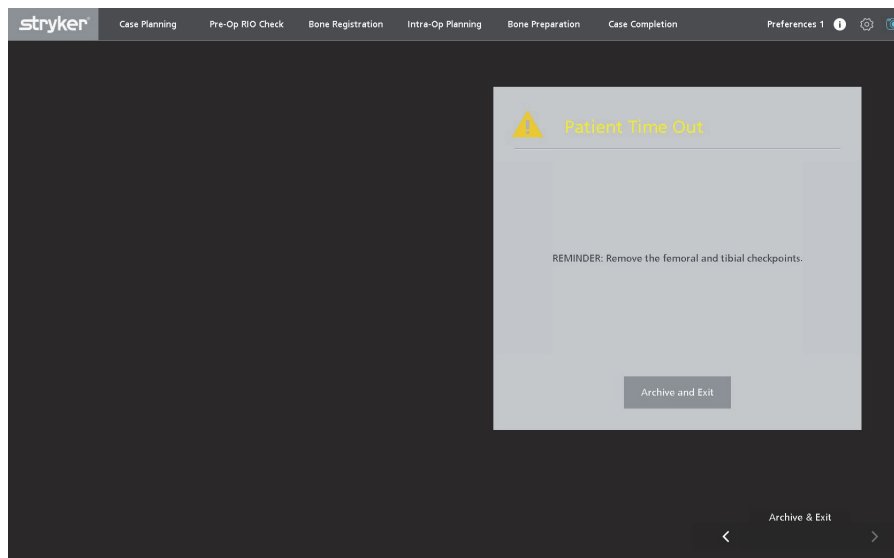

Figure 39. Remove the Femoral and Tibial Mechanical Checkpoints before shutting down the system.

A surgeon must always rely on his or her own professional clinical judgment when deciding whether to use a particular product when treating a particular patient. Stryker does not dispense medical advice and recommends that surgeons be trained in the use of any particular product before using it in surgery.

The information presented is intended to demonstrate the breadth of Stryker product offerings. A surgeon must always refer to the package insert, product label and/or instructions for use before using any Stryker product. The products depicted are CE marked according to the Medical Device Directive 93/42/EEC. Products may not be available in all markets because product availability is subject to the regulatory and/or medical practices in individual markets. Please contact your Stryker representative if you have questions about the availability of Stryker products in your area.

Stryker Corporation or its divisions or other corporate affiliated entities own, use or have applied for the following trademarks or service marks: KINETIS, MAKOplasty, Mako, MAKO Surgical Corp., RIO, Stryker, Triathlon, VIZADISC. All other trademarks are trademarks of their respective owners or holders.

PN 210469 Rev 00 01/16
Copyright © 2016 Stryker
Printed in USA

Stryker Australia Pty Ltd
8 Herbert Street St Leonards
NSW 2065 Australia
Ph: +61 2 9467 1000
www.stryker.com.au

Stryker New Zealand Limited
515 Mt. Wellington Highway
Auckland 1060 New Zealand
Ph: +64 9 573 1890
www.stryker.com