

USER MANUAL
使用說明書

HITACHI
Inspire the Next

HITACHI FULLY AUTOMATIC WASHING MACHINE
日立全自動洗衣機

Model AJ-S55KXP/AJ-S55KX



Thank you for your purchase of HITACHI Fully Automatic Washing Machine.

- Please read this manual carefully for proper operation.
- Please keep this manual for future reference.

承蒙您選購日立的全自動洗衣機，謹此致衷心謝意。

- 請細閱本說明書，以便正確使用本洗衣機。
- 閱讀完畢，請妥善保存本說明書，以備將來查閱。

CONTENTS

目錄

Preface 前言	3
Safety Precautions 安全方面的注意事項	4
Installation Guide 安裝指南	7
Installation 安裝	13
Safety Check 安全檢查	14
Washing Machine Repair 洗衣機修理事宜	14
Technical Description 各部件名稱	15
Control Panel (AJ-S55KXP) 控制面板 (AJ-S55KXP)	16
Before Using Your Machine 開始洗衣前	19
Checking Amount of Laundry and Detergent (Approximately Amount) 檢測洗衣量和洗衣粉量(大致用量)	20
How to Use Liquid Detergent, Bleach and Fabric Softener 洗衣粉、漂白劑、柔軟劑的使用方法	21
Amount of Laundry and Detergent 洗衣量和洗衣粉量	23
Selection of Laundry Process 洗衣程序的選擇方法	24
Content of the Washing Process 洗衣程序的內容	26
Process Description 各程序的說明	27
Using the PRESET for Washing 預校時間洗衣	31
Using the Detergent Again 再次使用洗衣液	32
Using the Washing Cap 使用洗衣蓋	33
AIR JET Process 風乾程序	35
Wash in Your Favorite Way 按照您喜歡的方式進行洗衣	38
Maintenance of Washing Basket (TUB DRY • TUB CLEAN) 洗衣槽的保養 (筒風乾 • 筒清洗)	40
Use Guidelines 使用中的注意事項	41
Maintenance and Repair 維護保養方法	42
When Failure Happens 有故障發生時	46
Optional Parts 另售部件	52
Product Specifications 產品規格	52



Preface 前言

☞ The number next to the sign is the page number for detailed description.
後面的數字表示具體說明的頁數。

Air jet 空氣噴射乾燥

It's an economic mode of drying without heating.

無需進行加熱的節能乾燥方式。

- May be used to dry the heat-irresistible swimsuit or the underwear containing the amino heat-insulation materials.
可乾燥不耐熱的泳衣或含氨基隔熱材料的內衣。
- Keep room free of mugginess for causing no temperature rise.
由於溫度不上升，房間不會悶熱。
- Control the black mildew.
抑制洗衣槽的黑色霉菌。

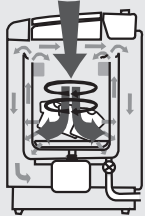

※ The drying capacity can be as high as 1.5kg.
乾燥容量可達1.5kg。

※ The duration is irrelevant to the dryness level for applying the preset mode of drying.
採用定時乾燥方式，結束時間與乾燥程度無關。

Please read "USER MANUAL" carefully for proper operation. (☞ 35)
請仔細閱讀“使用說明書”，以便您能正確使用。(☞ 35)

Infiltration washing 滲透清洗

Infiltrate the detergent inside the cloth to detach the dirt off the cloth fiber.

使洗衣粉滲入到衣料內部，使污垢從布料纖維上脫落。

The detergent dissolves sufficiently to become the high-concentration detergent that washes the laundry in infiltration mode for easier detachment of dirt off the cloth fiber.

洗衣粉充分溶解，形成高濃度洗衣液，對衣物進行滲透清洗，使污垢更易從布料纖維上分離。

- 1 Put detergent in, adding some water**
加入洗衣粉，供給少量水
The detergent put in at the injection opening will fall below the pulsator.
從注入口加入的洗衣粉將落在攪拌翼下方，並注入少量水。
- 2 Make the detergent dissolves fast by rotating the spinning basket.**
通過脫水桶旋轉加速洗滌劑溶解
- 3 The detergent dissolves inside the cloth**
溶解洗衣粉使其滲入衣物
The concentrated detergent dissolves with the power agitating of pulsator, and infiltrates sufficiently inside the cloth.
濃縮洗衣粉在攪拌翼強力攪拌下溶解，充分滲透到衣物內部。
- 4 THREE-STEP washing**
三步洗衣
Inject a little water, and the dirt will detach with the high-concentration detergent; inject more water to the normal water level for washing.
加入少量水，污垢在高濃度洗衣液下脫落，再加水到通常水位處進行洗衣。

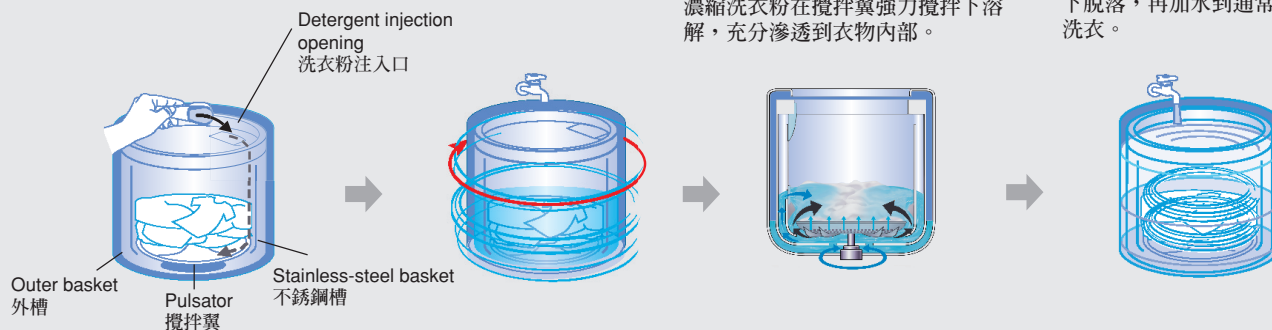

※ Please use concentrated powder detergent to wash.
請使用濃縮合成粉末洗衣粉進行洗衣。

The infiltration washing can't be performed to the processes of "WOOL", "BLANKET" and "TUB CLEAN". (Because of no detergent dissolution course in these processes)

『毛絨』、『被毯』、『筒清洗』程序不能進行滲透清洗。(因為沒有溶解洗衣粉的過程)

Laundry rearrangement and spinning 理衣脫水

Loosen the post-spinning laundry for easy taking out. 疏鬆脫水後的衣物，使之易於取出。



※ The laundry rearrangement may be out of service in the case that the washing capacity is less than 1kg or more than 4kg.
洗衣量不足 1kg 或超過 4kg 時，有可能無法進行理衣程序。

※ The laundry rearrangement doesn't perform in the case of manual setup of "RINSE", "SPIN" or "SPIN ONLY".
手動設定“沖洗”、“脫水”或“只脫水”等時，不進行理衣程序。





Safety Precautions



安全方面的注意事項

Please read this part of substance carefully for proper operation before using your machine.

使用之前，請仔細閱讀這部分的內容，以便正確使用。

★ The precautions stated here are classified as "Warning" and "Attention" according to the damage and the emergency caused by misoperation, and are described respectively in line with the marks below
這裏所說的注意事項根據誤操作而引起的傷害大小以及緊迫程度，分為“警告”和“注意”兩種，並且按照以下標識進行區分說明

 Warning 警告	With no respect to this mark, the misoperation may cause death or GBH. 表示如果無視此標記，誤操作後，可能引起死亡或重傷事故。
 Attention 注意	With no respect to this mark, the misoperation may cause body harm or object damage. 表示如果無視此標記，誤操作後，可能引起人身傷害或物體損壞事故。

Graphic mark 圖形例子	 This mark indicates the content of warning or attention. 表示敦促警告及需要注意的內容。
	 This mark indicates the prohibited action. 表示禁止行為。
	 This mark indicates the compulsory action to be carried out. 表示必須執行的強制行為。

 Warning 警告	
 <p>Dismantle, repair or alterations should only carried out by professional technicians. 除指定的專業維修人員外，應絕對禁止他人拆卸、修理或改裝洗衣機。</p> <p>• Avoid electric shock, fire, and body injury due to improper activity. 避免因不恰當行為而導致觸電、火災及人身傷害。</p>	 <p>Please use the single socket with 220V, 10A specification. 請單獨使用額定值為交流 220V、10A 以上容量的電源插座。</p> <p>• The share of the same socket with other electric appliances may cause fire due to excessive heat. 若與其他電器設備共用同一插座，可能因異常發熱而導致火災事故。</p> 
 <p>This washing machine is equipped with the electricity wire with bi-electrode grounding plug, please use the bi-electrode grounding socket. The creepage protector shall be used if possible. 本品採用二極接地插頭電源線，請使用二極接地電源插座。可能的話，最好使用漏電保護器。</p> <p>• To prevent electricity leak which may cause injuries. 避免因漏電故障引起傷害。</p>	 <p>Washing machine should not be installed in humid place or in places exposed to wind and rain. 請勿將洗衣機安裝在潮濕或容易受到風吹雨淋的地方。</p> <p>• Otherwise, electricity leak causing electric shock or fire may occur. 避免觸電或因漏電而引發火災事故。</p> 
 <p>Electricity supply must be unplugged with dry hands. 嚴禁使用濕手插拔電源插頭。</p> <p>• Otherwise, this may cause electric shock. 否則可能導致觸電事故。</p> 	 <p>Do not put water in direct contact with the unit during maintenance and repair. 進行保養時，請勿直接將水淋灑在洗衣機各個部位。</p> <p>• This may cause short circuit or electric shock. 否則可能造成短路而導致觸電事故。</p> 

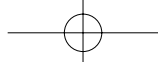

⚠ Warning 警告



Prohibited
禁止

Do not put your hand into the basket until it has stopped completely.
在脫水槽完全停止轉動前，嚴禁將手伸進槽內拿取衣物。

- Even when the spinning of the basket is slow, there is still a danger of being caught in the motion, resulting injuries. Particular attention should be paid when children are around.
即使旋轉緩慢，手部仍有被衣物纏繞的危險。兒童尤需注意。

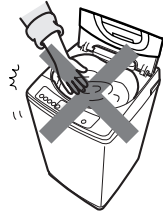

Prohibited
禁止

Do not put your hands into the washing • spinning basket during the washing and rinsing process.
洗衣和沖洗過程中，嚴禁將手伸入洗衣•脫水槽內。

- Even when the spinning is slow, hands may be trapped by clothes. If necessarily, please press pause button, and put your hands into the basket after it has stopped completely.
即使旋轉緩慢，手部仍有被衣物纏繞的危險。(若必須將手伸入槽內時，請按下暫停按鈕，待洗衣•脫水槽完全停止旋轉後再伸入槽內)。



Prohibited
禁止

Damaged or loosen wire or plug should not be used.
嚴禁使用已損壞的電源線、插頭或鬆動的插座。

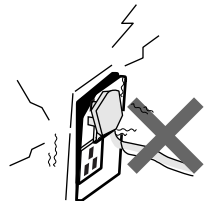

- Otherwise electric shock, short circuit or fire may take place.
否則可能導致觸電、短路或起火。



Prohibited
禁止

Do not damage wire.
嚴禁損壞電源線。

Do not damage or alter the wire forcibly bend, pull, twist or handle the wire. Beside, please do not put weight on or trap the wire.
請勿隨意進行改裝、強行彎曲、拉伸、扭曲及捆扎電源線。此外，亦請勿將重物壓在其上或夾於其中。

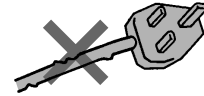

- Damage of wire may cause electric shock or fire.
若電源線遭受損傷，可能導致觸電或火災。



Prohibited
禁止

Keep child away from the washing • spinning basket and do not place box or shelves next to the washing machine.
嚴禁讓兒童探看洗衣•脫水槽。也請勿在洗衣機旁放置台架等物品。

- Children may fall into the basket resulting in injuries.
兒童可能因掉入洗衣•脫水槽中造成人身傷害。



Clear
清掃

Thoroughly wipe the power plug when dirt is adhering the prong or around the base of the prong.
電源插頭的插片以及插片的夾緊面上，若有塵垢附著時，請擦拭乾淨後再使用。

- Failure to do so may cause a fire.
可能會引起火災。

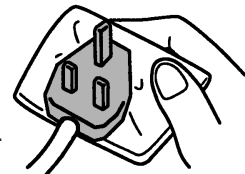

No smoke or fire
禁止煙火

This washing machine is strictly prohibited to get close to the locations with candle, mosquito-repellent incense, dog-end or other kinds of open flame.

本洗衣機嚴禁靠近蠟燭、蚊香或煙頭等有明火的場所。

- To avoid injuries caused by the lock damage.
避免因機構損壞而招致意想不到的傷害。

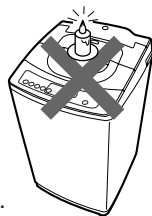

Prohibited
禁止

Do not put gasoline, benzene, alcohol, thinner or fabrics with these stains into or near to the washing machine.

請勿將汽油、香蕉水、酒精、燒鹼或沾有上述液體的衣物放入槽內或靠近洗衣機。

- To prevent fire or explosion which may cause injuries.
否則可能引發爆炸或火災事故。

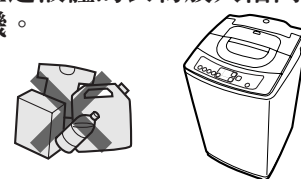



Safety Precautions (continued)

安全方面的注意事項 (續)

Warning 警告



Prohibited
禁止

Do not insert a screwdriver into the Lid Lock hold.
嚴禁用螺絲刀插入洗衣機機蓋緊鎖裝置部位的孔內。

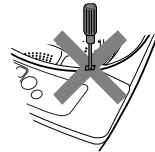

- To avoid injuries caused by the lock damage. 避免因裝置損壞而招致意想不到的傷害。



Prohibited
禁止

Do not open the lid in locked status by force.
嚴禁強行打開處於鎖定狀態的機蓋。

- Otherwise, the lid or locking device may be damaged, resulting in unstoppable spinning of washing basket and thus causing injuries. 否則將會損壞機蓋或鎖緊裝置，導致洗衣、脫水槽無法停止旋轉，造成人身傷害。



Attention 注意



Prohibited
禁止

Do not pull the wire from the socket when unplugging the unit.
拔掉電源插頭時，切勿拉扯電源線，必須拿住插頭本體向外拉。

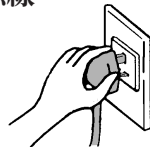

- To avoid electric shock or fire cause by short circuit may result. 避免觸電或因短路導致火災事故。



Prohibited
禁止

Do not stand on or put weight on the top of the unit.
請勿站立在洗衣機上，或者在其上放置重物。

- Otherwise, deformation and damage may result causing injuries. 可能因變形或損壞而造成人身傷害。



Prohibited
禁止

Do not connect to the hot water supply. And, water of above 50°C should not be used for washing.
請勿連接至熱水管，並且用溫水進行洗滌時，水溫嚴禁超過 50 °C。

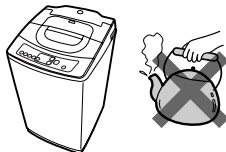

- Electric shock or leakage may occur due to deformation of plastic parts of the unit. 可能因塑料部件的變形受損而導致觸電或漏電事故。



Prohibited
禁止

Keep hands and feet away from the bottom of the washing when it is motion.
運轉過程中，請勿將手或腳伸至洗衣機的下部。

- Ports in motion beneath the unit may cause injuries. 旋轉部件可能會引起人身傷害。



water leakage
漏水

Please unplug the unit when not using the unit for a long period of time.
不使用洗衣機時，必須將電源插頭拔出。

- Electric shock or leakage due to aging of insulator may cause fire. 可能因絕緣老化而引發觸電、漏電或火災事故。



water leakage
漏水

Water supply hose should be tightly screwed to the unit.
供水管連接機體的螺母必須擰緊。

Union nut
連接螺母

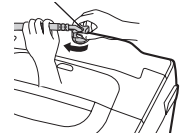

- Failure to do so may result in water leakage. 可能導致漏水。
- Used for a long period of time, the unit may result in water leakage caused by loosen union nut. So please check it in time and screw tightly again. 長期使用後，可能會因連接螺母鬆動造成漏水而遭受不必要的損失。因而請務必定期檢查並重新擰緊已鬆動的螺母。



water leakage
漏水

Check water supply hose connection by turning on the water before washing.
開始洗衣前，請先打開水龍頭，檢查供水管的連接狀況。

- To prevent damages caused by possible water leakage due to loosen screw. 如果螺釘鬆脫，會因漏水而招致不必要的損失。



water leakage
漏水

When installing the washing machine, be sure to hang the water drainage hose.
安裝洗衣機時，請務必將排水管挂起。

- If water drainage hose is not hung up, the remained water inside will flow out and result in unnecessary loss. 如果排水管沒有挂起，殘留在內部的水會流出，從而造成不必要的損失。



water leakage
漏水

Electricity supply must be unplugged with dry hands during maintenance and repair.
維修保養時，請務必將電源插頭從插座拔出。

- Otherwise, electric leakage causing injuries may occur. 避免因漏電而招致傷害。

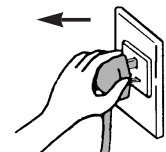

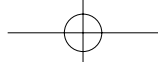

⚠ Attention 注意



Please turn off the water tap when not using the unit.

不使用洗衣機時，必須關閉水龍頭。

water leakage
漏水



- To prevent damages caused by water leakage.
以防產生漏水。



Do not wash, rinse and spin the water proof fabric or cloth.

請勿洗滌防水性的苫布或衣物。

Prohibited
禁止

(sleeping bag, raincoat, cover of skiing, utilities, bicycles, cars and motors
睡袋、雨衣、滑雪用具以及自行車、轎車、摩托車的車罩等。

- Otherwise may lead to injury by abnormal vibration during spinning or damage the washing machine, wall, floor and clothes.
可能在脫水時產生異常振動而引起人身傷害，或者導致洗衣機、牆壁、地板以及衣物的損壞。



Prohibited
禁止

Do not incline installing the washing cap. Do not use the washing cap except WOOL process, BLANKET process.

嚴禁傾斜安裝洗衣蓋，並絕對禁止在『毛絨』、『被毯』程序以外使用洗衣蓋。

- Splash of water may occur or washing cap may be swung out of the basket.
可能會因水滴飛濺或洗衣蓋彈飛出造成洗衣機受損或人身傷害事故。



Installation Guide 安裝指南

Installation of Washing Machine 洗衣機的安裝

Where to install 安裝地方

- Please install on a solid horizontal surface.

請安放在堅硬、平坦的地面上。

- Installation on a slippy or irregular surface may result in noise and shaking.
安放在易於滑動、柔軟的地面上，會容易產生振動和噪音。



Solid, horizontal surface
堅硬、平坦的地面



Weak surface
柔軟的地面



Irregular surface
凹凸的地面

- Avoid installing the unit too close to the wall.

請勿靠近牆壁安放。

- This is to prevent abnormal vibration and noise.
以防止異常振動和噪音。

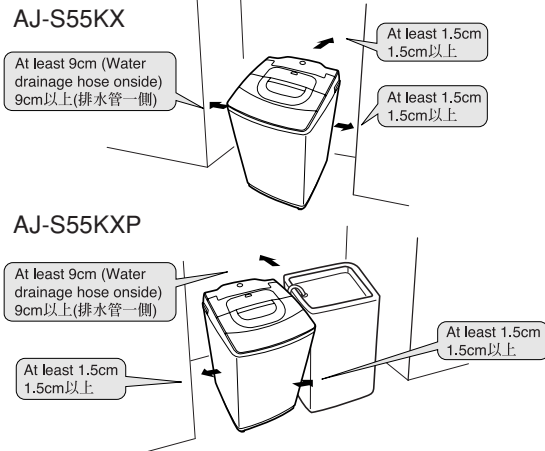

How to install 安裝方法

- The unit should be installed on a flat horizontal surface.

請水平安裝洗衣機。

Otherwise sudden stop or abnormal sound may result during the spinning cycle.

若安裝得不水平，會導致脫水時停機或產生異常聲音。



Installation Guide (continued) 安裝指南 (續)

Installation of Washing Machine 洗衣機的安裝

1 Adjust the instability of the washing machine with adjustable leg.
用可調機腳來調整洗衣機的不平穩。

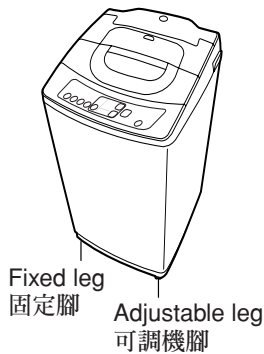

2 Please make sure of the horizontality of the washing machine.
請確認機體的水平度。

- As shown in the figure, the horizontality can be easily observed by the string used to hang an object.
如圖所示，用懸掛重物的細繩來觀察，即可輕易確認其水平度。

It is level if the clearance between A and machine body is the same with that between (A) and the machine body.
A 和 (A) 兩點與機體之間間隙相同，即表示水平。

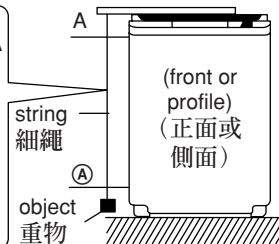

Inspection of trial run 試運轉的檢查

Put some water into the washing barrel and reconfirm its horizontality.

在洗衣槽內放些水，請再一次確認其水平度。

- The ground is level if all front, rear, left and right height difference between the spinning hole and water surface are less than 3mm.
脫水孔相對於水面的高度差(B與C的差)，如果前後左右均在3mm以內，就表示地面是水平的。

- To install the machine on an inclined floor, leg caps in the attached accessory kit can be used to adjust height by connecting them to the fixed leg.
安裝在傾斜的地面上時，請將附有的腳套套在固定腳上進行調整。

- ※ Confirming the machine type of AJ-S55KXP, please install the water drainage hose and hang it on, otherwise there will be no water in washing basket.

AJ-S55KXP 机型確認時，請先安裝排水管並將其掛起，否則洗衣槽內無法盛水。
排水管的安裝及固定方法。☞ 9

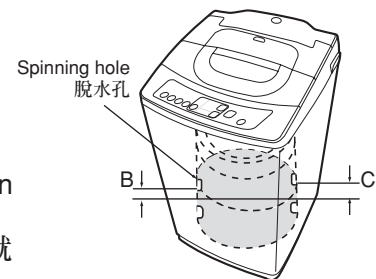

How to Use the Adjustable Leg 可調機腳的使用

1 Loosen the lock nut by unscrewing in arrow direction ① before using the adjustable leg to stabilize unit.
將鎖緊螺母沿箭咀方向①旋鬆，再旋轉可調機腳調整機身的平穩。

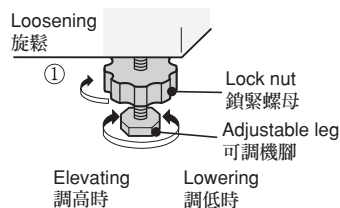

2 After adjusting of the unit, tighten the lock nut by screwing it in arrow direction.
調整完畢後，將鎖緊螺母沿箭咀方向②旋緊。

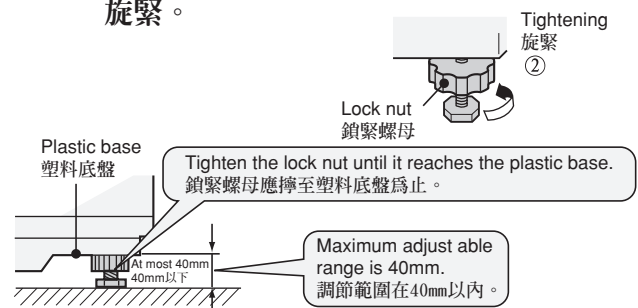

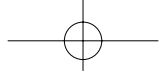

How to Install the Water Drainage Hose 排水管的安裝方法 (AJ-S55KXP)

1 Connect the water drainage hose with the water drainage joint on the back of the body.

將排水管連接到機體背後的排水接頭上。

- Fully insert it into place to avoid leakage.
應切實地插入到位，以免漏水。

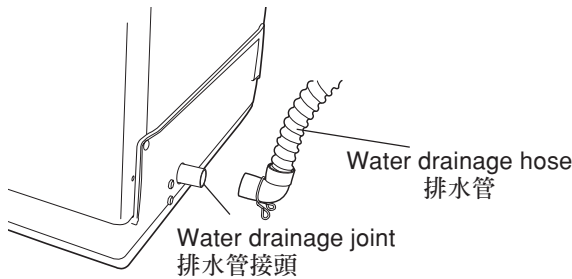

2 After the connection is completed, please use hose clipper to clamp the water drainage hose to avoid fall-off.

連接完成後，請用軟管夾子將排水管夾住以防止掉落。

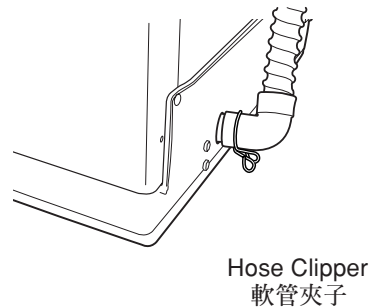

3 ① Insert the fixing holder of water drainage hose into mounting hole. 將排水管的固定架插入安裝孔。

- ② As shown in illustration, rotate the fixed leg for 90 degree into hole.
如圖所示，將固定腳旋轉 90 度旋入孔中。

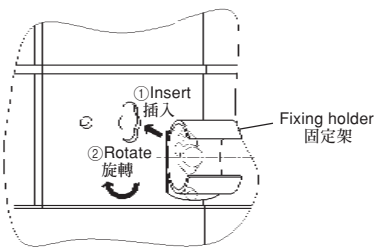

4 Pull the water drainage hose straight, concave to fix into the fixing holder of water drainage hose.

將排水管拉直，使其嵌入排水管的固定架。

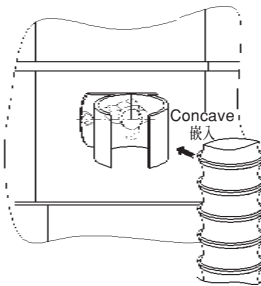

Water drainage hose from the right or (left) side of the unit.
排水管從右側（或左側）引出。

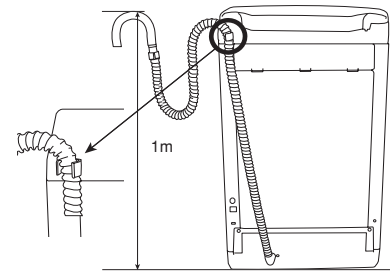

Attention 注意

- To avoid direct draining due to the fallen water drainage hose, the water drainage hose must be used only after installing into fixing holder, and its hanging height should not exceed 1m.
為了避免排水管掉落造成直接排水，請務必將排水管嵌入固定架後再進行使用，且排水管的掛靠高度不應超過 1 米。
- Do not release the water drainage hose lest the water is splashed.
請勿將排水管放倒，以免水洒落。
- Do not use extended water drainage hose.
請勿使用延長排水管。
- Do not immerse the U-shaped hose on the tail of the water drainage hose in the water.
請勿將排水管尾部的 U 型管浸沒在水中。
- When using it in winter, to prevent icing, please release the water drainage hose after using and place the its tail in water container such as basin, set the washer to single dehydration mode and drain the remained water. 44
在冬季使用時，為防止結冰，使用結束後，請將排水管放倒，並將其尾部放入水盆等盛水容器，設定洗衣機為單脫水，將殘留的水排乾。 44
- Be sure not to install the water drainage hose at a position lower than water drainage joint, otherwise, it could lead to difficulties in water drainage.
排水管安裝時，請勿低於排水接頭，如低於排水接頭可能會導致排水不暢。

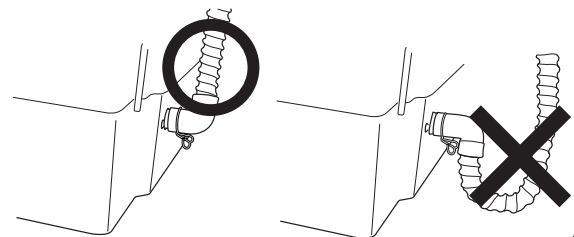

※ This discharge pipe installs the method to be only suitable in AJ-S55KXP.
此排水管安裝方法只適用於 AJ-S55KXP。



Installation Guide (continued)

安裝指南 (續)

How to Change the Water Drainage Hose 排水管的轉換方法 (AJ-S55KX)

Water drainage hose is attached on the left side of unit at shipment, nonetheless, it can be reattached on the right side to suit drainage needs.

產品出廠時，排水管安裝在機身左側，請視排水位置的具體情況將其換至右側。

1 Lay the unit down slowly. 請將機體慢慢地放倒。

- Lay the unit down on some corrugate paper to prevent damage.
放倒機體時，請在地面上放置一些瓦楞紙類的襯墊，以免損傷機身。

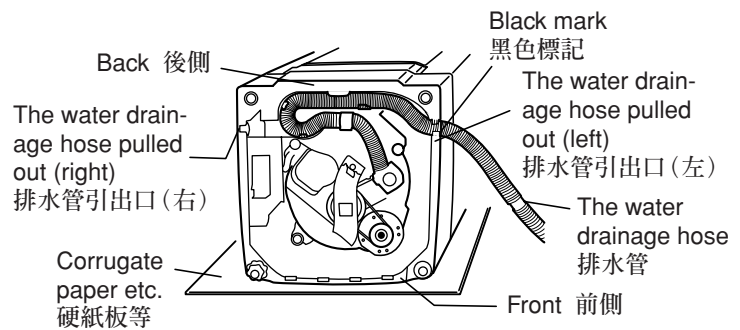

2 Pull out the water drainage hose from the right side of the unit. 把排水管從右面引出。

- Remove the right water drainage hose cover (The cover can be disposed).
將機體右面的排水管蓋拆下 (排水管蓋可丟棄)。
- After pulling out the "Black" mark of the water drainage hose from the left groove of the unit, the "Purple" mark of the water drainage should be inserted into the corresponding groove of the right unit.
把排水管“黑色”標記部從機體左側的凹槽內引出，“紫色”標記部應嵌入機體右側對應的凹槽內。
- The water drainage hose should be pulled out through the proper hose retainer when the hose is pulled out on the right.
排水管從右面引出時，排水管應通過相應的軟管固定夾後再引出。

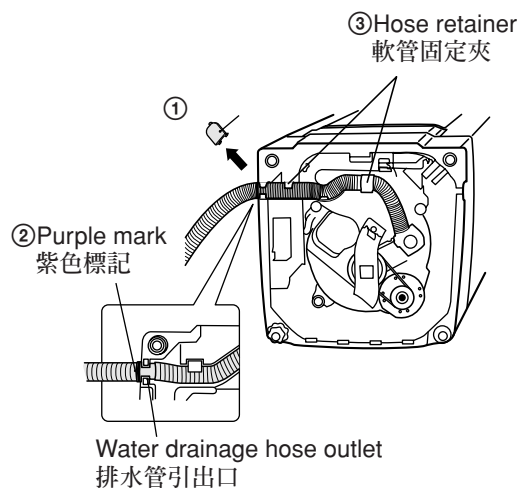

⚠ Attention 注意



The black or purple mark of the water drainage hose should be inserted into the corresponding groove of the unit.

安裝洗衣機時，請務必將排水管的黑色或紫色標記部嵌入機體相對應的凹槽內。

- Water drainage hose which inserts into the unit, can't touch other parts, to prevent the damage caused by water leakage.
排水管在機體內的部分，不應與其他部件碰觸，以免因破損產生漏水而導致不必要的損失。
- Water drainage hose retainer must be tightened.
排水管固定夾必須夾緊。
- The inner section of the water drainage hose must be secured by the retainer before fetched out.
排水管機內部分必須經固定夾固定後再引出。

■ When fitting the water drainage hose to the water drainage outlet

排水管插入排水口時

If the water drainage outlet is too shallow or the end of the water drainage hose touches the grounds, cut the end of the water drainage hose in an oblique angle.
排水口較淺或排水管前端與地面碰觸時，可將排水管的前端沿斜向切除一部分。

- Failure to do so may cause insufficient rinsing or unit malfunction due to poor drainage or too much subbles during rinsing and spinning.
若不切除，在沖洗及脫水時，由於排水狀況的不良，將會引起漂洗不充分或因肥皂沫而影響電機運轉。

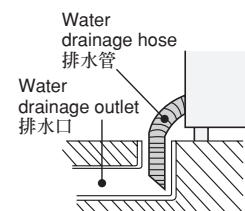

※ This discharge pipe installs the method to be only suitable in AJ-S55KX .
此排水管轉換方法只適用於 AJ-S55KX 。

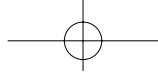

installation of the bottom plate 底板的安裝

The bottom plate is placed on the packaging foam on the top of the washer.
出廠時，底板安放在洗衣機頂部的包裝發泡上

1 Please place the washer transversely in a slight way.
請將機體輕輕地放倒。

- Before placing the washer transversely, lay some soft paper pad on the ground to avoid damage to the body.
放倒機體時，請在地面上放置一些瓦楞紙類的襯墊，以免損傷機身。

2 Align the hook on the bottom plate with the square hole on the chassis and insert it, then tighten the screw.
將底板上的倒鉤對准底盤上的方孔插入，然後擰緊螺釘。

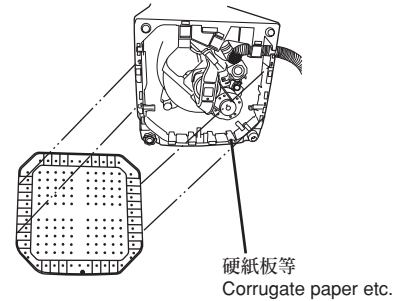

How to Install the Water Supply Hose 供水管的安裝

Connecting the water supply hose to the main unit 供水管與機體的連接

Firmly tighten the union nut when connecting the water supply hose to the main unit.
沿箭咀方向旋轉連接螺母，使其與供水口緊緊相連。

- Loosely tightened union nut will cause water leakage.
請務必擰緊供水管與機體的連接螺母。否則，將會漏水。
- When removing the hose, unscrew the union nut first.
拆卸供水管時，先鬆開連接螺母，再進行拆卸。

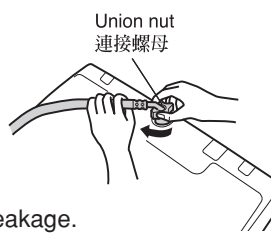

Extended the water supply hose 供水管的延長

Please use optional extension tube for lengthening the water supply hose.
請使用另行銷售的延長供水管。

Three standard of extension hoses (1m,2m,3m) are available. Please inquire distributors for extending the water supply hose.
備有 1m、2m 和 3m 三種規格供購買。
如欲駁長供水管，請向銷售商查詢。



Installation Guide (continued)

安裝指南 (續)

How to Install the One Touch Joint 便捷連接器的安裝

1 Confirm the diameter of the water tap. 確認水龍頭直徑。

- If the diameter exceeds 2cm, remove the joint ring.
若水龍頭的外徑超過2cm，可將連接環取出。

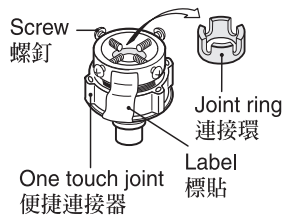

3 Press the sealed pad evenly against the tap and tighten the four screws in a uniform fashion. 將密封墊均勻地壓在水龍頭上，再將4個螺釘均等地擰緊。

將密封墊均勻地壓在水龍頭上，再將4個螺釘均等地擰緊。



Tighten screw in advance if it is located close to the wall.
靠近牆壁的螺釘，可預先用手擰進一些。

2 Check the distance between joints A and B. 確認接頭 A、B 之間間隙。

- Screw joint B in the arrow direction to adjust the gap.
沿箭咀方向旋轉接頭 B 調整間隙。

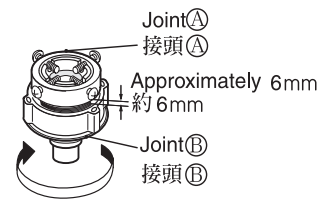

4 Tighten joint B in the arrow direction to reduce the gap between joint A and B to 4mm or less. 沿箭咀方向擰緊接頭 B，使接頭 A、B 之間間隙在 4mm 以內。

沿箭咀方向擰緊接頭 B，使接頭 A、B 之間間隙在 4mm 以內。

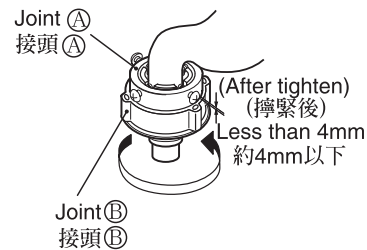

- For water supply hose installation, please refer to "How to install the water supply hose" in the user manual.
供水管的安裝參閱使用說明書中『供水管的安裝』一章。
- Loosening may occur with extended use. In such case, reinstall the joint following steps 2 to 4.
長時間使用後，可能會因鬆脫而引起漏水，此時請按 2 ~ 4 的步驟重新安裝。
(Carry out the same steps when reinstalling the one touch joint at a change of residence, etc.)
(搬家等需重新安裝便捷連接器時，請按照相同的步驟進行。)

Appropriate water tap 適用的水龍頭

Horizontal taps A and B as shown below.
橫式 A、B 型水龍頭最為適宜。

Horizontal tap A
橫式 A 型水龍頭



Horizontal tap B
橫式 B 型水龍頭



Square mouth tap
方口水龍頭



Distance must be over 1.6cm in order to install correctly.
若無 1.6cm 以上的距離將無法安裝。

Universal household tap
萬能水龍頭



May break off after install the one touch joint.
便捷連接器安裝後，可能會脫落。

Swivel tap
萬向水龍頭



Water leakage may occur.
有可能會漏水。



Installation 安裝

⚠ Attention 注意



Please turn on the water tap to check to connecting condition of the water supply hose before washing.

開始洗衣前，請先打開水龍頭，檢查供水管的連接狀況。

- To prevent damages caused by water leakage due to loosen screw.
如果螺釘鬆脫，會因漏水而招致不必要的損失。

How to install and remove the water supply hose

供水管的安裝方法和拆卸方法

Water tap 水龍頭

Do not allow water tap, one touch joint and rubber ring to touch the unit when installing them.
安裝水龍頭、便捷連接器以及滑環時，注意別讓它們碰到洗衣機機體。

■ Installing 安裝方法

1 Push down the rubber ring and insert the tap into the one touch joint.
將滑環下壓，然後插入便捷連接器內。

2 Release the rubber ring and push up the water supply hose until it clicks.
放開滑環，向上推壓供水管，直至發出“叭”的鎖緊聲為止。

- Pull the water supply hose to check that it does not come off easily.
拉一拉供水管，確認供水管不會脫落。

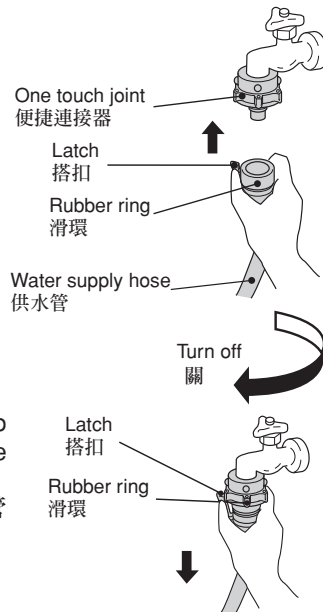

■ Removing 拆卸方法

1 Turn off the water tap.
關閉水龍頭。

2 Press the start button and let the unit run for about ten seconds.
按下啟動按鈕，運轉 10 秒鐘。

- This is to prevent water splash when removing the tap.
爲了防止拆卸時水花四濺。

3 Remove the latch and the water supply hose while pushing down the rubber ring.
鬆開搭扣，拉下滑環，同時將供水管拔下。

Main unit 機體

Turn the union nut in the direction as shown by the arrow and firmly. Connect it to the water supply opening.
沿箭咀方向旋轉連接螺母，使其與供水口緊緊相連。

⚠ Attention 注意



Firmly tighten the union nut when connecting the water supply hose to the main unit.

請務必旋緊供水管與機體的連接螺母。

- Failure to do so may result in water leakage.
螺母鬆脫的話，可能會漏水。



- Loosely tightened union nut will cause water leakage.
連接螺母如不擰緊，可能產生漏水現象。
- When removing the hose, unscrew the union nut first.
拆卸時，擰下連接螺母，即可拆除。
- Please note that water supply hose and one touch joint should be used.
請使用隨機配套的供水管和便捷連接器。
- The appliance is to be connected to the water mains using new hose-sets and that old hose-sets should not be reused.
應使用附帶的新的連接水管進行連接，舊的連接水管不得再次使用。



Safety Check 安全檢查

If any of the following conditions or other abnormalities occur, immediately pull out the power plug to prevent an accident and request help from an authorized dealer or agent.

如出現下列情況或其他異常現象，請立即拔下電源插頭，務必向有關的經銷商委托檢查、修理。(可能根據實際情況收取費用)

- Never conduct repairs by yourself as it may be dangerous.
請勿自行維修，以免發生危險。
- If you have used the washing machine for 4 - 5 years, even if the following conditions and other abnormalities do not occur, request for safety inspection of the machine is still required.
使用超過 4 ~ 5 年的洗衣機，即使沒有出現下列情況或其他異常現象，亦請進行安全檢查。
- If the power supply cord is damaged, Please repair it in a repair shop appointed by the manufacturer or its service agents in order to avoid a hazard.
電源線破損時，請到廠商指定的店鋪修理，以免危險。
- The washing machine is not to be used by children or persons with reduced physical, sensory or mental capabilities, or lack of experience and knowledge, unless they have been given supervision or instruction.
兒童、殘疾人士、智障人士在沒有監管和指導的情況下請勿使用本品。
- The washing machine having ventilation openings in the base.
The washing machine bottom must not be obstructed by carpeting when the washing machine is installed on a carpet floor.
洗衣機的底部應保持通風。
安置洗衣機時，請勿因地毯而妨礙洗衣機的底面安置。

- When you turn on the switch, the machine sometimes does not operate.
若打開開關，洗衣機或會停止運作。
- The power cord has "cracks" or "flaws".
電線出現損毀或裂痕。
- There are abnormal sounds and vibrations during operation.
運行過程中發出異常聲音或震動。
- The agitator does not stop easily. (It takes over 15 seconds for the agitator to stop)
洗衣槽不易停止。(停止洗衣槽需要 15 秒鐘以上)
- There is water leakage. (Basket, hose, joint, etc.)
漏水。(洗衣槽、水管、接頭等)
- There is a smell of burning.
有燒焦味。
- If you touch the machine, you may get an electric shock.
用手觸摸時，有電擊的感覺。

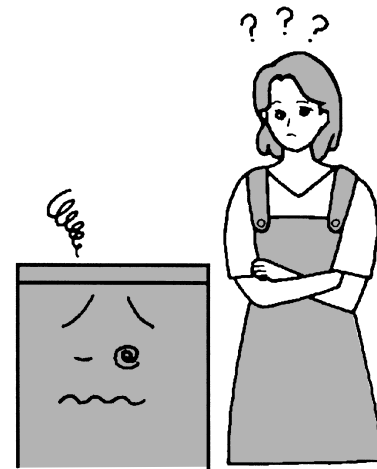

In case when the washing machine is used in places other than ordinary households.

在一般家庭以外使用時

- If the washing machine is in use for extremely long periods of time compared to ordinary household usage, such as in dormitories and hospitals, it may be necessary to change parts (such as the clutch, belt or sealed pad) more frequently. In this case, consult with the dealer from whom you purchased the washing machine and have the machine inspected periodically.
如在宿舍或醫院等地方使用，而每天的使用時間比一般家庭較長時，或需在短期內更換零件 (如离合器、皮帶、密封墊等)。請與購買洗衣機的商店聯絡，接受定期檢查後再使用。

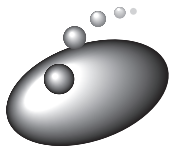

Washing Machine Repair 洗衣機修理事宜

In case of malfunction of the washing machine, read the manual in detail before requesting repair services. If the problem still cannot be solved, contact an authorized service dealer or a service agent and provide the following information.

- ① Model name: AJ-S55KXP、AJ-S55KX.
- ② Describe abnormal situations and damages in detail.
- ③ Your address and telephone number.

若洗衣機在使用期間發生故障，在請求維修前，請務必詳閱本說明書。若發生的故障或異常情況未能用本說明書的指示解決，請與認可的維修服務店聯絡。請向維修服務店提供下列資料：

- ① 產品型號：AJ-S55KXP、AJ-S55KX。
- ② 盡可能詳細的說明故障狀況或異常情況的內容。
- ③ 您的聯絡地址和電話號碼。



Technical Description

各部件名稱

☞ The number next to the sign is the page number for detailed description.

後面的數字表示詳細說明的頁數。

Water Inlet
供水口 ☞ 45

Inhaling Window
吸氣窗 ☞ 36
Nanometer titanium filter net
納米鈦淨化網 ☞ 42

Lid
機蓋

Water Drainage Hose
(Suitable in AJ-S55KX)
排水管 (適用AJ-S55KX)

Bleach and Liquid detergent injection opening
液體洗衣劑·漂白劑注入口 ☞ 22

Control panel
控制面板 ☞ 16

Powder synthetic detergent dispenser (Detergent injection)
粉末合成洗衣粉加入盤 (洗衣粉加入口) ☞ 21

Water Drainage Hose
(Suitable in AJ-S55KXP)
排水管 (適用AJ-S55KXP)

Washing · Spinning basket
洗衣·脫水槽

Pulsator
攪拌翼

Fabric softener injection
柔軟劑注入口 ☞ 22

Power Wire
電源線



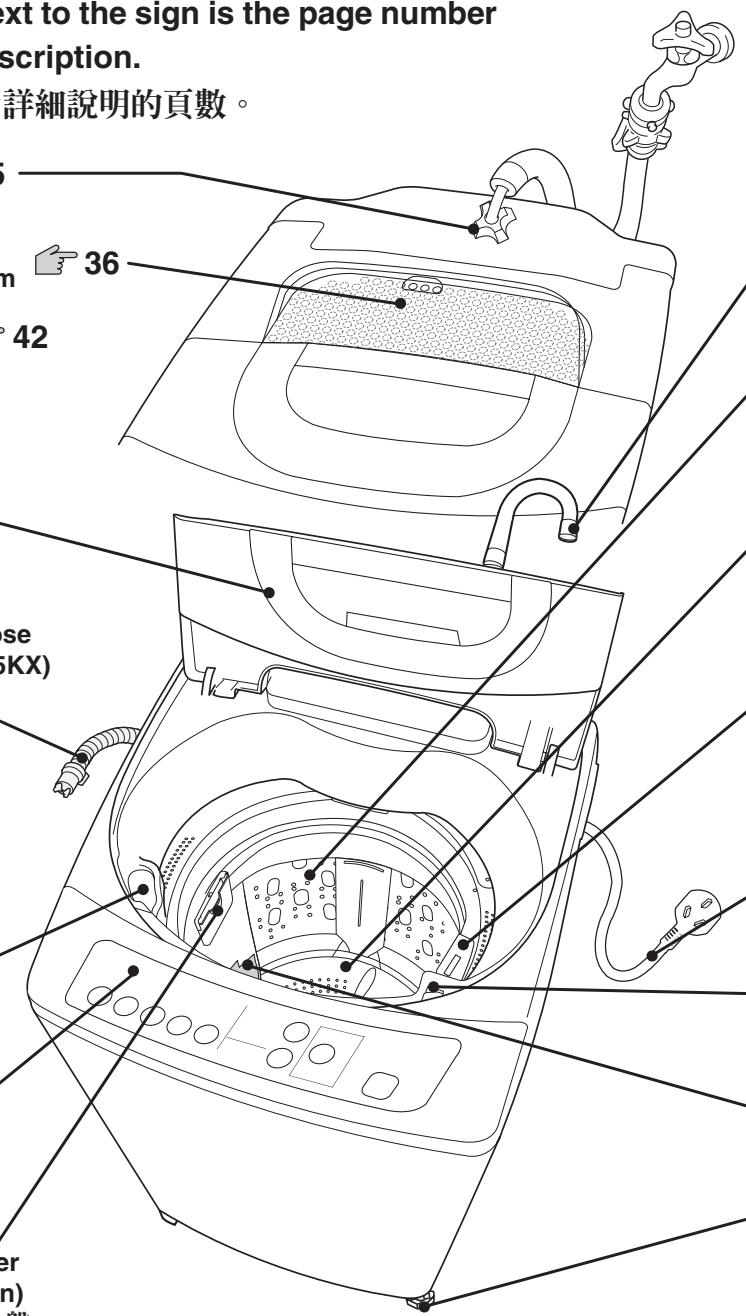

Lid Lock
機蓋緊鎖裝置 ☞ 18

Lint filter
棉絮過濾網 ☞ 43

Adjustable leg
(Where height of the front leg can be adjusted)
可調機腳 (可調節前腳高度) ☞ 8

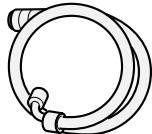
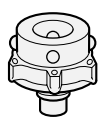

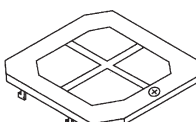
Accessories (Refer to “Installation Guide”) 附件(請參照『安裝指南』)

<p>Water supply hose 供水軟管</p>  <p>(One) (1 根)</p>	<p>One touch joint 便捷連接器</p>  <p>(One) (1 個)</p>	<p>Leg cap 腳套</p>  <p>(Two) (2 個)</p>	<p>Base plate (Screws include) 底板(帶螺釘)</p>  <p>(One) (1 塊)</p>	<p>Water Drainage Hose 排水管</p>  <p>(One)(1 根) (Suitable in AJ-S55KXP) (適用 AJ-S55KXP)</p>	<p>Fixing holder of water drainage hose 排水管固定架</p>  <p>(One)(1 個) (Suitable in AJ-S55KXP) (適用 AJ-S55KXP)</p>
--	---	--	--	---	---



Control Panel (AJ-S55KXP) 控制面板 (AJ-S55KXP)

Lid Lock indicator 機蓋緊鎖裝置

Lid Lock indicator will light when the lid is in locked status.
機蓋鎖緊時，指示燈亮起。

- Before the water supply, the lid is in the status of locking.
開始供水前，機蓋處於鎖緊狀態。

Washing indicator 洗衣內容表示

The indicators of washing, rinsing and spinning display the ongoing process and its duration.
洗衣、沖洗、脫水各相應指示燈的顯示，告知您正在進行的洗衣內容和洗衣時間。

- During the washing machine operation, the display (lighting, flashing, darkening) of indicator of each process describes the operation status and the working process to the user.
(Setting injection rinse in AJ-S55KX)
洗衣機在運轉過程中，通過各進程指示燈的顯示（點亮、閃動、熄滅）告知使用者程序的運行狀況及其進程。
(AJ-S55KX可設定注水沖洗)

Detergent indicator 洗衣粉量表示

The detergent amount and the water level are described by the lighting or flashing of indicator. The amount of detergent refers to the (concentrated) powder detergent. 23
通過指示燈的點亮或閃動來顯示洗衣粉量和水位。洗衣粉量表示的是（濃縮）粉末洗衣粉。23

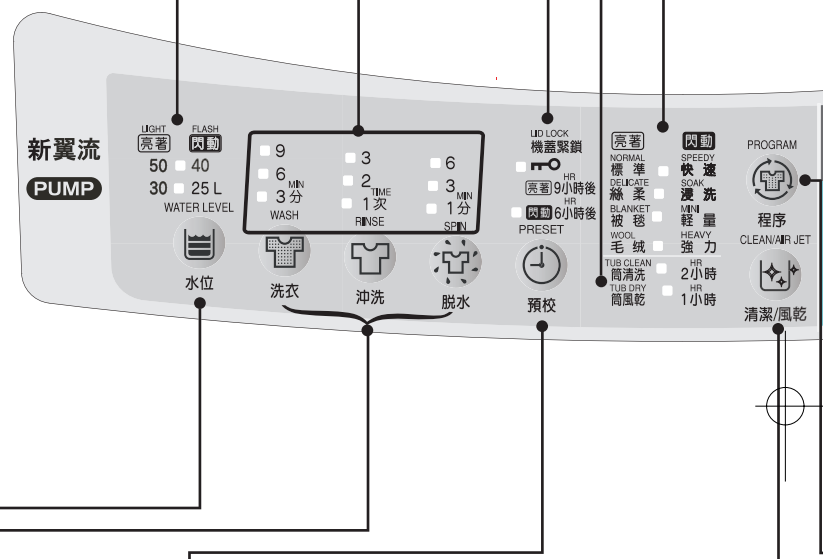

WATER LEVEL button 水位按鈕

Used to set the water level manually or replenish water during the agitating.
在按照自己需要設定水位或在攪拌過程中想再注水時使用。

- After the washing machine starts, any change of setup shall be made before the end of washing and rinsing. Before making the change, please press the "PAUSE" button. (During the course from starting the water supply to reaching the required level, the setup can't be changed)
洗衣機啟動後，若需更改設定，請在洗衣、沖洗結束前進行。在進行變更操作前，請先按下暫停按鈕。（從開始供水到到達規定水位的過程中不能更改設定）
- Press and hold the "WATER LEVEL" button to replenish water during the course of washing or rinsing. (No water will be replenished after reaching the top water level of each process)
洗衣或沖洗過程中若要再注水，請持續按住水位按鈕，即進行加水。（達到各程序的最高水位後便不再進水）

WASH • RINSE • SPIN button 洗衣 • 沖洗 • 脫水按鈕

Used to set the processes of washing, rinsing or spinning manually or change the setup.
在按照自己需要設定洗衣、沖洗、脫水方式或更改設定內容時使用。

- After the washing machine starts, any change of setup shall be made after the operation comes to a pause. During the course from starting the water supply to reaching the required level, or after the end of washing, the setup can't be changed. (There are also processes allowing no change. 38)
洗衣機啟動後需更改設定的話，必須在暫停運轉後更改。從開始供水到到達規定水位的過程中，或洗衣結束後不能更改設定。（也有不能進行更改的程序 38）

PRESET button 預校按鈕

The button is used to preset the operation time. 31
預校運轉時使用。31

- The washing process can be set to finish in nine hours.
洗衣可預校在9小時後完成。
- Pre-defined operation can work in "NORMAL" and "MINI", "HEAVY", "SPEEDY", "SOAK", but not for other modes.
『標準』，『輕量』，『強力』，『快速』，『浸洗』程序可設定預校運轉，其餘程序不可設定。

CLEAN/AIR JET button 清潔 / 風乾按鈕

Used to set the clean duration the air-jet duration or the basket air-jet duration.
在設定清潔或風乾時使用。

Attention 注意

- Never press 2 (or more) buttons together, which may cause misoperation.
請勿同時按住 2 個以上(包括 2 個)的按鈕，以免造成誤操作。

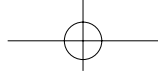

Sailing indicator
 慳水表示

The lamp will light when setting the program of "NORMAL", "DELICATE", "WOOL", "SPEEDY" and "MINI" auto running.
 設定『標準』、『絲柔』、『毛絨』、『快速』、『輕量』程序自動運行時，慳水指示燈亮。
 ※ If setting "water level" or "washing indicator" in above program manually, the lamp will put off.
 如果手動設定上述程序中的『水位』或『洗衣內容』時，慳水指示燈熄滅。

CLEAN/AIR JET indicator
 清潔 / 風乾內容表示

Please select the proper air-jet duration in compliance with the air-jet level required to the laundry. The indicator lights to describe the air-jet duration.
 根據對衣物的風乾程度，請選擇相應的風乾時間。通過各指示燈點亮或閃動，顯示出風乾時間。

TUB DRY (LED ON) → TUB CLEAN (LED ON)
 筒風乾(亮著) → 筒清洗(亮著)
 DRY for 1 hour (FLASH) ← DRY for 2 hour (FLASH)
 風乾1小時(閃動) ← 風乾2小時(閃動)

Program indicator
 程序顯示

The indicator of selected process will light or flash. With each pressing on the "PROGRAM" button, the indicator will light in the following sequence.
 被選程序的指示燈會點亮或閃動。每按一下『程序』按鈕，指示燈會按以下的順序亮起。

NORMAL (LED on) → DELICATE (LED on) → BLANKET (LED on) → WOOL (LED on)
 HEAVY (Flash) ← MINI (Flash) ← SOAK (Flash) ← SPEEDY (Flash)
 標準(亮著) → 絲柔(亮著) → 被毯(亮著) → 毛絨(亮著)
 強力(閃動) ← 輕量(閃動) ← 浸洗(閃動) ← 快速(閃動)

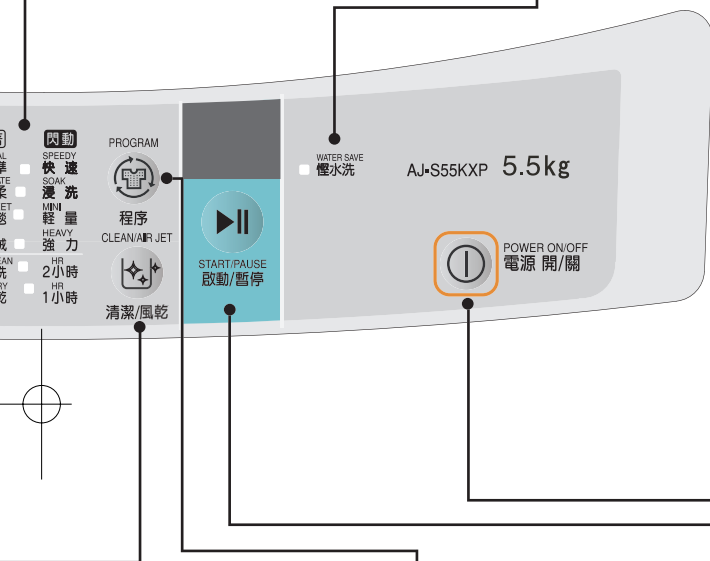

PROGRAM button
 程序按鈕

There are eight options available, you can choose the right one based on the types and dirty levels of the washings. 24
 備有8種程序，可根據衣物的種類和髒污程度來選擇適合的程序。24
 ● By pressing the "PROGRAM" button, the indicator of the selected process will light or flash.
 按動『程序』按鈕，所選擇的程序指示燈會點亮或閃動。

START/PAUSE button (One touch button)
 啟動/暫停按鈕『一按通按鈕』

The button is used to start the operation or temporarily pause the operation.
 控制洗衣機啟動或暫停時使用。
 ● After selecting the required process, press this button to start or pause the process operation.
 選擇好需要的程序後，按此按鈕可啟動或暫停執行程序。
 ● If press the "PAUSE" button during the course of spinning, no button signal can be received until the switching off the power, and the lid can't be opened. 如脫水過程中按下暫停按鈕後，到關斷開為止都不再接收任何按鈕信號，機蓋亦不能打開。

POWER switch
 電源開關按鈕

Used to "switch on" and "switch off" the power.
 用於電源的『開』和『關』。
 ● When the washing cycle finishes, the buzzer beeps and the power of the unit will be switched off automatically. The washing machine will be automatically switched off after 5 minutes of no start with power on.
 49
 電源自動關閉功能運轉結束後，洗衣機發出蜂鳴聲並自動切斷電源。接通電源後，不啟動洗衣機，將其放置5分鐘後也會自動關閉電源。49

In the case of any of the following manual setup, the washing machine will make 2 sounds for acceptance (to announce the datum mark of indication):

當手動設定為下述狀態之一時，洗衣機都會發出2聲表示接收的聲響(以告知您指示基準點)：

① The water level is "50L"; ② The washing duration is 15 minutes ("9 minutes" + "6 minutes"). ③ Rinsing duration is "twice"; ④ The spinning duration is "6 minutes"; ⑤ The preset duration is "9 hours later"; ⑥ The process switches to "NORMAL"; ⑦ CLEAN/AIR JET to "TUB CLEAN".

①水位為『50L』；②洗衣時間為『15分(『9分』+『6分』)』；③沖洗次數為『2次』；④脫水時間為『6分』；⑤預校時間為『9小時後』；⑥程序切換到『標準』程序；⑦清潔 / 風干切換到『筒清洗』程序。

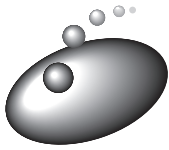

Control Panel (continued) 控制面板 (續)

Lid Lock function 機蓋緊鎖功能

The lid will be locked automatically when washing for children's safe.

爲防止意外傷害及保護兒童的安全，洗衣過程中供水開始後，洗衣機會自動將機蓋鎖緊。

Attention 注意

- With the set of Lid Lock function, the washing machine can't operate if the lid is opened. (The control panel will release the alarm if the lid is opened)

設定機蓋緊鎖功能後，洗衣機不能在機蓋處於開啟狀態時運轉。(機蓋處於開啟狀態時，控制面板將發出警報)

※ Factory initial state for "safe mode".

出廠初始狀態爲“安全保護模式”。

Remove safe mode 解除安全保護模式

1 Press "POWER ON/OFF" button .

按下『電源開/關』按鈕 .

2 Press and hold down the "WASH" button  for at least three seconds, then the safe mode can be removed.

持續按住『洗衣』按鈕  3 秒鐘以上，可解除安全保護模式。

- Press and hold down the "WASH" button  for at least three seconds again to set the safe mode.

再持續按住『洗衣』按鈕  3 秒鐘以上，可設定安全保護模式。

3 Cut off the power supply.

切斷電源。

When you want to open the lid 想打開機蓋時

Press "START/PAUSE" button  Lock will be removed automatically after washing. Lid can be opened.

按下『啟動/暫停』按鈕  旋轉結束，鎖緊解除，可打開機蓋。

When beginning again 再啟動時

With the set of safe mode, the lid will be locked as the washing machine restarts.

Without the set of safe mode, the lid will be locked automatically during the course spinning.

在設定爲安全保護模式時，洗衣機再啟動時機蓋會立即被鎖緊。

若沒有設定安全保護模式，在脫水時機蓋會自動鎖緊。

Hope to switch off the buzzer beep after the completion of the washing process 希望消除洗衣結束的蜂鳴聲時

Follow the below steps to switch off the buzzer beep after the completion of washing process.

按以下順序進行操作，可消除洗衣結束的蜂鳴聲。

1 Press the power button.

接通電源開關。

2 Press and hold down the "START/PAUSE" button for at least three seconds, the buzzer beep can be switched off.

持續按住『啟動/暫停』按鈕 3 秒鐘以上，蜂鳴聲消除。

- You can press and hold down the "START/PAUSE" button for at least three seconds to recover the beeping.

接通電源開關後，持續按住『啟動/暫停』按鈕 3 秒鐘以上，可將蜂鳴聲恢復。



Before Using Your Machine

開始洗衣前

● Preparation for washing machine

洗衣機的準備

When the first using 第一次使用時

The washing machine can be used only after the proper installation in compliance with the "Installation Guide".
按照『安裝指南』，確定將洗衣機安裝好後才可使用。

Daily using 日常的使用

- 1 The U-shaped hose on the tail shall be tightly secured. (Suitable in AJ-S55KXP)**
排水管尾端的 U 型管應牢靠地掛靠。(適用 AJ-S55KXP)
The front of the water drainage hose must insert in the water drainage outlet. (Suitable in AJ-S55KX)
排水管前端應牢固地插入排水口內。(適用 AJ-S55KX)
- 2 Connect the water supply hose and turn on the water tap.**
接好供水管並緩慢打開水龍頭。
- 3 Insert the power plug into the socket.**
將電源插頭插入插座。

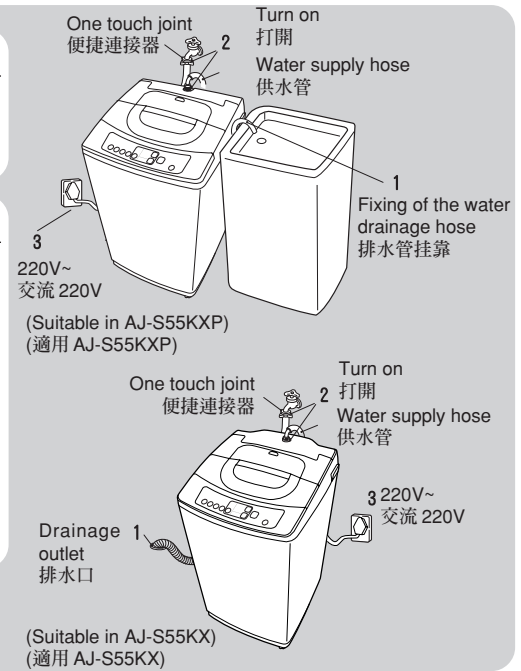

● Preparation for laundry

洗衣前的衣物準備

Secure strings and pull zips up before putting laundry into the washing machine. (beneficial suggestion)

洗滌帶有帶子或拉鏈的衣物時，請先繫好帶子或將拉鏈完全拉上。(有益的提示)



- This is to prevent damage to clothes and zips.
防止損傷衣物和拉鏈。

The laundry from which the hair or silk is inclined to run shall have its inner side turn to external before washing.
易起球或脫絲的衣物，請先翻至內面再進行洗滌。



Please remove soil or dirt from laundry before washing.
洗滌前，請先將衣物上的泥沙除去。



Remove anything from the laundry before washing. (Do not forget anything in pocket)

洗滌前，請先取出衣服中的異物。(不要忘記口袋中的東西)



- To avoid damaging the clothes and unit malfunction.
以免損傷衣物或導致洗衣機出現故障。

Clothes of easily-fadeaway colors must be separated.
易褪色的衣物應分開洗滌。

The jeans and alike
如牛仔褲等衣物

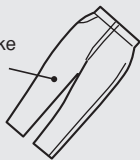

- The bluejeans that are inclined to fade may decolor during washing.
洗滌易褪色的藍色牛仔褲可能會引起褪色現象。

The vulnerable laundry shall be put into the wash string bag before washing.
洗滌容易損傷的衣物時，請放入洗衣袋中進行洗滌。

To be cautious, please put the laundry with lace or the woman underwear with steel wire into the optional wash string bag before washing.
慎重起見，請將帶蕾絲的衣物或帶鋼絲的女性內衣放入市面出售的洗衣袋中清洗。

- Prevent the laundry from damaging by accident.
防止衣物意外受損。

The laundry from which the silk is inclined to run shall be put into the string bag before washing.
易抽絲的衣物請放入洗衣袋中清洗。

The laundry made of corduroy or other particular cloth, and the black hose or other clothing sensitive to silk-running shall be put into the optional anti-silk-running string bag before washing.

像燈芯絨等特殊布料或黑色長統襪等容易脫絲的衣物，請放入市面出售的防脫絲洗衣袋中清洗。

Please handle the dirt as early as possible.
請盡早處理污垢。

As it's hard to remove the dirt after adhering to laundry for long, the dirt shall be under cleanout and handling with detergent before washing, which brings better washing effect.

污垢長時間附在衣物上會很難脫落，在洗衣前先清洗污垢並用洗衣粉處理，洗衣時效果會更加明顯。



Before Using Your Machine (continued) 開始洗衣前（續）

● How to put laundry in 衣物的放入方法

Put in the laundry as evenly distributed as possible.
盡可能均勻地放入待洗衣物。

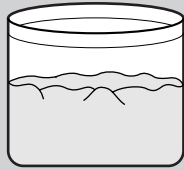

Put bulky or floating laundry in basket first.
大件衣物或易浮起的衣物應先放入洗衣槽。



- It smoothes rotation of the laundry.
有利於衣物的良好旋轉。
- Splash of water must be prevented.
防止水滴飛濺。

The bluejeans and other thick cloth shall be evenly distributed in the washing basket before washing.
(Prevent the laundry from overflowing during washing)
將牛仔褲等厚布料衣物均勻地放入洗衣槽內再進行清洗。
(防止脫水時衣物溢出)

- Splash of water must be prevented.
防止水滴飛濺。



Checking amount of laundry and detergent (Approximately amount) 檢測洗衣量和洗衣粉量（大致用量）

● Checking amount of laundry 洗衣量的檢測

Select the process required for washing after put in the laundry, and press the "START" button. The sensors begin to detect the weight of laundry, and the necessary detergent amount (approximate amount) and water level are displayed correspondently. (The detection is not included in the processes of "DELICATE", "SPEEDY", "WOOL", "BLANKET", "DRY CLEAN" and "AIR JET".)
放入衣物後選擇洗衣所需程序，按下『啟動』按鈕，傳感器開始檢測衣物重量，並相應顯示所需的洗衣粉量（大致用量）和水位。（『絲柔』、『快速』、『毛絨』、『被毯』、『筒清洗』、『風乾』程序不進行檢測。）

1 Put the laundry in, turn the power ON, choose the appropriate process, and press the START button.
放入衣物，按下電源開關按鈕。
選擇洗衣所需程序，按下啟動按鈕。



- The pulsator rotates with absence of water to check the washing load (cause no damage to clothes)
攪拌翼在無水狀態下旋轉，檢測洗衣量。
(不會損傷衣物)

2 Display the necessary detergent amount and water level.
顯示所需的洗衣粉量和水位。

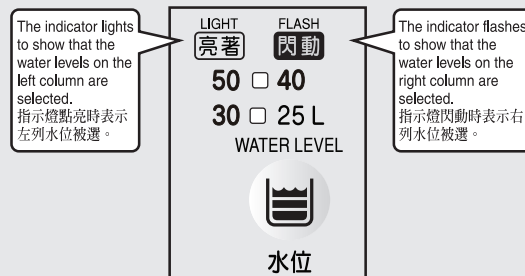

3 Put the detergent in. (☞ 20-22)
放入洗衣粉。（☞ 20-22）

- Put detergent fabric softener bleach and close the lid.
放入洗衣粉、柔軟劑、漂白劑後，請關閉洗衣機機蓋。
- After the display of the detergent amount and water level, please add in detergent in one minute, and close the lid, otherwise it will sound alarm. (at that time, if the "WATER LEVEL" button is pressed, the washing machine will not wait any more and start rotating)
顯示洗衣粉量和水位後，請在 1 分鐘內放入洗衣粉，並關閉機蓋，否則將響起警報。（此時若按下“水位”按鈕，則洗衣機不再等待而立即開始旋轉）
- After the washing basket is filled with water or begins operating, the replenishing detergent shall be thrown into the basket directly.
洗衣槽中有水或運轉開始後，如要增加洗衣粉，請將洗衣粉直接倒入洗衣槽中。

● Amount of detergent (Approximately amount) 洗衣粉量（大致用量）

The display of detergent amount (approximate amount) refers to the amount added with the measuring spoon in the package of concentrated power detergent.
洗衣粉量（大致用量）的顯示是指濃縮粉末洗衣粉包裝盒中計量匙的加入量。

- The usage benchmark of detergent amount (approximate amount) is the capacity of one measuring spoon (about 37g). (Other detergent ☞ 23)
洗衣粉量（大致用量）的使用量是以計量匙一匙（約 37 克）為基準。（其他洗衣粉 ☞ 23）
- The capacity of measuring spoon depends on the brand of detergent, so please refer to the description on the detergent package.
計量匙的大小按洗衣粉品牌不同而不同，詳情請參照洗衣粉包裝上的說明。
- The diagram example of detergent measuring spoon only stands for the approximate amount.
洗衣粉計量匙的圖示只表示大致用量。

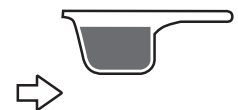
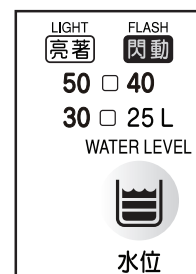

Please put in the detergent as much as 80% of the capacity of measuring spoon (about 30g).
請放入計量匙 80% 左右（約 30 克）的洗衣粉。

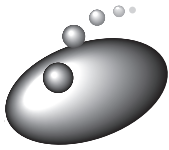

How to Use Liquid Detergent, Bleach and Fabric Softener

洗衣粉、漂白劑、柔軟劑的使用方法

Start the washing machine with water in the washing basket, and the infiltration washing can't perform then. Please put the detergent in the washing • spinning basket.

在洗衣槽有水時啟動洗衣機，不能進行滲透清洗。請將洗衣粉放入洗衣•脫水槽內。

Powder synthetic detergent 粉末合成洗衣粉

Put the detergent in the detergent dispenser

將洗衣粉放入洗衣粉加入盤內

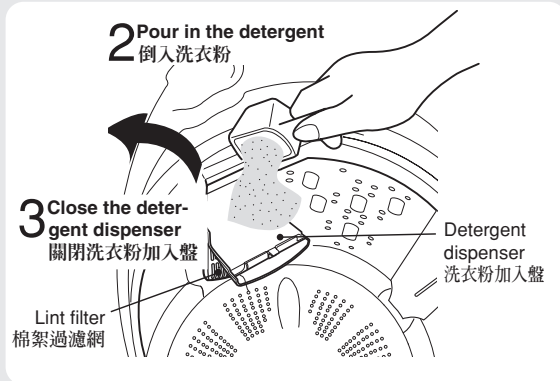

Notes 備注

- When water is adhering to the detergent dispenser, please wipe it first. 洗衣粉加入盤有水滴時，請擦乾水滴後注入洗衣粉。
- When the detergent adheres to the dispenser, it remains even the dispenser is closed. If the detergent still adheres to the dispenser after 2 or 3 times of repetitive open and close, please remove the dispenser for cleaning up. (☞ 43) 洗衣粉黏附在盤上時，即使關閉，洗衣粉也會殘留在加入盤內。反復開關2、3次後仍然附在加入盤上時，請拆下加入盤進行清洗。(☞ 43)
- Please pay attention to keep the detergent away from the injection opening of fabric softener, so as to avoid malfunction. 請注意避免將洗衣粉注入柔軟劑注入口內，以免引致故障。
- Some types of detergent may be hard to dissolve. In this case, please inject the detergent into the washing basket directly after it sufficiently dissolves. 有些種類的洗衣粉可能較難溶解。此時，待洗衣粉充分溶解後請直接將其注入洗衣槽內。
- In the case of bulky laundry, sometimes it may be hard to open the detergent dispenser. In this case, please move the laundry to the opposite side of injection opening, then open the dispenser. 洗衣量太多時，有可能難以打開洗衣粉加入盤。此時，請將衣物撥向注入口的對面一側，再打開加入盤。
- Only after closing the detergent dispenser can the operation begin. The laundry may be damaged under the operation with the dispenser open. 請務必關閉洗衣粉加入盤後才可進行運轉。在加入盤開啟狀態下運轉，很可能會損傷衣物。
- The detergent dispenser can be opened as much as about 90 degrees. Any action to open it by force may cause damage. 洗衣粉加入盤只能打開約90°的角度。強行打開可能會造成損壞。

How to install the detergent dispenser

洗衣粉加入盤的安裝方法

Insert the pin into the pin hole at the injection opening. 將洗衣粉加入盤的銷釘分別插入注入口兩端的銷釘孔內。

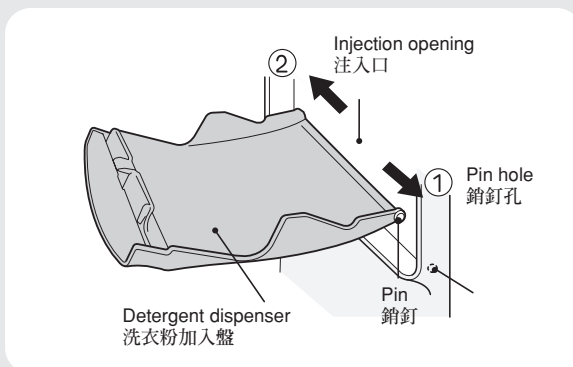

How to uninstall the detergent dispenser

洗衣粉加入盤的拆卸方法

- ① Bend the detergent dispenser. 彎折洗衣粉加入盤。
- ② Disassemble the pin off the pin hole. 將銷釘從銷釘孔中卸下來。

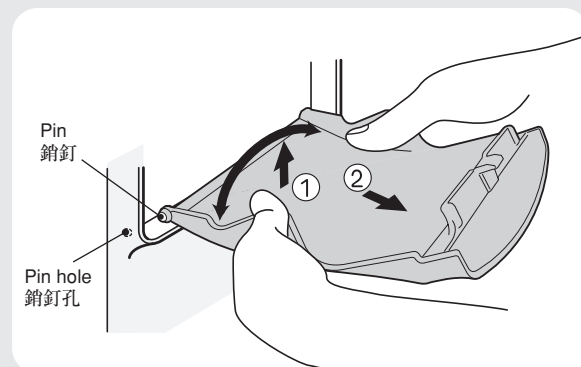



How to Use Liquid Detergent, Bleach and Fabric Softener (continued)

洗衣粉、漂白劑、柔軟劑的使用方法（續）

Liquid detergent/Bleach 液體洗衣劑 / 漂白劑

Liquid detergent 液體洗衣劑

Dilute the liquid detergent with water and gently pour it into the injection opening.

將液體洗衣劑用水均勻稀釋，由注入口慢慢倒入。

- When using preset operation, dilute the detergent with twice the amount of water.
預校運轉的時候請稀釋成二倍後再使用。

Bleach 漂白劑

Dilute the bleach with water before the washing and gently pour it into the injection opening.

開始洗衣時，先用水稀釋，然後由注入口慢慢倒入。



Attention 注意

- Follow the instructions for the liquid detergent and bleach on the labels for the usage amount and method to use.
關於液體洗衣劑和漂白劑的使用量和使用方法，請參照其相關說明。
- Please do not pour bleach directly onto the items being washed. Otherwise, it may cause discoloring and damage the clothes.
請避免將漂白劑直接用於衣物上，以免引起變色或布料損壞。

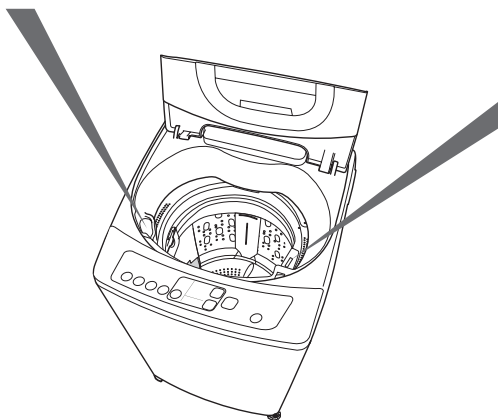

Notes 備注

- The concentrated type easily solidifies. Please use twice the amount of water to dilute such fabric softener.
濃縮型柔軟劑易於固化，因此請用 2 倍清水將其稀釋後再使用。
- Once consumption of the softener shall be less than 45ml. Excessive consumption of the softener instead prevents it from being effective.
柔軟劑的“一次使用量”應低於 45mL，使用過多的柔軟劑反而不能有效發揮作用。
- Please do not leave the fabric softener in the basket for an extended period (12 hours) as the fabric softener may solidify and cause malfunction.
請勿讓柔軟劑長時間(超過 12 小時)停留在洗衣槽內，以免柔軟劑在注入口中固化，導致洗衣機運轉不良。
- When the washing machine or the basket is tilted, water may flow into fabric softener injection opening. (Thus fabric softener performance will be reduced)
若洗衣機傾斜或供水時洗衣槽傾斜時，水可能會流進柔軟劑注入口。(導致柔軟劑失去其應有的作用)
- Please use an appropriate amount of detergent. Too much fabric softener may result in poor rinsing and fabric softener performance.
請使用適量的洗衣粉，使用量過多會降低漂洗效果和柔軟劑的效果。

Fabric softener 柔軟劑

- Open the cap of the fabric softener injection opening.
打開柔軟劑注入口的蓋子。

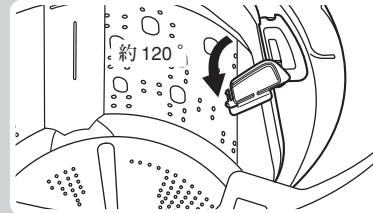

- Softener filling opening can only be opened by an angle of up to 120°. Forced operation may damage the filling opening.
柔軟劑注入口只能打開約 120° 的角度。強行打開可能會損壞注入口。

- Pour the fabric softener into the injection opening in accordance with the indication of water level before the washing starts.

洗衣開始前，按照水位表示，將柔軟劑倒入柔軟劑注入口內。

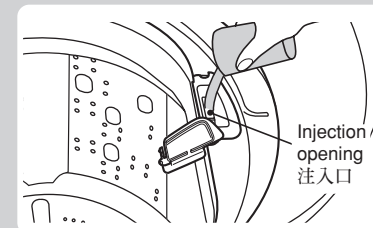

- When you find it difficult to pour the fabric softener into the injection opening, push the basket to one side to pour the fabric softener in.
當柔軟劑不易倒入注入口時，請將洗衣槽偏向一側後再倒入柔軟劑。

- Close the cap of the fabric softener injection opening.
關閉柔軟劑注入口的蓋子。

- Please note that the cap of fabric softener injection opening should be closed.
請務必關閉柔軟劑注入口的蓋子才可進行運轉。

- Fabric softener will be dispensed into the basket during the final rinse.

柔軟劑會在最後一次漂洗前自動投入槽內。

- Dispensation of the fabric softener is performed automatically by the rotation of the spinning basket. The fabric softener moves in gradually during the spinning and reaches the basket before the final spinning.
柔軟劑是利用脫水槽旋轉而自動投入槽內的，在中間脫水過程中，柔軟劑從注入口移向內部，直至最後脫水結束前投入槽內。

<Approximate amount of fabric softener>

<柔軟劑的大致用量>

Water level 水位		25L	30L	40L	50L
Fabric softener 柔軟劑	Concentrated type 濃縮型	6 mL	7 mL	9 mL	11 mL
	Regular type 普通型	17 mL	20 mL	27 mL	33 mL

- Concentrated detergent: 6.6mL for 30L of water

濃縮型柔軟劑：水位 30L 使用量 6.6mL



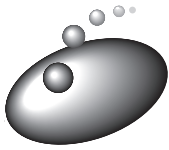

- Normal detergent: 20mL for 30L of water

普通型柔軟劑：水位 30L 使用量 20mL



Amount of Laundry and Detergent

洗衣量和洗衣粉量

Amount of Laundry 洗衣量	Water Level 水位	Synthetic detergent 合成洗衣劑		
		Concentrated detergent 濃縮型洗衣劑		Regular detergent 一般洗衣劑
		20g for 30L of water (Powder) 水位 30L 需 20g (粉末)	25mL for 30L of water (Liquid) 水位 30L 需 25mL (液體)	40g or 40mL for 30L of water (Powder, Liquid) 水位 30L 需 40g 或 40mL (粉末、液體)
5.5kg	50L	33g 	42mL	67g (67mL)
3.5kg	40L	27g 	33mL	53g (53mL)
1.5kg	30L	20g 	25mL	40g (40mL)
0.5kg	25L	13g 	17mL	27g (27mL)

- Please refer to the description given by the detergent manufacturer for the usage amount and the details of detergent.
洗衣粉的使用量，詳細情況請參照洗衣粉生產廠家的說明。
- The list of detergent amount (approximate amount) in this table takes the measuring spoon in the package of concentrated synthetic detergent as benchmark. (20g detergent for 30L water)
本表中洗衣粉量（大致用量）的表示，以濃縮合成洗衣粉包裝中的計算匙為基準。（水位 30L 使用 20g 洗衣粉）
- If laundry is only lightly stained, use only half of the amount of detergent to be used.
如果衣物只是輕微有些髒，則洗衣粉量為上表所示值的一半為宜。
- The excessive usage of detergent brings no more cleanness but the side effect of insufficient rinsing.
使用過多的洗衣粉並不能增加洗衣的潔淨度，相反會引起沖洗不充分而導致弊端。

Amount of Laundry 洗衣量

- Laundry load varies according to different taps, sizes and thickness of cloth. Approximate weight of laundry is shown in ().
表中()內所示的是一件衣物的大致重量。由於洗滌的衣物種類、大小、厚度各有不同，因此洗衣量也有所不同。
- When washing normal clothes, the appropriate amount of washing load is about 70 to 80 percent of the amount indicated. In case the agitator stops which indicates overload, please check and if necessary, adjust the load.
如為一般衣物，其洗衣量為表中所示值 70%~80% 最為恰當。若攪拌停止，表示放入的衣物過多，請檢視衣物旋轉情況並予以調整。

Approximate amount of laundry 衣物的大致重量



Briefs (Cotton 50g)
男用內褲（棉約 50g）



Long-sleeved vest (Cotton 150g)
長袖內衣（棉約 150g）



Bath towel (Cotton 300g)
浴巾（棉約 300g）



Socks (Cotton 50g)
襪子（棉約 50g）



Blouse (Blended materials 200g)
女式襯衣（混棉約 200g）

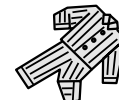

Pajama (Top and bottom)
(Cotton 500g)
睡衣（上、下）（棉約 500g）



Towel (Cotton 70g)
毛巾（棉約 70g）

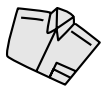

Shirt (Blended materials 200g)
男式襯衣（混棉約 200g）











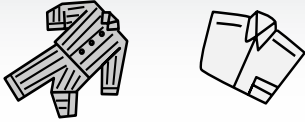
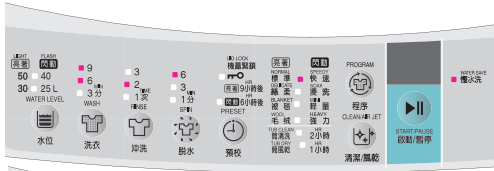

Sheet (Cotton 500g)
床單（棉約 500g）

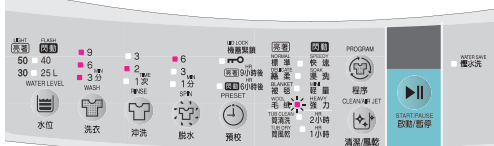
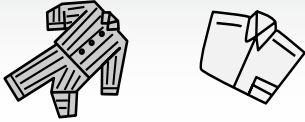

Selection of Laundry Process

洗衣程序的選擇方法

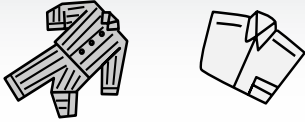
The washing machine have eight laundry courses.
Please select the appropriate detergent and course for laundry according to the table below.
本洗衣機備有 8 種洗衣程序：
請參照下表，根據衣物種類和髒污程度選擇適合的洗滌程序。

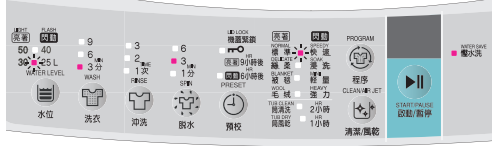
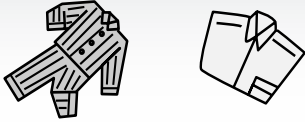
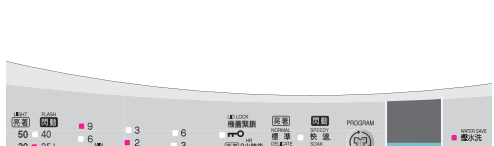
Type of laundry 衣物種類	Recommended Automatic Program 建議的全自動程序	Control Panel Display 控制面板顯示	Recommended Detergent 推薦的洗滌劑
Regular laundry 一般的衣物 	NORMAL 標準 Automatically select the program suitable for washing. 以適當洗滌物的方式，進行自動洗滌。		Power synthetic detergent 粉末合成洗衣粉 Liquid detergent 液體洗衣劑 Special detergent used in dothes with dry-clean label 乾洗標誌衣物專用洗衣劑 Neutral liquid detergent 液體中性洗衣劑
Heavily stained laundry 嚴重污垢的衣物 	MINI 輕量 對小件衣物進行洗滌。		
Heavily stained laundry 嚴重污垢的衣物 	HEAVY 強力 Use powerful currents to wash. 用強水流洗滌衣物。		
Regular laundry 一般的衣物 	SOAK 浸洗 Wash with special moving steeped water flow. 運用特設的運動浸泡水流進行洗滌。		
Heavily stained laundry 嚴重污垢的衣物 	DELICATE 絲柔 Wash with soft water current. 利用柔和水流精心洗滌。		
Regular laundry 一般的衣物 	SPEEDY 快速 The fastest way to clean your laundry. 以最快的方式來洗滌衣物。		
Heavily stained laundry 嚴重污垢的衣物 	WOOL 毛絨 Wash with spinning water current. 利用旋轉水流精心洗滌。		
Regular laundry 一般的衣物 	BLANKET 被毯 Wash with blanket water current. 利用被毯水流精心洗滌。		

* Above control panel demonstration content take AJ-S55KXP as an example.
以上控制面板顯示內容以 AJ-S55KXP 為例。

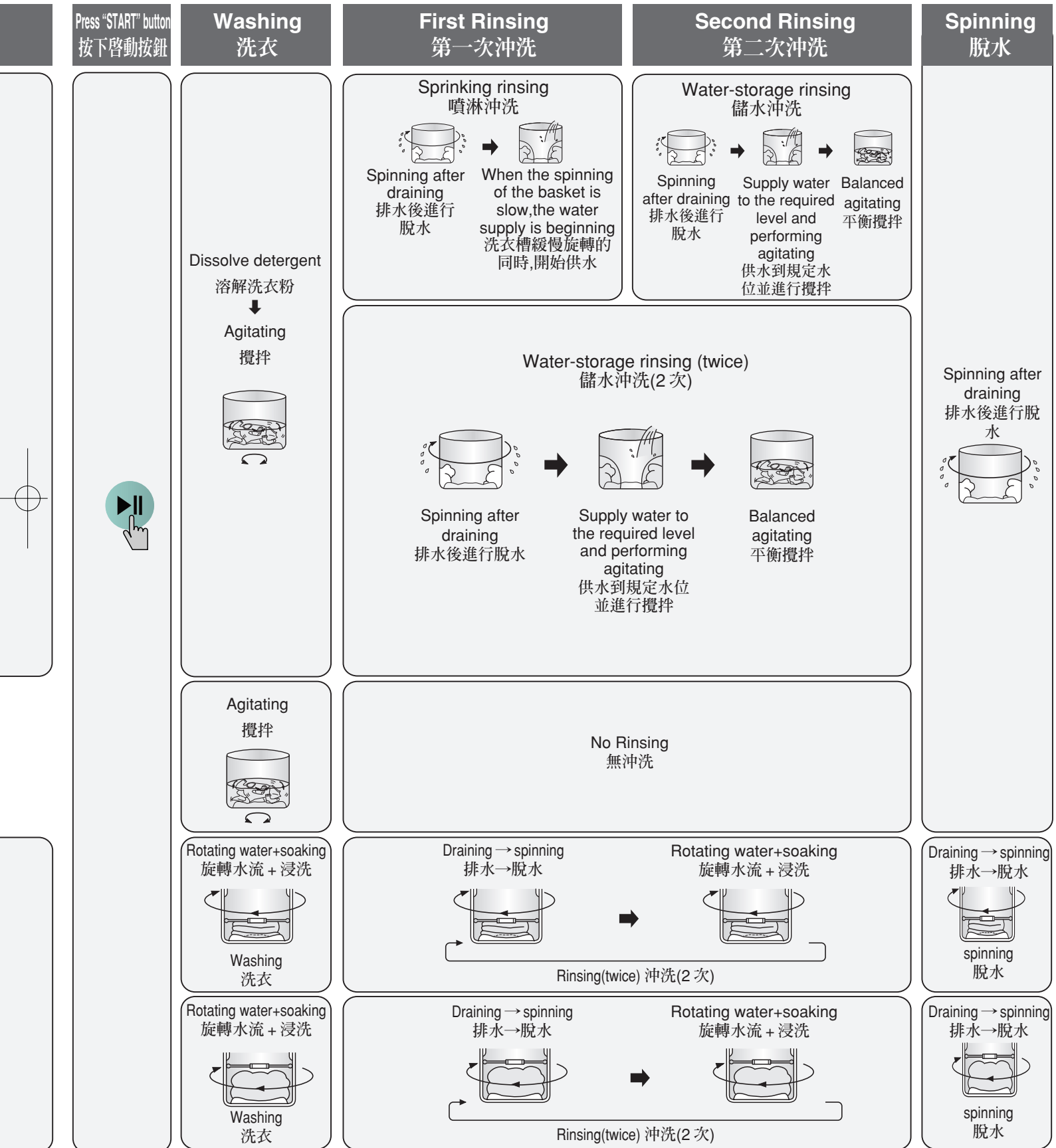



Content of the washing process

洗衣程序的內容

■ This part describes the process of each process.

本部分對各洗衣程序的過程進行說明。

■ () indicates it may be manually switched within the range contained in the bracket by pressing the buttons. No () means no switch.

()中表示用各按鈕可切換的範圍。無()表示不能進行切換。



Process 程序	Automatic setup of water level 自動設定的水位	Washing 洗衣	Rinsing 沖洗		Spinning 脫水	Required duration (approximate) 所需時間 (大約)
			Round 1 第一次	Round 2 第二次		
NORMAL 標準	50~25L (50~25L)	15 min (15~3 min)	Sprinkling rinsing 噴淋沖洗	Water-storage rinsing 儲水沖洗	6~3 min (9~1 min)	48 min (63~28 min)
			(Water-storage rinsing 1~3 times) (儲水沖洗1~3次) (*AJ-S55KXX Water-storage or Water-injection rinsing 1~3 times) (儲水或注水沖洗1~3次)			
DELICATE 絲柔	40L (50~25L)	9 min (15~3 min)	Water-storage rinsing 儲水沖洗	Water-storage rinsing 儲水沖洗	3 min (9~1 min)	36 min (63~22 min)
			(Water-storage rinsing 1~3 times) (儲水沖洗1~3次) (*AJ-S55KXX Water-storage or Water-injection rinsing 1~3 times) (儲水或注水沖洗1~3次)			
BLANKET 被毯	50L (50~25L)	25 min	Water-storage rinsing 儲水沖洗	Water-storage rinsing 儲水沖洗	6 min (9~1 min)	65 min (65~56 min)
WOOL 毛絨	30L (30~25L)	9 min	Water-storage rinsing 儲水沖洗	Water-storage rinsing 儲水沖洗	1 min	36 min
SPEEDY 快速	25L (30~25L)	3 min (15~3 min)	no rinsing 無沖洗		3 min (9~1 min)	12 min (45~20 min)
			(Water-storage rinsing 1~3 times) (儲水沖洗1~3次) (*AJ-S55KXX Water-storage or Water-injection rinsing 1~3 times) (儲水或注水沖洗1~3次)			
SOAK 浸洗	50~25L (50~25L)	60 min	Water-storage rinsing 儲水沖洗	Water-storage rinsing 儲水沖洗	6 min (9~1 min)	100 min (122~85 min)
			(Water-storage rinsing 1~3 times) (儲水沖洗1~3次) (*AJ-S55KXX Water-storage or Water-injection rinsing 1~3 times) (儲水或注水沖洗1~3次)			
MINI 輕量	30L (50~25L)	9 min (15~3 min)	Sprinkling rinsing 噴淋沖洗	Water-storage rinsing 儲水沖洗	6 min (9~1 min)	37 min (42~31 min)
			(Water-storage rinsing 1~3 times) (儲水沖洗1~3次) (*AJ-S55KXX Water-storage or Water-injection rinsing 1~3 times) (儲水或注水沖洗1~3次)			
HEAVY 強力	50~25L (50~25L)	18 min (18~3 min)	Water-storage rinsing 儲水沖洗	Water-storage rinsing 儲水沖洗	6 min (9~1 min)	52 min (67~31 min)
			(Water-storage rinsing 1~3 times) (儲水沖洗1~3次) (*AJ-S55KXX Water-storage or Water-injection rinsing 1~3 times) (儲水或注水沖洗1~3次)			

※ The above table is based on AJ-S55KXP.
上表以AJ-S55KXP為基準

■ Time required for washing

洗衣所需時間

- The washing time includes the time of charging (volume of 15L per minute) and draining (standard condition).
洗衣時間包括供水時間(供水量每分鐘15L)和排水時間(標準狀態)。
- The washing time depends on the water pressure, washing quantity and drainage condition etc.
所需時間隨水壓、洗衣量和排水條件等因素變化而變化。
- In the "NORMAL", "SOAK" and "HEAVY" processes, the washing machine determine the optimum washing mode by checking the load and texture of the washings. The time shown in the above table are ones in standard condition. (marked with ■).
在「標準」、「浸洗」、「強力」程序中，洗衣機通過檢測洗滌量和洗滌物的質地，決定最佳洗衣方式。上表所示時間為標準狀態(用■表示)下的時間。
- There are certain errors between the "washing time" & "spinning time" and the actual operation time.
“洗衣時間”、“脫水時間”於實際運轉時間存在一定誤差。
- Some processes, the washing machine will stir the clothes for after final spinning for fluey effect. (stirring may not be made for some washing loads.)

有些程序在最終脫水結束後，會進行攪拌以理順衣物，達到疏松效果。(有的洗衣量不能進行此攪拌)

■ Change of the options in the modes

關於更改程序內容

- () indicates it may be manually switched within the range contained in the bracket by pressing the buttons.
()中表示用各按鈕可手動切換的範圍。
- Options in modes can't be changed after the completion of the "washing" process.
不能在“洗衣”過程結束後更改程序內容。
- Changes can't be made during the period from the beginning of charging to the time when the level of charged water reach the stated standard.
從供水開始到水位達到規定水位的過程中，也不能進行更改。

■ Switch of modes

關於切換程序

- Modes can't be switched after the starting of washing machine. If it is necessary to switch, please cut off the power supply first, and then proceed with the switch.
不能在啟動後切換程序。如需更改，請切斷電源後再進行程序切換。



Process Description

各程序的說明

DELICATE Process 絲柔程序

Not suitable for washing laundries below:

不宜洗滌下列衣物：

Laundries with Dry clean label and out of hand wash label.

僅有 標志而無 標志的衣物。

Laundries with fur material except for sweaters of wool, (high-quality cashmere, Angora, mohair and alike)

羊毛以外的獸毛材料的衣物。(高級羊絨、安哥拉兔毛、馬海毛等)

Laundries with lace embroidery knitted by special method.

蕾絲繡花等特殊編織方法制成的衣物。

If laundry is only lightly stained, use only half of the amount of detergent (50%~60%).

污漬較輕的情況下，洗滌劑的使用量為通常的一半（5-6成）即可。

In case of laundries too wrinkle or heavy dry by spinning, please set shorter spinning time by pressing "SPIN" button.

擔心衣物因脫水出現皺褶或被過度絞干時，請按『脫水』 按鈕設定較短的脫水時間。

After washing

洗滌結束後

Prevent the knitted sweater and alike from distorting please pay attention when drying.

羊毛衫等毛織品衣物，為防止其變形，晾曬時應特別注意。

- Woolen sweater can be flattened out on a lever board for drying and sunning to prevent distorting. 可將羊毛衫攤平在平整的木板上晾曬，以防止其變形。



SPEEDY Process 快速程序

※ This program is designed for washing clothes only with sweat but no dirt in summer.

本程序是為洗滌夏季含有汗水但無污漬的衣物而設計的專用程序。

※ This program will not rinse in full automatic mode, so no detergent, fabric softener,

bleach are required. If it is necessary to use them, be sure to make manual setting or select other program. 在全自動運行時，本程序將不進行沖洗，因此請勿加入洗滌劑、柔軟劑、漂白劑。如果確實有必要使用時，請進行手動設定，或選擇其他程序。

WOOL Process 毛絨

Before using your machine 開始洗衣前

Please note that the washing cap can be used in "WOOL" process

用『毛絨』程序洗滌衣物時，請使用洗衣蓋

- Washing without the cap may cause the laundry damage and the washing machine failure.

不用洗衣蓋進行洗衣時，可能會造成衣物損傷及洗衣機損壞。

How to install and uninstall the washing cap 33

洗衣蓋的安裝和拆卸方法 33

※ The washing cap is the optional part

洗衣蓋是另售部件

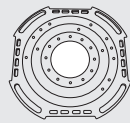

The "WOOL" process applies the mode of basket rotation, which uses the rotating water in the basket to wash the fine cloth with label and the laundry with label gently.

『毛絨』程序採用洗衣槽旋轉的方式，利用槽內的旋轉水流，對有 標志的精細衣物和有 標志的衣物進行柔和的洗滌。

- Some laundries can't be washed due to the cloth materials. 也有因布料原因而不能進行洗滌的衣物。

Because this process imitates the dry cleaning that handles the laundry without external force, please remove the oil contamination, the dirt and the color spot off the laundry.

由於本程序模仿乾洗，不使用外力對衣物進行洗滌，因此請事先除掉衣物上的油污、泥垢及色斑等。

Laundries within or out of the washing range 能洗滌和不能洗滌的衣物

Laundries within the washing range 能洗滌的衣物

Among the signs of clothes' washing methods
衣物的洗衣標志中

With Hand wash label
有 標志的
With Dry clean label
有 標志的

- The sweater, the knitted sweater (high-quality cashmere, mohair and alike)
毛衣、羊毛衫（高級羊絨、馬海毛等）
- The trousers, the skirts
西褲、裙子
- The overall, the shirt, the one-piece dress (silk, flax and alike)
罩衫、襯衫、連衣裙（絲綢、麻等）
- The school uniform, the sailor uniform
學生服、海員服

※ Even the laundry with label may be out of the washing range. Please refer to "Laundries out of the washing range" at the right side. 即使有 標志的衣物也可能不能洗滌。請參照右邊的“不能洗滌的衣物”。

Laundries out of the washing range 不能洗滌的衣物

- The leather craft or the leather decoration
皮革製品和皮革裝飾品
- The laundries with decoration (feather, fur and alike)
帶裝飾品（羽毛、皮毛等）的衣物
- The rayon, the amino-copper fiber and their mixture
人造絲、銅氨纖維及其混紡物
- The laundries inclined to decolor
易脫色衣物
- The necktie, the suit and the overcoat
領帶、西裝和大衣
- The laundries handled with the coating process, the resin process (with bond), the grain-rolling process (with the raised or sunken patterns)
進行了塗層加工、樹脂加工（使用黏合劑）、軋紋加工（有凹凸花紋）的衣物
- The laundries applied with the forcefully-contorted fiber (forcefully-twisted wire) such as silk and wool (especially the jacquard and alike)
採用絲綢、羊毛等強力扭曲纖維的衣物（尤其是提花等）
- The silk, the corduroy and the alike wools
天鵝絨、燈芯絨等毛料
- The laundries with no washing label
沒有洗衣標籤的衣物

Attention 注意

If the laundry is not included in the above list, please wash it with reference to the detergent specification. 以上並未提及的衣物，請參照洗衣粉說明書進行洗滌。



Process Description (continued) 各程序的說明（續）

Preparation for the washing 洗衣的準備

Preparation for the laundry 衣物的準備

- Remove the color spot or the dark dirt before washing.
衣物上有色斑或嚴重污垢時，請事先將其清除掉。
- Please fasten the fasteners or the zip of laundry completely.
請將衣物鈕扣扣上並將拉鏈完全拉上。
- As to the laundries with fastener or broider, turn its inner side to external before washing.
帶鈕扣或有刺繡的衣物，請先翻至內面再進行洗滌。

Make sure the decoloring possibility 確認有否脫色

- Please make sure the decoloring possibility of the laundry. Dip the white towel with the detergent, use it to wipe the inconspicuous part of the laundry, and observe whether the towel is attached with color. Don't wash the laundry that decolors.
請事先確認可能脫色的衣物是否會脫色。用白色毛巾沾上洗衣液，在衣物不顯眼處用力擦拭，觀察毛巾是否染上顏色。不能對脫色的衣物進行洗滌。
- Pay particular attention to the laundries that are inclined to decolor, such as the scarf.
圍巾等容易脫色的衣物，應特別注意。

Make the dirt or the color spot easy to remove 使污垢或色斑等易於清除

The oil contamination around the collar or the wristband 領子或袖口處的油垢

- As to the dirt around the fringe of collar, wristband, lap or pocket, use the brush with detergent to wipe these positions hard for dirt removal.
對於領子、袖口、下擺或口袋邊緣等處污垢，可用沾上洗衣液的刷子在上述位置用力擦拭來清除。





The color spot 色斑

- Underlay the towel at the inner side of laundry, and use the brush with detergent to flap gently and remove the color spot.
可在衣物內面墊上毛巾，用沾上洗衣液的刷子在色斑處輕輕拍打，使色斑脫落。



Use of detergent 洗衣劑的使用

■ Use of detergent 洗衣劑的使用

- Please use special detergent (liquid) to wash clothes with Dry clean label.
洗衣標誌中有  標誌的衣物，請用乾洗衣物專用洗衣劑(液體)進行洗滌。
- Please use neutral liquid detergent (liquid) to wash clothes with Hand washing label.
有  標誌的衣物，也可用中性洗衣劑(液體)進行洗滌。

- Please refer to the detergent specification for the usage amount of detergent.
洗衣劑使用量請參照洗衣劑說明書。
- Do not use other detergent except liquid detergent.
除液體洗衣劑外，請勿使用其他洗衣劑。

■ Do not use Bleach. 請勿使用漂白劑

- The bleacher is of strong alkalinity and will do harm to the clothes.
漂白劑具有強烈鹼性，會損傷布料。

As to the laundry that highly shrinks after washing, the paper model shall be prepared in advance in order to get the laundry back to the original size.

對洗滌後縮水嚴重的衣物，事先應準備好其紙樣，以便將衣物重新恢復到原有尺寸。

After washing 洗衣結束後

■ Drying methods

晾乾方法

- Sweaters of wool, Angora and cashmere shall be laid in shady and cool place after dressing to be dried in shade.
羊毛、安哥拉羊毛和山羊絨等毛衣應在整形後，放置於陰涼處風乾。
- Woolen sweater can be flattened out on a level board for drying and sunning to prevent distortion.
可將羊毛衫攤平在平坦的木板上晾曬，以防止變形。
- Blouse or one-piece dress shall be dressed and hung in hanger for drying in shade.
罩衫或連衣裙應整形，掛置於衣架上風乾。

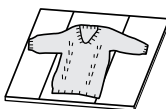

■ Treatment (recovery of the shrinkage and distortion)

處理方法(縮水或變形的恢復方法)

- Hover the steam flatiron over the clothes, release steam and dress the clothes.
將蒸汽熨斗輕懸於衣物上，使之噴出蒸汽並整理衣物形狀。
- After spraying sufficient steam, flatten out and dress the clothes.
充分噴過蒸汽後，按紙樣平鋪衣物並整理其形狀。

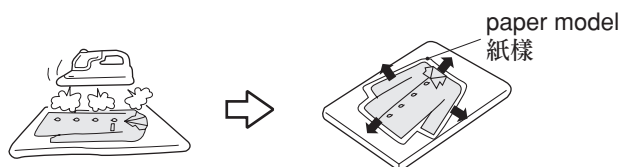

- **Pre-defined operation is not available in the "WOOL" process.**

“毛絨”程序不能進行預校運轉。

- **Use appropriate quantity of detergent.**

使用適量的洗衣劑。

Excessive consumption of detergent will lead to insufficient rinse and may do harm to the clothes.
使用過量洗衣劑會導致沖洗不充分，並有可能損傷衣物。

BLANKET Process

被毯程序

Before using your machine 開始洗滌前

- **The basket rotates and creates "Blanket washing current" and "Soak" process to gently wash comforters, blanket and bed spread.**

洗衣槽旋轉產生洗被毯水流，使被褥等物不會遭受過大的力，從而對床單、被褥、毛毯進行柔和洗滌。

- **Please note that washing cap can be used in BLANKET process.**

『被毯』程序洗衣時，請使用洗衣蓋。

- Washing without the cap may do harm to the clothes and the washing machine.
不用洗衣蓋，可能會造成衣物損傷及洗衣機損壞。

For installation and dismantlement of the washing cap, please see page 33.

洗衣蓋的安裝和拆卸方法 33

The washing cap is the optional part.

洗衣蓋為另售部品

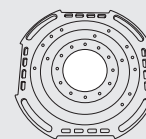

■ Washable Comforter

能洗滌的被子

- Comforters filled with synthetic (polyester) fibre.
Quilt (single, less than width 150cm X length 210cm, the weight of the batting in the quilt less than 1.8kg)
Body-contact light quilt (dual, less than width 190cm X length 210cm, the weight of the batting in the quilt less than 1.8kg)
內部棉絮材質為化學纖維(聚酯纖維)的被子
被子(單人寬 150cm x 長 210cm 以下，內部棉絮重量不超過 1.8kg)
貼身輕被(雙人寬 190cm x 長 210cm 以下，內部棉絮重量不超過 1.8kg)
- Quilt with the interior batting being feather, and with a sign of 、.
(For example: The batt inside the close fitting comforter is 0.5kg)
內部棉絮材質為羽毛，有 、 標誌的被子
(例：貼身輕被內部棉絮重量為 0.5kg)

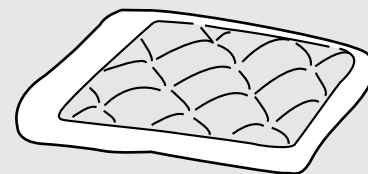





Process Description (continued) 各程序的說明 (續)

Attention 注意

- Don't wash the comforter with the wool as its batt material inside or the silk as its cover material.
請勿洗滌內部棉絮材質為羊毛或被套材質為絲綢的被子。

Washable Blanket

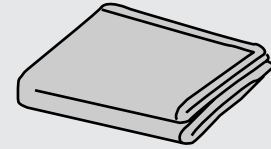

能洗滌的毛毯

- Blankets with  label
有  標誌的毛毯
- Acryl or Polyester fiber double breadth elastic blanket, looped pile carpet and woven carpet (less than 180cm(W) x 230cm(L) and single weight not over than 4.2kg)
丙烯酸類或聚酯纖維的雙幅尺寸彈力毛毯、毛圈毛毯、編織毛毯(寬 180cm x 長 230cm 以下，單件重量不超過 4.2kg)
- Please refer to operation manual of electric blanket for the washing of electric carpet
電熱毯的洗滌請參照電熱毯使用說明書進行。



Other Washable Items

其他能洗滌的物品

- Mattress with  label
有  標誌的床墊
- Pillow cases and cushions filled with synthetic (polyester) fibre
有  標誌的枕頭、坐墊(內部棉絮材質為化學纖維(聚酯纖維))



How to put in comforter and blanket

被子和毛毯的放入方法

- 1 Put in the corner first, then the rest of the comforter slowly.
從被角開始，將被子逐漸放入洗衣槽內。



- 2 To squeeze air out from the inside of the comforter put it in slowly.
將被子內部棉絮中的空氣擠出，然後逐漸將其放入洗衣槽內。



After the end of washing 洗衣結束後

Method to take out 取出方法

- Opposite to the put-in sequence, pull out the comforter slowly.
與放入時相反，應緩慢將被子拉出。

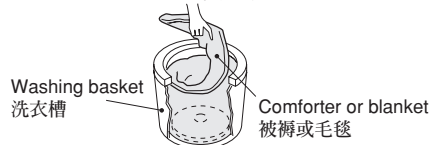

- The preset operation is not applicable to the "BLANKET" process.
『被毯』程序不能進行預校運轉。
- Scrub away tough stains by liquid detergent prior to washing.
被子邊緣等處有嚴重污垢時，請事先用液體洗衣劑將其清除掉。

Natural Air jet at the place with good ventilation 在良好通風處讓其自然風乾

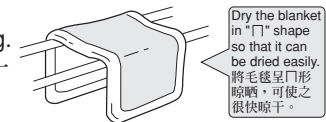

- (About 4 hours are needed to dry the comforter in sunny days)
(在晴天曬被子約需 4 小時)
- When drying the comforter in sun, the frequent turning-over will shorten the drying duration. When drying the comforter in sun, the frequent flap will make the comforter fluffy and comfortable.
晾曬被褥時，若能經常將其翻身會乾得更快。晾曬時，若能經常拍打被褥，會使棉被蓬鬆舒適。
- Neaten up the oblique batting in the quilt, make the quilt more dry, fluey and comfortable. (in order to prevent deterioration of batting and damage of quilt, please cover the coverlet to protect the quilt)
整理羽絨被中偏斜了的棉絮，可使棉被乾燥並蓬鬆舒適。(為防止羽絨變質或被褥受損，請蓋上被單以保護被子)
- When the blanket is still wet, use the brush to tease the hair towards one direction, so as to keep the blanket in good looking.
趁毛毯潮濕時，使用刷子將毛朝同一方向梳理整齊，使之保持美觀。



AIR JET 風干

※ This program is designed for washing clothes only with sweat but no dirt in summer.
本程序是爲了縮短衣物晾干時間而設計的專用程序。

※ ■ Clothes not suitable for this mode.
不適宜此程序的衣物

- Clothes that cannot be washed WOOL processes.
不能在毛絨程序中洗滌的衣物。
- Clothes of easily-fade away colors
易脫色衣物
- Quilt and blanket
被子、毛毯
- Clothes with  sign in washing mark
洗衣標籤中有  標誌的衣物
- Shoes
鞋子
- Easily distorted clothes
容易變形的衣物

Using the PRESET for Washing 預校時間洗衣

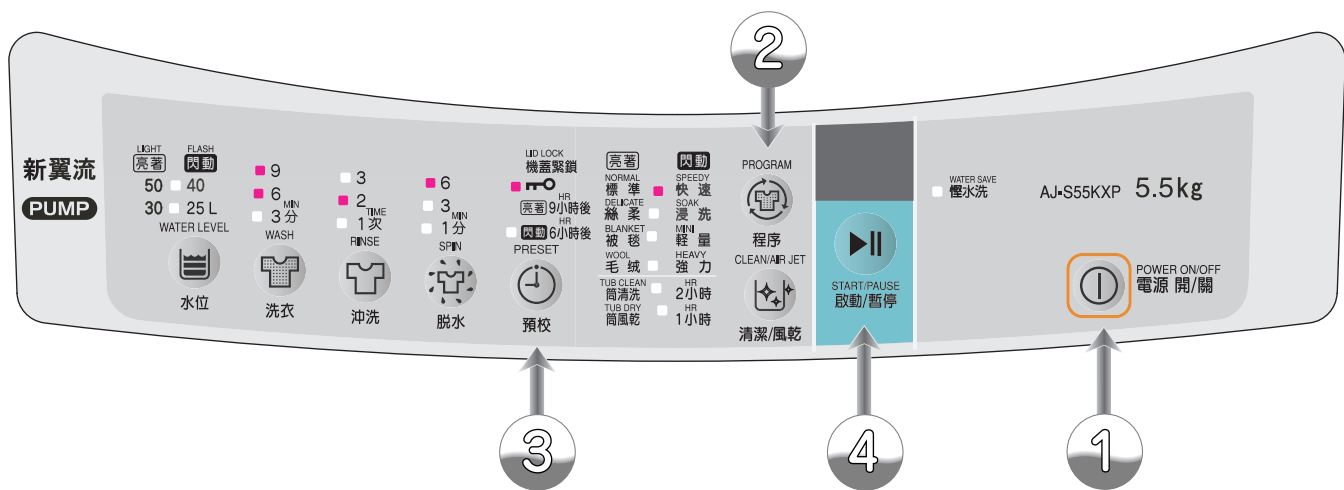

1 Put the laundry in and press the "POWER ON/OFF" button .

放入衣物，按下『電源開/關』按鈕 .

2 Press the "PROGRAM" button , select the washing mode.

按下『程序』按鈕 , 選擇洗衣方式。

- With each pressing on the "PROGRAM" button, the indicator will light in sequence.

每按動一次『程序』按鈕，各指示燈會順次點亮。

3 Press the "PRESET" button , set the pre-defined time.

按下『預校』按鈕 , 設定預定時間。

- Set the time it will take to finish washing from now.
設定從現在開始多長時間後結束洗衣。

- Predefined time can be switched by pressing the "PRESET" button.

按下『預校』按鈕，可切換預定時間。

4 Press "START/PAUSE" button .

按下『啟動/暫停』按鈕 .

★ Put in the detergent according to the amount and close the lid.

(The sound of buzzer indicates washing completion.)

根據顯示的水位，
放入洗衣粉，關閉機蓋。

(蜂鳴聲響起表示洗衣完畢。)

- The pulsator to detect the amount of laundry and display on the control panel.  20

攪拌翼旋轉檢測出洗衣量並由控制面板顯示出來。  20

- For use and charging methods of the detergent, please see the detailed description of the selected mode.
關於洗衣粉的使用方法和洗衣粉的注入方法請參照所選程序的詳細說明。

- Do not use liquid detergent during preset washing.
預校洗衣時，請勿使用液體洗衣劑。



Using the PRESET for Washing (continued) 預校時間洗衣 (續)

※ Predefined operation can't be set in "DELICATE", "WOOL", "BLANKET", "TUB CLEAN", "CLEAN/AIR JET" Processes.
『絲柔』、『毛絨』、『被毯』、『筒清洗』、『清潔/風乾』程序不能設定預校運轉。

How to use the "PRESET" button (Switched options) 『預校』按鈕的使用方法 (切換內容)

- The preset function allows the finishing time to be set to 6 hours or 9 hours later. This feature comes in handy when you wish to do the washing while you are out or when you wish to do the washing at night and hang out in the morning.
可將洗衣完成時間設定在6小時後或9小時後，在外出時進行洗衣，或在夜間洗衣早晨晾曬，利用本功能是相當便利的。
- Press the "PRESET" button to set the washing content.
按下『預校』按鈕，設定洗衣內容。

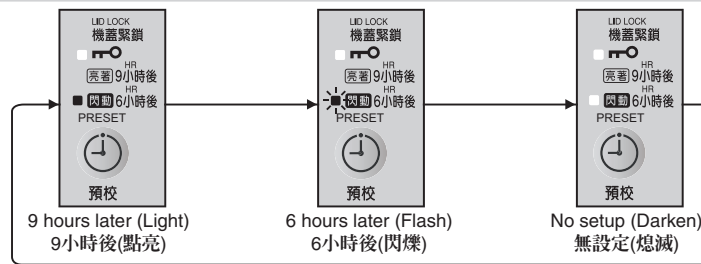

In the following cases 在以下情況下

- **Fix the preset duration: press the "PRESET" button** (🕒).
(With the button pressing and holding, the preset duration will be displayed)
確認預校內容：按下『預校』按鈕 (🕒)。
(持續按下期間，顯示預校內容)
- **Cancel the preset duration: switch off the "POWER ON/OFF" button** (🔌).
取消預校內容：切斷『電源開/關』 (🔌)。
- **Change the preset duration: switch off the "POWER ON/OFF" button (🔌), and reset.**
更改預校內容：切斷『電源開/關』 (🔌) 後，重新設定。

Attention 注意

- In predefined operation, do not mix the clothes liable to discoloration.
預校運轉時，請勿將容易脫色的衣物混在一起洗滌。
- With the power unplugged or cut, the preset process will be canceled.
拔掉電源插頭或停電時，預校程序將被取消。
- The washing time varies with the change of the load and texture of the washings and the volume of the charged water.
洗衣時間隨洗衣量和質地及供水量的變化而改變。
- To prevent the laundry from corrugating, take it out for drying as early as possible after the end of washing.
為防止衣物起皺，洗衣結束後應盡早取出晾乾。
- Please make sure the inhaling window is closed before operation. If the washing machine operates with the inhaling window open, the water may splash.
請務必關閉吸氣窗才進行運轉。洗衣機在吸氣窗開啟的狀態下運轉，水滴可能會飛濺出來。

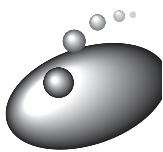

Using the Detergent Again 再次使用洗衣液

Use the detergent again 再次使用洗衣液

1



"Washing" only for the 1st collective of laundries.
對第一批衣物進行“單洗”。

2

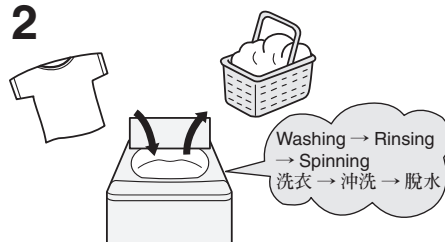

Put in the 2nd collective of laundries, and select the favorite washing mode.

- 放入第二批衣物，選擇喜歡的洗衣方式進行洗衣。
- Set the proper water level for the laundries.
設定適合衣物的水位。

3



Rinse and spin the 1st collective of washed laundries.

- 對第一批已經洗過的衣物進行沖洗和脫水。
- Set the proper water level for the laundries.
設定適合衣物的水位。



Using the Washing Cap 使用洗衣蓋

Make sure the washing cap is used in "WOOL" or "BLANKET" process. The washing cap is the optional part.
進行『毛絨』或『被毯』程序時，請使用洗衣蓋。洗衣蓋為另行銷售的部品。

Installation of the washing cap

洗衣蓋的安裝方法

- 1** Bend the cap as is shown in the figure and then put it in the washing basket with the side with letter faced up.
洗衣蓋內有文字一面朝上，如圖所示將其彎曲並先放入洗衣槽內側。

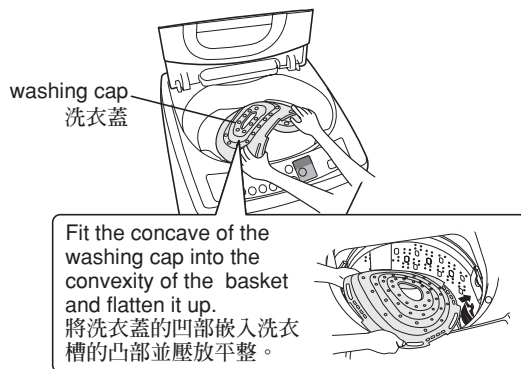

- 2** ① Press the washing cap on your side, squeeze the whole cap into the basket.
壓下身旁的洗衣蓋，將洗衣蓋整個壓入洗衣槽內。
② Press hard the whole washing cap down and flatten it up.
用力將洗衣蓋整個向下壓，擺放平整。

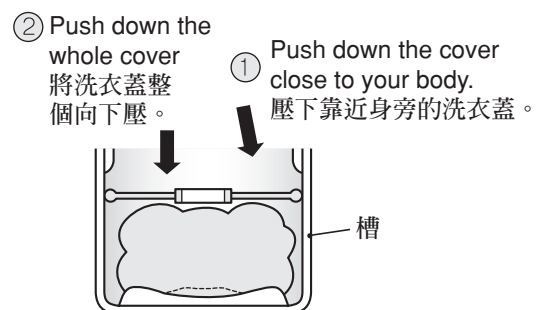

Attention 注意

- Please install the washing cap in right way to avoid unnecessary injury.
請正確安裝洗衣蓋，避免造成不必要的傷害。

Adjustment of the position and height of the washing cap

調整洗衣蓋的位置高度

In "WOOL" process 『毛絨』程序時

- The installation position (height) of the washing cap shall be determined by the type, size, and thickness of the washings. Please install the washing cap at a height where it could press against the washings slightly.
洗衣蓋的安裝位置(高度)應根據衣物的種類、大小、厚度而定，請將洗衣蓋安裝在可輕壓住衣物的高度。
- There is a sign of protrusion on the interior wall of the basket, indicating where the installation position shall be, which can be used as reference at the time of installation.
洗衣槽內壁上有表示安裝位置的突起標誌，安裝時可供參考。
- For light and thin clothes such as blouse, towels can be put into the basket to adjust the height of the washings and avoid oblique of the washing.
洗滌罩衫等輕薄衣物時，可在洗衣槽內放入毛巾等物，以調節衣物高度，避免脫水時衣物偏斜。

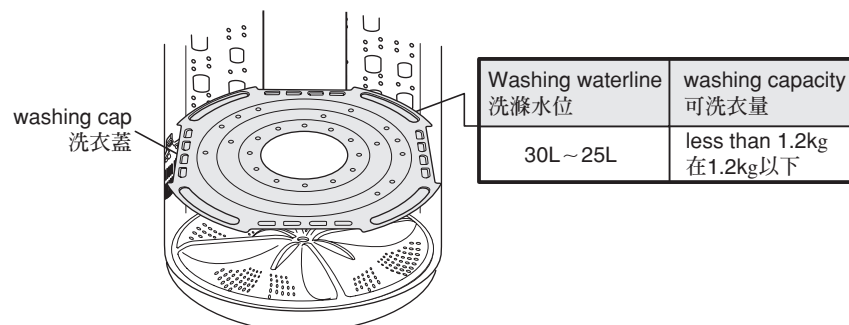

Attention 注意

- Do not add any clothes on the washing cap after the installation of the cover.
洗衣蓋安裝完畢後，請不要在洗衣蓋上面加入衣物。



Using the Washing Cap (continued) 使用洗衣蓋 (續)

In "BLANKET" process 『被毯』程序時

1 Dismantlement of the detergent dispenser. 洗衣粉加入盤的拆卸方法。

- ① Bend the dispenser.
彎折加入盤。
- ② Dismantle the pin from the pinhole.
將銷釘從銷孔中卸下來。

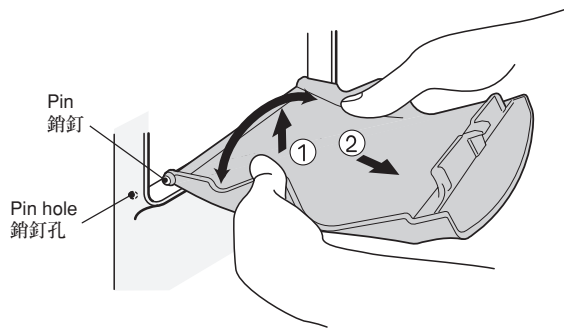

2 Put the washing cap into the basket, hold the central circle, and pull it right beneath the balance ring. 把洗衣蓋放入洗衣槽內，握住中圈將其拉到平衡環正下方。

- Do not clip the clothes when installing the washing cap.**
安裝洗衣蓋時，請勿夾住衣物。

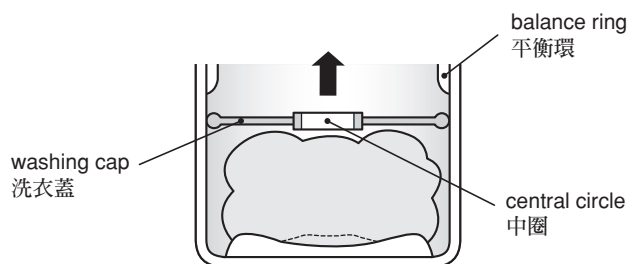
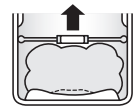

Attention 注意

- Do not add any clothes on the washing cap after the installation of the cap.
洗衣蓋安裝完畢後，請不要在洗衣蓋上再加入衣物。

! Attention 注意



Prohibited
禁止

It is prohibited to install the washing cap aslant. In addition, the washing cap is prohibited from being used in other modes except the "BLANKET" and "WOOL" process.
嚴禁傾斜安裝洗衣蓋。另外，除『被毯』、『毛絨』程序外，嚴禁在其他程序中使用洗衣蓋。

- Least the splashed water drop or the washing cap bounced out will cause body injury or damage of the washing machine.
以免水滴飛濺或洗衣蓋飛出造成人身傷害或洗衣機損壞。

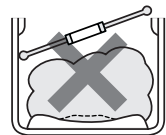

- When keeping the washing cap, please prevent it from deforming.
保管洗衣蓋時，請注意防止其變形。
- The washing cap is a consumable good. Purchases can be made at authorized dealers.
Refer page 52 for the optional components.
洗衣蓋屬於消耗品，若有損壞請到指定的商鋪購買。
另售部品 52

Taking out the washing cap 洗衣蓋的取出方法

1 Push the washing cap down. 將洗衣蓋向下壓。

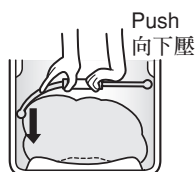

2 As shown in the figure hold on to the center part and bend it to the arrow direction. 如圖抓住中圈，將洗衣蓋向箭咀方向彎曲。

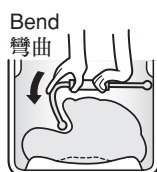

3 Pull the washing cap out. 然後順勢將洗衣蓋拉起，取出。





AIR JET Process

風乾程序

Preparing for AIR JET

開始風乾前

- **Air Jet function helps to shorten the time for laundry airing by using of strong wind and high-speed spinning . It prevents shrinkage and transfigure that caused by heating.**
風乾功能是利用強風和高速脫水，縮短衣物晾乾時間，可免除傳統熱烘式乾衣引致縮水變形的問題。
 - May be used to dry the heat-irresistible swimsuit or the underwear containing the amino heat-insulation materials.
可對不耐熱的泳衣或含隔熱材料的內衣進行風乾。
 - Keep room free of mugginess for causing no temperature rise.
由於溫度不上升房間不會悶熱。
- **Provide the same drying effect as the airing in the room.**
可以達到和房間內晾乾同等的乾燥效果。
 - Maximal 1.5kg of blending chemical fiber can be dried in 3 hours.
可在3小時內風乾1.5kg化學纖維混紡等衣物。
- **Be able to control the black mildew in the washing basket. (The process of “TUB DRY” that only dries the washing basket may be applied to prevent the mildew.)** 40
可抑制洗衣槽中的黑色霉菌。(可利用僅風乾洗衣槽的『筒風乾』程序來防止霉菌) 40

- **The drying capacity can be as high as 1.5kg. (Blending chemical fiber)**
衣物最大風乾量為1.5kg。(化學纖維混紡)

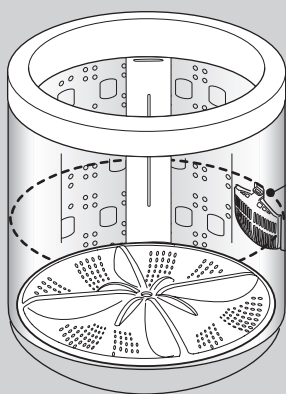

About 1.5kg of laundries
約1.5kg洗衣量
Hair above the filter net
(Well rearrange the post-spinning wet laundries and put them into the washing basket)
棉架過濾網之上(將已脫水濕衣理順後並放入洗衣槽內)

- **Laundries not applicable to air jet dry**
不適宜風乾的衣物

- Laundries not applicable to the washing processes of “WOOL” 27
不能在毛絨程序中洗滌的衣物 27
- Comforter and blanket
被子、毛毯
- Shoes
鞋子
- Laundries inclined to decolor
易脫色衣物
- Laundries with the label for washing
洗衣標籤中有標誌的衣物
- Laundries inclined to be reshaped
容易變形的衣物

Excessive use of detergent may cause insufficient air jet dry or unexpected corrugations.
洗衣量過多時會造成風乾不充分或出現較多皺紋。

Please never handle the waterproof paper or laundries with air jet mode.
請勿風乾具防水性的紙張或衣物。

- **Approximate weight of air jet laundries**
風乾物的大致重量

White shirt (blending, about 200g) 白襯衫 (混紡約200克)	Overall (blending, about 200g) 罩衫 (混紡約200克)	Sweater (chemical fiber, about 500g) 絨布衫 (化學纖維約500克)
Close-fitting trousers (with the amino heat-insulation materials) (chemical fiber, about 200g) 緊身褲(含隔熱材料) (化學纖維約200克)	Washable silk (silk, about 200g) 可洗的絲綢 (絲綢約200克)	sports suit (jacket and trousers) (chemical fiber, about 700g) 運動衫(上下) (化學纖維約700克)
Lady's shirt vest (with the amino heat-insulation materials) (chemical fiber, about 200g) 女用襯衣背心(含隔熱材料) (化學纖維約200克)	Night-suit (jacket and trousers) (blending, about 500g) 睡衣(上下) (混紡約500克)	work clothes (blending, about 800g) 工作服 (混紡約800克)

- The figure in the parentheses means the approximate weight of one piece of clothes. The weight varies according to the type, size and thickness of laundries.
()中的數值表示一件衣物的大致重量。該重量隨衣物種類、大小、厚度等因素的變化而有所不同。



AIR JET Process (continued)

風乾程序 (續)

AIR JET Process

風乾方法

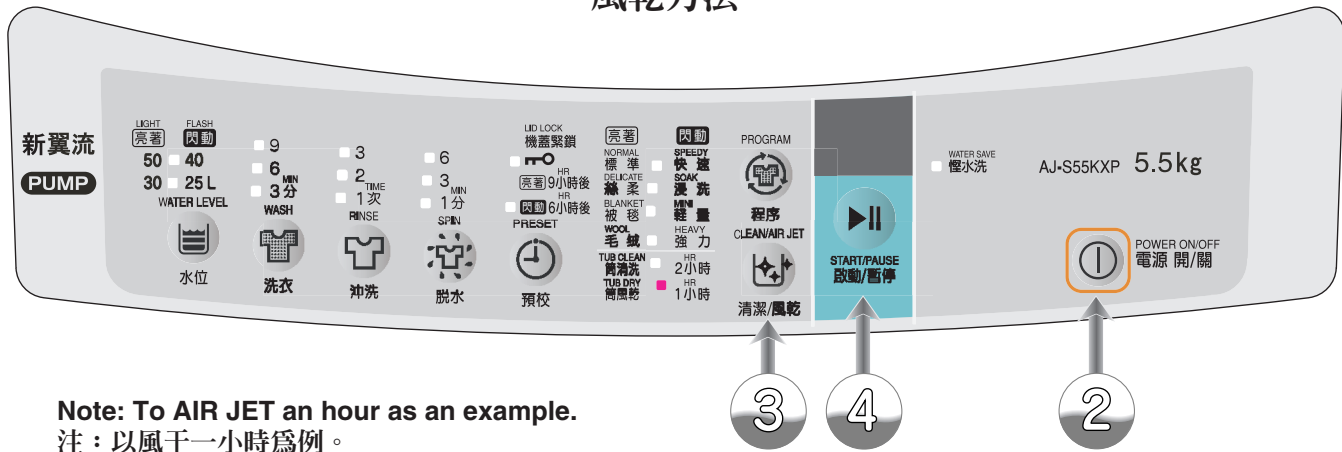

Note: To AIR JET an hour as an example.
注：以風干一小時為例。

1

Take out the laundries after washing process, rearrange them evenly and put them into the washing basket.

洗衣結束後，取出衣物，理順後將其平整放入洗衣槽。

- The air jet capacity can be as high as 1.5kg.
最大風乾量為 1.5kg。

2

Close the lid, open the inhaling window, and press the "POWER ON/OFF" button.

關閉機蓋，打開吸氣窗，按下『電源開/關』按鈕。

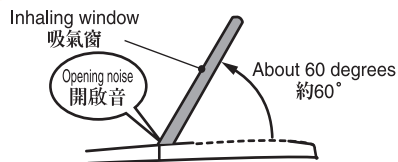

Attention 注意

- Forget to open the inhaling window may cause insufficient air jet.
忘記打開吸氣窗可能導致風乾不充分。

3

Press the "AIR JET" button to set the air jet duration.

按下『風乾』按鈕，設定風乾時間。

■ The duration is irrelevant to the air jet level for applying the preset mode. The amount and type of laundries, the temperature and humidity, the season, or the installation environment may cause insufficient air jet.

Go on with the air jet process in case of insufficient drying.

因採用定時風乾方式，所以風乾結束時間與風乾程度無關。衣物的量和種類、氣溫濕度、季節、安裝環境等因素也可能造成風乾不充分的現象。若出現風乾不充分，請繼續進行風乾。

- Refer to the following table for approximate air jet duration. 大致的風乾時間參照下表。
- The preset during is only for air jet process, and the actual operation duration is 5 to 30 minutes longer for including the duration of rearrangement and even regulation of the laundries. (Depending on the preset duration) 設定時間僅是風乾的時間，實際運轉時間還要加上理順衣物和調整衣物平衡的時間，大概要增加 5 至 30 分鐘。(根據設定時間的變化而改變)。

Operation mode of air-dry process

風乾程序的運轉方式

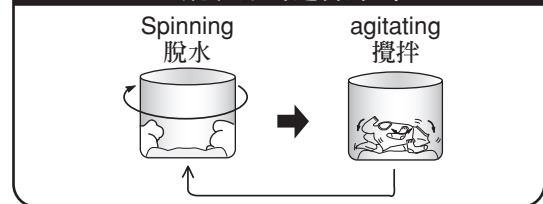

- Please prevent the washing machine from shaking when taking out the laundries. (Water may flow out from the injection opening) 取出衣物時，請勿使洗衣機搖晃。(水可能會從注入口處流出)

4

Press the "START/PAUSE" button (The sound of buzzer indicates washing completion)

按下『啟動/暫停』按鈕 (蜂鳴聲響起表示洗衣完畢)

Attention 注意

- Please well rearrange the laundries before putting them into the washing basket. 請務必將衣物理順後再放入洗衣槽內。 Excessive or poorly-rearranged laundries may cause operation failure. 放入衣物過多或衣物尚未理順時，可能會出現錯誤。

Please pause the operation after the operation failure, reduce the amount of laundry and correct the laundry declination or enwinding, then press the "START/PAUSE" button. If the failure remains after repeating the above procedure 2 or 3 times, please contact an authorized service dealer. 出現錯誤後，請暫停運轉，減少衣物量並消除衣物偏斜和纏繞，然後再次按下『啟動/暫停』按鈕。若反復 2 至 3 次仍出現錯誤，請與認可的維修服務店聯絡。

Proposed Operation Time 建議使用時間表

■ The following information is for reference only. Air Jet is only an supporting feature, helps shorten the time for laundry airing, but it can not dry your laundries completely.

以下資料只供參考，由於風乾功能僅屬輔助性質，幫助縮短晾曬衣物的時間，但不能將衣物完全乾透，衣物仍須晾乾。

Air-dry of individual laundry
單獨風乾一種衣物時

	1.5kg	1.0kg	0.5kg
White shirt polyester fiber: 60% cotton: 40% 白襯衫 聚脂纖維：60% 棉：40%	3 hours 3小時	2 hours 2小時	90 min 90分
Sports suit polyester fiber: 100% 運動衫 聚脂纖維：100%	60 min 60分	60 min 60分	60 min 60分
Night-suit (jacket and trousers) polyester fiber: 85%, cotton: 15% 睡衣(上、下) 聚脂纖維：85% 棉：15%	2 hours 2小時	90 min 90分	90 min 90分
Sweater polyester fiber: 100% 絨布衫 聚脂纖維：100%	90 min 90分	60 min 60分	60 min 60分
Work clothes polyester fiber: 65% cotton: 35% 工作服 聚脂纖維：65% 棉：35%	3 hours 3小時	2 hours 2小時	90 min 90分

Air-dry of mixing laundries (about 1.5kg : 3 hours)
混合風乾幾種衣物時(約1.5kg : 3小時)

Case 1: Mixture of 1.1kg of chemical fiber and 0.4kg of blending
例1：化學纖維1.1kg和混紡0.4kg的組合

	60 min (1 hours)	120 min (2 hours)	180 min (3 hours)
Blending 混紡 400g 400克			
White shirt (2) 白襯衫2件			150 min 150分
Chemical fiber 化纖 200g 200克			
Overall (1) 罩衫1件		70 min 70分	
Sports suit (trousers) 運動衫下		60 min 60分	
Sweater (1) 絨布衫1件			100 min 100分

Case 2: Mixture of 0.5kg of chemical fiber and 1.1kg of blending,
例2：化學纖維0.5kg和混紡1.0kg的組合

	60 min (1 hours)	120 min (2 hours)	180 min (3 hours)
Blending 混紡 600g 600克			
White shirt (3) 白襯衫3件			150 min 150分
Chemical fiber 化纖 400g (half sleeve) 400克 短袖			
Half-sleeve work clothes (jacket) 短袖工作服上			180 min 180分
Chemical fiber 化纖 300g (Jacket of sports suit) 300克 (運動衫上)			
Jacket of sports suit (1) 運動衫上1件	60 min 60分		
Overall (1) 罩衫1件		70 min 70分	

Go on with the air-dry process in case of insufficient drying. 若出現風乾不充分，請繼續進行風乾。

- The laundries with lining should be set with enough air-dry duration.
應對有襯裡的衣物設定較長的風乾時間。
- If the blending product includes a big portion of cotton, reduce the amount of laundry in one round of air-dry process or set longer air-dry duration.
混紡制品中棉的比重較多時，應減少一次風乾中衣物的量或設定較長的風乾時間。
- In the sensitive case of dust or pollen, please close the doors and windows before starting operation.
對灰塵或花粉較為敏感時，請將門窗關閉後再進行運轉。

Shorten Laundry Airing Duration

縮短晾曬時間

The duration to handle the laundry above 1.5kg (below 3.0kg) with 1 hour of air jet is about 40% shorter than that of airing.
對1.5kg以上(3.0kg以下)衣物進行1小時的風乾運轉，可將晾乾時間縮短3~4成左右。

■ The maximal capacity applicable of shortening the laundry airing duration is 3.0kg.
可縮短衣物晾曬時間的最大處理量為3.0kg。

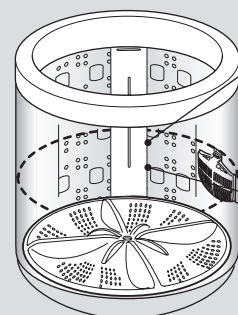

Approximate amount of 3.0kg of dried laundry (The benchmark is the upper end of stainless steel part of washing or spinning basket)
3.0kg已乾燥衣物的大致量
(以洗衣或脫水槽不銹鋼部分的上端為準)

Approximate amount of 3.0kg of wet laundry
3.0kg濕衣物的大致量



Wash in Your Favorite Way

按照您喜歡的方式進行洗衣

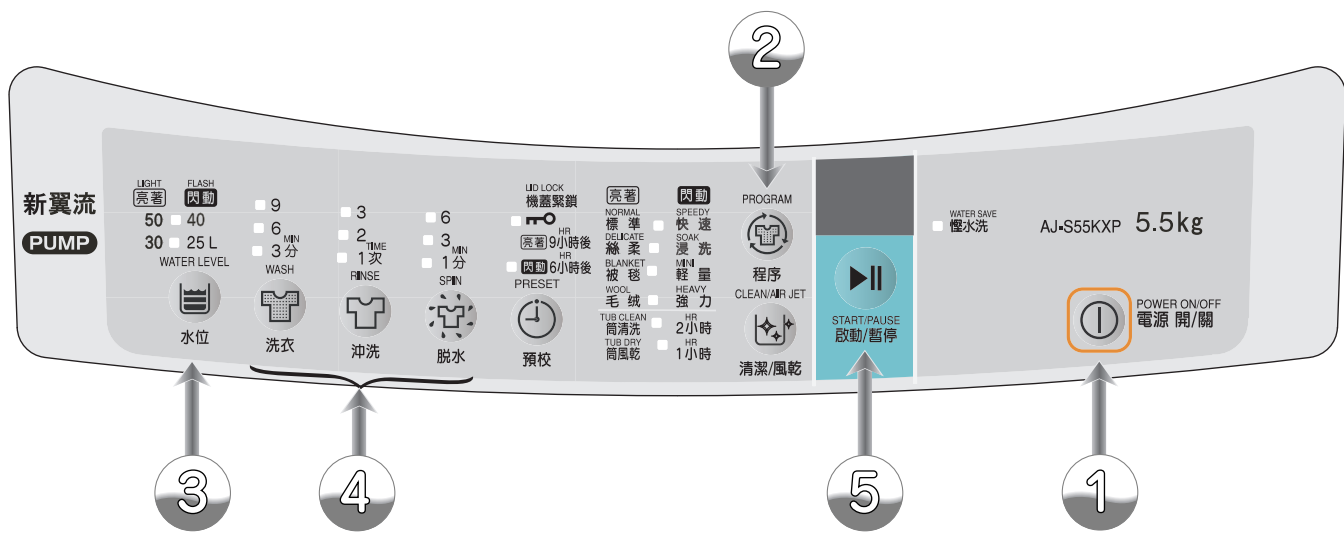









- Any of the processes of "Washing", "Rinsing" and "Spinning" can be set up alone, and the processes can also operate in combination. (The content of the washing will not be stored)
可以單獨設定洗衣、沖洗、脫水任何一個程序，亦可將各個程序組合運轉。(洗衣內容將不會被儲存)

Attention 注意

- Except the "washing → rinsing → spinning" and "washing → spinning", when other washing modes are set, no stirring of the washings will be made for loosening clothes after the completion of drainage.
除“洗衣→沖洗→脫水”及“洗衣→脫水”設定外，設定其他洗衣方式時，最後排水結束後不會為疏鬆衣物而進行理衣攪拌。

In the following cases 在下列情況下

	1	2	3	4	
Wash in the favorite way 按自己喜歡的方式洗衣時 Washing → Rinsing → Spinning 洗衣 → 沖洗 → 脫水	Power 電源  Press the power button 按下電源開關	 Select the "NORMAL" process 選擇『標準』程序	 Select the water level 選擇水位 Automatically set to "50L" in the case of no set to water level. 沒有設定水位時，自動設定為「50L」。	Set washing modes by pressing the buttons 通過各按鈕設定洗衣方式 	
Use the detergent again 再次使用洗衣液時 Washing only 單洗				Select the water level 選擇水位 The sensor will fix the water level automatically in the case of no set to water level. 沒有設定水位時，由傳感器自動決定水位多少。 	
No need to spinning after Rinsing 沖洗結束後無需脫水時 Washing → Rinsing 洗衣 → 沖洗				Select the water level 選擇水位 Automatically set to "50L" in the case of no set to water level. 沒有設定水位時，自動設定為「50L」。	After draining and spinning, it begins to add water for rinsing. 排水和脫水結束後，開始供水準備沖洗。 
To rinse the washed laundry 希望將已洗過的衣物沖洗時 Rinsing only 只沖洗				Select the water level 選擇水位 Automatically set to "50L" in the case of no set to water level. 沒有設定水位時，自動設定為「50L」。	After draining and spinning, it begins to add water for rinsing. 排水和脫水結束後，開始供水準備沖洗。 
To rinse and spin the washed laundry 希望將已洗過的衣物沖洗並脫水時 Rinsing → Spinning 沖洗 → 脫水				Select the water level 選擇水位 Automatically set to "50L" in the case of no set to water level. 沒有設定水位時，自動設定為「50L」。	After draining and spinning, it begins to add water for rinsing. 排水和脫水結束後，開始供水準備沖洗。 
To drain the water out of the washing basket or to spin before drying 希望排出洗衣筒內的水或在晾乾前脫水 Draining only, spinning only 只排水，只脫水					

How to use the "WATER LEVEL" button 水位按鈕的使用

With each pressing on the "WATER LEVEL" button, the indicator will move towards the arrow.
每按一次水位按鈕，指示燈會沿著箭咀方向移動。

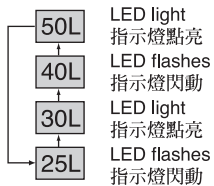

Tips 簡要說明

When adding water during washing or rinsing process, press and hold the WATER LEVEL button for continuous injection of water.
(When the top water level is reached, no more water is able to be charged.)
洗衣或沖洗過程中要加水時按下水位按鈕，持續按住即可加水。
(到達最高水位後，將無法再度加水)
※ Only "25L" and "30L" can be selected in "SPEEDY" and "WOOL" process.
在『快速』、『毛絨』程序中水位只能選擇"25L"、"30L"。
Only "50L" can be set in "TUB CLEAN" process.
在『筒清洗』程序中水位只能設為"50L"。

How to use the "WASH" button 洗衣按鈕的使用

With each pressing on the "WASH" button, the indicator will move towards the arrow.
每按一次洗衣按鈕，指示燈會沿著箭咀方向移動。

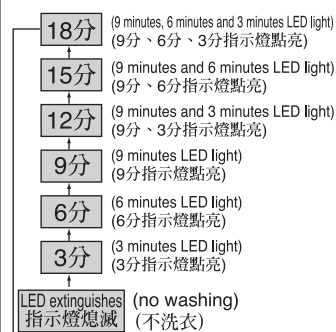

Tips 簡要說明

※ Manual setting can't be made in "SOAK", "WOOL", "BLANKET" and "TUB CLEAN" process.
在『浸洗』、『毛絨』、『被毯』和『筒清洗』程序中不能進行手動設定。
※ Setting 18 minutes only can be made in "HEAVY" program.
僅『強力』可設定為18分。

How to use the "RINSE" button 沖洗按鈕的使用

With each pressing on the "RINSE" button, the indicator will move towards the arrow.
每按一次沖洗按鈕，指示燈會沿著箭咀方向移動。

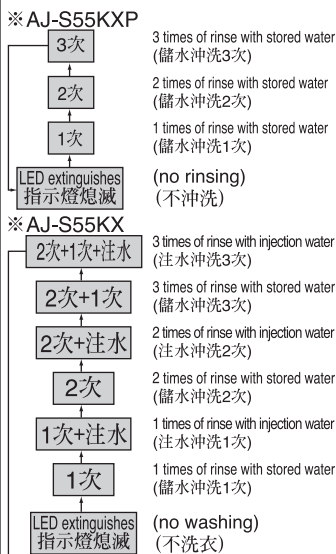

Tips 簡要說明

※ Manual setting can't be made in "WOOL", "BLANKET" and "TUB CLEAN" process.
在『毛絨』、『被毯』和『筒清洗』程序中不能進行手動設定。

How to use the "SPIN" button 脫水按鈕的使用

With each pressing on the "SPIN" button, the indicator will move towards the arrow.
每按一次脫水按鈕，指示燈會沿著箭咀方向移動。

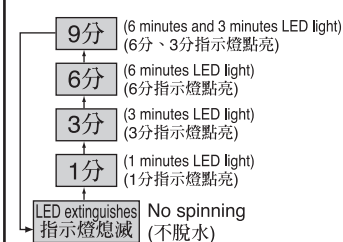

Tips 簡要說明

※ Manual setting can't be made in "WOOL" and "TUB CLEAN" processes.
在『毛絨』和『筒清洗』程序中不能進行手動設定。

5

End
The buzz stands for the end of washing.
結束
蜂鳴聲響起表示洗衣結束

Press the "START/PAUSE" button
按下啟動按鈕

Operation stops if the detergent remains.
仍有洗衣液時停止運轉。

Operation stops if the rinse solution remains.
仍有沖洗液時停止運轉。

Operation stops if the rinse solution remains.
仍有沖洗液時停止運轉。



Maintenance of Washing Basket (TUB DRY • TUB CLEAN) 洗衣槽的保養（筒風乾 • 筒清洗）

TUB DRY Process 筒風乾程序

Frequent air jet to the washing basket may prevent the mildew. (Applied frequency: once a week)

經常風乾洗衣槽可抑制黑色霉菌的產生。(使用頻率：約每周1次)

The process of "TUB DRY" is the same applied as that of "CLEAN/AIR JET" process. (☞ 36)

『筒風乾』程序的使用方法與“清潔/風乾”的方法相同。(☞ 36)

Press the "CLEAN/AIR JET" button , and set the option as "TUB DRY" to start operation. (Operation is as long as about 30 minutes)

按下『清潔/風乾』按鈕 , 設定為『筒風乾』後便可運轉。(運轉時間約30分鐘)

The black mildew can be cleaned with the common oxidized bleacher.

出現黑色霉菌時，可用市面有售的氧化型漂白劑進行清洗處理。

Attention 注意

- Please never put laundry into the washing basket during the course of TUB DRY.
筒風乾時，請勿在洗衣槽內放入衣物。

TUB CLEAN Process 筒清洗程序

It's hard for the soap alkali residue and the mildew to adhere to the stainless steel basket, but the soap alkali residue may come into being after long usage.

Please perform the regular maintenance, and clean the washing basket bimonthly.

雖然肥皂鹼垢和霉菌很難附在不銹鋼槽內，但長時間使用後，有可能形成肥皂鹼垢。

請定期進行保養，大約2個月對洗衣槽進行一次清洗。

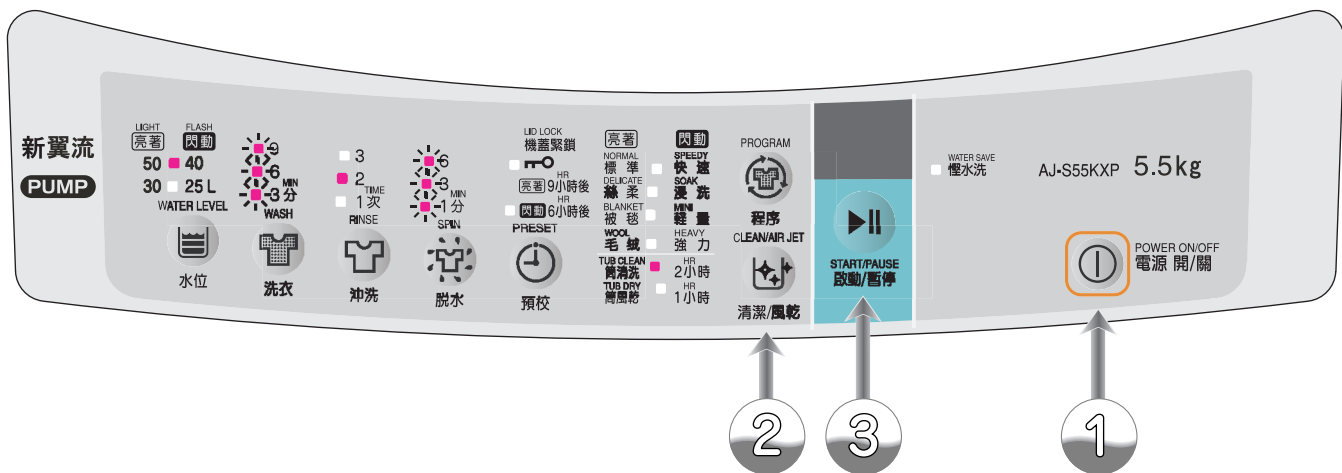

1 Press the "POWER ON/OFF" button 
按下『電源開/關』按鈕 

2 Press the "CLEAN/AIR JET" button , select the "TUB CLEAN" process.
按下『清潔/風乾』按鈕 , 選擇『筒清洗』程序

3 Press the "START/PAUSE" button 
按下『啟動/暫停』按鈕 

- Final spinning is made after washing (stirring, stop) 120 min and water storage rinse 2 times.
經過洗滌（攪拌、停頓）120分鐘和2次儲水沖洗，最後進行脫水。
- The detergent is the oxidizing bleacher sell in the city. Please infuse 250g (about one bottle) bleacher.
清洗劑為市面有售的氧化型漂白劑，請在洗衣槽內倒入250g(約1瓶)漂白劑。

- Please do not use regular detergent, for it will not be able to clean the basket.
請勿使用日常使用的清洗劑，因為不能達到清洗槽的目的。
- Please do not put clothes in the basket.
請勿在洗衣槽內放入衣物。

★ Pour in detergent, close the lid.(The sound of buzzer indicates washing completion)

放入清洗劑後，關閉機蓋。(蜂鳴聲響起表示洗衣完畢)。

TUB CLEAN process is completed
筒清洗程序完畢

※ Final spinning operates for about 20 minutes, can dry the basket and prevent the black mildew from being generated.
最後的脫水約運轉20分鐘，可對槽內進行乾燥，從而抑制黑色霉菌的產生。



Use Guidelines 使用中的注意事項

Do not remove the plug of power supply during the operation.

運轉過程中，請勿拔掉電源插頭。

- Lest the washing machine will be in trouble. Make sure the operation is suspended or the power supply is cut off before removing the plug.
以免引起洗衣機故障。請務必暫停運轉或切斷電源開關後，再拔掉電源插頭。

Do not add excessive amount of detergent.

請勿投入過量洗衣粉。

- Excessive detergent won't improve the washing effect much.
投入過量洗衣粉，洗衣效果並無多大改變。
- Instead, it will cause insufficient rinse and lead to some problems due to excessive foams.
相反會造成沖洗不充分，以及因泡沫過多而引起某些問題。

Don't be close to television or radio.

請勿靠近電視機或收音機

- It may interfere with the television or radio.
可能會對電視機或收音機構成干擾。

The power supply switch is in ineffective condition after the power supply is cut off and before the Mode LED extinguishes .

切斷電源後，程序指示燈尚未熄滅前，電源開關處於無效狀態。

- To switch on the power supply, it is recommended to press the power supply switch again after the LED extinguishes.
想再次接通電源時，應待指示燈熄滅後再按下電源開關。

Attention on dewfall .

結露時應注意。

- Since the humidity is high in summer, there will be dewfall outside the washing machine when washing with cool water, which may damp the floor. Please pay attention to it.
由於夏天濕度較高，當用冷水進行洗衣時，會在洗衣機外側出現結露現象，有可能會將地板弄濕，請加以注意。

When washing the thick clothes such as jersey, the oblique of the clothes in the basket is liable to cause the security problem.

洗滌運動衫等厚衣物時，由於衣物在槽內偏斜，較易導致安全開關動作。

Attentions in continuous operation.

連續運轉時應注意。

- Manually set the washing time as "12 minutes", operate the washing machine for over 3 consecutive cycles, the protective mechanism may work and stop the motor.
手動將洗衣時間設定為“12分鐘”，連續運轉3個循環以上時，保護裝置可能會起作用而使馬達停止運轉。
- If continuous operation is necessary, please restart the operation of the washing machine after 30 minutes more or less.
需連續運轉時，請隔30分鐘左右再讓洗衣機重新運轉。

Do not put in excessive clothes.

請勿投入過多衣物。

- It may cause overflow of the clothes during washing.
The placement of washings please see page 20.
有可能造成衣物在洗衣過程中溢出。
衣物的放入方法 20。

After spinning, the lock-in function of the lid is unlocked, but the basket will remain rotating for over 15 seconds.

脫水結束後，機蓋鎖緊功能被解除，但洗衣槽還會旋轉15秒以上。

- Stop use immediately and please request repair.
立即停止使用並請僱人維修。

Do not use sharp-edged article to press the buttons.

請勿使用鋒利的物品來按按鈕。

- Lest the buttons be damaged or in trouble.
以免造成破損或故障。

Don't open the lid while the inhaling window is open.

吸氣窗打開狀態下，不要開關機蓋。

- It may cause damage.
可能會造成破損。



Maintenance and Repair

維護保養方法

Maintenance of nanometer titanium filter net

納米鈦淨化網的維護

1 Open the inhaling window to 60° (you will feel a click), and remove the filter net.

吸氣窗打開至 60° 的位置 (有 " 卡塔 " 的感觸), 取下淨化網支架。

- The stains remained on inhaling window and inhaling net can be removed with a soft cloth.
吸氣窗、吸氣網有污垢時可用軟布清潔。

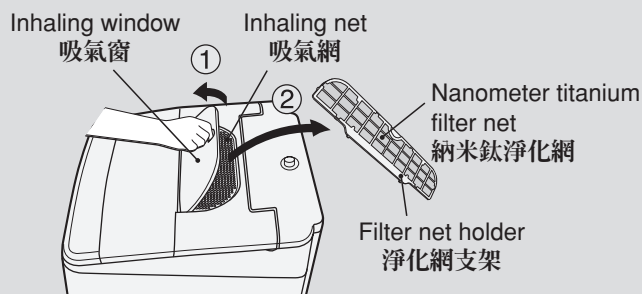

2 If there are stains on nanometer titanium filter net, please remove them with dust collector.

納米鈦淨化網上有污垢時, 請用吸塵器從淨化網支架上去除。

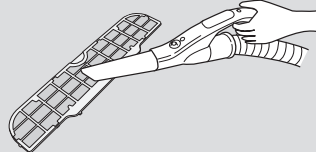

- If the stains are serious, please replace with a new nanometer titanium filter net.
若污垢很多, 建議更換新的納米鈦淨化網。

3 Hold the nanometer titanium filter net and release it from holder (with 6 latches)

抓住納米鈦淨化網使它脫離淨化網支架 (6 個搭扣)

- Use a soft cloth to clean the stains on filter net holder.
淨化網支架有污垢時可用軟布清潔。

Notes 備注

The nanometer titanium filter net assy is an exchangeable part.

納米鈦淨化網組件是一種可更換式部件。

If loss, damage, or severely stains occur, please buy new one at a dealer.

當出現丟失、破損、污垢嚴重時請往搵定商舖購買。

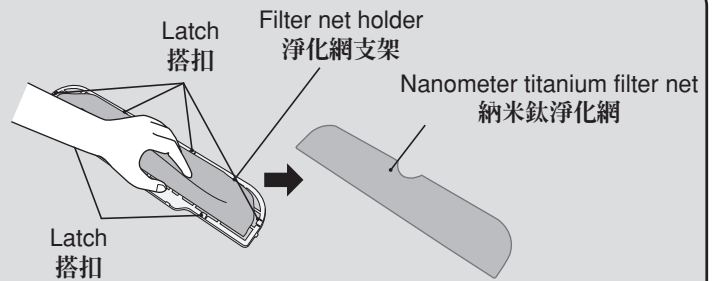

4 Install the nanometer titanium filter net onto its holder.

把納米鈦淨化網安裝到它的支架上。

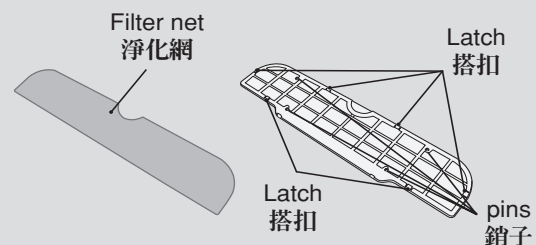

Attention 注意

- When installing, insert the nanometer filter net into its holder latches (6 places) and pins (4 places).
安裝時, 納米鈦淨化網要插入到它的支架的搭扣 (6 個), 銷子 (4 處) 上。

5 Install the nanometer titanium filter net onto the inhaling net.

將納米鈦淨化網裝在吸氣網上。

Attention 注意

- If nanometer titanium filter net is incorrectly installed, it may reduce the deodorization effect when drying.
納米鈦淨化網安裝不正確, 會降低乾燥時的除臭效果。

6 Close the inhaling window.

關閉吸氣窗。

※ If there is blockage in nanometer titanium filter net, it will influence the drying of laundry.
如果納米鈦淨化網的網眼堵塞的話, 會對衣服乾燥程度產生影響。

Pay attention to the rust on the washing basket 注意洗衣槽內的銹跡

The stainless basket is rustproof, but it may rust in the following cases.
雖然不銹鋼槽具有難以生銹的性質，但在以下場合還是有可能會生銹。

- ① The rust-inclined ironwork such as the barrette or the needle remains in the basket and touches the stainless steel inner wall.
髮夾或針等容易生銹的鐵製品留在槽內，與不銹鋼內壁接觸時。
- ② The water containing the impurities such as rust or iron power flows into the washing basket, and the impurities adhere to the stainless steel inner wall.
混有紅銹或鐵粉等雜質的水流進洗衣槽內，從而附著在不銹鋼內壁上。

When rusting of the basket occurs, use a sponge soaked with liquid cleanser to remove the rust.
(See instruction label on liquid cleanser for details)

對於鐵銹，可用市面有售的乳狀清潔劑倒在海綿或布上，反復擦拭將其清除。
(詳細內容請參閱洗衣粉的使用說明)

- Please do not use metal brush to clean the washing basket lest it will damage or rust the washing basket.
請勿使用金屬刷清洗洗衣槽，以免損傷洗衣槽或使之生銹。

To avoid rust, the followings must be ensured.

為防止生銹，必須注意以下要點。

- Avoid water and chlorine bleach in the basket for too long.
嚴禁水或氯類漂白劑長時間停留在洗衣槽內。



Maintenance of the detergent dispenser (it is liable to damage during dismantlement, please pay attention to it during the operation) 洗衣粉加入盤的保養(拆下時易損壞，操作時請加以注意)

- Remove the detergent dispenser for maintenance. ☞ 21
拆下洗衣粉加入盤進行保養。☞ 21
- If there is detergent or softener residue, please wipe it off or flush it away with water.
有洗衣粉或柔軟劑等物殘留時，請擦拭乾淨並用水沖洗。
- If there is severe dirt, warm water of around 40°C can be used to immerse it for five minutes, and then use the tools such as toothbrush to clean it up.
有嚴重污垢時，可用 40 度左右的溫水浸泡 5 分鐘，然後用牙刷等工具清洗乾淨。
- Before installing the detergent dispenser, please wipe off the water attached on it.
安裝洗衣粉加入盤前，請擦乾上面附著的水分。

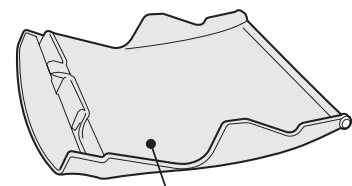

Detergent dispenser
洗衣粉加入盤

Maintenance of the lint filter. (It shall be performed after each time of use) 棉絮過濾器的保養(每次使用後都必須進行)

- 1 Press the hasp and pull it out, take out lint filter.
按住搭扣並順勢將其拉出，取下棉絮過濾器。

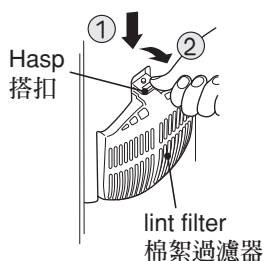

- 2 Remove the filter net from the encasing.
將過濾網從外殼上拆下。

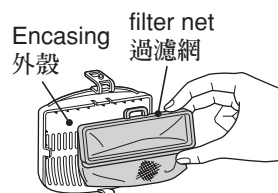

- 3 Remove the filter net and clean the net. If the net is severely blocked, toothbrush can be used to eliminate the floss.
除掉棉絮並清洗網孔。若網孔被嚴重堵塞，可用牙刷等物將棉絮清除乾淨。

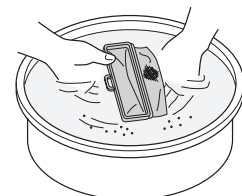



Maintenance and Repair (continued) 維護保養方法 (續)

- 4** Fit the angle hole of the filter net over the convexity of the encasing, then match the hasps on left and right sides. (push the protrusion of the angle hole into the encasing)
將網袋角孔套進外殼凸部，然後對好左右兩邊搭扣。(將網袋的角孔突起部分推進外殼內部)

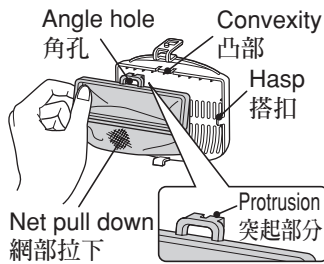

- 5** Install the lint filter.
安裝棉絮過濾器。

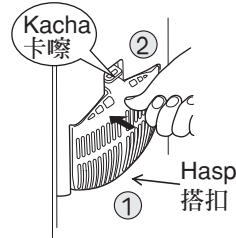

- ① Insert the lower hasp of the encasing in.
將外殼下部搭扣塞入。
- ② Press the encasing until hearing the sound of "Kacha".
將外殼壓入，直到聽到“卡嗒”的聲音。

Notes 備注

- The lint filter is consumable items. When damage is found in the filter net, please buy a new one at a dealer.
棉絮過濾器屬於消耗品。網袋破損時，請往指定商鋪購買。

Attention 注意

- When the lint filter is fetched out, please do not let the coin or barrette fall in the bottom of the washing basket.
取出棉絮過濾器時，請勿讓髮夾或硬幣等物掉入洗衣槽底部。
- Please do not wash clothes after removing the lint filter lest it will damage the clothes.
請勿將在棉絮過濾器拆下時洗滌衣物，以免損傷衣物。
- If lint filter is wrongly installed, the clothes or filter may be damaged during washing.
若不正確安裝棉絮過濾器，則洗衣時可能會損傷衣物或損壞過濾器。

When icing is possibly underway 有可能結冰時

- 1** Turn off the tap, and disassemble the water supply hose.
(Refer to page 13 for proper disassembly)
關閉水龍頭，拆下供水管。
(拆卸方法 13)

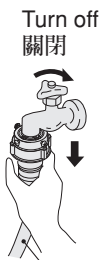

- 2** Make the water supply hose downward, but don't bend it.
將供水管朝下，但不能讓其彎曲。
- Lest the water remained in the charging hose will flow out.
以免殘留在供水管中的水流出。

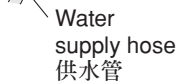

- 3** Select the "TUB CLEAN" process, and the operation will stop after 30 minutes.
選擇『筒清洗』程序，運轉 30 秒鐘後停止運作。
- All the water remained in the charging hose can be drained.
可將殘留在供水管中的水全部排出。

- 4** Put down the water drainage hose, place its tail in water container such as basin.
放下排水管，將其尾部放入水盆等盛水容器中。

- 5** Only set the "Spinning" 1 minute, and operation.
只設定『脫水』1 分鐘，運轉。 38

- 6** Switch off the power.
關閉電源開關。

When icing happens 如果已經結冰時

- 1** Disassemble the water supply hose, and put it into the warm water as hot as 40°C.
卸下供水管，將其放入 40 度左右的溫水中。

- 2** Pour the warm water as hot as 40°C into the basket.
在槽內倒入 40 度左右的溫水。

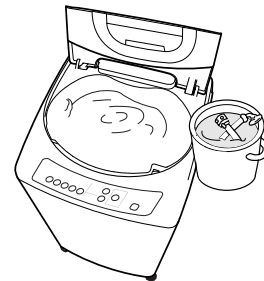

- 3** Connect the water supply hose to the tap, and check the washing machine to make sure the water supply and drain are in normal case.
再將供水管接至水龍頭，檢查洗衣機是否正常進行供水、排水動作。

How to maintain the water supply opening 供水口的保養

The contamination accumulated at the water supply opening will worsen the supply effect.
供水口積有髒物會影響供水效果。

1 Turn off the tap, and disassemble the water supply hose.
(Refer to page 13 for proper disassembly)
關閉水龍頭，卸下供水管。
(拆卸方法 13)

2 Clean up the contamination accumulated at the filtering net of water supply opening.
清除供水口濾網處積留的污物。
• If it's hard to clean up the contamination, disassemble the filtering net for easy cleanout.
若污物不易清除時，可將濾網拆下以便清洗。



Attention 注意

- The filtering net of water supply opening shall be recovered to the original shape after cleanout, so as to avoid the failure of water supply valve.
供水口濾網清洗後，請務必恢復原狀，以免引起供水閥的故障。

Maintenance to the main unit 機體的保養

Please use the soft cloth to wipe and clean the dirt on the washing machine body and the control panel.
請用軟布將機體和控制面板上的污垢擦拭乾淨。

Warning 警告



During the course of maintenance and repair, don't spray water directly to any part of the washing machine body.
進行保養時，請勿直接將水淋灑在洗衣機的各個部位。

- To avoid the happening of short circuit or electric shock.
以免造成短路或觸電。



Attention 注意

- Please don't use gasoline, thinner, detergent, alkali or weak-alkali detergent and wax to wipe the washing machine body, and please don't use brusher to wipe the body either.
請勿用汽油、稀釋劑、清潔劑、鹼性或弱鹼性洗衣粉以及蠟等物質擦拭機體，也請勿用刷子來擦洗機身。
- When using the chemical duster cloth, please refer to its user manual.
使用化學抹布時請遵照其使用說明。
- Remove any detergent touching the lid or other plastic components, otherwise it will damage the washing machine body after long remaining.
清潔劑沾至機蓋等塑料部件時，應立即擦除，否則長時間會損傷機身。

Warning 警告



Tap shall be closed first before remounting the charging hose. Select "BLANKET" process, slowly open the tap after pressing the start button. (it shall be treated the same in case of long-term idleness.)
斷水後或拆掉供水管又再次裝上時，應先關閉水龍頭，選擇『被毯』程序，在按下開始按鈕後再緩慢打開水龍頭。(長時間停止時也同樣處理)

- If there is residue air in the water supply hose and water drainage hose, the washing machine could be damaged by compressed air, leading to leakage or injury accident.
供水管、水管中有殘留空氣，洗衣機有可能因壓縮空氣而受損，從而造成漏水或傷害事故。



When Failure Happens 有故障發生時

About the abnormality alarm

關於異常警報

In the following cases, the flash of indicator and the sound of buzzer will announce the abnormality.

If the washing machine generates unexpected error alarm, the washing machine shall be temporarily suspended for a while, and then restarted. If the same error alarm occurs again, please follow the following steps.

出現下列情況時，將通過指示燈的閃動和蜂鳴器聲響告知您發生異常。

但若洗衣機出現意外的錯誤警報時，應先暫停機器，然後再次啟動。

若再次出現同樣的錯誤警報，請按以下步驟進行檢查。

Flash of indicator 指示燈閃動	Alarm content 警報內容	Part to check 檢查部位	Solution 處理方法
	Fail to supply water 無法供水時 Fail to reach the full water level within 40 minutes or fail to reach the required level (10L) within 8 minutes 經過40分鐘還無法達至滿水位，或經過8分鐘還沒有達到規定水位(10L)時	<ul style="list-style-type: none"> Is the tap turned on? 水龍頭是否打開? Is the tap water pipe frozen or out of supply? 自來水管是否凍結或停水? Is the filtering net at the water supply opening blocked by contamination? 供水口濾網是否被污物堵塞? 	<p>▶▶</p> <p>Troubleshooting 排除異常</p> <p>▶▶</p> <p>Restart operation 再次啟動運轉</p>
	Fail to drain water 無法排水時 Fail to drain up water within 5 minutes 經過5分鐘還無法排水完畢	<p>Check the water drainage hose 請對排水管進行檢查</p> <ul style="list-style-type: none"> Is the hanging height of the water drainage hose more than 1m? 排水管掛靠高度是否超過1m? Is the U-shaped hose on the tail immersed in the water and blocked? 排水管尾部U型管是否浸沒於水中而被堵塞? Is the water drainage hose or water drainage pump blocked by silt or lint? (Drainage opening need to be checked also) 排水管或排水泵是否被泥沙或棉絮堵塞? (排水口也需檢查) Is the water drainage hose frozen? 排水管是否有凍結? Is the water drainage hose properly installed? 9~10 是否正確安裝了排水管? 9~10 AJ-S55KXP whether or not hang the drain hose. AJ-S55KXP的排水管是否掛起? ※ AJ-S55KX Is the water drainage hose laid down? 排水管是否被放下? Is the water drainage hose squeezed up? 排水管是否被壓扁? 	
	Stop during the spinning course 脫水過程中停止	<ul style="list-style-type: none"> Is the laundry laid aside? 衣物是否偏置於一側? 	
	Lock of lid can not be unlocked 機蓋鎖緊無法解除	<ul style="list-style-type: none"> Press "PAUSE" button, and then restart it 按下『暫停』按鈕，然後重新啟動 	

**Flash of indicator
指示燈閃動**

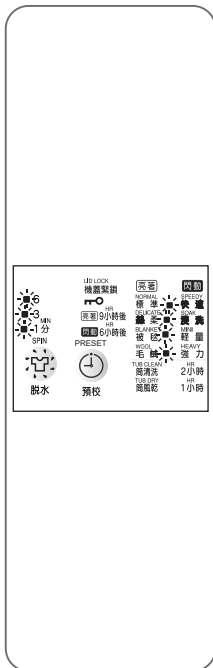

**Alarm content
警報內容**

The lid is not locked completely
(The lid is not completely closed)
機蓋沒有完全鎖緊
(機蓋沒有完全關閉時)

Washing basket can not rotate
(washing, rinsing, spinning)
洗衣槽無法旋轉
(洗衣、沖洗、脫水)

**Part to check
檢查部位**

• Is there foreign substance under the lid?
機蓋下有異物?

• Are the washings oblique?
衣物有無偏斜?
• Or is the washing machine placed straight? See page 7
洗衣機是否水平放置? 7

**Solution
處理方法**

Troubleshooting
排除異常
▼
Restart operation
再次啟動運轉

Please press the "START/PAUSE" button to pause the operation, rearrange the laundry evenly, and restart with the lid closed.
請按下『暫停』按鈕暫停運轉，調整衣物平衡後，關閉機蓋重新啟動。

- If the above abnormal alarms occur, they may be caused by outside interference. At that time, please press the PAUSE button to suspend the washing machine, then restart it. If the same alarms occur, please stop the use and request repair.
若出現上述之外的異常警報，有可能是由外來干擾導致。此時請按下暫停按鈕暫停運轉，然後重新啟動，若仍出現相同的異常警報，請停止使用並僱人修理。

**Before the repair request
要求修理前**

**Please recheck the following items
請再次檢查以下項目**

Case 現象

**Fail to running
不運轉**

**Water leakage
漏水**

Cause 原因

- Is power cut?
是否停電?
- Does fuse or breaker blow?
保險絲或熔斷器是否燒斷?
- Can the power plug enter the socket properly?
電源插頭是否可靠地插入電源插座?
- Is the power switch on?
電源開關是否打開?
- Is the tap turned on?
水龍頭是否打開?
- Is the "Preset washing process" set? 31
是否設定了“預校洗衣程序”? 31
- Whether the "START" button is pressed or not?
有無按下『啟動』按鈕?

- Is the tap of proper shape? 12
水龍頭的形狀是否合適? 12
- Are the one touch joint and the connection nut unfastened? 12, 13
便捷連接器和連接螺母是否出現鬆動? 12, 13



When Failure Happens (continued) 有故障發生時（續）

Case 現象	Cause 原因
Fail to supply water 不供水 No spinning, washing basket can't rotate 不脫水、洗衣槽無法旋轉 No stirring 不攪拌	<p>Please refer to "Part to check" in "About abnormality alarm". 46 請參照“關於異常警報”中的『檢查部位』。 46</p>
Unable to air jet 無法風乾	<ul style="list-style-type: none"> • Please refer to "Proposed Operation Time". 37 請參照“建議使用時間表”。 37
It doesn't work after setting of air jet 設定風乾後無法工作	<ul style="list-style-type: none"> • If there is water remained in the spinning basket, Start button can not be pressed. And it can only be pressed after draining all of the water. 脫水槽中有水積存時，就不能接受『啟動』鍵，要先進行排水，把水排光後再按『啟動』。
Can not open the lid 機蓋打不開	<ul style="list-style-type: none"> • Is the power on? (If there is outage and shutdown during the operation, the washing machine will generate alarms and cut off the power supply. The lid is still locked. When power supply is switched on again, the lid lock will be unlocked.) 電源開關是否打開？ (運轉過程中出現斷電或停電時，洗衣機將發出異常警報並自動切斷電源，機蓋仍處於鎖定狀態。再次接通電源後，機蓋鎖定將解除。)
Abnormal sound occurs 發出異常聲音	<ul style="list-style-type: none"> • Is the washing machine declining or shaky? 7 Installation Guide 洗衣機是否有傾斜或搖晃？ 7 安裝指南 • Is any barrette or metal item mixed in the washing basket? 有無髮夾或金屬物體混入洗衣槽內？
No buzz at the end of washing 洗衣結束後無蜂鳴聲	<ul style="list-style-type: none"> • Is the buzz at the end of washing set as canceled? 18 是否已設定取消洗衣結束蜂鳴聲？ 18
The lid can't be opened during the operation. 運轉過程中，機蓋無法打開	<ul style="list-style-type: none"> • Whether it is set to lid lock function (safety protection mode)? 18 是否進行了機蓋緊鎖功能(安全保護模式)的設定？ 18
Water can not be reserved (when pouring the water with water basket) 不能儲水 (用水桶等容器倒入水時)	<ul style="list-style-type: none"> • Is the power on? 電源開關是否打開？ (In case of power cut during draining, the drainage valve will keep open. And the drainage valve will close after the power resumes.) (原因在於排水過程中出現斷電或停電時，排水閥會保持開啟狀態。再次接通電源後，排水閥將關閉。)

• Except the failures metioned above, the lid lock protector may cause cases such as stop during operation or lid unable to be opened. In such case, please unplug the power supply unit. Plug it back after 5 minutes, and then reset operation.

除了上述故障外，如發生運行中途停止或機蓋無法打開的現象，是童鎖開關保護器動作。此時，請拔下電源插頭，五分鐘後再插上，重新設定並運行即可。

※ AJ-S55KXP

• If all indicators turn off during operation but only the water drainage pump remains in operation, this is the auto operation of protection circuit in washing machine for water level is too high. This is not an error.

After water drainage pump stops, please reconnect the power supply and reassign the setting.

如果所有指示燈在運轉過程中熄滅，但只有排水泵仍在運轉，這是因為洗衣機水位過高、保護電路自動運行。這並非故障。排水泵停止運轉後，請重新連接電源並進行設置。

■ Automatic power OFF 電源自動關閉功能

- The power will be cut automatically at the end of operation.
運轉結束後，電源開關將自動切斷。
- The power will be automatically cut if the washing machine keeps one of the following status for above 1 hour.
在下列情況中，若將洗衣機放置1小時以上，則電源開關將自動切斷。
 - 1) Pause 暫停狀態
 - 2) Lid open 機蓋開啟的狀態
 - 3) Abnormality alarm describer in page 46 如同46頁的異常警報狀態
- With no pressing on "START/PAUSE" button in 5 minutes after the power on, the power will be cut automatically.
接通電源後，若不按下啟動按鈕，則5分鐘之後電源開關將自動切斷。

The following cases are not the failures 以下現象並非故障

Case 現象	Cause 原因	
About the water charging 關於供水	Supply water during the course of washing. 洗衣過程中供水。	• Supply water automatically if the water level drops during the course of washing. 洗衣過程中若水位下降，便會自動補水。
	The water can no be charged when starting washing form rinse. 從沖洗開始洗衣時，無法供水。	• The rinse water can only be charged after drainage and spinning. 排水和脫水之後才開始進沖洗用水。
	After connecting the water supply pipe, water will come in from the water supply opening if turning on the tap. 供水管連接後，打開水龍頭，有水從供水口處流出。	• With the application of decompression valve, the close of valve needs certain duration. 由於採用了減壓閥，閥門關閉需要一定的時間。
	The pulsator stop rotating during the charging for about 1 minutes. 供水過程中攪拌翼停止旋轉，供水停止約1分鐘。	• It may be influenced by outside interference, and it takes some time for the sensor to detect the interference. 可能受到了外來干擾的影響，而傳感器檢測干擾需要一定時間。
	The rotary water supply takes a longer time. 旋轉供水時間變長。	• As the water level of washing machine is too low. 這是由于洗衣机的供水量太小所引起的。
About the sound 關於聲音	"Rustle" happens as rotating the washing basket by hand. 用手轉動洗衣槽，發出“沙沙”聲音。	• The sound comes from the water flow in the liquid balance used to relieve the spinning vibration. 這是降低脫水振動的液體平衡器中水流的聲音。
	It sounds "Karcha" at the beginning of washing or spinning. 洗衣或脫水開始時發出“卡嚓”聲音。	• That is generated during the mode switch of the clutch (the strength of the sound varies with the sound duration). 這是離合器進行模式切換時的聲音。 (聲音大小隨發生時間而變化)
	It buzzes during the operation. 運轉過程中發出“嗡—”或“嗡嗡”聲音。	• That is the electromagnetic sound of the motor switched on and off. 這是電機通斷電或電閘的電磁音。
	It buzzes or sounds "Hoola, hoola" during the high-speed washing or dehydration. 高速洗衣或脫水過程中發出“嗡—”或“嘩啦嘩啦”聲音。	• That is the electromagnetic sound of the motor switched on and off to control the rotating speed. 這是為了控制脫水轉速而給電機通斷電所發出的聲音。



When Failure Happens (continued) 有故障發生時 (續)



Case 現象	Cause 原因
About the rinse 關於沖洗 Sprinkling rinsing turns into water storing rinse. 噴淋沖洗變為儲水沖洗。 When the washings is not much, water can't be poured over the clothes in sprinkling rinsing mode. 洗衣量較少時，噴淋沖洗無法將水澆到衣物上。	<ul style="list-style-type: none"> It is because the clothes oblique cause the action of the security switch. 由於衣物偏斜導致安全開關動作的緣故。 It doesn't matter that the water is hard to be poured over the clothes since there are not much washings. 洗衣量較少時，雖然難以將水澆到衣物上，但沖洗功能並無問題。
About the spinning 關於脫水 Supply water during the course of spinning. 脫水過程中供水。 Supply water and start rinsing during the course of spinning. 脫水過程中開始供水並沖洗。 Spin intermittently after start spinning. 脫水開始後，間歇性地脫水。 The lid can't be opened even when the PAUSE button is pressed during the spinning. 脫水過程中，即使按下暫停按鈕也無法立即打開機蓋。 The power supply switch won't work right away even when the ON/OFF button is pressed during the spinning. 脫水過程中即使按下電源開關按鈕，電源開關也不會立即起作用。	<ul style="list-style-type: none"> The security switch acts as the laundry declines. Change automatically to the "Water-storage rinse" for the next rinsing. 由於衣物偏斜導致安全開關動作的緣故。下次沖洗將自動變為儲水沖洗。 The security switch acts as the laundry declines. Start spinning and agitating after rinsing, and the spinning will go on after clearing the laundry declination. 由於衣物偏斜導致安全開關動作的緣故。沖洗後進行脫水和攪拌運轉，消除衣物偏斜後還會繼續脫水。 It is because the sensor control the spinning times to improve the efficiency of spinning. 這是為提高脫水效率，由於傳感器控制脫水次數的緣故。 When the power supply is cut off, the spinning basket stops completely, and the lid lock will be unlocked. 當斷開電源，脫水槽完全停止下來後，機蓋鎖定將被解除。 The power supply switch won't work until the spinning basket stops the inertial rotation. 直到脫水槽的慣性旋轉停止後，電源開關才會起作用。
※AJ-S55KXP About the water drainage pump 關於排水泵 During the period of water drainage, the water drainage pump start to work, and there is water drained out from the water drainage hose. 供水過程中，排水泵開始工作，排水管中有水排出 It sounds like asthma when the water drainage pump start to work. 排水泵排水時，有類似哮喘的聲音	<ul style="list-style-type: none"> This is to prevent overflow. The water drainage pump starts automatically when the preset alarming level is exceeded. 這是為了防止溢水。當超過設定的預警水位時，排水泵自動啟動。 This is because the water in the washer is going to be drained off, resulting in the entry of air into the chamber of the water drainage pump. 這是因為洗衣機中的水即將排完，使空氣進入了排水泵的腔體內。
About the water level 關於水位 Relatively low water level compared with the washings load. 水位相對於洗衣量較低。 Relatively high water level compared with the washings load. 水位相對於洗衣量較高。	<ul style="list-style-type: none"> The setting of the water level is based on the extent of the washings in the washing machine emerging out the water surface and the ability of the clothes roll up and down in the washing machine. 洗衣機以衣物稍微露出水面為依據設定水位，由攪拌翼攪拌衣物可以上下翻動。 Since the clothes of chemical fiber is comparatively light, the water level is set accordingly low. 由於化學纖維、聚脂纖維等衣物較輕，因此水位設定也較低。 The water level will rise during washing if the clothes being washed have been drenched or water has been charged in advance. 洗滌已濕透的衣物或洗衣槽中事先放了水時，洗衣時水位會較高。
About the lint filter 關於棉絮過濾器 There are much floss. 棉絮較多時。	<ul style="list-style-type: none"> If there is much floss in "NORMAL" process, the efficiency of the floss filtering can be improved by increasing the water consumption, extending washing time and setting rinse for more times. 標準程序中出現較多棉絮時，可用提高水位，延長洗衣時間和設定多次沖洗等方法提高過濾棉絮的效率。
About the washing duration 關於洗衣時間 Washing doesn't finish beyond the predefined time. 超過設定時間洗衣仍未結束。	<ul style="list-style-type: none"> The washing time may exceed predefined time in case of extremely small amount of charged water. 供水量很少的情況下，洗衣時間有可能超過設定時間。

Case 現象	
About the drying time 關於乾燥時間	Dehydration doesn't finish beyond the predefined time. 超過設定時間乾燥仍未結束。
About the air jet processing 關於風乾程度	It is not dried. 未乾。
About the power switch 關於電源開關	The power supply switch won't work right away when transferred from switched-off to switched on. 電源開關由“斷開”轉換到“接通”時，可能不會立即起作用。
	The indicating LED won't light right away when the power supply switch is switched on. 電源開關“接通”後，指示燈不會立即點亮。
	Four modes LED light after the power supply switch is switched off. 電源開關“斷開”後，4個程序指示燈點亮。
	It buzzes after the power supply switch is switched off. 電源開關“斷開”後，發出“嗡嗡”的聲音。
About the lid lock 關於機蓋鎖定	The lid can't be opened even when the PAUSE button is pressed during the spinning. 脫水過程中，即使按下暫停按鈕也無法立即打開機蓋。
About the flavor 關於氣味	Odor of insulating varnish smells in the beginning of use. 初期使用時有氣味。
	It smells at the time of spinning. 脫水時有氣味。
Others 其他	Water comes out from the water drainage hose during first time usage. 第一次使用時，有水從排水管中流出。
	Pulsator rotates but does not display the washings load and water quantity after pressing the START button. 按下啟動按鈕後，攪拌翼轉動但沒有顯示洗衣量和水位。
	No reaction after starting. 啟動後無動作。
	There are detergent residue remained on the detergent dispenser. 洗衣粉殘留在洗衣粉加入盤。

Cause 原因
<ul style="list-style-type: none"> • The predefined time is the time for drying dehydration, and the actual operation time need to plus the clothes dressing and oblique correction time, which, in aggregation, will be longer than the predefined time by 5~30 minutes. 設定時間是進行乾燥脫水的時間，實際運轉時間還要加上理順衣物和糾正衣物偏斜的時間，大概比設定時間延長5至30分鐘。
<ul style="list-style-type: none"> • Depending on the quantities & types of laundries, air temperature & moisture, seasons and environment, the completion time may differ. 由衣物的數量、種類、氣溫、濕度、季節和環境決定，完成時間會變化。 • Please refer to "Proposed Operation Time". 37 請參照“建議使用時間表”。 37
<ul style="list-style-type: none"> • The power supply switch doesn't work from the cutoff of the switch to the extinguishment of the mode LED. If the power supply is to be switched on again, please press the switch after the LED extinguish. 從切斷電源開關到程序指示燈熄滅為止，電源開關不起作用。若要再次接通電源，請待指示燈熄滅後再按下電源開關。 • The washing machine sound "Hoola, hoola" after the power supply is switched on. About 1 second later, the LED light. (since the software switch is used, the microcomputer need time for internal treatment.) 接通電源開關後，洗衣機發出“嗶嗶”的聲音，大約1秒鐘後指示燈點亮。(由於使用軟件開關，而微電腦進行內部處理需要時間) • When switching off the power supply with clutch motor in spinning status, the clutch motor returns to washing status and the mode LED light. 离合器電機在脫水狀態下，切斷電源開關時，离合器電機回復至洗滌狀態，同時程序指示燈點亮。 • The operation stops after the power supply is switched off during the dehydration, and it buzzes. That's the sound generated during switching of the modes by clutch. 脫水過程中切斷電源開關後，運轉停止並發出“嗡嗡”聲。這是離合器進行模式切換時的聲音。
<ul style="list-style-type: none"> • After the power supply is cut off, the spinning basket stops completely, and the lid lock will be unlocked. 當斷開電源，脫水槽完全停止後，機蓋鎖定將被解除。
<ul style="list-style-type: none"> • This is the odor of the insulating varnish of the motor in the beginning of use. The odor exists only at the early stage, and will disappear about period of time after put into application. 這是初期使用時從電機中的絕緣漆產生的氣味。該異味僅存在於初期，使用約一段時間後氣味會自動消失。 • Adverse drainage condition or excessive foams (due to excessive detergent) may cause too much spinning load and make the smell even more intensive. 排水條件惡劣或泡沫過多(因放入過多洗衣粉等)會造成脫水負荷過大，使得氣味更加強烈。
<ul style="list-style-type: none"> • Water from tests conducted by the manufacturer remains in the drainage hose. 這是工廠做性能測試時剩下的水。 • This is because the sensor can not successful detect due to the foreign interference. At that time, the power supply can be cut off and the washing machine is to be restarted. 這是由於外來干擾的影響而導致傳感器無法正確檢測造成的。此時可切斷電源，然後再次啟動。 • This is because the washing machine is waiting for detergent or is switching the clutch. 這是由於洗衣機在等待放入洗衣粉或正在進行切換離合器。 • When the body is excessive oblique, the detergent may remain on the dispenser. Please check the obliquity of the body. 當機體過度傾斜時，洗衣粉可能會殘留在洗衣粉加入盤。請檢查機體的傾斜程度。



Optional Parts 另售部件

<p>■ Extended water supply hose (1m / 2m / 3m) 延長用供水管 (1m / 2m / 3m)</p> <ul style="list-style-type: none"> For supply hose extension. 用於延長供水管。 	<p>■ Washing cap (Specialized) 洗衣蓋 (專用)</p> 	<p>■ Lint filter 棉絮過濾器</p> 	<p>■ Nanometer titanium filter net assy 納米鈦淨化網組件</p> 
<p>■ Fixing holder 排水管固定架(AJ-S55KXP)</p> 	<p>■ Water drainage hose 排水管(AJ-S55KXP)</p> 	<p>■ Extended water drainage hose (about 80 cm) 延長用排水軟管 (約 80cm)(AJ-S55KX)</p> <ul style="list-style-type: none"> For drainage hose extension. 用於延長排水軟管。 	

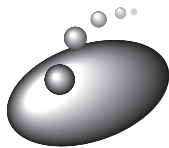

Product Specifications 產品規格

Model 型號	AJ-S55KXP	AJ-S55KX
Type 種類	Fully automatic washing machine 全自動洗衣機	Fully automatic washing machine 全自動洗衣機
Power 電源	220V~50Hz	220V~50Hz
Normal washing capacity 標準洗衣容量	5.5kg (the quality of dry cloth)	5.5kg (the quality of dry cloth)
Normal spinning capacity 標準脫水容量	(乾布的質量)	(乾布的質量)
Normal water level 標準水位	50L("NORMAL"process) 50L(「標準」程序)	50L("NORMAL"process) 50L(「標準」程序)
Rating power 額定功率	Washing:380W; Spinning:300W 洗滌時:380W; 脫水時:300W	Washing:380W; Spinning:300W 洗滌時:380W; 脫水時:300W
Washing mode 洗衣方式	Automatic reverse pulsator type 自動正反攪拌方式	Automatic reverse pulsator type 自動正反攪拌方式
Pressure of tap water 自來水水壓	0.03MPa~0.8MPa (0.3kgf/cm ² ~8kgf/cm ²)	0.03MPa~0.8MPa (0.3kgf/cm ² ~8kgf/cm ²)
Profile dimension 外形尺寸	W 500mm×D 560mm×H 985mm 寬 500mm×深 560mm×高 985mm	W 539mm×D 530mm×H 985mm 寬 539mm×深 530mm×高 985mm
Weight 重量	About 30kg 約 30kg	About 30kg 約 30kg



Hitachi Appliances, Inc.

No. 15-12, 2-chome, Nishi-Shinbashi, Minato-ku, Tokyo 105-8410, Japan

Tel: Tokyo (03) 3502 - 2111