

SHARP®

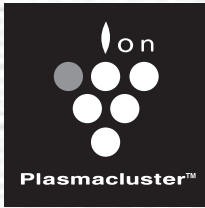

Free Standing
直立式

*Plasmacluster is a trademark of Sharp Corporation.

*Plasmacluster 是聲寶公司的商標

香港電器安全規格
(國際電工委員會規格適合)

FU-S51A

AIR PURIFIER
OPERATION MANUAL

空氣清新機
使用說明書

ENGLISH

中文

Please read before operating your new Air Purifier

The air purifier draws in room air from its air intake, lets the air pass through a Active Carbon Filter (deodorization filter) and a HEPA Filter (dust collection filter) inside of the unit, then discharges the air from its air outlet. The air purifier unit repeats this process by moving its internal fan.

As air passes through, a new HEPA Filter can remove 99.97% of dust particles, of as small as 0.3 microns. The Active Carbon Filter gradually absorbs odour elements as they repeatedly pass through the filter. (Odour elements are absorbed by HEPA Filter as well.)

Some odour ingredients absorbed by the filters may become separated and may be discharged through the air outlet and result in additional odour. Depending on the usage environment, especially when the product is used in a condition significantly more severe than household use, this odour may become strong in a shorter period than expected.

If the odour persists, then the filters are fully expended and it is necessary to purchase the optional replacement filter.

NOTE

- The air purifier is designed to remove air-suspended dust and odour, but not harmful gases (for example, carbon monoxide contained in cigarette smoke). If the odour sources still exist, it cannot completely remove the odour. (for example, odours from construction materials and pet odours).
- It is suggested to open the window a bit when you are smoking in order to facilitate ventilation.

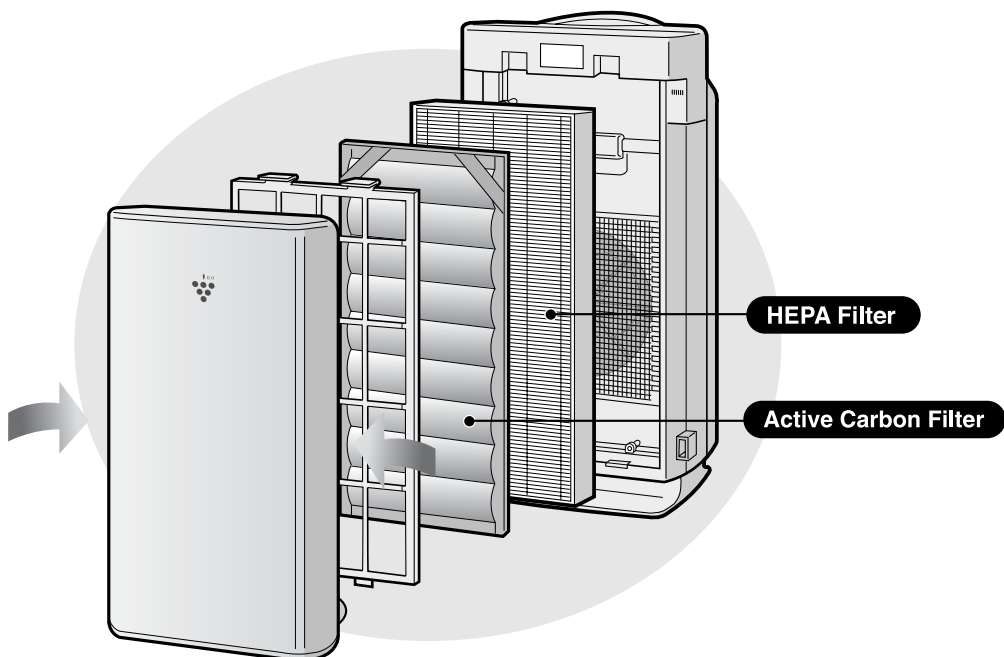

FEATURES

ION SHOWER

New ION SHOWER Operation Mode releases the concentrated Plasmacluster Ions, and effectively removes the pollen and mold, and also controls the activity of airborne virus, mold, and allergen.

Plasmacluster Ion Control

Your new air purifier will control the ratio of negative ions and positive ions depending on the condition of the room.

• Clean Mode

Approximately the same numbers of positive and negative ions are discharged.

• AUTO Plasmacluster Ion Mode

The unit will switch between Clean Mode and Ion Control Mode* automatically depending on the amount of impurities in the air detected by the odour and dust sensors.

*Ion Control Mode

Negative ions will be released in an increased rate and controls the ion balance.

• Filters

1) Washable Active Carbon Filter

Absorbs odour elements.
Washable to maintain optimum deodorization performance.

2) HEPA (High Efficiency Particulate Air) Filter with Microbial Control

High-efficiency particle collection including pollen and dust.

CONTENTS

IMPORTANT SAFETY INSTRUCTIONS E-2

- WARNING E-2
- CAUTIONS CONCERNING OPERATION ... E-3
- INSTALLATION GUIDELINES E-3
- FILTER GUIDELINES E-3

PART NAMES E-4

- MAIN UNIT DISPLAY E-4
- ILLUSTRATIVE DIAGRAM E-4
- BACK E-5
- INCLUDED E-5

PREPARATION E-6

- FILTER INSTALLATION E-6

OPERATION E-8

- MAIN UNIT OPERATION E-8

CARE AND MAINTENANCE E-10

- MAIN UNIT E-10
- FILTER E-10
- SENSORS E-10
- WASHABLE ACTIVE CARBON FILTER CARE E-11
- FILTER REPLACEMENT GUIDELINES E-12

SPECIFICATIONS E-12

TROUBLESHOOTING E-13

Thank you for purchasing the SHARP Air Purifier. Please read this manual carefully for the correct usage information. Before using this product, be sure to read the section: "Important Safety Instructions."

After reading this manual, retain it in a convenient location for future reference.

IMPORTANT SAFETY INSTRUCTIONS

When using electrical appliances, basic safety precautions should be followed, including the following:

WARNING - To reduce the risk of electrical shock, fire or injury to persons:

- Read all instructions before using the air purifier.
- Use only a 220 volt outlet with a polarized receptacle.
- **Do not use the air purifier if the power cord or plug is damaged or the connection to the wall outlet is loosened.**
- Periodically remove dust from the power plug.
- **Do not insert fingers or foreign objects into the intake or air outlet.**
- **When removing the power plug, always hold the plug and never pull the cord.**
Electrical shock and/or fire from short circuit may occur as a result.
- **Do not remove the plug when your hands are wet.**
- **Do not use this air purifier near gas appliances or fireplaces.**
- **Remove the power plug from the wall outlet before cleaning the unit and when not using the unit.**
Electrical shock from bad insulation and/or fire from short circuit may occur as a result.
- **If the power cord is damaged, it must be replaced by the manufacturer, its service agent, Sharp authorized Service Centre or similarly qualified person in order to avoid a hazard.**
- Do not operate when using aerosol insecticides or in rooms where there is oily residue, incense, sparks from lit cigarettes, chemical fumes in the air or in very high humidity condition, such as a bathroom.
- Be cautious when cleaning the air purifier. Strong corrosive cleansers may damage the exterior.
- Only Sharp Authorized Service Centre should service this air purifier. Contact the nearest Service Centre for any problems, adjustments, or repairs.

NOTE - Radio or TV Interference

If this air purifier should cause interference to radio or television reception, try to correct the interference by one or more of the following measures:

- Reorient or relocate the receiving antenna.
- Increase the separation distance between the air purifier and radio/TV receiver.
- Connect the equipment into an outlet on a circuit different from that to which the receiver is connected.
- Consult the dealer or an experienced radio/TV technician for help.

IMPORTANT SAFETY INSTRUCTIONS

CAUTIONS CONCERNING OPERATION

- Do not block the intake and air outlet.
- Do not use the unit near or on hot objects, such as stoves or heaters or where it may come into contact with steam.
- Do not lay the unit down when using.
- **Always hold the handle on the back of the unit when moving it.**
Holding the front panel when carrying may cause it to detach, thus dropping the unit and resulting in bodily injury.
- **Do not operate the unit without the filter.**
- **Do not wash and reuse HEPA filter .**
It not only does not improve filter performance, it may cause electric shock or malfunction.
- **Clean the exterior with a soft cloth only.**
The unit surface may be damaged or cracked.
In addition, the sensors may malfunction as a result.

INSTALLATION GUIDELINES

- **During the operation of the product, please place the unit at least 2m away from equipments which involve electric wave such as televisions, radios or wave clocks, in case electrical interference occurs to such equipment.**
- **Avoid a location where the sensor is exposed to direct wind.**
The unit may not operate properly.
- **Avoid locations where curtains, etc., come into contact with the intake or air outlet.**
Curtains, etc., may become dirty or a malfunction may occur.
- **Avoid locations where the unit is exposed to condensation, due to drastic temperature changes.**
(Use under appropriate conditions between 0 and 35°C in the room.)
- **Place on a stable surface with sufficient air circulation.**
When placing the unit on a heavily carpeted area, it may cause the unit to vibrate slightly.
- **Do not install when there is generation of lampblack, such as in a kitchen, etc.**
The unit surface may crack or the sensor may malfunction as a result.
- **Leave about 60cm of space from the wall.**
The wall behind the air outlet may become dirty as time passes. When using the unit for extended period of time in the same location, use a vinyl sheet, etc., to prevent the wall from becoming dirty. In addition, periodically clean the wall.

FILTER GUIDELINES

- Follow the instructions in this manual for correct care and maintenance of the filters.

PART NAMES

MAIN UNIT DISPLAY

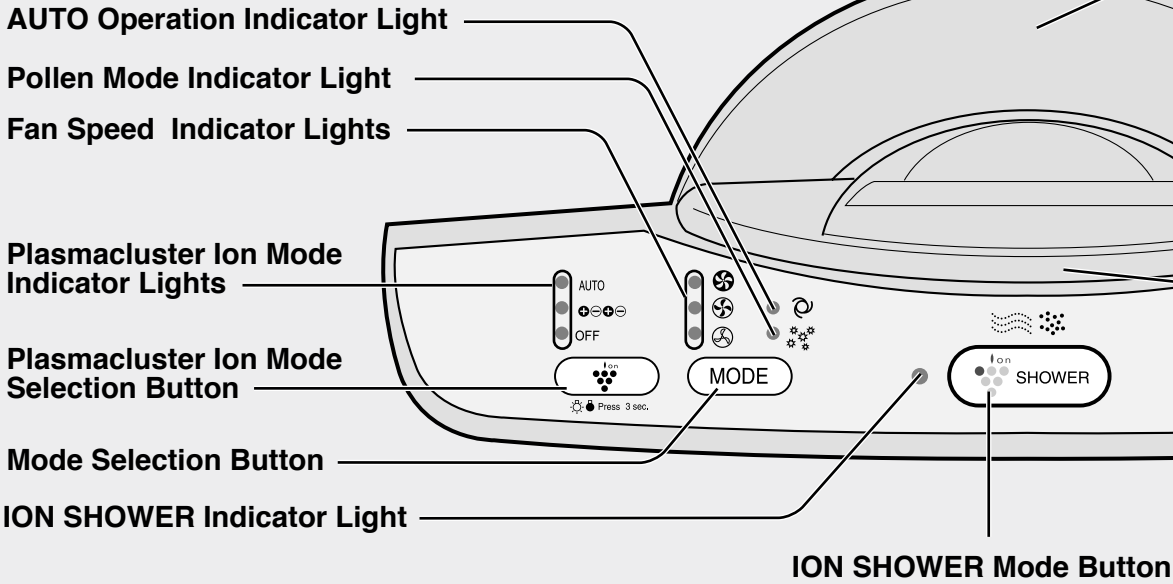

ILLUSTRATIVE DIAGRAM

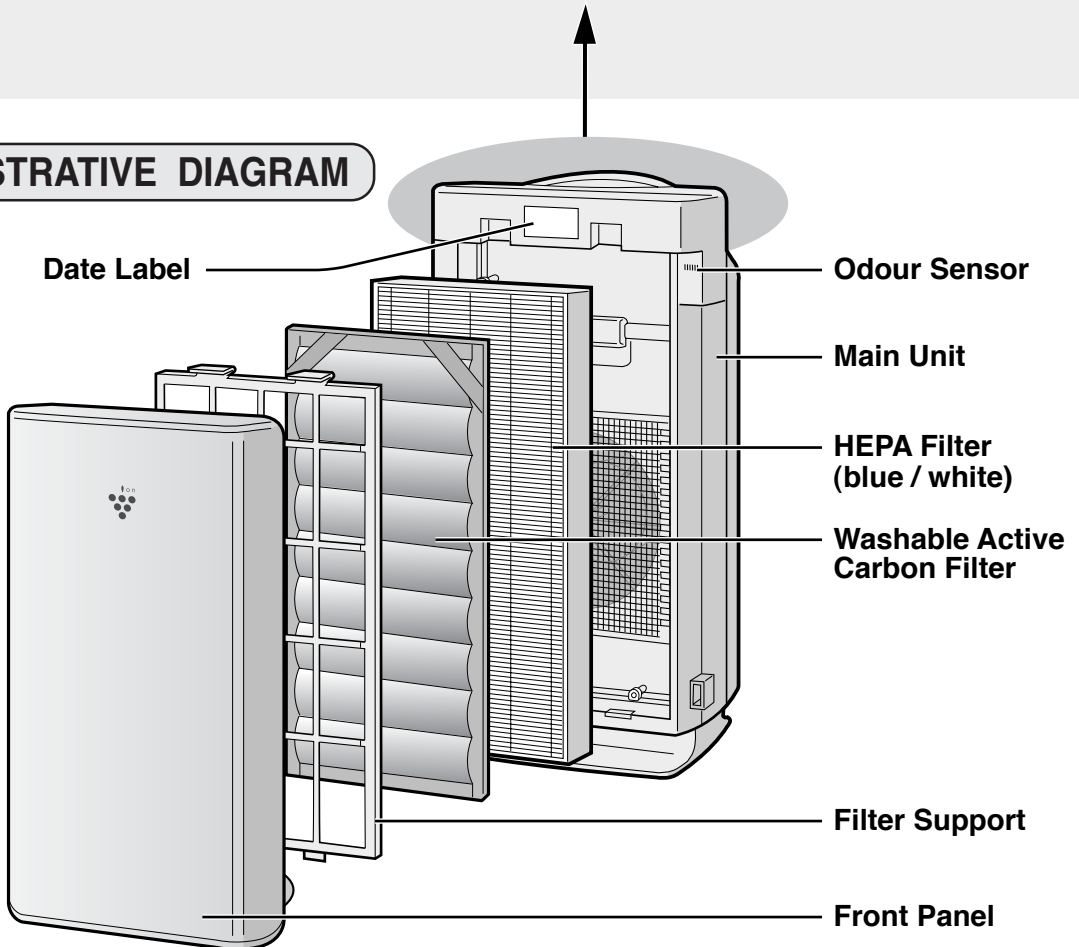

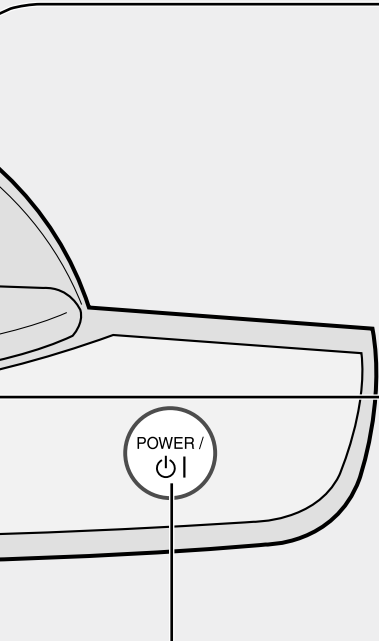

POWER ON/OFF Button

Plasmacluster Indicator Light
(Please refer page E-9)

Blue light

When the Plasmacluster ion operation is in Clean Mode, or in AUTO Plasmacluster Ion Mode and the air in the room is impure, the light will be activated and the unit will operate in Clean Mode.

Green light

When the Plasmacluster ion operation is in the Ion Control Mode during AUTO Plasmacluster Ion Mode and the air in the room is clean, this light will be activated and the unit will operate in Ion Control Mode.

Cycles of blue and green

When the Plasmacluster ion operation is in the ION SHOWER Mode, Plasmacluster Indicator Light will repeat its colour cycles between blue and green.

CLEAN - SIGN Light

The colour changes according to the air condition.

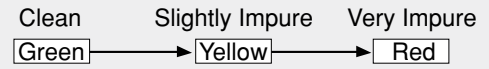

ABOUT THE CLEAN-SIGN

- The condition of the CLEAN-SIGN depends on the room air condition detected by the Dust and Odour Sensors when the plug is inserted into the wall outlet.
- It is possible to have a green CLEAN-SIGN with impurities in the air at the time that the air purifier was just introduced to the room environment. After a while, however, the base impurity rate will be adjusted to detect room air condition correctly.

DETERMINING THE BASE IMPURITY RATE

For the first 30 seconds after the power plug is inserted into the wall outlet, the unit will check the conditions of the air. If operation is set to ON during this time, the CLEAN-SIGN LIGHT will alternately flash in green, yellow and red.

BACK

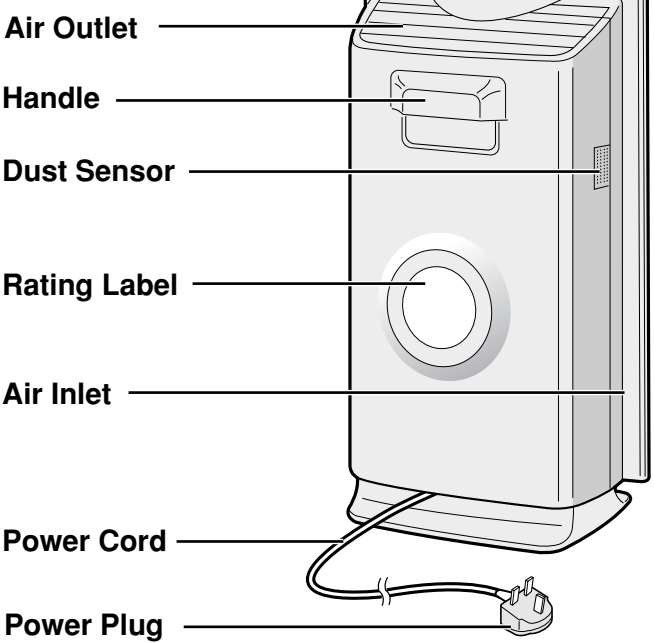

INCLUDED

- Operation manual

FILTER INSTALLATION

To maintain the quality of the filters, they are installed in the main unit and packed in plastic bags. Be sure to remove the filters from the plastic bags before using the unit.

1 Remove the filters

- 1 Remove the Front Panel.**
Pull the Front Panel on the lower sides, and lift up.

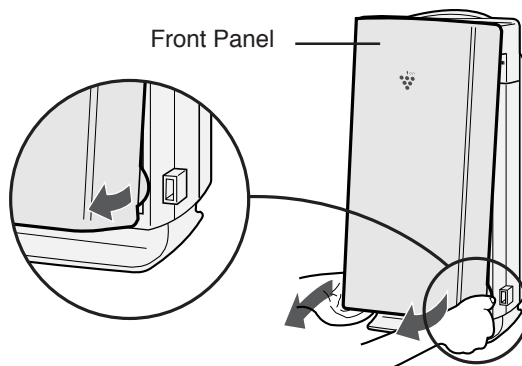

- 2 Remove the Filter Support.**
Push in the hooks on top, then pull the Filter Support.

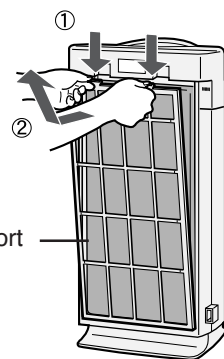

- 3 Remove the HEPA Filter.**

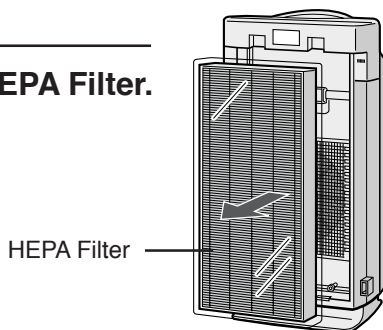

- 4 Remove the HEPA Filter from the plastic bag.**

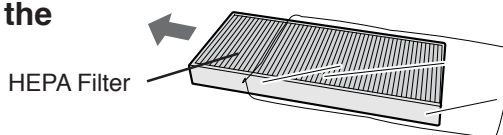

- 5 Remove the Active Carbon Filter from the carton box, and also remove from the plastic bag.**

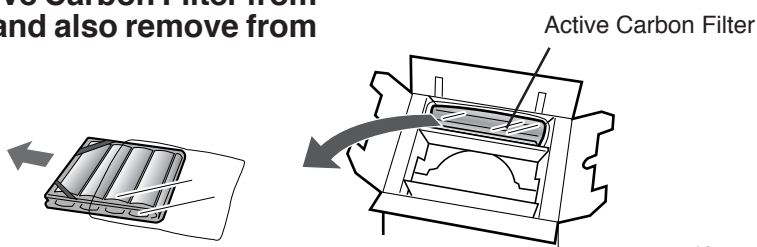

(At open)

2 Install the filters

1 Place the HEPA Filter into the main unit.

Please make sure that the HEPA Filter(blue) and the tab is placed in proper direction.

Do not install the filter backwards or the unit will not operate properly.

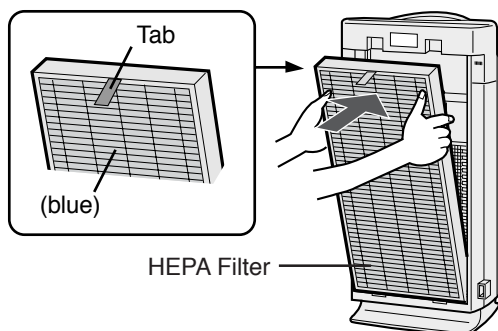

2 Place the Filter Support through the bands (2 places) located at the corners of the Active Carbon Filter.

Filter Support
Active Carbon Filter

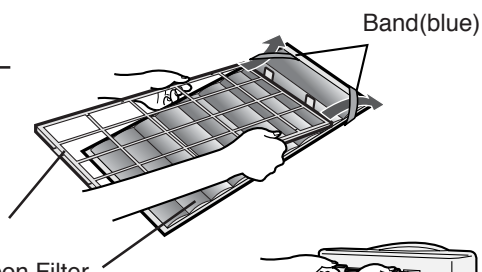

3 Replace the Filter Support and Active Carbon Filter back to the main unit.

Filter Support

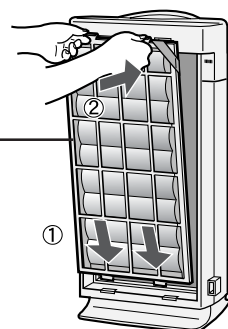

4 Fill in the usage start date on the Date Label.

Use the date as a guide for the Filter Replacement schedule.

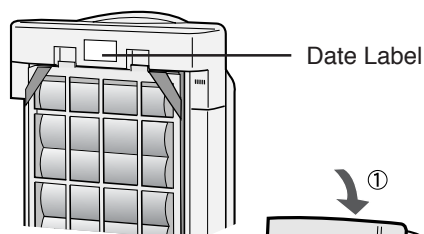

5 Replace the Front Panel.

Place the Front Panel from the obliquely upward, then mount the hooks at the bottom.

Front Panel

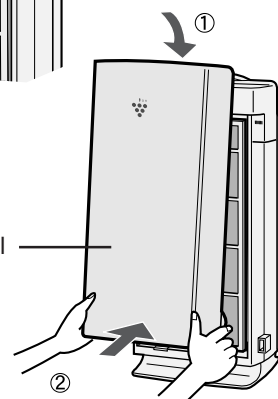

OPERATION

MAIN UNIT OPERATION

Mode Selection Button

Plasmacluster Ion Mode Selection Button

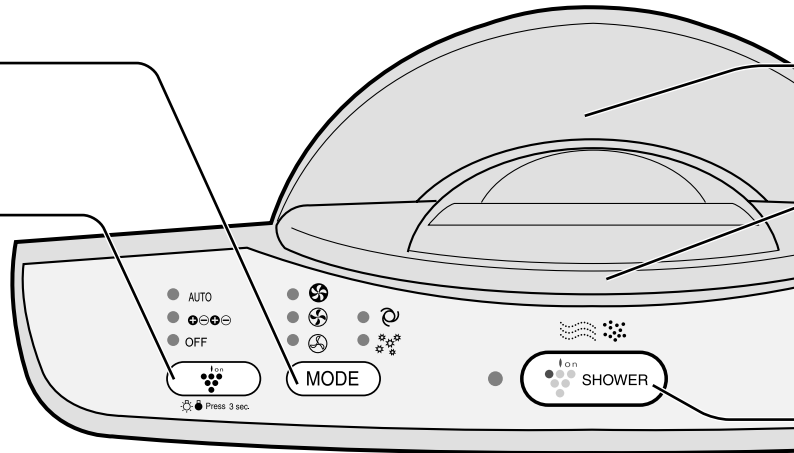

Power ON/OFF Button

- Used to start operation (short beep) and stop operation (long beep)
- Plasmacluster Indicator Light and Fan Speed Indicator Light turn on/off.
- Unless unplug the power cord, the operation starts in the previous mode the unit was operated in.
- When stop operation during ION SHOWER Operation, the unit will back to the prior operation of ION SHOWER Operation.

MODE

MODE Selection Button

- The operation mode can be switched.

AUTO operation

The fan speed is automatically switched (HIGH*, MEDIUM, SILENT) depending on the amount of impurities in the air. The sensors detect the impurities for efficient air purification.

POLLEN mode operation

The unit will operate at HIGH* fan speed for 10 minutes, then will alternate between MEDIUM and HIGH* for 20 minutes.

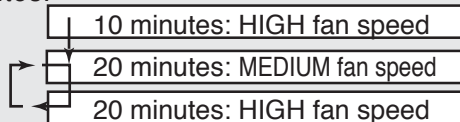

SILENT operation

The unit will operate quietly using minimal air intake.

MEDIUM operation

The unit will operate at a fan speed of MEDIUM.

MAX operation

The unit will operate at a fan speed of MAX.

* HIGH fan speed is an intermediate speed between MEDIUM and MAX.

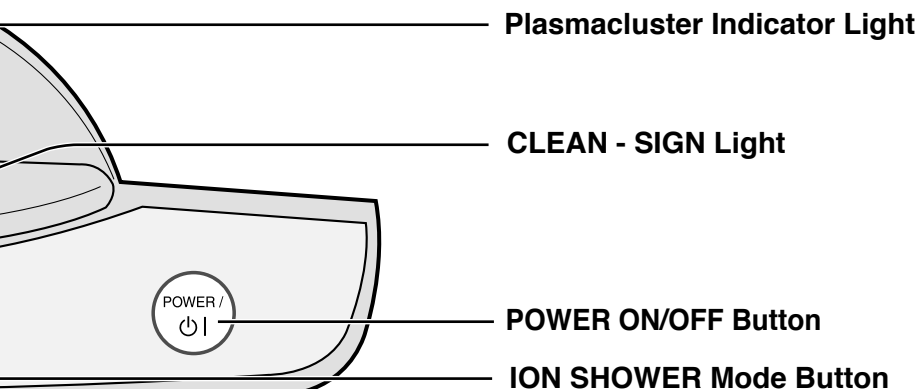

ION SHOWER Mode Button

When pushing the ION SHOWER Mode button, the ION SHOWER operation will be activated. (Direct start is available even when the unit is not turned on.)

The concentrated Plasmacluster Ions (ION SHOWER) will be generated in the room like a shower for 15 minutes, repeating the airflow cycles between strong and gentle. (The Plasmacluster Indicator Light repeats its colour cycles between blue and green.), and effectively controls the airborne dust, pollen, mold, and allergen.

- When the operation finishes, the unit will return to the prior operation.
- When pushing the ION SHOWER button while the ION SHOWER operation mode is working, the unit will return to the prior operation.



Plasmacluster Ion Mode Selection Button

The Plasmacluster Ion mode can be switched.

AUTO

The unit will switch between Clean Mode and the Ion Control Mode* automatically depending on the amount of impurities in the air as detected by the dust and odour sensors. Clean Mode will operate for 10 minutes when the Auto function is selected.

CLEAN ⊕⊖⊕⊖

The unit will constantly operate in the Clean Mode, in which the same numbers of positive and negative ions are discharged. The Plasmacluster Indicator Light is blue.

OFF

The generation of ions will stop and the Plasmacluster Indicator Light will go out.

*Ion Control Mode
Negative ions will be released in an increased rate and controls the ion balance.

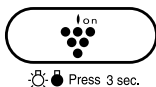

LIGHTS ON/OFF Button

(Please press the Plasmacluster Ion Mode Selection Button for 3 seconds.)
Switches the Plasmacluster Indicator Light and CLEAN-SIGN Light either ON or OFF.

CARE AND MAINTENANCE

To maintain optimum performance of this air purifier, please clean the unit including the sensor and filters periodically.

When cleaning the unit, be sure to unplug the power cord, and never handle the plug with wet hands. Electrical shock and/or bodily injury may occur as a result.

MAIN UNIT

Care Cycle 1 month

To prevent dirt or stains on the main unit, clean as often as necessary. If stains are allowed to remain, they may become hard to clean.

Wipe with a dry, soft cloth

For stubborn stains or dirt, use a soft cloth dampened with warm water.

Do not use volatile fluids

Benzene, paint thinner, polishing powder, etc., may damage the surface.

Do not use detergents

Detergent ingredients may damage the unit.

Keep the unit away from water

FILTER

Care Cycle 2 months

Clean the top surface of the Washable Active Carbon Filter lightly with a vacuum cleaner.

Washable Active Carbon Filter

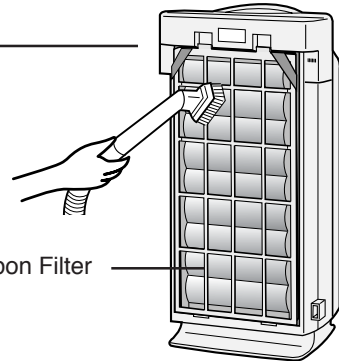

SENSORS (DUST SENSOR, ODOUR SENSOR)

Care Cycle 2 months

Remove dust from the surface of the hole of the sensors using a vacuum cleaner.

SENSOR FILTER CARE

(The sensor Filter is in the sensor cover.)

Detach the sensor filter and tap it lightly with your hand to remove the dust.

If it is very dirty, wash it with water and then allow it to dry thoroughly.

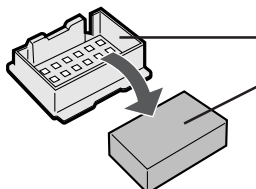

Sensor Cover

Sensor Filter
It does not have a front and a back.

Sensor Cover

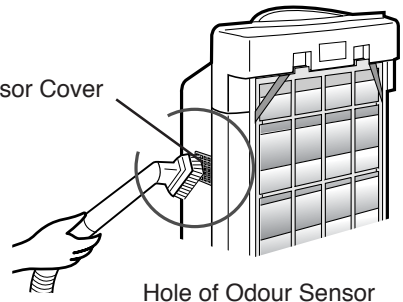

Hole of Odour Sensor

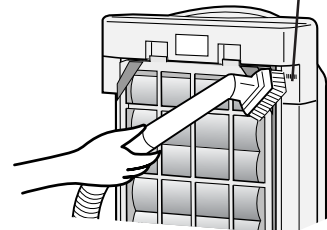

WASHABLE ACTIVE CARBON FILTER CARE

Care Cycle 2 months

HAND WASH ONLY!
DO NOT TUMBLE DRY!

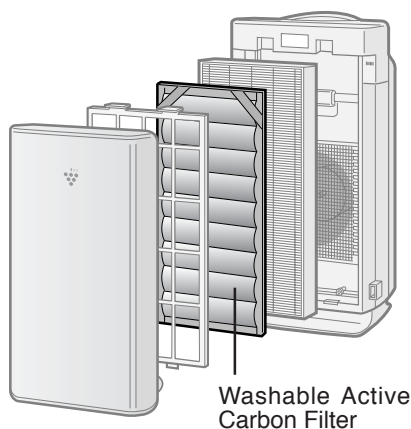

- 1** Fill a large container with lukewarm water, add a mild kitchen detergent and stir.

Dilute as indicated on the detergent container.



- 2** Allow the filter to soak approximately 10 minutes before washing.

If the filter surface is very dirty, scrub with an old toothbrush.



- 3** Rinse thoroughly with clean water.

CAUTION

If rinsing in a container, be sure to rinse 3 to 4 times so that the odour is rinsed thoroughly from the filter.



- 4** Remove excess water.

The filter will be saturated with water after rinsing. To decrease drying time, wrap the filter in an old thick towel so that excess water can be removed.

CAUTION

Some carbon may adhere to the towel, but it is harmless.

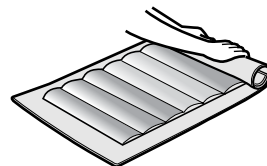

- 5** Dry the filter outdoors if possible in a well ventilated area.

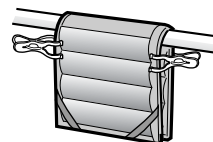

CAUTION

- The wet filter is heavy. Fix it securely for drying to make sure it does not fall down.
- The filter takes longer time to dry in winter, on rainy days. Wash it on a day when the weather is good and dry it in the sun. Move it indoors at night to prevent freezing.
- Dry the filter outdoors in a well ventilated area. If dried indoors, the water dripping off the filter may soil your floor.
- Make sure that the activated carbon has not shifted to one side of the filter. If it has, distribute it evenly with your fingers.
- Let the filter dry thoroughly. If used while the filter is still moist, then the air that is exhausted from the main unit will have an odour. It may take 1 or 2 days to dry.

- 6** Reinstalling the Filters.

Reinstall the filters as shown on Page E-6,7

CARE AND MAINTENANCE

FILTER REPLACEMENT GUIDELINES

The replacement period differs depending on the room environment, the usage hours and location of the Air Purifier.

If dust or odours persists, replace the filters.

(Refer to “Please read before operating your new Air Purifier”)

HEPA Filter / Washable Active Carbon Filter

Up to 5 years after opening

Guide for filter replacement timing

- Filter life can be greatly reduced in poor environment.
The presence of cigarette smoke, pet dander and other concentrations of airborne particles will cause filters to become clogged in less time. Please check filters regularly and replace as needed.

Replacement Filters

Model	• HEPA Filter : 1 unit
FZ-S51SEF	• Washable Active Carbon Filter : 1 unit

REPLACING THE FILTERS

1. See page E-6,7 for directions on how to install the filters when replacing.
2. Fill in the usage start date of the filters on the Date Label.

Disposal of Filters

Please dispose of replaced filters according to the local disposal laws and regulations.

HEPA Filter Materials:

- Filter: Polypropylene
- Frame: Polyester

Active Carbon Filter Materials:

- Deodorizer: Activated charcoal
- Net: Polypropylene 60%, Polyester 40%

SPECIFICATIONS

Model		FU-S51A		
Power supply		220V 50Hz		
Fan Speed Operation	Fan Speed Adjustment	MAX	MED	SILENT
	Rated Power	46 W	8.6W	3.7 W
	Air Flow Volume (m ³ /hour)	306	138	30
Applicable Floor Surface		~38m ² *1		
Cord Length		2.0m		
Dimensions		338mm(W)x207mm(D)x620mm(H)		
Weight		6.5kg		

- *1 • The applicable floor surface area is appropriate for operating the unit at maximum fan speed.
• Applicable floor surface area indicates the space where a certain amount of dust particles can be removed in 30 minutes.

Standby Power

In order to operate the electrical circuits while the power plug is inserted in the wall outlet, this product consumes about 0.7W of standby power.
For energy conservation, unplug the power cord when the unit is not in use.

TROUBLESHOOTING

Before calling for repair, please review the list below, since the problem may not be a unit malfunction.

SYMPTOM	REMEDY (not a malfunction)
Odours and smoke are not removed.	<ul style="list-style-type: none"> • Clean or replace the filters if they appear to be heavily soiled. (Refer to E-11, E-12)
The CLEAN-SIGN Light lights green even when the air is impure.	<ul style="list-style-type: none"> • The air could be impure at the time the unit was plugged in. (Refer to E-5) Pull out the plug from the electrical outlet, and insert the plug one minute later.
The CLEAN-SIGN Light lights yellow or red even when the air is clean.	<ul style="list-style-type: none"> • The sensitivity of the sensors become unstable when the opening of the odour sensor or dust sensor is dirty or is clogged. Clean the dust around the sensor opening using a vacuum cleaner. (Refer to E-10)
The Plasmacluster Indicator Light remains green (or blue) and does not change.	<ul style="list-style-type: none"> • When in Ion Control Mode (or Clean Mode), the Plasmacluster Indicator Light colour will not change.
A clicking or ticking sound is heard from the unit.	<ul style="list-style-type: none"> • Clicking sound is emitted when the unit is in the Ion Control Mode, and ticking sound is emitted when the unit is generating ions. If the sound is irritating, set the unit away from you.
The discharged air has an aroma or odour.	<ul style="list-style-type: none"> • Check to see if the filters are heavily soiled. Replace the filters. • Plasmacluster Air Purifiers emit small traces of ozone which may produce an odour. These ozone emissions are well below safety levels .
The unit does not operate when cigarette smoke is in the air.	<ul style="list-style-type: none"> • Is the unit installed in a location that is difficult for the sensor to detect cigarette smoke? • Are the dust or odour sensor openings blocked or clogged? (In this case, clean the openings.) (Refer to E-10)
The Plasmacluster Indicator Light or the CLEAN-SIGN Light will not activate.	<ul style="list-style-type: none"> • Check to see if the Lights OFF Mode is selected. If so, then press the Plasmacluster Ion Mode Selection Button for 3 seconds to activate the indicator lights. (Refer to E-9)
Plasmacluster Indicator Light (repeats colour cycles between blue and green)	<ul style="list-style-type: none"> • The ION SHOWER operation is working.

ENGLISH

ERROR DISPLAY

LAMP INDICATION	REMEDY
The "Silent" Fan Speed Indicator Light blinks.	<p>Fan motor disconnected or abnormal. Operation stops.</p> <ul style="list-style-type: none"> • Pressing the POWER ON/OFF button will reset the error display, but if error occurs again, contact the Sharp Service Centre.

聲寶空氣清新機操作原理

空氣清新機經吸氣口吸入室內空氣，使其通過機內的活性炭過濾網（除臭過濾網）和HEPA過濾網（集塵過濾網），然後從吹出口排出。空氣清新機通過其內部風扇的運行不斷重複此過程。

當空氣通過時，HEPA過濾網能夠除去灰塵粒子達百份之99.97（過濾0.3微米之微塵粒子時）。當異味成分多次經過活性炭過濾網時，便逐步被吸收。（異味成分也被HEPA過濾網吸收）

有些已被過濾網吸收的異味成分可能會離開過濾網並經吹出口被排出，因而產生額外的異味。根據不同的使用環境，尤其是這產品應用於比家居使用環境嚴重的情況下，這些異味可能在比預期更短的時間內變得強烈。如異味持續，表示過濾網已完全耗盡，請選購過濾網更換配件。

注意

- 本空氣清新機用於去除空氣中懸浮的灰塵和異味，而不能去除有害氣體（如：香煙煙霧中的一氧化碳）。如果異味的源頭依然存在，異味將不能徹底去除（如：來自建築材料或寵物身上的異味）。
- 建議吸煙時將窗戶稍微打開，以便空氣流通。

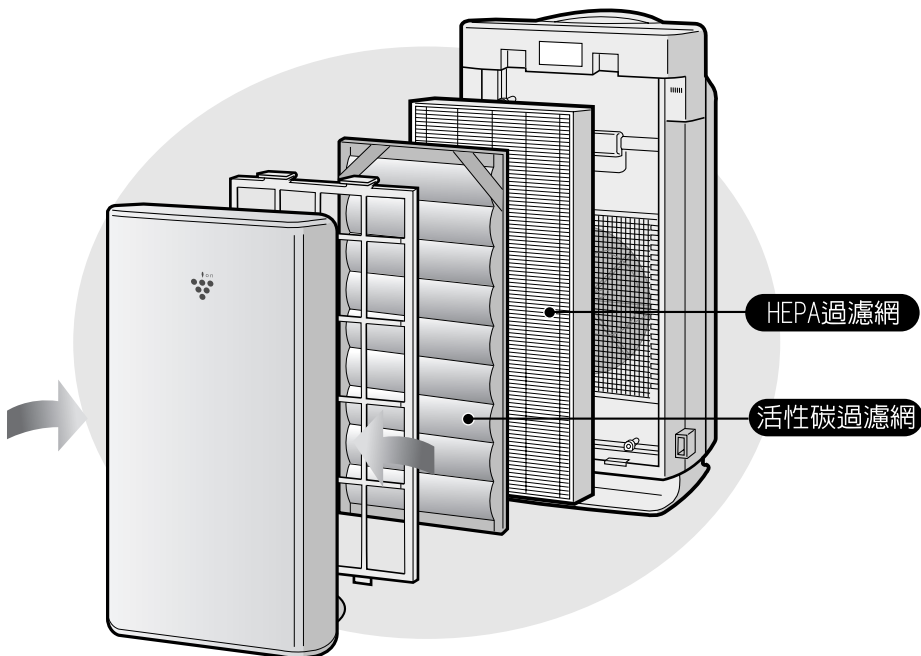

特點

強力離子簇除菌

新的強力離子簇除菌操作模式會放出高密度的離子簇，並且有效除去花粉和霉菌，控制空氣中的病毒、霉菌和過敏原的活動。

離子簇控制

您的新空氣清新機根據室內空氣狀況控制負離子和正離子的比例。

• 淨化模式

釋放出大約同等數量的正離子和負離子。

• 自動離子簇模式

本機將根據灰塵和異味感應器感測空氣的污濁程度，從而自動轉換為淨化模式或離子控制模式*。

* 離子控制模式

負離子會以增加的比率釋放並控制離子的平衡。

• 過濾網

1) 可清洗的活性碳過濾網

吸收異味成份。

清洗本過濾網可維持其最佳的除臭效能。

2) 配備微生物控制的HEPA(高效能微塵)過濾網

過濾網可高效吸附微粒，包括花粉和灰塵。

目錄

重要安全事項	C-2
• 警告	C-2
• 操作注意事項	C-3
• 安裝指南	C-3
• 過濾網指南	C-3
各部份名稱	C-4
• 主機部份	C-4
• 分解圖	C-4
• 背部	C-5
• 附件	C-5
準備工作	C-6
• 安裝過濾網	C-6
操作	C-8
• 主機操作	C-8
保養與清潔	C-10
• 主機	C-10
• 過濾網	C-10
• 感應器	C-10
• 保養可清洗的活性碳過濾網	C-11
• 過濾網更換指南	C-12
規格	C-12
維修前的檢查事項	C-13

多謝您購買聲寶空氣清新機。請仔細閱讀此說明書，以瞭解正確使用資訊。使用本產品之前，請務必閱讀“重要安全事項”這一節。閱讀後請妥善保管此說明書以便日後查閱。

重要安全事項

使用電器時，必須遵守基本安全預防措施，包括以下各方面：

警告– 為了減少電擊、火災或受傷等危險：

- 在使用空氣清新機之前請閱讀所有注意事項。
- 只能使用220V插座。
- 如果電源線或插頭已經損壞，或者牆上的電源插座已鬆脫，請勿使用空氣清新機。
- 定期清除電源插頭上的灰塵。
- 請勿將手指或異物插入吸氣或吹出口。
- 當拔掉電源插頭時，必須緊握插頭而不要拉扯電線。
否則可能導致電擊或因短路引起火災。
- 手濕時請勿拔掉電源插頭。
- 在氣體設備或壁爐附近請勿使用空氣清新機。
- 清潔本機或不使用本機時，請將插頭從牆上的電源插座上拔掉。
否則可能導致因絕緣不良而引起電擊或因短路而引起火災。
- 如果電源線損壞，必須由製造商或其代理、聲寶公司特約維修機構或具有同等資格的人員負責更換，以免發生危險。
- 當使用噴霧殺蟲劑時請勿使用本機，或房間內有油渣、焚香時的煙、點煙時的火苗、空氣中有化學氣味或浴室等濕氣很重的地方也不要使用本機。
- 清潔空氣清新機時請加以小心。具強力腐蝕性的清潔劑會損壞本機表面。
- 只有聲寶特約維修人員方可維修本空氣清新機，當需要調校、修理或出現問題時，請聯絡就近的維修機構。

注意– 收音機或電視干擾

如果本空氣清新機對收音機或電視接收造成干擾，請嘗試以下列其中一項或多項措施修正干擾：

- 重新調整或重新放置接收天線。
- 增加空氣清新機和收音機/電視接收器的距離。
- 將本設備的電源與接收器的電源連接到不同的插座。
- 如需協助，請聯絡經銷商或專業的收音機/電視技術人員。

重要安全事項

操作的注意事項

- 請勿堵塞吸氣口和吹出口。
- 不要靠近或在熱源物體上(如爐灶或暖爐式可能接觸到蒸汽的場所)使用本機。
- 使用時請勿平放本機。
- 移動本機時，須一直緊握主機後邊的手柄。
移動時若握住前面板可能導致前面板脫落，致使主機墜落，造成人身傷害。
- 請勿在沒有過濾網的情況下操作本機。
- 請勿清洗和再用HEPA過濾網。
- 只能使用軟布清潔本機表面。
否則本機可能會損壞或破裂。
此外，還可能導致感應器故障。

安裝指南

- 操作本機時，請將本機置於帶有電波的設備(如電視機、收音機或時鐘)至少2米以外。以防產生電波干擾。
- 請勿安裝在感應器直接對住風口的地方。
否則可能會影響本機正常工作。
- 請勿安裝在窗簾等物件可能會接觸到吸氣口或吹出口的地方。
否則該物件可能會被污染或導致本機故障。
- 請勿安裝在由於溫度劇烈變化而導致本機直接暴露於冷凝環境的地方。
(在5至35度室溫的適當情況下使用。)
- 安裝必須穩固，且通風良好。
把本機放置在鋪有厚地毯的地方時，可能導致本機微微震動。
- 請勿安裝在會產生黑煙的地方(如廚房等)。
否則可能會導致本機表面破裂或感應器故障。
- 遠離牆壁大約60厘米。
排氣口後邊的牆壁可能會隨著時間變髒，當在同一位置長時間使用本機時，請在牆上貼一張軟膠墊，以免牆壁變髒。此外，請可以定期清潔牆壁。

過濾網指南

- 遵照說明書指示，了解正確保養和清潔過濾網的方法。

各部份名稱

主機部份

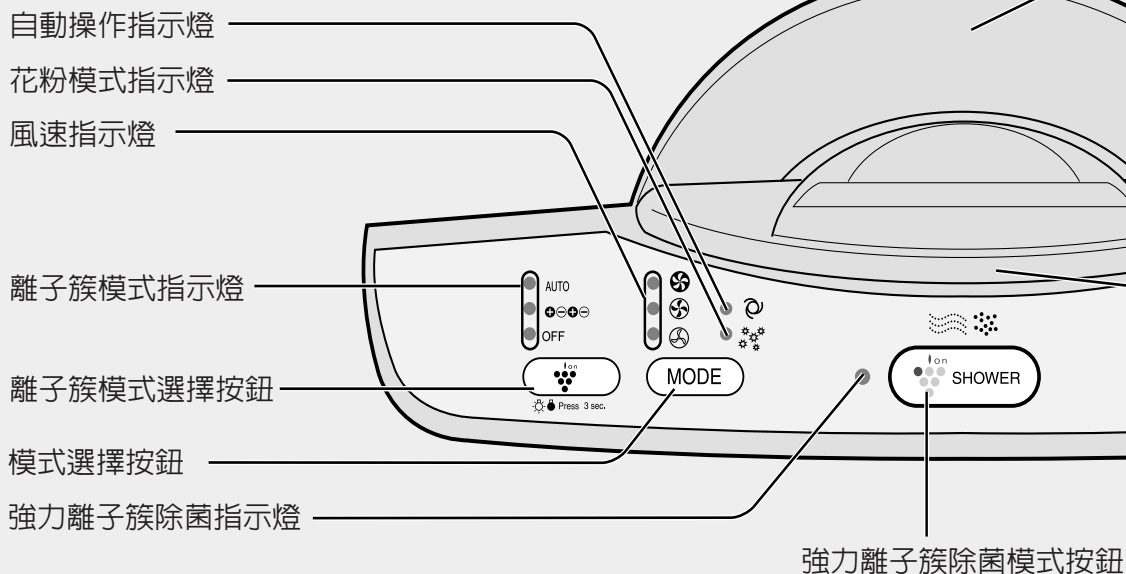

分解圖

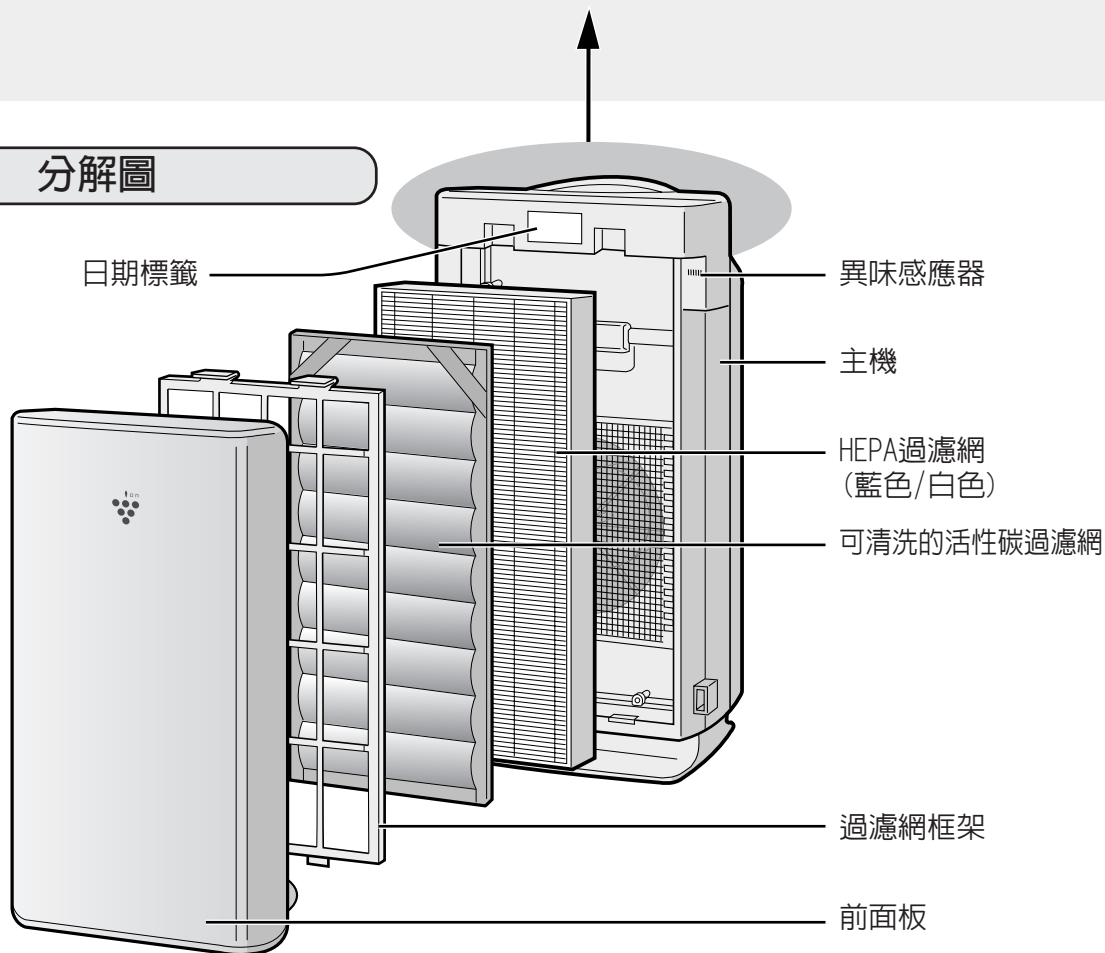

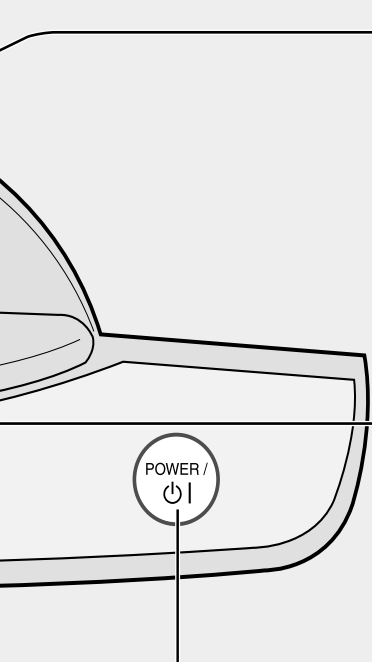

離子簇指示燈

(請參見C-9頁)

藍燈

當離子簇以淨化模式操作或者處於自動操作模式而室內空氣污濁時，藍色指示燈會點亮，主機將以「淨化模式」操作。

綠燈

當離子簇以自動模式操作而室內空氣潔淨時，綠色指示燈會點亮，主機將以「離子控制模式」操作。

藍燈和綠燈交替顯示

當離子簇操作正處於「強力離子簇除菌」模式，離子簇指示燈會以藍燈和綠燈交替顯示。

淨化度指示燈

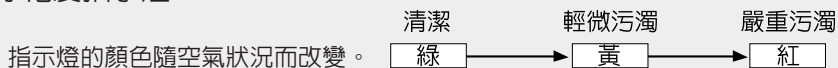

關於淨化度

- 通電時，淨化度狀態取決於灰塵和異味感應器所感測到的空氣狀況。
- 空氣清新機首次搬入房內使用時，即使房間內空氣有雜質，淨化度指示燈仍有可能顯示為綠色。但一段時間之後，空氣清新機將會調整雜質比率基準，並準確感測室內空氣狀況。

確定污濁比率基準

通電後30秒內，主機會檢查空氣狀況，如果此時處於操作狀態，淨化度指示燈將會以綠色、黃色和紅色交替閃爍。

電源開/關按鈕

中文

背部

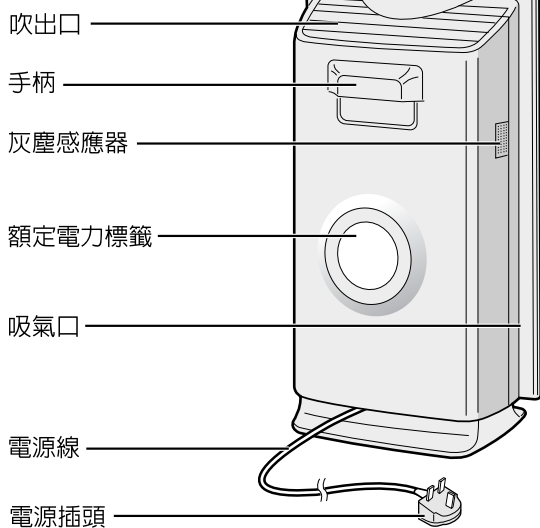

附件

- 使用說明書

安裝過濾網

為確保過濾網的質量，過濾網以塑膠袋包裝安裝在主機中。
使用本機前，須將過濾網從塑膠袋中取出。

1 取出過濾網

- 1 取下前面板。
拉住前面板的底部，然後往上掀起。

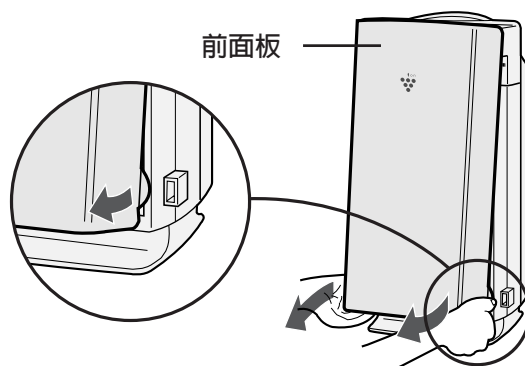

- 2 取出過濾網框架。
按下在頂部的鉤扣，然後拉起過濾網框架。

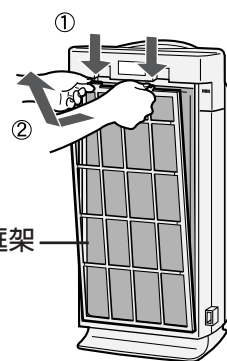

- 3 取出HEPA過濾網。

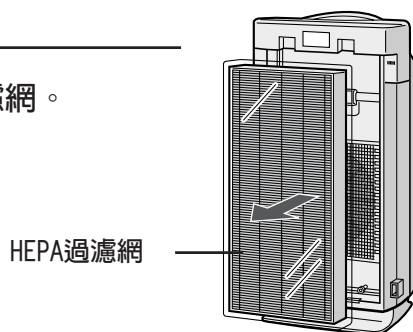

- 4 從塑膠袋中取出HEPA過濾網。

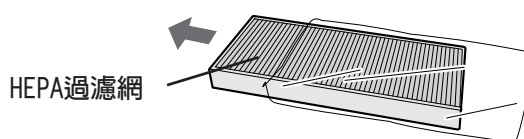

- 5 從紙盒中取出活性炭過濾網，然後從塑膠袋中取出。

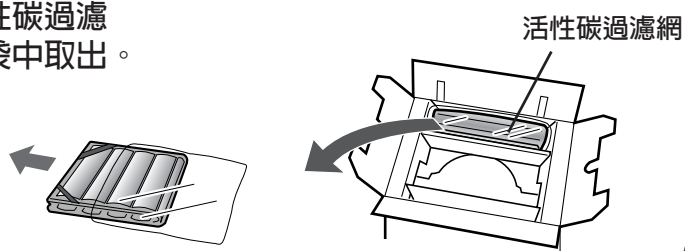

(打開時)

2 安裝過濾網

1 將HEPA過濾網放進主機內。

確定依正確的方向放置HEPA過濾網 (藍色) 及頁片。

請勿以反方向安裝過濾網，否則將影響本機正常操作。

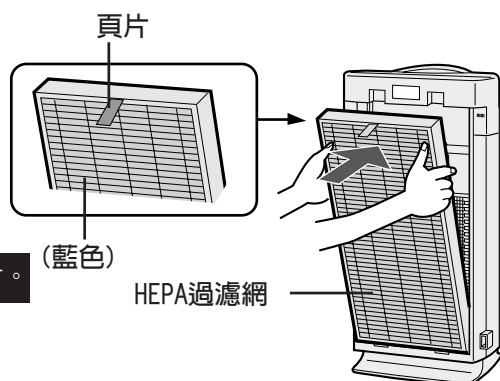

2 將過濾網框架插入位於活性炭過濾網左右兩角的彈力帶(2根)內。

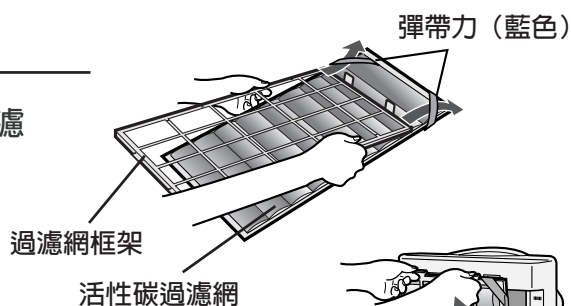

3 將過濾網框架裝回主機內。

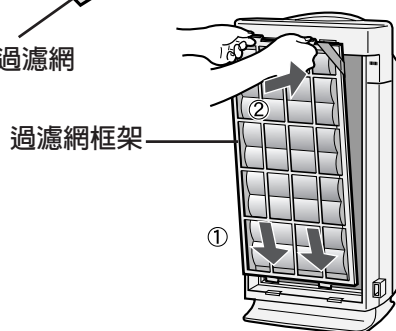

4 在日期標籤上填上開始使用的日期。

該日期將作為日後過濾網更換的時間參考。

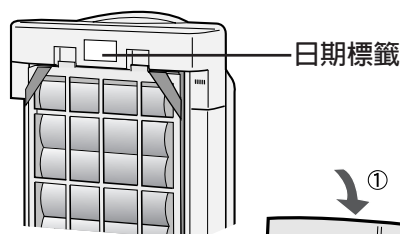

5 裝回前面板。

以向上傾斜的方向安裝前面板，然後裝入底部的鉤扣上。

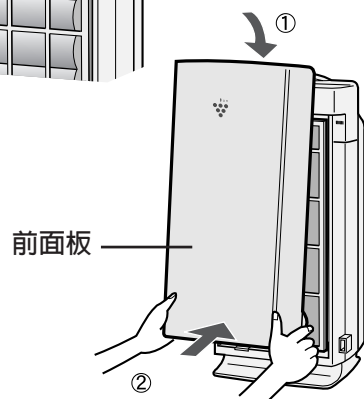

操作

主機操作

模式選擇按鈕

離子簇模式選擇
按鈕

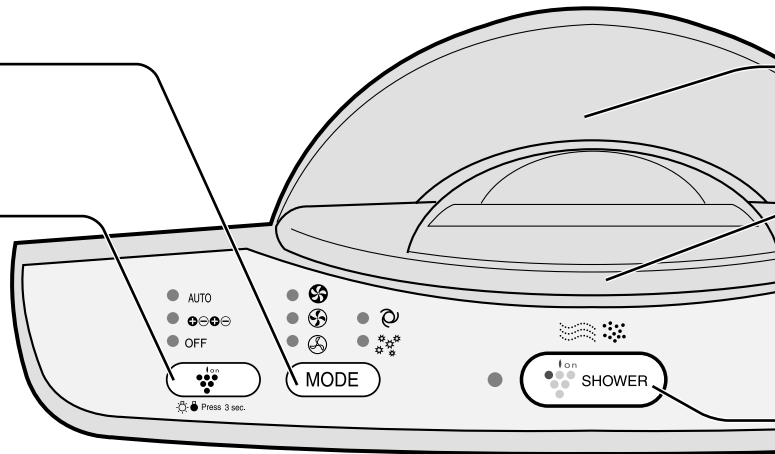

電源開 / 關按鈕

- 用於開始操作本機（短嗶聲）和停止操作本機（長嗶聲）。
- 離子簇指示燈和風速指示燈開/關。
- 除非拔掉電源，否則主機啟動後將維持前一次的操作模式。
- 在「強力離子簇除菌」模式進行時，按電源開/關按鈕停止操作後，再按一次該按鈕，主機將返回前一次的操作模式。

MODE

模式選擇按鈕

- 可切換操作模式。

自動操作

風速將根據空氣污染含量自動切換（高風速*、標準、靜音）。感應器將感測空氣污濁程度，以便有效地淨化空氣。

花粉模式操作

主機以高風速*操作10分鐘，之後交替地以20分鐘標準和高風速*模式操作。

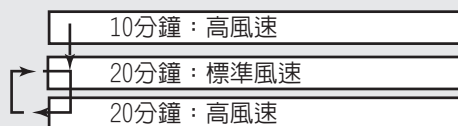

* 高風速是介於標準和最大之間的風速。

靜音操作

本機將以最小吸氣量寧靜地操作。

標準運轉

本機將以標準風速操作。

最大風速操作

本機將以最大風速操作。

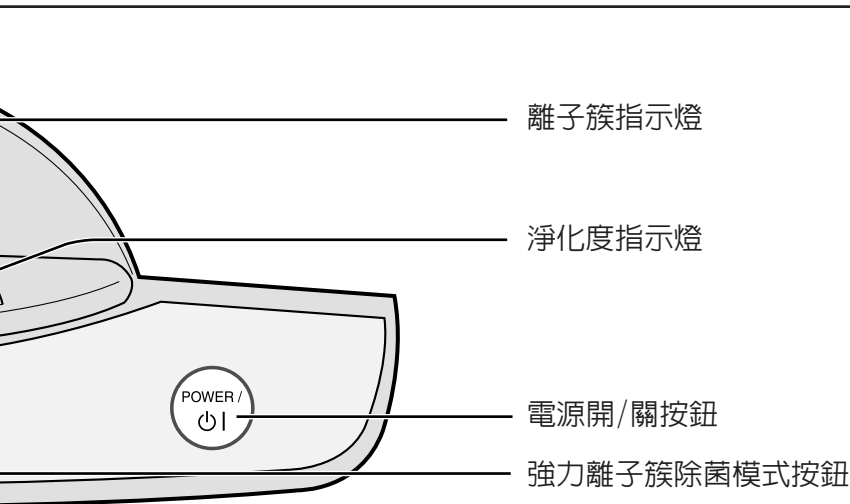

強力離子簇除菌模式按鈕

按下「強力離子簇除菌」模式按鈕時，將會啟動「強力離子簇除菌」操作。(即使在未開啓本機電源時也可以直接啟動。)

高密度的離子簇(強力離子簇除菌)將以類似淋浴的方式在室內釋放15分鐘，重複以強烈和溫和的氣流循環吹動。(離子簇指示燈循環亮起藍色和綠色。)而且有效抑制空氣中的灰塵、花粉、霉菌和過敏原。

- 完成此操作後，本機將回復之前的操作。
- 在強力離子簇除菌模式正在操作時按下「強力離子簇除菌」按鈕，本機將返回前一個操作模式。

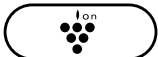

離子簇模式選擇按鈕

可切換離子簇選擇模式。

自動 (AUTO)

本機將會根據灰塵和異味感應器所感測的空氣污濁程度而在淨化模式和離子控制模式*之間自動轉換。當選擇了自動功能時，淨化模式將會操作10分鐘。

淨化 (⊕⊖⊕⊖)

按此按鈕，本機將持續以淨化模式操作並釋放出相等數量的正負離子。離子簇指示燈為藍色。

關 (OFF)

將停止產生離子，且離子簇指示燈熄滅。

* 離子控制模式
負離子會以增加的比率釋放並控制離子的平衡。

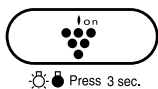

指示燈開 / 關按鈕

(請按離子簇模式選擇按鈕3秒鐘。)

開啓或關掉離子簇指示燈和淨化度指示燈。

保養與清潔

為了保持本空氣清新機的最佳效能，請定期清潔本機，包括感應器和過濾網。
清潔本機時，務必拔掉電源線，而且決不可以用濕手觸摸電源插頭。否則可能會導致電擊和/或受傷。

主機

保養週期 1 個月

為防止主機積聚灰塵或污垢，需經常清潔主機。否則，頑固的污漬將變得難以清洗。

使用柔軟乾布擦拭

對於頑固污漬，使用一塊溫水浸泡過的軟布擦拭。

請勿使用揮發性液體

苯、油漆稀釋劑以及打臘粉等皆有可能損壞主機表面。

請勿使用清潔劑

清潔劑成分可能會損壞主機。

請讓主機遠離水源

過濾網

保養週期 2 個月

用吸塵機輕輕清潔可清洗的活性碳過濾網的表面。

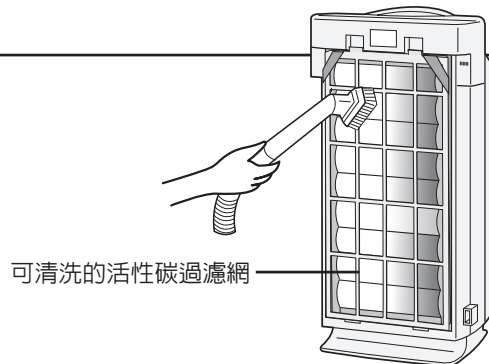

感應器 (灰塵感應器、異味感應器)

保養週期 2 個月

使用吸塵機清除感應器小孔表面的灰塵。

保養感應器過濾網

(感應器過濾網在感應器蓋子內。)

拆除感應器過濾網，然後用手輕拍以除去灰塵。

如果非常骯髒，請用水清洗，然後讓它徹底風乾。

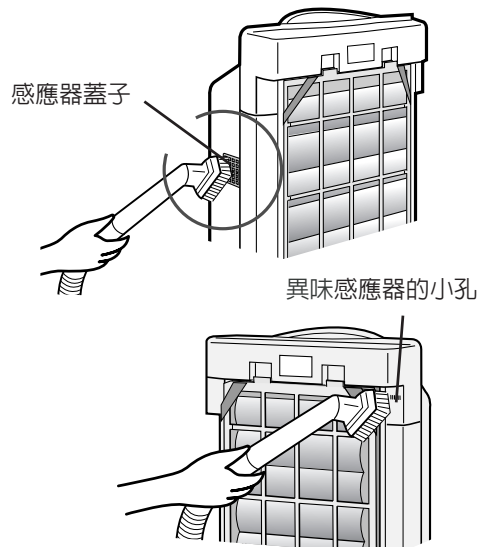
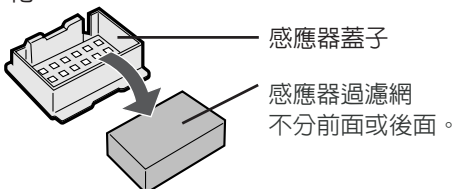

可清洗的活性炭過濾網的保養

保養週期 2 個月

只能手洗！
嚴禁烘乾！

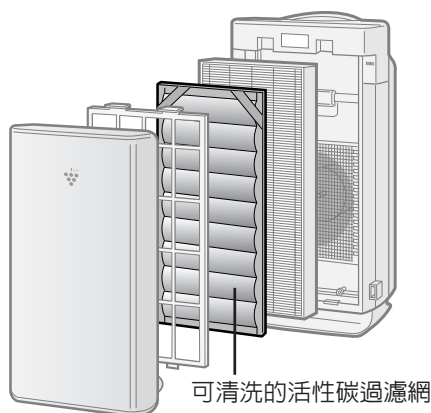

1 用大容器盛滿溫水，然後加入溫和的廚房清潔劑並攪拌。

按照清潔劑包裝指示進行稀釋。



2 清洗前將過濾網浸泡約10分鐘。

如果過濾網表面過髒，用一個舊牙刷進行擦洗。



3 用清水徹底沖洗。

注意

如果在容器內沖洗，必須沖洗3至4次，以便徹底去除過濾網異味。



4 除去多餘的水。

沖洗過後過濾網會濕透，為減少風乾時間，請用一條舊的厚毛巾包裹過濾網，吸去多餘水分。

注意

一些活性炭可能會吸附在毛巾上，但是對身體無害。

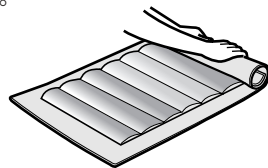

5 若可能的話，在室外通風良好處曬乾過濾網。

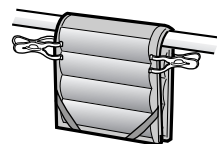

注意

- 濕的過濾網會較重，曬乾時將其穩固地固定，防止跌下。
- 冬天或雨天可能會需要較長時間乾燥。最好在天氣好時清洗過濾網，並將其曬乾。晚上要將其移入屋內，以防凍結。
- 在室外通風良好的地方曬乾過濾網，若在屋內晾乾，滴水可能弄髒地板。
- 確保活性炭沒有傾移到過濾網的一側。若有，檢查並用手指使其平均地分佈。
- 讓過濾網徹底風乾。如果於過濾網還未乾透時使用，主機排出的空氣將有異味。大約需要1至2日風乾過濾網。

6 重新安裝過濾網。

按照第C-6、7頁的圖示重新安裝過濾網。

更換過濾網指南

更換時間視乎使用的房間環境、使用時間長短和空氣清新機的位置而定。
如果灰塵或異味仍然存在，請更換過濾網。

(請參閱「操作您的新空氣清新機之前，請詳細閱讀本手冊」)

HEPA過濾網/可清洗的活性碳過濾網

打開後最多可使用5年

更換過濾網指南

- 惡劣環境會大幅降低過濾網使用的壽命。
香煙煙霧、寵物毛髮和其他濃縮的懸浮粒子將會使過濾網更快堵塞。請定期檢查過濾網，有需要時請更換。

更換用的過濾網

型號 FZ-S51SEF

- HEPA過濾網：1件
- 可清洗的活性碳過濾網：1件

更換用的過濾網

- 有關更換過濾網的安裝指示，請參閱第C-6、7頁。
- 在日期標籤上填寫過濾網開始使用的日期。

棄置過濾網

請按照當地法律規定來處理已使用的過濾網。

HEPA過濾網材料：

- 過濾網：聚丙烯
- 外框：聚酯

活性碳過濾網材料：

- 除臭劑：活性碳
- 網：60%聚丙烯，40%聚酯

規格

型號		FU-S51A		
電源		220伏 / 50赫茲		
風速 操作	風速調整	最大	標準	靜音
	額定功率	46 瓦	8.6 瓦	3.7 瓦
	空氣流量 (立方米 / 小時)	306	138	30
適用面積		~38平方米*1		
電源線長度		2.0米		
尺寸		338毫米(闊)x207毫米(深)x620毫米(高)		
重量		6.5公斤		

*1 • 適用面積是以最大風速操作本機的面積計算。

- 適用面積表示可在30分鐘內清除一定數量灰塵粒子的空間大小。

關於備用耗電量 當電源插頭插入插座時，本機在備用狀態下的耗電量為0.7瓦。為節省用電，在不使用本機時請拔掉電源接線。

維修前的檢查事項

在要求修理之前，請檢查下列症狀，因為有些問題可能不是本機故障而引起的。

症狀	補救措施（並非故障）
不能去除異味和煙霧。	<ul style="list-style-type: none"> 如果過濾網已很髒，請清潔或更換。（參見C-11、C-12頁）
即使空氣污濁時，淨化度指示燈依然為綠色。	<ul style="list-style-type: none"> 清新機剛接通電源時空氣可能污濁。（參見C-5頁）從電源插座上拔掉插頭，一分鐘後再次插入插頭。
即使空氣潔淨時，淨化度指示燈依然為黃色或紅色。	<ul style="list-style-type: none"> 當異味感應器和塵埃感應器開口處變髒或堵塞時，其靈敏度將會變得不穩定。使用吸塵機除去感應器開口周圍的灰塵。（參見C-10頁）
離子簇指示燈持續為綠色（或藍色），沒有變化。	<ul style="list-style-type: none"> 在離子控制模式（或淨化模式）下，離子簇指示燈顏色將不會改變。
主機發出喀嚓/滴答聲。	<ul style="list-style-type: none"> 當本機處於離子控制簇模式時會發出喀嚓聲，當本機在釋放離子時會產生滴答聲。如果您感到此聲音煩擾，可將本機置於遠處。
排放的空氣有氣味或異味。	<ul style="list-style-type: none"> 檢查過濾網是否已很髒。 更換過濾網。 離子簇空氣清新機釋放少量臭氧，可能會產生異味。這臭氧的釋放量很少，遠低於安全標準。
即使空氣中有煙霧時，本機也不操作。	<ul style="list-style-type: none"> 本機是否安裝在感應器難以感測到煙霧的地方？ 塵埃或異味感應器開口處是否被堵塞？（如果是，請清潔開口處）（參見C-10頁）
離子簇指示燈或淨化度指示燈不點亮。	<ul style="list-style-type: none"> 檢查是否已選擇指示燈關模式。如果是，請按離子簇模式按鈕3秒，以打開指示燈。（參見C-9頁）
離子簇指示燈（以藍燈和綠燈交替閃爍）	<ul style="list-style-type: none"> 強力離子簇除菌正在操作。

錯誤顯示

指示燈	補救措施
「靜音」風速指示燈閃爍。	<p>風扇馬達切斷或異常。 操作停止。</p> <ul style="list-style-type: none"> 按開 / 關按鈕將重設錯誤顯示，但是如果再次出現錯誤，請聯絡聲寶維修中心。

SHARP[®]
SHARP CORPORATION

Printed in Japan

TINS-A185KKRZ (JP) 05KK ①