

# Panasonic®

## Operating Instructions

### Digital HD Video Cassette Recorder

Model No. AJ-**HD1400**<sup>P</sup><sub>E</sub>

**DVCPRO HD**

**EX**

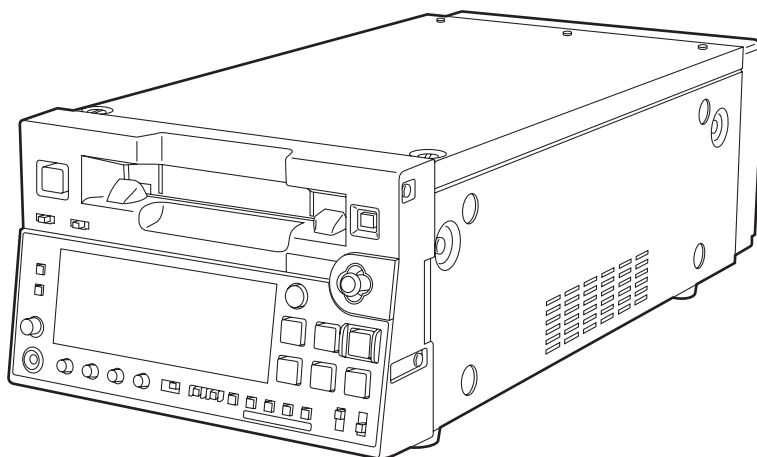

Before operating this product, please read the instructions carefully and save this manual for future use.

# Read this first!

For AJ-HD1400P and AJ-HD1400E

## ■ THIS APPARATUS MUST BE GROUNDED

To ensure safe operation the three-pin plug must be inserted only into a standard three-pin power outlet which is effectively grounded through normal household wiring.

Extension cords used with the equipment must be three-core and be correctly wired to provide connection to the ground. Incorrectly wired extension cords can be extremely hazardous.

The fact that the equipment operates satisfactorily does not imply that it is grounded, and the installation is not necessarily safe. For your safety, if in any doubt about the effective grounding of the equipment or power outlet, please consult a qualified electrician.

## CAUTION:

THE AC RECEPTACLE (MAINS SOCKET OUTLET) SHALL BE INSTALLED NEAR THE EQUIPMENT AND SHALL BE EASILY ACCESSIBLE. TO COMPLETELY DISCONNECT THIS EQUIPMENT FROM THE AC MAINS, DISCONNECT THE POWER CORD PLUG FROM THE AC RECEPTACLE.

## CAUTIONS:

In order to maintain adequate ventilation, do not install or place this unit in a bookcase, built-in cabinet or any other confined space. To prevent risk of electric shock or fire hazard due to overheating, ensure that curtains and any other materials do not obstruct the ventilation.

## CAUTIONS:

TO REDUCE THE RISK OF FIRE OR SHOCK HAZARD AND ANNOYING INTERFERENCE, USE THE RECOMMENDED ACCESSORIES ONLY.

## WARNING:

- TO REDUCE THE RISK OF FIRE OR SHOCK HAZARD, DO NOT EXPOSE THIS EQUIPMENT TO RAIN OR MOISTURE.
- TO REDUCE THE RISK OF FIRE OR SHOCK HAZARD, KEEP THIS EQUIPMENT AWAY FROM ALL LIQUIDS. USE AND STORE ONLY IN LOCATIONS WHICH ARE NOT EXPOSED TO THE RISK OF DRIPPING OR SPLASHING LIQUIDS, AND DO NOT PLACE ANY LIQUID CONTAINERS ON TOP OF THE EQUIPMENT.

 indicates safety information.

## IMPORTANT

“Unauthorized recording of copyrighted television programmes, video tapes and other materials may infringe the rights of copyright holders and contravene copyright laws.”

## Operating precaution

Operation near any appliance which generates strong magnetic fields may give rise to noise in the video and audio signals. If this should be the case, deal with the situation by, for instance, moving the source of the magnetic fields away from the unit before operation.

**For AJ-HD1400P**

	<b>CAUTION</b> <b>RISK OF ELECTRIC SHOCK</b> <b>DO NOT OPEN</b>	
<b>CAUTION: TO REDUCE THE RISK OF ELECTRIC SHOCK, DO NOT REMOVE COVER (OR BACK). NO USER SERVICEABLE PARTS INSIDE. REFER TO SERVICING TO QUALIFIED SERVICE PERSONNEL.</b>		



The lightning flash with arrowhead symbol, within an equilateral triangle, is intended to alert the user to the presence of uninsulated "dangerous voltage" within the product's enclosure that may be of sufficient magnitude to constitute a risk of electric shock to persons.



The exclamation point within an equilateral triangle is intended to alert the user to the presence of important operating and maintenance (service) instructions in the literature accompanying the appliance.

**Notice (U.S.A. only):**

This product has a fluorescent lamp that contains a small amount of mercury. It also contains lead in some components. Disposal of these materials may be regulated in your community due to environmental considerations. For disposal or recycling information, please contact your local authorities, or the Electronics Industries Alliance:  
<<http://www.eiae.org>>

**FCC Note:**

This equipment has been tested and found to comply with the limits for a class A digital device, pursuant to Part 15 of the FCC Rules. These limits are designed to provide reasonable protection against harmful interference when the equipment is operated in a commercial environment. This equipment generates, uses, and can radiate radio frequency energy, and if not installed and used in accordance with the instruction manual, may cause harmful interference to radio communications. Operation of this equipment in a residential area is likely to cause harmful interference in which case the user will be required to correct the interference at his own expense.

**Warning:**

To assure continued FCC emission limit compliance, the user must use only shielded interface cables when connecting to external units. Also, any unauthorized changes or modifications to this equipment could void the user's authority to operate it.

**CAUTION:**

This apparatus can be operated at a voltage in the range of 100 – 240 V AC. Voltages other than 120 V are not intended for U.S.A. and Canada.

**CAUTION:**

Operation at a voltage other than 120 V AC may require the use of a different AC plug. Please contact either a local or foreign Panasonic authorized service center for assistance in selecting an alternate AC plug.

 indicates safety information.

**<For USA-California Only>**

This product contains a CR Coin Cell Lithium Battery which contains Perchlorate Material — special handling may apply. See [www.dtsc.ca.gov/hazardouswaste/perchlorate](http://www.dtsc.ca.gov/hazardouswaste/perchlorate).

**For AJ-HD1400E**

## Caution for AC Mains Lead

**FOR YOUR SAFETY PLEASE READ THE FOLLOWING TEXT CAREFULLY.**

This product is equipped with 2 types of AC mains cable. One is for continental Europe, etc. and the other one is only for U.K.

Appropriate mains cable must be used in each local area, since the other type of mains cable is not suitable.

**FOR CONTINENTAL EUROPE, ETC.**

Not to be used in the U.K.

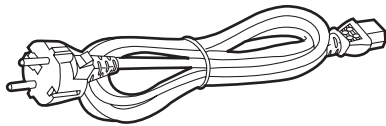

**FOR U.K. ONLY**

If the plug supplied is not suitable for your socket outlet, it should be cut off and appropriate one fitted.

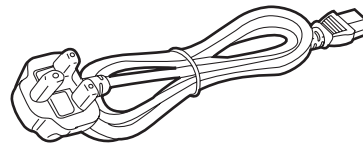

**FOR U.K. ONLY**

This appliance is supplied with a moulded three pin mains plug for your safety and convenience.

A 13 amp fuse is fitted in this plug.

Should the fuse need to be replaced please ensure that the replacement fuse has a rating of 13 amps and that it is approved by ASTA or BSI to BS1362.

Check for the ASTA mark  or the BSI mark  on the body of the fuse.

If the plug contains a removable fuse cover you must ensure that it is refitted when the fuse is replaced.

If you lose the fuse cover the plug must not be used until a replacement cover is obtained.

A replacement fuse cover can be purchased from your local Panasonic Dealer.

**IF THE FITTED MOULDED PLUG IS UNSUITABLE FOR THE SOCKET OUTLET IN YOUR HOME THEN THE FUSE SHOULD BE REMOVED AND THE PLUG CUT OFF AND DISPOSED OF SAFELY. THERE IS A DANGER OF SEVERE ELECTRICAL SHOCK IF THE CUT OFF PLUG IS INSERTED INTO ANY 13 AMP SOCKET.**

**How to replace the fuse**

1. Open the fuse compartment with a screwdriver.

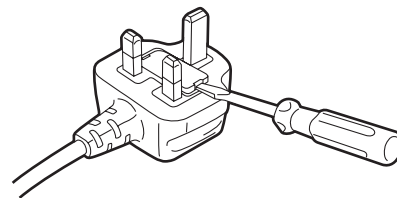

2. Replace the fuse.

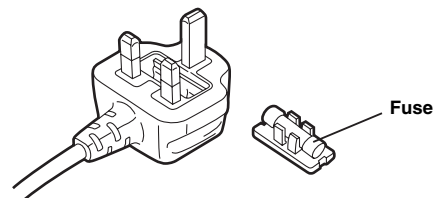

**■ DO NOT REMOVE PANEL COVERS BY UNSCREWING THEM.**

To reduce the risk of electric shock, do not remove the covers. No user serviceable parts inside. Refer servicing to qualified service personnel.

 indicates safety information.

# Contents

---

<b>Read this first!</b> .....	<b>2</b>	<b>Setup menus</b> .....	<b>32</b>
<b>Introduction</b> .....	<b>6</b>	Menu which are displayed .....	32
<b>Features</b> .....	<b>6</b>	SYSTEM .....	36
<b>Parts and their functions</b> .....	<b>9</b>	BASIC .....	37
Front panel (1) .....	9	Formats for playback .....	39
Front panel (2) .....	10	OPERATION .....	40
Front panel (3) .....	11	INTERFACE .....	43
Display panel .....	12	EDIT .....	44
Rear panel .....	14	TAPE PROTECT .....	45
<b>Reference signals</b> .....	<b>16</b>	TIME CODE.....	45
<b>Reference frequencies</b> .....	<b>17</b>	VIDEO .....	47
<b>Tapes</b> .....	<b>18</b>	AUDIO .....	51
<b>Connections</b> .....	<b>19</b>	DIF .....	53
Example of connections		MENU .....	54
with an editing controller .....	19	<b>Time code/user bits</b> .....	<b>55</b>
<b>IEEE1394 digital interface</b> .....	<b>20</b>	Timecodes recorded by this product .....	56
Settings for this unit .....	20	<b>Superimpose screen</b> .....	<b>57</b>
Precautions for use .....	20	<b>Video head cleaning</b> .....	<b>58</b>
<b>VANC data recording/playback</b> .....	<b>21</b>	<b>Condensation</b> .....	<b>58</b>
VANC data recording .....	21	<b>Maintenance</b> .....	<b>58</b>
VANC data playback.....	21	<b>Error messages</b> .....	<b>59</b>
<b>Joystick and</b>		DIAG menu .....	59
<b>Variable Speed Playback</b> .....	<b>22</b>	Displaying the DIAG menu .....	59
Joystick .....	22	Displaying the "HOURS METER" information ....	59
Variable Speed Playback.....	22	UMID information display .....	60
<b>PF (Programmable Function)</b> .....	<b>23</b>	Displaying the warning information.....	61
Performing operations using the PF buttons.....	23	Error messages .....	62
Operation using the PF buttons .....	23	<b>Emergency eject</b> .....	<b>64</b>
<b>Pause/Recording</b>		<b>Specifications</b> .....	<b>65</b>
<b>(Recording with pauses)</b> .....	<b>24</b>		
<b>Cue up</b> .....	<b>24</b>		
<b>Repeat playback</b> .....	<b>25</b>		
Setting the BEGIN and END points .....	25		
Setting the repeat playback mode .....	25		
<b>Recording from a variable frame rate</b>			
<b>camera</b> .....	<b>26</b>		
Recording the HD SDI output signal			
from a variable frame rate camera .....	26		
Field displacement .....	26		
<b>Setup (initial settings)</b> .....	<b>27</b>		
Setting method using the on-screen menus .....	27		
Returning to the factory settings .....	27		
Setting the user defaults .....	28		
User default loading method .....	29		
Menu protection method .....	30		
Menu protection release method .....	30		
System frequency switching .....	31		
Procedure for shifting the system frequency.....	31		

# Introduction

---

---

This unit is a multi-format VTR capable of recording and playing back HD signals (1080i/59.94 Hz, 1080i/50 Hz, 720P/59.94 Hz, 720P/50 Hz) in DVCPRO HD-LP format using a small cassette tape 1/4 inch wide, HD (DVCPRO HD/DVCPRO HD-LP\*) and SD (DVCPRO50/DVCPRO) recorded in DVCPRO format as well as conventional consumer DV/DVCAM tapes.

A down-converter as a standard feature verifies all tapes using analog composite signals and SD SDI output. Similarly, each of the following output signals can be obtained.

- 720/25p over 60p sources can be converted to 1080/25 PsF or 576i format output signals.
- 720/50p over 60p sources can be converted to 720/50p, 1080/50i or 576i format output signals.

The compact size and light weight of the unit enable it to be carried around and mounted in a standard rack with ease. You can perform the unit's settings interactively with the on-screen menus displayed on the TV monitor.

\* DVCPRO HD-LP has the same format as the DVCPRO HD EX described in the operation manual of our camera recorder.

## Features

---

---

### Compact size and light weight

The unit has a width of 214 mm (8-7/16 inches), a height of 132 mm (5-1/4 inches), and a depth of 442 mm (17-3/8 inches) (Protruding portion is not included), and weighs only 8.5 kg (18.74 lb).

Grips are also attached for easy carry.

### Efficient installation in a rack

The unit's width is one-half of 19 inches and its height is 3U: this translates into greater saving of installation space in a standard rack compared to conventional models.

### DVCPRO HD cassette tapes used

The unit uses 1/4-inch wide cassette tapes.

#### <Note>

When recording HD signals, use DVCPRO HD cassettes.

### High image quality

The unit achieves a high image quality by recording 4:2:2 HD component signals with a recording rate (=100 Mbps) which is four times as high as that for existing DVCPRO formats.

### 1080i or 720p, NTSC or PAL selectable

By switching the settings provided for the video signal input (1080i/59.94 Hz or 720p/59.94 Hz) on the setup menu, the unit can record and playback each signal and also playback NTSC SD material.

The unit also supports the PAL mode. Playback of 1080i/50 Hz, record and playback of 720P/50 Hz or playback of PAL SD materials is enabled by switching the setting on the system menu.

### Frame rate conversion

When playing back a tape recorded at a frame rate of 24 fps using a variable frame rate camera, the tape's signals can be converted to the 1080/24 PsF format and output by selecting a menu item setting.

When playing back a tape recorded at a frame rate of 25 fps, the tape's signals can be converted to the 1080/25 PsF or 576i format and output. When playing back a tape recorded at a frame rate of 50 fps, the tape signals can be converted to the 1080/50i or 576i format and output.

#### <Notes>

- Use tapes that are shot with a variable frame rate camera.
- Do not use dubbed or edited tapes. The tape control information may be lost, making it impossible to convert the signals for playback.

### DVCPRO-compatible playback

In addition to DVCPRO HD-LP playback, the unit can play back tapes recorded using the existing DVCPRO HD, DVCPRO50 and DVCPRO formats.

It can also play back consumer DV tapes (SP) and DVCAM tapes.

### SD down-converter

The unit comes with a built-in SD down-converter as a standard feature to enable the output of SD SDI signals and analog composite signals at the same time as HD SDI output signals and for monitoring the signals on an SD monitor.

### Up-convert function

When an SD format tape is played back, it is possible to output the signals in the HD SDI output and HD analog component signals while at the same time outputting them in SD format, since this unit includes the HD converter as a standard feature.

# Features (continued)

---

## Cross-convert function

The unit comes with a built-in cross-converter to enable 1080i/59.94 Hz format signals to be converted into 720p/59.94 Hz format signals or, conversely, to enable 720p/59.94 Hz format signals to be converted into 1080i/59.94 Hz format signals.

Cross-convert with 1080i/50 Hz and 720p/50 Hz is also possible.

## HD analog component output

This feature enables HD signals to be monitored with ease.

## Gamma correction of cinema for film

This feature corrects the image from a variable frame rate camera in cinema gamma mode for film to an image with film quality.

## AC/DC operation

The unit supports AC supply voltages ranging from 100V to 240V and DC12V power supply as well.

## Editing function

Using the 9-pin serial remote (RS-422A), assembly or insertion is allowed.

(Only with 1080i/59.94 Hz, 720P/59.94 Hz, 1080i/50 Hz, and 720P/50 Hz)

## Encoder remote controller function

Using the external encoder remote controller, each setting for the video output signal can be adjusted.

## Follow-on recording function

Using the REC button and PAUSE button together activates the auto back function, enabling the next image to follow on from the last image with no disruptions in the continuity.

## On-screen menu settings

Highly detailed and individualized function settings can be performed on-screen.

## Time code

The unit is equipped with a built-in time code generator/time code reader (TCG/TCR). Since time code signals can also be input from an external device, regeneration to an external time code is possible.

Since the backup function using a backup battery is incorporated in the TCG (time code generator), time codes during free-run operations are retained even if the power of the unit is turned off.

## Joystick and variable speed playback

The unit is equipped with a joystick (stick controller) for use of the search function during variable speed playback.

In addition, the joystick allows convenient setting of the onscreen menu/time code generator.

## PF (Programmable Function) button

The unit is equipped with three PF buttons. Selecting the three most frequently used setup menus, the menu settings can be changed with the buttons on the front panel.

## UMID information recording and playback

This unit supports the recording/playback of UMID (Unique Material Identifier) information in the SMPTE 330M standard. UMID information can be confirmed with the diagnostic menu.

VTRs that do not support the recording/playback of UMID information will not playback UMID information correctly. In addition, when VTRs that do not support recording/playback of UMID information are connected to this unit, UMID information will not be recorded correctly.

## VANC data recording/playback

VANC data packets that added to the Y stream of HD SDI can be recorded with the video signal. In addition, VANC data packets can be played back with the Y stream of HD SDI. This unit is capable of input and output through the IEEE1394 standard interface.

## AUTO REC Feature

This unit can be connected to our camera recorder using HD SDI signals. It is possible to remotely turn ON/OFF the recording feature of this unit by using overlapped commands.

# Features (continued)

---

## Multi-functional interfaces

### ● Serial digital input/output

The unit's HD component serial I/O interface enables interfacing with HD component video signals and 8-channel digital audio signals using a single BNC connector. (SMPTE 292M/296M/299M)

The unit is also equipped with an SD downconverter as a standard feature so that SD component serial signals can be output as well.

(SMPTE 259M-C, 272M-A, ITU-R BT.656-4)

### ● Analog video output

Since the unit's down-converter comes as a standard feature, the analog composite signals can be monitored on an SD monitor.

### ● 9-pin remote

The unit's 9-pin remote control connector enables it to be operated with an external remote controller.

### ● IEEE1394 digital input/output

Set to this position when controlling this unit with the AV/C command of the 9-pin REMOTE, REMOTE of HD SDI, IEEE1394.

#### <Playback formats and output formats>

Playback format	Output format
DVCPRO HD-LP, DVCPRO HD	DVCPRO HD, DVCPRO50, DV
DVCPRO50	DVCPRO50, DV
DVCPRO	DVCPRO, DV
DV, DVCAM	DV
In case of EE and REC modes: ● Select a value other than "1394" with the INPUT SELECT button on the front panel.	DVCPRO HD

#### <Note>

When any of the settings below is established, no signals will be output from the IEEE1394 digital interface.

- When "60/24" is selected as the menu item No.030 HD FREQUENCY setting
- When "23/24," "25 (HD)," "25 (SD)," "50 (HD)," or "50 (SD)" is selected in menu item No. 025 SYSTEM FREQ.



# Parts and their functions

## Front panel (1)

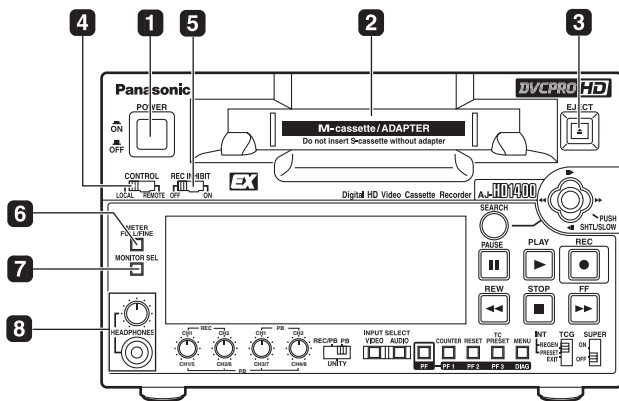

### 1 POWER switch

### 2 Cassette insertion slot (See page 18)

### 3 EJECT button

When this button is pressed, the tape is unloaded and the cassette is ejected automatically a few seconds later. When CTL display has been selected for the counter display, the display is reset.

To enable or disable the EJECT button operation during recording, use menu No. 115 EJECT SW INH.

### 4 CONTROL switch

This is selected to control the unit from an external source using the REMOTE connector.

**REMOTE:** Set to this position when controlling the unit with the AV/C command or the commands overlapped on the HD SDI of the 9-pin REMOTE, via IEEE1394.

**LOCAL:** Set to this position to control the unit using the controls on the unit's operation panel.

### 5 REC INHIBIT switch

This switch is used to enable or disable recording on the cassette tape.

**ON:** Recording on the cassette tape is disabled (inhibited). In this state, the REC INH lamp lights on the display panel.

**OFF:** Recording on the cassette tape is enabled so long as the accidental erasure prevention mechanism on the cassette tape is set to enable recording.

### 6 METER (FULL/FINE) selector button

This button is used to select the scale display for the audio level meter.

#### FULL mode:

The standard scale ( $-\infty$  to 0 dB) is selected.

#### FINE mode:

The scale in 0.5 dB increments is selected. The █ position indicates the standard level of  $-20$  dB (For AJ-HD1400P) or  $-18$  dB (For AJ-HD1400E). (See page 12)

### 7 MONITOR SEL button

This button is used to select the audio signals which are to be output to the AUDIO MON L and R connectors.

Each time the button is pressed, the audio signals to be output to the AUDIO MON L or R connector are changed in the following sequence.

L : [CH1] → [CH3] → [CH1] → [CH2] → [CH3] → [CH4]  
 R : [CH2] → [CH4] → [CH1] → [CH2] → [CH3] → [CH4]  
 → [CUE] → [CH1+CH2] → [CH3+CH4]  
 → [CUE] → [CH1+CH2] → [CH3+CH4]

Which signal is currently selected is displayed by the lighting of the L or R lamp on the level meter display.

Select [CH5-8] on the menu No. 783 AUDIO CH SEL to monitor CH5 to CH8.

### 8 Headphone jack and volume control

When stereo headphones are connected to the headset jack, you can monitor the audio signal through the headphones during recording and playback.

The headphone volume for output and monitoring output can be adjusted with the volume control knob. Whether the monitoring volume is linked to the volume control knob or not can be selected in menu No. 712 MONI OUT. In independent operation, the monitor output is fixed regardless of the position of the volume control knob.

Also, the output volume of the headphones is always linked to the volume control knob.

## Front panel (2)

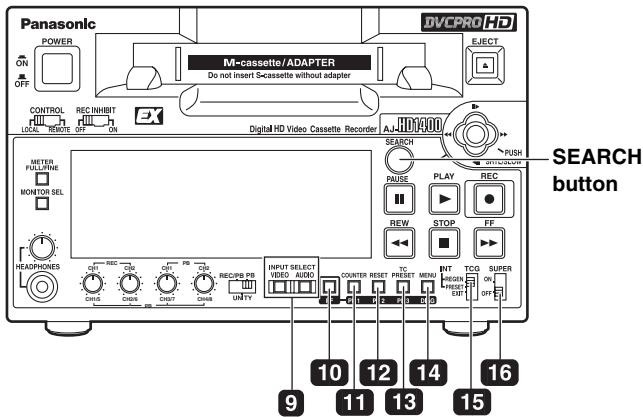

### 9 INPUT SELECT buttons

These buttons are used to switch the video and audio input signals. They can also be used to switch the video input signals to the internal reference signal selected as the menu item No.601 VIDEO INT SG setting.

#### VIDEO:

Each time the VIDEO button is pressed, the input video signal selection is switched in the order of [HD SDI] → [1394] → [SG].

When SG has been selected, the signal is switched to the internal reference signal selected as the menu item No.601 VIDEO INT SG setting.

#### AUDIO:

Each time the AUDIO button is pressed, the input audio signal selection is switched in the order of [HD SDI] → [SG] → [ANALOG].

#### <Notes>

- It is possible to inhibit the input switch operations (video and audio) of the INPUT SELECT buttons using menu item No.190 V IN SEL INH and item No.191 A IN SEL INH.
- The audio input signal cannot be switched to [1394] independently. The audio signal can be switched to [1394] only when the video signal is switched to [1394] by interlocking.

Since the audio input signal at this time is fixed to [1394], it cannot be switched to another input signal.

### 10 PF button

When this button is pressed, buttons **11** - **13** do function as the PF1, PF2 and PF3 buttons, respectively. When it is pressed again before another button is pressed, these modes are canceled.

When this button is pressed together with the MENU/DIAG button **14**, the DIAG screen is displayed.

### 11 COUNTER/PF1 button

Each time this button is pressed, the counter display on the display panel changes by one step in the following sequence: CTL → TC → UB → REM.

### 12 RESET/PF2 button

When this button is pressed in the CTL mode, the counter display is reset to [00:00:00:00].

When it is pressed in the TC/UB mode while holding down the TC PRESET button **13**, the generator is reset.

### 13 TC PRESET/PF3 button

This button is used to set the TC or UB values.

### 14 MENU/DIAG button

When the connector that is selected in menu No.005 SUPER is used, When this button is pressed, the setup menus are displayed on the TV monitor, and the setup menu numbers are displayed on the unit's display panel. When it is pressed again, the setup menu settings are exited, and the original status is restored.

When the button is pressed while holding down the PF button **10**, the VTR information is displayed. When it is pressed again, the original display is restored. The VTR information consists of the WARNING, HOURS METER, UMID INFO and DIF STATUS 1, 2 information.

The SEARCH button **20** is used to switch the displays between these kinds of information.

Descriptions of the warnings are displayed on the WARNING screen. The deck's serial number, poweron time, drum rotation time, tape travel time, number of loading times, number of power on/off times, etc. are displayed on the HOURS METER screen. The UMID (Unique Material Identifier) information is displayed on the UMID INFO screen. The IEEE1394 digital interface information is displayed on the DIF STATUS 1, 2 screen.

### 15 TCG switch

**REGEN:** The internal time code generator is synchronized with the time code which the time code reader has read from the tape.

The signal that is to be used for regeneration is selected using menu No. 505 TCG REGEN.

**PRESET:** The time code generator can be preset (see page 55) on the operation panel or by remote control.

**EXT:** The external time code which is input from the time code input connector or video signal SLTC, SVITC or IEEE1394 digital input signal is used. Which of the two is to be set is selected using menu No. 507 EXT TC SEL.

#### <Note>

When selecting "1394" with the INPUT VIDEO switch on the front panel, the time code input to IEEE1394 digital input/output connector is used.

### 16 SUPER switch

**ON:** Outputs superimposed information, such as time code, to the connector selected in menu No. 005 SUPER.

**OFF:** No superimposed information is output.

## Front panel (3)

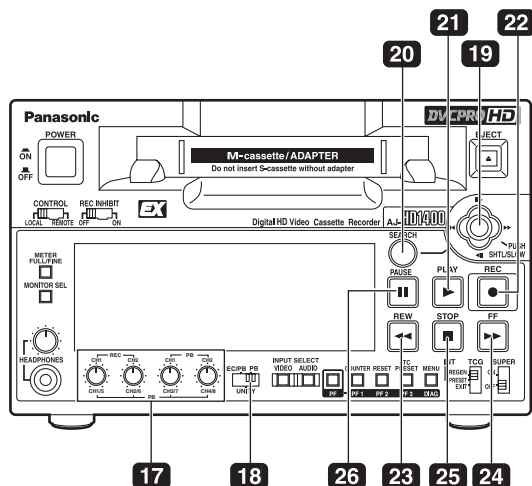

### 17 Audio level control knobs

These knobs are used to adjust the recording and playback level of the PCM audio signals.

The audio level control selector switch **18** switches between the recording/playback level adjustment for CH1/CH2 and the playback level adjustment for CH1 to CH4.

#### <Notes>

- The level of the IEEE1394 digital input/output audio signals cannot be adjusted.
- For the recording level, only the analog input can be adjusted.
- For HD SDI and SG, only the playback level is adjustable.

### 18 Audio level control selector switch

**UNITY:** At this position, the audio signals are recorded or played back at a fixed level regardless of the position of the audio level control knobs **17**.

**REC/PB:** The two switches on the left side of the audio level control knobs **17** control the recording level for the audio signal from analog input CH1/CH2, and the two switches on the right side control the playback level for the audio signal for CH1/CH2.

**PB:** At this position, the audio signals for CH1 - CH4 or CH5 - CH8 are played back at the level which has been adjusted by the audio level control knobs **17**.

#### <Note>

When selecting PB, the recording level is UNITY. Selecting CH1 to CH4 makes the playback level of CH5 to CH8 UNITY while selecting CH5 to CH8 makes the playback level of CH1 to CH4 UNITY. Selecting between CH1 to CH4 and CH5 to CH8 can be performed using menu No. 783 AUDIO CH SEL.

### 19 Joystick

This is used for shuttle, slow and other variable-speed playback. It is also used for the menu settings, etc.

The stick can be moved upward, downward, to the left or to the right, and it can also be pressed to initiate operations. (See "Joystick and Variable Speed Playback" (page 22))

#### <Note>

When this unit is turning on, do not use the stick. Variable-speed playback and menu setting operation become impossible.

### 20 SEARCH button

When this button is pressed, the search mode is established.

### 21 PLAY button

When this button is pressed, playback starts.

When this button and the REC button are pressed together, recording starts.

### 22 REC button

When this button is pressed together with the PLAY button, recording starts.

When it is pressed during playback, a search, fast forwarding or rewinding, the EE mode pictures and audio signals can be monitored while it is held down.

When it is pressed in the stop mode, the EE mode pictures and audio signals can be monitored. (When it is pressed during playback, the servo will be disrupted.) When the STOP button is pressed, the original pictures and sound are restored.

### 23 REW button

When this button is pressed, the tape is rewound. The rewinding speed can be selected using menu No.102 FF. REW MAX.

### 24 FF button

When this button is pressed, the tape is fast forwarded. The fast forwarding speed can be selected using menu No.102 FF. REW MAX.

### 25 STOP button

When this button is pressed, the tape stops traveling, and when "TAPE" has been selected for the menu item No.140 OUTPUT setting, the still images can be monitored.

Even in the stop mode, the drum continues to rotate, and the tape remains in close contact with the drum.

When the stop mode continues beyond a specific time period, the unit is automatically set to the standby OFF mode or STEP FWD mode in order to protect the tape. (This is set using menu item No.400 to 403.) Immediately after a cassette has been loaded in the unit, the stop mode is established.

### 26 PAUSE button

When this button is pressed during recording, the recording operation stops temporarily. Restart the recording by pressing the button again.

When this button is pressed during playback, the screen changes to a static display. Restart playback by pressing the button again.

## Display panel

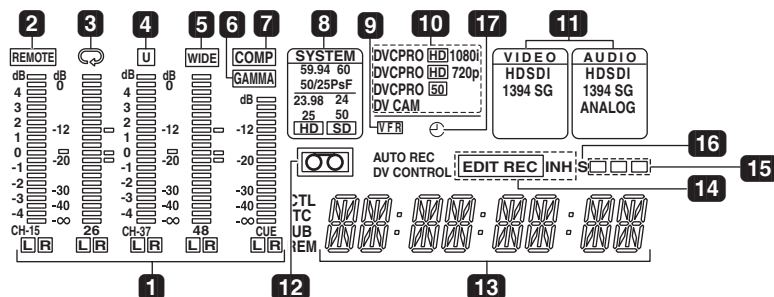

### 1 Level meter

Displays CH1/CH2/CH3/CH4 of the PCM audio signal for each level of CH5/CH6/CH7/CH8 and the CUE track. During recording and when the EE mode is selected, it shows the levels of the input audio signals; during playback, it shows the levels of the output audio signals. The audio level display is switched to CH1/CH2/CH3/CH4 and CH5/CH6/CH7/CH8 by selecting menu No. 783 AUDIO CH SEL. (See page 52)

The audio level display is switched between the FULL mode and FINE mode using the METER selector button **6** (See page 9).

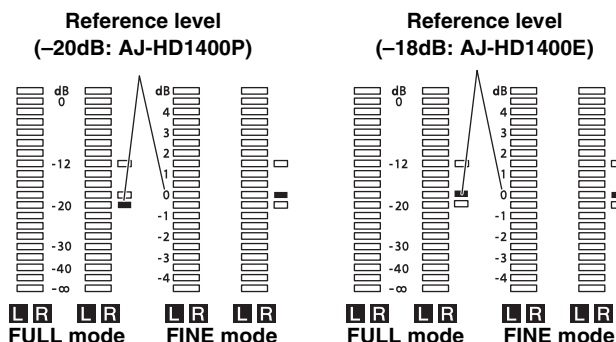

### 2 REMOTE lamp

This lamp lights when the CONTROL switch has been set to the REMOTE position.

### 3 Repeat lamp

This lights when the repeat play mode has been set.

### 4 U lamp

This lamp lights when UMID information is present on the input signal in EE mode. This lamp lights during tape playback when UMID information has been recorded on the tape.

### 5 WIDE lamp

This lamp turns on when "SQUEEZ" is selected in menu No. 620 DOWNCON MODE and the down-conversion output is set to wide screen, or when wide screen information is recorded on tape when an SD tape is played back.

### 6 GAMMA lamp

This lamp lights when GAMMA function is selected in menu No.693 GAMMA SEL.

### 7 COMP lamp

This lamp turns on when "DARK" is selected in menu No. 693 COMP MODE.

### 8 SYSTEM FREQ display screen

Displays the selections of menu No. 25 SYSTEM FREQ.

### 9 VFR (Variable Frame Rate) lamp

This lamp lights when a tape (24/25/50PsF) from a variable frame rate camera is played back after selecting the frame rate converter and when conversion is performed normally. If the tape and selected frame rate conversion function for play back do not match, the lamp flashes on and off. Select the frame rate conversion function in menu No. 25 SYSTEM FREQ. (See page 37)

### 10 Format displays

The recording format and the format (DVCPRO HD 1080i/DVCPRO HD 720P/DVCPRO 50/DVCPRO/DV/DVCAM) of the tape inserted in the unit are displayed here.

### 11 INPUT SELECT display area

The characters corresponding to the selected input signals light up in this area. With the exception of analog audio signals, flashing appears in this area if the selected input signals are not available.

#### VIDEO

**HDSI:** HD serial digital video signals  
**1394:** IEEE1394 digital signals  
**SG:** Internal reference signal

#### AUDIO

**HDSI:** HD serial digital audio signals  
**1394:** IEEE1394 digital signals  
**SG:** Internal reference signal  
**ANALOG:** Analog audio signals

### 12 lamp

This lamp lights when a cassette tape is inserted into the VTR.

In the standby OFF mode, this lamp is flashing.

### 13 Counter display

The tape counter, time code, etc. are displayed here.

The type of value displayed is indicated by CTL, TC, UB or REM.

**CTL:** This area indicates the tape timer (control signal).

**TC:** This area indicates time code data.

**UB:** This area indicates user bit data.

**REM:** This area indicates the remaining tape time and total tape duration in minutes.

Example: [30-46]

Remaining tape time: 30 minutes,

Total tape duration: 46 minutes

### 14 EDIT/EDIT REC/REC/REC INH lamps

**EDIT:** This lamp lights when the edit mode is selected. (9-pin control)

**EDIT REC:**

This lamp lights when in the editing record status. (9-pin control)

**REC:** This lights in the recording mode.

**REC INH:**

This lamp lights in the recording prohibited status (when the front upper REC INHIBIT switch is "ON" or when the tape was recorded in a format other than DVCPRO HD-LP and was played back while "ON" was selected in menu No. 118 SP MODE INH, or the cassette is in the erase protection status.)

Recording is not possible while this lamp is lighted.

Whether the lamp is to light or flash when the accidental erasure prevention tab on the cassette tape has been set to the recording inhibit position can be selected using menu item No.114 REC INH LAMP.

### 15 Channel condition lamps

These lamps light to indicate the error rate status.

**Green:** This lights when the error rates for the video and audio playback signals are both at acceptable levels.

**White:** This lights when the error rate for the video or audio playback level has increased.

The playback picture and sound remain unaffected even while this lamp is lighted.

**Red:** This lights when the error rate for the video or audio playback level has increased to the extent that correction or interpolation was performed.

### 16 S (servo) lamp

This lights when both the drum servo and capstan servo are locked.

### 17 Backup battery warning lamp

This lamp displays the voltage condition of the backup battery for 5 seconds after turning on the power.

**Steady light :** The voltage is the specified voltage or more

**Flashing :** The backup battery is not installed properly or the voltage of the backup battery is less than the specified voltage.

This unit is equipped with a backup mechanism to count down the time code generator while the power of the unit is turned off. For details, refer to "Time code when power is not supplied" (page 56).

The battery must be replaced periodically, since this unit cannot count down and the numerical value of the time code generator is reset if the backup battery voltage drops below the specified value. However, it is not necessary to replace the battery when it is not necessary to drive the backup feature.

#### <NOTE>

Refer replacement of backup battery to qualified service personnel.

# Parts and their functions (continued)

## Rear panel

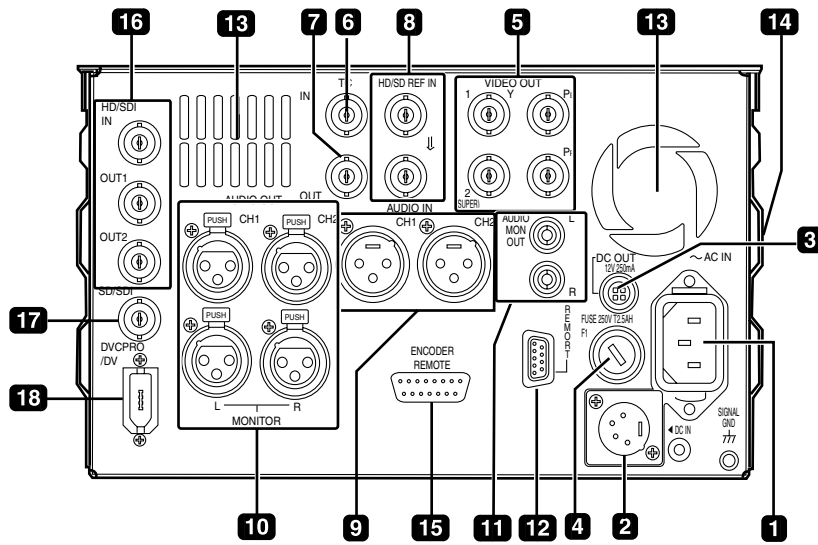

### 1 AC IN inlet

This is the AC power inlet.  
Connect the accessory power cable here.  
When both an AC power supply and DC power supply have been connected, the AC power supply takes priority.

### 2 DC IN socket

This is the input connector for the DC 12V supply voltage.  
Use an external DC power supply rated at DC 12 V/7 A (12 A peak or higher)  
When the voltage has dropped to around 10.6V, the unit's power is automatically turned off. (When "TYPE-A" or "TYPE-B" is not selected as the menu item No.180 BATTERY SEL setting)  
Even when the supply voltage is restored later, the power will not automatically come back on. The POWER switch must be set to OFF and then back to ON several seconds later.

If an external DC power supply is used, then check the ratings of the external DC power supply so that they are compatible with those of this unit. Check the pin arrangements of the DC output terminal of the external DC power supply and those of the DC IN socket of this unit so that their polarities are correctly arranged.  
If +12 V are supplied to the unit's GND terminal by mistake, this may cause fire or injury.  
If the polarities of the DC IN connectors of other devices are incorrect, and the other devices are connected to the unit by mistake, fire or personal injury may result.

#### <Notes>

- If an external DC power supply is used, then make sure that the external DC power supply is first turned ON, then this unit is turned ON. Improper operation may result in a malfunction in the unit due to slow startup of the output voltage of the external DC power supply.
- If input exceeds 18 V by mistake, the protection feature shuts down the power source at around 20 to 35 V. Change the voltage to the regular voltage, and the unit is available. An AC source cannot be connected to this terminal.

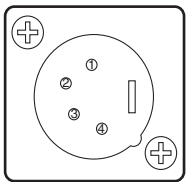

Pin No.	Signal
1	Ground
2	-
3	-
4	+12 V

### 3 DC OUT socket

This is the DC 12V output socket.  
Power is supplied from here to the external remote controller (AJ-A95: optional accessory).  
The DC power cable is packed together with the AJ-A95.

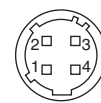

Pin No.	Signal
1	Ground
2	-
3	-
4	+12 V

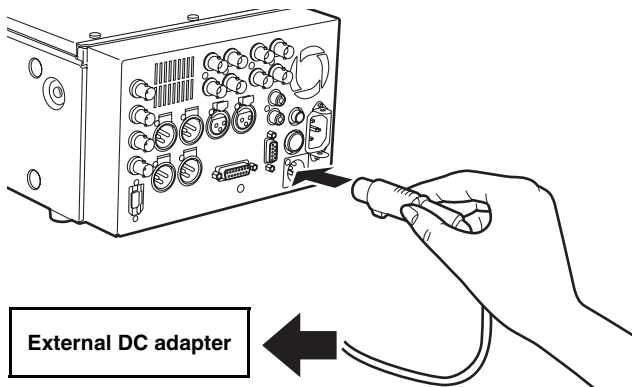

External DC adapter

### 4 Fuse holder

This holds the AC 250 V/2.5 A fuse (time lag type).

#### <Note>

Use the fuse specified by Panasonic.

## Parts and their functions (continued)

### 5 VIDEO OUT (1, 2, Y, P<sub>B</sub>, P<sub>R</sub>) connectors

By changing the menu item No.615 V OUT SEL setting, either analog composite signals or HD analog component Y signals are output from the VIDEO OUT1 connector.

Analog composite signals with superimposed information embedded can be output from the VIDEO OUT2 connector. Whether superimposed information is to be embedded in the signals is selected using menu item No.005 SUPER.

#### <Note>

When HD analog component output or HD SDI output signals are output with the 60 Hz or 24 Hz system frequency, the SD SDI signals will be output without the sync signals (NO SYNC), and the analog composite signals will be output in the black-and-white mode (burst OFF).

### 6 TC IN connector

This is used to record an external time code onto the tape.

### 7 TC OUT connector

This is used to output the playback time code during playback.

During recording, the time code generated by the internal time code generator is output from this connector.

### 8 HD/SD REF VIDEO IN connector and OUT connector

Input connector for the HD/SD reference video signal and loop through output connector.

#### <Notes>

- When inputting an HD reference signal to the connector, input a tri-level sync signal with positive and negative polarities. Also, supply signals matching the input signals and tape format.
- When inputting an SD reference signal to the connector, use a black burst signal which satisfy the SMPTE170M or ITU624-4 standard.
- If no cable is connected to the REF VIDEO OUT connector, the REF VIDEO IN connector will be 75 Ω automatically. If the cable is connected, the 75 Ω connection is cancelled.

### 9 AUDIO IN connectors (CH1, CH2)

These are the input connectors for the analog audio signals.

### 10 AUDIO OUT/MONITOR connector (CH1, CH2, Lch, Rch)

These are the output connectors for the analog audio signals.

It is possible to interlock Lch/Rch to the volume control knob for headphones by adjusting menu No. 712 MONI OUT appropriately.

### 11 AUDIO MONITOR connectors

These are the audio monitor output connectors. These connectors output the monitor selection channels.

It is possible to interlock these connectors to the volume control knob for headphones by adjusting menu No. 712 MONI OUT appropriately.

### 12 REMOTE CONTROL connector

An external remote controller is connected here to enable the unit to be operated using an external device.

#### <Notes>

- Set the LOCAL/REMOTE switch to REMOTE.
- The connector satisfies the RS-422A interface standard.

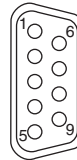

Pin No.	Signal
1	Frame Ground
2	Transmit A
3	Receive B
4	Receive Common
5	—
6	Transmit Common
7	Transmit B
8	Receive A
9	Frame Ground

### 13 Fan motor

This is provided to cool off the unit.

### 14 Grips

This is the handle for carrying the unit.

### 15 ENCODER REMOTE connector

Connect a connector encoder remote controller when externally adjusting each setting of the video output signal.

Pin No.	Signal
1	FRAME GROUND
4	REM(G)
7	REM RX (X) REMOTE CONTROL PROTOCOL RECEIVE
8	REM TX (X) REMOTE CONTROL PROTOCOL TRANSMIT
14	REM RX (Y) REMOTE CONTROL PROTOCOL RECEIVE
15	REM TX (Y) REMOTE CONTROL PROTOCOL TRANSMIT

### 16 HD SERIAL COMPONENT AUDIO VIDEO IN/OUT connector

These are input-output connectors for the HD digital component audio/video signal conforming to the SMPTE 292M, 296M or 299M standard.

## Parts and their functions (continued)

### 17 SD SERIAL COMPONENT AUDIO VIDEO OUT connector

These are output connectors for the digital component audio/video signal conforming to the SMPTE 259M-C, 272M-A standard.

They are output during DVCPRO50, DVCPRO, DV or DVCAM interchangeable playback or when signals are down-converted and output.

#### <Note>

When in 23.98/24 Hz mode, SD SDI output, the system phase of analog composite video output may change to match the phase of HD SDI output when tape speed is at the standard rate.

### 18 IEEE1394 digital input/output connector

This unit is capable of input and output through a digital interface conforming to the IEEE1394 standard. Use 6-pin connectors. Does not support bus power.

## Reference signals

During tape playback, the video output reference signals are as shown in the table below.

### In the 59.94 Hz/60 Hz or 50 Hz mode

Input signals		Menu item No.031			
REF_IN	INPUT	AUTO	HD_REF	SD_REF	INPUT*1
HD_REF_IN	Input	HD_REF_IN	HD_REF_IN	Internal SD	INPUT
	Not input	HD_REF_IN	HD_REF_IN	Internal SD	Internal HD
SD_REF_IN	Input	SD_REF_IN	Internal HD	SD_REF_IN	INPUT
	Not input	SD_REF_IN	Internal HD	SD_REF_IN	Internal SD
None	Not input	Internal HD	Internal HD	Internal SD	Internal HD

\*1 If "1394" or "INT SG (internal standard signal)" is selected for the video input signal, the video output reference signal will always be "Internal HD."

#### <Notes>

- When "E-AUTO" is selected in menu No. 31 OUT REF, the unit operates as if "INPUT" is selected in edit mode or "AUTO" is selected in modes other than the edit mode.
- When using the SD → HD up-converter and HD → HD cross-converter, input the HD tri-level sync signal that supports the HD output format in order to initiate operation using HD\_REF\_IN.

### In the 23.98 Hz/24 Hz mode

Input signals	
REF_IN	
HD_REF_IN	HD_REF_IN
None	Internal HD

### In the 25 Hz (HD), 25 Hz (SD), 50 Hz (HD) or 50 Hz (SD) mode

Input signals	Menu item No.031			
REF_IN	AUTO	HD_REF	SD_REF	INPUT
HD_REF_IN	HD_REF_IN	HD_REF_IN	Internal SD	Internal HD
SD_REF_IN	SD_REF_IN	Internal HD	SD_REF_IN	Internal HD
None	Internal HD	Internal HD	Internal SD	Internal HD

#### <Notes>

- In the 25 Hz (HD) or 50 Hz (HD) mode, black signals are output from the SD SDI output and analog composite output connectors.
- In the 25 Hz (SD) or 50 Hz (SD) mode, black signals are output from the HD SDI output and analog component output connectors.
- All the HD SDI output, SD SDI output, video output, analog component output, audio output and TC output signals are output in phase with the REF input.

#### Internal HD:

With HD tape playback as the reference, operation uses a 74 MHz clock signal in the free-run mode.

#### Internal SD:

With SD tape playback as the reference, operation uses a 4fsc clock signal in the free-run mode.



# Reference frequencies

During tape playback, the video output reference frequencies are as shown in the table below.

## 59.94 Hz/60 Hz operation specifications

Input signals		Menu item No.031			
REF_IN	INPUT	AUTO	HD_REF	SD_REF	INPUT
HD_REF_IN	Input	Complies with HD REF IN frequency	Complies with HD REF IN frequency	59.94Hz	Complies with INPUT frequency
	Not input	Complies with HD REF IN frequency	Complies with HD REF IN frequency	59.94Hz	Complies with menu item No.030 frequency
SD_REF_IN	Input	59.94Hz	Complies with menu item No.030 frequency	59.94Hz	Complies with INPUT frequency
	Not input	59.94Hz	Complies with menu item No.030 frequency	59.94Hz	Complies with menu item No.030 frequency
None	Not input	Complies with menu item No.030 frequency	Complies with menu item No.030 frequency	59.94Hz	Complies with menu item No.030 frequency

### <Notes>

- During SD tape playback, operation is not possible in the 60 Hz mode.
- When the HD SDI output signals are output at 60 Hz/24 Hz, the SD SDI signal is output in the NO SYNC status, and the analog composite signals are output in black-and-white mode (burst OFF).
- All the HD SDI output, SD SDI output, analog composite output, analog component output, audio output and TC output signals are output in phase with the REF input.

When "90H" is selected as the menu item No.26 HD SYS H ADV, the HD output is output with a phase 90H ahead of the SD output.

When the SD REF signal is input, the REF input and SD output signals are inphase, and when the HD REF signal is input, the REF input and HD output signals are in-phase.

- The audio output and TC output signals are output in-phase with the HD output signals.
- With the 720p format, there is a phase difference of 120H.

# Tapes

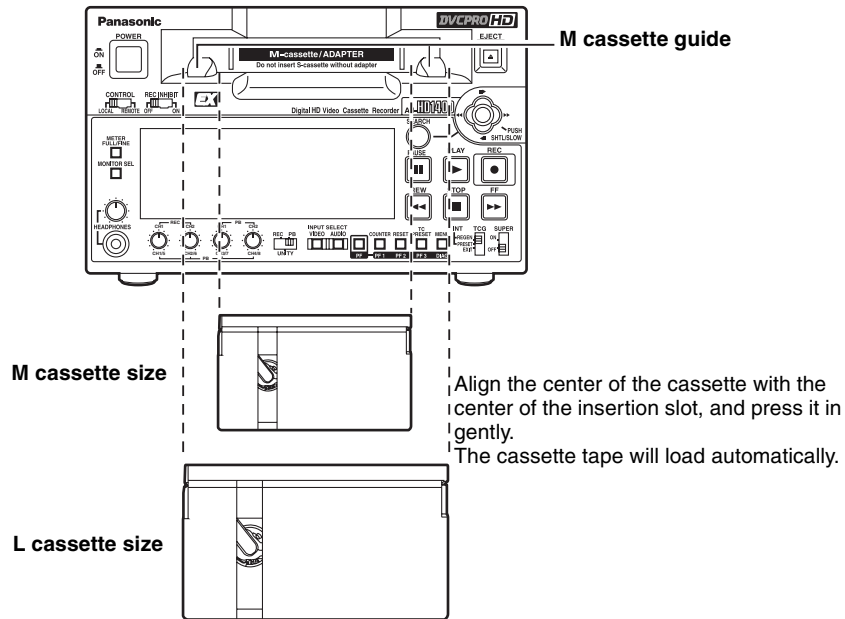

## Consumer-use DV and DVCAM cassettes (Standard DV and DVCAM cassettes, mini DV and DVCAM cassettes)

- Use a cassette adapter (AJ-CS455P) when a mini DV or DVCAM cassette is to be used.  
Note that inserting a mini DV or DVCAM cassette without the use of a cassette adapter will cause malfunctioning.  
Also note that long-duration mini DV cassettes (80 minutes in the standard mode and 120 minutes in the LP mode) cannot be used.
- It is not possible to play back tapes which have been recorded in the LP mode.
- When editing material recorded on a consumer-use DV or DVCAM cassette, first record the material on a DVCPRO tape or other tape used by VTRs for broadcast applications.
- The maximum transport speed of a mini DV or DVCAM cassette tape is 32×.
- The images may be subject to disturbance during the slow motion playback of consumer-use DV and DVCAM cassette tapes.
- From the perspective of protecting consumer-use DV and DVCAM cassette tapes, minimize the number of times the tapes are cued up at the same locations as much as possible.
- When consumer-use DV and DVCAM cassette tapes are used, the maximum time for STILL TIMER is set to 10 seconds.

It is recommended that tapes bearing the Panasonic brand be used as the consumer-use DV tapes.

### <Notes on cassette insertion>

- Set the cassette level with the cassette slit and insert straight.
- Do not put your hand in the cassette slit.
- Insert an M-cassette between the left/right M-cassette guides.
- If the cassette slit is exposed to the strong direct rays of the sun, a malfunction in the tape travel may occur.

### M cassettes

Tapes capable of up to 33 minutes of recording or playback (AJ-HP33EMG: for AJ-HD1400E)

### L cassettes

Tapes capable of up to 64 minutes of recording or playback (AJ-HP64ELG: for AJ-HD1400P and AJ-HD1400E)

# Connections

## Example of connections with an editing controller

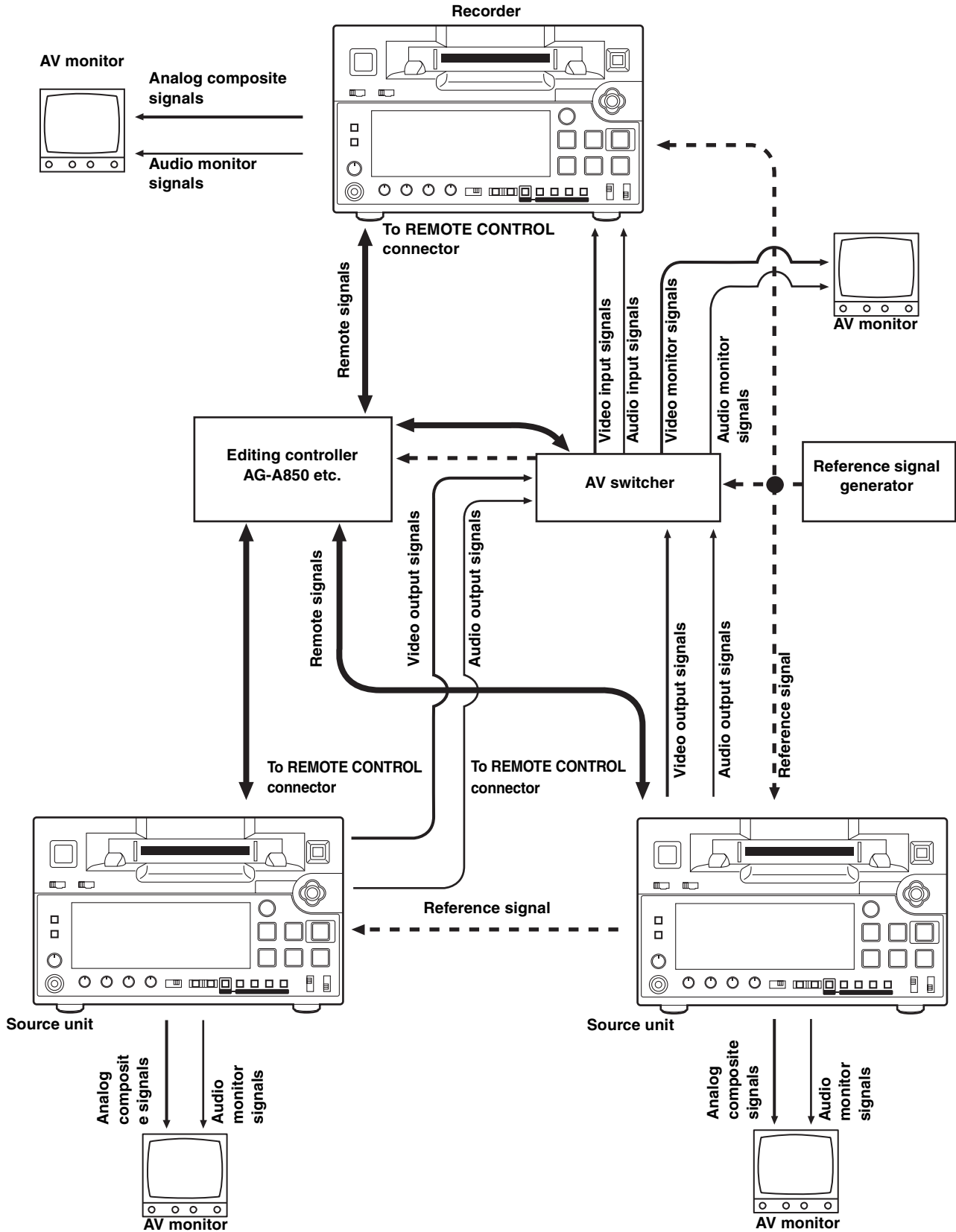

### <Notes>

- When disconnecting the remote signals (9P) from one component and re-connecting them to another component, check the settings, etc. of the editing controller.
- If the editing operation is executed via the 1394 connection, errors may occur in the editing.
- If the JOG/VAR operates at a half speed or less, errors may occur in the CTL count.

# IEEE1394 digital interface

## Settings for this unit

Confirm that menu No. 882 DIF IN CH and No. 883 DIF OUT CH of this unit are set to "AUTO."

Input-output of the digital input signal is enabled when "59/60" is selected in menu No. 25 SYSTEM FREQ and operated in 59.94 Hz. Input-output of the digital input signal is enabled when "50i/25P" is selected in menu No. 25 SYSTEM FREQ as well.

### <Notes>

- The incoming signal is limited to the format selected in menu No. 020 SYSTEM FORMAT.
- The output format is determined according to the list shown below.

Playback format	Output data format
DVCPRO HD-LP, DVCPRO HD	DVCPRO HD, DVCPRO50, DV*
DVCPRO50	DVCPRO50, DV*
DVCPRO	DVCPRO, DV
DV, DVCAM	DV
For EE mode or recording/editing (Including scene-to-scene continuity) ● Select a value other than "1394" with the INPUT SELECT button on the front panel.	DVCPRO HD*

\* CH1/CH2 or CH3/CH4 can be selected as the output audio channel.

With the following setting, the signal is not output from the IEEE1394 digital interface.

- When "23/24," "25 (HD)," "25 (SD)," "50 (HD)," or "50 (SD)" is selected in menu No. 025 SYTEM FREQ
- When the unit operates in 60 Hz/24 Hz

## Precautions for use

- Connect the interface with another device on a 1:1 basis.
- If the E-92 warning (1394 INITIAL ERROR) is displayed, either re-connect the connecting cable or turn the VTR's power off and back on.
- The AV signals may be disrupted when the power of the connected devices is turned on or off and when the interface cable is connected or disconnected.
- When the input signals are switched or the mode is transferred, it may take a few seconds for the system to stabilize. Proceed with the recording operation only after the system has stabilized.
- The following situation applies when recording is to be performed by selecting the IEEE1394 digital interface input, and it applies with the signals which are output by the IEEE1394 digital interface.
  - ◆ The audio level control knobs on the front panel do not work. The settings in menu No. 680/681/695 are ignored and the blanking will not be applied.
  - ◆ When playback signals other than regular 1× speed playback signals have been input, no guarantees are made for the pictures and sound which will be recorded or for the EE-type pictures and sound.
- The following situation applies when the video input selection has been set as the IEEE1394 digital interface.
  - ◆ The SDI signals, the analog video output signals and time code output signals become irregular in the EE mode. Do not use these signals for recording purposes. (The teletext signals and other signals superimposed onto the video output signals also become irregular.)
- During SLOW/STILL playback, unprocessed video and audio signals are output as the IEEE1394 digital interface output. When these video and audio signals are monitored using another device, they may differ from the video and audio signals played back by this unit.  
When the equipment for non-linear editing is connected to this unit, do not start any other application program than software for the non-linear edit. Non-linear editing equipment may garble the output video picture.

### Be absolutely sure not to defeat the following safeguards when connecting the IEEE1394 cable.

- (1) **Ensure that the unit and all devices to be connected are grounded (or connected to a common ground).**  
If the equipment cannot be grounded, first turn off the power of all the connected devices, and then disconnect and re-connect the IEEE1394 cable.
- (2) **When connecting the unit to a device equipped with a 4-pin connector, connect the unit's connector (6-pin type) first.**
- (3) **When making a connection to a PC equipped with a 6-pin connector, connect the 1394 cable so that it mates properly with the 1394 connector. Bear in mind that if the plug is inserted the wrong way round, the unit may be damaged as a result.**

# VANC data recording/playback

---

---

## VANC data recording

- 1** Detects the VANC data packets that multiplex recorded in the following range of the Y stream of HD SDI.  
1080i: L9–L20, L571–L583  
720P: L9–L25

**<Note>**

HANC data packets are not be detected.

- 2** Records VANC data packets up to the following volume in the VAUX region of the DVCPRO HD format in the order of the earlier line.  
1080i: 5760 word/frame  
720P: 2880 word/frame

**<Note>**

Data packets that exceed the capacity will not be recorded or played back.

- 3** Records the video signal from the HD SDI simultaneously.

**<Note>**

Recording and playback of VANC data only are not possible.

## VANC data playback

- 1** If the VTR mode is one of the following, VANC data will be multiplexed to the Y stream of the HD SDI and will be played back with the video signal.

- Normal playback mode
- Simultaneous playback mode
- Edit playback mode
- EE mode

**<Notes>**

- If an operation mode other than the above, such as FF, REW, JOG, VAR, the video signal will only be played back by muting VANC data.
- Playback of VANC data only is not possible.

- 2** VANC data packets will be multiplexed to the same line of the multiplex line.

**<Note>**

For format conversion playback, the video signal only will be played back by muting VANC data.

# Joystick and Variable Speed Playback

## Joystick

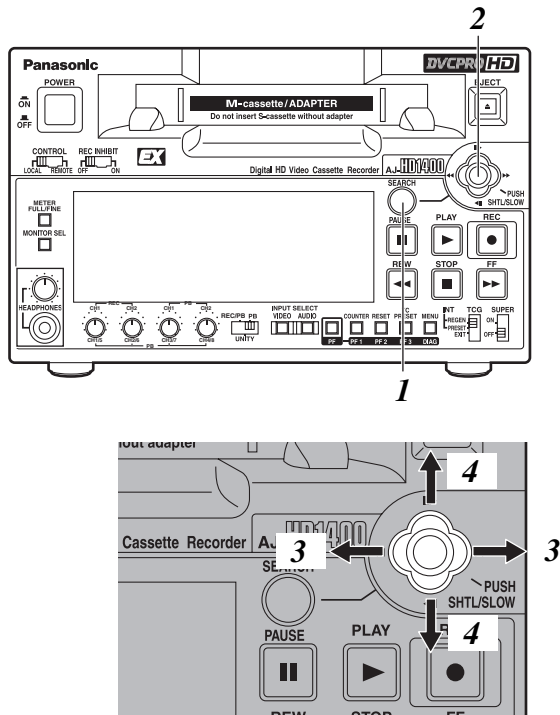

- 1** Press the SEARCH button to activate the joystick. When "STICK" has been selected as the menu item No.100 SEARCH ENA setting, the joystick will be activated without pressing the SEARCH button.
- 2** Press the joystick to switch between the SHTL mode and SLOW mode.
- 3** When the joystick is inclined toward the right, the tape can be played back in the forward direction at a variable speed based on the angle that the stick is inclined. When the stick is inclined toward the left, the tape is played back in the reverse direction.
  - SHTL mode:  
The maximum speed which is established when the joystick has been inclined at the maximum angle corresponds to the speed which has been set by menu item No.101 SHTL MAX.
  - SLOW mode:  
The speed ranges from  $-0.9\times$  to  $+1.0\times$ .

- 4** When the joystick is inclined upward, the tape travels in 1-frame increments in the forward direction; when it is inclined downward, it travels in 1-frame increments in the reverse direction.

Slow playback is performed if the stick is held at the top or bottom position.

- If the SEARCH button is pressed while the joystick is pressed to one side, the current speed is maintained even if the joystick is released. Pressing the STOP, PLAY, or other operation buttons cancels the fixed speed operation.

### <Notes>

- Noise may occur in the video images and voices may be distorted when tape is replayed at a speed other than the standard speed ( $1\times$ ).
- The PCM audio signal is played back in the  $-0.9\times$  to  $+1.0\times$  speed range, while the CUE signal is played back at all other speeds. (See menu No. 746 MONI CH SEL (page 51) and No. 765 CUE OUT SEL (page 52))

## Variable Speed Playback

Variable playback speeds are possible by operating the controller if the 9P remote controller is connected to the REMOTE CONTROL connector.

# PF (Programmable Function)

Three setup menu items can be registered in the PF buttons, and these buttons can then be used to change the setup menu settings by a simple operating procedure.

## Performing operations using the PF buttons

- 1 Open the setup menu by pressing the Menu button, and move the cursor to the A00 MENU by tilting the joystick down and then to the right.
- 2 Move the cursor to the item with the PF number to be registered (A04 to A06) by tilting the joystick up and down.

```

SETUP-MENU MENU
<USER1> NO. A04-
A02 P. ON LOAD OFF
*A04 PF1 ASSIGN 012
A05 PF2 ASSIGN 513
A06 PF3 ASSIGN ---
END
    
```

- 3 When the joystick is pressed, a list of items which can be set is displayed.

```

SETUP-MENU MENU
<USER1> NO. A04-
A04 PF1 ASSIGN 012

*--- NO ASSIGN
001 LOCAL ENA
002 LOCAL TIMER
003 REMAIN SEL
008 CHARA H-POS
009 REMAIN SEL
010 CHARA V-POS
    
```

- 4 Press the joystick to select the item at the cursor position; the display will then return to the regular menu.

### <Notes>

- The following menu items cannot be saved.

No.	Menu item	No.	Menu item
05	ENCODER SEL	653	Y LEVEL (HD)
06	V LEVEL CTRL	654	Pb LEVEL (HD)
12	SYS H (HD)	655	Pr LEVEL (HD)
14	SYS SC (SD)	656	BK LEVEL (HD)
15	VO SYS SC (SD)	658	Y LEVEL (SD)
16	SD SYS SC (SD)	659	Pb LEVEL (SD)
18	SCH CORS (SD)	660	Pr LEVEL (SD)
19	SCH FINE (SD)	661	BK LEVEL (SD)
20	AV PHASE	662	V LEVEL
25	SYSTEM FERQ	663	C LEVEL
26	HD SYS H ADV	664	HUE (AJ-HD1400P)
181	TYPE A NEAR		C PHASE (AJ-HD1400E)
182	TYPE A END	665	SETUP LVL (AJ-HD1400P)
183	TYPE B NEAR		BK LVL (AJ-HD1400E)
184	TYPE B END		

- As for the menu items registered in the PF button, when the menu is not displayed due to change of settings in menu No. 25 SYSTEM FREQ are changed, the registered contents in the interlocked PF button will be in the “not saved” state and cannot be displayed nor operated. Refer to “Menus which are displayed” (page 32). The settings for the PF buttons are retained but will be updated once save operations are executed again.

## Operation using the PF buttons

- 1 When the PF button is pressed, the registered items are displayed on the monitor screen which is output from the VIDEO MON connector.
- 2 Press the PF1, PF2 or PF3 button that corresponds to the item whose setting is to be changed. Each time the button is pressed, the setting is updated in sequence.

```

PF1: SYS FORMAT 50M
PF2: INT SG CB75
PF3: -----
    
```

- 3 When the PF button is pressed again, the regular display is restored. If no operations are made, the display is also restored automatically after five seconds elapse.

# Pause/Recording (Recording with pauses)

---

- 1** Press the PAUSE button during playback of the cassette tape.
- 2** Press the REC button to move to the REC PAUSE mode. When menu item No. 154 AUTO BACK is set to "REC-P" or "ALL," the tape is rewound for a few seconds from the position where the PAUSE button is pressed.
- 3** Press the PAUSE button to start recording. The tape runs to the position where the PAUSE button is pressed as mentioned in **1** above, and recording starts.
- 4** Press the PAUSE button again to pause the recording. When menu item No. 154 AUTO BACK is set to "REC-P" or "ALL," the tape is rewound for a few seconds from the position where the PAUSE button is pressed, and then paused.
- 5** By repeating the operation in **3** and **4** above, it is possible to record with pauses.

## Cue up

---

When recording with pauses, the time codes of the starting point and the stopping point of the recording are automatically backed up. However, the "CTL" is selected by using the COUNTER button, and the control signals are backed up. With the following button operation, it is possible to cue up to the starting and stopping points of the recording.

### STOP + REW

Press the REW button while the STOP button is pressed to cue up to the starting point of the recording.

### STOP + FF

Press the REW button while the STOP button is pressed to cue up to the starting point of the recording.

### <Note>

If the time code is not successive, it is impossible to cue up to the starting point of the recording properly. Execute the following settings.

- Menu item No. 154 AUTO BACK:  
"REC-P" or "ALL"
- Menu item No. 503 TCG MODE:  
"REGEN" or "AUTO"

- 1** Execute the recording with pauses.
- 2** Press the REW button while the STOP button is pressed. The tape cues up to the starting point of the recording with an accuracy of  $\pm 1$  frame.
- 3** Press the PLAY button to confirm the recording.
- 4** Press the FF button while the STOP button is pressed. The tape cues up to the stopping point of the recording and stops 5 to 10 frames before the stopping point.
- 5** Press the PAUSE button and then the REC button to move to the REC PAUSE mode. The tape cues up to the stopping point of the recording and stops 5 to 10 frames before the stopping point.

### <Notes>

- In the backup operation, only the time codes of the last event recorded with pause are stored.
- Even if the recording is stopped by pressing the STOP button, the stopping point of the recording is backed up.
- Cueing up from a portion where nothing is recorded cannot be executed properly.
- If the FF/REW button is pressed during the cue up operation, the unit moves to the ordinary search mode.
- When the power is turned off, backup data stored when starting the recording and completing the recording will be cleared.



# Repeat playback

## Setting the BEGIN and END points

- 1 Press the MENU button.
- 2 Select menu item No. 161 CTL (TC) BGN or No. 162 END, and tilt the joystick right/left while pressing the SEARCH button.  
By operating the joystick, the user can choose whether or not to set the BEGIN and END points. "--:--:--" appears on the display when the points are not set. If repeat playback is initiated in this state, the tape start will serve as the BEGIN point, and the tape end will serve as the END point.
- 3 Press the joystick while the setting is displayed. The changed digits flash on the display.
- 4 Select TC or CTL using the COUNTER button.
- 5 Incline the joystick to the left or right, and select the digits to change (flashing).  
The frame digits cannot be selected. "00" is always displayed for these digits.  
When the joystick is now inclined upward or downward, the value of the digits changes.  
The counter display is reset to 00:00:00:00 when the RESET button is pressed.
- 6 After the settings have been completed, press the joystick.
- 7 Press the MENU button.

### <Note>

The settings for the BEGIN and END points are not stored in user default. Even if the factory settings and/or the user defaults are loaded, the settings for the BEGIN and END points are not revised. For user defaults, refer to "Setup (initial settings)" (page 27).

## Setting the repeat playback mode

- 1 Press the MENU button.
- 2 Select menu item No.160 MEMORY MODE, and select the repeat playback mode.

Item setting	Description of operation
OFF	Normal operation
M-STOP	When the tape is fast forwarded or rewound, it stops near the BEGIN point.
REPT1	When the tape is played as far as the END point, it is rewound to the BEGIN point where it stops.
CONT	When the tape is played as far as the END point, it is rewound to the BEGIN point and played, and this sequence of operations is repeated.

- 3 Press the MENU button.  
A confirmation screen now appears. The settings are stored in the memory if the PLAY button is now pressed.

### <Notes>

- The picture quality deteriorates when repeat playback is initiated for the same tape over and over again. As a general rule of thumb, replace the tape with a new one after playing back the tape for about 100 times.
- The output images to be displayed while the tape is being rewound to the BEGIN point in the repeat playback mode can be set using menu item No.163 REPT MODE.  
If "FREEZE" is selected as the REPT MODE setting and the tape end has been set as the END point, the playback image will not be frozen properly. Set the END point at a place on the tape where images have been recorded.
- If the counter display mode (TC or CTL), which was established when menu item No.161 CTL (TC) BGN and No.162 END were set, is different from the counter display mode (TC or CTL) in which repeat playback is to be initiated, the repeat lamp flashes, and the repeat playback operation cannot be performed.
- When repeat playback is to be initiated using a consumer-use DV and DVCAM tapes, the unit will not operate even if "CONT" has been selected as menu item No.160 MEMORY MODE setting.

# Recording from a variable frame rate camera

## Recording the HD SDI output signal from a variable frame rate camera

Connect the HD SDI (720/30P over 59.94P) output of the variable frame rate camera to the HD SDI input connector of this unit.

- 1 Select "SLTC" in menu No. 032 REC REF.  
Detect the frame information from the superimposed time code in the HD SDI signal to prevent displacement of the field.
- 2 Adjust the following settings to activate the two settings.
  - Menu No. 25 SYSTEM\_FREQ: 59/60
  - Menu No. 020 SYS\_FORMAT: 720p
  - INPUT SELECT button on the front panel: HDSDI
- 3 Change the mode for this unit to REC PAUSE mode.
- 4 Press the PAUSE button while confirming the HD SDI output image of the variable frame rate camera to start recording.  
The time code is recorded to maintain the continuity of the recorded tape.  
The superimposed user bits for the HD SDI signal is recorded.

### <Note>

Through the settings in menu No. 032 REC REF, the time code and the user bits recorded on the tape are as follows.

### SLTC:

The time code is recorded to maintain the continuity of the recorded tape.

The superimposed user bits for the HD SDI signal is recorded.

The following settings are then invalid.

- TCG switch on the front panel (REGEN/PRESET/EXT)
- Menu No. 503 TCG\_MODE (SW/FREE)
- Menu No. 505 TCG\_REGEN (TC&UB/TC/UB)
- Menu No. 507 TC\_SOURCE (EXT\_L/SLTC/SVITC)

### NORMAL:

Time code and user bits are recorded according to the following settings.

- TCG switch on the front panel (REGEN/PRESET/EXT)
- Menu No. 503 TCG\_MODE (SW/FREE)
- Menu No. 505 TCG\_REGEN (TC&UB/TC/UB)
- Menu No. 507 TC\_SOURCE (EXT\_L/SLTC/SVITC)

## Field displacement

There is no discriminant information to differentiate between the first field and the second field in the HD SDI signal of 720P. Accordingly, it is usually necessary to synchronize the HD SDI signal transmission equipment to the recording equipment with the reference signal from SD. If not synchronized, there is a risk of generating displacement (image frame fails to match the time code) with 1/2 probability described as follows.

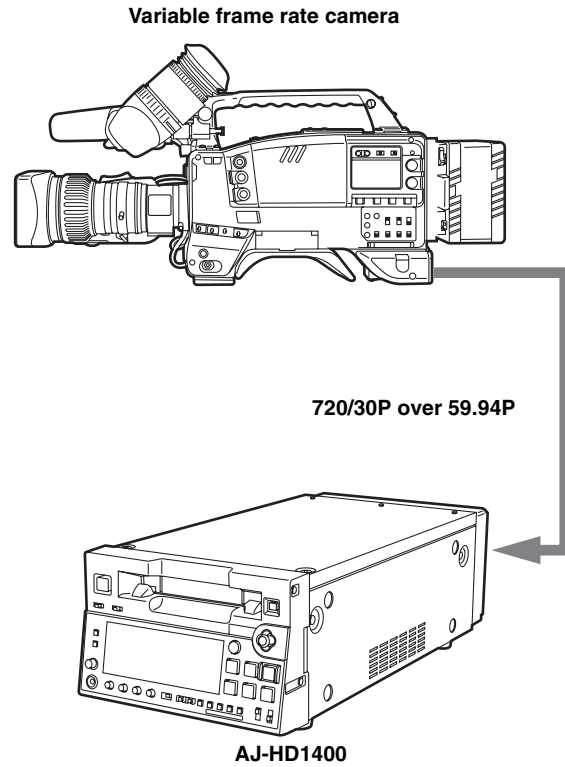

### Video output of variable frame rate camera

A	A	B	B	C	C	D	D	E	E	F

### Time code output of variable frame rate camera

00	01	02	03	04	05
----	----	----	----	----	----

### Record image of VTR

A	B	B	C	D	D	E	E

### Record time code of VTR

00	01	02	03	04
----	----	----	----	----

To prevent displacement of this field, select "SLTC" in menu No. 032 REC REF when recording the HD SDI output signal from a variable frame rate camera (720/30P over 59.94p) with this unit.

# Setup (initial settings)

This unit's main settings can be performed and checked using the on-screen menus which are displayed on the video monitor connected to the unit.

It is also possible to set and confirm using the item number and the setting number or the item name, which are displayed on the display part on the front panel.

Furthermore, a user setting memory in which to store three sets of settings is provided, enabling the desired settings to be stored for future use.

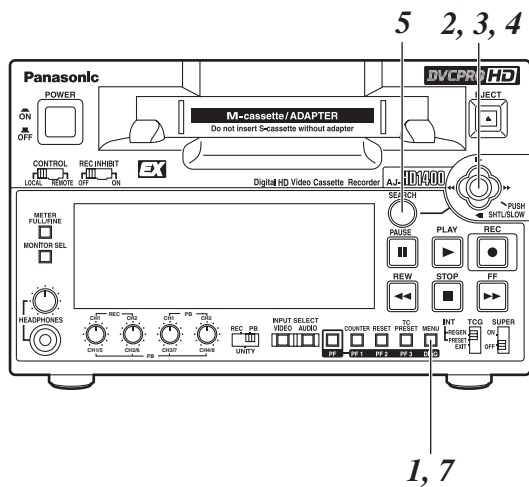

## Setting method using the on-screen menus

**1** Press the MENU button.

SETUP-MENU MAIN is displayed on the video monitor, and the names of the main menu items are displayed in the counter display.

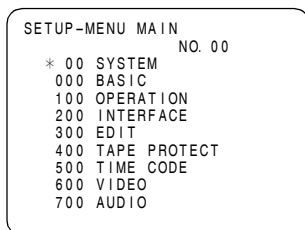

**2** Incline the joystick up and down to select the main menu item.

The cursor (\*) for the main menu items on the select screen moves up and down and the names of main menu items are displayed on the counter display.

**3** Incline the joystick toward the right to move the cursor on the settings screen to each item.

The settings screen for each item is displayed on the video monitor, and the item number in the counter display will flash. When the FF button is pressed for about 1.5 seconds, the item name will be displayed in the counter display. When the FF button is pressed for about 1.5 seconds again, the display returns to the item number.

In order to return to the SETUP-MENU MAIN screen, incline the joystick toward the left.

**4** Incline the joystick up and down to select the item to change the setting.

The cursor (\*) on the select screen moves up and down, and the item number flashes on the counter display.

**5** Incline the joystick right and left while pressing the SEARCH button at the changing position.

The set value on the settings screen and the set value in the counter display flash; the value changes each time the joystick is inclined right and left. When the set value is displayed, return the joystick.

In order to return the set value to the factory settings, press the RESET button while pressing the SEARCH button.

**6** To change the other items, repeat the process 4, 5, and 6.

**7** Press the MENU button.

- When the set value is not changed, the display of the menu screen disappears.
- When the set value is changed, a confirmation screen will be displayed.
- Press the PLAY button to save the changes of the set value.
- Press the STOP button to cancel the change of the set value.



## Returning to the factory settings

**1** Press the MENU button.

A select screen for the major menu items is displayed on the video monitor and the names of the major menu items are displayed in the counter display.

**2** Press the RESET button.

The unit is now set to the default setting mode, and the default setting screen now appears on the video monitor.

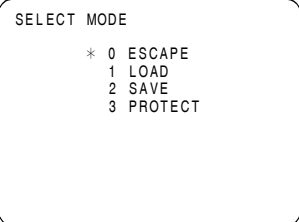

## Setup (initial settings) (continued)

- 3 Incline the joystick up and down to adjust the cursor in the default settings screen to the "LOAD" position and press the joystick. The mode for this unit changes to the LOAD mode, the LOAD screen is displayed on the video monitor, and the item name is displayed in the counter display.

```
SETUP-MENU <LOAD>
* NO
  FACTORY
  USER (ALL)
  USER (NOT SYSTEM)
```

- 4 Incline the joystick up and down to adjust the cursor in the LOAD screen to the "FACTORY" position and press the joystick.
- If this operation is made after moving the cursor to "FACTORY," values for all menus except the SYSTEM menu will return to the factory settings.
  - When the cursor is moved to "NO" and this operation is performed, the display returns to the menu screen without restoring the factory settings.

- 5 The confirmation screen is displayed on the video monitor.
- Press the PLAY button to save the change of the set value.
  - Press the STOP button to cancel the change of the set value.

```
SETUP-MENU <LOAD>
FACTORY OK?
YES<PLAY>/NO<STOP>
```

- 6 Press the MENU button.
- When the set value is not changed, the display of the menu screen disappears.
  - When the set value is changed, a confirmation screen will be displayed.
  - Press the PLAY button to save the change of the set value.
  - Press the STOP button to cancel the change of the set value.

```
SETUP-MENU SET OK?
YES<PLAY>/NO<STOP>
```

## Setting the user defaults

- 1 Press the MENU button.  
A select screen for major menu items is displayed on the video monitor, and the names are displayed in the counter display.
- 2 Follow the procedure described in "Setting method using the on-screen menus" 2-6 and adjust the desired settings.
- 3 Press the RESET button.  
The mode for this unit will change to the default setting mode, and the default setting screen will be displayed on the video monitor.

```
SELECT MODE
* 0 ESCAPE
  1 LOAD
  2 SAVE
  3 PROTECT
```

- 4 Incline the joystick up and down to adjust the cursor in the default settings screen to the "SAVE" position and press the joystick.  
The mode for this unit changes to the SAVE mode, the SAVE screen is displayed on the video monitor, and the item name is displayed in the counter display.

```
SET-UP MENU <SAVE>
* NO
  USER1 (ALL)
  USER2 (ALL)
  USER3 (ALL)
  USER1 (NOT SYSTEM)
  USER2 (NOT SYSTEM)
  USER3 (NOT SYSTEM)
```

- 5 Incline the joystick up and down to adjust the cursor on the SAVE screen to the "USER \* (ALL)" position (\* each value from 1 to 3.) and press the joystick.
- When storing a set value other than SYSTEM menu in memory, move the cursor to "USER \* (NOT SYSTEM)" (\* each value from 1 to 3.) and press the joystick.
  - To cancel the operation, move the cursor to "NO" and press the joystick.
- 6 Confirmation screen for SAVE is displayed.
- Press the PLAY button to save the setting.
  - Press the STOP button if the set value is not saved.

```
SET-UP MENU <SAVE>
USER1 (ALL) OK?
YES<PLAY>/NO<STOP>
```

## Setup (initial settings) (continued)

- 7 Press the MENU button.
- When the set value is not changed, the display of the menu screen disappears.
  - When the set value is changed, a confirmation screen will be displayed.
  - Press the PLAY button to save the changes of the set value.
  - Press the STOP button to cancel the change of the set value.

```
SETUP-MENU SET OK?  
YES<PLAY>/NO<STOP>
```

### User default loading method

- 1 Press the MENU button.  
A select screen for the major menu items is displayed on the video monitor, and the names are displayed in the counter display.
- 2 Press the RESET button.  
The unit is now set to the default setting mode, and the default setting screen now appears on the video monitor.

```
SELECT MODE  
* 0 ESCAPE  
1 LOAD  
2 SAVE  
3 PROTECT
```

- 3 Incline the joystick up and down to adjust the cursor on the default settings screen to the LOAD position and press the joystick.  
The mode for this unit changes to the LOAD mode, the LOAD screen is displayed on the video monitor, and the item name is displayed in the counter display.

```
SET-UP MENU <LOAD>  
* NO  
USER1 (ALL)  
USER2 (ALL)  
USER3 (ALL)  
USER1 (NOT SYSTEM)  
USER2 (NOT SYSTEM)  
USER3 (NOT SYSTEM)
```

- 4 Incline the joystick up and down to adjust the cursor on the LOAD screen to the "USER \* (ALL)" (\* each value from 1 to 3.) position and press the joystick.
- When loading a set value other than SYSTEM menu in memory, move the cursor to "USER \* (NOT SYSTEM)" (\* each value from 1 to 3.) and press the joystick.
  - To cancel the operation, move the cursor to "NO" and press the joystick.
- 5 LOAD confirmation will be displayed.
- To load the set value, press the PLAY button. Indications on the menu will disappear.
  - To prevent loading of the set value, press the STOP button. Indications on the menu will disappear.

```
SET-UP MENU <LOAD>  
USER1 (ALL) OK?  
YES<PLAY>/NO<STOP>
```

# Setup (initial settings) (continued)

## Menu protection method

By switching to the menu protect mode, it is possible to disable the setup menu even if the MENU button on the front panel is pressed.

- 1 Press the MENU button.  
A select screen for the major menu items is displayed on the video monitor, and the names are displayed in the counter display.
- 2 Press the RESET button.  
The unit will switch to the default setting mode, and the default screen will be displayed on the video monitor.

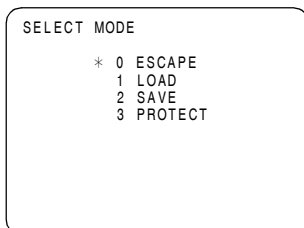

- 3 Tilt the joystick up/down to move the cursor to the "PROTECT" position on the default screen and then press the joystick.  
The unit will switch to the LOAD mode, and the LOAD screen will display on the video monitor. The item names will appear on the counter display.

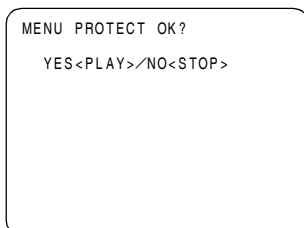

- 4 Press the PLAY button.  
The menu is displayed.
- 5 Press the MENU button.  
The menu disappears and the unit will switch to the menu protect mode.
  - If the MENU button is pressed while the menu protect mode is set, the message <MENU PROTECT> is displayed on the video monitor and the menu is displayed.

### <Note>

To enable ordinary menu operation while the menu protection mode is set, press the MENU button when pressing the COUNTER button on the front panel.

## Menu protection release method

- 1 Press the MENU button when pressing the COUNTER button on the front panel.  
A select screen for the major menu items is displayed on the video monitor, and the names are displayed in the counter display.
- 2 Execute the procedures from 2 to 3 described in the "Menu protection method."  
The unit will be set to the menu protect setting mode, and the display for confirming menu protection will appear on the video monitor.

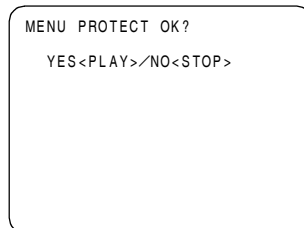

- 3 Press the STOP button.  
The menu is displayed.
- 4 Press the MENU button.  
The menu disappears, and the menu protect mode is released.

# Setup (initial settings) (continued)

## System frequency switching

<Selection of the record and playback format and the synchronizing signal depends on the operation mode>

NO.25 SYSTEM FERQ	Recordable format	Playback permissible format	Synchronized signal
59/60	1080/59.94i (HD_LP) 720/59.94p (HD_LP) 720/60.00p (HD_LP) (Only the variable frame rate signal can be recorded.)	1080/59.94i 1080/60i 720/59.94p 720/60.00p 480/59.94i (50M, 25M, DV, DVCAM)	HD_REF (59.94Hz, 60Hz) SD_REF (59.94Hz)
			According to the setting in menu No. 031 OUT REF.
50i/25P	1080/50i (HD_LP) 720/50p (HD_LP)	1080/50i 720/50p 576/50i (50M, 25M, DV, DVCAM) 576/25p over 50i (50M, 25M, DV)	HD_REF (50Hz) SD_REF (50Hz)
			According to the setting in menu No. 031 OUT REF.
23/24	None	1080/23.98p over 59.94i [2:3 mode] 1080/23.98p over 59.94i [2:3:3:2 advance mode] 720/23.98p over 59.94p 720/24p over 60.00p 480/23.98p over 59.94i [2:3 mode] 480/23.98p over 59.94i [2:3:3:2 advance mode]	HD_REF (47.96Hz, 48Hz)
25 (HD)	None	720/25p over 60p	HD_REF (50Hz) SD_REF (50Hz)
			According to the setting in menu No. 031 OUT REF.
25 (SD)	None	720/25p over 60p	HD_REF (50Hz) SD_REF (50Hz)
			According to the setting in menu No. 031 OUT REF.
50 (HD)	None	720/50p over 60p	HD_REF (50Hz) SD_REF (50Hz)
			According to the setting in menu No. 031 OUT REF.
50 (SD)	None	720/50p over 60p	HD_REF (50Hz) SD_REF (50Hz)
			According to the setting in menu No. 031 OUT REF.

## Procedure for shifting the system frequency

To shift the system frequency execute the following operations.

- 1 Change the set value of menu item No. 25 SYSTEM FREQ. For the method to change the set value, refer to "Setting method using the on-screen menus" (page 27) . Once the set value is changed, the outer frame of the display part of SYSTEM FREQ and the characters in SYSTEM on the front display panel start flashing.
- 3 The confirmation screen is displayed to enable the changed set value.

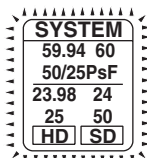

- 2 Press the MENU button.

```

SETUP-MENU SET OK?
YES<PLAY>/NO<STOP>

System menu item No.25
(SYSTEM FREQ) setting
has been changed.
    
```

- To enable the change to set value, press the PLAY button. Then the system resumes and starts again in the selected mode.
- To disable the change to the set value, press the STOP button. Any other changes in the set up menu items are also disabled.

### <Note>

If the system is restarted when a cassette remains in the unit, the cassette will automatically be ejected.

# Setup menus

## Menus which are displayed

The menus displayed differ depending on the setting selected for menu item No.25 SYSTEM FREQ.

NO.	Item	Menu No.25 SYSTEM FREQ						
		59/60	23/24	50i/25P	25 (HD)	25 (SD)	50 (HD)	50 (SD)
05	ENCODER SEL							
06	V LEVEL CTRL							
12	SYS H (HD)							
14	SYS SC (SD)							
15	VO SYS H (SD)							
16	SD SYS H (SD)							
18	SCH COAR (SD)							
19	SCH FINE (SD)							
20	AV PHASE							
25	SYSTEM FREQ							
26	HD SYS H ADV		No	No	No	No	No	No
001	LOCAL ENA							
002	TAPE TIMER		No		No	No	No	No
003	REMAIN SEL							
005	SUPER							
006	DISPLAY SEL							
007	CHARA H-POS							
008	CHARA V-POS							
009	CHARA TYPE							
020	SYS FORMAT		No		No	No	No	No
022	PB FORMAT							
023	FORMAT SEL							
030	HD FREQUENCY			No	No	No	No	No
031	OUT REF		No					
032	REC REF		No	No	No	No	No	No
100	SEARCH ENA							
101	SHTL MAX							
102	FF. REW MAX							
104	REF ALARM							
105	AUTO EE SEL		No		No	No	No	No
106	EJECT EE SEL							
107	EE MODE SEL		No		No	No	No	No
108	PLAY DELAY							
109	CAP. LOCK		No		No	No	No	No
110	AUTO REW							
112	FRZ MODE SEL							
114	REC INH LAMP							
115	EJECT SW INH		No		No	No	No	No
118	SP MODE INH		No		No	No	No	No
119	CONFI REC		No		No	No	No	No
134	ARARM BEEP							
140	OUTPUT		No		No	No	No	No
152	HUMID OPE							
154	AUTO BACK		No		No	No	No	No
155	AUTO REC		No		No	No	No	No
160	MEMORY MODE							
161	CTL BGN/TC BGN							
162	END							
163	REPT MODE							
180	BATTERY SEL							
181	TYPE-A NEAR							
182	TYPE-A END							
183	TYPE-B NEAR							



## Setup menus (continued)

NO.	Item	Menu No.25 SYSTEM FREQ						
		59/60	23/24	50i/25P	25 (HD)	25 (SD)	50 (HD)	50 (SD)
184	TYPE-B END							
190	V IN SEL INH		No		No	No	No	No
191	A IN SEL INH		No		No	No	No	No
202	ID SEL							
302	CONFI EDIT		No		No	No	No	No
303	AUD EDIT IN		No		No	No	No	No
304	AUD EDIT OUT		No		No	No	No	No
307	AFTER CUE-UP		No		No	No	No	No
320	EDIT RPLCE1		No		No	No	No	No
321	EDIT RPLCE2		No		No	No	No	No
322	EDIT RPLCE3		No		No	No	No	No
323	EDIT RPLCE4		No		No	No	No	No
324	EDIT RPLCEC		No		No	No	No	No
400	STILL TIMER							
401	SRC PROTECT							
402	DRUM STDBY							
403	STOP PROTECT							
500	VITC BLANK		No		No		No	
501	VITC POS-1		No		No		No	
502	VITC POS-2		No		No		No	
503	TCG MODE		No		No	No	No	No
504	RUN MODE		No		No	No	No	No
505	TCG REGEN		No		No	No	No	No
506	REGEN MODE		No		No	No	No	No
507	EXT TC SEL		No		No	No	No	No
508	BINARY GP		No		No	No	No	No
509	PHASE CORR							
510	TCG CF FLAG		No		No	No	No	No
511	DF MODE		No	No	No	No	No	No
512	TC OUT REF		No		No	No	No	No
513	VITC OUT							
514	HD EMBD VITC					No		No
515	HD EMBD LTC					No		No
601	VIDEO INT SG		No		No	No	No	No
602	SDI IN MODE		No		No	No	No	No
603	V-MUTE SEL							
604	FREEZE SEL							
615	V OUT SEL				No	No	No	No
619	V_FILTER	No	No	No	No		No	No
620	DOWNCON MODE				No		No	
621	UPCONV MODE				No	No	No	No
626	D/C ENH H				No		No	
627	D/C ENH V				No		No	
628	U/C ENH H				No	No	No	No
629	U/C ENH V				No	No	No	No
630	1080i→HD_OUT		No		No	No	No	No
632	720p→HD_OUT		No		No	No		No
636	SD→HD_OUT		No		No	No	No	No
650	STYLE							
651	HUE STYLE (SD)			No	No	No	No	No
653	Y LVL (HD)							
654	Pb LVL (HD)							
655	Pr LVL (HD)							
656	BK LVL (HD)							
658	Y LVL (SD)							
659	Pb LVL (SD)							
660	Pr LVL (SD)							

## Setup menus (continued)

NO.	Item	Menu No.25 SYSTEM FREQ						
		59/60	23/24	50i/25P	25 (HD)	25 (SD)	50 (HD)	50 (SD)
661	BK LVL (SD)							
662	V LEVEL							
663	C LEVEL							
664	HUE							
665	SETUP LVL							
676	BLK CLIP			No	No	No	No	No
680	CC (F1) BLANK		No	No	No	No	No	No
681	CC (F2) BLANK		No	No	No	No	No	No
682	VO SETUP (HD) (For AJ-HD1400P)			No	No	No	No	No
683	VO SETUP (SD) (For AJ-HD1400P)			No	No	No	No	No
684	EDH (SD)				No		No	
685	ESR MODE (SD)			No	No	No	No	No
686	CCR MODE (SD)			No	No	No	No	No
687	SDI INDEX 0		No		No		No	
689	COMP MODE		No	No	No	No	No	No
690	UMID REC		No		No	No	No	No
691	UMID GEN		No		No	No	No	No
692	UMID POS		No		No	No	No	No
693	GAMMA SEL							
695	BLANK LINE		No		No	No	No	No
701	CH1 IN LV		No		No	No	No	No
702	CH2 IN LV		No		No	No	No	No
706	CH1 OUT LV							
707	CH2 OUT LV							
710	MONIL OUT LV							
711	MONIR OUT LV							
712	MONI OUT							
724	REC CH3/4		No		No	No	No	No
730	REC CUE		No		No	No	No	No
731	PB FADE							
732	EMBEDDED AUD							
746	MONI CH SEL							
750	ANA CH1/2 SEL							
759	DV PB ATT		No		No	No	No	No
760	REC PT MUTE		No		No	No	No	No
762	AUD RATE CON							
765	CUE OUT SEL							
781	IN IMP SEL		No		No	No	No	No
782	EMB CH SEL							
783	AUDIO CH SEL							
784	MONI SEL INH							
880	DIF SPEED		No		No	No	No	No
882	DIF IN CH		No		No	No	No	No
883	DIF OUT CH		No		No	No	No	No
886	DIF CONFIG		No		No	No	No	No
890	DIF AUD OUT		No		No	No	No	No
891	DIF DV AUDIO		No		No	No	No	No
892	DIF SIG CMD		No		No	No	No	No
894	HD→DIF OUT		No		No	No	No	No
895	50M→DIF OUT		No		No	No	No	No
896	25M→DIF OUT		No		No	No	No	No
899	DIF SUPER		No		No	No	No	No
A02	P. ON LOAD							
A04	PF1 ASSIGN							
A05	PF2 ASSIGN							
A06	PF3 ASSIGN							

## Setup menus (continued)

### Video output signal adjustments

The control matrix for the adjustments is shown in the table below.

This function is not available for IEEE1394 digital output.

**When "CMPNT" has been selected as the menu item No.650 STYLE setting**

Setting		Adjustment item	
05: ENCODER SEL	06: V LEVEL CTRL	653: Y LVL (HD) 654: Pb LVL (HD) 655: Pr LVL (HD) 656: BK LVL (HD)	658: Y LVL (SD) 659: Pb LVL (SD) 660: Pr LVL (SD) 661: BK LVL (SD)
LOCAL	HD	AJ-HD1400	AJ-HD1400
	SD		
	BOTH		
BOTH	HD	External encoder remote controller/ AJ-HD1400	AJ-HD1400
	SD	AJ-HD1400	External encoder remote controller/ AJ-HD1400
	BOTH	External encoder remote controller/ AJ-HD1400	External encoder remote controller/ AJ-HD1400

#### AJ-HD1400:

Only adjustments of the setup menu items are performed.

#### External encoder remote controller/AJ-HD1400:

Adjustments can be performed from both the external encoder remote controller and setup menus.

#### <Notes>

- Use the AJ-ER50 as the external encoder remote controller. However, its "VIDEO PHASE" and "SYNC PHASE" controls will not work.
- During menu operations and operations using the PF function, operations from the external encoder remote controller cannot be accepted.

**When "CMPST" has been selected as the menu item No.650 STYLE setting**

Setting		Adjustment item
05: ENCODER SEL	06: V LEVEL CTRL	662: V LEVEL 663: C LEVEL 664: HUE 665: SETUP LVL
LOCAL	HD	AJ-HD1400
	SD	
	BOTH	
BOTH	HD	External encoder remote controller/ AJ-HD1400
	SD	
	BOTH	

#### AJ-HD1400:

Only adjustments of the setup menu items are performed.

#### External encoder remote controller/AJ-HD1400:

Adjustments can be performed from both the external encoder remote controller and setup menus.

#### <Note>

Use the MT-200/2000 (manufactured by Musashi and recommended by Panasonic) as the external encoder remote controller. However, its VIDEO PHASE, SYNC PHASE and SC PHASE controls will not work.

During menu operations and operations using the PF function, operations from the external encoder remote controller cannot be accepted.

# Setup menus (continued)

## SYSTEM

No./Item	Description of setting
05 ENCODER SEL	<p>For setting whether to perform the various adjustments for the video output signals using this VTR or using an external encoder remote controller.</p> <p><b>0001 LOCAL :</b> The various adjustments for the video output signals are performed using this VTR.</p> <p><b>0002 BOTH :</b> The various adjustments for the video output signals are performed using both this VTR and an external encoder remote controller.</p> <p><b>&lt;Notes&gt;</b></p> <ul style="list-style-type: none"> <li>For video adjustments, refer to "Video output signal adjustments" (page 35).</li> <li>If the signals are adjusted with the external encoder remote controller, the adjusted values are reflected in the setup menu. However, the adjusted numerical values will not be stored unless about 1 minute has elapsed after completion of the adjustment operation. If the unit is turned off after executing the adjustments with the external encoder remote controller, it is necessary to wait about 1 minute before turning off the power.</li> <li>Settings in this menu are not effective for the IEEE1394 digital output.</li> </ul>
06 V LEVEL CTRL	<p>For selecting what is to be controlled when the video output level is to be adjusted by an external encoder remote controller.</p> <p><b>0000 HD :</b> The HD video output level can be adjusted.</p> <p><b>0001 SD :</b> The SD video output level can be adjusted.</p> <p><b>0002 BOTH :</b> Both the HD and SD video output levels can be adjusted.</p>
12 SYS H (HD)	<p>For adjusting the system phase of the HD SDI output signals. (in 13.5 ns increments).</p> <p>- :Phase advances. + :Phase delays.</p> <p><b>0000 -1100</b> : : <b>1100 0</b> : : <b>2200 1100</b></p> <p><b>&lt;Notes&gt;</b></p> <ul style="list-style-type: none"> <li>When menu item No. 25 SYSTEM FREQ is set to 50i/25P, 25 (HD), 25(SD), 50 (HD) or 50 (SD), the setting range is from -1320 - 0 - 1320.</li> <li>When menu item No. 25 SYSTEM FREQ is set to 23/24, the setting range is from -1375 - 0 - 1375.</li> </ul>
14 SYS SC (SD)	<p>For adjusting the system phase of the analog composite output and SD SDI output signals (total variable range of over ±180 degrees).</p> <p>- :Phase advances. + :Phase delays.</p> <p><b>0000 -108</b> : : <b>0108 0</b> : : <b>0216 108</b></p>
15 VO SYS H (SD)	<p>For adjusting the system phase of the analog composite output signals (in 37 ns increments).</p> <p>- :Phase advances. + :Phase delays.</p> <p><b>0000 -858</b> : : <b>0858 0</b> : : <b>1716 858</b></p> <p><b>&lt;Note&gt;</b> The setting range is -864 to 0 to 864 when 50i/25P, 25 (HD) or 25 (SD) is selected as the menu item No.25 SYSTEM FREQ setting.</p>

No./Item	Description of setting
16 SD SYS H (SD)	<p>For adjusting the system phase of the SD SDI output signals (in 37 ns increments).</p> <p>- :Phase advances. + :Phase delays.</p> <p><b>0000 -858</b> : : <b>0858 0</b> : : <b>1716 858</b></p> <p><b>&lt;Note&gt;</b> The setting range is -864 to 0 to 864 when 50i/25P, 25 (HD) or 25 (SD) is selected as the menu item No.25 SYSTEM FREQ setting.</p>
18 SCH COAR (SD)	<p>For adjusting the SCH (sub-carrier to horizontal) phase of the analog composite output signals (4 positions in 90-degree increments).</p> <p>The SC phase changes, and the H phase remains unchanged.</p> <p><b>0000 0</b> <b>0001 90</b> <b>0002 180</b> <b>0003 270</b></p>
19 SCH FINE (SD)	<p>For adjusting the SCH (sub-carrier to horizontal) phase of the analog composite output signals (variable range of over ±45 degrees).</p> <p>The SC phase changes, and the H phase remains unchanged.</p> <p>A range of ±180 degrees is covered by using this setting in combination with item No.18 SCH COAR (SD).</p> <p><b>0000 -32</b> : : <b>0032 0</b> : : <b>0064 32</b></p>
20 AV PHASE	<p>For adjusting the phase of the AUDIO output signals in relation to the video output signals (in 20.8 μs increments).</p> <p>- :Audio phase against image advance. + :Audio phase against image delay.</p> <p><b>0000 -100</b> : : <b>0100 0</b> : : <b>0200 100</b></p>

"\_\_\_\_\_" indicates the factory setting.

# Setup menus (continued)

## SYSTEM (continued)

No./Item	Description of setting
25 SYSTEM FREQ	<p>For selecting the system frequency. For details, refer to "Procedure for shifting the system frequency" (page 31).</p> <p>0000 59/60 : The 59.94 Hz or 60 Hz system frequency is selected.</p> <p>0001 50I/25P : The 50 Hz or 25 PsF system frequency is selected. At this setting, the 1080/25 PsF format signals can be recorded and played back in the same way as with the 1080/50I format.</p> <p>0002 23/24 : The 23.98 Hz or 24 Hz system frequency is selected.</p> <p>0003 25(HD) : The 25 Hz system frequency is selected. However, black signals are output from the SD SDI output and analog composite connectors.</p> <p>0004 25(SD) : The 25 Hz system frequency is selected. However, black signals are output from the HD SDI output and analog component connectors.</p> <p>0005 50(HD) : The 50 Hz system frequency is selected. However, black signals are output from the SD SDI output and analog composite connectors.</p> <p>0006 50(SD) : The 50 Hz system frequency is selected. However, black signals are output from the HD SDI output and analog component connectors.</p>
26*1 HD SYS H ADV	<p>For selecting the output whose HD output phase is to be advanced by 90H in relation to the SD output.</p> <p>0000 0H : Both the HD and SD signals are output in phase with the HD and SD REF output signals.</p> <p>0001 90H : The HD signals are output at a phase advanced by 90H from the SD output signals. When the SD REF signal is input, the REF input and SD output are in-phase, and when the HD REF signal is input, the REF input and HD output are inphase.</p> <p>&lt;Notes&gt;</p> <ul style="list-style-type: none"> <li>● The audio signals and TC signal are output in phase with the HD output.</li> <li>● With the 720p format, there is a phase difference of 120H between them.</li> </ul>

\*1 Displayed menus may vary depending on the settings in menu No. 25 SYSTEM FREQ. For details, refer to "Menus which are displayed" (page 32).

## BASIC

No./Item	Description of setting
001 LOCAL ENA	<p>For setting the operable buttons on the front panel when the REMOTE/LOCAL switch is set to "REMOTE."</p> <p>0000 DIS : None of the buttons can be operated.</p> <p>0001 ST&amp;EJ : Only the STOP and EJECT buttons can be operated.</p> <p>0002 ENA1 : All of the buttons with the exception of COUNTER and RESET can be operated.</p> <p>0003 ENA2 : All of the buttons can be operated.</p>
002*1 TAPE TIMER	<p>For setting how the time is to be displayed on the CTL counter display.</p> <p>0000 ±12h : 12-hour display</p> <p>0001 24h : 24-hour display</p>
003 REMAIN SEL	<p>For setting the remaining time on the tape for the respective connectors and the superimposed indications of the total length of the tape.</p> <p>0000 OFF : No displays are superimposed.</p> <p>0001 2L : The remaining tape time is displayed on the second line.</p> <p>0002 1L : The remaining tape time is displayed on the first line.</p> <p>0003 R/TTL : The remaining tape time is displayed on the first line and the total tape duration on the second line.</p> <p>&lt;Note&gt; The information will not be displayed when "2L" or "R/TTL" is set and TIME is selected as the menu item No.006 DISPLAY SEL setting.</p>
005 SUPER	<p>For setting the superimposing of the displays onto various connectors.</p> <p>0000 OFF : The displays are superimposed onto none of the output connectors.</p> <p>0001 CMPST : The displays are superimposed onto the analog composite output.</p> <p>0002 CMPNT : The displays are superimposed onto the HD analog component output.</p> <p>0003 SDSDI : The displays are superimposed onto SD SDI OUT.</p> <p>0004 HSDSI : The displays are superimposed onto HD SDI OUT.</p> <p>0005 CPS&amp;SD : The displays are superimposed onto the analog composite output and SD SDI OUT.</p> <p>0006 CPN&amp;HD : The displays are superimposed onto the HD analog component output and HD SDI OUT.</p> <p>&lt;Notes&gt;</p> <ul style="list-style-type: none"> <li>● The information will not be displayed when the SUPER switch is OFF.</li> <li>● 1394 output is according to Menu No. 899 DIF SUPER.</li> <li>● If the 23.98/24 Hz, 25 Hz (HD), or 50 Hz (HD) mode is selected in menu No. 25 SYSTEM FREQ, no super is displayed on the analog composite output and the SD SDI output.</li> <li>● If the 25 Hz (SD) or 50 Hz (SD) mode is selected, no super is displayed on the analog component output and the HD SDI output.</li> </ul>

" \_\_\_\_ " indicates the factory setting.

# Setup menus (continued)

## BASIC (continued)

No./Item	Description of setting
006 DISPLAY SEL	<p>For setting what the information to be superimposed.</p> <p>0000 <b>TIME :</b> Only the data is displayed. ("Data" refers to the CTL, TC or UB value selected by the COUNTER button.)</p> <p>0001 <b>T&amp;STA :</b> The data and operation status are displayed.</p> <p>0002 <b>T&amp;S&amp;M :</b> The data, operation status and mode are displayed.</p> <p>0003 <b>T&amp;RT :</b> The data and REC TIME are displayed.</p> <p>0004 <b>T&amp;YMD :</b> The data and REC DATE (year/month/day) are displayed.</p> <p>0005 <b>T&amp;MDY :</b> The data and REC DATE (month/day/year) are displayed.</p> <p>0006 <b>T&amp;DMY :</b> The data and REC DATE (day/month/year) are displayed.</p> <p>0007 <b>T&amp;UB :</b> The data and user bits are displayed. The time code is displayed after the user bits when the COUNTER button is set to UB.</p> <p>0008 <b>T&amp;CTL :</b> The data and CTL are displayed. The time code is displayed after the CTL data when the COUNTER button is set to CTL.</p> <p>0009 <b>T&amp;T :</b> The data and time code are displayed.</p> <p><b>&lt;Notes&gt;</b></p> <ul style="list-style-type: none"> <li>Depending on the format used, the following displays appear for the modes. &lt;Format&gt; → &lt;Display&gt; DVCPRO HD-LP → DVCPRO_HD-LP DVCPRO HD → DVCPRO_HD DVCPRO50 → DVCPRO_50 DVCPRO → DVCPRO DV → DV DVCAM → DVCAM</li> <li>When T&amp;S&amp;M is selected as the item setting, an error message is superimposed onto the display when a warning or error occurs.</li> <li>REC TIME and REC DATE are displayed only during DV or DVCAM playback. The operation mode is displayed with the DVCPRO HD-LP, DVCPRO HD, DVCPRO50 or DVCPRO format.</li> </ul>
007 CHARA H-POS	<p>For setting the horizontal position at which the superimposed characters are to be displayed.</p> <p>0000 0 : : 0006 6 : : 0037 37</p> <p><b>&lt;Note&gt;</b> Press the joystick and tilt up/down and right/left to set the character position.</p>
008 CHARA V-POS	<p>For setting the vertical position at which the superimposed characters are to be displayed.</p> <p>0000 0 : : 0023 23 : : 0032 32</p> <p><b>&lt;Note&gt;</b> Press the joystick and tilt up/down and right/left to set the character position.</p>

No./Item	Description of setting
009 CHARA TYPE	<p>For setting the superimposed display and menu display type.</p> <p>0000 <b>WHITE :</b> White characters are displayed on a black background.</p> <p>0001 <b>W/OUT :</b> White characters with black edges are displayed.</p>
020*1 SYS FORMAT	<p>For setting the format in which to record or play back the signals including the HD REF signals.</p> <p>0000 <b>1080i :</b> 1080i mode</p> <p>0001 <b>720p :</b> 720p mode</p>
022 PB FORMAT	<p>For setting the format in which to play back the tape.</p> <p>0000 <b>MANUAL :</b> The tape is played back in the format selected by the menu item No.020 SYS FORMAT and No.023 FORMAT SEL setting.</p> <p>0001 <b>AUTO :</b> The tape is played back in the format selected by the format in which the tape was recorded.</p>
023 FORMAT SEL	<p>For selecting the format when "MANUAL" is selected as the menu item No.022 PB FORMAT setting.</p> <p>0000 <b>HD_LP :</b> The DVCPRO HD-LP format is selected, and the format follows the menu item No.020 SYS FORMAT setting.</p> <p>0001 <b>HD_SP :</b> The DVCPRO HD format is selected, and the format follows the menu item No.020 SYS FORMAT setting.</p> <p>0002 <b>422 :</b> The DVCPRO50 (422) format is selected.</p> <p>0003 <b>411 :</b> The DVCPRO (411) format is selected.</p> <p>0004 <b>DV :</b> The DV format is selected.</p> <p>0005 <b>DVCAM :</b> The DVCAM format is selected.</p>

\*1 Displayed menus may vary depending on the settings in menu No. 25 SYSTEM FREQ. For details, refer to "Menus which are displayed" (page 32).

### <Note>

When the signal format to be output is set to other than DVCPRO HD and an external device is connected to the DV connector, the following settings are recommended.

- Menu No. 022 PB FORMAT:  
MANUAL
- Menu No. 023 FORMAT SEL:  
Format of the tape that is inserted in the unit

"\_\_\_\_\_" indicates the factory setting.

# Setup menus (continued)

## BASIC (continued)

No./Item	Description of setting
030* <sup>1</sup> HD FREQUENCY	<p>For setting the field frequency.</p> <p>0000 59/23 : The field frequency is set to 59.94/23.98 Hz.</p> <p>0001 60/24 : The field frequency is set to 60/24 Hz.</p> <p>&lt;Note&gt; The field frequency which is set here takes effect only when there is no input which supports the OUT REF setting. If there is an input which supports the setting, the field frequency is consistent with the field frequency of input.</p>
031* <sup>1</sup> OUT REF	<p>For selecting the video output reference.</p> <p>0000 AUTO : The REF signal (HD/SD) which is input to the REF connector is automatically identified and serves as the reference. If no signal is supplied to the REF connector, the HD serial input signal serves as the reference. If neither the REF input signal nor HD serial input signal is supplied, the unit's internal reference is used.</p> <p>0001 INPUT : The input signal serves as the reference. If this signal is not available, the unit's internal reference is used.</p> <p>0002 HD REF : The HD REF input signal serves as the reference. If this signal is not available, the unit's internal reference is used.</p> <p>0003 SD REF : The SD REF input signal serves as the reference. If this signal is not available, the unit's internal reference is used.</p> <p>0004 E-AUTO : When the editing mode is selected, the state is the same as when set to "INPUT." When any mode other than the editing mode is selected, the state is the same as when set to "AUTO." For details, refer to "Reference signals" (page 16).</p>
032* <sup>1</sup> REC REF	<p>Select the reference to synchronize the image frames for recording.</p> <p>0000 NORMAL : The video signal which is input is automatically identified and serves as the reference.</p> <p>0001 SLTC : The time code which is input to the HD SDI IN connector is identified and serves as the reference.</p> <p>&lt;Note&gt; When the SLTC is selected, the following settings are necessary to validate the settings for this item.</p> <ul style="list-style-type: none"> <li>● Menu No. 25 SYSTEM FREQ: 59/60</li> <li>● Menu No. 020 SYS FORMAT: 720p</li> <li>● INPUT SELECT button on the front panel: HSDI</li> </ul>

\*1 Displayed menus may vary depending on the settings in menu No. 25 SYSTEM FREQ. For details, refer to "Menus which are displayed" (page 32).

"\_\_\_\_\_" indicates the factory setting.

## Formats for playback

Depending on how the menu item No.020 SYS FORMAT, No.022 PB FORMAT and No.023 FORMAL SEL settings are combined, the formats of the tapes played back by the unit differ as shown in the table below.

022. PB FORMAT	020. SYS FORMAT	023. FORMAT SEL	Playback format	
MANUAL	1080i	HD_LP	DVCPRO HD-LP (1080i)	
		HD_SP	DVCPRO HD (1080i)	
		50M	DVCPRO50 (422)	
		25M	DVCPRO (411)	
		DV	DV	
			DVCAM	DVCAM
	720P	HD_LP	DVCPRO HD-LP (720p)	
		HD_SP	DVCPRO HD (720p)	
		50M	DVCPRO50 (422)	
		25M	DVCPRO (411)	
DV		DV		
		DVCAM	DVCAM	
AUTO	If AUTO is selected as the menu item No.022 PB FORMAT setting, the format applying when the format is not yet detected (when the tape inserted) follows the menu item No.023 FORMAL SEL setting. However, if "DV" or "DVCAM" is selected, operation proceeds as if "HD_LP" is selected.		DVCPRO HD-LP (1080i/720p), DVCPRO HD (1080i/720p), DVCPRO50 (422), DVCPRO (411), DVCPROP (420p), DC or DVCAM format is detected automatically.	

### <Notes>

- When the tape is ejected, the format follows the one selected by menu item No.020 SYS FORMAT setting.
- DVCPRO P playback is not possible.

# Setup menus (continued)

## OPERATION

No./Item	Description of setting
100 SEARCH ENA	To set the transition method to search mode (stick operation). 0000 <b>STICK</b> : Shift to the search mode when the SEARCH button is pressed or when the stick is operated. 0001 <b>KEY</b> : Do not shift to the search mode unless the SEARCH button is pressed.
101 SHTL MAX	For setting the maximum speed in the shuttle mode. 0000 <b>X8.4</b> : 8.4× normal speed 0001 <b>X16</b> : 16× normal speed 0002 <b>X32</b> : 32× normal speed <Note> The maximum speed for the HD SP mode is automatically limited to 25× normal speed.
102 FF.REW MAX	For setting the maximum speed of fast forward or rewind operations. 0000 <b>X16</b> : 16× normal speed 0001 <b>X32</b> : 32× normal speed 0002 <b>X50</b> : 50× normal speed <Notes> ● The maximum speed for the HD SP mode is automatically limited to 25× normal speed. ● The maximum speed for the DV and DVCAM modes is automatically limited to 32× normal speed.
104 REF ALARM	For setting whether a warning is to be displayed when the REF VIDEO signal is not connected. 0000 <b>OFF</b> : No warning is displayed. 0001 <b>ON</b> : A warning is displayed by the flashing STOP lamp.
105*1 AUTO EE SEL	For setting the mode of the VTR, which becomes the EE state when menu item No. 140 OUTPUT is set to "EE." 0000 <b>S/F/R</b> : The mode changes to the EE state when this item is set to STOP, FF, or REW. 0001 <b>STOP</b> : The mode changes to the EE state only when this is set to STOP.
106 EJECT EE SEL	For setting the output conditions of video images and voice when ejecting the tape. 0000 <b>EE</b> : Both the video and audio signals are always output in the EE (electric modulation to electric playback) mode regardless of the setting of the menu No.140 OUTPUT. 0001 <b>BLACK</b> : The output status differs according to the setting of the menu No.140 OUTPUT. EE: The signals are output in the EE mode. TAPE: BLACK is output for the video, and the audio is muted. 0002 <b>GRAY</b> : The output status differs according to the setting of the menu No.140 OUTPUT. EE: The signals are output in the EE mode. TAPE: GRAY is output for the video, and the audio is muted. <Note> When "23/24" mode, "25 (HD/SD)" mode, or "50 (HD/SD)" mode is selected in menu No. 25 SYSTEM FREQ, BLACK is output if "EE" is selected.

No./Item	Description of setting
107*1 EE MODE SEL	For setting the HD SDI and HD analog component output signals in EE mode when HD SDI input is selected. 0000 <b>NORMAL</b> : Signals delayed by the time taken by internal signal processing are output. 0001 <b>THRU</b> : Signal processing is not undertaken internally, and the signals are output without delay at their original timing. <Notes> ● The superimposed information is not displayed when THRU is used as the setting. ● When 1394 or SG is selected for the input signal in edit mode, internal signal is selected forcibly "NORMAL".
108 PLAY DELAY	For setting the play rise time in frame increments. 0000 <b>0</b> : 0015 <b>15</b>
109*1 CAP. LOCK	For selecting in how many field increments the playback framing is to be locked. 0000 <b>2F</b> 0001 <b>4F</b> 0002 <b>8F</b> <Notes> ● "8F" can be selected only when "50i/25p" is selected as the menu item No.25 SYSTEM FREQ setting. ● In the HD LP or HD SP mode, 2F mode is selected when recording and playing back, including editing, regardless of the menu.
110 AUTO REW	For setting whether the tape is to be automatically rewound to its beginning when the tape end is detected. 0000 <b>OFF</b> : The tape is not rewound. 0001 <b>ON</b> : The tape is rewound to its beginning.
112 FRZ MODE SEL	For setting the video output when the mode is transferred from playback images to standby OFF (half loading) mode or EJECT mode. 0000 <b>DIS</b> : The video output is muted. 0001 <b>STBOFF</b> : When the standby OFF (half loading) mode is established, the image played back at that moment is frozen and output. 0002 <b>SOF&amp;EJ</b> : When in the STANDBY OFF mode and the EJECT mode, the image played back at that moment is frozen and output. <Notes> ● The frozen status will be according to the settings in menu No. 604 FREEZE SEL. ● In the EJECT mode, the frozen image will be output only when setup No. 106 EJECT EE is the 1 (BLACK) or 2 (GRAY) setting.
114 REC INH LAMP	For setting the operation of the REC INHIBIT lamp when the cassette is set to the erasure prevention status. 0000 <b>LIGHT</b> : The lamp lights. 0001 <b>FLASH</b> : The lamp flashes. <Note> When the REC INHIBIT switch on the front panel is set to ON, the REC INHIBIT lamp lights at all times regardless of what setting is selected for this menu item.

\*1 Displayed menus may vary depending on the settings in menu No. 25 SYSTEM FREQ. For details, refer to "Menus which are displayed" (page 32).

"\_\_\_\_\_" indicates the factory setting.



# Setup menus (continued)

## OPERATION (continued)

No./Item	Description of setting
115* <sup>1</sup> EJECT SW INH	For setting whether to restrict the operation of the EJECT button on the front panel. 0000 REC : Operation is inhibited while the unit is in the recording mode. 0001 OFF : The EJECT button can be operated in all operation modes.
118* <sup>1</sup> SP MODE INH	For selecting whether to enable or disable recording on a tape which has been recorded using a format other than DVCPRO HD-LP. 0000 OFF : Recording onto the cassette tape is enabled. 0001 ON : Recording onto the cassette tape is disabled.
119* <sup>1</sup> CONFI REC	For selecting whether or not to perform simultaneous playback during normal recording (Other than the frame-by-frame shooting). 0000 OFF : The output for simultaneous playback during normal recording is switched in accordance with the menu item No.140 OUTPUT. EE: EE output TAPE: Simultaneous playback output 0001 ON : Simultaneous playback during normal recording is performed at all times, regardless of the setting of the menu item No.140 OUTPUT.
134 ALARM BEEP	For selecting the alarm sound for condensation, termination of the tape (remaining time of about 2 minutes) or running out of battery power. 0000 OFF : The alarm sound is not activated. 0001 ON : The alarm sound is activated. <Note> If "ON" is selected in menu item No. 152 HUMID OPE, the alarm sound for condensation is not activated even if "ON" is selected.
140* <sup>1</sup> OUTPUT	For selecting the output signals. 0000 EE : <In the STOP mode>: The input signals selected by the setting of the INPUT SELECT button are output. <During recording or editing>: The input signals selected by the setting of the INPUT SELECT button are output: 0001 TAPE : <In the STOP mode> The signals played back from the tape are output. <During recording or editing>: The simultaneous playback signals are output. <Note> In order to select the output signals during recording or editing, set menu item No.119 CONFI REC or No.302 CONFI EDIT.

No./Item	Description of setting
152 HUMID OPE	For setting the unit's operation when condensation has formed. 0000 OFF : The unit does not operate when condensation has formed. 0001 ON : It operates even when condensation has formed but no guarantees are made that the operation will be trouble-free. <Note> Since operating the unit when condensation has formed may damage the tape or give rise to other trouble, the "OFF" setting is recommended under normal circumstances.
154* <sup>1</sup> AUTO BACK	For setting how the follow-on recording function is to be used. (For setting the AUTO BACK function operation which rewinds the tape for several seconds in order to ensure that the video images follow on one from another with no disruptions.) 0000 OFF : The tape is not rewound automatically (no AUTO BACK). 0001 REC-P : The tape is rewound (AUTO BACK) during REC PAUSE, and it then stops in the recording standby status. (When PAUSE is released, the tape runs up, and recording starts.) 0002 ALL : In addition to the function of the 0001 REC-P setting, the tape is rewound (AUTO BACK) during REC PLAY, the tape immediately runs up, and recording starts.

\*1 Displayed menus may vary depending on the settings in menu No. 25 SYSTEM FREQ. For details, refer to "Menus which are displayed" (page 32).

"\_\_\_\_\_" indicates the factory setting.

# Setup menus (continued)

## OPERATION (continued)

No./Item	Description of setting
155*1 AUTO REC	<p>For setting whether the recording/stop is executed automatically in conjunction with the Recording Mark of the HD SDI input signals from our camera recorder or not.</p> <p><b>0000 OFF :</b> Do not to execute the recording/stop automatically.</p> <p><b>0001 TYPE1 :</b> To execute the recording/stop automatically in conjunction with the Recording Mark in the LTC information added to the HD SDI.</p> <p><b>0002 TYPE2 :</b> To execute the recording/stop automatically in conjunction with the Recording Mark in the SVITC information added to the HD SDI.</p> <p><b>&lt;Notes&gt;</b></p> <ul style="list-style-type: none"> <li>● Set the LOCAL/REMOTE switch to the REMOTE position.</li> <li>● For the selection of TYPE 1 or TYPE 2, refer to "Our camera recorder, Recording format, and Recording Mark."</li> <li>● To select TYPE 1 or TYPE 2 to start recording automatically, set this unit to the REC PAUSE mode. It may not operate in any mode other than the REC PAUSE mode. After accepting the auto stop, this unit changes to the REC PAUSE mode.</li> <li>● When this unit is recording in normal operation, the AUTO REC function is not available.</li> </ul>

\*1 Displayed menus may vary depending on the settings in menu No. 25 SYSTEM FREQ. For details, refer to "Menus which are displayed" (page 32).

Our camera recorder, Recording format, and Recording Mark

Model	Recording format	Recording Mark TYPE	Remarks
AJ-HDC27F, H	720/**p over 60p	TYPE1	—
AJ-HDX400	1080/59.94i	_+2	It is possible to switch between TYPE 1 and TYPE 2. TYPE-1 and TYPE-2 are the initial settings for the camera recorder. If the unit is used with the TYPE-1 settings, set the UB MODE of the camera to "FRE RATE". If it is used with the TYPE-2 settings, set the VITC UB MODE to "FRM RATE."
AJ-HDX400E	1080/50i	_+2	
AJ-HDX900	720/59.94p	TYPE1	It is possible to switch between TYPE 1 and TYPE 2. TYPE-1 and TYPE-2 are the initial settings for the camera recorder. If the unit is used with the TYPE-1 settings, set the UB MODE of the camera to "FRE RATE". If it is used with the TYPE-2 settings, set the VITC UB MODE to "FRM RATE."
	720/23.98p over 59.94p	TYPE1	
	720/23.97p over 59.94p	TYPE1	
	1080/59.94i	_+2	
	1080/23.98p over 59.94i	TYPE2	
	1080/23.97p over 59.94i	_+2	
	1080/50i	_+2	
1080/25p over 50i	_+2		
	720/50p	TYPE1	
	720/25p over 50p	TYPE1	

\*2 In the initial settings, the Recording Mark is not overlapped on the HD SDI signals.

No./Item	Description of setting
160 MEMORY MODE	<p>For setting the repeat playback mode.</p> <p><b>0000 OFF :</b> No repeat playback (normal operation).</p> <p><b>0001 M-STOP :</b> The tape stops near the BEGIN point when it is fast forwarded or rewind.</p> <p><b>0002 REPT1 :</b> When the tape reaches the END point, it is rewind to the BEGIN point, and stops.</p> <p><b>0003 CONT :</b> When the tape reaches the END point, it is rewind to the BEGIN point, and plays back, and this is done repeatedly.</p>
161 CTL BGN or TC BGN	<p>For setting the BEGIN point in the repeat playback mode.</p> <p>Either TC or CTL is set as the counter display mode using the COUNTER button.</p> <p>If no mode is set, --- : --- : --- : --- appears, and the tape start serves as the BEGIN point.</p>
162 END	<p>For setting the END point in the repeat playback mode.</p> <p>Either TC or CTL is set as the counter display mode using the COUNTER button.</p> <p>If no mode is set, --- : --- : --- : --- appears, and the tape end serves as the END point.</p>
163 REPT MODE	<p>For setting what images are to be output while the tape returns to the BEGIN point in the repeat playback mode.</p> <p><b>0000 FREEZE :</b> The tape returns to the BEGIN point with the image played back at the END point still frozen.</p> <p><b>0001 BLACK :</b> The tape returns to the BEGIN point while the screen remains black.</p> <p><b>0002 MENU :</b> The tape returns to the BEGIN point following the the settings in menu No. 140 OUTPUT.</p> <p><b>&lt;Note&gt;</b> If the tape end is set as the END point when "FREEZE" is selected, the playback image will not be frozen properly. Set the END point to a place within the range where images are recorded.</p>
180 BATTERY SEL	<p>For setting the type of battery.</p> <p><b>0000 NiCd12 :</b> Settings for 1 pc. 12 V battery (NEAR: 11.2 V, END: 10.6 V)</p> <p><b>0001 NiCd13 :</b> Settings for 1 pc. 13 V battery (NEAR: 12.0 V, END: 10.6 V)</p> <p><b>0002 NiCd14 :</b> Settings for 1 pc. 14 V battery (NEAR: 13.6 V, END: 10.6 V)</p> <p><b>0003 S-LION :</b> Settings for 1 pc. lithium-ion battery "BP-L90A". (NEAR: 11.7 V, END: 10.6 V)</p> <p><b>0004 I-LION :</b> Settings for 1 pc. lithium-ion battery "ENDURA80". (NEAR: 12.9 V, END: 12.4 V)</p> <p><b>0005 TYPE-A :</b> Setting for using the battery selected by the menu item No.181 TYPE-A NEAR item and No.182 TYPE-A END item</p> <p><b>0006 TYPE-B :</b> Setting for using the battery selected by the menu item No.183 TYPE-B NEAR item and No.184 TYPE-B END item</p>

"\_\_\_\_\_" indicates the factory setting.

# Setup menus (continued)

## OPERATION (continued)

No./Item	Description of setting
181* <sup>1</sup> TYPE-A NEAR	For setting (in increments of 0.1 V) the voltage level at which the counter flashes as warning for TYPE-A battery (selected as the menu item No.180 BATTERY SEL item). Use when adjusting the settings for multiple batteries or new type batteries. 0000 10.6 : : 0023 12.9 : : 0044 15.0 <Note> When this item has been set to a voltage level close to 15.0 V, the counter display may flash even when an AC power source is being used.
182* <sup>1</sup> TYPE-A END	For setting (in increments of 0.1 V) the voltage level at which the TYPE-A battery (selected as the menu item No.180 BATTERY SEL item) is to be automatically turned off. Use when adjusting the settings for multiple batteries or new type batteries. 0000 10.6 : : 0018 12.4 : : 0034 14.0
183* <sup>1</sup> TYPE-B NEAR	For setting (in increments of 0.1 V) the voltage level at which the counter flashes as warning for TYPE-B battery (selected as the menu item No.180 BATTERY SEL item). Use when adjusting the settings for multiple batteries or new type batteries. 0000 10.6 : : 0023 12.9 : : 0044 15.0 <Note> When this item has been set to a voltage level close to 15.0 V, the counter display may flash even when an AC power source is being used.
184* <sup>1</sup> TYPE-B END	For setting (in increments of 0.1 V) the voltage level at which the TYPE-B battery (selected as the menu item No.180 BATTERY SEL item) is to be automatically turned off. 0000 10.6 : : 0018 12.4 : : 0034 14.0
190* <sup>2</sup> V IN SEL INH	For selection of the video input switching mode with the INPUT SELECT switch. 0000 OFF : Video input switching with the INPUT SELECT switch is enabled. 0001 ON : Video input switching with the INPUT SELECT switch is prohibited. 0002 REC : After this unit shifts to recording (except editing), video input switching with the INPUT SELECT switch is prohibited.

No./Item	Description of setting
191* <sup>2</sup> A IN SEL INH	Select the audio input switching mode with the INPUT SELECT switch. 0000 OFF : Select the audio input switching mode with the INPUT SELECT switch. 0001 ON : Video input switching with the INPUT SELECT switch is prohibited. 0002 REC : After this unit shifts to recording (except editing), video input switching with the INPUT SELECT switch is prohibited.

- \*1 Even if the RESET button is pressed while pressing the SEARCH button, the value may not return to the factory setting.
- \*2 Displayed menus may vary depending on the settings in menu No. 25 SYSTEM FREQ. For details, refer to "Menus which are displayed" (page 32).

## INTERFACE

No./Item	Description of setting
202 ID SEL	For setting the ID information to be returned to the controller. 0000 OTHER : The ID information of the VTR other than DVCPRO is set. 0001 DVCPRO : The DVCPRO ID information is set. 0002 ALL : Set this only when the unit is connected to a Panasonic controller (such as the AG-A850, optional accessory). <Note> Select 1 (DVCPRO) or 2 (ORIG) if "23/24," "25(HD)," "25(SD)," "50(HD)" or "50(SD)" is selected as the menu item No.25 SYSTEM FREQ setting.

"\_\_\_\_\_" indicates the factory setting.

# Setup menus (continued)

## EDIT

No./Item	Description of setting
302* <sup>1</sup> CONF1 EDIT	For selecting whether to perform simultaneous playback during editing. 0000 OFF : Simultaneous playback is not performed. 0001 ON : Simultaneous playback is performed.
303* <sup>1</sup> AUD EDIT IN	For selecting how to connect the digital audio edit IN points. 0000 CUT : Cut processing 0001 FADE : V-fade processing
304* <sup>1</sup> AUD EDIT OUT	For selecting how to connect the digital audio edit OUT points. 0000 CUT : Cut processing 0001 FADE : V-fade processing
307* <sup>1</sup> AFTER CUE-UP	For selecting the VTR's mode upon completion of the cue-up operation. 0000 STOP : The VTR is set to the STOP mode. 0001 STILL : The VTR is set to the still picture (SHTL STILL) mode. 0002 STILL2 : The VTR is set to the still picture (VAR STILL) mode.
320* <sup>1</sup> EDIT RPLCE1	For setting the allocation of the channels for the analog audio presets of a controller when a controller without a function to control the edit presets of the digital audio signals is used to edit the digital audio signals of the VTR. The VTR's CH1 edit presets are set to ON or OFF following the analog audio signals specified by the controller. 0000 N-DEF : Not set. 0001 CH1 : The analog CH1 edit presets are followed. 0002 CH2 : The analog CH2 edit presets are followed. 0003 CH1+2 : The analog CH1 or CH2 edit presets are followed.
321* <sup>1</sup> EDIT RPLCE2	As with menu item No.320, the VTR's CH2 edit presets are set to ON or OFF following the analog audio signals specified by the controller. 0000 N-DEF : Not set. 0001 CH1 : The analog CH1 edit presets are followed. 0002 CH2 : The analog CH2 edit presets are followed. 0003 CH1+2 : The analog CH1 or CH2 edit presets are followed.
322* <sup>1</sup> EDIT RPLCE3	As with menu item No.320, the VTR's CH3 edit presets are set to ON or OFF following the analog audio signals specified by the controller. 0000 N-DEF : Not set. 0001 CH1 : The analog CH1 edit presets are followed. 0002 CH2 : The analog CH2 edit presets are followed. 0003 CH1+2 : The analog CH1 or CH2 edit presets are followed.

No./Item	Description of setting
323* <sup>1</sup> EDIT RPLCE4	As with menu item No.320, the VTR's CH4 edit presets are set to ON or OFF following the analog audio signals specified by the controller. 0000 N-DEF : Not set. 0001 CH1 : The analog CH1 edit presets are followed. 0002 CH2 : The analog CH2 edit presets are followed. 0003 CH1+2 : The analog CH1 or CH2 edit presets are followed.
324* <sup>1</sup> EDIT RPLCEC	As with menu item No.320, the VTR's CUE edit presets are set to ON or OFF following the analog audio signals specified by the controller. 0000 N-DEF : Not set. 0001 CH1 : The analog CH1 edit presets are followed. 0002 CH2 : The analog CH2 edit presets are followed. 0003 CH1+2 : The analog CH1 or CH2 edit presets are followed.

\*1 Displayed menus may vary depending on the settings in menu No. 25 SYSTEM FREQ. For details, refer to "Menus which are displayed" (page 32).

"\_\_\_\_\_" indicates the factory setting.

# Setup menus (continued)

## TAPE PROTECT

No./Item	Description of setting
400 STILL TIMER	For setting the time to be taken before the unit is set in the tape protection mode when it is left standing in the STOP or STILL status. (Units: S = seconds, min = minutes) 0000 0.5S 0001 5S 0002 10S 0003 20S 0004 30S 0005 40S 0006 50S 0007 1min 0008 2min <Note> When a DV, DVCAM or an unused tape is used, or a DVCPRO HD/DVCPRO50/DVCPRO tape is used in the EE mode, any setting above 2 (10S) will result in a setting time of 10 seconds.
401 SRC PROTECT	For setting the operation to be performed in the tape protection mode when the unit is left standing in the STILL status (JOG/VAR/SHTL). 0000 STEP : STEP FWD 0001 HALF : STANDBY OFF (HALF LOADING) <Note> When STEP FWD is selected, the unit is automatically transferred to the standby OFF (half loading) mode when the unit is left standing in the STOP mode for a total of 30 minutes (or 1 minute for DV or DVCAM tape).
402 DRUM STDBY	For setting the cylinder operation in the standby OFF (half loading) mode. 0000 OFF The cylinder stops rotating. 0001 ON The cylinder continues to rotate.
403 STOP PROTECT	For setting the operation to be performed in the tape protection mode when the unit is left standing in the STOP status. 0000 STEP : STEP FWD 0001 HALF : STANDBY OFF (HALF LOADING) <Note> When STEP FWD is selected, the unit is automatically transferred to the standby OFF (half loading) mode when the unit is left standing in the STOP mode for a total of 30 minutes (or 1 minute for DV or DVCAM tape).

“\_\_\_\_\_” indicates the factory setting.

## TIME CODE

No./Item	Description of setting
500*1 VITC BLANK	For setting whether to output the VITC signal at the position which is set using menu items No.501 VITC POS-1 and No.502 VITC POS-2. 0000 BLANK : The VITC signal is not output. 0001 THRU : The VITC signal is output. <Note> This setting takes effect only with the SD output (analog composite output and SD SDI output).
501*1,2 VITC POS-1	For setting the position where the VITC signal is to be inserted. <525 mode> <625 mode> 0000 10L 0000 7L : : : : 0006 16L 0004 11L : : : : 0010 20L 0015 22L <Notes> ● The same line as the one selected by menu item No.502 VITC POS-2 and No.692 UMID POS cannot be selected. ● This setting takes effect only with the SD output (analog composite output and SD SDI output).
502*1,2 VITC POS-2	For setting the position where the VITC signal is to be inserted. <525 mode> <625 mode> 0000 10L 0000 7L : : : : 0008 18L 0008 13L : : : : 0010 20L 0015 22L <Notes> ● The same line as the one selected by menu item No.501 VITC POS-1 and No.692 UMID POS cannot be selected. ● This setting takes effect only with the SD output (analog composite output and SD SDI output).
503*1 TCG MODE	For setting the synchronization of the internal time code generator. 0000 SW : When the TCG switch on the front panel is set to REGEN or PRESET, the selection is complied. 0001 AUTO : REGEN or PRE is automatically selected depending on the operation mode. When editing (including a chained shot): REGEN is selected. Other than the above: PRE is selected.
504*1 RUN MODE	For setting the operation mode in which the internal time code generator runs. 0000 REC : The generator runs only while recording is in progress. 0001 FREE : The generator runs while the power is on regardless of the unit's operation mode.
505*1 TCG REGEN	For setting the signal to be regenerated when the TCG (time code generator) is in the regeneration mode. 0000 TC&UB : Both the time code and user bits are regenerated. 0001 TC : Only the time code is regenerated. 0002 UB : Only the user bits is regenerated.

\*1 Displayed menus may vary depending on the settings in menu No. 25 SYSTEM FREQ. For details, refer to “Menus which are displayed” (page 32).

\*2 Even if the RESET button is pressed while pressing the SEARCH button, the value may not return to the factory setting.

# Setup menus (continued)

## TIME CODE (continued)

No./Item	Description of setting
506* <sup>1</sup> REGEN MODE	For selecting the editing mode range when the VTR is operating in the REGEN mode while performing editing operations with "AUTO" selected as the menu item No.503 TCG MODE setting. 0000 <b>AS&amp;IN</b> : Regeneration applies during assemble or insert editing. 0001 <b>ASSEM</b> : Regeneration applies during assemble editing. 0002 <b>INSRT</b> : Regeneration applies during insert editing. <Note> At the time of frame-by-frame shooting, the operations are equivalent to assemble editing.
507* <sup>1</sup> EXT TC SEL	For selecting the time code to be used when an external time code is used. 0000 <b>LTC</b> : The LTC information of the TIME CODE IN connector is used. 0001 <b>SLTC</b> : The LTC information added to the serial signals which are supplied to the HD SDI IN connector is used. 0002 <b>SVITC</b> : The VITC information added to the serial signals which are supplied to the HD SDI IN connector is used. <Note> When selecting "1394" with the INPUT VIDEO switch on the front panel, the time code input to IEEE1394 digital input/output connector is used. The VITC information will not be superimposed onto the video signal output when recording is performed or the EE mode is established. The LTC information and VITC information are not superimposed onto the HD serial output signals.
508* <sup>1</sup> BINARY GP	For setting the usage status for the user bits of the time code generated by the TCG. 0000 <b>000</b> : No character set specified 0001 <b>001</b> : 8-bit character set complying with the ISO646 and ISO2022 standards 0002 <b>010</b> : Undefined 0003 <b>011</b> : Undefined 0004 <b>100</b> : Undefined 0005 <b>101</b> : Page/line 0006 <b>110</b> : Undefined 0007 <b>111</b> : Undefined
509 PHASE CORR	For setting whether to control the phase correction of the LTC output during playback. 0000 <b>OFF</b> : The phase correction is not controlled. 0001 <b>ON</b> : The phase correction is controlled.
510* <sup>1</sup> TCG CF FLAG	For selecting whether to set the CF flag of the TCG to ON. 0000 <b>OFF</b> : The CF flag is set to OFF. 0001 <b>ON</b> : The CF flag is set to ON.

No./Item	Description of setting
511* <sup>1</sup> DF MODE	For selecting whether to use the DF or NDF mode for CTL and TCG. 0000 <b>DF</b> : The drop frame (DF) mode is used. 0001 <b>NDF</b> : The non-drop frame (NDF) mode is used.
512* <sup>1</sup> TC OUT REF	When the TCG switch of the front panel is set to EXT, it switches the phase of time code output from the TC OUT connector for external LTC input. (In EE mode only) 0000 <b>VOUT</b> : Match the output image. 0001 <b>TC_IN</b> : Match the external time code input.
513 VITC OUT	For selecting how to output the VITC signal which is superimposed onto the output video signal. 0000 <b>SBC</b> : In the playback mode, the time code recorded in the SBC area* <sup>A</sup> is output. 0001 <b>VAUX</b> : In the playback mode, the time code recorded in the VAUX area* <sup>B</sup> is output. <Notes> ● The VITC information which is detected by the HD serial input is automatically recorded in the VAUX area when the images are recorded. ● When "23/24," "25(HD)," "25(SD)," "50(HD)" or "50(SD)" is selected as the menu item No.25 SYSTEM FREQ setting and VAUX is selected as the VITC OUT setting, the time code which is output may not be continuous.
514* <sup>1</sup> HD EMBD VITC	For selecting whether to superimpose the VITC information onto the HD serial output. 0000 <b>OFF</b> : The VITC information is not superimposed. 0001 <b>ON</b> : The VITC information is superimposed.
515* <sup>1</sup> HD EMBD LTC	For selecting whether to superimpose the LTC information onto the HD serial output. 0000 <b>OFF</b> : The LTC information is not superimposed. 0001 <b>ON</b> : The LTC information is superimposed.

\*1 Displayed menus may vary depending on the settings in menu No. 25 SYSTEM FREQ. For details, refer to "Menus which are displayed" (page 32).

\*A The SBC (Sub Code Data) area is an area that exists separately from the video and audio area on the helical track and contains the tape management information, such as the time code, in compliance with the SMPTE/EBU and the recording time. As with the ordinary LTC (Linear Time Code), the time code can be read even when rewinding/fast-forwarding and can be read out when the tape stops.

\*B The VAUX (Video Auxiliary Data) area is an area in the video area on the helical track and contains information related to the video data.

"\_\_\_\_\_" indicates the factory setting.

# Setup menus (continued)

## VIDEO

No./Item	Description of setting
601* <sup>1</sup> VIDEO INT SG	For selecting the type of internal standard signals. 0000 100%CB : A 100% color bar signal is selected. 0001 75%CB : A 75% color bar signal is selected. 0002 SMPTE : An SMPTE color bar signal is selected. 0003 ARIB : An ARIB color bar signal is selected. 0004 BLACK : A black signal is selected.
602* <sup>1</sup> SDI IN MODE	For selecting how to process the serial input. 0000 DR OFF : The 8 higher bits whose two lower bits have been rounded off are recorded. 0001 DR ON : The dynamically rounded 8 higher bit signal is recorded.
603 V-MUTE SEL	For setting whether to mute the video output signal when a blank part of the tape is detected during playback. 0000 N-MUTE : The video output signal is not muted. (It is frozen.) 0001 GRAY : The video output signal is muted and turned gray. 0002 BLACK : The video output signal is muted and turned black. 0003 NOISE : The video output signal is muted and turned into noise.
604 FREEZE SEL	For selecting the freeze mode of the still pictures and the slow play mode. 0000 FIELD : Field freeze, field slow 0001 FRAME : Frame freeze, frame slow <Note> For IEEE 1394 digital output, if format conversion is not executed, the frames may freeze or slow down regardless of the settings in this item.
615* <sup>1</sup> V OUT SEL	For selecting what signals are to be output from the VIDEO OUT1 output connector. 0000 CMPNT : The HD component signals are output. 0001 CMPST : Composite signals are output. <Note> When the CMPST is selected, the Pb and Pr of the analog HD component signals are muted.
619* <sup>1</sup> V_FILTER	This is used to select the method to process the images using the vertical filter during down-conversion. 0000 FIELD : The images are processed by field basis. 0001 FRAME : The images are processed by frame basis. <Note> When "FRAME" has been selected, the resolution is improved, but the images may flicker.
620* <sup>1</sup> DOWNCON MODE	For setting the image processing during down-conversion. 0000 FIT_V : Side cut mode 0001 FIT_H : Letter-box mode 0002 FIT_HV : Squeeze mode

No./Item	Description of setting
621* <sup>1</sup> UPCONV MODE	For setting the image processing during up-conversion. 0000 FIT_V : Side panel mode 0001 FIT_H : Top and bottom cut-off in vertical direction 0002 FIT_HV : Stretch mode
626* <sup>1</sup> D/C ENH H	For enhancing the horizontal outlines during down-conversion. 0000 0dB 0001 +1dB
627* <sup>1</sup> D/C ENH V	For enhancing the vertical outlines during down-conversion. 0000 0dB 0001 +1dB
628* <sup>1</sup> U/C ENH H	For enhancing the horizontal outlines during up-conversion. 0000 0dB 0001 +1dB
629* <sup>1</sup> U/C ENH V	For enhancing the vertical outlines during up-conversion. 0000 0dB 0001 +1dB
630* <sup>1</sup> 1080i → HD_OUT	For selecting the HD output signal format during 1080i tape playback or in the 1080i EE mode. 0000 1080i 0001 720p <Note> This item's setting cannot be changed while a tape is being recorded or while the recording pause mode is established.
632* <sup>1</sup> 720p → HD_OUT	For selecting the HD output signal format during 720p tape playback or in the 720p EE mode. 0000 1080i 0001 720p <Note> This item's setting cannot be changed while a tape is being recorded or while the recording pause mode is established.
636* <sup>1</sup> SD → HD_OUT	For selecting the HD output signal format during SD tape (DVCPR050, DVCPR0, DV or DVCAM) playback. 0000 1080i 0001 720p
650 STYLE	0000 CMPNT : Level adjustment mode for the component style 0001 CMPST : Level adjustment mode for the composite style

\*1 Displayed menus may vary depending on the settings in menu No. 25 SYSTEM FREQ. For details, refer to "Menus which are displayed" (page 32).

"\_\_\_\_\_" indicates the factory setting.

# Setup menus (continued)

## VIDEO (continued)

No./Item	Description of setting
651*1 HUE STYLE (SD) <sup>DW</sup>	For selecting the rotational axis of the chroma phase adjustment. 0000 <b>Pb-Pr</b> : The axis rotates in a perfect circle on the SDI (component style) vectorscope. 0001 <b>U-V</b> : The axis rotates in a perfect circle on the analog (composite style) vectorscope.
653 Y LVL (HD) <sup>UP</sup>	For adjusting the Y level of the HD SDI or HD analog component output. (-∞ to 0 dB to +3 dB) 0000 0.0% : : 1000 100.0% : : 1413 141.3% <Note> This setting takes effect when "CMPNT" has been selected as the menu item No.650 setting.
654 Pb LVL (HD) <sup>UP</sup>	For adjusting the PB level of the HD SDI or HD analog component output. (-∞ to 0 dB to +3 dB) 0000 0.0% : : 1000 100.0% : : 1413 141.3% <Note> This setting takes effect when "CMPNT" has been selected as the menu item No.650 setting.
655 Pr LVL (HD) <sup>UP</sup>	For adjusting the PB level of the HD SDI or HD analog component output. (-∞ to 0 dB to +3 dB) 0000 0.0% : : 1000 100.0% : : 1413 141.3% <Note> This setting takes effect when "CMPNT" has been selected as the menu item No.650 setting.
656 BK LVL (HD) <sup>UP</sup>	For adjusting the black level of the HD SDI or HD analog component output. 50 -10.0% : : 150 0.0% : : 250 +10.0% <Note> This setting takes effect when "CMPNT" has been selected as the menu item No.650 setting.
658 Y LVL (SD) <sup>DW</sup>	For adjusting the Y level of the SD SDI output and analog composite output. (-∞ to 0 dB to +3 dB) 0000 0.0% : : 1000 100.0% : : 1413 141.3% <Note> This setting takes effect when "CMPNT" has been selected as the menu item No.650 setting.
659 Pb LVL (SD) <sup>DW</sup>	For adjusting the PB level of the SD SDI output and analog composite output. (-∞ to 0 dB to +3 dB) 0000 0.0% : : 1000 100.0% : : 1413 141.3% <Note> This setting takes effect when "CMPNT" has been selected as the menu item No.650 setting.

No./Item	Description of setting
660 Pr LVL (SD) <sup>DW</sup>	For adjusting the PR level of the SD SDI output and analog composite output. (-∞ to 0 dB to +3 dB) 0000 0.0% : : 1000 100.0% : : 1413 141.3% <Note> This setting takes effect when "CMPNT" has been selected as the menu item No.650 setting.
661 BK LVL (SD) <sup>DW</sup>	For adjusting the black level of the SD SDI output and analog composite output. 50 -10.0% : : 150 0.0% : : 250 +10.0% <Note> This setting takes effect when "CMPNT" has been selected as the menu item No.650 setting.
662 V LEVEL	For adjusting the video level of the HD SDI, analog component output, SD SDI output and analog composite output. (-∞ to 0 dB to +3 dB) 0000 0.0% : : 1000 100.0% : : 2000 200.0% <Note> This setting takes effect when "CMPST" has been selected as the menu item No.650 setting.
663 C LEVEL	For adjusting the chroma level of the HD SDI, analog component output, SD SDI output and analog composite output. (-∞ to 0 dB to +3 dB) 0000 0.0% : : 1000 100.0% : : 1413 141.3% <Note> This setting takes effect when "CMPST" has been selected as the menu item No.650 setting.
664 HUE (AJ-HD1400P) C PHASE (AJ-HD1400E)	For adjusting the chroma phase of the HD SDI, analog component output, SD SDI output and analog composite output. (Approx. -30° to +30°) 0000 -31.0 : : 0062 0.0 : : 0124 31.0 <Notes> ● This setting takes effect when "CMPST" has been selected as the menu item No.650 setting. ● If 50 Hz mode or 25 Hz mode has been selected as the system menu item No.25 SYSTEM FREQ setting: • The HD SDI output cannot be adjusted. • The SD SDI output and analog composite output can be adjusted only when an SD format tape is being played back.

\*1 Displayed menus may vary depending on the settings in menu No. 25 SYSTEM FREQ. For details, refer to "Menus which are displayed" (page 32).

\*UP: With HD output (HD tape playback or up-converted output)

\*DW: With SD output (SD tape playback or down-converted output)

"\_\_\_\_\_" indicates the factory setting.



# Setup menus (continued)

## VIDEO (continued)

No./Item	Description of setting
665 SETUP LVL (AJ-HD1400P)  BK LVL (AJ-HD1400E)	For adjusting the setup ( or black) level of the HD SDI, analog component output, SD SDI output and analog composite output. (-10 ° to +10 °) 50            -10% : : 150           0.0% : : 250           +10.0% <Note> This setting takes effect when "CMPST" has been selected as the menu item No.650 setting.
676*1 BLK CLIP	For setting whether to clip what is below the pedestal level for the Y (luminance) signal of composite output and SD SDI output. 0000        OFF : What is below the pedestal level is not clipped. 0001        ON : What is below the pedestal level is clipped.
680*1 CC (F1) BLANK*DW	For selecting ON or OFF for the closed caption signal in the first field. 0000        BLANK : Forced blanking 0001        THRU : No blanking
681*1 CC (F2) BLANK*DW	For selecting ON or OFF for the closed caption signal in the second field. 0000        BLANK : Forced blanking 0001        THRU : No blanking
682*1 VO SETUP (HD)*UP (AJ-HD1400P)	This selects the composite output signal in HD mode. 0000        THRU : The signal is output with no setup added. 0001        ADD22L : The signal is output from line 22 with a 7.5% setup added. 0002        ADD21L : The signal is output from line 21 with a 7.5% setup added. 0003        ADD20L : The signal is output from line 20 with a 7.5% setup added.
683*1 VO SETUP (SD)*DW (AJ-HD1400P)	This selects the composite output signal in SD mode. 0000        THRU : The signal is output with no setup added. 0001        ADD22L : The signal is output from line 22 with a 7.5% setup added. 0002        ADD21L : The signal is output from line 21 with a 7.5% setup added. 00023      ADD20L : The signal is output from line 20 with a 7.5% setup added.
684*1 EDH (SD)*DW	For setting whether to superimpose EDH onto the SD SDI output. 0000        OFF : EDH is not superimposed. 0001        ON : EDH is superimposed.
685*1 ESR MODE (SD)*DW	For selecting the mode of the edge subcarrier reduction (ESR) operation in the playback circuit. 0000        OFF : ESR is forcibly turned off. 0001        AUTO : ESR is automatically set to ON or OFF depending on the unit's operation.

No./Item	Description of setting
686*1 CCR MODE (SD)*DW	For selecting the cross color processing during playback. 0000        OFF : The cross color is output as is. 0001        ON : The cross color can be reduced.
687*1 SDI INDEX 0*DW	For selecting whether to superimpose the VIDEO INDEX signal on the SD SDI output signal. 0000        OFF : The VIDEO INDEX signal is not superimposed on the SD SDI output signal. 0001        ON : The VIDEO INDEX signal is superimposed on the SD SDI output signal.
689*1 COMP MODE	This is used to select the method to process the image compression during recording. 0000        NORMAL : The images are recorded using the regular compression processing. 0001        DARK : The images are recorded while minimizing the compressed image distortion which arises in the dark areas below about 10 IRE (70 mV). <Notes> ● This setting is valid when recording in the 720p mode. ● When "DARK" has been selected, the COMP lamp lights.
690*1 UMID REC	This selects whether or not to record the UMID information on the tape. 0000        OFF : UMID information is not recorded on the tape. 0001        ON : The UMID set in menu No. 691 UMID GEN is recorded. If no Basic UMID is available in the input signals, a Basic UMID of the unit, which is newly generated, is recorded. <Note> UMID information cannot be rewritten in this unit.
691*1 UMID GEN	This selects a UMID that is recorded when menu No. 690 UMID REC is turned "ON". 0000        INT : Newly created basic UMID information of this unit is always recorded. 0001        EXT : The UMID information of the input signals is recorded. If no UMID is available in the input signals, a Basic UMID of the unit, which is newly generated, is recorded. <Note> The source pack (of the UMID information) of the input signal will be recorded on the tape, regardless of this menu's setting.

\*1 Displayed menus may vary depending on the settings in menu No. 25 SYSTEM FREQ. For details, refer to "Menus which are displayed" (page 32).

\*UP: With HD output (HD tape playback or up-converted output)

\*DW: With SD output (SD tape playback or down-converted output)

" \_\_\_\_ " indicates the factory setting.

# Setup menus (continued)

## VIDEO (continued)

No./Item	Description of setting
692*1 UMID POS	<p>This sets the line on which the UMID information is to be superimposed.</p> <p>0000 <b>BLANK</b> 0001 12L : : 0006 17L : : 0008 19L</p> <p>&lt;Notes&gt;</p> <ul style="list-style-type: none"> <li>● The line selected for the menu item No. 501 VITC POS-1 and No. 502 VITC POS-2 settings cannot be selected for this item.</li> <li>● The default settings are not restored even if the RESET button is pressed while holding down the SEARCH button.</li> <li>● Metadata recorded on the tape will be output giving UMID information first priority. When metadata is output, set to a line other than the original multiplexed line or select "BLANK."</li> </ul>
693 GAMMA SEL	<p>This selects gamma correction.</p> <p>0000 <b>OFF</b> : Gamma correction is not carried out.</p> <p>0001 <b>GAMMA1</b> : This corrects video images shot with the cine gamma FilmREC mode of the Varicam to images of film quality (equivalent to Telecine 5 of HD Gamma Corrector in AJ-GBX27G).</p> <p>0002 <b>GAMMA2</b> : This corrects video images shot with the cine gamma FilmREC mode of the Varicam to images of film quality (equivalent to Telecine 6 of HD Gamma Corrector in AJ-GBX27G).</p> <p>0003 <b>GAMMA3</b> : This converts video images shot with the cine gamma FilmREC mode of the Varicam into the Cineon curve appropriate for film recording.</p> <div data-bbox="244 1153 743 1541" data-label="Figure"> </div> <p>&lt;Notes&gt;</p> <ul style="list-style-type: none"> <li>● Gamma correction is effective in the following conditions. <ul style="list-style-type: none"> <li>◆ When the VTR operation mode is VV (TAPE) and 720p is displayed in the system format. However, during cross convert from 720p → 1080i, gamma correction is not effective for SD output.</li> </ul> </li> <li>● When "ON" is selected, the GAMMA lamp on the front panel is on at all times.</li> <li>● When this unit is turned to OFF, this setting returns to "OFF." The setting of user default returns to "OFF."</li> <li>● This item is not effective for 1394 output.</li> </ul>

No./Item	Description of setting
695*1 BLANK LINE*DW	<p>For selecting the blanking ON/OFF for a period of vertical blanking on video signals of the SD output.</p> <p>0000 <b>BLANK</b> : All the lines are forcibly blanked.</p> <p>0001 <b>THRU</b> : None of the lines are blanked.</p> <p>0002 <b>MANU</b> : Blanking ON or OFF is selected on a line-by-line basis.</p> <p>&lt;Notes&gt;</p> <ul style="list-style-type: none"> <li>● When setting "MANU," if the STOP button is pressed, the screen shifts to the sub screen and the ON/OFF setting for each line can be adjusted. Press the STOP button again to return to the main screen.</li> <li>● Lines that are selected as being blanked in this menu item are similarly blanked before being up-converted when replaying the SD tape.</li> </ul>
<b>Sub screen (59/60 Hz mode)</b>	
00 LINE 10&273 : 12 LINE 22&285	<p>0000 <b>BLANK</b> : Forced blanking</p> <p>0001 <b>THRU</b> : No blanking</p>
<b>Sub screen (50 Hz mode)</b>	
00 LINE 7&320 : 15 LINE 22&335	<p>0000 <b>BLANK</b> : Forced blanking</p> <p>0001 <b>THRU</b> : No blanking</p>

\*1 Displayed menus may vary depending on the settings in menu No. 25 SYSTEM FREQ. For details, refer to "Menus which are displayed" (page 32).

\*DW: With SD output (SD tape playback or down-converted output)

"\_\_\_\_\_" indicates the factory setting.

# Setup menus (continued)

## AUDIO

No./Item	Description of setting
701* <sup>1</sup> CH1 IN LV	For setting the reference level of the analog audio input (CH1). 0000 4dB 0001 0dB 0002 -20dB 0003 -60dB
702* <sup>1</sup> CH2 IN LV	For setting the reference level of the analog audio input (CH2). 0000 4dB 0001 0dB 0002 -20dB 0003 -60dB
706 CH1 OUT LV	For setting the reference level of the analog audio output (CH1). 0000 4dB 0001 0dB 0002 -20dB
707 CH2 OUT LV	For setting the reference level of the analog audio output (CH2). 0000 4dB 0001 0dB 0002 -20dB
710 MONIL OUT LV	For setting the reference level of the analog audio output (Lch). 0000 4dB 0001 0dB 0002 -20dB
711 MONIR OUT LV	For setting the reference level of the analog audio output (Rch). 0000 4dB 0001 0dB 0002 -20dB
712 MONI OUT	For selecting whether or not to enable the headphone volume control knob for the volume of an audio monitor output. 0000 UNITY : The signals are output at a fixed level. 0001 VAR : The signal output is coupled with the headphones volume control.
724* <sup>1</sup> REC CH3/4	This selects the input signal to be recorded on the audio CH3/4 track. 0000 CH1/2 : Audio input CH1/2 signal. 0001 MUTE : Mute <Notes> ● This item is effective for analog input only. ● When selecting analog input, the same data as CH1 to CH4 is recorded in CH5 to CH8.

No./Item	Description of setting
730* <sup>1</sup> REC CUE	For setting the input signal to be recorded on the CUE track. 0001 CH1 : Audio input CH1 signal 0002 CH2 : Audio input CH2 signal 0003 CH3 : Audio input CH3 signal 0004 CH4 : Audio input CH4 signal 0005 CH5 : Audio input CH5 signal 0006 CH6 : Audio input CH6 signal 0007 CH7 : Audio input CH7 signal 0008 CH8 : Audio input CH8 signal 0009 CH1+2 : Audio input CH1 + CH2 mixed signal 0010 CH3+4 : Audio input CH3 + CH4 mixed signal 0011 CH5+6 : Audio input CH5 + CH6 mixed signal 0012 CH7+8 : Audio input CH7 + CH8 mixed signal 0013 CH1-8 : Audio input CH1 through CH8 mixed signal <Notes> ● For analog input, this is interlocked to the settings in menu No. 724 REC CH3/4. ● Audio signal is not recorded in the CUE track when inputting 1394. (Mute)
731 PB FADE	For setting the processing for the audio edit points (IN point, OUT point) and followon recording point during playback. 0000 AUTO : The processing follows the status established during recording. 0001 CUT : Cut processing is forcibly performed. 0002 FADE : Fade processing is forcibly performed.
732 EMBEDED AUD	For setting whether to superimpose audio data onto the HD SDI output and SD SDI output. 0000 OFF : The audio data is not superimposed. 0001 ON : The audio data is superimposed.
746 MONI CH SEL	For selecting the monitor output. 0000 MANU : The signal selected by the MONITOR SELECT button is output. 0001 AUTO : The PCM audio signal is output when the speed range is less than -1.0× to +1.0×; the CUE AUDIO signal is output at all other speeds. 0002 PCM : The PCM audio signal is output in the -32× to +32× speed range. <Note> When the L/R selection is CUE with the MONITOR SEL button on the front panel of this unit, CUE AUDIO is output at all speeds, regardless of the above menu.

\*1 Displayed menus may vary depending on the settings in menu No. 25 SYSTEM FREQ. For details, refer to "Menus which are displayed" (page 32).

"\_\_\_\_\_" indicates the factory setting.

# Setup menus (continued)

## AUDIO (continued)

No./Item	Description of setting
750 ANA CH1/2 SEL	For selecting the channel for the signal output to the analog audio output terminal CH1/CH2. 0000 CH1/2 0001 CH3/4 0002 CH5/6 0003 CH7/8
759*1 DV PB ATT	For selecting the audio output level during DV format playback. 0000 OFF : The audio output level is not attenuated. 0001 ON : The audio output level is attenuated.
760*1 REC PT MUTE	For selecting whether to mute the sound at the joins in the recording during DV or DVCAM format playback. 0000 OFF : The sound is not muted. 0001 ON : The sound is muted.
762 AUD RATE CON	For setting whether the tape is to be played back without passing the signals through the rate converter (without activating the digital filter) in the digital audio output unit. 0000 OFF : The tape is played back without passing the signals through the rate converter. 0001 ON : The signals are passed through the rate converter, and the tape is played back. <Note> ON/OFF control is exercised for channels 1 through 8 at the same time. Separate settings cannot be performed on a channel by channel basis.
765 CUE OUT SEL	For setting whether to output the analog CUE signal to CH1/2 for the audio output. 0000 OFF : The analog CUE signal is not output. The PCM audio signal is output when the speed range is less than $-1.0\times$ to $+1.0\times$ ; while the no audio signal is output at any other speed. 0001 ON : The analog CUE signal is output. The PCM audio signal is output when the speed range is less than $-1.0\times$ to $+1.0\times$ ; while the analog CUE signal is output at any other speed.
781*1 IN IMP SEL	For setting the analog audio input impedance. 0000 600 : 600Ω 0001 HIGH : High impedance <Note> Regardless of this setting, the impedance is set to 3kΩ. when “-60 dB” is selected as the menu item No.701 to 702 settings.

No./Item	Description of setting
782 EMBD CH SEL	Set the channels to multiplex SD-SDI output. 0000 CH1-4 : 0001 CH5-8 : <Note> When tape other than DVCPRO HD (LP) is played, CH1 to CH4 is always multiplexed.
783 AUDIO CH SEL	For selecting channels that are adjusted with the audio volume control on the front panel and displayed on the audio level meter. 0000 CH1-4 : Select CH1-CH4. 0001 CH5-8 : Select CH5-CH8.
784 MONI SEL INH	Select enabled/disabled for MONITOR SELECT button operation on the front panel. 0000 OFF : Operation is enabled. 0001 ON : Operation is disabled. 0002 ON1 : Operation is disabled in the FULL display mode while the operation is enabled only in the FINE display mode.

\*1 Displayed menus may vary depending on the settings in menu No. 25 SYSTEM FREQ. For details, refer to “Menus which are displayed” (page 32).

“\_\_\_\_\_” indicates the factory setting.

# Setup menus (continued)

## DIF

No./Item	Description of setting
880* <sup>1</sup> DIF SPEED	For setting the transfer speed of the IEEE1394 digital interface output. 0000 S100 : 100 Mbps 0001 S200 : 200 Mbps 0002 S400 : 400 Mbps <Note> When S100 has been selected as this item's setting, DVCPRO HD format signals cannot be input or output.
882* <sup>1</sup> DIF IN CH	For setting the input channel. 0000 0 : : 0063 63 The input channel is fixed at the channel corresponding to the number specified. 0064 AUTO : The input channel is not fixed at the channel corresponding to the number specified. The input channel is initialized to 63 when the power is turned on.
883* <sup>1</sup> DIF OUT CH	For setting the output channel. 0000 0 : : 0063 63 The input channel is fixed at the channel corresponding to the number specified. 0064 AUTO : The output channel is not fixed at the channel corresponding to the number specified. The output channel is initialized to 63 when the power is turned on.
886* <sup>1</sup> DIF CONFIG	Menu item for expansion purposes. Normally, use DFLT as the setting. 0000 DFLT 0001 1 : : 0255 255
890* <sup>1</sup> DIF AUD OUT	For setting the audio channels to which the signals from the IEEE1394 digital interface are to be output in the DV format when a DVCPRO HD tape or 50M format tape is played back or when a DV tape in 4ch mode is played by the audio signals and menu No. 891 DIF DV AUDIO is set to "LOCK48." 0000 CH1/2 : CH1 and CH2 0001 CH3/4 : CH3 and CH4
891* <sup>1</sup> DIF DV AUDIO	For setting forcible audio mode conversion when a DV tape is played back and the audio signals are output in the DV format. 0000 THRU : Normal setting (the signals simply pass through). 0001 LOCK : Forcible conversion to the LOCK mode (no frequency conversion) 0002 LOCK48 : Forcible conversion to 48kHz/2CH/LOCK.

No./Item	Description of setting
892* <sup>1</sup> DIF SIG CMD	For setting how to reply when signals requesting a confirmation of the format is sent from an external device connected by the IEEE1394 digital interface. 0000 50M : DVDPRO50 is forcibly returned. 0001 25M : DVDPRO is forcibly returned. 0002 DV : DV is forcibly returned. 0003 AUTO : The reply is the same format as the signal format output from the IEEE1394 digital interface. <Note> When the unit is connected to a non-linear editing system using 50M, 25M, and DV signal format, the non-linear editing system may not operate properly. In this case, set the value to reply with the format signal supporting the connected signal format and start the system.
894* <sup>1</sup> HD → DIF OUT	For selecting channels that are adjusted with the audio volume control on the front panel and displayed on the audio level meter. 0000 HD : DVCPRO HD 0001 50M : DVCPRO50 0002 DV : DV
895* <sup>1</sup> 50M → DIF OUT	For setting the format of the signals to be output from the IEEE1394 digital interface when a 50M format tape is played back. 0000 50M : DVCPRO50 0001 DV : DV <Note> When DV is selected as this item's setting, the closed caption signals and time code (VITC) signals in the vertical blanking period are transmitted, but none of the other signals in the vertical blanking period are transmitted.
896* <sup>1</sup> 25M → DIF OUT	For setting the format of the signals to be output from the IEEE1394 digital interface when a 25M format tape is played back. 0000 25M : DVCPRO 0001 DV : DV
899* <sup>1</sup> DIF SUPER	For setting whether the superimposed display is to be output from the IEEE1394 digital interface when the format is converted (from HD to 50M, from HD to DV, from 50M to DV or from 25M to DV). 0000 OFF : The superimposed text is not displayed. 0001 ON : The superimposed text is displayed. <Note> Only TCR is displayed.

\*1 Displayed menus may vary depending on the settings in menu No. 25 SYSTEM FREQ. For details, refer to "Menus which are displayed" (page 32).

"\_\_\_\_\_" indicates the factory setting.

## Setup menus (continued)

---

### MENU

No./Item	Description of setting
A02 P.ON LOAD	The unit starts with the selected user default loaded when the power is turned on. <b>0000 OFF :</b> The unit starts with the previous set values. <b>0001 USER1 :</b> The unit starts with the selected user 1 loaded. <b>0002 USER2 :</b> The unit starts with the selected user 2 loaded. <b>0003 USER3 :</b> The unit starts with the selected user 3 loaded. <b>&lt;Note&gt;</b> Set value for SYSTEM menu is not loaded.
A04 PF1 ASSIGN	The setup menu item is stored to the PF1 button. <b>&lt;Note&gt;</b> Part of the items listed on the menu cannot be saved. For details, refer to "PF (Programmable Function)" (page 23).
A05 PF2 ASSIGN	The setup menu item is stored to the PF2 button. <b>&lt;Note&gt;</b> Part of the items listed on the menu cannot be saved. For details, refer to "PF (Programmable Function)" (page 23).
A06 PF3 ASSIGN	The setup menu item is stored to the PF3 button. <b>&lt;Note&gt;</b> Part of the items listed on the menu cannot be saved. For details, refer to "PF (Programmable Function)" (page 23).

"\_\_\_\_\_" indicates the factory setting.

# Time code/user bits

## Time code

The time code is used when the time code signal generated by the time code generator (time code signal generator) is to be recorded on the tape, its values are to be read by the time code reader (time code signal reader), and the absolute position of the tape is to be displayed in increments of hours, minutes, seconds and frames.

The time code is written in the sub-code area (data area) of the helical track. The VTR's playback speed can be read from the stop mode to slow-motion playback up to high-speed play (approx. 50 a normal speed approx. 100 a when using DVCPRO tape).

The time code values are indicated using the display and superimpose functions.

TCR 00 : 07 : 04 : 24  
↑     ↑     ↑     ↑  
Hours Minutes Seconds Frames

## User bits

"User bits" refers to the 32-bit (8-digit) data frame among the time code signals which has been released to users. It enables operator numbers values to be recorded.

The alphanumeric characters which can be used for the user bits are the figures 0 to 9 and the letters A to F.

## Setting the internal time code

- 1 Set the VTR to stop mode.
- 2 Select "TC" using the COUNTER button.
- 3 Set the run mode for the time code generator using menu No. 504 RUN MODE.

### REC:

The internal time code generator is advanced during recording.

### FREE:

When the power is on, the internal time code generator is advanced regardless of the operation mode.

- 4 Set the TCG switch to REGEN mode.

### REGEN:

In this mode, the continuity of the original time code is maintained.

A more detailed setting can be performed using menu No. 505 TCG REGEN.

### PRESET:

In this mode, recording is commenced from the value which was set by the TC PRESET button.

- 5 To preset the time code or user bit, take the following steps.
  1. Set the TCG switch to "PRESET."
  2. Select "TC" or "UB" using the COUNTER button.
  3. When the TC PRESET button is pressed, operation is transferred to the setting mode, and the setting digits start flashing on the counter display.
  4. Operate the joystick, and set the preset value.  
Left, right → for moving between digits;  
Up, down → for changing the setting  
●When the RESET button is pressed, the preset value is reset to zero.
  5. The preset value is set by pressing the TC PRESET button.

## Setting the external time code

- 1 Set the VTR to stop mode.
- 2 Select "TC" using the COUNTER button.
- 3 Set the TCG switch to "EXT". (External time code selection)
- 4 The following settings can be selected with menu No. 507 EXT TC SEL.

### EXT\_L:

The LTC signal input to the TIME CODE IN connector (BNC) on the rear panel is recorded as time code.

### SLTC:

The SLTC time code on the input video signal is recorded.

### SVITC:

The SVITC time code on the input video signal is recorded.

### <Note>

The LTC signal must be synchronized with the video signal.

## Reproducing the time code/user bits

- 1 Set the VTR to stop mode.
- 2 Select "TC" or "UB" using the COUNTER button.
- 3 Press the PLAY button.  
Playback starts and the time code is shown on the display.  
When the SUPER switch is set to ON, the time code value is superimposed on the video signals from the VIDEO MON connector.

### <Note>

When the time code signal cannot be read, the time code is automatically interpolated by the CTL signal. The display appears as shown below.

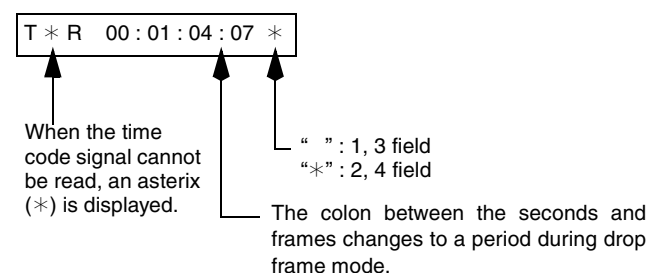

## Time code/user bits (continued)

### Time code when power is not supplied

Even if the power is not supplied, the time code generator operates for many hours (about 1 year) by using the backup feature. And the accuracy when power is not supplied is about  $\pm 30$  seconds a month.

#### <Notes>

- When the time code generator advances regardless of the operation mode, the backup function is enabled.
  - ◆ When the TCG switch in the front panel is set to "PRESET" and the menu No. 504 RUN MODE is set to "FREE."
  - ◆ When the TCG switch in the front panel is set to "EXT" and the external time code input set in menu No. 507 EXT TC SEL is disconnected from the connector on the rear panel.
- When the settings in menu No. 25 SYSTEM FERQ are revised, the advanced data will be cleared.

### Timecodes recorded by this product

TCG switch	Menu No. 507 EXT TC SEL	Selected video input signal	Recorded timecode	
			SBC area	VAUX area
INT (REGEN/PRESET)	---	1394	Internal TCG value (Refer to the following table.)	Timecode on IEEE1394 digital input (VAUX area)
		HD SDI		SVITC on input video signal*3
EXT	EXT_L	1394	Timecode on IEEE1394 digital input (SBC area)	Timecode on IEEE1394 digital input (VAUX area)
		HD SDI	Timecode from TIME CODE IN connector input*1	SVITC on input video signal*3
	SLTC	1394	Timecode on IEEE1394 digital input (SBC area)	Timecode on IEEE1394 digital input (VAUX area)
		HD SDI	SLTC on input video signal*2	SVITC on input video signal*3
	SVITC	1394	Timecode on IEEE1394 digital input (SBC area)	Timecode on IEEE1394 digital input (VAUX area)
		HD SDI	SVITC on input video signal*2	SVITC on input video signal*3

\*1 The internal TCG value is used when the signal cannot be detected from the TIME CODE IN connector input.

\*2 The internal TCG value is used when the SLTC or SVITC cannot be detected on the input video signal.

\*3 Nothing is recorded if the SVITC cannot be detected on the input video signal.

TCG switch	Menu			Recorded timecode					
	No.503 TCG MODE	No.505 TCG REGEN	No.506 REGEN MODE	For continuous recording		For assemble editing For frame-by-frame shooting*5		For insert editing (Time code selection)	
				TC	UB	TC	UB	TC	UB
REGEN	SW	TC&UB	---	REGEN					
		TC		REGEN	PRESET	REGEN	PRESET	REGEN	PRESET
		UB		PRESET	REGEN	PRESET	REGEN	PRESET	REGEN
PRESET		---	PRESET						
REGEN/ PRESET*4	AUTO	TC&UB	AS&IN	PRESET	REGEN		REGEN		
			ASSEM		PRESET		PRESET		
			INSRT		REGEN		REGEN		
		TC	AS&IN		REGEN	PRESET	REGEN	PRESET	
			ASSEM		PRESET	REGEN	PRESET	REGEN	
			INSRT		REGEN		REGEN		
		UB	AS&IN		REGEN		PRESET		
			ASSEM		REGEN		REGEN		
			INSRT		PRESET		REGEN		

\*4 When menu No. 503 TCG MODE is set to AUTO, the REGEN and PRESET selection of the TCG switch is disabled.

\*5 When menu No. 154 AUTO BACK is set to "OFF", scene-to-scene continuity will be a normal recording.



# Superimpose screen

The control signals, time code, etc. are displayed using abbreviations.

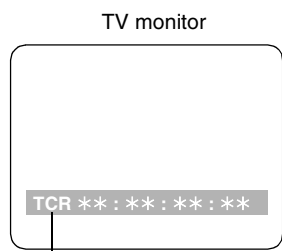

Abbreviations:

- CTL** : Control signal count value
- TCR** : Time code data recorded in the SBC area
- TCR.** : Time code data recorded in the VAUX area
- UBR** : User bit data recorded in the SBC area
- UBR.** : User bit data recorded in the VAUX area
- TCG** : Time code data of the time code generator
- UBG** : User bit data of the time code generator

## <Notes>

- [T \* R], [T \* R.], [U \* R] or [U \* R.] is displayed when the data has not been read correctly from the tape.
- When the 23.98/24 Hz, 25 Hz (HD/SD), or 50Hz (HD/SD) mode is selected in menu No. 25 SYSTEM FREQ, indications on the CTL and TCR will be "--:--:--:--".

## Characters displayed

The background of characters superimposed on the display can be changed using menu No. 009 CHARA TYPE.



TV monitor

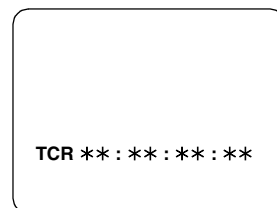

TV monitor

## Display position

The position of the characters superimposed on the display can be changed using menus No. 007 CHARA H-POS and No. 008 CHARA V-POS.



TV monitor



TV monitor

## Operation mode

The VTR's operation mode can also be displayed using menu No. 006 DISPLAY SEL.

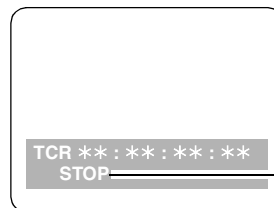

TV monitor

VTR operation mode

# Video head cleaning

---

---

This unit is equipped with an auto head cleaning function which automatically reduces the amount of dirt on the video heads. However, in order to maximize the unit's reliability, it is recommended that the video heads be cleaned as and when appropriate.

For further details on how to actually clean the heads, consult with your dealer.

## Condensation

---

---

Condensation occurs due to the same principle involved when droplets of water form on a window pane of a heated room. It occurs when the unit or tape is moved between places where the temperature or humidity varies greatly or when, for instance:

- It is moved to a very humid place full of steam or a room immediately after it has been heated up.
- It is suddenly moved from a cold location to a hot or humid location.

When moving the unit to locations such as these, leave it standing for about 10 minutes rather than switching on the power immediately. If condensation occurs in the unit, "E-20" will flash on the counter display and the cassette will be automatically ejected.

Leave the unit with the power on until "E-20" is cleared from the display.

## Maintenance

---

---

Before starting any maintenance work, switch the power to OFF and, holding the plug, unplug the cord from the socket. Use a soft cloth to clean the outside of the unit.

For stubborn dirt or stains, wipe the unit with a cloth that has been lightly dampened with well-diluted kitchen detergent and wrung out thoroughly.

After wiping off the dirt with the damp cloth, finish it off with a dry cloth.

### <Note>

Do not use alcohol, benzene, thinners or any other solvents as they may affect the color of external parts or damage the unit's coating.

# Error messages

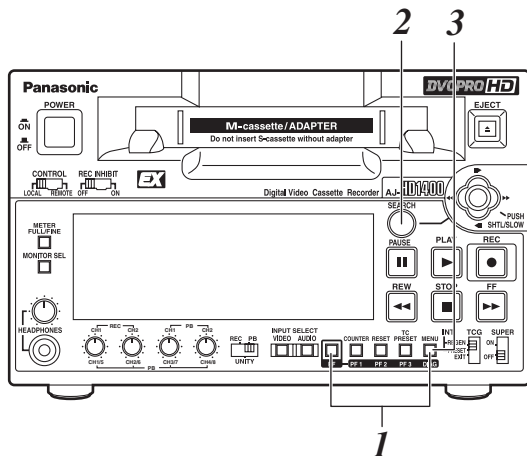

When a warning occurs in this unit, the error number is indicated on the counter display.  
 Open the DIAG menu to display a description of the error on the counter display or monitor TV.  
 When a operational malfunction has occurred in the unit, the error number flashes on the counter display.

## DIAG menu

This displays the VTR information.  
 The VTR information includes the warning information, hours meter (usage time) information and UMID information. The DIAG menu appears on the TV monitor when the VIDEO OUT connector on the rear panel is connected to the TV monitor.

## Displaying the DIAG menu

- 1 Press the MENU button while holding down the PF button.  
 The DIAG menu screen appears on the TV monitor, and a message appears on the counter display.
- 2 Press the SEARCH button.  
 Each time this button is pressed, the display changes by one step in the following sequence: "WARNING" → "HOURS METER" → "UMID INFO" → "DIF STATUS1" → "DIF STATUS2."
- 3 When the MENU button is pressed again, the original display is restored.

## Displaying the "HOURS METER" information

When the joystick is moved up or down, the cursor (\*) moves, and a description of the item where the cursor is located is shown on the counter display.

NO.	Item	Description
Ser	*****	Displays the unit's serial No.
H00	OPERATION	Displays the time that the power has been supplied in one-hour units.
H01	DRUM RUN	Displays the time that the drum has been rotating in one-hour units.
H02	TAPE RUN	Displays the duration for which the tape has been running in the FF, REW, PLAY, SEARCH (JOG, SLOW, SHTL) and REC modes (but not in the JOG, SLOW and SHTL STILL modes) in 1-hour increments.
H03	THREADING	The number of times for threading (loading)/ unthreading (unloading) is displayed in single units.
H04	F LOADING	Displays the number of times front loading has been performed in single units.
H11	DRUM RUNr	Displays the time that the drum has been rotating in one-hour units. (Can be reset)
H12	TAPE RUNr	Displays the duration for which the tape has been running in the FF, REW, PLAY, SEARCH (JOG, SLOW, SHTL) and REC modes (but not in the JOG, SLOW and SHTL STILL modes) in 1-hour increments. (This item can be reset.)
H13	THREADINGr	The number of times for threading (loading)/ unthreading (unloading) is displayed in single units. (Can be reset)
H14	F LOADINGr	Displays the number of times front loading has been performed in single units. (Can be reset)
H30	POWER ON	The number of times the power has been turned on is displayed in single units.

### <Notes>

- The resettable items in the "HOURS METER" information are reset by the dealer when maintenance work is performed.
- No operations can be performed using the SEARCH button or the joystick while the DIAG menu is displayed.

## Error messages (continued)

If "T&S&M" is selected in the menu No. 008 DISPLAY SEL, a message appears in the modedisplay whenever a warning or error occurs. When multiple events occur, the event with the highest priority is displayed.

Priority	Display	Description
High ↑ ↓ Low	<b>Error messages</b> (See error message table)	When an operational malfunction has occurred in the unit, the error number flashes and the error message is indicated on the counter display.
	<b>INT SG</b>	When SG has been selected as the input signal by the INPUT SELECT button, the "INT SG" display will appear for the first two seconds at the start of operation (EE mode) when the REC button is pressed.
	<b>NO INPUT</b>	If there are no input signals--with the exception of the analog audio signals-- supplied to the connectors selected by the INPUT SELECT button, the "NO INPUT" display will appear for the first two seconds at the start of operation (EE mode) when the REC button is pressed.
	<b>Warning messages</b> (See error message table)	When a warning occurs in this unit, the error number and warning message are indicated on the counter display. When multiple warnings occur, the warning with the highest priority is displayed.

## UMID information display

This is displayed when UMID information is present on the input signal in EE mode.

This lamp lights during tape playback when UMID information has been recorded on the tape. "NO-INFO" is displayed when there is no UMID information.



Display	Description
<b>MATNO</b>	Material number
<b>COPY</b>	Instance number (No. of copies)
<b>OWNR</b>	Country, organization, user
<b>POS</b>	Reception status from GPS satellites when recording spatial coordinates (height above sea level, longitude and latitude): <b>HOLD:</b> No reception from any satellite <b>2D:</b> Reception possible, but number of satellites is insufficient. Height above sea level will not be accurate. <b>3D:</b> Good reception
<b>DATE</b>	Date
<b>TIME</b>	UTC (Coordinated Universal Time) and time difference with UTC

# Error messages (continued)

## Displaying the warning information

- A warning message appears when a warning has occurred. “NO WARNING” appears when a warning has not occurred.
- When more than one warning has occurred simultaneously, move the joystick up or down to check the description of each warning.

## Warning messages

Priority	Monitor display	Description	Corrective action	VTR operation
High   Low	E-20 (DEW)	If condensation is detected, the error number flashes and the unit transfers to eject mode. The drum rotates after the cassette is ejected to eliminate the condensation. Once the unit is released from condensation status, the error message display is cleared and the VTR is able to be used. <ul style="list-style-type: none"> <li>● If condensation is detected in the eject mode, the drum starts rotating as soon as it is detected.</li> <li>● If condensation is detected when the cassette has been inserted, the drum rotation is stopped, and after the tape is ejected, the drum starts rotating.</li> </ul>	Leave the power on and wait.	EJECT
	E-95 (INVALID EMBEDDED TC)	(When “SLTC” is selected in menu No. 032 REC REF) Appear when a time code for a signal input into the HD SDI IN connector is not stepping at the standard rate in synchronizing the image frames to be recorded with the time code.	Check the time code information of the input signal.	Operation continues.
	E-92 (1394 INITIAL ERROR)	Display if the IEEE1394 digital interface connection status is irregular	If the cable connection is in loop status, reconnect to 1 to 1. If not using the loop connection, turn the POWER switch OFF → ON.	Signal input and output through the IEEE1394 digital interface is stopped.
	E-04 (UNKNOWN SIG)	This appears when the signals supplied from the IEEE1394 digital interface are not DVCPRO/DV format signals.	Check that the 1394 input has been connected properly.	No recording operations are possible.
	E-90 (NOT 1X 100M SIG)	This appears when the initialization process fails during communication via the IEEE1394 digital interface.	Check the input signal.	Operation continues.*1
	E-16 (INVALID VIDEO SIG)	This appears when the compressed video signals supplied from the IEEE1394 digital interface are irregular signals. <ul style="list-style-type: none"> <li>● This warning appears only during recording operations. In such cases, no signals are recorded on the tape, and only erasure of existing signals is performed.</li> </ul>	Check the 1394 input signals. It is possible that playback signals of an unrecorded tape are being input.	Operation continues.*1
	E-17 (INVALID AUDIO SIG)	This appears when the audio signals supplied from the IEEE1394 digital interface are irregular signals. <ul style="list-style-type: none"> <li>● This warning appears only during recording operations. In such cases, the signals are recorded with the audio signals muted.</li> </ul>	Check the 1394 input signals. It is possible that signals other than 1x playback signals are being input from a VTR or other device.	Operation continues.*2
	E-18 (INVALID TC SIG)	This appears when the time code information supplied from the IEEE1394 digital interface is irregular information. <ul style="list-style-type: none"> <li>● This warning appears only during recording operations. In such cases, the internally generated time code is recorded.</li> </ul>	Check the time code of the device which is supplying the time code.	Operation continues.*3
	E-14 (NO MATCH SIG)	This appears when the signals supplied to the IEEE1394 digital interface are at variance from the system format which is set by this unit.	Check the input signal.	Operation continues.*1
	E-10 (FAN STOP)	This appears when the fan motor has shut down.	Check the fan for foreign matter.	Operation continues.
E-09 (NO RF)	This appears when a blank section lasting for more than one second on the tape has been detected during playback. A blank section is identified as such when all the following conditions are met: <ul style="list-style-type: none"> <li>● There are no output signals from any of the heads.</li> <li>● The playback data cannot be read.</li> <li>● There is no CTL signal (DV/DVCAM tapes excluded).</li> </ul>	Check the tape. It is possible that an unrecorded tape has been loaded.	Operation continues.	

\*1 This error message always appears in the EE mode.

In such a case, black signals are recorded as the video signals, and the audio signals are muted.

\*2: This error message always appears in the EE mode.



In such a case, the audio signals are muted.

\*3: This error message always appears in the EE mode.

In such a case, the time code of the time code generator inside this unit is recorded as the time code signal.

## Error messages (continued)

### Warning messages

Priority	Monitor display	Description	Corrective action	VTR operation
High   Low	<b>E-00 (SERVO NOT LOCKED)</b>	This appears when the servo is not locked for three or more seconds during playback or recording.	Check the tape.	Operation continues.
	<b>E-93 (INVALID TC MODE)</b>	(In 23.98/24 Hz mode) Display when the time code is recorded in DF mode. On the drop point of the time code, the video output is garbled and audio output is muted. Operation of VTR continues. When using this unit to playback a tape recorded from a variable frame rate camera, it is necessary to record the time code in NDF mode.	Use the original tape recorded with the variable frame rate camera.	Operation continues.
	<b>E-94 (TC SEQUENCE UNMATCH)</b>	(In 23.98/24 Hz, 25 Hz, 50 Hz mode) Appear when the relationship between the active frame information and time code is not regular during playback. The video output may not be regular (not smooth). Operation of VTR continues. The active frame information (top frame of the switched frame image) is recorded on the tape from a variable frame rate camera. To play it back with this unit, it is necessary to detect the 0 frame of the time code at the activation frame position.	Use the original tape recorded with the variable frame rate camera.	Operation continues.
	<b>E-01 (LOW RF)</b>	This appears when an envelope level approximately one-third of the normal level has been detected for more than one second during playback or recording.	Clean the video heads.	Operation continues.
	<b>E-02 (HIGH ERROR RATE)</b>	This appears when the error rate has increased to the extent that correction or interpolation was applied to either the video or audio playback signals.	Clean the video heads.	Operation continues.

### Error messages

Monitor display	Description	Corrective action	VTR operation
<b>E-29 FRONT LOAD MOTOR</b>	The unit switches to eject mode and if the cassette fails to move up within 6 seconds, this error number flashes on the display. <Note> If the cassette does not move down inside the machine even when 6 seconds have elapsed since the cassette was inserted, the VTR is transferred to the eject mode.	Set the POWER switch to OFF and then to ON again.	STOP
<b>E-31 LOADING MOTOR</b>	If the unloading operation is not completed within 6 seconds, this error number flashes on the display. <Note> When the loading operation is not completed within 6 seconds, the VTR is transferred to the eject (unloading) mode.	Set the POWER switch to OFF and then to ON again.	STOP
<b>E-35 SERVO CONTROL ERROR</b>	If there is no response from the servo microcomputer for 1 second or more, this error number flashes on the display.	Set the POWER switch to OFF and then to ON again.	STOP
<b>E-37 SERVO COMM ERROR</b>	If 10 seconds or more elapses and the servo microcomputer has not followed orders issued by the system control microcomputer, this error number flashes on the display.	Set the POWER switch to OFF and then to ON again.	STOP
<b>E-38 SERVO FG ERROR</b>	This appears when the automatic reel and capstan rotation adjustment, which is performed in the EJECT mode, has not been carried out properly when the unit's power was switched on.	Set the POWER switch to OFF and then to ON again.	STOP
<b>E-51 FRONT LOAD ERROR</b>	If the take-up reel rotates without engaging for a specific period of time during the start or end processing operation while loading is underway (half position), this error number flashes on the display.	Set the POWER switch to OFF and then to ON again.	STOP
<b>E-52 W-UP REEL NOT ROTA</b>	If the take-up reel fails to take up the tape while the tape is traveling in the state where the total amount of the tape has not yet been detected after the cassette was inserted, this error number flashes on the display.	Set the POWER switch to OFF and then to ON again.	STOP
<b>E-53 WINDUP ERROR</b>	If there is an abnormally large discrepancy between the amount of tape taken up by the take-up reel and the amount of tape supplied by the supply reel while the tape is traveling after the total amount of the tape begins to be detected, this error number flashes on the display.	Set the POWER switch to OFF and then to ON again.	STOP

## Error messages (continued)

### Error messages (continued)

Monitor display	Description	Corrective action	VTR operation
<b>E-55 UNLOAD ERROR</b>	If the tape has not been taken up during unloading, this error number flashes on the display.	Set the POWER switch to OFF and then to ON again.	STOP
<b>E-57 S-FF/REW TIMEOVER</b>	If the start or end processing operation is not completed, this error number flashes on the display.	Set the POWER switch to OFF and then to ON again.	STOP
<b>E-59 DRUM ROTA TOO SLOW</b>	If the cylinder motor speed is abnormally low, this error number flashes on the display.	Set the POWER switch to OFF and then to ON again.	STOP
<b>E-60 DRUM ROTA TOO FAST</b>	If the cylinder motor speed is abnormally high, this error number flashes on the display.	Set the POWER switch to OFF and then to ON again.	STOP
<b>E-61 CAP ROTA TOO SLOW</b>	If the capstan motor speed is abnormally low, the error number flashes on the display.	Set the POWER switch to OFF and then to ON again.	STOP
<b>E-64 S REEL ROTA TOO FAST</b>	If the supply reel motor speed is abnormally high, the error number flashes on the display.	Set the POWER switch to OFF and then to ON again.	STOP
<b>E-67 T REEL ROTA TOO FAST</b>	If the take-up reel motor speed is abnormally high, the error number flashes on the display.	Set the POWER switch to OFF and then to ON again.	STOP
<b>E-69 T REEL TORQUE ERR</b>	If excess torque being applied to the take-up reel motor is detected, the error number flashes on the display.	Set the POWER switch to OFF and then to ON again.	STOP
<b>E-70 S REEL TORQUE ERR</b>	If excess torque being applied to the supply reel motor is detected or an abnormal current flowing to the current detection resistor is detected, this error number flashes on the display.	Set the POWER switch to OFF and then to ON again.	STOP
<b>E-71 CAP TENSION ERROR</b>	If abnormal tension at the supply side is detected in the capstan mode, the error number flashes on the display.	Set the POWER switch to OFF and then to ON again.	STOP
<b>E-72 REEL TENSION ERROR</b>	If abnormal tension at the supply side is detected in the reel mode, the error number flashes on the display.	Set the POWER switch to OFF and then to ON again.	STOP
<b>E-73 REEL DIR UNMATCH</b>	If the take-up reel motor has rotated in the reverse direction, this error number flashes on the display.	Set the POWER switch to OFF and then to ON again.	STOP
<b>E-74 DRUM TORQUE ERROR</b>	If excess torque being applied to the cylinder motor is detected, this error number flashes on the display.	Set the POWER switch to OFF and then to ON again.	STOP
<b>E-78 M-IF COMM ERROR</b>	If a problem has been encountered in communication between the servo microcomputer and mechanism relay board, this error number flashes on the display.	Set the POWER switch to OFF and then to ON again.	STOP
<b>E-bA BATTERY</b>	This appears when the input DC voltage has dropped below the undercut voltage.	Check the output voltage of the equipment supplying DC power.	STOP

#### <Note>

Consult your dealer if the error message display persists even after the unit has been restarted.

# Emergency eject

## Procedure to ejecting the tape manually in an emergency

If the cassette tape fails to be ejected even when the EJECT button is pressed, it can be ejected as follows.

● Follow the steps below after making absolutely sure that the unit's power has been turned off.

- 1 Remove the top panel.
- 2 Use a Phillips-head screwdriver to push in the red plastic gear (A) and turn it counterclockwise while keeping it pushed in. The mechanism that winds up the tape is activated by this, and it makes a latching sound. Ignore the sound, and turn the gear through about 10 revolutions.
- 3 Check that the posts have unloaded the tape and that the tape is completely housed inside the cassette.
- 4 Once the tape has been completely returned inside the cassette case, use the Phillips-head screwdriver to push in the red plastic gear (B) in front of the front loading motor's worm gear and, while keeping it pushed in, turn it clockwise to eject the cassette.

**<Note>**

Turning the gear more than necessary will strain the cassette, possibly resulting in tape damage.

**<Note>**

When closing the cassette cover, take care not to catch the tape.

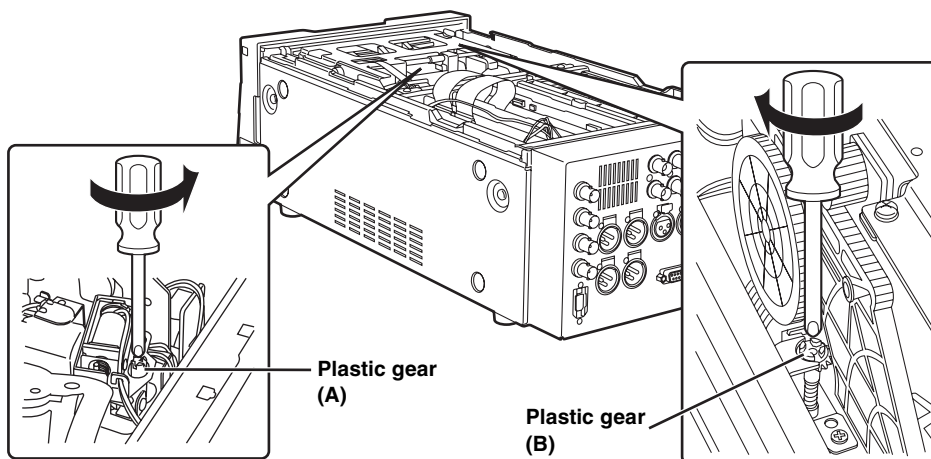



# Specifications

## [GENERAL]

**Power supply:** AC 100-240 V , 50/60 Hz, 85 W  
DC 12 V, 5.3 A, 64 W

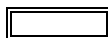
 indicates safety information.

### **Ambient operating temperature:**

5°C to 40°C (41°F to 104°F)

### **Storage temperature:**

-20°C to 60°C (-4°F to 140°F)

### **Ambient operating humidity:**

10% to 80% (no condensation)

### **Dimensions (W×H×D):**

214 mm × 132 mm × 442 mm  
(8-7/16 inches × 5-1/4 inches × 17-3/8 inches)  
(Protruding portion is not included)

### **Weight:**

8.5 kg (18.74 lb)

### **Recording format:**

DVCPRO HD-LP

### **Recording video signals:**

1080i/59.94 Hz, 50 Hz,  
720p/59.94 Hz, 50 Hz, 60 Hz (only Varicam)  
switchable

### **Recording audio signal:**

48 kHz, 16 bits, 8 channels

### **Recording tracks:**

- ◆ Digital video/audio: Helical track
- ◆ Time code: Helical track (sub code area)
- ◆ Cue signal: 1 track
- ◆ Control (CTL) signal: 1 track

### **Playback formats:**

DVCPRO HD-LP, DVCPRO HD, DVCPRO50,  
DVCPRO, DV-SP, DVCAM

### **Recording tape speed:**

67.640 mm/sec (in 59.94 Hz mode)  
67.708 mm/sec (in 50/60 Hz mode)

### **Recording time:**

64 min (when using AJ-HP64ELG)

### **Tapes used:**

Metal tapes

### **FF/REW time:**

Approx. 90 sec (when using AJ-HP64ELG)

### **Editing accuracy:**

±0 frame  
(when time code is used, in 50 Hz, 59.94 Hz or  
60 Hz mode)

### **Tape timer accuracy:**

±2 frames (when continuous CTL signal is used)  
(For slow replay at half speed or less, errors may  
occur in the CTL count.)

## [VIDEO]

### ■ Digital video

#### **Sampling frequency:**

Y: 74.25 MHz  
P<sub>B</sub>/P<sub>R</sub>: 37.125 MHz

#### **Quantizing:**

8 bits

#### **Video compression system:**

DCT + variable length code

#### **Video compression ratio:**

1:6.7

#### **Error correction:**

Reed-Solomon product code

#### **Video recording bit rate:**

100 Mbps

### ■ Video input connectors

#### **HD serial digital input:**

BNC × 1  
(compliant with SMPTE 292M/296M/299M  
standards)

#### **Reference input:**

Black burst/HD tri-level sync automatic switching  
BNC × 1 (loop-through × 1)  
75 Ω termination automatic switching

### ■ Video output connectors

#### **HD serial digital output:**

BNC × 2  
(compliant with SMPTE 292M/296M/299M  
standards)  
(information superimposing ON/OFF)

#### **SD serial digital output:**

BNC × 1 (compliant with SMPTE 259M-C/  
272M-A, ITU-R BT.656-4 standards)  
(information superimposing ON/OFF)

#### **Analog composite output:**

BNC × 1  
VIDEO 1, VIDEO 2  
(information superimposing ON/OFF)

#### **HD analog component output:**

BNC × 3 (Y/P<sub>B</sub>/P<sub>R</sub>)  
(information superimposing ON/OFF)  
(VIDEO1 and HD analog component Y output  
are switched.)

## ■ Video output adjustment ranges

### ● Component style

HD/SD SDI, HD analog component, composite output Y gain:

–∞ to +3 dB

HD/SD SDI, HD analog component, composite output P<sub>B</sub> gain:

–∞ to +3 dB

HD/SD SDI, HD analog component, composite output P<sub>R</sub> gain:

–∞ to +3 dB

HD/SD SDI, HD analog component, composite output Y black level:

±10%

### ● Composite style

HD/SD SDI, HD analog component, composite output video gain:

–∞ to +6 dB

HD/SD SDI, HD analog component, composite output chroma gain:

–∞ to +3 dB

HD/SD SDI, HD analog component, composite output chroma phase:

±30°

HD/SD SDI, HD analog component, composite output Y setup:

±10%

### ● System phase

HD serial digital output system phase:

1080i: ±0.5H (in 13.5 ns increments)

59.94/60 Hz: ±1100 samples

50 Hz: ±1320 samples

23.98/24 Hz: ±1375 samples

720p: ±0.5H (in 13.5ns increments)

59.94/60 Hz: ±825 samples

50 Hz: ±990 samples

Composite video output system phase:

±0.5H (in 37 ns increments)

59.94 Hz: ±858 samples

50 Hz: ±864 samples

Composite video output SC phase:

±180° or more

## [AUDIO]

### ■ Digital audio

Sampling frequency:

48 kHz (synchronized with video)

Quantizing:

16 bits

Frequency response:

20 Hz to 20 kHz ±1 dB (at reference level)

Dynamic range:

More than 85 dB (1 kHz, emphasis OFF)

Distortion:

Less than 0.1%

(1 kHz, emphasis OFF, reference level)

Crosstalk:

Less than –80 dB (1 kHz, between 2 channels)

Wow & flutter:

Below measurable limits

Headroom:

20 dB (For AJ-HD1400P)

18 dB (For AJ-HD1400E)

### ■ Audio input connectors

Analog input (CH1, CH2):

XLR ×2, 600 Ω/high impedance switchable

+4/0/–20 dBu/–60 dBu switchable

HD serial digital input:

BNC ×1

Compliant with SMPTE 292M/296M/299M standard

### ■ Audio output connectors

Analog output (CH1, CH2):

XLR ×2, low impedance

+4/0/–20 dBu switchable

HD serial digital output:

BNC ×2 (compliant with SMPTE 292M/296M/299M standard)

SD serial digital output:

BNC ×1 (compliant with SMPTE 259M-C/272M-A/ITU-R BT.656-4 standards)

Monitor output (L, R):

● XLR ×2, low impedance

+4/0/–20 dBu switchable

● Pin jack ×2

Headphone output:

3.5-mm stereo mini jack ×1, 8 Ω, level variable

## Specifications (continued)

---

### [OTHER CONNECTORS]

**Time code input:**

XLR × 1, 0.5 to 8 Vp-p, 10 k $\Omega$

**Time code output:**

XLR × 1, low impedance,  $2.0 \pm 0.5$  Vp-p  
(with 600  $\Omega$  load)

**RS-422A input:**

D-sub 9-pin  
RS-422A interface

**Encoder remote**

D-sub 15-pin

**DC power output:**

4 pins × 1, DC 12 V, 250 mA, for AJ-A95

**1394 input/output connector:**

Connector: 6-pin type

Transmission rate:

400 Mbps, 200 Mbps, 100 Mbps;selectable

Transmission data:

Compliant with IEEE1394-1995

Compliant with IEC 61883-Part1, Part2

Control command:

Compliant with AV/C command set

### [Accessories]

Power supply cord × 1 (AJ-HD1400P)

Power supply cord × 2 (AJ-HD1400E)

## Information on Disposal for Users of Waste Electrical & Electronic Equipment (private households)



This symbol on the products and/or accompanying documents means that used electrical and electronic products should not be mixed with general household waste.

For proper treatment, recovery and recycling, please take these products to designated collection points, where they will be accepted on a free of charge basis. Alternatively, in some countries you may be able to return your products to your local retailer upon the purchase of an equivalent new product.

Disposing of this product correctly will help to save valuable resources and prevent any potential negative effects on human health and the environment which could otherwise arise from inappropriate waste handling. Please contact your local authority for further details of your nearest designated collection point.

Penalties may be applicable for incorrect disposal of this waste, in accordance with national legislation.

### For business users in the European Union

If you wish to discard electrical and electronic equipment, please contact your dealer or supplier for further information.

### Information on Disposal in other Countries outside the European Union

This symbol is only valid in the European Union.

If you wish to discard this product, please contact your local authorities or dealer and ask for the correct method of disposal.

# Panasonic®

**PANASONIC BROADCAST & TELEVISION SYSTEMS COMPANY**  
UNIT COMPANY OF PANASONIC CORPORATION OF NORTH AMERICA

**Executive Office:**

One Panasonic Way 4E-7, Secaucus, NJ 07094 (201) 348-7000

**EASTERN ZONE:**

One Panasonic Way 4E-7, Secaucus, NJ 07094 (201) 348-7196

**Southeast Region:** (201) 348-7162

**WESTERN ZONE:**

3330 Cahuenga Blvd W., Los Angeles, CA 90068 (323) 436-3500

**Government Marketing Department:**

One Panasonic Way 2E-10, Secaucus, NJ 07094 (201) 348-7587

**Broadcast PARTS INFORMATION & ORDERING:**

9:00 a.m. – 5:00 p.m. (EST) (800) 334-4881/24 Hr. Fax (800) 334-4880

Emergency after hour parts orders (800) 334-4881

**TECHNICAL SUPPORT:**

Emergency 24 Hour Service (800) 222-0741

**Panasonic Canada Inc.**

5770 Ambler Drive, Mississauga, Ontario L4W 2T3 (905) 624-5010

**Panasonic de Mexico S.A. de C.V.**

Av angel Urraza Num. 1209 Col. de Valle 03100 Mexico, D.F. (52) 1 951 2127

**Panasonic Puerto Rico Inc.**

San Gabriel Industrial Park, 65th Infantry Ave., Km. 9.5, Carolina, Puerto Rico 00630 (787) 750-4300

---

## Professional & Broadcast IT Systems Business Unit Europe Panasonic Marketing Europe GmbH

Hagenauer Str. 43, 65203 Wiesbaden-Biebrich Deutschland Tel: 49-611-235-481