



**RX-V467**

**AV Receiver**

**Owner's Manual**

---

**English**

# CONTENTS

## INTRODUCTION

<b>Features and capabilities</b> .....	<b>3</b>
About this manual.....	4
Supplied accessories .....	4
<b>Part names and functions</b> .....	<b>5</b>
Front panel.....	5
Rear panel.....	6
Front panel display .....	7
Remote control .....	8

## CONNECTIONS

<b>Connecting speakers</b> .....	<b>9</b>
Speaker channels and functions.....	9
Speaker layout .....	10
Connecting speakers and subwoofer .....	11
<b>Connecting external components</b> .....	<b>14</b>
Cable plugs and jacks .....	14
Connecting a TV monitor.....	15
Connecting BD/DVD players and other devices .....	17
Connecting video cameras and portable audio players ..	21
Transmitting input A/V to external components .....	21
<b>Connecting the FM/AM antennas</b> .....	<b>22</b>
<b>Set up the speaker parameters automatically (YPAO)</b> .....	<b>23</b>

## PLAYBACK

<b>Basic playback procedure</b> .....	<b>28</b>
Adjusting high/low-frequency sound (Tone control) .....	28
<b>Changing input settings with a single key (SCENE function)</b> .....	<b>29</b>
Registering input sources/sound field program .....	29
<b>Enjoying sound field programs</b> .....	<b>29</b>
Selecting sound field programs and sound decoders.....	29
Sound field programs .....	32

<b>FM/AM tuning</b> .....	<b>34</b>
Selecting a frequency for reception (Normal tuning).....	34
Registering and recalling a frequency (Preset tuning) ...	35
Recalling a preset station.....	37
Clearing preset stations .....	37
Radio Data System tuning (U.K. and Europe models only) .....	37
<b>Playing back tunes from your iPod™/iPhone™</b> .....	<b>39</b>
Connecting the Yamaha iPod universal dock .....	39
Controlling an iPod™/iPhone™ .....	39
<b>Playing back tunes from Bluetooth™ components</b> .....	<b>42</b>
Connecting a Yamaha Bluetooth wireless audio receiver .....	42
Pairing Bluetooth™ components .....	42
Using Bluetooth™ components .....	43

## SETUP

<b>Configuring the settings specific for each input source (Option menu)</b> .....	<b>44</b>
Option menu display and setup .....	44
Option menu items .....	44
<b>Setting various functions (Setup menu)</b> .....	<b>48</b>
Setup menu display and settings .....	48
Setup menu items .....	49
Manages settings for speakers.....	49
Setting the audio output function of this unit.....	53
Setting HDMI functions .....	54
Making the receiver easier to use .....	57
Setting the sound field program .....	58
Prohibiting setting changes .....	58
<b>Setting sound field program parameters</b> .....	<b>59</b>
CINEMA DSP parameters .....	60
Parameters usable in certain sound field programs .....	60
Parameters usable in surround decoder .....	61
<b>Controlling other components with the remote control</b> .....	<b>62</b>
Keys connecting external components .....	62
Default remote control code settings.....	62

Registering remote control codes for external component operations .....	63
Resetting all remote control codes .....	64

<b>Extended functionality that can be configured as needed (Advanced Setup menu)</b> .....	<b>65</b>
Displaying/Setting the Advanced Setup menu.....	65
Setting the impedance of speakers (U.S.A. and Canada models only).....	65
Avoiding crossing remote control signals when using multiple Yamaha receivers .....	66
Changing FM/AM frequency steps (Asia and General models only).....	66
Initializing various settings for this unit .....	66
<b>Using the HDMI Control function</b> .....	<b>67</b>

## APPENDIX

<b>Troubleshooting</b> .....	<b>70</b>
General.....	70
HDMI™ .....	73
Tuner (FM/AM) .....	73
iPod™/iPhone™ .....	74
Bluetooth™ .....	75
Remote control.....	75
<b>Glossary</b> .....	<b>76</b>
Audio information.....	76
Sound field program information.....	77
Video information .....	77
<b>Information on HDMI™</b> .....	<b>78</b>
<b>About trademarks</b> .....	<b>78</b>
<b>Specifications</b> .....	<b>79</b>
<b>Index</b> .....	<b>81</b>

# INTRODUCTION

## Features and capabilities

■ <b>Built-in high-quality, high-power 5-channel amplifier</b>	
■ <b>1-button input/sound field program switching (SCENE function)</b> .....	29
■ <b>Speaker connections for 2- to 7.1-channel configurations</b>	
– (U.S.A. and Canada models only) Speaker impedance configuration .....	12
– Speaker channels and functions .....	9
– Speaker layout .....	10
– Speaker cable connection .....	11
– Subwoofer cable connection .....	13
– Using with 6.1/7.1-channel speaker layout .....	11
■ <b>Acoustic parameter adjustment to match your speakers and listening environment</b>	
– Automatic settings for speaker acoustic parameters (YPAO - Yamaha Parametric Room Acoustic Optimizer) .....	23
– Specifying the settings for each speaker .....	49
– Volume control for each speaker .....	51
– Speaker distance settings .....	51
– Sound quality control with the equalizer <Graphic Equalizer> .....	51
– Test tone speaker adjustment .....	52
– Bass and treble level adjustment <Tone Control> .....	28
■ <b>External component connection (max. 14 inputs) and playback</b>	
– External component connection .....	15
– Audio signal output from the TV transmitted through the HDMI jack .....	56
– HDMI/AV video input combining other audio input .....	46
– Correction of lag between audio and video signals <Lipsync> .....	53
– Protective cover for front panel jacks .....	4
– Input source name changing <Input Rename> .....	57
– Configuring the settings specific for each input source <Option menu> .....	44
– Playback from external components .....	28
– Playback from an iPod/iPhone (iPod/iPhone and components sold separately) .....	39
– Playback from a Bluetooth component (Bluetooth and components sold separately) .....	42
■ <b>HDMI settings</b>	
– Setting the HDMI functions .....	54
– Controlling this unit from HDMI compatible device such as TVs <HDMI Control function> .....	67
– Listening to TV audio with single HDMI cable connection <Audio Return Channel function> .....	69
■ <b>FM/AM tuner</b>	
– FM/AM broadcast listening .....	34
– Simple preset tuning .....	35
– (U.K. and Europe models) Radio Data System tuning .....	37
– (U.K. and Europe models) Automatic traffic information reception .....	38
– Changing FM mode (Stereo/Monaural) .....	35
– (Asia and General models only) Changing FM/AM frequency steps initializing various settings for this unit .....	34
■ <b>Multi-channel, multi-format playback</b>	
– Sound field effect selection .....	29
– Playback without sound field effects .....	30
– Stereo playback .....	30
– Sound field effect configuration .....	59
– Compressed-music playback .....	29
– Setting the decode format of digital audio signals <Decoder Mode> .....	45
– Selecting the 5.1-channel signal playback method <EXTD Surround> .....	45
■ <b>Front panel information display</b>	
– Front panel display information switching .....	7
– Front panel display brightness adjustment <Dimmer> .....	58
– Digital video/audio signal information display <Signal Info> .....	46
■ <b>Volume adjustment functions</b>	
– Easy listening at low volumes <Adaptive DRC> .....	53
– Maximum volume settings .....	54
– Startup volume settings .....	54
– Adjusting volume between input sources <Volume Trim> .....	45
■ <b>Remote control operation</b>	
– External component operation with this unit's remote control .....	62
– Multiple Yamaha receiver operation without signal interference <Remote ID Switching> .....	66
■ <b>Other features</b>	
– Standby mode after prolonged non-operation <Auto Power Down function> .....	58
– Standby mode after a specific amount of time <Sleep timer> .....	8
– (U.S.A. and Canada models only) To charge the iPod/iPhone when this unit is in standby mode <iPod Standby Charge> .....	41
– Initializing various settings for this unit .....	66
– Prohibiting setting changes of this unit <Memory Guard> .....	58



## About this manual

- Some features are not available in certain regions.
- This manual is created prior to production. Design and specifications are subject to change in part as a result of improvements, etc. In case of differences between the manual and product, the product has priority.
- “**4**HDMI” (example) indicates the name of the parts on the remote control. Refer to the “Part names and functions” (p. 5) for the information about each position of the parts.
- **1** indicates that the reference is in the footnote. Refer to the corresponding numbers on the bottom of the page.
- **3** indicates the page describing the related information.
- Click on the “**1**” at the bottom of the page to display the corresponding page in “Part names and functions.”

- 1** Front panel
- 2** Rear panel
- 3** Front panel display
- 4** Remote control

## Supplied accessories

Check that you received all of the following parts.

- Remote control
- Batteries (AAA, R03, UM-4) x 2
- YPAO microphone
- AM loop antenna
- Indoor FM antenna
- VIDEO AUX input cover

### ■ Attaching the VIDEO AUX input cover (supplied)

To protect against dust, attach the supplied VIDEO AUX input cover to the VIDEO AUX jacks when you do not use the jacks. To remove the cover, push the left section of it.

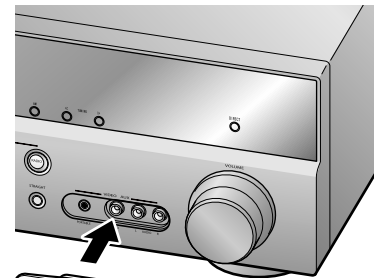

Attach the cover

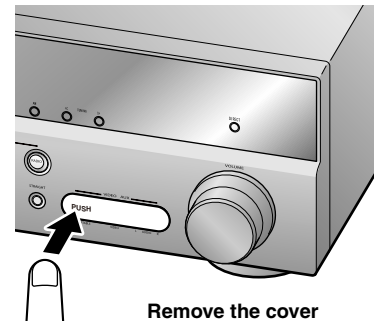

Remove the cover

### ■ Installing batteries in the remote control

When inserting batteries in the remote control, remove the battery compartment cover from the reverse side of the remote control, and insert two AAA batteries into the battery compartment so that they match with the polarity markings (+ and -).

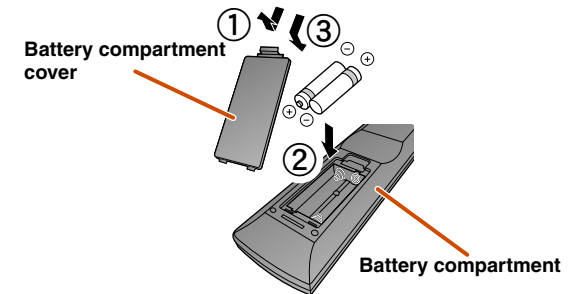

Replace the batteries with new ones if the following symptoms become evident:

- The remote control can only be operated within a narrow range.
- **2**TRANSMIT does not light up, or only lights dimly.

### NOTE

If there are remote control codes for external components registered to the remote control, removing the batteries for more than 2 minutes, or leaving exhausted batteries in the remote control, may clear the remote control codes. If this should occur, replace the batteries with new ones, and set the remote control codes.

## Part names and functions

### Front panel

- ① **⏻ (Power)**  
Switches this unit between on and standby mode.
- ② **HDMI Through/iPod Charge indicator**  
Lights up in any of the following cases while the unit is in standby mode.
  - When Standby Through function is enabled and audio/video from an external component connected with HDMI is output to a TV during the standby mode (p. 55). 1
  - When an iPod is charging in the Yamaha iPod universal dock during the standby mode (p. 41).

When the HDMI Control functions are “On” (p. 55), then this stays on during standby mode.
- ③ **YPAO MIC jack**  
Connect the supplied YPAO microphone and adjust the speaker balance automatically (p. 23).
- ④ **INFO**  
Changes the information displayed on the front panel display (p. 7).

- ⑤ **MEMORY**  
Registers FM/AM stations as preset stations (p. 36). 2
- ⑥ **PRESET </>**  
Selects an FM/AM preset station (p. 37). 2
- ⑦ **FM**  
Sets the FM/AM tuner band to FM (p. 34). 2
- ⑧ **AM**  
Sets the FM/AM tuner band to AM (p. 34). 2
- ⑨ **TUNING <</>>**  
Changes FM/AM tuner frequencies (p. 34). 2
- ⑩ **Front panel display**  
Displays information on this unit (p. 7).
- ⑪ **DIRECT**  
Switches this unit to direct mode (p. 31).
- ⑫ **PHONES jack**  
For plugging headphones in. Sound effects applied during playback can also be heard through the headphones.
- ⑬ **INPUT </>**  
Selects an input source from which to playback. Press either the left or right key repeatedly to cycle through the input sources in order.

- ⑭ **SCENE**  
Switches the input source and the sound field program with a single button (p. 29). When this unit is in standby mode, press this key to switch on.
- ⑮ **TONE CONTROL**  
Adjusts high-frequency/low-frequency output of speakers/headphones (p. 28).
- ⑯ **PROGRAM </>**  
Switches between the sound field effect (sound field program) you are using and the surround sound decoder (p. 29). Press either the left or right key repeatedly to cycle through the input sources in order.
- ⑰ **STRAIGHT**  
Changes a sound field program to straight decoding mode (p. 30).
- ⑱ **VIDEO AUX jacks**  
For connecting video cameras, game consoles, and portable music players to this unit temporarily. Attach the supplied VIDEO AUX input cover when not using this jack.
- ⑲ **VOLUME**  
Adjusts the volume level.

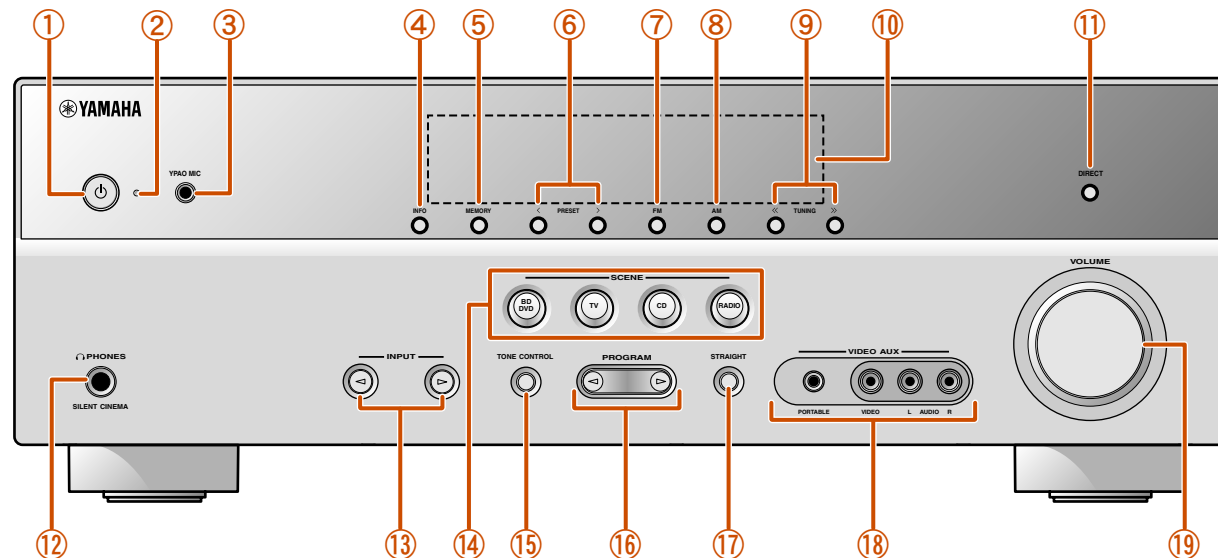

1: During the standby mode, you can select the HDMI input (HDMI1-4) to output to a TV. When the input is changed correctly, HDMI Through/iPod Charge indicator blinks twice.  
2: Usable when you have selected tuner input.

## Rear panel

① **DOCK jack**

For connecting an optional Yamaha iPod universal dock (such as YDS-12) or Bluetooth wireless audio receiver (YBA-10) (see p. 39, p. 42).

② **HDMI OUT jack**

For connecting an HDMI-compatible TV to output audio/video signals (see p. 15).

③ **HDMI1-4 jacks**

For connecting external components equipped with HDMI-compatible outputs to receive audio/video signals (see p. 17).

④ **AV1-6 jacks**

For connecting to external components equipped with audio/video outputs to receive audio/video signals (see p. 18, p. 19).

⑤ **AV OUT jacks**

For outputting audio/video signals received when analog inputs (AV3-6 or AUDIO1-2) are selected (see p. 21).

⑥ **ANTENNA jacks**

For connecting AM and FM antennas (see p. 22).

⑦ **AUDIO1-2 jacks**

For connecting to external components equipped with analog audio outputs to input sound into this unit (see p. 20).

⑧ **MONITOR OUT jacks**

**VIDEO jack**

For connecting a TV capable of receiving video input, and outputting video signals to it (see p. 16).

**COMPONENT VIDEO jacks**

For connecting TV that are compatible with component video signals, using three cables to output video signal (see p. 15).

⑨ **AUDIO OUT jacks**

For outputting audio signals received when analog jacks, such as the AV5-6 or AUDIO1-2 are selected (see p. 21).

⑩ **SPEAKERS terminals**

For connecting the front, center, surround and surround back speakers (see p. 12).

⑪ **SURROUND BACK jacks (PRE OUT)**

Outputs the surround back L/R channel signals. You can enjoy the maximum of 7.1-channels by connecting an external amplifier (see p. 11).

⑫ **SUBWOOFER jack**

For connecting a subwoofer with a built-in amplifier (see p. 13).

⑬ **VOLTAGE SELECTOR**

(Asia and General models only)

Select the switch position according to your local voltage (Refer to Quick Reference Guide).

⑭ **Power cable**

For connecting this unit to an AC wall outlet.

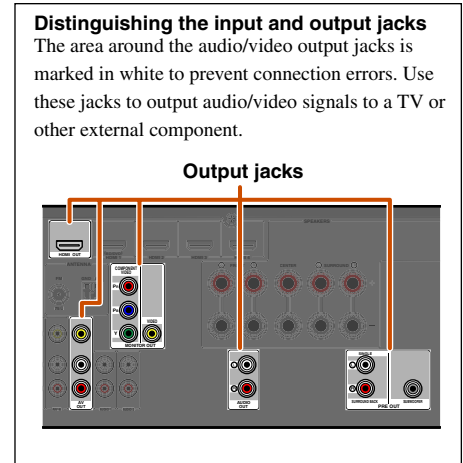
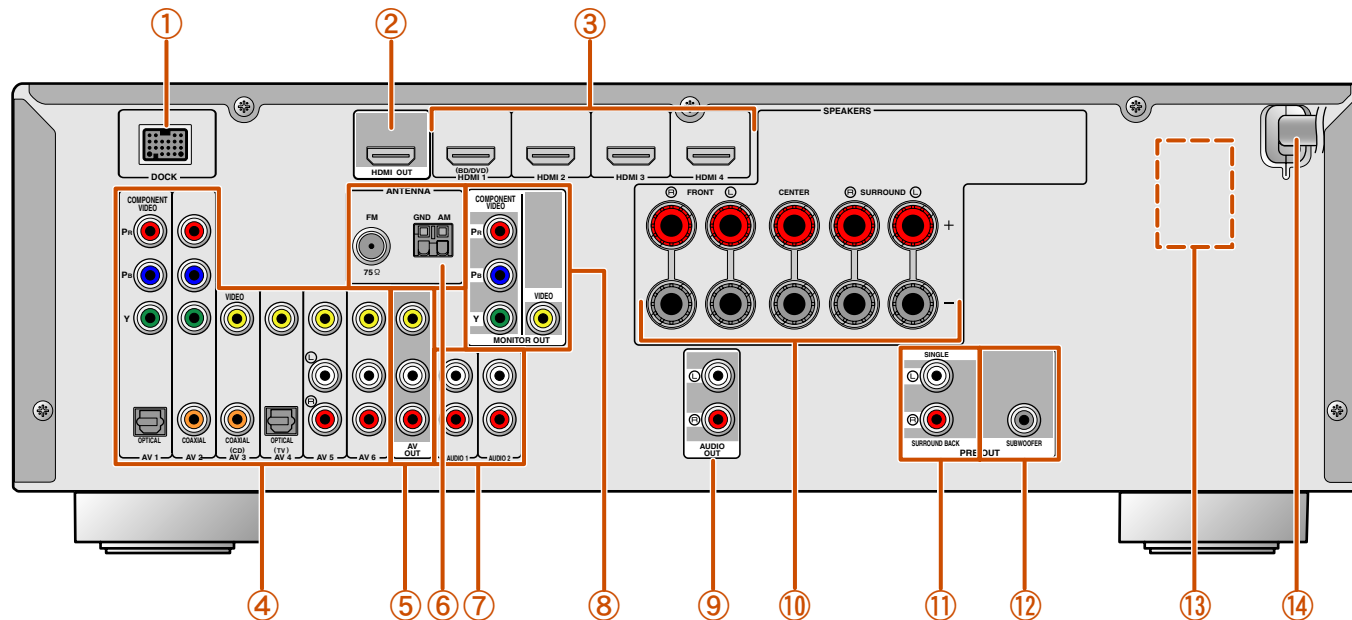

## Front panel display

- ① **HDMI indicator**  
Lights up during normal HDMI communication when any of the HDMI 1-4 inputs are selected.
- ② **CINEMA DSP indicator**  
Lights up when a sound field effect that uses CINEMA DSP technology is selected.
- ③ **Tuner indicator**  
Lights up when receiving an FM/AM broadcast.
- ④ **SLEEP indicator**  
Lights up when the sleep timer is on (p. 8).
- ⑤ **MUTE indicator**  
Flashes when audio is muted.
- ⑥ **VOLUME indicator**  
Displays the current volume level.

- ⑦ **Cursor indicators**  
Light up if corresponding cursors on the remote control are available for operations.
- ⑧ **Multi information display**  
Displays a range of information on menu items and settings.
- ⑨ **Speaker indicators**  
Indicate speaker terminals from which signals are output.

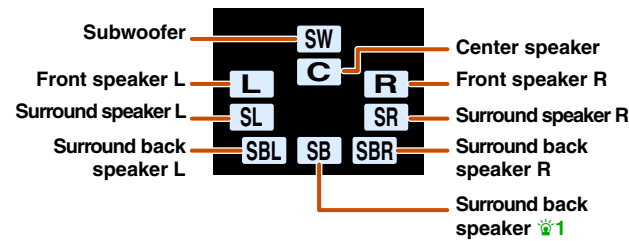

### Changing the front panel display

The front panel can display sound field programs and surround decoder names as well as the active input source. Press **INFO** repeatedly to cycle through input source → sound field program → surround decoder in order. **2**

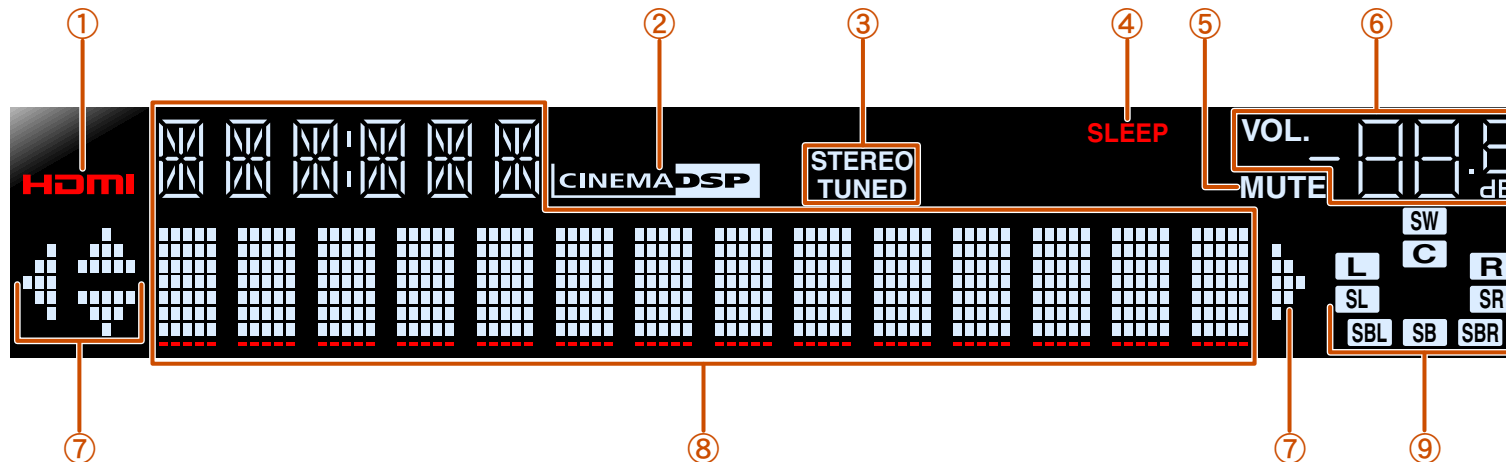
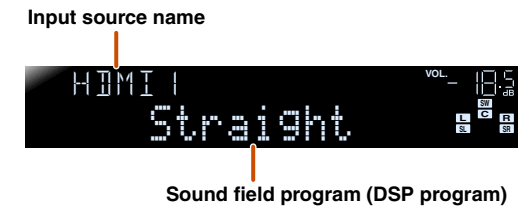

**1**: "SB" is displayed when using a 6.1-channel configuration only.  
**2**: While selecting a tuner input, the FM/AM frequency is displayed instead of the input source.

### Remote control

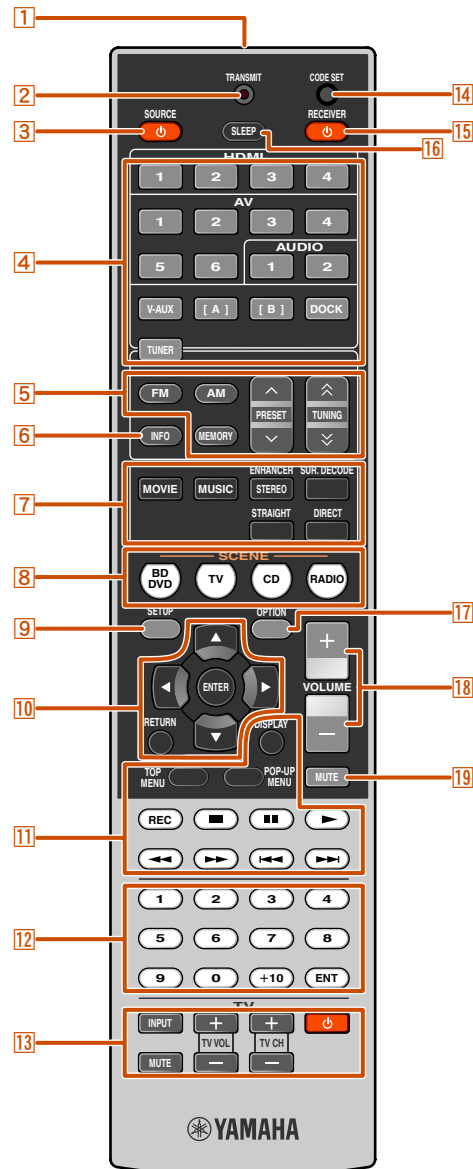

- 1 Remote control signal transmitter**  
Transmits infrared signals.
- 2 TRANSMIT**  
Lights up when a signal is output from the remote control.
- 3 SOURCE  $\phi$  (SOURCE Power)**  
Switches an external component on and off.
- 4 Input selector**  
Select an input source on this unit from which to playback.
 

<b>HDMI1-4</b>	HDMI1-4 jacks
<b>AV1-6</b>	AV1-6 jacks
<b>AUDIO1-2</b>	AUDIO1-2 jacks
<b>V-AUX</b>	Front panel VIDEO AUX jacks
<b>[A]/[B]</b>	Changes the external component to operate with the <b>11 External component operation keys</b> without changing inputs. <b>1</b>
<b>DOCK</b>	A Yamaha iPod universal dock or Bluetooth wireless audio receiver connected to the DOCK jack.
<b>TUNER</b>	FM/AM tuner
- 5 Tuner keys**  
Operates the FM/AM tuner. These keys are used when using the tuner input.
 

<b>FM</b>	Sets the FM/AM tuner band to FM.
<b>AM</b>	Sets the FM/AM tuner band to AM.
<b>MEMORY</b>	Presets radio stations.
<b>PRESET <math>\wedge</math> / <math>\vee</math></b>	Selects a preset station.
<b>TUNING <math>\wedge</math> / <math>\vee</math></b>	Changes tuning frequencies.
- 6 INFO**  
Cycles the information displayed on the front panel display (the name of the currently selected input source, the sound field program, the surround decoder, the FM/AM tuner frequency, etc.) ([p. 7](#)).
- 7 Sound selection keys**  
Switch between the sound field effect (sound field program) you are using and the surround decoder ([p. 29](#)).
- 8 SCENE**  
Switches the input source and the sound field program with a single button ([p. 29](#)). When this unit is in standby mode, press this key to switch on.
- 9 SETUP**  
Displays a detailed Setup menu for this unit ([p. 48](#)).

- 10 Cursor  $\Delta$  /  $\nabla$  /  $\triangleleft$  /  $\triangleright$ , ENTER, RETURN**  
**Cursor  $\Delta$  /  $\nabla$  /  $\triangleleft$  /  $\triangleright$**  Select menu items and change settings when setting menus, etc. are displayed.  
**ENTER** Confirms a selected item.  
**RETURN** Returns to the previous screen when setting menus are displayed, or ends the menu display.
- 11 External component operation keys**  
Operate recording, playback, and menu displays etc. for external components. **1**
- 12 Numeric keys**  
Enter numbers.
- 13 TV control keys**  
Operate a monitor such as a TV.
- 14 CODE SET**  
Sets remote control codes for external component operations ([p. 62](#), [p. 66](#)).
- 15 RECEIVER  $\phi$  (RECEIVER Power)**  
Switches this unit between on and standby mode.
- 16 SLEEP**  
Switch this unit to standby mode automatically after a specified period of time has elapsed (sleep timer). Press this key repeatedly to set the time for the sleep timer function.



The SLEEP indicator ([p. 7](#)) lights up when the sleep timer is on.

- 17 OPTION**  
Displays the Option menu for each input source ([p. 44](#)).
- 18 VOLUME +/-**  
Adjusts the volume level ([p. 28](#)).
- 19 MUTE**  
Turns the mute function of the sound output on and off ([p. 28](#)).

**1** : You can use **11 External component operation keys** for each input source to operate registered components. Remote control codes must be registered for each input in advance if you want to operate external components ([p. 62](#)).





# CONNECTIONS

## Connecting speakers

This unit uses acoustic field effects and sound decoders to bring you the impact of a real movie theater or concert hall. These effects will be brought to you with ideal speaker positioning and connections in your listening environment.

### Speaker channels and functions

#### Front left and right speakers

The front speakers are used for the front channel sounds (stereo sound) and effect sounds.

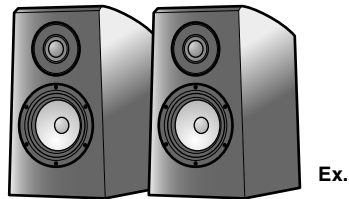

Front speaker layout:

Place these speakers at an equal distance from the ideal listening position in the front of the room. When using a projector screen, the appropriate top positions of the speakers are about 1/4 of the screen from the bottom.

#### Center speaker

The center speaker is for the center channel sounds (dialog, vocals, etc.).

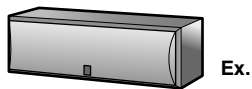

Center speaker layout:

Place it halfway between the left and right front speakers. When using a TV, place the speaker just above or just under the center of the TV with the front surfaces of the TV and the speaker aligned. When using a screen, place it just under the center of the screen.

#### Surround left and right speakers

The surround speakers are for effect and vocal sounds with the 5.1-channel speakers providing rear-area sounds. When used with 6.1/7.1-channel (including surround back channel), sound for right and left rear-area is output.

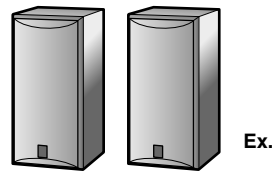

Surround speaker layout:

Place the speakers at the rear of the room on the left and right sides facing the listening position. They should be placed between 60 degrees and 80 degrees from the listening position and with the speaker tops at a height of 1.5 – 1.8 m from the floor.

#### Surround back left and right speakers

Outputs the rear effect. When used with 6.1ch sound, sound from the left and right sound surround back speakers is mixed and output from a single speaker. When used with 5.1ch sound, sound from surround back speakers is distributed between the left and right surround speakers.

When using the surround back speakers, connect an external amplifier to the SURROUND BACK jacks of the PRE OUT terminals.

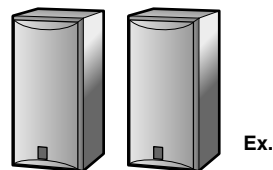

Surround back speaker setting:

When used with 7.1ch sound, arrange the left and right speakers towards the listening position, to the rear of the listening position. Arrange the left and right speakers at least 30 cm apart. The same separation as with the front left and right speakers is optimum. When used with 6.1ch sound, arrange these to the rear of the listening position.

#### Subwoofer

The subwoofer speaker is used for bass sounds and low-frequency effect (LFE) sounds included in Dolby Digital and DTS. Use a subwoofer that is equipped with built-in amplifier.

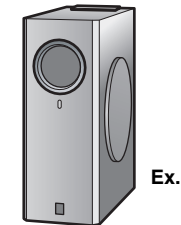

Subwoofer speaker layout:

Place it exterior to the front left and right speakers facing slightly inward to reduce echoes from the wall.

## Speaker layout

### ■ 5.1-channel speaker layout (5 speakers + subwoofer)

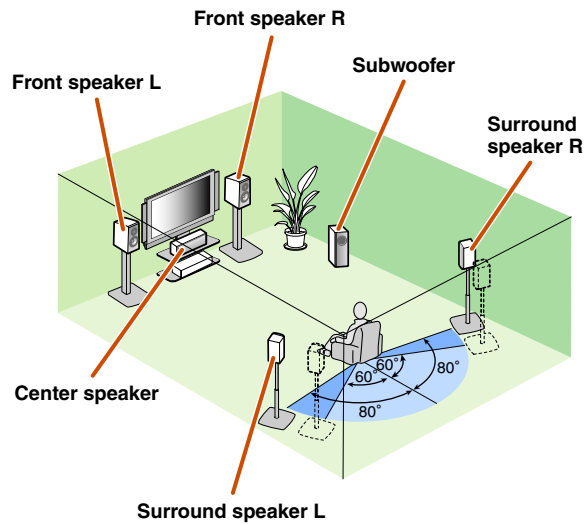

### ■ 6.1-channel speaker layout (6 speakers + subwoofer)

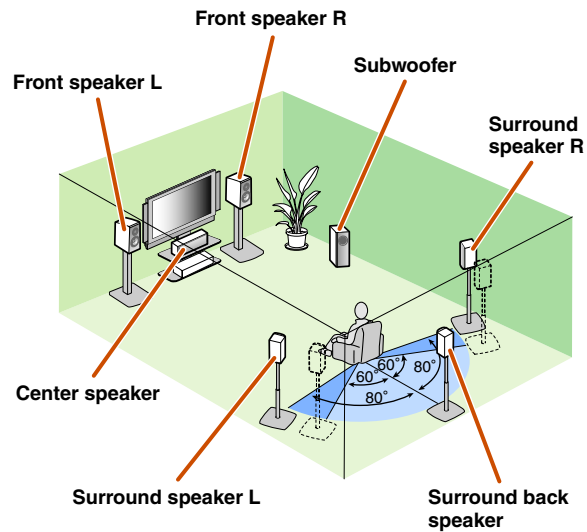

### ■ 7.1-channel speaker layout (7 speakers + subwoofer)

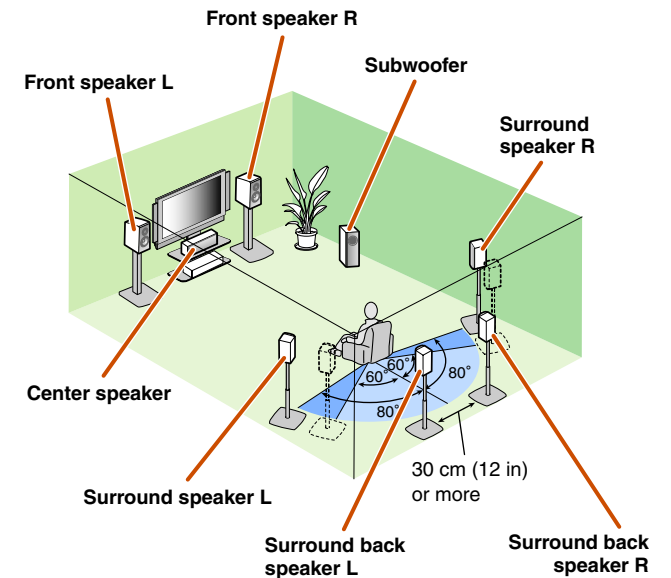

- Connect at least two speakers (front left and right).
- If you cannot connect all five speakers, give priority to the surround speakers.
- The surround speakers should be placed between 60 degrees and 80 degrees from the listening position.
- When used with 7.1-channel speaker layout, arrange the left and right surround back speakers at least 30 cm a part.

#### ■ CRT monitors

We recommend that you use magnetically shielded speakers to avoid video distortion, especially for the front and center speakers near the screen.  
If your screen still gets interference from magnetically shielded speakers, move the speakers farther away from your TV.

 1: When used with 7.1/6.1-channel speaker layout, connect an external amplifier to the SURROUND BACK L/R jacks of the PRE OUT terminals ([see p. 11](#)).

## Connecting speakers and subwoofer

Connect your speakers to their respective terminals on the rear panel.

### CAUTION

- Remove the AC power cable of this unit from the power outlet before connecting the speakers.
- Generally speaker cables consist of two parallel insulated cables. One of these cables is a different color, or has a line running along it, to indicate different polarity. Insert the different colored (or lined) cable into the “+” (positive, red) terminal on this unit and the speakers, and the other cable into the “-” (negative, black) terminal.
- Be careful that the core of the speaker cable does not touch anything or come into contact with the metal areas of this unit. This may damage this unit or the speakers. If the speaker cables short circuit, “CHECK SP WIRES!” will appear on the front panel display when this unit is switched on.

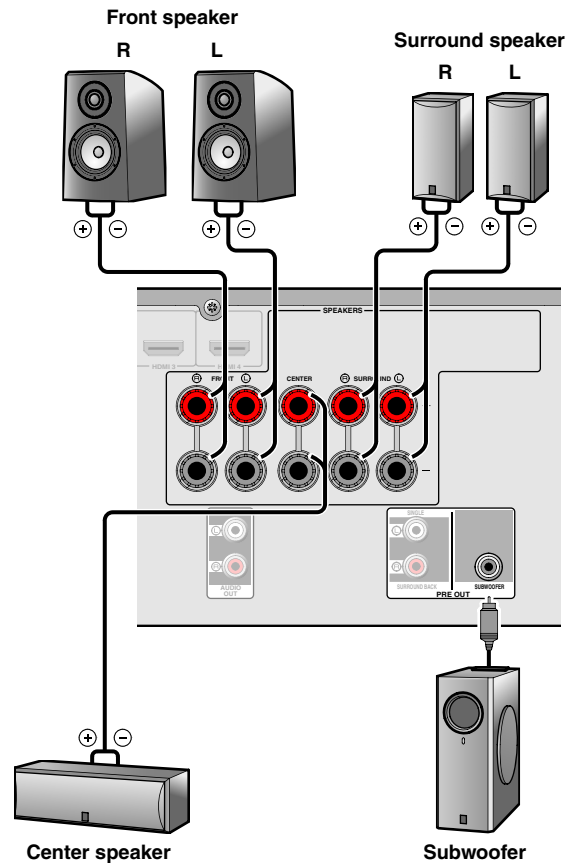

## Connecting the surround back speakers

Connecting an external amplifier to the SURROUND BACK L/R jacks of the PRE OUT terminals allows you to create the maximum of 7.1-channel surround system with a surround back channel. For a 6.1-channel system, connect the external amplifier to the SURROUND BACK L jack of the PRE OUT terminals.

For a 7.1-channel system connect it to the SURROUND BACK L/R jacks.

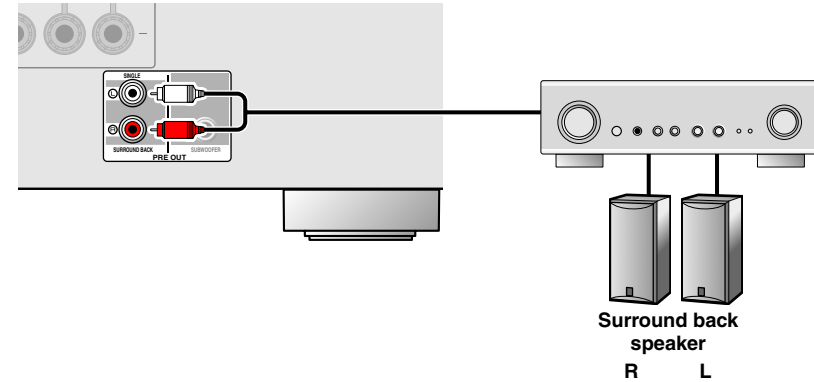

You can adjust the surround back speaker volume with a volume control of the external amplifier. To obtain the balanced sound during playback, set the speaker output characteristics in advance using the YPAO (Yamaha Parametric Room Acoustic Optimizer) or “Speaker Setup” of the Setup menu ([p. 23](#)).

### (U.S.A. and Canada models only) Changing speaker impedance

This unit is configured for 8Ω speakers as the factory setting. When connecting to 6Ω speakers, carry out the following procedure to switch to 6Ω.

**1** Switch this unit to the standby mode.

**2** Press **⏻** while pressing and holding **STRAIGHT** on the front panel.

Release the keys when “ADVANCED SETUP” is displayed on the front panel display.

After approximately a few seconds, the top menu items are displayed. 1

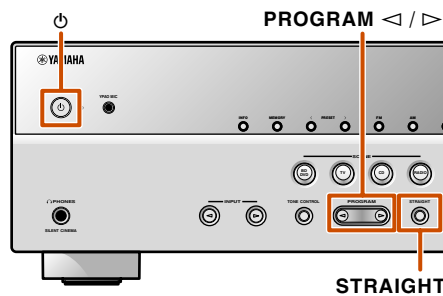

**3** Check that “SP IMP.” is displayed on the front panel.



**4** Press **STRAIGHT** repeatedly to select a “6ΩMIN.”

**5** Switch this unit to the standby mode, and then switch it on again.

The power turns on, when the settings you made has been configured.

### Connecting speakers

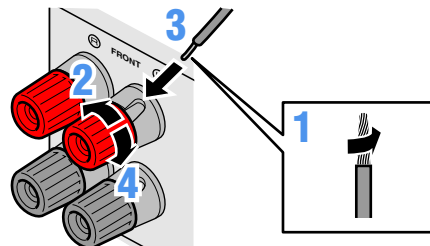

**1** Remove approximately 10 mm of insulation from the ends of the speaker cables, and twist the bare wires of the cables together firmly so that they will not cause short circuits.

**2** Loosen the speaker terminals.

**3** Insert the bare wire of the speaker cable into the gap on the side of the terminal.

**4** Tighten the terminal.

### Connecting the banana plug (Except U.K., Europe, Asia and Korea models)

Tighten the knob, and then insert the banana plug into the end of the terminal.

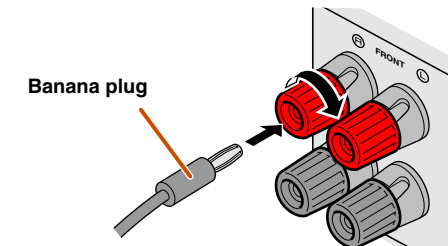

1: Refer to the “Extended functionality that can be configured as needed (Advanced Setup menu)” ([see p. 65](#)) for details on the Advanced Setup menu.

## ■ Connecting the subwoofer

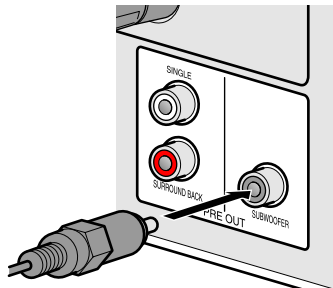

**1** Connect the subwoofer input jack to the **SUBWOOFER** jack on this unit with an audio pin cable.

**2** Set the subwoofer volume as follows.  
Volume: Set to approximately half volume (or slightly less than half).

Crossover frequency (if available): Set to maximum.

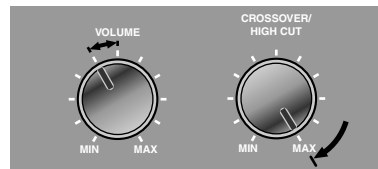

Subwoofer examples

## Connecting external components

### Cable plugs and jacks

This unit is equipped with the following input/output jacks. Use jacks and cables appropriate for components that you are going to connect.

#### Audio/Video jacks

##### HDMI jacks

Digital video and digital sound are transmitted through a single jack. Only use an HDMI cable.

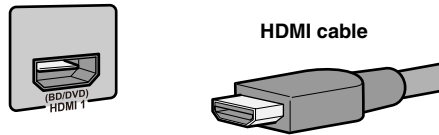

- Use a 19-pin HDMI cable with the HDMI logo.
- We recommend using a cable less than 5.0 m long to prevent signal quality degradation.

#### Analog video jacks

##### COMPONENT VIDEO jacks

The signal is separated into three components: luminance (Y), chrominance blue (PB), and chrominance red (PR).

Use component video pin cables with three plugs.

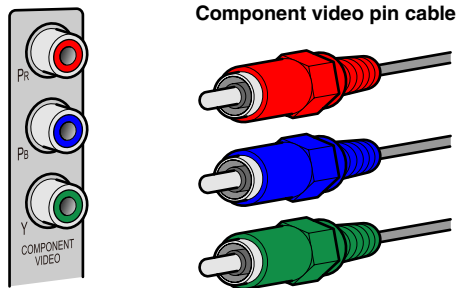

##### VIDEO jack

This jack transmits conventional analog video signals.

Use video pin cables.

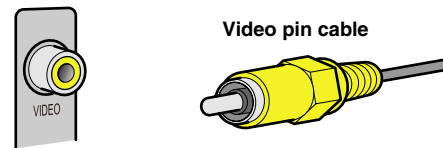

#### Audio jacks

##### OPTICAL jacks

These jacks transmit optical digital audio signals. Use fiber-optic cables for optical digital audio signals.

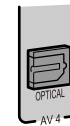

##### Digital audio fiber-optic cable



##### COAXIAL jacks

These jacks transmit coaxial digital audio signals. Use pin cables for digital audio signals.



##### Digital audio pin cable

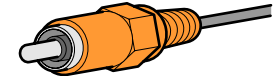

##### AUDIO jacks

These jacks transmit conventional analog audio signals.

Use stereo pin cables, connecting the red plug to the red R jack, and the white plug to the white L jack.



##### Stereo pin cable

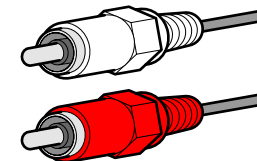

##### PORTABLE jack

This jack transmits conventional analog audio signals.

Use a stereo mini-plug cable when connecting.

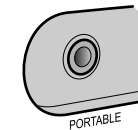

##### Stereo mini-plug cable

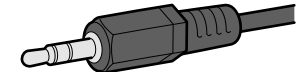

## Connecting a TV monitor

This unit is equipped with the following three types of output jack for connection to a TV. HDMI OUT, COMPONENT VIDEO or VIDEO. Select the proper connection according to the input signal format supported by your TV.

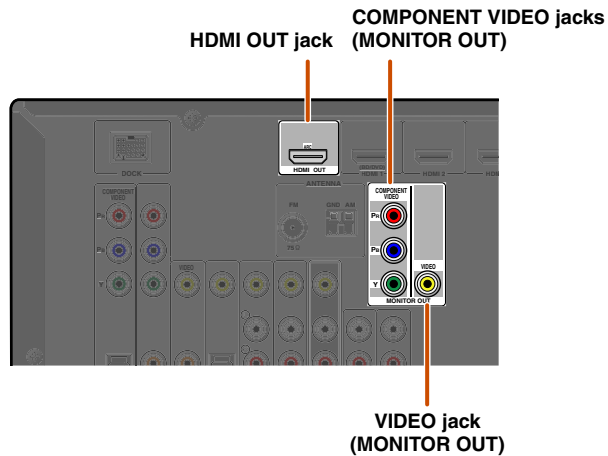

This unit will receive HDMI, component, or video signals in the same format as transmitted by the output devices.

For example, these three output devices must be connected to the TV by matching input/output jacks and cables, and then you must change the TV's input mode to the proper setting.

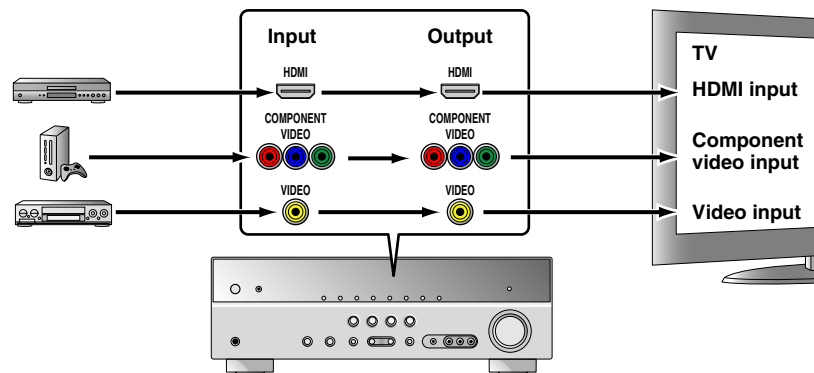

## Connecting an HDMI video monitor

Connect the HDMI cable to the HDMI OUT jack.

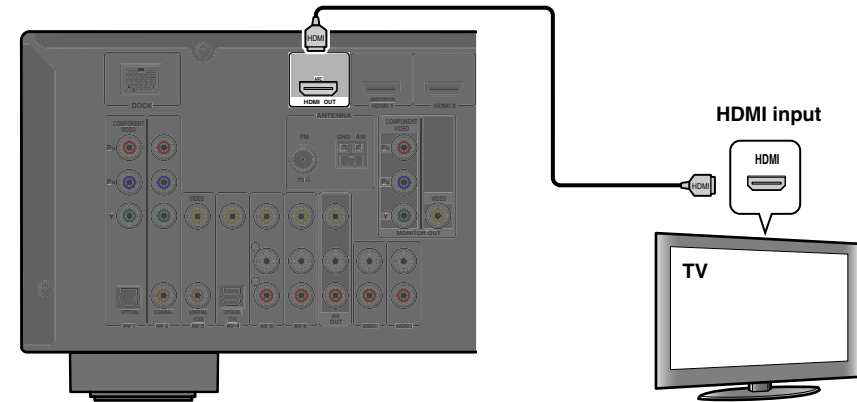

- Use a 19-pin HDMI cable with the HDMI logo.
- We recommend using a cable less than 5.0 m long to prevent signal quality degradation.

## Connecting a component video monitor

Connect the component video cable to the COMPONENT VIDEO (MONITOR OUT) jacks.

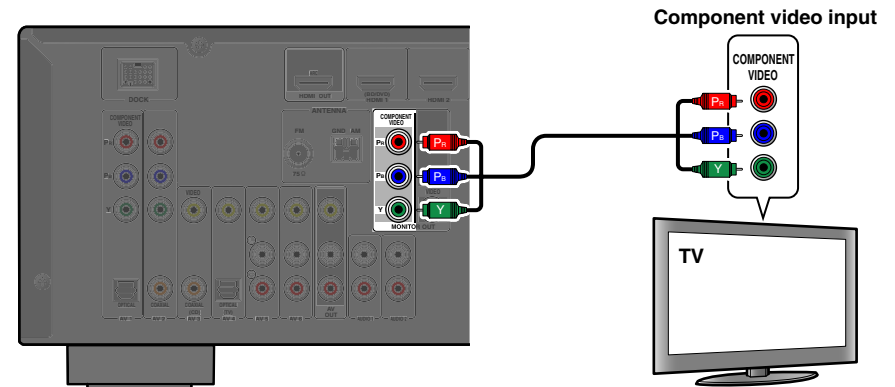

### Connecting a video monitor

Connect the video pin cable to the VIDEO (MONITOR OUT) jack.

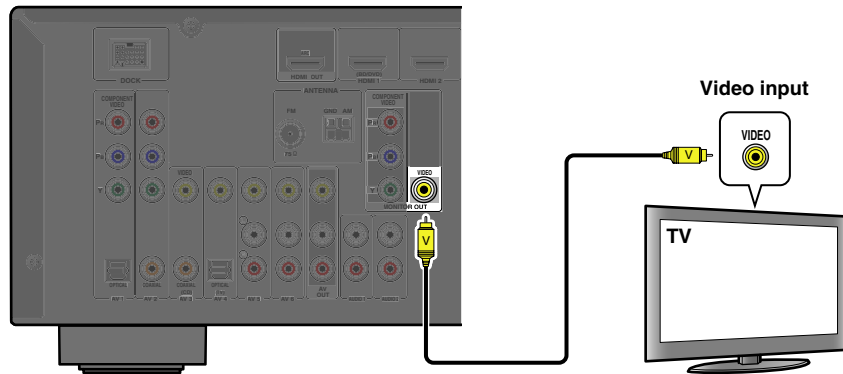

### When using other TVs

To transmit sound from the TV to this unit, connect its AV1-6 or AUDIO1-2 jacks to the TV's audio output jacks.

Depending on the connection on TV, connect the TV's audio output to the AV1-6 or AUDIO1-2.

TV audio output	Connection
Optical digital audio output	Connect to the OPTICAL jack of the AV1 or AV4 with a digital audio pin cable.
Coaxial digital audio output	Connect to the COAXIAL jack of the AV2 or AV3 with a fiber-optic cable.
Analog stereo output	Connect to one of the AV5, AV6, AUDIO1, AUDIO2, or V-AUX with a stereo pin cable.

Select the input source connected via TV's audio output jack to enjoy the TV sound.

If the TV supports optical digital audio output, we recommend that you connect the TV audio output to the receiver's AV4 jack.

Connecting to AV4 allows you to switch the input source to AV4 with just a single key operation using the SCENE function ([p. 29](#)).

### Listening to TV audio

To transmit sound from the TV to this unit, connect as followings according to the TV:

#### When using a TV that supports the Audio Return Channel function and HDMI Control function

When your TV supports both HDMI Control (Ex. Panasonic VIERA Link) and Audio Return Channel functions, audio/video output from the unit to the TV and audio output from the TV to the unit are possible using a single HDMI cable.

The input source is switched automatically to match operations carried out on the TV, and that makes TV sound control easier to use.

For the connections and settings, refer to "Single HDMI cable input to TV audio with Audio Return Channel function" ([p. 69](#)).

#### When using a TV that supports the HDMI Control functions

When using a TV that supports HDMI Control functions (Ex. Panasonic VIERA Link), if HDMI Control functions are enabled on the unit, then input source can be switched automatically to match operations carried out on the TV.

For the connections and settings, refer to "Switching the input source on this unit automatically when listening to TV audio" ([p. 68](#)).

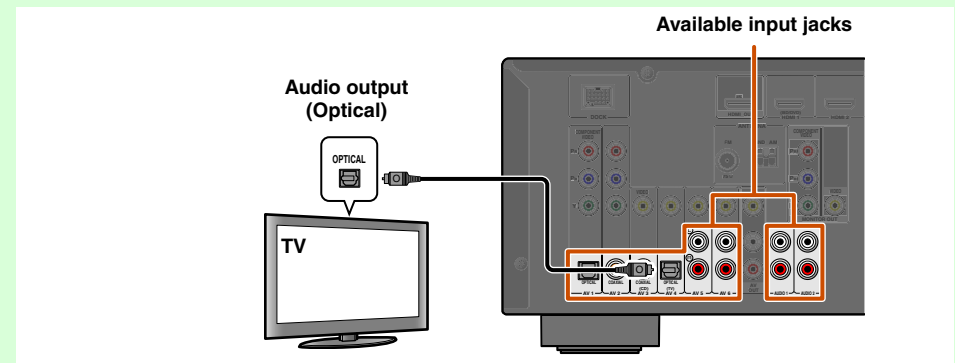

You can control your TV using the receiver's remote control by entering the TV's remote control code ([p. 62](#)).



## Connecting BD/DVD players and other devices

This unit has the following input jacks. Connect them to the appropriate output jacks on the playback devices such as BD/DVD players.

Input jack	Video input	Audio input
HDMI1	HDMI	HDMI
HDMI2	HDMI	HDMI
HDMI3	HDMI	HDMI
HDMI4	HDMI	HDMI
AV1	Component video	Optical digital
AV2	Component video	Coaxial digital
AV3	Video	Coaxial digital
AV4	Video	Optical digital
AV5	Video	Analog (Stereo)
AV6	Video	Analog (Stereo)
AUDIO1	—	Analog (Stereo)
AUDIO2	—	Analog (Stereo)
VIDEO AUX	Video	Analog (Stereo)

## Connecting BD/DVD players and other devices with HDMI

Connect the device with an HDMI cable to one of the HDMI1-4 jacks. Select the HDMI input (HDMI1-4) that the playback device is connected to for playback.

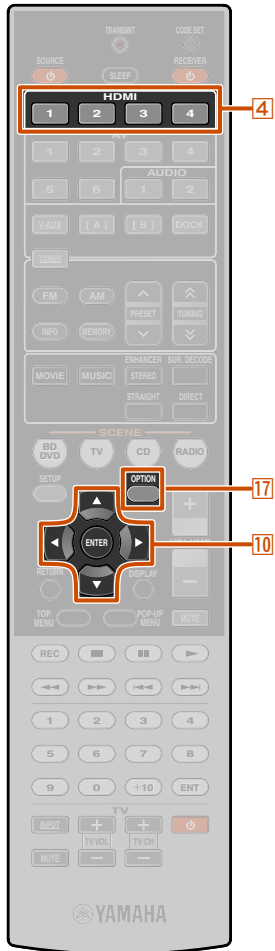

- 4 Input selector
- 10 Cursor ▽ / ▹ / ▸ / ▹
- 10 ENTER
- 17 OPTION

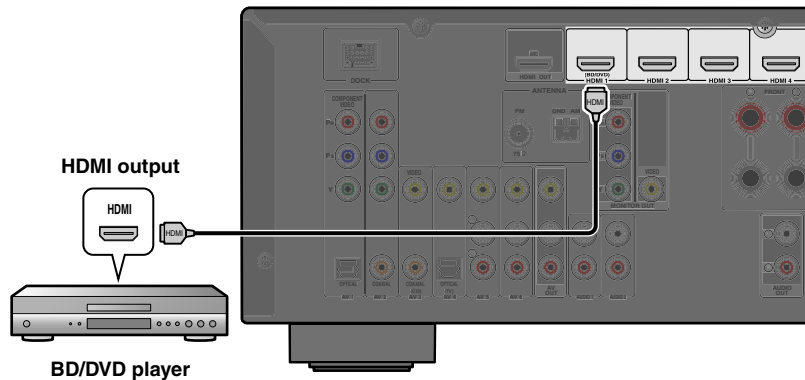

## Receiving video signals from the HDMI jack and audio signals from a jack other than HDMI

This unit can use the AV1-6 or AUDIO1-2 input jacks to receive audio signals from other input jacks.

For example, if an playback device cannot produce audio signals from an HDMI jack, use the following method to change the audio input.

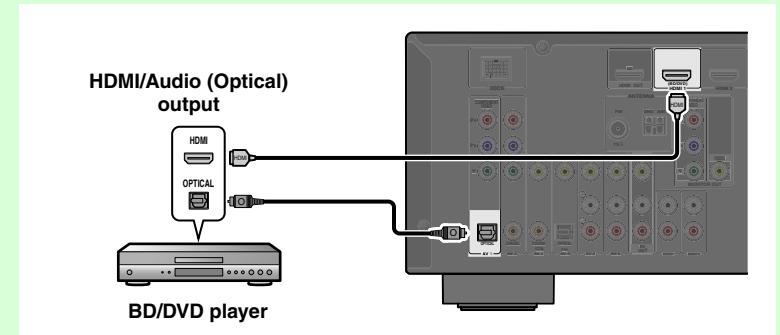

- 1 Use the 4 Input selector to select the desired HDMI input source.
  - 2 Press 17 OPTION to display the Option menu. 1
  - 3 Press 10 Cursor ▽ until "Audio In" is displayed, and then press 10 ENTER.
  - 4 Press 10 Cursor </> to select the audio input source.
- If you have selected AV1 input audio (optical digital)
- 5 Once you have completed the setup, press 17 OPTION to close the Option menu.

1: Refer to the "Configuring the settings specific for each input source (Option menu)" ([p. 44](#)) for details on the Option menu.

## ■ Connecting BD/DVD players and other devices with component cables

Connect the device with a component video cable to one of the AV1-2 input jacks.

### Using optical digital audio output sources

Select the AV1 input that the playback device is connected to for playback.

Component video / Audio (Optical) output

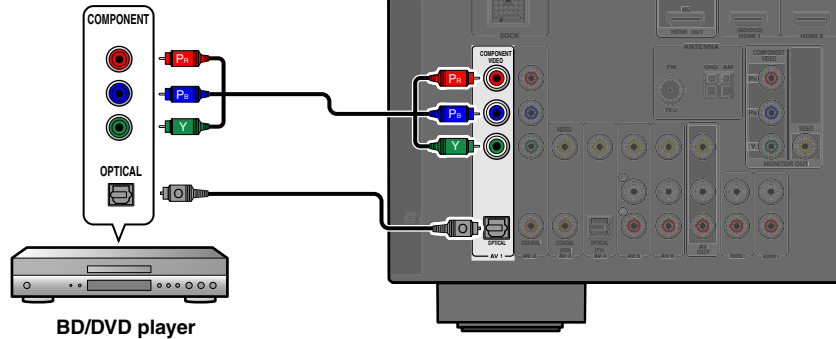

### Using coaxial digital audio output sources

Select the AV2 input that the playback device is connected to for playback.

Component video / Audio (Coaxial) output

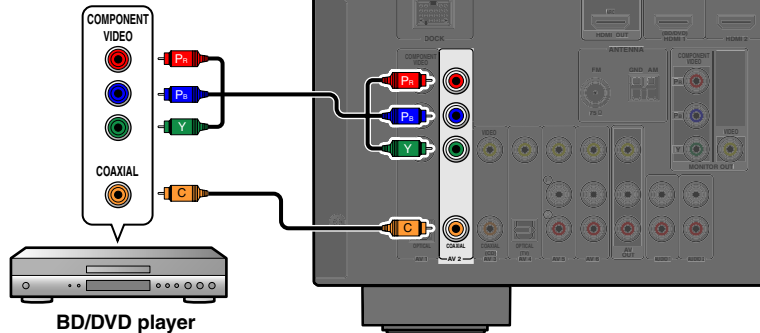

## ■ Component connections to analog audio output devices

Component video / Audio output

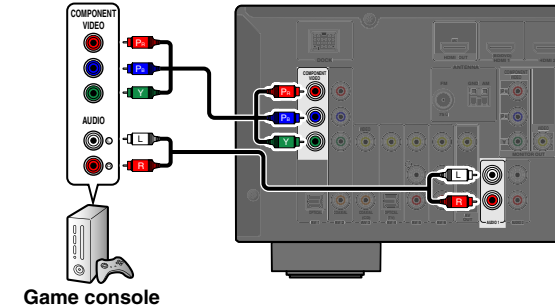

You can use the video input from the AV1-2 jacks in combination with the audio input from other AV inputs or AUDIO1-2.

When connecting these devices, select the AV input jacks or the AUDIO1-2 jacks as the audio input for AV1 or AV2. Refer to “Receiving video signals from the HDMI jack and audio signals from a jack other than HDMI” (p. 17) for detailed setup guidance.

Select the AV input source (AV1-2) that is connected by component video cable to the playback device for playback.



If you have selected AUDIO1 input audio (Analog stereo)

## Connecting BD/DVD players and other devices with video cables

Connect the playback device with a video pin cable to one of the AV3-6 input jacks.

### Using optical digital audio output sources

Select the AV4 input that the playback device is connected to for playback.

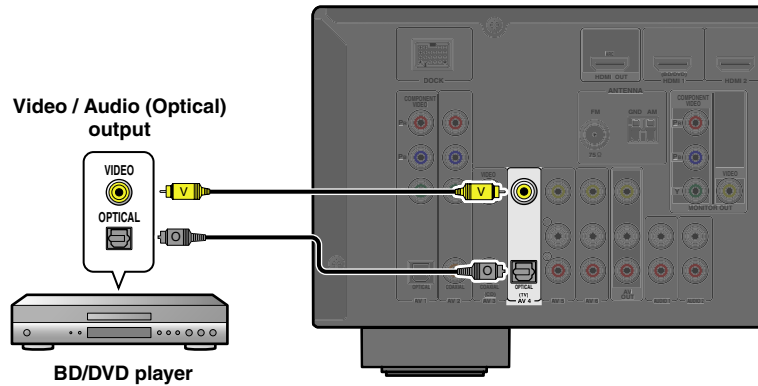

### Using analog stereo audio output sources

Select the AV5 or AV6 input that the playback device is connected to for playback.

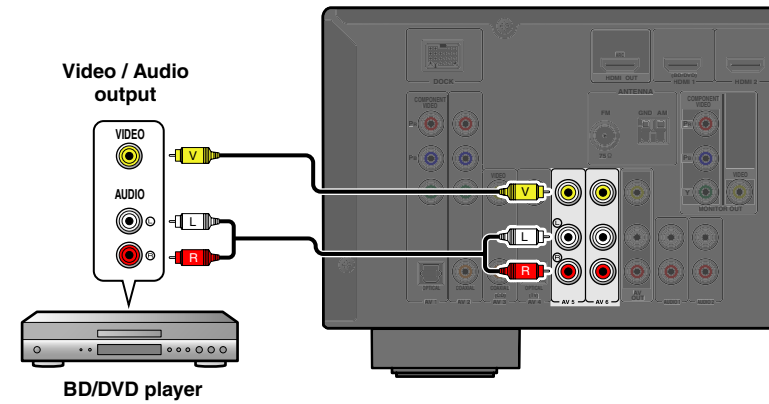

### Using coaxial digital audio output sources

Select the AV3 input that the playback device is connected to for playback.

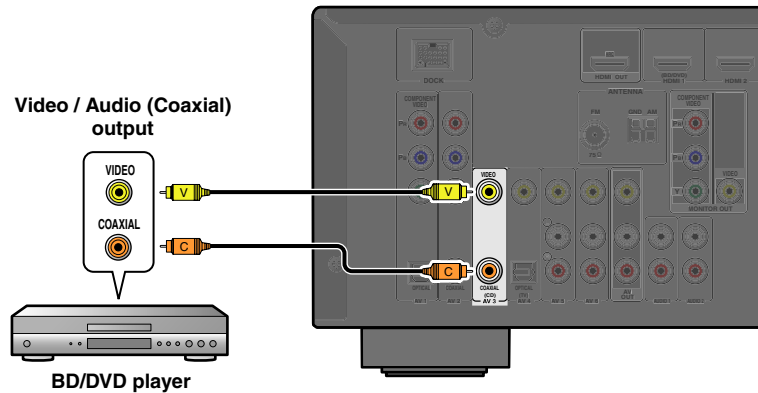

## Connecting CD players and other audio devices

### Using analog stereo output sources

Select the audio input (AUDIO1-2) that the playback device is connected to for playback.

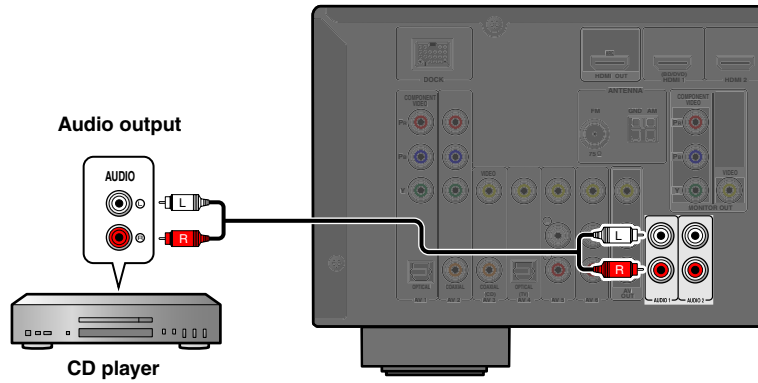

### Using optical digital output sources

Select the AV input (AV1 or AV4) that the playback device is connected to for playback.

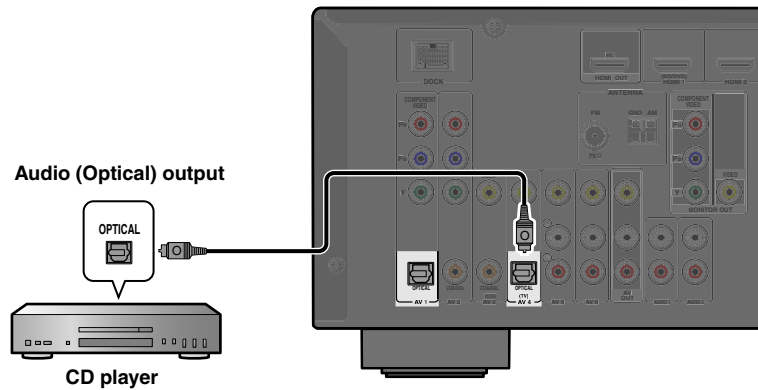

### Using coaxial digital output sources

Select the AV input (AV2 or AV3) that the playback device is connected to for playback.

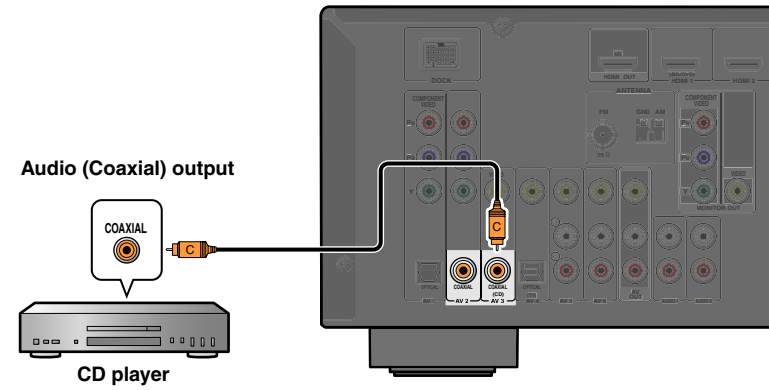

We recommend connecting audio devices with an coaxial digital output to the AV3 coaxial digital jack on this unit. This connection allows you to switch to the AV input 3 just by pressing the “CD” SCENE key ([ESP. p. 29](#)).

## Connecting video cameras and portable audio players

Use the VIDEO AUX jacks on the front panel to temporarily connect video cameras, video game units, or portable audio devices to the receiver.

Select the V-AUX input to use these connected devices.

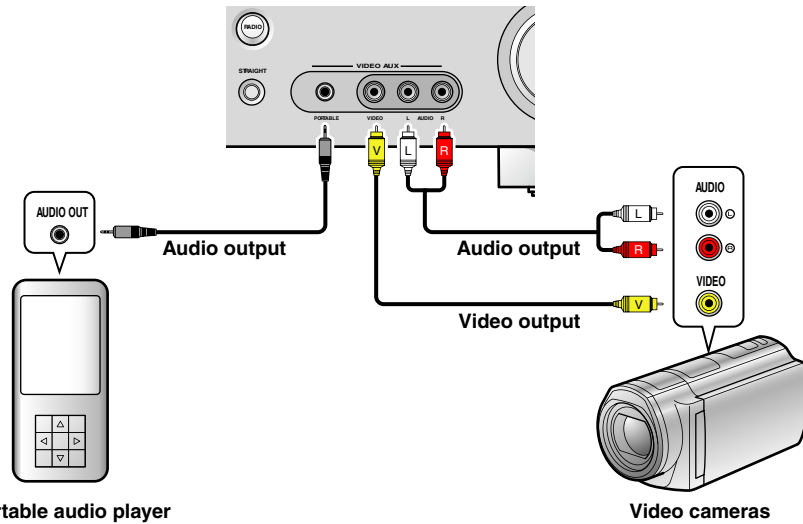

- Be sure to turn down the volume when connecting this unit and the other devices.
- When external components are connected to both the PORTABLE jack and the AUDIO jacks, the sound output from the PORTABLE jack is transmitted.

## Transmitting input A/V to external components

This receiver can transmit selected incoming analog audio/video signals to external components through the AV OUT and AUDIO OUT jacks. You can record these input audio and video signals to VCRs or similar devices, or send them to other TVs or external components.

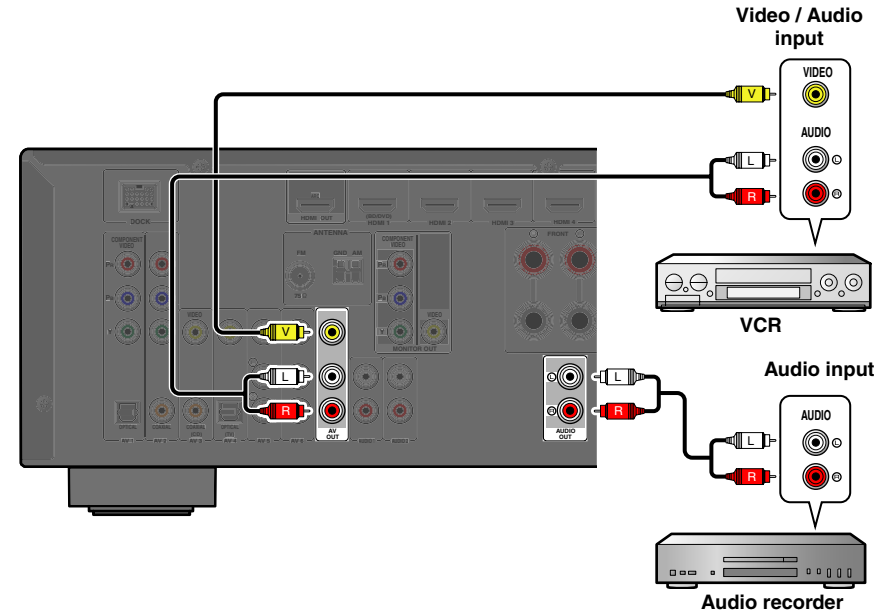

### Using the AV OUT jacks

Connect these jacks to the external component's video input jack and analog audio input jacks.

### Using the AUDIO OUT jacks

Connect this jack to the external component's analog audio input jacks.

HDMI audio/video signals, component video signals, and digital audio signals cannot be transmitted from these jacks.

## Connecting the FM/AM antennas

An indoor FM antenna and an AM loop antenna are supplied with this receiver. Connect these antennas properly to their respective jacks.

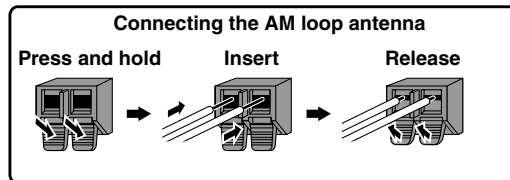
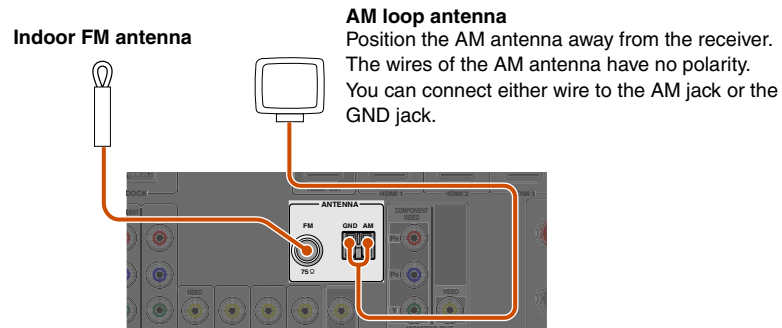

### ■ Improving FM reception

We recommend using an outdoor antenna. For more information, consult the nearest authorized dealer.

### ■ Improving AM reception

Connect this unit to an outdoor antenna with a 5-10 m vinyl-coated wire. Make sure the AM loop antenna is still connected.

Connecting the GND jack can reduce noise. Connect the jack to a store-bought ground bar or copper plate with a vinyl-covered wire and bury this new attachment in moist ground.

The GND jack is not to be connected to the ground socket of an electrical outlet.

## Set up the speaker parameters automatically (YPAO)

This unit is equipped with a YPAO (Yamaha Parametric Room Acoustic Optimizer) that adjusts the status, size, and volume balance of the speakers in order to provide an optimal sound field. Using YPAO allows you to automatically configure settings for which specialist knowledge is usually needed, such as adjusting speaker output and acoustic parameters to suit your listening room (the room in which this unit is placed). 

When you use YPAO, a test tone will be output from the speakers for approximately 3 minutes and acoustic measuring will be performed. When using YPAO, be careful of the following.

- The test tone is output at high volume. Please refrain from using this function at night when it may be a nuisance to others nearby.
- Please take care that the test tone does not frighten any small children.

### 1 Check the following before using YPAO.

#### This unit

- The headphones are removed.

#### Subwoofer

- The power is turned on.
- Volume is set to approximately half, and the cross-over frequency (if present) is set to maximum.

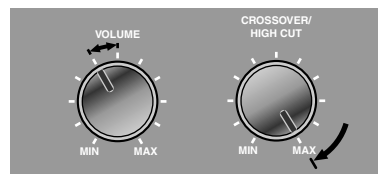

Subwoofer examples

### 2 Place the supplied YPAO microphone at ear height in your listening position.

Face the head of the YPAO microphone upwards.

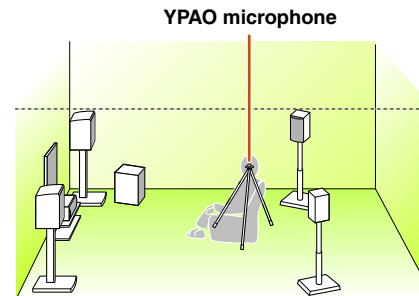

When positioning the microphone, we recommend that you use equipment that allows you to adjust the height (such as a tripod) as a microphone stand. When using a tripod, use the tripod screws to fix the microphone in place.

### 3 Switch this unit on.

### 4 Connect the YPAO microphone to the YPAO MIC jack on the front panel.

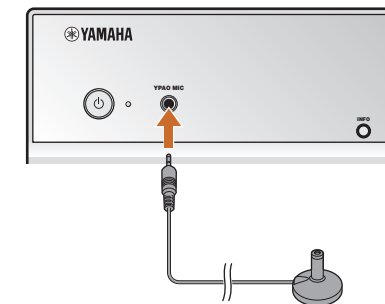

“MIC ON. YPAO START” appears on the front panel display, and then changes to display the following. 



Continues to the next page 

 1: When you have changed the number of speakers or the locations in which they are installed, first use YPAO to adjust the speaker balance.

 2: To cancel measurement, disconnect the YPAO microphone.

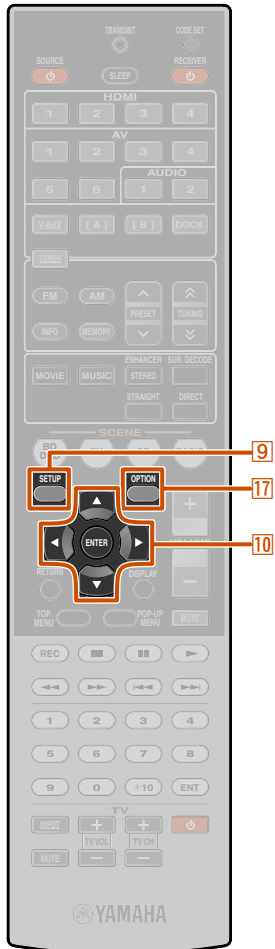

- 9 SETUP
- 10 Cursor  $\Delta$  /  $\nabla$  /  $\leftarrow$  /  $\rightarrow$
- 10 ENTER
- 17 OPTION

### 5 If necessary, press 17 **OPTION** repeatedly and select the measuring acoustic characteristics in the “EQ Type” setting.

During YPAO, the results of measuring the acoustic characteristics are used to set the equalizer (parametric equalizer) to give a unified sound field. After setting, you can select the characteristics of the sound field in “EQ Type,” as necessary.

Natural (Default)	Adjusts all speaker sound to give natural acoustics.
Flat	Sets uniform characteristics for each speaker. Choose this when all of the speakers used are of the same quality. If the treble range sounds harsh after adjustment, select “Natural” and measure again.
Front	Sets the characteristics of each speaker to match the front speakers. Choose this when the front speakers are of significantly higher quality than the other speakers.

This completes preparations. To achieve more accurate results, be careful of the following when measuring.

- Measuring will take approximately 3 minutes. Keep the room as quiet as possible during measurement.
- Wait in the corner of the listening room during measurement or leave it entirely, to avoid becoming an obstruction between the speakers and the YPAO microphone.

 1: You can also select “EQ Type” using the cursor keys. Press 10 **Cursor**  $\Delta$  to select “EQ Type,” and you can change the setting using 10 **Cursor**  $\leftarrow$  /  $\rightarrow$ .

### 6 Press 9 **SETUP** to start measurement.

Display during measurement



The following display appears when measurement finishes without any problems.



#### NOTE

When a problem occurs, an error message or report appears either during or after measurement. Use the following page as a reference to solve the problem, and carry out YPAO again.

### 7 Press 10 **ENTER** to apply the results of measurement.



You can use the following method to cancel measurement results if you want to redo the measuring. Press 10 **Cursor**  $\nabla$  to switch to the following display, the use 10 **Cursor**  $\leftarrow$  /  $\rightarrow$  to select “Cancel” and press 10 **ENTER**. After this operation, use the same procedure to carry out YPAO again.



### 8 Remove the YPAO microphone.

YPAO finishes automatically when the YPAO microphone is removed.

The YPAO microphone is sensitive to heat. When you have finished measuring, store the microphone out of direct sunlight, and away from locations that may experience high temperatures, such as on top of AV equipment.



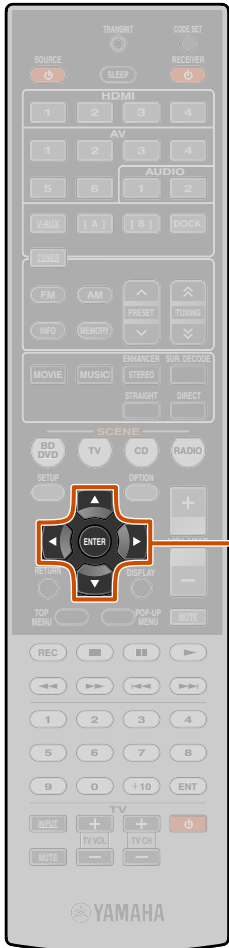

**10** Cursor  $\nabla / \triangle / \leftarrow / \rightarrow$   
**10** ENTER

## When an error message appears during measurement

Check the content of the message from the “Error message” (p. 26) to resolve the problem, and carry out the measurement process again.



Error message (example)

Check the error code that appears in the display, and carry out YPAO again by performing the following steps.

### When “E-1,” “E-2,” “E-4” or “E-6” is displayed:

- 1 Press **10**Cursor  $\nabla$  once, and then press **10**Cursor  $\triangleright$  to select “Exit.”
- 2 Press **10**ENTER to finish YPAO, and switch the unit to standby mode.
- 3 Check that the speakers are properly connected.
- 4 Turn on the unit, and then carry out YPAO again.

### When “E-5,” “E-7,” “E-8” or “E-9” is displayed:

- 1 Check that the environment is suitable for accurate measurement.
- 2 Press **10**Cursor  $\nabla$  once to select “Retry.”
- 3 Press **10**ENTER to carry out YPAO again.

### When “E-10” is displayed:

- 1 Press **10**Cursor  $\nabla$  once to select “Exit.”
- 2 Press **10**ENTER to finish YPAO.
- 3 Switch the unit to standby mode.
- 4 Turn on the unit again, and then carry out YPAO.

## When a warning message appears after measurement

Check the content of the message from the “Warning message” (p. 27) to resolve the problem. You can confirm the speaker that has the problem on the TV screen.



Number of messages

### NOTE

Although you can apply the results of measurement when a warning message appears, doing so will not provide optimal sound. We recommend you resolve the problem and then carry out YPAO again.

### Confirm the warning message:

Press **10**ENTER once.



Warning message (example)

Speaker that has a problem

### When multiple warning messages exist:

Press **10**ENTER to confirm the warning message and use **10**Cursor  $\triangleleft / \triangleright$  to display other warning messages.

### When applying the results of measurement:

If a warning message is displayed, press **10**ENTER to switch display, use **10**Cursor  $\triangleleft / \triangleright$  to select “Set,” and press **10**ENTER.

### When cancelling YPAO:

If a warning message is displayed, press **10**ENTER to switch display, use **10**Cursor  $\triangleleft / \triangleright$  to select “Cancel,” and press **10**ENTER.

## Message list

### NOTE

If the following messages appear, resolve the problems that have occurred and carry out the measurement process again.

### When a warning message appears before measurement

Connect MIC!	The YPAO microphone is not connected.	Connect the YPAO microphone to the YPAO MIC jack on the front panel.
Unplug HP!	The headphones are connected.	Remove the headphones.
Memory Guard!	The settings of this unit are protected.	Set "Memory Guard" in the Setup menu to "Off" ( <a href="#">see p. 58</a> ).

### Error message

E-1:FRONT SP	The unit was not able to find the front channel.	Check that the left and right front speakers are connected correctly.
E-2: SUR. SP	The unit was only able to find one of side of the surround channels.	Check that the left and right surround speakers are connected correctly.
E-4: SBR->SBL	Only one surround back speaker is connected and only the right side surround back channel sound is detected.	When only one surround back speaker is connected, connect to the left side terminal on the external amplifier.
E-5: NOISY	The noise is too loud, preventing accurate measurements from being taken.	Measure again in quiet surroundings. Turn off any devices in the room that may be emitting noise, or place them further away from the YPAO microphone. When this message is displayed, selecting "Proceed" will allow you to continue measuring. However, we recommend resolving the problem and measuring again, as continuing measurement without doing so will not give accurate results.
E-6: CHECK SUR.	Even though surround left and right speakers are not connected, only the surround back speakers are connected.	When using surround back speakers, connection of the surround left/right speakers is necessary.

E-7: NO MIC	The YPAO microphone has been removed.	While measuring, take care not to touch the YPAO microphone.
E-8: NO SIGNAL	The YPAO microphone could not distinguish a test tone.	<p>Check that the YPAO microphone has been installed correctly.</p> <p>Check that each speaker has been connected and installed correctly.</p> <p>The YPAO microphone or the YPAO MIC jack may be broken. Inquire at the retailer where you purchased this unit, or the nearest Yamaha service center.</p>
E-9: CANCEL	You have carried out an operation that has cancelled the measuring process.	Carry out the measuring process again. Do not operate this unit by, for example, adjusting the volume.
E-10: INTERNAL	An internal error has occurred.	Carry out the measuring process again. Contact a Yamaha service center if "E-10" appears again.



## ■ Warning message

W-1: PHASE	<p>The speakers displayed are connected with the opposite polarity.</p> <p>Depending on the type of speakers you are using and the environment in which you have them installed, this message may occur even if the speakers are connected correctly.</p>	<p>Depending on the type of speakers, “W-1” may display even if the speakers are connected correctly.</p> <hr/> <p>Check that the speaker polarity + (positive), and - (negative) are correct. If these are connected correctly, you can use the speakers normally even this message appears.</p>
W-2: DISTANCE	<p>The speakers displayed are separated from the listening position by more than 24 m, and cannot be adjusted correctly.</p>	<p>Install the speakers with 24 m of the listening point.</p>
W-3: LEVEL	<p>The difference each channel is too loud or too low, and cannot be adjusted correctly.</p>	<p>Check that all speakers are installed in the same surroundings.</p> <hr/> <p>Check that the speaker polarity + (positive), and - (negative) are correct.</p> <hr/> <p>We recommend the same speakers or speakers with as similar specifications as possible.</p> <hr/> <p>Adjust the volume of the subwoofer.</p>

If “W-2” or “W-3” appears, you can apply measurement results, but they will not give optimal results. We recommend that you resolve the problem and carry out the measurement process again.

# PLAYBACK

## Basic playback procedure

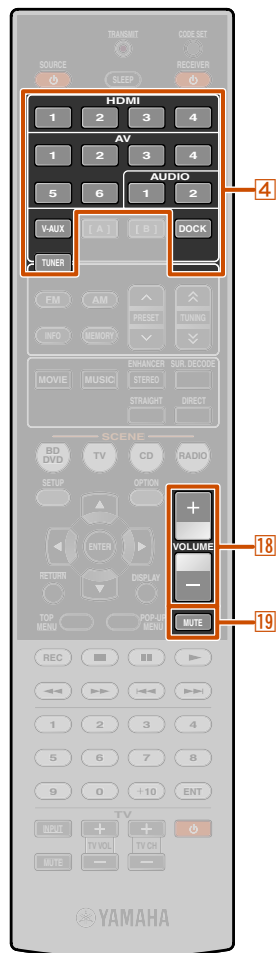

- 4 Input selector
- 18 VOLUME +/-
- 19 MUTE

- 1 Turn on external components (TV, DVD player, etc.) connected to this unit.
- 2 Turn on this unit and select the input source using 4 Input selector.  
The name of the selected input source is displayed for a few seconds. 🌟1
- 3 Play the external component that you have selected as the source input, or select a radio station on the tuner.  
Refer to the instruction manuals provided with the external component for details on playback.  
For details on the following operations, refer to the corresponding pages:
  - “FM/AM tuning” (p. 34)
  - “Playing back tunes from your iPod™/iPhone™” (p. 39)
  - “Playing back tunes from Bluetooth™ components” (p. 42)
- 4 Press 18 VOLUME +/- to adjust the volume.

### To mute the output.

Press 19 MUTE to mute the audio output.

Press 19 MUTE again to unmute.

## Adjusting high/low-frequency sound (Tone control)

You can adjust the balance of the high-frequency range (Treble) and low-frequency range (Bass) of sounds output from the front left and right speakers to obtain desired tone.

The tone control of the speakers or headphones can be set separately. Set the headphone tone control with the headphones connected.

- 1 Press TONE CONTROL on the front panel repeatedly to select “Treble” or “Bass.”

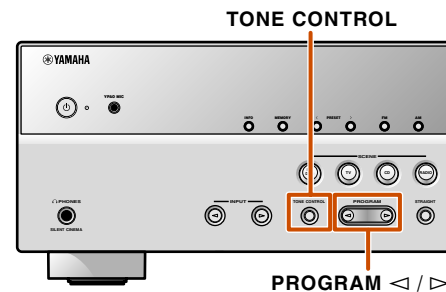

The current setting is displayed on the front panel display.



- 2 Press PROGRAM </> to adjust the output level in those frequency ranges.

Adjustable range	-10.0 dB to +10.0 dB
Adjustment increments	2.0 dB

The display returns to the previous display soon after you release the key.

If you set the balance extremely off, sounds may not match those from other channels well.

🌟1 : You can change the input source name displayed on the front panel display as necessary (p. 57).

## Changing input settings with a single key (SCENE function)



- 4 Input selector  
7 Sound selection keys  
8 SCENE

This unit has a SCENE function that allows you switch this unit on and change input sources and sound field programs with one key.

Four scenes are available for different uses, such as playing movies or music. The following input sources and sound field programs are provided as the initial factory settings.

SCENE	Input	Sound field program
BD/DVD	HDMI1	Straight
TV	AV4	Straight
CD	AV3	Straight
RADIO	TUNER	7ch Enhancer

### Registering input sources/sound field program

- 1 Use the [4] **Input selector** to select the input source you want to register.
- 2 Use the [7] **Sound selection keys** to select the sound field program you want to register.

- 3 Press the [8] **SCENE** key until “SET Complete” appears on the front panel display.



Release the key when “SET Complete” is displayed

When changing “SCENE,” also change the external component that the remote control operates ([p. 62](#)).

## Enjoying sound field programs

This unit is also equipped with a Yamaha digital sound field processing (DSP) chip. You can enjoy multi-channel playback for almost any sound source using various sound field programs stored on the chip, and a range of sound decoders.

### Selecting sound field programs and sound decoders

This unit offers sound field settings (sound field programs) in many different categories suitable for movies, music and other uses. Choose a sound field program that sounds best with the source you are playing back, rather than relying on the name or explanation of the program.

- Sound field programs are stored for each input source. When you change the input source, the sound field program previously selected for that input source is applied again.
- When you playback DTS Express sources or audio signals with sampling frequency of higher than 96 kHz, the straight decoding mode ([p. 30](#)) is automatically selected.
- When you playback DTS-HD sources with CINEMA DSP, the DTS decoder is automatically selected.

Continues to the next page





### Selects sound field program:

MOVIE category: Press **7**MOVIE repeatedly

MUSIC category: Press **7**MUSIC repeatedly

### Selects stereo reproduction:

Press **7**STEREO repeatedly

### Selects compressed music enhancer:

Press **7**STEREO repeatedly

### Selects surround decoder:

Press **7**SUR. DECODE repeatedly

### Switches Straight decoding mode:

Press **7**STRAIGHT

### Switches Direct mode (p. 31):

Press **7**DIRECT

#### Sound field program categories



Program

- You can use the speaker indicators on the front panel display to check what speakers are currently outputting sound (p. 7).
- You can adjust sound field elements (sound field parameters) for each of the programs.

## Enjoying unprocessed playback (Straight decoding mode)

Use straight decoding mode when you want to playback sound without sound field processing. You can playback as follows in straight decoding mode.

### 2-channel sources such as CD

Stereo sound plays through the front left and right speakers.

### Multi-channel playback sources such as BD/DVD

Plays back audio from a playback source without applying sound field effects, using an appropriate decoder to split the signal into multiple channels.

Press **7**STRAIGHT to enable the straight decoding mode.



To disable straight decoding mode, press

**7**STRAIGHT again.



Previously selected program

## Enjoying stereo playback

Select "2ch Stereo" from the surround field programs when you want to playback 2-channel stereo sound (from the front speakers only), regardless of the playback source.

Selecting "2ch Stereo" will playback as follows for the playback of CD and BD/DVD sources.

### 2-channel sources such as CD

Stereo sound plays back through the front speakers.

### Multi-channel sources such as BD/DVD

Playback channels other than the front channels in the playback source are mixed with the front channels and played back through the front speakers.

Press **7**STEREO repeatedly to select "2ch Stereo."



To disable stereo playback, press any of the **7**Sound selection keys to select a sound field program other than "2ch Stereo."



#### **7** Sound selection keys

**7** MOVIE

**7** MUSIC

**7** STEREO

**7** SUR. DECODE

**7** STRAIGHT

**7** DIRECT





7 DIRECT

## Enjoying sound field programs without surround sound speakers

This unit allows you to use virtual surround speakers to enjoy sound field surround effects, even without any surround speakers (Virtual CINEMA DSP mode). You can even enjoy surround sound presence with just a minimal configuration of the front speakers only.

This unit will switch to Virtual CINEMA DSP mode automatically when surround speakers are unavailable. 🌟1

## Enjoying sound field programs with headphones

Even when headphones are connected, you can enjoy the reproduction sound field presence with ease (SILENT CINEMA mode). 🌟2

## Enjoying Hi-Fi Sound Quality (Direct mode)

Use Direct mode to enjoy the pure high fidelity sound of the selected source. When direct mode is enabled, this unit plays back the selected source with the least circuitry. 🌟3

Press 7 DIRECT to turn direct mode on. 🌟4



To disable direct mode, press 7 DIRECT again.

🌟1 : However, Virtual CINEMA DSP mode is not available in the following conditions:

- When headphones are connected to this unit.
- When a “7ch Stereo” sound field program is selected.
- When direct mode or straight decoding mode is selected.

🌟2 : However, SILENT CINEMA mode is not available in the following conditions:

- When a “7ch Stereo” sound field program is selected.
- When direct mode or straight decoding mode is selected.

🌟3 : The following features are disabled in direct mode.

- sound field program, tone control
- display and operation of the Option menu and Setup menu







🌟4 : While direct mode is on, the front panel display screen becomes dim in order to reduce noise. When turning Direct mode off, the brightness of the screen returns to the previous setting.

## Sound field programs

 in the table indicates the sound field program for CINEMA DSP.

### Category: MOVIE

Sound field programs optimized for viewing video sources such as movies, TV programs, and games.

<b>Standard</b> 	This program creates a sound field emphasizing the surround feeling without disturbing the original acoustic positioning of multi-channel audio such as Dolby Digital and DTS. It has been designed with the concept of an ideal movie theater, in which the audience is surrounded by beautiful reverberations from the left, right and rear.
<b>Spectacle</b> 	This program represents the spectacular feeling of large-scale movie productions. It reproduces a broad theater sound field that matches cinemascope and wider-screen movies with an excellent dynamic range providing everything from very small sound effects to large, impressive sounds.
<b>Sci-Fi</b> 	This program clearly reproduces the finely elaborated sound design of the latest science fiction and special effects-featuring movies. You can enjoy a variety of cinematographically created virtual spaces reproduced with clear separation between dialog, sound effects and background music.
<b>Adventure</b> 	This program is ideal for precisely reproducing the sound design of action and adventure movies. The sound field restrains reverberations but puts emphasis on reproducing a powerful space expanded widely to the left and right. The reproduced depth is also restrained relatively to ensure the separation between audio channels and the clarity of the sound.
<b>Drama</b> 	This sound field features stable reverberations that match a wide range of movie genres from serious dramas to musicals and comedies. The reverberations are modest but offer an optimum 3D feeling, reproducing effects tones and background music softly but cubically around clear words and center positioning in a way that does not fatigue the listener even after long hours of viewing.
<b>Mono Movie</b> 	This program is provided for reproducing monaural video sources such as a classic movie in an atmosphere of a good old movie theater. The program produces the optimum expansion and reverberation to the original audio to create a comfortable space with a certain sound depth.
<b>Sports</b> 	This program allows the listeners to enjoy stereo sport broadcasts and studio variety programs with enriched live feeling. In sports broadcasts, the voices of the commentator and sportscaster are positioned clearly at the center while the atmosphere of the stadium expands in an optimal space to offer the listeners a feeling of presence in the stadium.

### Action Game



This sound field is suitable for action games such as car racing and FPS games. It uses reflection data that limits the effects range per channel in order to offer a powerful playing environment that makes the listener feel as if they are right there by enhancing various effects tones while maintaining a clear sense of directions.







### Roleplaying Game



This sound field is suitable for role-playing and adventure games. It combines the sound field effects for movies and the sound field designs for "Action Game" to represent the depth and 3D feeling of the field during play, while offering movie-like surround effects in the movie scenes in the game.

### Category: MUSIC

This sound field is suitable when listening to music sources such as CDs.

<b>Hall in Munich</b> 	This sound field simulates a concert hall with approximately 2500 seats in Munich, using stylish wood for the interior finishing as normal standards for European concert halls. Fine, beautiful reverberations spread richly, creating a calming atmosphere. The listener's virtual seat is at the center left of the arena.
<b>Hall in Vienna</b> 	This is an approximately 1700-seat, middle-sized concert hall with a shoebox shape that is traditional in Vienna. Pillars and ornate carvings create extremely complex reflections from all around the audience, producing a very full, rich sound.
<b>Chamber</b> 	This program creates a relatively wide space with a high ceiling like an audience hall in a palace. It offers pleasant reverberations that are suitable for courtly music and chamber music.
<b>Cellar Club</b> 	This program simulates a live house with a low ceiling and homey atmosphere. A realistic, live sound field features powerful sound as if the listener is in a row in front of a small stage.
<b>The Roxy Theatre</b> 	This is the sound field of a rock music live house in Los Angeles, with approximately 460 seats. The listener's virtual seat is at the center left of the hall.
<b>The Bottom Line</b> 	This is the sound field at stage front in The Bottom Line, a famous New York jazz club once. The floor can seat 300 people to the left and right in a sound field offering real and vibrant sound.
<b>Music Video</b> 	This sound field offers an image of a concert hall for live performance of pop, rock and jazz music. The listener can indulge oneself in a hot live space thanks to the presence sound field that emphasizes the vividness of vocals and solo play and the beat of rhythm instruments, and to the surround sound field that reproduces the space of a big live hall.





## Category: STEREO

Suitable for listening to stereo sources.

<b>2ch Stereo</b>	Use this program to mix down multi-channel sources to 2-channels. When multi-channel signals are input, they are down mixed to 2-channels and output from the front left and right speakers.
<b>7ch Stereo</b> 	Use this program to output sound from all speakers. When you playback multi-channel sources, this unit down-mixes the source to 2-channels, and then outputs the sound from all speakers. This program creates a larger sound field and is ideal for background music at parties, etc.

## Category: ENHNCR (Compressed music enhancer)

Suitable for listening to compressed audio, such as MP3.

<b>Straight Enhancer</b>	Use this program to restore the original depth and dynamics of 2-channel or multi-channel to compression audio.
<b>7ch Enhancer</b>	Use this program to playback compression artifacts in 7-channel stereo.

## Category: SUR.DEC (Surround decode mode)

Select this program to playback sources with selected decoders. You can playback 2-channel sound sources in up to 7-channels using a surround decoder.

<input type="checkbox"/> <b>Pro Logic</b>	Reproduces sound using the Dolby Pro Logic decoder. This is suitable for all kinds of sound sources.
<input type="checkbox"/> <b>PLIIx Movie /</b> <input type="checkbox"/> <b>PLII Movie</b>	Reproduces sound using the Dolby Pro Logic IIx (or Dolby Pro Logic II) decoder. This is suitable for movies. 🌟1
<input type="checkbox"/> <b>PLIIx Music /</b> <input type="checkbox"/> <b>PLII Music</b>	Reproduces sound using the Dolby Pro Logic IIx (or Dolby Pro Logic II) decoder. This is suitable for music. 🌟1
<input type="checkbox"/> <b>PLIIx Game /</b> <input type="checkbox"/> <b>PLII Game</b>	Reproduces sound using the Dolby Pro Logic IIx (or Dolby Pro Logic II) decoder. This is suitable for games. 🌟1
<b>Neo:6 Cinema</b>	Reproduces sound using the DTS Neo:6 decoder. This is suitable for movies.
<b>Neo:6 Music</b>	Reproduces sound using the DTS Neo:6 decoder. This is suitable for music.

- 🌟 1: You cannot select the Dolby Pro Logic IIx decoder in the following conditions:
- When the "Sur. B" setting in "Speaker Setup" of the Setup menu is set to "None."
  - When headphones are connected.

## FM/AM tuning



- 4 TUNER
- 5 FM
- 5 AM

When using the FM/AM tuner, adjust the direction of the FM/AM antenna connected to this unit to get the best reception.

### (Asia and General models only)

The factory pre-set FM/AM tuner frequency steps are 9 kHz for AM and 50 kHz for FM. Carry out the following settings and select the frequency steps suitable for your listening environment.

- 1 Switch this unit to the standby mode.
- 2 Press while pressing and holding STRAIGHT on the front panel.

Release the keys when “ADVANCED SETUP” is displayed on the front panel display. After approximately a few seconds, the top menu items are displayed. 1

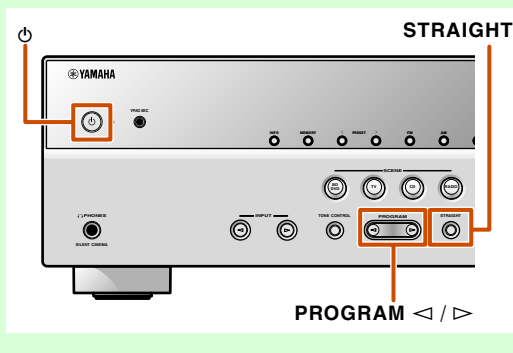

- 3 Press PROGRAM repeatedly to display “TU.”



- 4 Press STRAIGHT repeatedly to select a frequency steps.
- 5 Switch this unit to the standby mode, and then switch it on again.

The power turns on, with the settings you made configured.

The FM/AM tuner of this unit provides the following two modes for tuning.

### Normal tuning

You can tune in to a desired FM/AM station by searching or specifying its frequency.

### Preset tuning [\(p. 35\)](#)

You can preset the frequencies of FM/AM stations by registering them to specific numbers, and later just select those numbers to tune in.

FM/AM tuner frequencies will differ depending on the country or region where the unit is being used. This explanation uses a display with frequencies used in U.K. and Europe models.

## Selecting a frequency for reception (Normal tuning)

- 1 Press 4 TUNER to switch to the tuner input.
- 2 Press 5 FM or 5 AM to select a band to receive.



Continues to the next page

1: Refer to the “Extended functionality that can be configured as needed (Advanced Setup menu)” [\(p. 65\)](#) for details on the Advanced Setup menu.

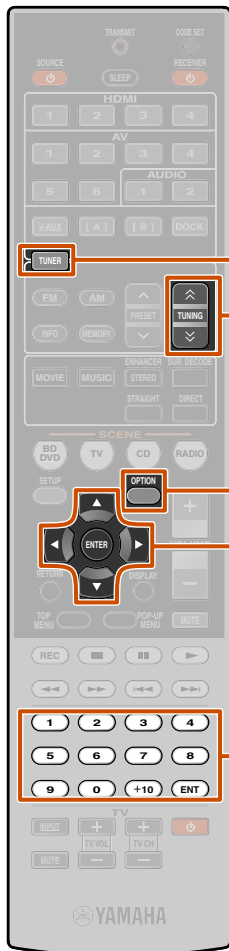

- 4 TUNER
- 5 TUNING  $\wedge / \vee$
- 10 Cursor  $\triangle / \nabla / \triangleleft / \triangleright$
- 10 ENTER
- 12 Numeric keys
- 17 OPTION

### 3 Use 5 TUNING $\wedge / \vee$ to set a frequency to receive.

#### 5 TUNING $\wedge$

Increases the frequency. Press and hold this key for longer than a second to search automatically for a station on a higher frequency than the current one. 1

#### 5 TUNING $\vee$

Decreases the frequency. Press and hold this key for longer than a second to search automatically for a station on a lower frequency than the current one. 1

Lights up when receiving a broadcast from a station

Lights up when receiving a stereo broadcast



### ■ Entering a frequency number

In normal tuning mode, use the 12 Numeric keys on the remote control to enter a frequency. Leave the decimal point out when entering a number. 2

For example, enter as follows to select a station on 98.50MHz.



### ■ When signal reception is poor

When you are receiving an FM broadcast and cannot obtain a stable stereo broadcast, you can force this unit to receive in a monaural mode.

#### 1 Press 4 TUNER to switch to the tuner input.

#### 2 Press 17 OPTION to display the Option menu. 3

#### 3 Use 10 Cursor $\triangle / \nabla$ to select "FM Mode."



#### 4 Press 10 ENTER and use 10 Cursor $\triangleleft / \triangleright$ to select "Mono."



#### 5 When setting is completed, press 17 OPTION to close the Option menu.

To return this unit to its original settings, use the same procedure and select "Stereo" in step 4.

## Registering and recalling a frequency (Preset tuning)

You can register up to 40 FM/AM stations as preset stations. There are two methods of presetting stations, "Auto Preset" and "Manual Preset." Use one of these methods to register stations.

### ■ Presetting FM stations automatically (Auto Preset)

The tuner detects FM stations with strong signals and registers up to 40 automatically.

AM stations cannot be automatically registered. Use manual station preset ([p. 36](#)).

#### 1 Press 4 TUNER to switch to the tuner input.

#### 2 Press 17 OPTION to display the Option menu. 3

#### 3 Use 10 Cursor $\triangle / \nabla$ to select "Auto Preset."



Continues to the next page

1 : When searching for a station, release the key once the search has started.

2 : "Wrong Station!" appears on the front panel display when you enter a frequency that is out of receivable range. Make sure that the frequency entered is correct.

3 : Refer to the "Configuring the settings specific for each input source (Option menu)" ([p. 44](#)) for details on the Option menu.

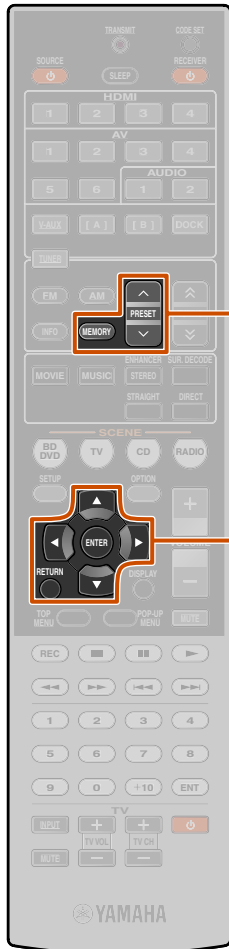

- 5 MEMORY
- 5 PRESET ^ / v
- 10 Cursor Δ / ▽
- 10 ENTER
- 10 RETURN

### 4 Press 10 ENTER, then press 5 PRESET ^ / v or 10 Cursor Δ / ▽ to choose the preset number from which to start the Auto Preset function.

Auto Preset will begin approximately 5 seconds after you select a preset number. If you do not select a preset number, Auto Preset will begin approximately 5 seconds after “READY” is displayed.

#### Selecting a preset number

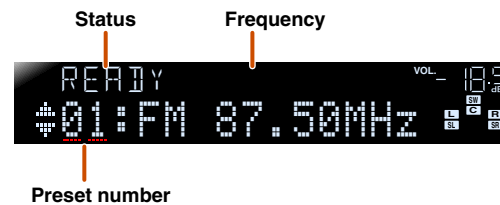

To cancel registration, press 10 RETURN.

#### During Auto Preset



#### When Auto Preset is complete



The Option menu closes automatically when presetting is complete. 💡1

💡1 : The preset with the lowest preset number will be selected automatically immediately after presetting.

### Registering stations manually (Manual Preset)

Set stations manually and register them as presets individually.

#### 1 Tune in to the station you want to register, referring to “Selecting a frequency for reception (Normal tuning)” (p. 34).

#### 2 Use one of the following methods to register the station you are currently receiving.

##### ■ Registering to a preset number to which no station is registered

Press 5 MEMORY for 3 seconds or longer. The station will be registered automatically to the lowest open preset number (or the next number after the one registered most recently).



##### ■ Designating a preset number for registration

Press 5 MEMORY once, to display “Manual Preset” on the front panel display. After a small wait, the preset number that the station has been registered to will appear.

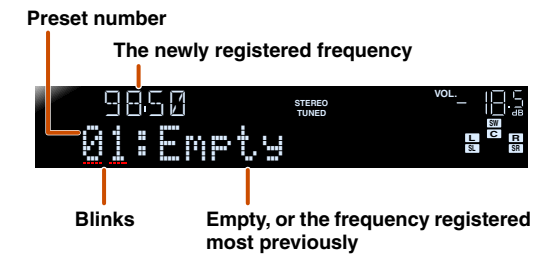

Press 5 PRESET ^ / v to select the preset to register the station to, and then press 5 MEMORY to register.

To cancel registration, press 10 RETURN or do not operate the remote control for about 30 seconds.

## Recalling a preset station

You can call preset stations registered by automatic station preset or manual station preset. 🌟1

To select a registered station, press **5** PRESET **^ / v** to select the preset number of the station. 🌟2

## Clearing preset stations

**1** Press **4** TUNER to switch to the tuner input.

**2** Press **17** OPTION to display the Option menu. 🌟3

**3** Use **10** Cursor **Δ / ▽** to display “Clear Preset” and press **10** ENTER.

The number of the preset to be cleared

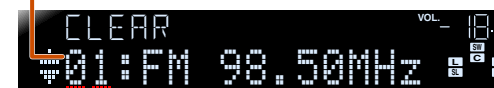

Blinks

Registered frequencies

Press **10** RETURN to cancel the operation.

**4** Use **10** Cursor **Δ / ▽** to select the preset number you want to clear, and press **10** ENTER to clear it.

Repeat this operation to clear the registration of multiple numbers.

**5** Press **17** OPTION to finish this operation.

## Radio Data System tuning (U.K. and Europe models only)

Radio Data System is a data transmission system used by FM stations in many countries. This unit can receive various Radio Data System data such as “Program Service,” “Program Type,” “Radio Text,” “Clock Time” when receiving Radio Data System broadcasting stations.

### ■ Displaying the Radio Data System information

You can display the 4 types of the Radio Data System information: “Program Service,” “Program Type,” “Radio Text,” “Clock Time.”

**1** Tune into the desired Radio Data System broadcasting station.

We recommend that you use the automatic preset tuning to tune into the Radio Data System broadcasting stations ([see p. 35](#)).

Continues to the next page

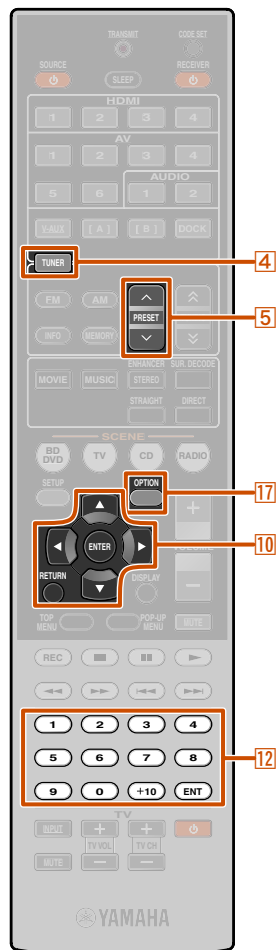

- 4** TUNER
- 5** PRESET **^ / v**
- 10** Cursor **Δ / ▽**
- 10** ENTER
- 10** RETURN
- 12** Numeric keys
- 17** OPTION

🌟1: Preset numbers to which no stations are registered will be skipped. “No Presets” is displayed when there are no stations are registered.

🌟2: To select a station by selecting a preset number, use the **12** Numeric keys to enter the preset number of the station you want to listen. When an invalid number is entered, “Wrong Num.” appears on the front panel display. Check that you have entered the correct number.

🌟3: Refer to the “Configuring the settings specific for each input source (Option menu)” ([see p. 44](#)) for details on the Option menu.

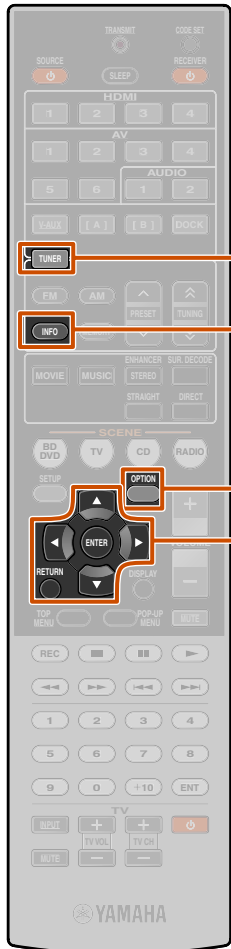

- 4 TUNER
- 6 INFO
- 10 Cursor  $\Delta / \nabla$
- 10 ENTER
- 10 RETURN
- 17 OPTION

## 2 Press **6**INFO repeatedly until the desired information is displayed.

Information on the display changes as you press the key. The kind of information is displayed for a while and then the information is displayed. 1

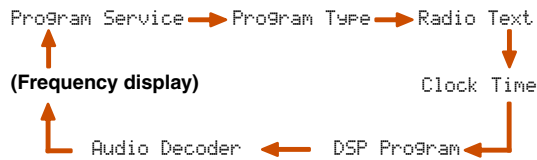

Contents of information are as follows.

Type of information	Description
Program Service	Displays the name of the Radio Data System program service currently being received.
Program Type	Displays the type of the Radio Data System program currently being received.
Radio Text	Displays the information on the Radio Data System program currently being received.
Clock Time	Displays the current time.
DSP Program	Displays the currently selected sound field program.
Audio Decoder	Displays the currently selected surround decoder.

## Front panel display (When “Program Type” selected)

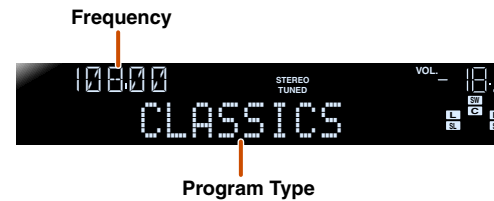

“Program Service,” “Program Type,” “Radio Text” and “Clock Type” do not appear when the radio station does not provide the Radio Data System service.

## Automatic traffic information reception (U.K. and Europe models only)

When the tuner is active, this unit can automatically search for and receive transmissions from traffic information broadcast stations. To start this function:

### 1 Press **4**TUNER to switch to the tuner input.

### 2 Press **17**OPTION to display the Option menu. 2



### 3 Use **10**Cursor $\Delta / \nabla$ to select “TrafficProgram.”



### 4 Press **10**ENTER to start the search function.



- The transmission search will begin in approximately 5 seconds. Or, when the status indicator reads “READY,” you can begin the search immediately by pressing **10**ENTER.
- By pressing **10**RETURN right before or during a search, it will return to the Option menu.
- When the status is “READY,” use **10**Cursor  $\Delta / \nabla$  to start a search in the specified direction.
  - 10**Cursor  $\Delta$ : Searches upward from the current frequency.
  - 10**Cursor  $\nabla$ : Searches downward from the current frequency.

When a traffic station is found, it will appear on the display and the Option menu will close.

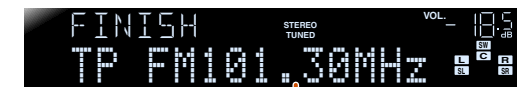

Traffic information broadcast station (Frequency)

If the receiver cannot find a traffic station, “TP Not Found” will appear on the display, and the Option menu will shortly close.

1: “PTY Wait,” “RT Wait,” or “CT Wait” may appear when Program Type, Radio Text, or Clock Time is displayed. That shows this unit is receiving data (or stopping receiving data). If the data is receivable, the corresponding information is displayed after a while.

2: Refer to the “Configuring the settings specific for each input source (Option menu)” ([p. 44](#)) for details on the Option menu.

## Playing back tunes from your iPod™/iPhone™

Once you have connected a Yamaha iPod universal dock (such as the YDS-12, sold separately) to this unit, you can enjoy playback of your iPod/iPhone using the remote control supplied with this unit. When playing back from an iPod/iPhone, you can also use the compressed music enhancer sound field programs ([see p. 33](#)) to give compressed audio formats such as MP3 a sharper, more dynamic sound.

- iPod touch, iPod (Click and Wheel including iPod classic), iPod nano, iPod mini, iPhone, iPhone 3G, and iPhone 3GS are supported (As of March 2010).
- When connecting an iPhone, please use a YDS-12.
- Some features may not be compatible depending on the model or the software version of your iPod.
- Some functions may not be available for some Yamaha iPod universal dock models. This explanation focuses on the YDS-12.

### Connecting the Yamaha iPod universal dock

Use the dedicated cable to connect the dock to the DOCK jack on the rear panel of this unit. Refer to the operating instructions of the iPod universal dock for information on how to connect your iPod/iPhone.

#### CAUTION

To prevent accidents, switch this unit to standby mode before connecting an iPod universal dock.

Switch this unit on and place your iPod/iPhone in the dock. The unit is now ready for playback.

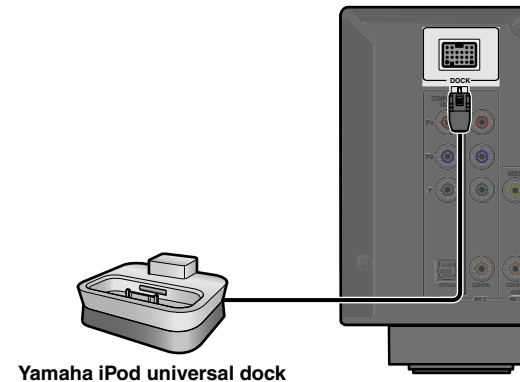

### Controlling an iPod™/iPhone™

After setting your iPod/iPhone in your dock, just press **4 DOCK** to switch to DOCK input to play your iPod/iPhone.

The iPod/iPhone can be operated in the following two ways.

#### Simple play mode:

Plays audio and video through this unit while viewing the menu displayed on the iPod/iPhone screen.

#### Menu browse mode:

Plays the iPod/iPhone while viewing the menu displayed on the front panel display.



**4 DOCK**

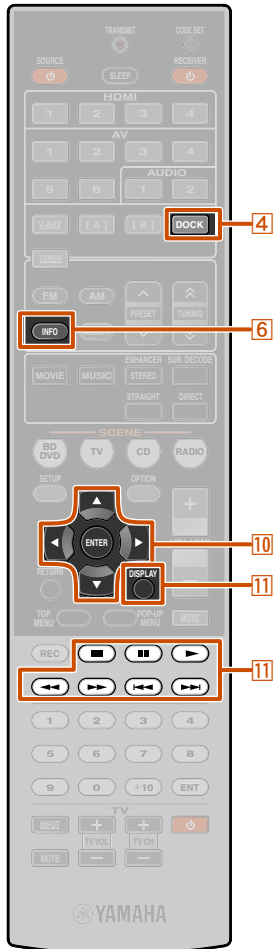

Use the following remote control keys to operate (playback, stop, skip, etc.) your iPod/iPhone. You can check song information on the iPod/iPhone screen. 1

<b>4 DOCK</b>	Switch to the DOCK (iPod) input.
<b>10 Cursor <math>\Delta / \nabla</math></b>	Move the cursor up and down to different fields.
<b>10 Cursor <math>\langle / \rangle</math></b>	Return to the previous menu or enter the menu you have selected.
<b>10 ENTER</b>	Enter the selected menu.
<b>11 DISPLAY</b>	Switches between simple play mode or menu browse mode.
<b>11 <math>\langle \langle</math></b>	Searches backwards while held down.
<b>11 <math>\rangle \rangle</math></b>	Searches forwards while held down.
<b>11 <math>\langle \langle \langle \langle</math></b>	Skip to the beginning of the currently playing song. Pressing repeatedly skips one song backwards with each press.
<b>11 <math>\rangle \rangle \rangle \rangle</math></b>	Skip to the beginning of the next song.
<b>11 <math>\square</math></b>	Stops playback.
<b>11 <math>\square \square</math></b>	Switches between playback and pause.
<b>11 <math>\triangleright</math></b>	Switches between playback and pause.

**1** Press **4 DOCK** to switch to the DOCK input.

**2** Press **11 DISPLAY** on the remote control to change between menu browse mode and simple remote mode, as required.

When you select menu browse mode, the front panel display changes as follows.

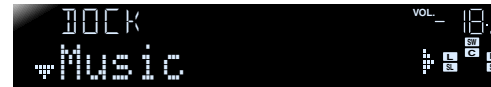

- Information on the iPod/iPhone can only be displayed in alphanumeric characters. “\_” (underscore) is displayed for characters that this unit cannot display.
- When displaying play information in menu browse mode, song information (Artist, Album, Song) is displayed on the front panel. Change the displayed information by pressing **6 INFO** repeatedly.
- (Except iPod touch and iPhone) In menu browse mode, the “Yamaha Mark” will be displayed on the iPod/iPhone screen. You cannot directly control your iPod/iPhone while this mark is displayed.

**3** Select iPod/iPhone menu items using **10 Cursor  $\Delta / \nabla / \langle / \rangle$** , and press **10 ENTER** to play.

- 4 DOCK**
- 6 INFO**
- 10 Cursor  $\Delta / \nabla / \langle / \rangle$**
- 10 ENTER**
- 11 DISPLAY**
- 11  $\square$**
- 11  $\square \square$**
- 11  $\triangleright$**
- 11  $\langle \langle$**
- 11  $\rangle \rangle$**
- 11  $\langle \langle \langle \langle$**
- 11  $\rangle \rangle \rangle \rangle$**

1 : Controls on the iPod/iPhone can also be operated in simple playback mode.





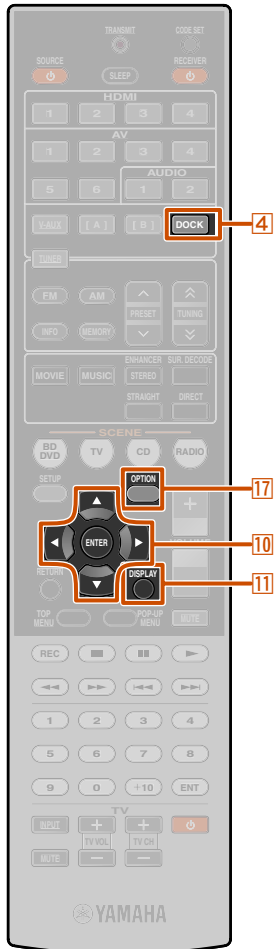

- 4** DOCK
- 10** Cursor  $\Delta / \nabla / \triangleleft / \triangleright$
- 10** ENTER
- 11** DISPLAY
- 17** OPTION

## Shuffle/Repeat playback

You can use special playback functions such as shuffle playback and repeat playback by first displaying the Option menu.

- 1** Press **4** DOCK to switch to the DOCK input.
- 2** Press **11** DISPLAY to switch to menu browse mode.
- 3** Press **17** OPTION to display the Option menu. 1
- 4** Press **10** Cursor  $\Delta / \nabla$  to select the desired playback function, “Shuffle” or “Repeat,” then press **10** ENTER.

### Shuffle

Plays back songs or albums in random order. When the shuffle function is enabled, “ $\text{ㄥ}$ ” appears on the TV screen.

Off	Does not play back songs or albums in random order.
Songs	Plays “Songs” back in random order.
Albums	Plays “Albums” back in random order.

### Repeat

Plays songs or albums repeatedly.

Off	Does not play back songs or albums repeatedly.
One	Plays a “Song” back repeatedly.
All	When all “Songs” have completed playback, returns to the start and repeats playback.

When the repeat function is enabled, “ $\text{ㄥ}$  (One)” or “ $\text{ㄥ}$  (All)” appears on the TV screen.

- 5** Press **10** Cursor  $\triangleleft / \triangleright$  to select the desired playback function.
- 6** To close the Option menu, press **17** OPTION.
- 7** Play the iPod/iPhone.  
Playback of the iPod/iPhone starts using the function selected in step 5.

To disable Shuffle/Repeat playback, redo the above steps, and return settings to “Off.”

### To charge the iPod/iPhone when this unit is in standby mode

If you connect an iPod/iPhone to the iPod universal dock the iPod/iPhone will always charge when this unit is turned on.

This unit can charge an iPod/iPhone even when in standby mode (iPod Standby Charge function). Check the HDMI Through/iPod Charge indicator on the front panel of this unit to check whether this unit is charging an iPod/iPhone during in standby mode. While charging an iPod/iPhone, the HDMI Through/iPod Charge indicator lights. When Standby Through function is off, the indicator goes out after the charging is complete.

If necessary, you can also disable the iPod Standby Charge function.

- 1** Press **4** DOCK to switch to the DOCK input.
- 2** Press **17** OPTION to display the Option menu.
- 3** Use **10** Cursor  $\Delta / \nabla$  to display “Standby Charge” and press **10** ENTER.



- 4** Use **10** Cursor  $\triangleleft / \triangleright$  to switch the setting to “Off.”



- 5** When setting is completed, press **17** OPTION to close the Option menu.

To enable the Standby Charge function again, carry out this procedure again and change the “Standby Charge” setting back to “Auto.”

1: Refer to the “Configuring the settings specific for each input source (Option menu)” ([esp. p. 44](#)) for details on the Option menu.

## Playing back tunes from Bluetooth™ components

You can connect a Yamaha Bluetooth wireless audio receiver (such as the YBA-10, sold separately) to this unit and enjoy wireless playback from Bluetooth-compatible portable music players. 🌟1

### NOTE

When playing back from a Bluetooth component for the first time, you must first pair the devices (register the Bluetooth components). When establishing a wireless connection you must carry out pairing on both this unit and on the Bluetooth component.

### Connecting a Yamaha Bluetooth wireless audio receiver

Use the dedicated cable to connect the dock to the DOCK jack on the rear panel of this unit.

The Bluetooth wireless audio receiver connection will be complete when this unit is turned on.

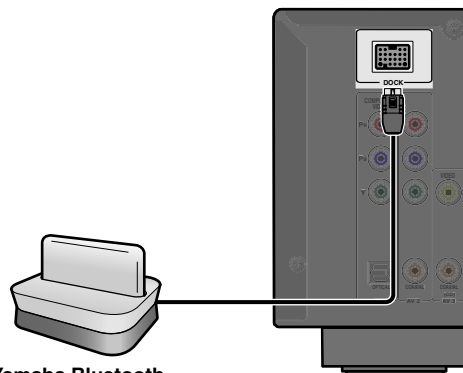

Yamaha Bluetooth wireless audio receiver

### Pairing Bluetooth™ components

Be sure to carry out pairing when connecting a Bluetooth component for the first time, or when settings have been deleted.

Refer to the operating instructions of your Bluetooth component as necessary when carrying out pairing.

The Yamaha Bluetooth wireless audio receiver can be paired with up to eight Bluetooth components. When the ninth device is paired, the pairing settings for the device which has not been used for the longest period of time will be deleted.

**1** Press **4** DOCK to switch to the DOCK input.

**2** Turn on the Bluetooth component you want to pair with and set it to pairing mode.

**3** Press **17** OPTION to display the Option menu and use **10** Cursor  $\Delta / \nabla$  to select "Pairing."



**4** Press **10** ENTER to start pairing.



- To cancel pairing, press **10** RETURN.
- You can also press and hold **5** MEMORY on the front panel to begin pairing.

**5** Make sure the Bluetooth component recognizes the Bluetooth wireless audio receiver.

When the device is recognized, it will appear in the Bluetooth component list, for example as "YBA-10 YAMAHA."

**6** Select the Bluetooth wireless audio receiver from the Bluetooth component list, and enter a pass key "0000" into the Bluetooth component. 🌟2

When pairing occurs correctly

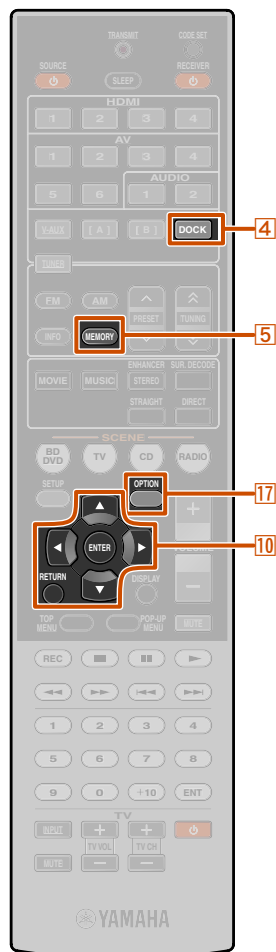

- 4** DOCK
- 5** MEMORY
- 10** Cursor  $\Delta / \nabla$
- 10** ENTER
- 10** RETURN
- 17** OPTION

### CAUTION

To prevent accidents, switch this unit to standby mode before connecting a Bluetooth wireless audio receiver.

🌟1 : This unit supports A2DP (Advanced Audio Distribution Profile) of the Bluetooth profile.

🌟2 : Depending on Bluetooth components, wireless connection is carried out right after the pairing. In this case, "BT connected" is displayed instead of "Completed."

## Using Bluetooth™ components

When pairing is complete, carry out the following procedure to achieve a wireless connection between this unit and the Bluetooth component. When the wireless connection is complete, you playback from Bluetooth components.

Depending on Bluetooth components, a wireless connection is established automatically or by operating the Bluetooth components. In that case, it is not necessary to carry out the following procedure.

**1** Press **[4] DOCK** to switch to the DOCK input.

**2** Press **[17] OPTION** to display the Option menu.

**3** Use **[10] Cursor**  $\Delta / \nabla$  to select “Connect” and press **[10] ENTER**.  **1**

When wireless connection is complete



“Not found” is displayed when there is an error connecting. Check that the following conditions have been satisfied, and try to establish a wireless connection again.

- Both this unit and the Bluetooth component are paired.
- The Bluetooth component is switched on.
- The Bluetooth component is within 10 meters/32 feet of the Bluetooth wireless audio receiver.

**4** Operate the Bluetooth component for playback.

To disconnect a wireless connection, repeat the same steps, and in step 3, select “Disconnect.”

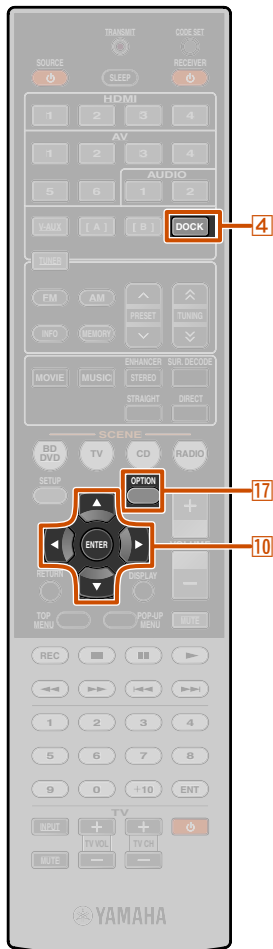

**[4] DOCK**

**[10] Cursor**  $\Delta / \nabla$

**[10] ENTER**

**[17] OPTION**

 **1**: “Disconnect” is displayed when a Bluetooth component has been connected.

# SETUP

## Configuring the settings specific for each input source (Option menu)

This receiver has a unique option menu specific for each type of input source, such as volume trim for compatible input sources, audio/video data display for signals from playback devices, and other frequently used menu items.

### Option menu display and setup

**1** Use the **[4]** Input selector on the remote control to select the Option menu you want to display.

**2** Press **[17]** OPTION.  
The Option menu appears for the desired input source.

Option menu



**3** Select the desired control/setup item using **[10]** Cursor  $\Delta / \nabla / \triangleleft / \triangleright$  and press **[10]** ENTER.

The displayed Option menu items differ depending on the input source.

For details, read the following Option menu items section.

**4** Select the desired menu item (or enable a function) using **[10]** Cursor  $\Delta / \nabla / \triangleleft / \triangleright$  and **[10]** ENTER.

Parameters of the selected item are displayed. The parameters you can set differ depending on the menu items.

- You can also use **[10]** RETURN to return to the previous screen or close the Option menu.
- Certain selected menu items may automatically close the Option menu when their functions are carried out.

**5** To close the Option menu, press **[17]** OPTION.

For a few seconds after closing the Option menu, the remote control keys may not function. If this occurs, reselect the input source.

### Option menu items

The following menu items are provided for each input source.

HDMI1-4	Volume Trim	Decoder Mode	EXTD Surround
	Audio In	Signal Info	
AV1-2	Volume Trim	Decoder Mode	EXTD Surround
	Audio In	Signal Info	
AV3-4	Volume Trim	Decoder Mode	EXTD Surround
	Signal Info		
AV5-6	Volume Trim		
AUDIO1-2	Volume Trim		
V-AUX	Volume Trim		
TUNER	Volume Trim	<a href="#">FM Mode</a>	<a href="#">Auto Preset</a>
		<a href="#">Clear Preset</a>	<a href="#">TrafficProgram</a> 🌱1
iPod (DOCK)	Volume Trim	<a href="#">Shuffle</a>	<a href="#">Repeat</a>
		<a href="#">Standby Charge</a>	
Bluetooth (DOCK)	Volume Trim	<a href="#">Connect/Disconnect</a>	<a href="#">Pairing</a>

- [4]** Input selector
- [10]** Cursor  $\Delta / \nabla / \triangleleft / \triangleright$
- [10]** ENTER
- [10]** RETURN
- [17]** OPTION

🌱1 : U.K. and Europe models only.

## Adjusting volume between input sources

### Volume Trim

**Input source:** All

Reduces any change in volume when switching between input sources by correcting volume differences in each input source. You can adjust this parameter for each input source.

<b>Adjustable range</b>	-6.0 dB to 0.0 dB to +6.0 dB
<b>Default setting</b>	0.0 dB
<b>Adjustment increments</b>	0.5 dB steps

## Setting the format of digital audio signals

### Decoder Mode

**Input source:** HDMI1-4, AV1-4 

Sets the format of digital audio to playback to DTS. For example, if the format is not automatically detected correctly even during playback of DTS format audio, this menu item can be used to set the playback format to DTS.

<b>Auto (Default)</b>	The audio format is automatically selected to match the format of the input audio.
DTS	Selects DTS signals only. Other input signals are not reproduced.

## Selecting the 5.1-channel signal playback method

### EXTD Surround

**Input source:** HDMI1-4, AV1-4 

Selects whether to reproduce 5.1-channel input signals in 6.1- or 7.1-channel when surround back speakers are used.

<b>Auto (Default)</b>	Automatically selects the most suitable decoder if a flag for reproducing surround back channel is present, and reproduces the signals in 6.1- or 7.1-channel.
<input checked="" type="checkbox"/> PLIIx Movie	Always reproduces signals in 7.1-channel using the Dolby Pro Logic Ix Movie decoder whether or not surround back channel signals are contained. You can select this parameter when two surround back speakers are connected.
<input checked="" type="checkbox"/> PLIIx Music	Always reproduces signals in 6.1- or 7.1-channel using the Dolby Pro Logic Ix Music decoder whether or not surround back channel signals are contained. You can select this parameter when one or two surround back speakers are connected.
EX/ES	Automatically selects the most suitable decoder for input signals whether or not the flag for reproducing surround back channel is present, and always reproduces signals in 6.1-channel.
Off	Always reproduces original channels whether or not the flag for reproducing surround back channel is present.

 1: AV5-6 or AUDIO1-2 are also available when the "Audio Return Channel" function is on, and the source is used for the TV audio input (TVAudio).

## Combining HDMI/AV1-2 input source video and audio

### Audio In

**Input source:** HDMI1-4, AV1-2

Combines video from HDMI or AV input sources with analog/digital audio inputs in situations such as:

- an playback device is connected with an HDMI cable but cannot transmit audio through HDMI
- an playback device with component video output and analog audio output (such as certain game consoles) are connected to the system

#### Inputs that change the audio source



#### Assignable audio input jacks

To change assignments, select an input source (HDMI1-4 or AV1-2) as the video input first, and then select audio input jacks in this menu.

Set as follows according on the desired combination of audio input jacks.

Audio inputs	Settings method
Optical digital audio input	Select AV1 or AV4. Connect the external component audio cable to the optical digital jack for the selected input.
Coaxial digital audio input	Select AV2 or AV3. Connect the external component audio cable to the coaxial digital jack for the selected input.
Analog audio input	Select one of AV5, AV6, AUDIO1, or AUDIO2. Connect the external component audio cable to the audio jack for the selected input.

- For details of settings, refer to “Receiving video signals from the HDMI jack and audio signals from a jack other than HDMI” (p. 17) and “Component connections to analog audio output devices” (p. 18).
- To return audio inputs to their previous settings, display this item again, and select the original input jack.

## Displaying information on audio/video signals

### Signal Info

**Input source:** HDMI1-4, AV1-4

Displays information on digital audio and video signals on the TV screen.

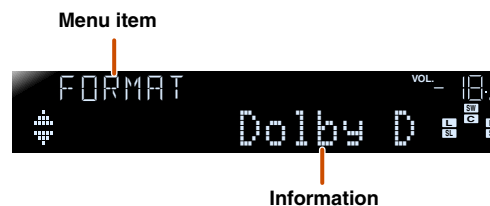

## Audio information

FORMAT	Format of audio signals.
CHAN	The number of input signal channels (front/surround/LFE). For example, if input signal channels are 3 front channels, 2 surrounds and LFE, “3/2/0.1” is displayed. If a channel that cannot be expressed as the above, a total number of channels such as “5.1ch” may be displayed.
SAMPL	The sampling frequency of analog-to-digital conversion.
RATE	The bit rate of input signal per second.

## Video information

V IN	Format and resolution of video input signal.
V OUT	Format and resolution of video output signal.
V MSG (appears only when an error has occurred)	Error messages about HDMI signals and components. <b>Error message</b> HDCP Error    HDCP authentication failed. Device Over    The number of connected HDMI components is over the limit.

- “No Signal” is displayed when no signals are being received, and “---” is displayed if this unit cannot recognize the incoming signal.
- The bit rate may vary during playback.

1: AV5-6 or AUDIO1-2 are also available when the “Audio Return Channel” function is on, and the source is used for the TV audio input (TVAudio).

## ■ Changing FM mode (Stereo/Monaural)

### FM Mode

**Input source:** TUNER

Sets this unit to automatically match FM broadcast frequencies in stereo, or to convert the frequency to monaural ([p. 35](#)).

## ■ Automatically presetting FM radio stations

### Auto Preset

**Input source:** TUNER

Automatically detects radio stations in the FM frequency and registers them as preset stations ([p. 35](#)).

## ■ Clearing preset FM stations

### Clear Preset

**Input source:** TUNER

Clears the preset stations ([p. 37](#)).

## ■ Searching for traffic information (U.K. and Europe models only)

### TrafficProgram

**Input source:** TUNER

Automatically searches for traffic information with the Radio Data System ([p. 38](#)).

## ■ Charging an iPod™/iPhone™ in standby mode

### Standby Charge

**Input source:** DOCK (iPod)

Charges an iPod/iPhone stationed in the iPod universal dock while the receiver is in standby mode ([p. 41](#)).

## ■ Shuffle playback with iPod/iPhone

### Shuffle

**Input source:** DOCK (iPod)

Changes the shuffle playback style on iPod ([p. 41](#)).

## ■ Repeat playback with iPod/iPhone

### Repeat

**Input source:** DOCK (iPod)

Changes the repeat playback style on iPod ([p. 41](#)).

## ■ Connect / Disconnect Bluetooth component

### Connect

### Disconnect

**Input source:** DOCK (Bluetooth)

Switches communication with a Bluetooth component on and off ([p. 43](#)).

## ■ Pairing Bluetooth component

### Pairing

**Input source:** DOCK (Bluetooth)

Performs pairing of this unit and a Bluetooth component ([p. 42](#)).

## Setting various functions (Setup menu)

You can configure various function settings of this unit using the Setup menu.

### Setup menu display and settings

**1** Press **[9] SETUP** on the remote control.



#### Setup menu categories

Speaker Setup	Set parameters for speakers, such as speaker status, and volume adjustment for each speaker.
Sound Setup	Set functions related to audio output, such as adjustment of maximum volume and of dynamic range.
HDMI Setup	Set functions related to HDMI, such as HDMI Control functions.
Func. Setup	Sets functions such as changing input names and auto power down that make the unit easier to use.
DSP Parameter	Edit sound field programs.
Memory Guard	Protects settings against accidental alteration.

**2** Use the **[10] Cursor Δ / ▽** to select the desired menu and press **[10] ENTER**.



Ex: Sound Setup menu

**3** Use **[10] Cursor Δ / ▽** to navigate the submenus to find the desired setting and press **[10] ENTER**.



**4** When multiple menu item is displayed, use **[10] Cursor Δ / ▽** to select the desired item.

**5** Use **[10] Cursor < / >** to change the setting. You can return to the previous screen by pressing **[10] RETURN**. You can change other items by repeating step 4 and 5.

**6** Press **[9] SETUP** to exit the Setup menu.

For a few seconds after closing the Setup menu, the remote control keys may not function. If this occurs, reselect the input source.

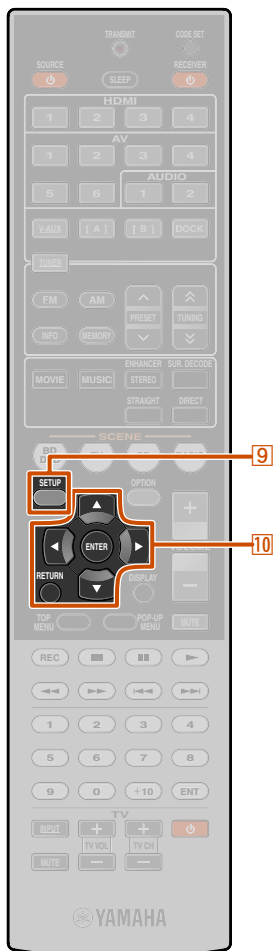

- [9] SETUP**
- [10] Cursor Δ / ▽ / < / >**
- [10] ENTER**
- [10] RETURN**



## Setup menu items

### Setup menu

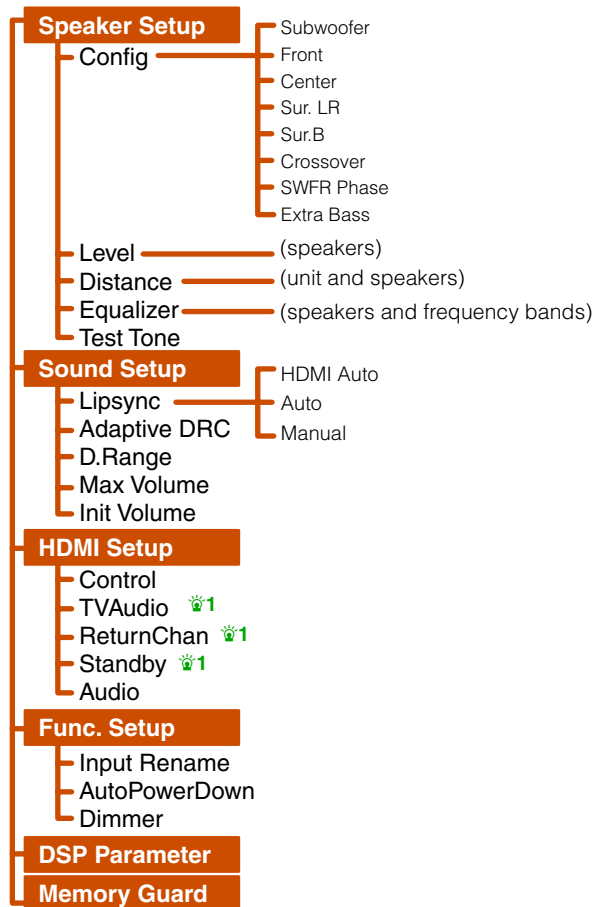

## Manages settings for speakers



### Speaker Setup submenu

Config	Manually manages speaker configuration, such as speaker size (sound production capacity), and bass audio processing.
Level	Manually adjusts the volume of each speaker.
Distance	Manually adjusts the output of each speaker based on distance to the listening point.
Equalizer	Selects an equalizer to adjust speaker output characteristics.
Test Tone	Generates test tones.

## Manual speaker setup

### Config

Adjusts the output characteristics of the speakers based on manually set parameters.

In the Config submenu, you can select the speaker size characteristic (Large or Small). Select the size (sound reproduction capacity) that matches your speakers.

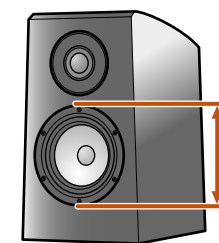

**Woofer diameter**

- 16 cm or larger → Large
- 16 cm or smaller → Small

When speaker size is set to “Small,” low-frequency components of the speakers that you configured are produced from the subwoofer (or from the front speakers if there is no subwoofer).

### Subwoofer

Confirms the subwoofer.

YES (Default)	Select this when you have a subwoofer connected. During playback, the subwoofer will produce audio from the LFE (low-frequency effect) channel and bass audio from other channels. 
NONE	Select this when you do not have a subwoofer connected. The front speakers will produce audio from the LFE (low-frequency effect) channel and bass frequency audio from other channels.

 1 : This menu item appears depending on the “Control” setting.

 2 : Enabling the “Extra Bass” setting allows both the subwoofer and the front speakers to produce bass audio.

### Front

Selects the size (sound reproduction capacity) of the front speakers. 🌱1

Small (Default)	Select this for small speakers. The subwoofer will produce front channel low-frequency components. 🌱2
Large	Select this for large speakers. The front speakers will produce all of the front channel frequency components.

### Center

Selects the size of the center speakers.

None	Select this when there is no center speaker. The front speakers will produce center channel audio.
Small (Default)	Select this when a small center speaker is connected.
Large	Select this when a large center speaker is connected.

### Sur. LR

Selects the size of the surround speakers.

None	Select this when no surround speakers are connected. The front speakers will produce surround channel audio signals.
Small (Default)	Select this when the surround speakers are small.
Large	Select this when the surround speakers are large.

- When set to “None,” no sound is produced from the surround back speaker even if that speaker is connected.
- When set to “None,” the sound field programs will change to Virtual CINEMA DSP mode.

### Sur. B

Selects the size of the surround back speakers.

None (Default)	Select this when no surround back speakers are connected.
SMLx1	Select when one small surround back speaker is connected.
SMLx2	Select when two small surround back speakers are connected.
LRGx1	Select when one large surround back speaker is connected.
LRGx2	Select when two large surround back speakers are connected.

- When there are no surround speakers are inactive, the setting will automatically change to “None.”
- You can set surround back audio signals, including from the playback source, to be mixed down and produced from a single speaker (6.1-channel layout) or produced from left and right surround back speakers (5.1-channel layout).

### Crossover

Sets the lower limit of low-frequency component output from speakers set to “Small.”

Audio with a frequency below that limit will be produced from the subwoofer or the front speakers. 🌱3

40Hz	110Hz
60Hz	120Hz
80Hz (Default)	160Hz
90Hz	200Hz
100Hz	

### SWFR Phase

Sets the phase of the subwoofer if the bass audio is lacking or unclear.

NRM (Default)	Does not change the subwoofer phase.
REV	Reverses the subwoofer phase.

### Extra Bass

Allows the front channel low-frequency components to be produced exclusively by the subwoofer, or by both the subwoofer and the front speakers.

ON	The subwoofer and the front speakers produce the front channel low-frequency components.
OFF (Default)	Depending on the size of the front speakers, either the front speakers or the subwoofer produce the front channel low-frequency components.

When the “Subwoofer” is set to “None,” the “Extra Bass” setting is disabled.

🌱1: When “Subwoofer” is set to “None,” you can only choose “Large.” If the front speaker setting is “Small” and you change “Subwoofer” to “None,” it will automatically change to “Large.”

🌱2: You can set the low-frequency components of audio signals transmitted from the front speakers to the subwoofer by using “Crossover” setting.

🌱3: If your subwoofer has a volume control or a crossover frequency control, set the crossover frequency to maximum and the volume to half (or slightly less).

### Controlling the volume of each speaker

#### Level

Separately adjusts the volume of each speaker. Use **[10]Cursor**  $\Delta$  /  $\nabla$  to select the desired speaker and adjust the volume with **[10]Cursor**  $\triangleleft$  /  $\triangleright$ .

FL	Front speaker L
FR	Front speaker R
C	Center speaker
SL	Surround speaker L
SR	Surround speaker R
SBL	Surround back L
SBR	Surround back R
SB 	Surround back
SWFR	Subwoofer

<b>Adjustable range</b>	-10.0 dB to +10.0 dB
<b>Default setting</b>	0 dB (FL/FR/SWFR) -1.0 dB (C/SL/SR/SBL/SBR/SB)
<b>Adjustment increments</b>	0.5 dB

### Manually setting speaker distance

#### Distance

Adjusts the timing at which the speakers produce audio so that sounds from the speakers reach the listening position at the same time.

#### Selecting adjustment units

Use **[10]Cursor**  $\Delta$  /  $\nabla$  to display “Unit,” and then use **[10]Cursor**  $\triangleleft$  /  $\triangleright$  to choose the units of length (meters or feet).

#### Setting distances for each speaker

Use **[10]Cursor**  $\Delta$  /  $\nabla$  to display the speaker you want to configure, and then use **[10]Cursor**  $\triangleleft$  /  $\triangleright$  to set the distance from the speaker to your listening position.

Unit	Selects the distance unit (meters or feet).
Front L	Front speaker L
Front R	Front speaker R
Center	Center speaker
Sur. L	Surround speaker L
Sur. R	Surround speaker R
Sur. B L	Surround back speaker L
Sur. B R	Surround back speaker R
Sur. B 	Surround back speaker
SWFR	Subwoofer

<b>Adjustable range</b>	0.30 m to 24.0 m (1.0 ft to 80.0 ft)
<b>Default setting</b>	3.00 m (10.0 ft) (Front L/Front R/SWFR) 2.60 m (8.5 ft) (Center) 2.40 m (8.0 ft) (Sur. L/Sur. R/Sur.B L/Sur.B R/Sur.B)
<b>Adjustment increments</b>	0.10 m (0.5 ft)

### Adjusting sound quality with the equalizer

#### Equalizer

Adjusts sound quality of tone using a parametric or graphic equalizer.

#### EQ Select

Select an equalizer type.

PEQ	Uses the parametric equalizer to adjust sound quality. Selecting this setting applies the tone settings obtained using YPAO (see p. 23). 
GEQ (Default)	Uses the graphic equalizer to adjust sound quality. By pressing <b>[10]ENTER</b> , you can adjust the characteristics of the graphic equalizer.
Off	Disables the equalizer.

 1: “SB” and “Sur.B” is displayed when using a 6.1 channel configuration only.

 2: Using YPAO to carry out acoustic measurement selects “PEQ” automatically. “PEQ” does not appear if the measurement process has not been carried out at least once.

## ■ Adjusting the graphic equalizer

**1** When “EQ Select” is displayed, use **[10]Cursor </>** to select “GEQ” and press **[10]ENTER**.

**2** Check that “Channel” selects and use **[10]Cursor </>** to select the speaker for which you want to adjust the equalizer.



The speaker you are adjusting

**3** Press **[10]Cursor ▾** repeatedly to select the frequency you want to adjust, then use **[10]Cursor </>** to adjust the volume.

Raising volume: Press **[10]Cursor ▷**.

Lowering volume: Press **[10]Cursor ◁**.



Frequency band

Setting the volume level for the selected frequency

Frequency range	63 Hz/160 Hz/400 Hz/1 kHz/2.5 kHz/6.3 kHz/16 kHz
Adjustable range	-6.0 dB to 0 dB to +6.0 dB
Default setting	0 dB
Adjustment increments	0.5 dB

You can use **[10]Cursor ▲ / ▽** to select another frequency or return to step 2. Repeat steps 2-3 to adjust the tone to your liking.

**4** When you have finished making adjustments, press **[9]SETUP** to close the Setup menu.

## ■ Generating test tones

### Test Tone

Turns the test tone generator on or off.

Off (Default)	Does not generate test tones.
On	Generates test tones. While “On” is selected, test tones are produced constantly.

You can use the test tone in a variety of circumstances. For example, you can adjust the volume balance settings for each speaker, or whenever you adjust the settings on the internal graphic equalizer, you can listen to the actual effect while operating this unit. Turn the test tone off when you have finished making adjustments.

## Setting the audio output function of this unit



### Sound Setup submenu

Lipsync	Adjusts the delay between video and audio output.
Adaptive DRC	Auto-adjusting the sound level to make even low volumes more audible.
D.Range	Selects the dynamic range adjustment method for Dolby Digital and DTS playback.
Max Volume	Sets the maximum volume for this receiver.
Init Volume	Sets the initial volume for when this receiver is turned on.

## Synchronizing audio/video output

### Lipsync

Adjusts the delay between audio and video output (Lipsync function).

### HDMI Auto

When connecting to a TV via HDMI, automatically adjusts output timing if the TV supports an automatic lipsync function.

Off (Default)	Select this when the connected monitor does not support the automatic lipsync function or you do not want to use the automatic lipsync function. Set the correction time in "Manual."
On	Select this when the monitor supports the automatic lipsync function. Fine-adjust the correction time in "Auto."

### Auto

Fine-adjust the audio output timing by entering the correction time provided when "HDMI Auto" is set to "On."

Adjustable range	0 ms to 240 ms
Adjustment increments	1 ms

### Manual

Manually adjusts the correction time. Select this when the monitor does not support the automatic lipsync function or "HDMI Auto" is set to "Off."

Adjustable range	0 ms to 240 ms
Adjustment increments	1 ms
Default setting	0 ms

## Auto-adjusting the sound level to make even low volumes more audible

### Adaptive DRC

Adjusts the dynamic range in conjunction with the volume level (from minimum to maximum). When you play audio at night or at low volumes, it is a good idea to set parameter to "Auto." 1

Auto	Adjusts the dynamic range automatically.
Off (Default)	Does not adjust the dynamic range automatically.

When the "Auto" is selected, it adjusts the dynamic range as follows.

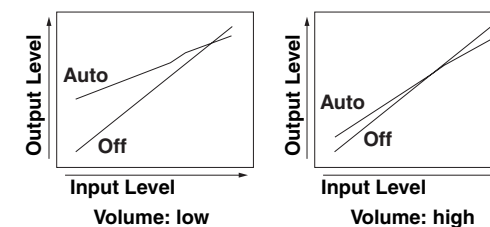

1: The Adaptive DRC setting is also effective when you use headphones.

## Auto-adjusting Dolby Digital and DTS dynamic range

### D. Range

Selects the dynamic range adjustment method for audio bitstream (Dolby Digital and DTS) signal playback.

Min/Auto	(Min) Sets the dynamic range suitable for low volume or a quiet environment, such as at night, for bitstream signals except for Dolby TrueHD signals. (Auto) Adjusts the dynamic range for Dolby TrueHD signals based on input signal information.
STD	Adjusts the dynamic range for optimum volume for regular home use.
Max (Default)	Produces audio without adjusting the dynamic range.

## Setting the maximum volume

### Max Volume

Sets a maximum volume level so that the audio is not played too loudly. The default setting of +16.5 dB produces the highest volume.

Adjustable range	-30.0 dB to +15.0 dB / +16.5 dB (Maximum volume)
Default setting	+16.5 dB
Adjustment increments	5.0 dB

## Setting the startup volume

### Init Volume



Sets the initial volume for when this receiver is turned on. When this parameter is set to “Off,” the volume is set at the level when the receiver last entered standby mode.  1

Adjustable range	Off, Mute, -80 dB to +16.5 dB
Default setting	Off
Adjustment increments	0.5 dB

## Setting HDMI functions



### HDMI Setup submenu

Control	Turns the HDMI Control on or off.
TVAudio  2	Chooses automatically selected audio input in conjunction with TV operation when the HDMI Control is turned on.
ReturnChan  2	Transmits audio/video output to the TV and audio input from the TV through a single HDMI cable.
Standby  2	Selects whether HDMI audio/video signals will be continue to be produced when this unit is on standby.
Audio	Selects the audio output device connected to this unit via HDMI jacks.

 1 : When you set the “Max Volume” at a lower level than “Init Volume,” the “Max Volume” setting has priority.

 2 : This menu item appears depending on the “Control” setting.

## Receiver operation via TV (HDMI Control)

### Control

Set the HDMI Control function to “On” to operate devices connected via HDMI. If the TV or other external components support HDMI Control (ex. Panasonic VIERA Link), you can use the remote controls of those devices to operate some of this unit’s functions, and to synchronize this unit with the operation of those devices.

Please refer to “Switching the input source on this unit automatically when listening to TV audio” (p. 68) for instructions.

Off (Default)	Sets HDMI Control to “Off.”
On	Sets HDMI Control to “On.” 

If this unit is connected to HDMI devices that do not support the HDMI Control function, these functions will not operate.

## Selecting an input source to assign audio input for the TV

### TVAudio

Select the input source that matches operations carried out on the TV while the HDMI Control function is on.

When using a TV that supports Audio Return Channel function and the function is enabled, the audio input for the TV is assigned to the input source selected here. 

AV1 to AV6	Assigns any of the AV1-6 input source for the audio input from the TV.
AUDIO1/AUDIO2	Assigns AUDIO1 or AUDIO2 input source for the audio input from the TV.

Default setting	AV4
-----------------	-----

- “TVAudio” is only displayed with the HDMI Control function (Control) is set to “On.”
- Please refer to “Using the HDMI Control function” (p. 67) for setting instructions.

## Listening to TV audio via single HDMI cable (Audio Return Channel)

### ReturnChan

You can enable or disable the Audio Return Channel function. When using a TV that supports Audio Return Channel function and the function is enabled, the TV’s audio output is transmit to this unit via an HDMI cable.

The TV audio input to this unit is regarded as the input source selected in “TVAudio.” 

By means of this function, you do not need to connect the TV’s audio output (digital audio output or analog audio output) to the unit.

Off (Default)	Sets the Audio Return Channel to “Off.”
On	Sets the Audio Return Channel to “On.”

When the TV audio is input to the unit using Audio Return Channel, “TV” is displayed on the front panel display.



- “ReturnChan” is only displayed with the HDMI Control function (Control) is set to “On.”
- Please refer to “Single HDMI cable input to TV audio with Audio Return Channel function” (p. 69) for setting instructions.

## Transmitting HDMI audio/video to the TV during standby mode (Standby Through)

### Standby

This function allows audio/video signals to continue to be transmitted to a TV connected to HDMI jacks 1-4 even when this unit is in standby mode.

Off (Default)	Sets Standby Through to “Off.”
On	Transmits audio/video signals from the selected HDMI input source to the TV.

- When HDMI Control is “On,” Standby Through function is automatically enabled and “Standby” is not displayed.
- When the Standby Through function is “On,” audio/video signals will continue to be transmitted to the TV from the selected HDMI input source when this unit is in standby mode. You can change the HDMI input source to transmit signals during the standby mode by using **HDMI1-4** on the remote control. When the input source is changed, the HDMI Through/iPod Charge indicator on the front panel blinks twice.
- When the Standby Through function is on, the HDMI Through/iPod Charge indicator on the front panel lights during the standby mode. When this indicator is lit, this unit consumes 1 to 3 W of power.

 1: When the HDMI Control is “On,” the Standby Through function is automatically enabled. When this unit enters standby mode, the audio and video signals from the last-selected HDMI input source will continue to be transmitted to the TV.

 2: While the Audio Return Channel function is on, the jack selected for the input source cannot be used.

## ■ Changing the output destination of HDMI input audio signals

### Audio

Choose whether to playback audio from an external component such as a BD/DVD player connected via HDMI through this unit or through a TV.

AMP (Default)	Outputs audio through this unit only. When this setting is selected, the external component outputs an audio format compatible with this unit.
TV	Outputs audio through a TV only. When this setting is selected, the external component outputs an audio format compatible with the TV.  1
AMP+TV	Outputs audio from the TV and this unit. When this setting is selected, the external component outputs an audio format compatible with this unit and TV.

“Audio” is only displayed with the HDMI Control function (Control) is set to “Off.”

 1 : When “TV” is selected, the speakers of this unit do not output sound.



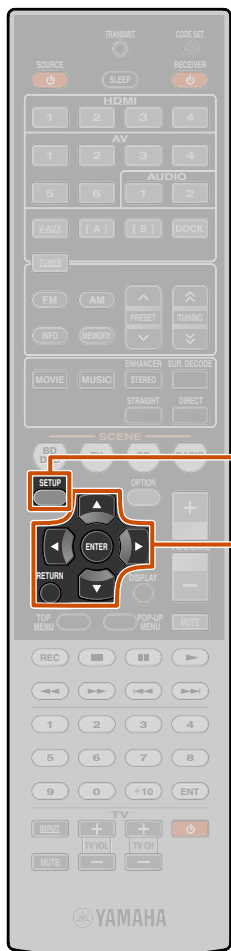

- 9 SETUP
- 10 Cursor  $\Delta / \nabla / \triangleleft / \triangleright$
- 10 ENTER
- 10 RETURN

## Making the receiver easier to use



### Func. Setup submenu

Input Rename	Changes the input source names.
AutoPowerDown	Goes enter standby mode if you leave it without operating.
Dimmer	Sets the brightness of the front panel display.

## Changing input source names

### Input Rename

Changes the input source names to be displayed on the front panel display.

You can change an input source name by choosing from a list of templates, or make one of your own.

### ■ Selecting a template

- 1 Select "Input Rename" from the Setup menu and press **10**ENTER.



Renaming the input source

- 2 Select the input source that you want to rename using **10**Cursor  $\Delta / \nabla$ .

- 3 Use **10**Cursor  $\triangleleft / \triangleright$  to select a new name from the following templates.

Blu-ray	Satellite
DVD	VCR
SetTopBox	Tape
Game	MD
TV	PC
DVR	iPod
CD	HD DVD
CD-R	(blank)

- 4 Confirm the new display name by pressing **10**RETURN. Press **9**SETUP to exit the Setup menu.

To cancel a name change, select the original name and then press **10**RETURN to exit renaming.

### ■ Entering an original name

- 1 Select "Input Rename" from the Setup menu and press **10**ENTER.



Renaming the input source

- 2 Select the input source that you want to rename using **10**Cursor  $\Delta / \nabla$ .

- 3 Press **10**ENTER.



Cursor

- 4 Use **10**Cursor  $\Delta / \nabla$  to select the characters you want to change, and use **10**Cursor  $\triangleleft / \triangleright$  to enter those characters.

The following characters are available for input source.

- A to Z, a to z
- 0 to 9
- Symbols (#, \*, -, +, etc.)
- Space

- 5 Repeat step 4 until you have entered the new input source name.

- 6 Confirm the new display name by pressing **10**ENTER. Press **9**SETUP to exit the Setup menu.

To cancel a name change, press **10**RETURN.

## ■ Goes enter standby mode automatically when you leave it without operating

### AutoPowerDown

If you do not operate this unit or use the remote control for an extended period of time, it will automatically go into standby mode (Auto Power Down function). This function's default setting is "Off." When you want to enable this function, set the amount of time to pass before this unit will enter standby.

Off (Default)	Auto Power Down function is disabled.
4hours	Goes into standby mode, when you have not operated this unit for four hours.
8hours	Goes into standby mode, when you have not operated this unit for eight hours.
12hours	Goes into standby mode, when you have not operated this unit for twelve hours.

This unit starts a countdown of 30 seconds before entering the standby mode. Pressing any key of the remote control during the countdown cancels entering the standby mode and reset the timer.

## ■ Setting the brightness of the front panel display

### Dimmer

Sets the brightness of the front panel display. Lowering the setting dims the display.

Adjustable range	-4 to 0
Default setting	0

## Setting the sound field program

You can set the parameters for the sound field programs ([p. 59](#)).



## Prohibiting setting changes



Prohibits setting changes to prevent careless changes being made to the settings on Setup menu.

Off (Default)	Settings are not protected.
On	Prohibits changes to the settings on Setup menu until it is returned to "Off." While set to "On," the unit displays "Memory Guard!" when an attempt is made to change the settings.

## Setting sound field program parameters

Although the sound field programs would satisfy you as they are with the default parameters, you can arrange the effect by setting the sound field elements (parameters). To adjust the sound effects suitable for acoustical conditions of audio/video sources or rooms, perform the following operations.

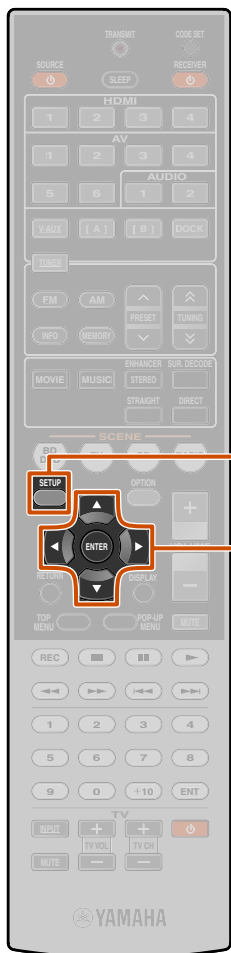

- 9 SETUP
- 10 Cursor  $\Delta$  /  $\nabla$  /  $\triangleleft$  /  $\triangleright$
- 10 ENTER

**1** Press **9** **SETUP** to display the Setup menu.

**2** Use **10** **Cursor**  $\Delta$  /  $\nabla$  to select “DSP Parameter” and press **10** **ENTER**.



**3** Use **10** **Cursor**  $\triangleleft$  /  $\triangleright$  to choose the sound field program you want to edit.



Sound field program to be edited

**4** Press **10** **Cursor**  $\Delta$  /  $\nabla$  to select the parameter that you want to change, and press **10** **Cursor**  $\triangleleft$  /  $\triangleright$  to change the parameter.



Sound field parameter      Choices

When there are multiple parameters in the sound field program you are configuring, repeat step 4 as necessary to change other parameters.

**5** Once you have completed editing, press **9** **SETUP** to close the Setup menu.

**■ To initialize the sound field parameters**  
 To set the parameters of the sound field program back to default, press **10** **Cursor**  $\nabla$  repeatedly during editing to select “Initialize” and press **10** **Cursor**  $\triangleright$ . When following message is displayed, press **10** **Cursor**  $\triangleright$  again to initialize.



To cancel operations, press **10** **Cursor**  $\triangleleft$  when “Press Again” appears and return to the original display.

### CINEMA DSP parameters

<Dolby PLIIx Movie>

<Neo:6 Cinema>

Selects a surround decoder to be used with a sound field program in the MOVIE category. 🧠1

Dolby PLIIx Movie (Dolby PLII Movie)	Selects the Dolby Pro Logic IIx Movie (or Dolby Pro Logic II Movie) decoder.
Neo:6 Cinema	Selects the Neo:6 (Cinema) decoder.

DSP Level

Change the effect level (level of the sound field effect to be added). You can adjust the level of the sound field effect while checking the sound effect.

Adjustable range	-6 dB to 0 dB to +3 dB
Default setting	0 dB

Adjust “DSP Level” as follows:

- The effect sound is too soft.  
→ Increase the effect level.
- There are no differences between effects of the sound field programs.  
→ Increase the effect level.
- The sound is dull.  
→ Reduce the effect level.
- The sound field effect is added too much.  
→ Reduce the effect level.

### Parameters usable in certain sound field programs

2ch Stereo only

Direct

Automatically bypasses the DSP circuit and tone control circuit depending on the condition of tone control etc., when an analog sound source is played back. You can enjoy a higher quality sound.

Auto (Default)	Outputs sound by bypassing the DSP circuit and tone control circuit when both tone controls of “Bass” and “Treble” are set to 0dB.
Off	Does not bypass the DSP circuit and tone control circuit.

7ch Stereo only

CT Level

Adjusts the center channel volume. 🧠2

Adjustable range	0 to 100%
Default setting	100%

SL Level

Adjusts the volume of the surround L channel. 🧠2

Adjustable range	0 to 100%
Default setting	100%

SR Level

Adjusts the volume of the surround R channel. 🧠2

Adjustable range	0 to 100%
Default setting	100%

SB Level

Adjusts the volume of the surround back channel. 🧠2

Adjustable range	0 to 100%
Default setting	35% (7.1-channel configuration) 50% (6.1-channel configuration)

Straight Enhancer/7ch Enhancer only

EFCT LVL

Adjusts the effect level of the compressed music enhancer mode.

High (Default)	Standard effect.
Low	Sets when the high-frequency signals of the source are emphasized excessively.

🧠1 : Surround decoders cannot be changed when used with the following MOVIE sound field programs.

- Mono Movie
- Sports
- Action Game
- Roleplaying Game

🧠2 : Not displayed when speakers are set to be inactive.

### Parameters usable in surround decoder

#### Dolby PLIIx Music and Dolby PLII Music only

##### Panorama

Adjusts the soundscape of the front sound field. Sends front left/right channels sounds to the surround speakers as well as the front speakers for a wraparound effect.

Off (Default)	Disables the effect.
On	Enables the effect.

##### CT Width

Spreads the center channel sound to the front left and right speakers to suit your needs or preferences. Set this parameter to 0 for outputting the center sound from the center speaker only, or to 7 for outputting it from the front left/right speaker only.

Adjustable range	0 to 7
Default setting	3

##### Dimension

Adjusts the difference in level between the front sound field and the surround sound field. You can adjust the difference in level created by the software being played back to obtain the preferred sound balance.

The surround sound gets stronger as you make the value more negative, and the front sound gets stronger as you make the value more positive.

Adjustable range	-3 to STD to +3
Default setting	STD (Standard)

#### When Neo:6 Music is selected

##### C. Image

Adjusts the front left and right channel output relative to the center channel to make the center channel more or less dominant as necessary.

Adjustable range	0.0 to 1.0
Default setting	0.3

## Controlling other components with the remote control

You can operate an external component such as TV and DVD player with the remote control of this unit by setting the code for external component (remote control code). The remote control code can be set for each input source. Individual setting allows you to switch external components seamlessly depending on the selected input source.

### Keys connecting external components

The remote control keys for controlling external components are available only when the external components have corresponding control keys.

### Default remote control code settings

The following remote control codes are assigned to input sources as factory default settings. For a complete list of available remote control codes, please refer to “[Remote Control Code Search](#)” in the CD-ROM.

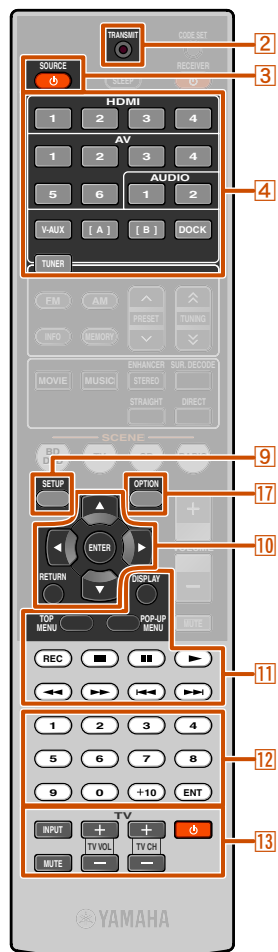

#### Selecting input source connected to DVD player

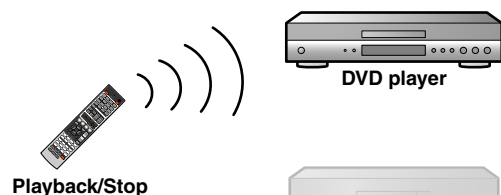

#### Selecting input source connected to CD player

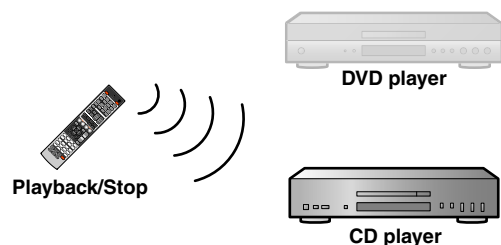

If you are unable to operate this unit after operating an external component, press **9** **SETUP** or **17** **OPTION** and then try operating the remote control again.

#### 3 SOURCE

Switches an external component on and off.

#### 10 Cursor, 10 ENTER, 10 RETURN

Operates the menus of external components.

#### 11 DISPLAY

Switches an external component display.

#### 11 External component operation keys

Functions as a recording or playback key of an external component, or a menu display key.

#### 12 Numeric keys

Functions as numeric keys of an external component.

#### 13 TV control keys

<b>13</b> INPUT	Switches video inputs of TV.
<b>13</b> MUTE	Mutes TV volume temporarily.
<b>13</b> TV VOL +/-	Controls the volume of TV.
<b>13</b> TV CH +/-	Switches TV channels.
<b>13</b> Power	Turns on and off TV.

Input	Category	Manufacturer	Remote control code
HDMI1	Blu-ray player/recorder	Yamaha	2064
HDMI2	—	—	—
HDMI3	—	—	—
HDMI4	—	—	—
AV1	—	—	—
AV2	—	—	—
AV3	CD player	Yamaha	5095
AV4	—	—	—
AV5	—	—	—
AV6	—	—	—
AUDIO1	—	—	—
AUDIO2	—	—	—
V-AUX	—	—	—
A/B	—	—	—
DOCK	DOCK	Yamaha	5089
TUNER	Tuner	Yamaha	5085

- 2** TRANSMIT
- 3** SOURCE
- 4** Input selector
- 9** SETUP
- 10** Cursor  $\Delta$  /  $\nabla$  /  $\leftarrow$  /  $\rightarrow$
- 10** ENTER
- 10** RETURN
- 11** External component operation keys
- 11** DISPLAY
- 12** Numeric keys
- 13** TV control keys
- 13** INPUT
- 13** MUTE
- 13** TV VOL +/-
- 13** TV CH +/-
- 13** Power
- 17** OPTION

**1** : You can register remote control codes for external components to **4** **Input selector** and remote control codes for TVs in **13** **TV control keys**.  
To register a TV remote control code to **4** **Input selector**: You can use the **10** **Cursor**, **12** **Numeric keys**, and **13** **TV control keys** to control a TV you have registered.

To register a remote control code for a device other than a TV to **4** **Input selector**: You can use the **10** **Cursor** and **12** **Numeric keys** etc to control external components, and the **13** **TV control keys** to control TVs registered in **13**.

**2** : Use A/B for external component operations only. Set these keys to remote control codes if you want to perform external component operations without linking to input source selection of this unit. For example, it may be convenient to assign remote control codes for devices such as TVs.



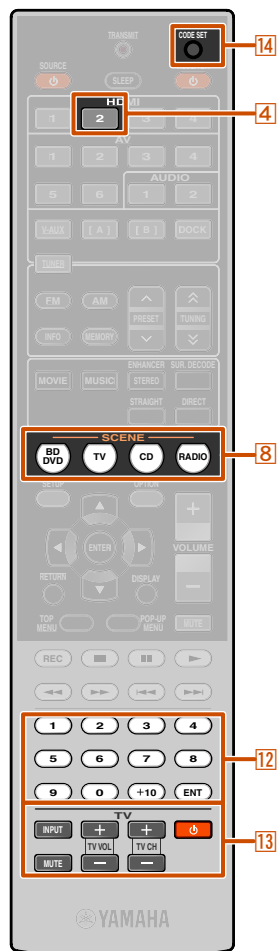

- 4 HMI2
- 8 SCENE
- 12 Numeric keys
- 13 TV control keys
- 13
- 14 CODE SET

### Registering remote control codes for external component operations

The following section describes how to register remote control code using an example of the registration of the remote control codes of a Yamaha BD player connected to HDMI2 jack.

- Perform each of the following steps within 1 minute. Settings will be automatically stopped if more than 1 minute passes since the last operation. To reset, repeat from step 2.
- Remote control code of an external component cannot be set from the name or model number of a unit. Use “Remote Control Code Search” in the CD-ROM to search the available remote control codes from the category or manufacturer of external components.
- If multiple remote control codes exist, first set the first code in the list, if it does not work then try the other codes.

- 1 Use “Remote Control Code Search” in the CD-ROM to search the available remote control codes from the category or manufacturer of external components.

“2064” can be used for a Yamaha BD player.

- 2 Press **14**CODE SET on the remote control using a pointed object such as the tip of a ballpoint pen.

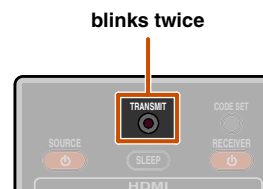

- 3 Press **4**HDMI2 on the remote control to switch the input source to HDMI2.

Perform the following steps to register the selected input source here to the remote control code.

- 4 Enter a remote control code “2064” using **12**Numeric keys.



Once the remote control code is registered successfully the remote control will blink twice.

Registration successful: blinks twice  
Registration failed: blinks 6 times

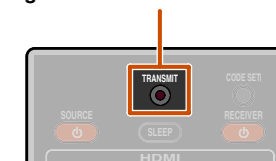

- If the registration fails, repeat the step 2.
- In case of an external component with multiple remote control codes, the other remote control codes may be supported. Repeat from step 2 with the other remote control codes.

- 5 To switch between BD player linked to scene selections, press **8**SCENE and at the same time press **4**HDMI2 and hold it for approximately 3 seconds.

Then you can operate the external components by switching the input source to HDMI2, or selecting HDMI2 in the registered scene.

Same steps for operating other external components, press **8**SCENE and at the same time press the input source key selected in step 3 and hold it for approximately 3 seconds.

1 : When you want to register a remote control code to the **13**TV control keys, press **13** (**13**TV control keys) in step 3.

2 : When you want to register a remote control code to the **13**TV control keys, enter the TV remote control code in step 4.



## Resetting all remote control codes

Resetting all remote control codes for external components to the initial factory settings.

Perform each of the following steps within 1 minute. Settings will be automatically stopped if more than 1 minute passes since the last operation. To reset, repeat from step 2.

**1** Press **14** **CODE SET** on the remote control using a pointed object such as the tip of a ballpoint pen.

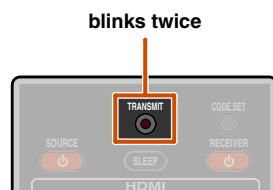

**2** Press **9** **SETUP** on the remote control.

**3** Enter “9981” using **12** **Numeric keys**.



Once the remote control code is reset successfully the remote control will blink twice.

**Reset successful: blinks twice**  
**Reset failed: blinks 6 times**

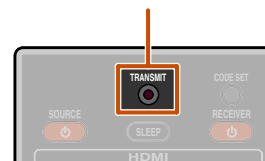

If setup fails, repeat from step 1.

- 9** **SETUP**
- 12** **Numeric keys**
- 14** **CODE SET**



## Extended functionality that can be configured as needed (Advanced Setup menu)

The Advanced Setup menu can be used for unit initialization and other useful extended functions. The Advanced Setup menu can be operated as follows.

### Displaying/Setting the Advanced Setup menu

**1** Switch this unit to the standby mode.

**2** Press **⏻** while pressing and holding **STRAIGHT** on the front panel.

Release the keys when “ADVANCED SETUP” is displayed on the front panel display.

After approximately a few seconds, the top menu items are displayed.

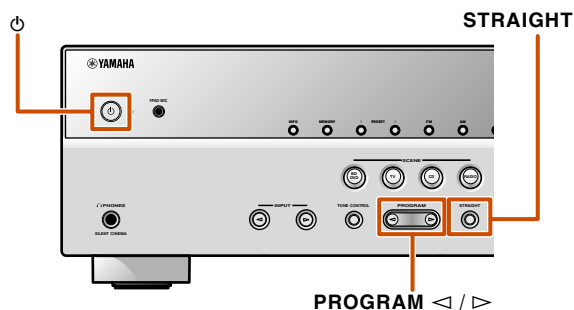

**3** Use **PROGRAM </>** to select the item to be set from the following items.

In the Advanced Setup menu, you can set the following settings.

SP IMP.	Sets the impedance of speakers.
REMOTE ID	Changes the remote control ID of a receiver.
TU	Selects one of the following FM/AM frequency steps.
INIT	Initializes various settings for this unit.

**4** Press **STRAIGHT** repeatedly to select the value you want to change.

**5** Switch this unit to the standby mode, and then switch it on again.

The settings become effective and the unit is powered on. If initialization is selected, it will be performed when the unit is powered on again.

### Setting the impedance of speakers (U.S.A. and Canada models only)



Changes the unit settings depending on the impedance of the speakers connected.

6Ω MIN	Select the impedance when 6Ω speakers are connected.
8Ω MIN (Default)	Select the impedance when speakers above 8Ω are connected.

1: U.S.A. and Canada models only.

2: Asia and General models only.

3: For detailed procedures of speaker impedance settings, refer to “(U.S.A. and Canada models only) Changing speaker impedance” ([esp. p. 12](#)).

## Avoiding crossing remote control signals when using multiple Yamaha receivers



The remote control of the unit can only receive signals from a receiver which has an identical ID (remote control ID). When using multiple Yamaha AV receivers, you can set each remote control with a unique remote control ID for its corresponding receiver.

On the contrary, if you are setting the same remote control ID for all receivers, you can use one remote control to operate 2 receivers.

ID1 (Default)	Receives the remote control signals set in ID1.
ID2	Receives the remote control signals set in ID2.

ID1 is set for both remote control and receiver by default. To avoid crossing remote control, change the remote control ID for both remote control and receiver.

### ■ To change the remote control ID

Perform each of the following steps within 1 minute. Settings will be automatically stopped if more than 1 minute passes since the last operation. To reset, repeat from step 1.

- 1 Press **14**CODE SET on the remote control using a pointed object such as the tip of a ballpoint pen.
- 2 Press **9**SETUP on the remote control.
- 3 Enter the desired remote control ID code.

To switch to ID1:  
Enter "5019" using **12**Numeric keys.

To switch to ID2:  
Enter "5020" using **12**Numeric keys.

Once the remote control code is registered successfully the remote control will blink twice.

Registration successful: blinks twice  
Registration failed: blinks 6 times

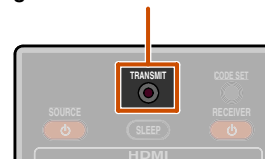

- If setup fails, repeat from step 1.
- Returns to ID1 after the remote control code is initialized ([p. 64](#)).

## Changing FM/AM frequency steps (Asia and General models only)



You can select one of the following FM/AM frequency steps: **1**

AM10/FM100	You can adjust the AM frequency by steps of 10kHz and FM by steps of 100kHz.
AM9/FM50 (Default)	You can adjust the AM frequency by steps of 9kHz and FM by steps of 50kHz.

## Initializing various settings for this unit



Initializes various settings stored in this unit and sets it back to default.

Select the items to be initialized from the following.

DSP PARAM	Initializes all parameters for the sound field programs.
ALL	Resets this unit to default factory settings.
CANCEL (Default)	Does not initialize.



- 9** SETUP
- 12** Numeric keys
- 14** CODE SET

**1** : For details on setting FM/AM frequency steps, refer to "FM/AM tuning" ([p. 34](#)).

## Using the HDMI Control function

This unit supports the HDMI Control function, which allows you to operate external components via HDMI. If you connect devices that support HDMI Control (ex. Panasonic VIERA Link-compatible TVs, DVD/Blu-ray Disc recorders, etc.) 1, you can use the following operations with the remote control of any of those devices:

- Power synchronization (on/standby)
- Volume control, including Mute
- Changing the volume of the audio output signal device (either the TV or this unit)

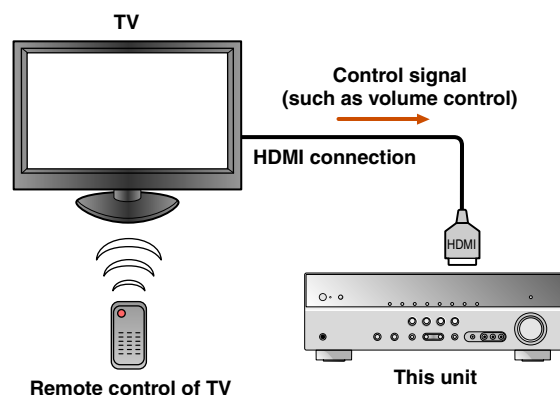

### NOTE

The following is an example of how to connect this unit, a TV, and a DVD recorder. Follow the instructions in your TV and DVD recorder manuals, as well as the ones written below.

- Set the TV's HDMI Control function to "On"
- Follow the AV amplifier connection instructions, and connect this unit to the TV

**1** Connect the TV, DVD recorder supporting HDMI Control to this unit's HDMI output jack.

**2** Turn on the TV and this unit.

Refer to the TV's instruction manual on how to operate external components.

**3** Set the TV and this unit's HDMI Control function to "On."

Receiver unit	Confirm that "Control" in the Setup menu (HDMI Setup) is set to "On" (p. 55).  2
TV/DVD Recorder	Check the instruction manuals for those devices.

**4** Turn the TV off.

Other synchronized HDMI Control devices are turned off with the TV. If they are not synchronized, turn them off manually.

**5** Turn the TV on.

Confirm that this unit has turned on in conjunction with the TV. If it is still off, turn it on manually.

**6** Change the TV's input setting to the input jack that is connected to this unit (ex. HDMI1).

**7** If DVD recorder that supports the HDMI Control function are connected to this unit, turn them on.

Receiver unit	Confirm that the input source for the DVD recorder has been selected. If a different input source has been selected, please change it manually.
TV/DVD Recorder	Confirm that the video signal from the recorder is being properly received by the TV.

Operations 1-7 will not be required more than twice.

**8** Confirm that this unit is properly synchronized with the TV through the following operations by using the TV remote control.

- Power On/Off
- Volume Control
- Switching between audio output devices

If this unit is not synchronized to the TV's power operations, check that the HDMI Control function is set to "On" for both devices.

If they will not properly synchronize, unplugging and re-plugging the devices and turning them on and off may solve the problem.

 1: We recommend that you use TVs and DVD/BD recorders from the same manufacturer whenever possible.

 2: The default setting for the HDMI Control function is "Off."

### Switching the input source on this unit automatically when listening to TV audio

When the HDMI Control (p. 67) is operating properly, the input source of this unit is automatically changed to match operations carried out on the TV. The default input jack is AV4. If the AV4 optical digital jack is connected to the TV's audio output jack, then you can enjoy TV sound through this unit right away.

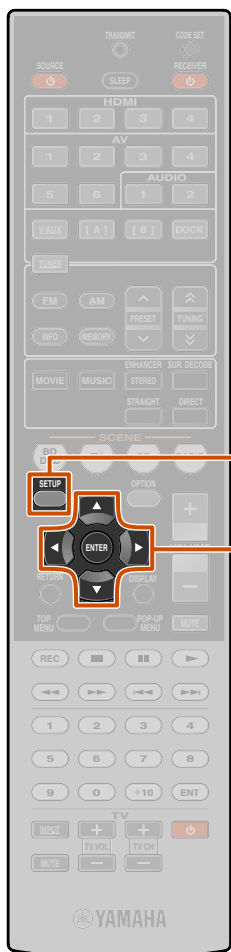

- 9 SETUP
- 10 Cursor  $\Delta/\nabla/\leftarrow/\rightarrow$
- 10 ENTER

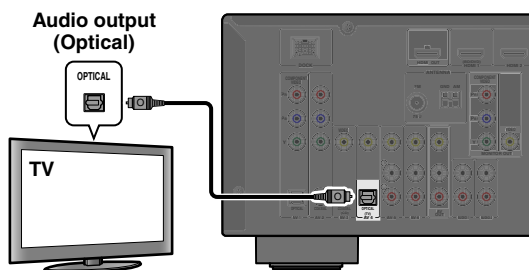

To use other jacks to input audio signals from TV, carry out the following procedure.

- 1 **Connect this unit and the TV with an HDMI cable.**
- 2 **Connect TV's audio output to this unit.**  
The input jacks listed below are available to input TV's audio signals. Use the same jack type as used for the TV.

TV output jack	Input jack
Optical digital audio output	AV1 or AV4 (default)
Coaxial digital audio output	AV2 or AV3
Analog stereo output	AV5, AV6, AUDIO1, or AUDIO2

Available input jacks

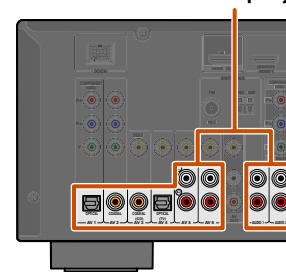

- 3 Press 9 **SETUP**.

- 4 Use 10 **Cursor**  $\Delta/\nabla$  to select "HDMI Setup" and press 10 **ENTER**.



- 5 Make sure that "Control" is selected, and then use 10 **Cursor**  $\leftarrow/\rightarrow$  to select "On."



- 6 Press 10 **Cursor**  $\nabla$  to select "TVAudio" and select the input jack connected in step 2 using 10 **Cursor**  $\leftarrow/\rightarrow$ .



- 7 Press 9 **SETUP** when you have finished changing the settings.

If the TV hereafter transmits audio output signals, this unit will automatically switch to the input source chosen in step 6.

1: Refer to the "Setting various functions (Setup menu)" (p. 48) for details on the Setup menu.

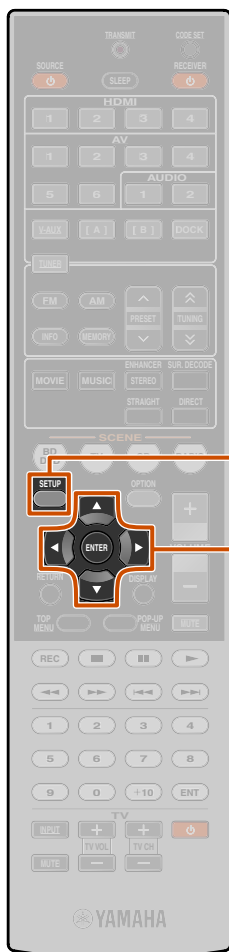

- 9 SETUP
- 10 Cursor  $\Delta/\nabla/\leftarrow/\rightarrow$
- 10 ENTER

## 1 Single HDMI cable input to TV audio with Audio Return Channel function

When using a TV that supports HDMI functions and Audio Return Channel function, audio/video output from this unit to the TV or audio output from the TV to this unit can be transmitted through a single HDMI cable (Audio Return Channel function). Audio signals transmitted from the TV to this unit can be assigned to any input source.

1 Connect this unit and the TV with an HDMI cable.

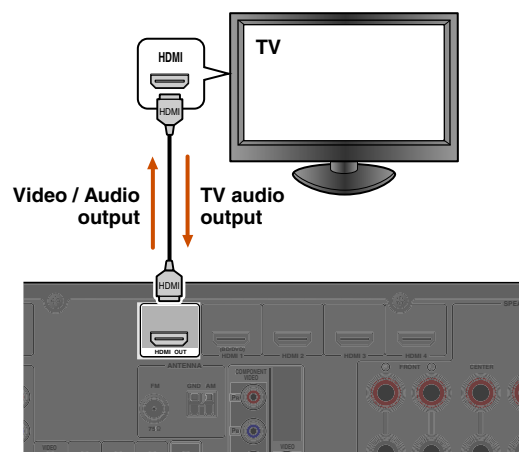

2 Press 9SETUP. 1

3 Use 10Cursor  $\Delta/\nabla$  to select "HDMI Setup" and press 10ENTER.



4 Make sure that "Control" is selected, and then use 10Cursor  $\leftarrow/\rightarrow$  to select "On."



5 Press 10Cursor  $\nabla$  to select "TVAudio" and select the input source that you want to assign to the HDMI audio signals from the TV using 10Cursor  $\leftarrow/\rightarrow$ . 2

6 Press 10Cursor  $\nabla$  to select "ReturnChan" and press 10Cursor  $\rightarrow$  to select "On."  
The Audio Return Channel function will turn on.



7 Press 9SETUP when you have finished changing the settings.

If the TV hereafter transmits audio output signals, this unit will automatically switch to the input source chosen in step 6.

1 : Refer to the "Setting various functions (Setup menu)" ([p. 48](#)) for details on the Setup menu.  
 2 : While the Audio Return Channel function is on, the jack selected for the input source cannot be used.

# APPENDIX

## Troubleshooting

Refer to the table below when this unit does not function properly.

If the problem you are experiencing is not listed below, or if the instructions below do not help, turn off this unit, disconnect the power cable, and contact the nearest authorized Yamaha dealer or service center.

### General

Problem	Cause	Remedy	See page
<b>The power will not turn on.</b>	The protection circuitry operated 3 times consecutively.	As a safety precaution, when the protection circuitry operates 3 times consecutively, the capability to turn on the power is disabled. Please contact your nearest Yamaha dealer or service center to request repair.	—
<b>The unit enters standby mode soon after the power is turned on.</b>	The power cable is not completely inserted.	Connect the power cable properly to an AC wall outlet.	—
	(When this unit is turned back on and “CHECK SP WIRES!” is displayed.) The protection circuitry has been activated because this unit was turned on while a speaker cable was shorted.	Make sure that all speaker cables between this unit and speakers are connected properly.	<a href="#">12</a>
<b>This unit cannot be turned off or does not work properly.</b>	The internal microcomputer is hung-up due to an external electric shock (such as lightning or excessive static electricity) or by a drop in power supply voltage.	Disconnect the power cable from the AC wall outlet, wait about 30 seconds and then plug it in again.	—
	The batteries in the remote control may have lost their charge.	Replace all batteries.	<a href="#">4</a>
<b>The unit enters standby mode.</b>	The protection circuitry has been activated because of a short circuit, etc.	Check that the speaker with an impedance of at least 6Ω.	—
		(U.S.A. and Canada models) Check that the speaker impedance settings are correct.	<a href="#">12</a>

Problem	Cause	Remedy	See page
<b>After display of a countdown on the front panel, the unit goes into standby mode.</b>	If you do not use take any action, the Auto Power Down function operates.	Turn on the unit, and play the source again.	—
		In the Setup menu “AutoPowerDown” (“Func. Setup” → “AutoPowerDown”), increase the time until switching to standby mode, or turn off the Auto Power Down function.	<a href="#">58</a>
<b>Sound/images suddenly go off.</b>	The protection circuitry has been activated because of a short circuit, etc.	Check that the speaker wires are not touching each other, then turn the unit back on.	—
	The sleep timer has turned off the unit.	Turn on the unit, and play the source again.	—



Problem	Cause	Remedy	See page
<b>No sound.</b>	Incorrect input or output cable connections.	Connect the cables properly. If the problem persists, the cables may be defective.	<a href="#">17</a>
	If a DVI-HDMI cable is used to connect the unit with an external component, then it is necessary to use an audio input jack for a different input to output audio.	Display the HDMI Input Option menu for the connected cable, select "Audio In," and select the jack to use for audio input.	<a href="#">46</a>
	Speaker connections are not secure.	Secure the connections.	<a href="#">12</a>
	The HDMI components connected to the unit do not support the HDCP copy protection standards.	Connect HDMI components that support the HDCP copy protection standards.	<a href="#">46</a>
	The audio input into the device is set to playback through the TV.	In the Setup menu, set the HDMI Audio Out ("Sound Setup" → "Audio") to other than "TV."	<a href="#">56</a>
	No appropriate input source has been selected.	Select an appropriate input source with <b>Input selector</b> .	<a href="#">28</a>
	The volume is turned down or muted.	Turn up the volume.	—
Signals that this unit cannot reproduce are being input from a source component, such as a CD-ROM.	Use an input source that has signals that can be reproduced on this unit.	—	
<b>No picture.</b>	An output video jack type used to display content on the TV is different from the one of the input video (ex. Video input → HDMI output).	Use video jacks of the same type (ex. Video input → Video output) to connect to the TV.	<a href="#">15</a>
	An appropriate video input is not selected on the TV.	Select an appropriate video input on the TV.	—

Problem	Cause	Remedy	See page
<b>No sound is output from a specific speaker.</b>	The speaker is malfunctioning. Check the Speaker indicators on the front panel display. If the corresponding indicator lights up, connect another speaker and check if sound is output.	If sound is not output, the unit may be malfunctioning.	<a href="#">7</a>
	The playback component or speakers are not connected properly.	Connect the cables properly. If the problem persists, the cables may be defective.	<a href="#">12, 17</a>
	Output from that speaker is disabled.	Check the Speaker indicators on the front panel display. If the corresponding indicator is turned off, try the following. 1) Change to a different input source. 2) With the selected sound field program, sound is not output from that speaker. Select another sound field program. 3) "None" may have been selected for that speaker on this unit. Display "Speaker Setup" in the Setup menu, and set respective parameters to enable output from that speaker ("Speaker Setup" → "Config").	<a href="#">7, 49</a>
	The volume of that speaker is set to the minimum in "Speaker Setup" in the Setup menu.	Display "Speaker Setup" in the Setup menu and adjust the volume ("Speaker Setup" → "Level").	<a href="#">51</a>
	(If hardly any sound comes from one channel) Speaker output balance is not set correctly.	Balance the volume of each speaker from "Level" in the Setup menu ("Speaker Setup" → "Level").	<a href="#">51</a>
	Sound may not be output from certain channels, depending on the input source or sound field program.	Try another sound field program.	<a href="#">29</a>
	<b>Only the center speaker outputs substantial sound.</b>	When a monaural source sound field program is applied, for some surround decoders, sound from all channels is output from the center speaker.	Try another sound field program.

Problem	Cause	Remedy	See page
<b>No sound is heard from the surround speakers.</b>	This unit is in straight decoding mode and a monaural source is being played back.	Press <b>STRAIGHT</b> to exit straight decoding mode.	<a href="#">30</a>
	Sound may not be output from certain channels depending on input sources or sound field programs.	Try another sound field program.	<a href="#">29</a>
<b>No sound is heard from the surround back speakers.</b>	An external amplifier is not connected to the external SURROUND BACK jacks.	Connect an external amplifier to the SURROUND BACK jacks and then connect surround back speakers.	<a href="#">11</a>
	An external amplifier or surround back speakers are not connected correctly to the external SURROUND BACK jacks.	Check if the connection is correct.	
	An external amplifier for surround back speakers is not set correctly. <ul style="list-style-type: none"> <li>The power is off.</li> <li>An input source that is connected from the SURROUND BACK jacks is not selected.</li> <li>The volume is too low.</li> </ul>	Set the external amplifier correctly.	—
	“EXTD Surround” in the Option menu is set to “Off,” or an input signal does not contain a surround back flag with “EXTD Surround” set to “Auto.”	Set “EXTD Surround” other than “Off” or “Auto.”	<a href="#">45</a>
<b>No sound is heard from the subwoofer.</b>	A subwoofer is not connected, or it is inactive.	Check that a subwoofer is connected correctly, and from the Setup menu “Subwoofer” (“Speaker Setup” → “Config” → “Subwoofer”), set the subwoofer to “On.”	<a href="#">49</a>
	The subwoofer is turned off.	Turn the subwoofer power on. If the subwoofer includes an Auto Power Off function, then lower the Auto Power Off sensitivity settings.	—
	The source does not contain LFE ( <a href="#">Esp. 77</a> ) or low frequency signals.		—

Problem	Cause	Remedy	See page
<b>The right combination of audio / video jacks to connect cannot be found.</b>	Combine input connected to the external component video output with another input audio jack.	Display the Input Audio menu for the connected video output, select “Audio In,” and select the jack to use for audio input.	<a href="#">46</a>
<b>The audio input sources cannot be played in the desired digital audio signal format.</b>	The connected component is not set to output the desired digital audio signals.	Set the playback component properly referring to its instruction manual.	—
<b>There is noise interference from digital or radio frequency equipment.</b>	This unit is too close to other digital or radio frequency equipment.	Move this unit further away from such equipment.	—
<b>Noise/hum noise is heard.</b>	Incorrect cable connection. Connect the audio cables properly.	If the problem persists, the cables may be defective.	—
	A DTS-CD is being played back.	1) When only noise is output If a DTS bitstream signal is not properly input to this unit, only noise is output. Connect the playback component to this unit by digital connection and playback the DTS-CD. If the condition is not improved, the problem may result from the playback component. Consult the manufacturer of the playback component. 2) When noise is output during playback or skip operation Before playing back the DTS-CD, display the Option menu after selecting the input source and set “Decoder Mode” to “DTS.”	—
<b>The volume cannot be increased, or the sound is distorted.</b>	The component connected to the output jacks of this unit is not turned on.	When the component connected to the output jacks of this unit is not turned on, the sound may be distorted, or the volume may be decreased due to the nature of AV receivers. Turn on all components connected to this unit.	—
	“Max Volume” is set to a low value.	Set it to a higher value.	<a href="#">54</a>







### HDMI™

Problem	Cause	Remedy	See page
<b>The front panel display HDMI indicator is flashing.</b>	An error with the HDMI connection has occurred.	Try re-inserting the HDMI cable.	—
		Confirm that HDMI video that is not supported by the unit is not being input (HDMI Input → Option menu → “Signal Info”).	<a href="#">46</a>
<b>No picture or sound.</b>	The number of components is over the limit.	Disconnect some of the HDMI components.	—
	The connected HDMI component does not support high-bandwidth digital copyright protection (HDCP).	Connect an HDMI component that supports HDCP.	—
<b>(When using HDMI Control function) TV sound is not output from this unit when operating the remote control of the TV.</b>	The TV audio output is not connected to this unit, or the setting to match operations carried out on TV is not set.	Connect the TV audio output to this unit, and then select the connected input source in “TVAudio” (Setup menu → HDMI Setup → TVAudio).	<a href="#">55</a>
	(When using Audio Return Channel function) The Audio Return Channel function is not working.	Make sure that your TV supports Audio Return Channel. Set the Audio Return Channel function to on (Setup menu → HDMI Setup → ReturnChan).	<a href="#">55</a>

### Tuner (FM/AM)

#### FM

Problem	Cause	Remedy	See page
<b>FM stereo reception is noisy.</b>	You are too far from the station transmitter, or the input from the antenna is weak.	Check the antenna connections.	<a href="#">22</a>
		Switch to monaural mode.	<a href="#">35</a>
		Replace the outdoor antenna with a more sensitive multi-element antenna.	—
<b>There is distortion, and clear reception cannot be obtained even with a good FM antenna.</b>	There is multi-path interference.	Adjust the antenna height or orientation, or place it in a different location.	—
<b>The desired station cannot be tuned into with the automatic tuning method.</b>	You are in an area far from a station, or input from the antenna is weak.	Replace the outdoor antenna with a more sensitive multi element antenna.	—
		Use <b>TUNING</b>  /  to manually select the station.	<a href="#">34</a>
<b>“No Presets” is displayed.</b>	No preset stations are registered.	Register stations you want to listen to as preset stations before operation.	<a href="#">35</a>
<b>“Wrong Station” is displayed.</b>	An invalid FM/AM frequency has been input.	Input a frequency that can be received.	—



### AM

Problem	Cause	Remedy	See page
<b>The desired station cannot be tuned into with the automatic tuning method.</b>	The signal is weak, or the antenna connections are loose.	Adjust the AM loop antenna orientation.	<a href="#">22</a>
		Use the manual tuning method.	<a href="#">34</a>
<b>Automatic station preset does not work.</b>	Automatic station preset is not available for AM stations.	Use manual station preset.	<a href="#">34</a>
<b>Continuous crackling and hissing noises are heard.</b>	The supplied AM loop antenna is not connected.	Connect the AM loop antenna correctly even if you use an outdoor antenna.	<a href="#">22</a>
	The noises may be caused by lightning, fluorescent lamps, motors, thermostats, or other electrical equipment.	It is difficult to completely eliminate noise, but it can be reduced by installing and properly grounding an outdoor AM antenna.	<a href="#">22</a>
<b>Buzzing and whining noises are heard.</b>	A TV set is being used nearby.	Move this unit away from the TV set.	—

### iPod™/iPhone™

Display	Cause	Remedy	See page
Loading...	The unit is in the process of recognizing the connection with your iPod/iPhone.		—
	The unit is in the middle of acquiring song lists from your iPod/iPhone.		—
Connect error	There is a problem with the signal path from your iPod/iPhone to the unit.	Turn off the unit and reconnect the Yamaha iPod universal dock to the DOCK jack of the unit.	<a href="#">39</a>
		Remove your iPod/iPhone from the Yamaha iPod universal dock and then place it back in the dock.	<a href="#">39</a>
Unknown iPod	The iPod/iPhone being used is not supported by the unit.	Connect an iPod/iPhone supported by the unit.	—
iPod connected	Your iPod/iPhone is properly placed in the Yamaha iPod universal dock.		—
Disconnected	Your iPod/iPhone is removed from the Yamaha iPod universal dock.		—
Unable to play	The unit cannot playback the songs currently stored on your iPod/iPhone.	Check that songs are currently stored on your iPod/iPhone.	—

### Bluetooth™

Display	Cause	Remedy	See page
Searching...	The Yamaha Bluetooth wireless audio receiver and the Bluetooth component are in the process of pairing.		—
	The Yamaha Bluetooth wireless audio receiver and the Bluetooth component are in the process of establishing a connection.		
Completed	The pairing is completed.		—
Canceled	The pairing is canceled.		—
BT connected	The connection between the Yamaha Bluetooth wireless audio receiver and the Bluetooth component is established.		—
Disconnected	The Bluetooth component is disconnected from the Yamaha Bluetooth wireless audio receiver.		—
Not found	The Bluetooth component is not found.	During pairing: – pairing must be performed on the Bluetooth component and this unit simultaneously. Check if the Bluetooth component is in pairing mode. During connecting: – check if the Bluetooth component is turned on. – check if the Bluetooth component is within 10 m (32 feet) of the Yamaha Bluetooth wireless audio receiver.	—

### Remote control

Problem	Cause	Remedy	See page
<b>The remote control does not work or function properly.</b>	Wrong distance or angle.	The remote control will function within a maximum range of 6 m / 20 ft, and no more than 30 degrees off-axis from the front panel.	—
	Direct sunlight or lighting (from an inverter type of fluorescent lamp, strobe light, etc.) is striking the remote control sensor of this unit.	Adjust the lighting angle, or reposition this unit.	—
	The batteries are weak.	Replace all batteries.	<a href="#">4</a>
	The remote control ID of the remote control and this unit do not match.	Match the remote control ID of this unit and the remote control.	<a href="#">66</a>
<b>External components cannot be controlled using the remote control.</b>	The remote control code is not correctly set.	Set the remote control code correctly using <a href="#">“Remote control code search”</a> on the CD-ROM.	—
		Try setting another code for the same manufacturer using <a href="#">“Remote control code search”</a> on the CD-ROM.	—
		If this unit does not work when you press <b>Cursor</b> $\Delta / \nabla / \triangleleft / \triangleright$ , do the following. When the key does not work during DVD disc menu operation: press the <b>Input selector</b> again. When the key does not work during Option menu/Setup menu operation: press the key corresponding to the current menu operation again.	—
	Even if the remote control code is correctly set, there are some models that do not respond to the remote control.		—

## Glossary

### Audio information

#### Audio and video synchronization (lip sync)

Lip sync, an abbreviation for lip synchronization, is a technical term that involves both a problem, and the capability of maintaining audio and video signals synchronized during post-production and transmission.

Whereas the audio and video latency requires complex end-user adjustment, HDMI version 1.3 incorporates an automatic audio and video syncing capability that allows devices to perform this synchronization automatically and accurately without user interaction.

#### Bi-amplification connection

A bi-amplification connection uses two amplifiers for a speaker. One amplifier is connected to the woofer section of a loudspeaker while the other is connected to the combined mid and tweeter section. With this arrangement each amplifier operates over a restricted frequency range. This restricted range presents each amplifier with a much simpler job and each amplifier is less likely to influence the sound in some way.

#### Dolby Digital

Dolby Digital is a digital surround sound system that gives you completely independent multi-channel audio. With 3 front channels (front L/R and center), and 2 surround stereo channels, Dolby Digital provides 5 full-range audio channels. With an additional channel especially for bass effects, referred to as LFE (Low-Frequency Effect), the system has a total of 5.1-channels (LFE is counted as 0.1 channel). By using 2-channel stereo for the surround speakers, more accurate moving sound effects and surround sound environments are possible than with Dolby Surround. The wide dynamic range from maximum to minimum volumes that are reproduced by the 5 full-range channels, and the precise sound orientation generated using digital sound processing provides listeners with unprecedented excitement and realism. With this unit, any sound environment from monaural up to a 5.1-channel configuration can be freely selected for your enjoyment.

#### Dolby Pro Logic II

Dolby Pro Logic II is an improved technique used to decode vast numbers of existing Dolby Surround sources. This new technology enables a discrete 5-channel playback with 2 front left and right channels, 1 center channel, and 2 surround left and right channels, instead of only 1 surround channel for conventional Pro Logic technology. There are three modes available: “Music mode” for music sources, “Movie mode” for movie sources, and “Game mode” for game sources.

#### Dolby Pro Logic IIx

Dolby Pro Logic IIx is a new technology enabling discrete multichannel playback from 2-channel or multi-channel sources. There are three modes available: “Music mode” for music sources, “Movie mode” for movie sources (for 2-channel sources only) and “Game mode” for game sources.

#### Dolby Surround

Dolby Surround uses a 4-channel analog recording system to reproduce realistic and dynamic sound effects: 2 front left and right channels (stereo), a center channel for dialog (monaural), and a surround channel for special sound effects (monaural). The surround channel reproduces sound within a narrow frequency range. Dolby Surround is widely used with nearly all video tapes and laser discs, as well as in many TV and cable broadcasts. The Dolby Pro Logic decoder built into this unit employs a digital signal processing system that automatically stabilizes the volume on each channel to enhance moving sound effects and directionality.

#### Dolby TrueHD

Dolby TrueHD is an advanced lossless audio technology developed for high-definition disc-based media including Blu-ray Disc. Selected as an optional audio standard for Blu-ray Disc, this technology delivers sound that is bit-for-bit identical to the studio master, offering a high-definition home theater experience. Supporting bitrates up to 18.0 Mbps, Dolby TrueHD can carry up to 8 discrete channels of 24-bit/96 kHz audio simultaneously. Dolby TrueHD also remains fully compatible with the existing multichannel audio systems and retains the metadata capability of Dolby Digital, allowing dialog normalization and dynamic range control.

#### DTS 96/24

DTS 96/24 offers an unprecedented level of audio quality for multichannel sound on DVD video, and is fully backward-compatible with all DTS decoders. “96” refers to a 96 kHz sampling rate compared to the typical 48 kHz sampling rate. “24” refers to 24-bit word length. DTS 96/24 offers sound quality transparent to the original 96/24 master, and 96/24 5.1-channel sound with full-quality full-motion video for music programs and motion picture soundtracks on DVD video.

#### DTS Digital Surround

DTS Digital Surround was developed to replace the analog soundtracks of movies with a 5.1-channel digital sound track, and is now rapidly gaining popularity in movie theaters around the world. DTS, Inc. has developed a home theater system so that you can enjoy the depth of sound and natural spatial representation of DTS Digital Surround in your home. This system produces practically distortion-free 5.1-channel sound (technically, left, right and center channels, 2 surround channels, plus an LFE 0.1 channel as a subwoofer, for a total of 5.1-channels).

#### DTS Express

This is an audio format for next-generation optical discs such as Blu-ray discs. It uses optimized low bit rate signals for network streaming. In the case of a Blu-ray disc, this format is used with secondary audio, enabling you to enjoy the commentary of the movie producer via the Internet while playing the main program.

#### DTS-HD High Resolution Audio

DTS-HD High Resolution Audio is a high resolution audio technology developed for high-definition disc-based media including Blu-ray Disc. Selected as an optional audio standard for Blu-ray Disc, this technology delivers sound that is virtually indistinguishable from the original, offering a high-definition home theater experience.

Supporting bitrates up to 6.0 Mbps for Blu-ray Disc, DTS-HD High Resolution Audio can carry up to 7.1 discrete channels of 24-bit/96 kHz audio simultaneously.

DTS-HD High Resolution Audio also remains fully compatible with the existing multichannel audio systems that incorporate DTS Digital Surround.

#### DTS-HD Master Audio

DTS-HD Master Audio is an advanced lossless audio technology developed for high-definition disc-based media including Blu-ray Disc. Selected as an optional audio standard for Blu-ray Disc, this technology delivers sound that is bit-for-bit identical to the studio master, offering a high-definition home theater experience.

Supporting bitrates up to 24.5 Mbps for Blu-ray Disc, DTS-HD Master Audio can carry up to 7.1 discrete channels of 24-bit/96 kHz audio simultaneously. Supported by HDMI version 1.3 and designed for the optical disc players and AV receivers/amplifiers of the future, DTS-HD Master Audio also remains fully compatible with the existing multichannel audio systems that incorporate DTS Digital Surround.



**DSD**

Direct Stream Digital (DSD) technology stores audio signals on digital storage media, such as Super Audio CDs. Using DSD, signals are stored as single bit values at a high-frequency sampling rate of 2.8224 MHz, while noise shaping and oversampling are used to reduce distortion, a common occurrence with very high quantization of audio signals. Due to the high sampling rate, better audio quality can be achieved than that offered by the PCM format used for normal audio CDs. The frequency is equal to or higher than 100 kHz, with a dynamic range of 120 dB. This unit can transmit or receive DSD signals via the HDMI jack.

**LFE 0.1 channel**

This channel reproduces low-frequency bass signals, and has a frequency range from 20 Hz to 120 Hz. This channel is counted as 0.1, because it only enforces a low-frequency range compared to the full-range reproduced by the other 5-channels in Dolby Digital or DTS 5.1-channel systems.

**Neo:6**

Neo:6 decodes the conventional 2-channel sources for 6-channel playback by the specific decoder. It enables playback with the full-range channels with higher separation just like digital discrete signal playback. There are two modes available: “Music mode” for music sources and “Cinema mode” for movie sources.

**PCM (Linear PCM)**

Linear PCM is a signal format under which an analog audio signal is digitized, recorded and transmitted without using any compression. This is used as a method of recording CDs and DVD audio. The PCM system uses a technique for sampling the size of the analog signal per very small unit of time. Standing for “Pulse Code Modulation,” the analog signal is encoded as pulses and then modulated for recording.

**Sampling frequency and number of quantized bits**

When digitizing an analog audio signal, the number of times the signal is sampled per second is called the sampling frequency, while the degree of accuracy when converting the sound level into a numeric value is called the number of quantized bits. The range of rates that can be played back is determined based on the sampling rate, whereas the dynamic range representing the sound level difference is determined by the number of quantized bits. In principle, the higher the sampling frequency, the wider the range of frequencies that can be played back, and the higher the number of quantized bits, the more accurately the sound level can be reproduced.

**Sound field program information****CINEMA DSP**

Since the Dolby Surround and DTS systems were originally designed for use in movie theaters, their effect is best felt in a theater having many speakers designed for acoustic effects. Since home conditions, such as room size, wall material, number of speakers, and so on, can differ so widely, it is inevitable that there are differences in the sound that is heard. Based on a wealth of actually measured data, Yamaha CINEMA DSP uses Yamaha’s original DSP technology to combine Dolby Pro Logic, Dolby Digital, and DTS systems to provide the audiovisual experience of a movie theater in the listening room of your own home.

**Compressed music enhancer**

The Compressed music enhancer feature of this unit enhances your listening experience by regenerating the missing harmonics in compression artifacts. As a result, it compensates for flattened complexity due to the loss of high-frequency fidelity as well as lack of bass due to the loss of low-frequency bass, providing improved performance for the overall sound system.

**SILENT CINEMA**

Yamaha has developed a natural, realistic sound effect DSP algorithm for headphones. Parameters for headphones have been set for each sound field program, so that accurate representations of all the sound field programs can be enjoyed on headphones.

**Virtual CINEMA DSP**

Yamaha has developed a Virtual CINEMA DSP algorithm that allows you to enjoy DSP surround effects even without any surround speakers, by using virtual surround speakers. It is even possible to enjoy Virtual CINEMA DSP using a minimal two-speaker system that does not include a center speaker.

**Video information****Component video signal**

With the component video signal system, the video signal is separated into the Y signal for luminance and the PB and PR signals for chrominance. Color can be reproduced more faithfully with this system because each of these signals is independent. The component signal is also called the “color difference signal” because the luminance signal is subtracted from the color signal. A monitor with component input jacks is required in order to output component signals.

**Composite video signal**

With the composite video signal system, the video signal comprises the three basic elements of a video picture: color, brightness and synchronization data. A composite video jack on a video component transmits these three elements combined.

**Deep Color**

Deep Color refers to the use of various color depths in displays, up from the 24-bit depths in previous versions of the HDMI specification. This extra bit depth allows HDTVs and other displays increase from millions of colors to billions of colors and eliminate on-screen color banding for smooth tonal transitions and subtle gradations between colors. The increased contrast ratio can represent many times more shades of gray between black and white. Additionally, Deep Color increases the number of available colors within the boundaries defined by the RGB or YCbCr color space.

**HDMI**

HDMI (High-Definition Multimedia Interface) is the first industry supported, uncompressed, all-digital audio/video interface. Providing an interface between any sources (such as set-top boxes or AV receivers) and audio/video monitors (such as digital televisions), HDMI supports standard, enhanced or high-definition video as well as multichannel digital audio using a single cable. HDMI transmits all ATSC HDTV standards and supports 8-channel digital audio, with bandwidth to spare to accommodate future enhancements and requirements.

When used in combination with HDCP (High-bandwidth Digital Content Protection), HDMI provides a secure audio/video interface that meets the security requirements of content providers and system operators. For further information on HDMI, visit the HDMI website at “<http://www.hdmi.org/>.”

**“x.v.Color”**

A color space standard supported by HDMI version 1.3. It is a more extensive color space than sRGB, and allows the expression of colors that were not hitherto possible. While remaining compatible with the color gamut of sRGB standards, “x.v.Color” expands the color space, and can thus produce more vivid, natural images. It is particularly effective for still pictures and computer graphics.



## Information on HDMI™

### ■ HDMI signal compatibility

#### Audio signals

Audio signal types	Audio signal formats	Compatible media
2ch Linear PCM	2ch, 32-192 kHz, 16/20/24 bit	CD, DVD-Video, DVD-Audio, etc.
Multi-ch Linear PCM	8ch, 32-192 kHz, 16/20/24 bit	DVD-Audio, Blu-ray Disc, HD DVD, etc.
DSD	2/5.1ch, 2.8224 MHz, 1 bit	SACD, etc.
Bitstream	Dolby Digital, DTS	DVD-Video, etc.
Bitstream (High definition audio)	Dolby TrueHD, Dolby Digital Plus, DTS-HD Master Audio, DTS-HD High Resolution Audio, DTS Express	Blu-ray Disc, HD DVD, etc.

- If the input source component can decode the bitstream audio signals of audio commentaries, you can playback the audio sources with the audio commentaries mixed down by using the digital audio input (optical or coaxial) connections.
- Refer to the supplied instruction manuals of the input source component, and set the component appropriately.

#### NOTES

- When CPPM copy-protected DVD-Audio is played back, video and audio signals may not be output, depending on the type of the DVD player.
- This unit is not compatible with HDCP-incompatible HDMI or DVI components.
- Refer to the supplied instruction manuals for details.  
To decode audio bitstream signals on this unit, set the input source component appropriately so that the component outputs the bitstream audio signals directly (does not decode the bitstream signals on the component).
- This unit is not compatible with the audio commentary features (for example, the special audio contents downloaded via Internet) of Blu-ray Disc or HD DVD. This unit does not playback the audio commentaries of the Blu-ray Disc or HD DVD content.

#### Video signals

This unit is compatible with the video signals of the following resolutions:

- 480i/60 Hz
- 576i/50 Hz
- 480p/60 Hz
- 576p/50 Hz
- 720p/60 Hz, 50 Hz
- 1080i/60 Hz, 50 Hz
- 1080p/60 Hz, 50 Hz, 24 Hz

## About trademarks



Manufactured under license from Dolby Laboratories. Dolby, Pro Logic and the double-D symbol are trademarks of Dolby Laboratories.



Manufactured under license under U.S. Patent No's:

5,451,942;5,956,674;5,974,380;5,978,762;6,226,616;6,487,535 & other U.S. and worldwide patents issued & pending. DTS is a registered trademark and the DTS logos, Symbol, DTS-HD and DTS-HD Master Audio are trademark of DTS, Inc. © 1996-2007 DTS, Inc. All Rights Reserved.

#### iPod™, iPhone™

“iPod” is a trademark of Apple Inc., registered in the U.S. and other countries. “iPhone” is a trademark of Apple Inc.

#### Bluetooth™

Bluetooth is a registered trademark of the Bluetooth SIG and is used by Yamaha in accordance with a license agreement.

# HDMI

“HDMI,” the “HDMI” logo and “High-Definition Multimedia Interface” are trademarks, or registered trademarks of HDMI Licensing LLC.

SILENT™  
CINEMA

“SILENT CINEMA” is a trademark of Yamaha Corporation.



## Specifications

### ■ Input jacks

- Analog audio  
Audio x 5 (AV5, AV6, AUDIO1, AUDIO2, V-AUX)
- Digital audio  
Optical x 2 (AV1, AV4)  
Coaxial x 2 (AV2, AV3)
- Video  
Composite x 5 (AV3, AV4, AV5, AV6, V-AUX)  
Component x 2 (AV1, AV2)
- Other  
HDMI x 4  
DOCK x 1 (AUDIO, VIDEO [Composite])

### ■ Output jacks

- Analog Audio  
Speaker out x 5ch (FRONT L/R, CENTER, SURROUND L/R)  
PRE OUT x 2 (SURROUND BACK L/R)  
Subwoofer out x 1  
AV OUT x 1  
AUDIO OUT x 1
- Video  
MONITOR OUT  
- Component x 1  
- Composite x 1  
AV OUT  
- Composite x 1
- Other  
HDMI OUT x 1

### ■ HDMI

- HDMI Specification: Deep Color, "x.v.Color," Auto Lips Sync, ARC (Audio Return Channel)
- Video Format (Repeater Mode)
  - VGA
  - 480i/60 Hz
  - 576i/50 Hz
  - 480p/60 Hz
  - 576p/50 Hz
  - 720p/60 Hz, 50 Hz
  - 1080i/60 Hz, 50 Hz
  - 1080p/60 Hz, 50 Hz, 24 Hz
- Audio Format
  - Dolby Digital
  - DTS
  - DSD 6ch
  - Dolby Digital Plus
  - Dolby TrueHD
  - DTS-HD
  - PCM 2ch-8ch (Max 192 kHz/24 bit)
- Content Protection: HDCP compatible

### ■ Compatible Decoding Formats

- Decoding Format
  - Dolby True HD, Dolby Digital Plus
  - DTS-HD Master Audio, DTS-HD High Resolution, DTS Express
  - Dolby Digital, Dolby Digital EX
  - DTS, DTS 96/24, DTS-ES Matrix 6.1, DTS-ES Discrete 6.1

### • Post Decoding Format

- Dolby Pro Logic
- Dolby Pro Logic II Music, Dolby Pro Logic II Movie, Dolby Pro Logic II Game
- Dolby Pro Logic IIx Music, Dolby Pro Logic IIx Movie, Dolby Pro Logic IIx Game
- DTS Neo:6 Music, DTS Neo:6 Cinema

### ■ AUDIO SECTION

#### • Minimum RMS Output Power for Front, Center, Surround

[U.S.A. and Canada models]	
(1 kHz, 0.9% THD, 8 Ω)	
FRONT L/R .....	105 W/ch
CENTER .....	105 W
SURROUND L/R .....	105 W/ch
[Other models]	
(1 kHz, 0.9% THD, 6 Ω)	
FRONT L/R .....	105 W/ch
CENTER .....	105 W
SURROUND L/R .....	105 W/ch

#### • Dynamic Power (IHF)

[U.S.A. and Canada models]	
Front Speakers 8/6/4/2 Ω .....	110/130/160/180 W
[Other models]	
Front Speakers 6/4/2 Ω .....	110/130/150 W

#### • Maximum Useful Output Power (JEITA)

[China, Korea, General and Asia models]	
1 kHz, 10% THD, 6 Ω .....	140 W

#### • Maximum Output Power [U.K., Europe and Asia models]

1 kHz, 0.7% THD, 4 Ω .....	120 W
----------------------------	-------

#### • IEC Output Power [U.K., Europe and Asia models]

Front Speakers 1 kHz, 0.9% THD, 8 Ω .....	105 W+105 W
---	-------------

#### • Dynamic Headroom [U.S.A. and Canada models]

8 Ω .....	0.2 dB
-----------	--------



- Input Sensitivity/Input Impedance  
AV5, etc .....200 mV/47 k $\Omega$
- Maximum Input Voltage  
AV5, etc. (1 kHz, 0.5% THD) ..... 2.3 V or more
- Rated Output Voltage/Output Impedance  
AUDIO OUT .....200 mV/1.2 k $\Omega$   
SUBWOOFER (2ch Stereo & Front: Small)..... 1.0 V/1.2 k $\Omega$
- Headphone Jack Rated Output/Impedance  
AV5, etc. (1 kHz, 50 mV, 8  $\Omega$ ) ..... 100 mV/470  $\Omega$
- Frequency Response  
AV5 to FRONT ..... 10 Hz to 100 kHz, +0/-3 dB
- Total Harmonic Distortion  
AV5, etc. to FRONT (DIRECT)  
[U.S.A. and Canada models] (1 kHz, 50 W, 8  $\Omega$ ) ..... 0.06% or less  
[Other models] (1 kHz, 50 W, 6  $\Omega$ ) ..... 0.06% or less
- Signal to Noise Ratio (IHF-A Network)  
AV5, etc. (DIRECT) Input Shorted (250 mV to Front Speakers)  
.....100 dB or more
- Residual Noise (IHF-A Network)  
Front Speakers .....150  $\mu$ V or less
- Channel Separation (1 kHz/10 kHz)  
AV5, etc. (5.1 k $\Omega$  shortened)..... 60 dB/45 dB or more
- Volume Control ..... MUTE / -80 dB to +16.5 dB
- Tone Control (Front Speakers)  
BASS Boost/Cut ..... $\pm$ 10 dB/2 dB at 50 Hz  
BASS Turnover Frequency ..... 350 Hz  
TREBLE Boost/Cut ..... $\pm$ 10 dB/2 dB at 20 kHz  
TREBLE Turnover Frequency ..... 3.5 kHz
- Filter Characteristics (fc=40/60/80/90/100/110/120/160/200 Hz)  
H.P.F. (Front, Center, Surround, Surround Back) ..... 12 dB/oct.  
L.P.F. (Subwoofer) ..... 24 dB/oct.

### ■ VIDEO SECTION

- Video Signal Type  
[U.S.A., Canada, Korea and General models] ..... NTSC  
[Other models] ..... PAL
- Signal Level  
Composite ..... 1 Vp-p/75  $\Omega$   
Component ..... 1 Vp-p/75  $\Omega$  (Y), 0.7 Vp-p/75  $\Omega$  (PB/PR)
- Maximum Input Level .....1.5 Vp-p or more
- Signal to Noise Ratio ..... 50 dB or more
- Frequency Response [MONITOR OUT]  
Component ..... 5 Hz to 60 MHz,  $\pm$ 3 dB

### ■ FM SECTION

- Tuning Range  
[U.S.A. and Canada models] ..... 87.5 to 107.9 MHz  
[Asia and General models] ..... 87.5/87.50 to 108.0/108.00 MHz  
[Other models] ..... 87.50 to 108.00 MHz
- 50 dB Quieting Sensitivity (IHF)  
Mono .....3.0  $\mu$ V (20.8 dBf)
- Signal to Noise Ratio (IHF)  
Mono/Stereo ..... 74 dB/69 dB
- Harmonic Distortion (1 kHz)  
Mono/Stereo .....0.3/0.3%
- Antenna Input (unbalanced) ..... 75  $\Omega$

### ■ AM SECTION

- Tuning Range  
[U.S.A. and Canada models] .....530 to 1710 kHz  
[Asia and General models] ..... 530/531 to 1710/1611 kHz  
[Other models] .....531 to 1611 kHz

### ■ GENERAL

- Power Supply  
[U.S.A. and Canada models] ..... AC 120 V, 60 Hz  
[General models] ..... AC 110/120/220/230-240 V, 50/60 Hz  
[China model] ..... AC 220 V, 50 Hz  
[Korea model] ..... AC 220 V, 60 Hz  
[Australia model] ..... AC 240 V, 50 Hz  
[U.K. and Europe models] ..... AC 230 V, 50 Hz  
[Asia models] ..... AC 220/230-240 V, 50/60 Hz
- Power Consumption  
[U.S.A. and Canada models] .....270 W/320 VA  
[Other models] ..... 280 W
- Standby Power Consumption  
HDMI Control off / Standby Through off .....0.2 W or less  
HDMI Control on / Standby Through off .....1.2 W or less  
HDMI Control on/ Standby Through on .....3 W or less
- Dimensions (W x H x D)  
435 x 151 x 364 mm (17-1/8 x 6 x 14-3/8 in)
- Weight  
8.4 kg (18.5 lbs)

\* Specifications are subject to change without notice.





## Index

## Numerics

5.1-channel speaker layout.....	10
6.1-channel speaker layout.....	10
7.1-channel speaker layout.....	10

## A

Adaptive DRC, Sound Setup .....	53
Advanced Setup menu .....	65
AM antenna connection .....	22
AM tuning.....	34
Audio In, Option menu .....	46
AUDIO jack .....	14
Audio Return Channel function.....	69
Audio, HDMI Setup.....	56
Auto Preset.....	35
Auto Preset, Option menu.....	47
Automatic traffic information reception .....	38
AutoPowerDown, Func. Setup .....	58

## B

BD player connection .....	17
Bluetooth™ component playback.....	42

## C

Cable plug .....	14
Center speaker.....	9
Changing speaker impedance .....	12
CINEMA DSP indicator .....	7
Clear Preset, Option menu .....	47
COAXIAL jack.....	14
COMPONENT VIDEO jack.....	14
Config, Speaker Setup .....	49
Connect, Option menu .....	47
Connecting speakers .....	11
Connections.....	9
Control, HDMI Setup.....	55
Cursor indicators.....	7

## D

D.Range, Sound Setup .....	54
Decoder Mode, Option menu.....	45
Dimmer, Func. Setup .....	58
Direct mode.....	31
Disconnect, Option menu.....	47
Distance, Speaker Setup.....	51
DSP Parameter .....	59
DVD player connection.....	17

## E

Equalizer, Speaker Setup .....	51
EXTD Surround, Option menu .....	45
External component connection.....	14

## F

FM antenna connection .....	22
FM Mode, Option menu.....	47
FM tuning.....	34
Front panel .....	5
Front panel display.....	7
Front speaker.....	9
Func. Setup.....	57

## H

HDMI Control function.....	67
HDMI indicator.....	7
HDMI jack .....	14
HDMI Setup.....	54
High-frequency sound adjustment .....	28

## I

Init Volume, Sound Setup.....	54
INIT, Advanced Setup menu.....	66
Input Rename, Func. Setup .....	57
iPhone™ playback .....	39
iPod™ playback.....	39

## J

Jack.....	14
-----------	----

## L

Level, Speaker Setup.....	51
Lipsync, Sound Setup.....	53
Low-frequency sound adjustment .....	28

## M

Manual Preset .....	36
Max Volume, Sound Setup .....	54
Memory Guard .....	58
Multi information display.....	7
MUTE indicator .....	7

## N

Normal tuning.....	34
--------------------	----

## O

OPTICAL jack .....	14
Option menu .....	44

## P

Pairing, Option menu .....	47
PHONES jack.....	5
Portable audio player connection .....	21
PORTABLE jack.....	14
Preset tuning .....	35

## R

Radio Data System tuning.....	37
Rear panel.....	6
Remote control .....	8
Remote control battery installation .....	4
Remote control, Controlling other components .....	62
REMOTE ID, Advanced Setup menu .....	66
Repeat playback, iPod/iPhone.....	41



Repeat, Option menu .....	47	VOLTAGE SELECTOR.....	6
ReturnChan, HDMI Setup .....	55	VOLUME.....	5
<b>S</b>		VOLUME indicator .....	7
SCENE function.....	29	Volume Trim, Option menu .....	45
Setup menu.....	48	<b>Y</b>	
Shuffle playback, iPod/iPhone.....	41	YPAO.....	23
Shuffle, Option menu.....	47		
Signal Info, Option menu.....	46		
Sound field program .....	29		
Sound field program parameter setting.....	59		
Sound Setup .....	53		
SP IMP., Advanced Setup menu.....	65		
Speaker connection .....	9		
Speaker indicators.....	7		
Speaker layout.....	10		
Speaker setting .....	23		
Speaker Setup.....	49		
Standby Charge, Option menu .....	47		
Standby, HDMI Setup.....	55		
Straight decoding mode .....	30		
Subwoofer .....	9		
Supplied accessories .....	4		
Surround back speaker .....	9		
Surround back speaker connection .....	11		
Surround speaker .....	9		
<b>T</b>			
Test Tone, Speaker Setup .....	52		
Tone control .....	28		
TrafficProgram, Option menu.....	47		
TU, Advanced Setup menu .....	66		
Tuner indicator.....	7		
TV monitor connection .....	15		
TVAudio, HDMI Setup .....	55		
<b>V</b>			
VIDEO AUX input cover .....	4		
Video cameras connection .....	21		
VIDEO jack .....	14		





**List of remote control codes**  
**Liste des codes de commande**  
**Liste der Fernbedienungscodes**  
**Lista över fjärrstyrningskoder**  
**Elenco dei codici di telecomando**

**Lista de códigos de mando a distancia**  
**Lijst met afstandsbedieningscodes**  
**Список кодов дистанционного управления**  
**遥控器代码列表**  
**리모콘코드목록**

<b>TV</b>		Axion	0156	Condor	0161, 0277, 0320, 0323, 0342, 0350, 0351	Elin	0277, 0320, 0323, 0342, 0349, 0350
A.R. Systems	0320	Baird	0282	Contec	0179, 0277, 0323, 0342, 0343, 0344	Elite	0320, 0340, 0350
Acme	0342	Bang & Olufsen	0180, 0339	Contec/Cony	0012, 0058	Elman	0341
Acura	0323, 0343	Basic Line	0282, 0320, 0323, 0340, 0343, 0350	Continental Edison	0345	Elta	0277, 0323, 0343
ADC	0337	Bastide	0282, 0342	Cosmel	0323, 0343	Emerson	0000, 0007, 0008, 0012, 0013, 0019, 0026, 0031, 0037, 0051, 0058, 0059, 0161, 0179, 0320, 0339
Admiral	0054, 0178, 0336, 0337, 0339, 0346, 0347	Baur	0320, 0349	Craig	0058, 0179	Emprex	0154
Advent	0158	Bazin	0282	Crosley	0010, 0037, 0171, 0339	Envision	0008, 0026, 0050
Adventura	0057	Beko	0161, 0269, 0294, 0302, 0311, 0320, 0328, 0351	Crown	0058, 0161, 0171, 0179, 0320, 0323, 0343, 0349, 0350, 0351	Epson	0155, 0206, 0359
Adyson	0277, 0282, 0342	Belcor	0008	CS Electronics	0277, 0340, 0342	Erres	0320, 0349, 0350
Agashi	0277, 0282	Bell & Howell	0019, 0054	CTC Clatronic	0341	ESA	0051
Agazi	0337	Benq	0097, 0242, 0361	CTX	0205	ESC	0282
Aiko	0277, 0282, 0320, 0323, 0342, 0343	Beon	0320, 0349, 0350	Curtis Mathes	0007, 0008, 0010, 0019, 0021, 0026, 0049, 0050, 0178	Etron	0343
Aim	0320	Best	0161	CXC	0058, 0179	Eurofeel	0282
Aiwa	0078, 0379	Bestar	0161, 0320, 0350	Cybertron	0340	Euro-Feel	0337
Akai	0050, 0055, 0109, 0159, 0181, 0277, 0282, 0320, 0323, 0340, 0343, 0349, 0350	Binatone	0282, 0342	Cytron	0152	Euroline	0349
Akiba	0320, 0340	Blue Sky	0320, 0340	Daewoo	0007, 0008, 0026, 0037, 0053, 0167, 0266, 0275, 0277, 0282, 0315, 0320, 0323, 0331, 0335, 0342, 0343, 0350, 0381, 0465	Euroman	0161, 0277, 0282
Akura	0320, 0323, 0337, 0340	Blue Star	0348	Dainichi	0277, 0340	Euromann	0320, 0337, 0342, 0350
Alaron	0277	Boots	0282, 0342	Dansai	0277, 0282, 0320, 0337, 0349, 0350	Expert	0321
Alba	0161, 0277, 0320, 0323, 0340, 0342, 0343, 0344, 0349, 0351, 0372, 0382	BPL	0320, 0348	Dantax	0161, 0349	Exquisit	0320
Albatron	0140	Bradford	0058, 0179	Dawa	0320	Fenner	0323, 0343
Alcyon	0171	Brandt	0322, 0345	Daytron	0007, 0008, 0026, 0323, 0343	Ferguson	0322, 0345, 0349
Alleron	0059	Brilliant	0182	De Graaf	0346	Fidelity	0277, 0320, 0342, 0346
Allorgan	0282	Brinkmann	0320	Decca	0282, 0320, 0342, 0349, 0350	Filsai	0282
Allstar	0320, 0350	Brionvega	0320, 0339, 0349, 0350	Dell	0145, 0245	Finlandia	0346
America Action	0179	Britannia	0277, 0282, 0342	Denver	0358, 0362	Finlux	0171, 0282, 0320, 0339, 0341, 0342, 0349, 0350
AMOi	0276	Brockwood	0008	Desmet	0320, 0349, 0350	FIRST LINE	0342, 0343, 0350
Amplivision	0161, 0282, 0321, 0342	Broksonic	0109, 0179	Diamant	0320	Firstline	0277, 0282, 0320, 0323
Amstrad	0320, 0323, 0337, 0340, 0343	Bruno	0339	Diamond	0277	Fisher	0019, 0161, 0282, 0339, 0342, 0344, 0351
Amtron	0058	BTC	0340	DiamondVision	0135, 0143	Flint	0320, 0350
Anam	0179, 0343	Bush	0269, 0282, 0283, 0304, 0320, 0323, 0328, 0332, 0340, 0343, 0344, 0346, 0348, 0349, 0350, 0372, 0382, 0463, 0470, 0472	Dimensia	0049	Formenti	0171, 0277, 0336, 0339, 0342, 0349
Anam National	0052, 0058	Capsonic	0337	Disney	0219	Formenti/Phoenix	0277
Anglo	0323, 0343	Carena	0320	Dixi	0282, 0320, 0323, 0343, 0349, 0350	Fortress	0366, 0339
Anitech	0171, 0320, 0323, 0337, 0343	Carnivale	0050	Dream Vision	0461, 0498	Fraba	0161, 0320
Ansonic	0161, 0168, 0320, 0323, 0341, 0343	Carrefour	0344	DTS	0323, 0343	Friac	0161
AOC	0008, 0026, 0050, 0053	Carver	0010	Dual	0282, 0320, 0342	Frontech	0282, 0323, 0337, 0343, 0346, 0347
Apex	0039, 0111, 0217	Cascade	0320, 0323, 0343	Dual-Tec	0342, 0343	Fujitsu	0059, 0069, 0074, 0075, 0282
Arcam	0277, 0282	Casio	0367	Dumont	0008, 0030, 0062, 0282, 0339, 0341, 0342	Fujitsu General	0282
Arcam Delta	0342	Cathay	0320, 0349, 0350	Durabrand	0031, 0051, 0179, 0215	Fujitsu Siemens	0504, 0505, 0507, 0510, 0511
Aristona	0320, 0349, 0350	CCE	0183, 0282	Dux	0349	Funai	0051, 0058, 0059, 0112, 0113, 0115, 0118, 0119, 0179, 0337
Arthur Martin	0321	Celebrity	0055, 0107	Dwin	0178	FUTURETECH	0058, 0179
ASA	0339, 0347	Celera	0039	Dynatron	0320, 0349, 0350	Galaxi	0320, 0351
Asberg	0171, 0320, 0350	Centurion	0320, 0349, 0350	Dynex	0228, 0231	Galaxis	0161, 0320
Astra	0343	Century	0339	Elbe	0161, 0168, 0282, 0320	Gateway	0176, 0177, 0241
Asuka	0277, 0282, 0337, 0340, 0342	CGE	0161, 0171	Elcit	0339	GBC	0323, 0343, 0344
Atlantic	0277, 0320, 0342, 0349, 0350	Changhong	0039	Electa	0348	GE	0008, 0021, 0023, 0026, 0027, 0031, 0034, 0049, 0052, 0056, 0209
Atori	0323, 0343	Chime	0273	ELECTRO TECH	0343	Geant Casino	0321
Auchan	0321	Cimline	0323, 0343	Electroband	0055, 0107	GEC	0282, 0320, 0342, 0347, 0349, 0350
Audiosonic	0161, 0282, 0320, 0340, 0342, 0343, 0349, 0350	Citizen	0007, 0008, 0026, 0050, 0058	Electrograph	0176	Geloso	0323, 0343, 0346
AudioTon	0161, 0282, 0342	City	0323, 0343	Electrohome	0008, 0026, 0052, 0055	General Technic	0323, 0343
Audiovox	0058, 0179, 0194	Clarion	0179	Element	0230		
Ausind	0171	Clarivox	0349				
Autovox	0171, 0282, 0337, 0339, 0342	Clatronic	0161, 0171, 0282, 0320, 0323, 0337, 0340, 0342, 0343, 0350, 0351				
Aventura	0051	CMS	0277				
Awa	0277, 0282	CMS Hightec	0282				
		Coby	0197				
		Colortyme	0008, 0026				
		Commercial Solutions	0021				
		Concerto	0008, 0026				
		Concorde	0323, 0343				

Genexxa	0320, 0340, 0347, 0350	Infinity	0010	Lifetec	0320, 0323, 0337, 0343	Multitech	0058, 0161, 0179, 0183, 0277, 0282, 0320, 0323, 0341, 0342, 0343, 0344, 0346, 0349
GFM	0128, 0227	InFocus	0250, 0327, 0363, 0479, 0508	Lloyds	0323		
Giant	0282	Ingelen	0347	Loewe	0161, 0168, 0265, 0320, 0330, 0352		
Gibraltar	0008, 0030, 0050, 0062	Ingersol	0323, 0343	Loewe Opta	0339, 0349, 0350	Murphy	0277, 0342
GoldHand	0277	Initial	0153	Logik	0054	NAD	0026, 0031, 0111
Goldline	0320	Inno Hit	0171, 0282, 0320, 0323, 0340, 0342, 0343, 0349, 0350	Luma	0320, 0323, 0346, 0349	Naonis	0346
GoldStar	0007, 0008, 0012, 0026, 0031, 0050, 0053, 0161, 0277, 0282, 0320, 0323, 0342, 0343, 0346, 0349, 0350	Innovation	0337, 0343	Lumatron	0282, 0320, 0346, 0349, 0350	NEC	0008, 0026, 0050, 0052, 0053, 0072, 0103, 0282, 0344
Goodmans	0246, 0272, 0282, 0320, 0323, 0337, 0343, 0344, 0349, 0350, 0462, 0473, 0477	Insignia	0131, 0228, 0236, 0238	Lux May	0350	Neckermann	0161, 0282, 0320, 0339, 0342, 0346, 0349, 0350, 0351
Gorenje	0161, 0351	Inteq	0030	Luxman	0008, 0026		
GPM	0340	Interactive	0161	Luxor	0282, 0342, 0346	NEI	0320, 0349, 0350
GPX	0129	Interbuy	0323, 0343	LXI	0010, 0019, 0021, 0026, 0027, 0031, 0049, 0111	Net-TV	0176
Gradiente	0240	Interfunk	0161, 0320, 0339, 0347, 0349, 0350	M Electronic	0342, 0343, 0345, 0347, 0349, 0350	Neufunk	0320, 0323
Graetz	0347	International	0277	MAG	0096	New Tech	0343, 0350
Granada	0171, 0282, 0320, 0321, 0342, 0344, 0346, 0349, 0350	Intervision	0161, 0282, 0320, 0337, 0341, 0342	Magnadyne	0339, 0341, 0349	New World	0340
Grandin	0340, 0343, 0348, 0349	Irradio	0171, 0320, 0323, 0340, 0343, 0349, 0350	Magnafon	0171, 0277, 0341, 0342	NewTech	0282, 0320, 0323
Gronic	0282	Isukai	0320, 0340	Magnavox	0008, 0009, 0010, 0013, 0026, 0032, 0033, 0048, 0050, 0128, 0211, 0212, 0224, 0226, 0239	Nicamagic	0277, 0342
Grundig	0160, 0161, 0171, 0310, 0320	ITC	0282, 0342			Nikkai	0277, 0282, 0320, 0323, 0337, 0340, 0342, 0349, 0350
Grunpy	0058, 0059, 0179	ITS	0277, 0320, 0340, 0348, 0350	Magnum	0337, 0343	Nikko	0266, 0031, 0050
Haier	0157, 0233	ITT	0343, 0347	Majestic	0054	Noblika	0171, 0277, 0341, 0342
Halifax	0277, 0282, 0337, 0342	ITV	0320, 0343, 0349	Mandor	0337	Nokia	0347
Hallmark	0008, 0026, 0031	Janeil	0057	Manesth	0282, 0320, 0337, 0342, 0349, 0350	Norcent	0201
Hampton	0277, 0282, 0342	JBL	0010	Marantz	0008, 0010, 0026, 0050, 0204, 0320, 0349, 0350	Nordic	0282
Hanseatic	0161, 0168, 0282, 0320, 0323, 0342, 0343, 0344, 0349, 0350	JC Penney	0007, 0008, 0026, 0027, 0049, 0053, 0056	Marelli	0339	Nordmende	0339, 0345, 0347, 0350
Hantarex	0320, 0323, 0343	JCB	0055, 0107	Mark	0277, 0282, 0320, 0323, 0349, 0350	Nordvision	0349
Hantor	0320	Jensen	0008, 0026	Masuda	0282	Novatronic	0320
Harman/Kardon	0010	JVC	0012, 0014, 0015, 0056, 0064, 0065, 0067, 0169, 0174, 0297, 0314, 0344, 0350, 0375	Matsui	0282, 0320, 0323, 0342, 0343, 0344, 0346, 0349, 0350, 0455	Oceanic	0321, 0347
Harvard	0058, 0179	Kaisui	0277, 0282, 0320, 0323, 0340, 0342, 0343, 0348	Matsushita	0017	Okano	0161, 0320, 0351
Harwood	0320, 0323	Kamosonic	0342	Maxent	0147, 0176	Olevia	0102, 0199, 0200, 0207, 0222
Havermy	0178	Kamp	0277, 0342	Mediator	0320, 0349, 0350	ONCEAS	0342
HCM	0282, 0320, 0323, 0337, 0342, 0343, 0348	Kapsch	0347	Medion	0320, 0337, 0343	Onwa	0058, 0179
Hema	0282, 0323	Karcher	0161, 0320, 0342, 0343, 0349	Megapower	0140	Opera	0320
Hewlett Packard	0192	Kawasho	0008, 0026, 0055, 0277	Megatron	0026, 0031	Oppo	0130
Higashi	0277	KEC	0179	MElectronic	0277, 0282, 0320, 0323	Optimus	0017, 0019
HiLine	0320	Kendo	0161, 0320, 0341, 0346	Melvox	0321	Optoma	0144
Hinari	0320, 0323, 0340, 0343, 0344, 0349, 0350	Kenwood	0008, 0026, 0050	Memorex	0019, 0026, 0031, 0053, 0054, 0137, 0215, 0323, 0343	Optonica	0178
Hisawa	0321, 0340, 0348	KIC	0282			Orbit	0320, 0350
Hisense	0247	Kingsley	0277, 0342	Memphis	0323, 0343	Orion	0043, 0146, 0283, 0320, 0323, 0328, 0343, 0349, 0350
Hitachi	0008, 0012, 0026, 0066, 0084, 0092, 0093, 0120, 0172, 0173, 0255, 0270, 0271, 0282, 0320, 0335, 0338, 0342, 0344, 0346, 0347, 0365, 0382, 0448, 0456, 0467	KLH	0039	Mercury	0320, 0323	Online	0320
Hornymphon	0320, 0350	Kloss Novabeam	0057, 0058	Metz	0339	Osaki	0282, 0320, 0337, 0340, 0342
Hoshai	0340	Kneissel	0161, 0168, 0320	MGA	0008, 0026, 0031, 0050, 0053	Oso	0340
Huanyu	0277, 0342	Kolster	0320, 0350	Micromaxx	0337, 0343	Otto Versand	0282, 0320, 0336, 0342, 0344, 0348, 0349, 0350
Hygashi	0277, 0282, 0342	Konka	0340	Microstar	0337, 0343	Pael	0277, 0342
Hyper	0277, 0282, 0323, 0342, 0343	Korting	0161, 0339	Midland	0007, 0021, 0023, 0027, 0030, 0056, 0062	Palladium	0161, 0282, 0320, 0342, 0351
Hypson	0282, 0320, 0321, 0337, 0342, 0348, 0349, 0350	Kosmos	0320	Minerva	0171	Panasonic	0282
Hyundai	0141	Koyoda	0343	Minoka	0320, 0350	Panama	0277, 0282, 0320, 0323, 0337, 0342, 0343
Iberia	0320	KTV	0007, 0050, 0058, 0179, 0183, 0282, 0342	Mintek	0153		
ICE	0277, 0282, 0320, 0323, 0337, 0340, 0342, 0343, 0350	Kyoto	0277, 0282	Mitsubishi	0008, 0026, 0031, 0053, 0066, 0084, 0093, 0098, 0150, 0178, 0289, 0320, 0339, 0344, 0350, 0376	Panasonic	0016, 0017, 0020, 0022, 0023, 0035, 0052, 0056, 0084, 0085, 0133, 0163, 0193, 0284, 0286, 0290, 0292, 0320, 0325, 0347, 0356
ICeS	0277	Lasat	0161	Mivara	0161, 0168, 0171, 0277, 0282, 0342	Panavision	0320
Ilo	0148, 0153	Lenco	0323, 0343	Monivision	0140	Pathe Cinema	0161, 0168, 0277, 0321, 0342
IMA	0058	Lenoir	0323, 0342, 0343	Montgomery Ward	0054	Pausa	0323, 0343
Imperial	0161, 0171, 0320, 0347, 0350, 0351	Leyco	0320, 0337, 0349, 0350	Motion	0171	Penney	0021, 0023, 0031, 0050, 0111
Indiana	0320, 0349, 0350	LG	0031, 0053, 0066, 0116, 0117, 0140, 0161, 0164, 0175, 0195, 0269, 0277, 0282, 0300, 0309, 0317, 0320, 0323, 0328, 0342, 0343, 0346, 0349, 0350, 0366, 0368, 0377, 0466, 0471, 0478	Motorola	0052, 0178	Perdio	0277, 0320
		LG/GoldStar	0164	MTC	0008, 0026, 0050, 0053, 0161, 0277	Perfekt	0320
		Liesenk	0349	Multi System	0349	Philco	0008, 0009, 0010, 0012, 0026, 0050, 0052, 0053, 0161, 0171, 0320, 0339
		Liesenkotter	0320			Philharmonic	0282, 0342
		Life	0337, 0343			Philips	0008, 0009, 0010, 0011, 0012, 0032, 0048, 0049, 0052, 0122, 0128, 0134, 0186, 0187, 0213, 0221, 0224, 0226,

	0239, 0256, 0257, 0259, 0261, 0263, 0267, 0280, 0281, 0287, 0296, 0299, 0301, 0303, 0305, 0313, 0319, 0320, 0324, 0333, 0339, 0342, 0349, 0350, 0353, 0357, 0360, 0380, 0383, 0452, 0459, 0460	Philips Magnavox Phoenix	0011, 0032, 0033 0161, 0277, 0320, 0339, 0349, 0350 0277, 0320, 0339, 0349, 0350	Phonola		Pilot Pioneer	0007, 0008, 0050 0008, 0026, 0094, 0095, 0161, 0320, 0345, 0347, 0349, 0350, 0458	Plantron	0320, 0323, 0337, 0350	Playsonic	0282	Polaroid	0039, 0142, 0202, 0234	Poppy Portland	0323, 0343 0007, 0008, 0026, 0053	Prandoni-Prince Precision Prima	0171, 0346 0282, 0342 0157, 0243, 0323, 0343, 0347	Princeton Prism Profex Profi-Tronic Proline Proscan Prosonic	0140 0023, 0056 0323, 0343 0320, 0350 0320, 0350 0021, 0027, 0049 0161, 0277, 0282, 0320, 0342, 0349 0282, 0337, 0341, 0342, 0343, 0349, 0350	Proton	0008, 0012, 0026, 0031	Protron PROVIEW Provision Pulsar Pye	0196 0096, 0246 0320, 0349 0008, 0030, 0062 0256, 0320, 0349, 0350, 0378	Pymi Quandra Vision Quasar	0323, 0343 0321 0017, 0023, 0052, 0056	Quelle	0282, 0320, 0337, 0342, 0349, 0350	Questa Radialva RadioShack	0344 0320 0019, 0021, 0031, 0050, 0179, 0320	RadioShack/Realistic	0007, 0008, 0012, 0026, 0049, 0058 0282, 0320, 0349, 0350	Radiola	0320, 0339 0161, 0320, 0323, 0350	Radiomarelli Radiotone	0320, 0339 0161, 0320, 0323, 0350	Rank RCA	0344 0008, 0021, 0024, 0025, 0026, 0027, 0042, 0049, 0052, 0053, 0063, 0136, 0225	Realistic	0019, 0031, 0050, 0179	Recor Redstar Reflex Revox	0320 0320 0320 0161, 0320, 0349, 0350	Rex RFT Rhapsody R-Line Roadstar	0337, 0346, 0347 0161, 0168, 0339 0277 0320, 0349, 0350 0323, 0337, 0340, 0343	Robotron Rowa Royal Lux RTF Runco Saba	0339 0277, 0282 0161 0339 0030, 0050, 0062 0298, 0322, 0339, 0345, 0347	Saisho Salora Sambers Sampo	0282, 0323, 0337, 0342, 0343 0346, 0347 0171, 0341 0007, 0008, 0026, 0050, 0176	Samsung	0004, 0005, 0006, 0007, 0008, 0012, 0026, 0031, 0036, 0050, 0053, 0076, 0077, 0079, 0114, 0124, 0125, 0126, 0127, 0139, 0161, 0183, 0185, 0190, 0191, 0258, 0264, 0277, 0282, 0320, 0323, 0334, 0337, 0342, 0343, 0349, 0350, 0351, 0373, 0453, 0468	Sandra Sansui Sanyo	0277, 0282, 0342 0043, 0109, 0320, 0350 0008, 0019, 0068, 0070, 0071, 0099, 0161, 0168, 0223, 0237, 0277, 0282, 0288, 0295, 0323, 0342, 0344, 0369, 0469	SBR Sceptre Schaub Lorenz Schneider	0320, 0349 0235, 0244 0347 0282, 0316, 0318, 0320, 0333, 0340, 0342, 0349, 0350, 0382	Scotch Scott	0026, 0031 0008, 0012, 0026, 0031, 0058, 0059, 0149, 0179	Sears	0008, 0010, 0019, 0021, 0026, 0027, 0031, 0049, 0051, 0059, 0111	SEG	0277, 0282, 0320, 0323, 0337, 0341, 0342, 0344, 0349, 0382	SEI SEI-Sinudyne Seleco Sencora Sentra Serino Sharp	0320 0339, 0341, 0347 0344, 0346, 0347 0323, 0343 0323 0277 0000, 0001, 0002, 0003, 0007, 0008, 0012, 0026, 0060, 0088, 0089, 0091, 0138, 0165, 0170, 0178, 0198, 0229, 0262, 0278, 0279, 0291, 0308, 0312, 0336, 0344, 0354, 0370, 0449, 0450, 0451, 0464, 0474, 0476	Sheng Chia Shogun Siarem Sierra Siesta Signature Silva Silver Singer Sinudyne	0178 0008 0320, 0339, 0341 0320, 0350 0161 0054 0277 0344 0321, 0339, 0341 0320, 0339, 0341, 0349	Skantic Solavox Sonitron	0347 0347 0161, 0282	Sonoko	0282, 0320, 0323, 0337, 0342, 0343, 0349, 0350	Sonolor Sontec	0321, 0347 0161, 0320, 0349, 0350	Sony	0038, 0044, 0045, 0047, 0055, 0104, 0105, 0107, 0110, 0123, 0184, 0220, 0248, 0249, 0251, 0252, 0254, 0326, 0343, 0344, 0371, 0374, 0457, 0475 0340, 0341	Sound & Vision Soundesign	0008, 0026, 0031, 0058, 0059, 0179 0320, 0349, 0350	Soundwave Squareview SSS Standard	0051 0008, 0058, 0179 0282, 0320, 0323, 0340, 0342, 0343, 0350	Starlite	0058, 0179, 0320, 0323, 0349	Stenway Stern Strato	0348 0346, 0347 0320, 0323	Stylandia Sunkai Sunstar Sunwood	0282 0343 0320, 0323 0320, 0323, 0343, 0350	Superla Superscan SuperTech Supra Supre-Macy Supreme Susumu Sutron SVA Sydney Sylvania	0277, 0282, 0342 0013, 0178 0277, 0320, 0323 0323, 0343 0057 0055, 0107 0340 0323, 0343 0151 0277, 0282, 0342 0008, 0009, 0010, 0011, 0013, 0026, 0048, 0050, 0051, 0128, 0227, 0253 0051, 0058, 0062, 0128, 0179, 0215	Symphonic	0199	Syntax Syntax-Brilliant Sysline Sytong Tandy	0199 0199 0349 0277 0178, 0282, 0336, 0340, 0342, 0347	Tashiko	0277, 0282, 0342, 0344, 0346	Tatung	0052, 0177, 0282, 0320, 0342, 0349, 0350	TCM Teac Tec	0337, 0343 0282, 0320 0282, 0323, 0342, 0343	Technics TechniSat	0017, 0023, 0056 0274, 0496, 0497, 0499	Techwood	0008, 0023, 0026, 0056	TEDELEX Teknika	0282 0007, 0008, 0010, 0012, 0026, 0053, 0054, 0058, 0059, 0179	Teleavia Telecor Telefunken	0345 0282, 0320 0320, 0322, 0345, 0350	Telegazi Telemeister Telesonic Telestar Teletech	0320 0320 0320 0320 0320, 0323, 0343, 0349	Teleton Televideon Televiso Tensai	0282, 0342 0277 0321 0282, 0320, 0323, 0340, 0343, 0350	Tesmet Tevion Texet	0350 0337, 0343 0277, 0282, 0323, 0342	Thomson	0162, 0188, 0189, 0285, 0320, 0322, 0342, 0345, 0350 0320, 0349	Thorn TMK TNCi Tokai Tokyo Tomashi Toshiba	0008, 0026, 0031 0030 0282, 0320, 0350 0277, 0342 0348 0018, 0019, 0040, 0041, 0046, 0073, 0100, 0103, 0108, 0109, 0111, 0121, 0132, 0166, 0208, 0210, 0214, 0217, 0260, 0268, 0282, 0283, 0293, 0304, 0306, 0307, 0329, 0344, 0355, 0454	Totevision Towada Trakton Trans Continen Transtec Trident Triumph Uher	0007 0282, 0347 0282 0282, 0320 0277 0282 0320 0161, 0171, 0320, 0347, 0350	Ultravox	0277, 0320, 0339, 0341, 0342	Unic Line United Universum	0320 0349 0161, 0171, 0282, 0320, 0337, 0349, 0350, 0351	Univox Vector Research Vestel	0320 0050 0282, 0320, 0346, 0347, 0349, 0350, 0351	Vexa	0320, 0323, 0343, 0349	Victor VIDEOLOGIC Videologique	0015, 0344, 0350 0277 0277, 0282, 0340, 0342	VideoSystem Videotechnic Vidikron Vidtech	0320, 0350 0277, 0282 0010 0008, 0026, 0031, 0053	Viewsonic	0176, 0203, 0232, 0364	Viking Viore Visiola Vision Vizio	0057 0148 0277, 0342 0282, 0320, 0350 0008, 0177, 0218, 0242, 0500, 0501, 0502, 0503, 0506 0320, 0349, 0350 0171, 0320, 0339, 0346, 0347, 0350	Waltham Wards	0282, 0320, 0342 0008, 0009, 0010, 0026, 0031, 0048, 0049, 0050, 0053, 0054, 0059	Watson Watt Radio Waycon Wega Wegavox Weltblick	0320, 0349, 0350 0277, 0341, 0342 0111 0320, 0339, 0344 0323 0282, 0320, 0349, 0350	Westinghouse White Westinghouse	0107, 0216, 0220 0037, 0090, 0277, 0320, 0341, 0342, 0349	Wincom Xrypton	0101, 0106 0320
--	--	-----------------------------	--	---------	--	------------------	---	----------	---------------------------	-----------	------	----------	---------------------------	-------------------	---	---------------------------------------	---	--	---	--------	---------------------------	--	---	----------------------------------	---	--------	---------------------------------------	----------------------------------	---	----------------------	--	---------	---	---------------------------	---	-------------	--	-----------	---------------------------	-------------------------------------	---	--	---	---	---	--------------------------------------	--	---------	---	---------------------------	---	--	---	-----------------	--	-------	---	-----	---	---	---	--	---	--------------------------------	----------------------------	--------	--	-------------------	---	------	---	------------------------------	---	--	--	----------	---------------------------------	----------------------------	----------------------------------	---	---	--	--	-----------	------	--	---	---------	---------------------------------	--------	--	--------------------	---	-----------------------	---	----------	---------------------------	--------------------	---	-----------------------------------	---	--	---	---	---	---------------------------	---	---------	--	--	---	---	---	----------	---------------------------------	----------------------------------	--	-------------------------------------	--	------	---------------------------	--------------------------------------	---	--	---	-----------	---------------------------	---	---	------------------	---	--	---	------------------------------------	--	-------------------	--------------------

Yamaha	0008, 0026, 0050, 0053, 0080, 0081, 0082, 0083, 0086, 0087	DIRECTV	1019, 1105, 1110, 1111, 1113, 1116, 1122	Interfunk	1028	Otto Versand	1028
Yamishi	0282, 0320	Dish Network	1018	Intervision	1009, 1026	Palladium	1008, 1027, 1029, 1031
Yokan	0320	Dishpro	1018	Irradio	1008, 1029, 1031	Panasonic	1000, 1022, 1044, 1055, 1068, 1072, 1085, 1090, 1091, 1120, 1121, 1214
Yoko	0161, 0277, 0282, 0320, 0323, 0337, 0340, 0342, 0343, 0349, 0350	Dual	1009, 1027, 1028	ITT	1027	Pathe Marconi	1027
Yorx	0340	Dumont	1026, 1028	ITV	1009, 1025, 1031	Perdio	1026
Zanussi	0282, 0346	Durabrand	1114	JC Penney	1064, 1065, 1068, 1070, 1071	Philco	1008, 1068
Zenith	0008, 0028, 0029, 0030, 0031, 0054, 0061, 0062	Dynatech	1069	JCL	1068	Philips	1006, 1013, 1028, 1035, 1040, 1045, 1046, 1050, 1058, 1059, 1061, 1068, 1076, 1101, 1110, 1113, 1116, 1117, 1122, 1126, 1210, 1211
<hr/>							
<b>VCR</b>							
ABS	1016	ESC	1009, 1025	Kaisui	1008, 1029	Philips Magnavox	1076
Adventura	1069	Etzuko	1008, 1029	Karcher	1028	Phonola	1028
Adyson	1008	Expressvu	1018	Kendo	1008, 1024, 1025, 1030	Pilot	1071
Aiwa	1024, 1026, 1027, 1069	Ferguson	1027	Kenwood	1027, 1064, 1065	Pioneer	1028, 1036
Akai	1021, 1027	Fidelity	1008, 1026	Korpel	1008, 1029	Polaroid	1088, 1099
Akiba	1008, 1029	Finlandia	1028	Kyoto	1008	Portland	1009, 1025, 1030
Akura	1008, 1027, 1029	Finlux	1026, 1027, 1028	Lenco	1025	Prinz	1026
Alba	1008, 1009, 1024, 1025, 1029, 1030	Firstline	1008, 1024, 1029, 1031	Leyco	1008, 1029	Profex	1029
Alienware	1016	Fisher	1065	LG	1010, 1026, 1031, 1047, 1054, 1056, 1071, 1103, 1221	Proline	1026
Ambassador	1030	Flint	1024	Lifetec	1024	Proscan	1019
American High	1068	Formenti/Phoenix	1028	Linksys	1016	Prosonic	1009, 1024
Amstrad	1008, 1009, 1026	Frontech	1030	Lloyd's	1069	Pulsar	1114
Anitech	1008, 1029	Fuji	1068	Loewe Opta	1028, 1031	Pye	1028, 1102
Apex	1088	Fujitsu	1026	Logik	1008, 1029	Quarter	1065
ASA	1028, 1031	Funai	1026, 1069	Lumatron	1009, 1025	Quartz	1065
Asha	1070	Galaxy	1026	Luxor	1008	Quasar	1068
Asuka	1008, 1026, 1028, 1029, 1031	Garrard	1069	LXI	1071	Quelle	1026, 1028
Audio Dynamics	1064	Gateway	1016	M Electronic	1026	Radialva	1008
Audiosonic	1009	GBC	1029, 1030	Magnavox	1020, 1068, 1114, 1126	RadioShack	1071
Audiovox	1071	GE	1068, 1070	Magnin	1071	RadioShack/Realistic	1065, 1068, 1069, 1070, 1071
Baird	1009, 1025, 1026, 1027	GEC	1028	Manesth	1008, 1029	Radiola	1028
Bang & Olufsen	1017	Geloso	1029	Marantz	1028, 1064, 1065, 1068	Radix	1071
Basic Line	1008, 1009, 1024, 1025, 1029, 1030	General	1030	Mark	1009	Randex	1071
Baur	1028	General Technic	1024	Marta	1071	RCA	1019, 1068, 1070, 1075, 1110, 1113, 1122, 1125
Beaumarck	1070	GOI	1018	Matsui	1024, 1031	Realistic	1065, 1068, 1069, 1070, 1071
Bell & Howell	1065	GoldHand	1008, 1029	Matsushita	1068	ReplayTV	1022, 1123
Bestar	1009, 1025, 1030	Goldstar	1026, 1031, 1064, 1071	Media Center PC	1016	Rex	1027
Black Panther Line	1009, 1025	Goodmans	1008, 1009, 1025, 1026, 1029, 1030, 1031	Mediator	1028	RFT	1008, 1028, 1030
Blaupunkt	1028	Gradiente	1069	Medion	1024	Ricavision	1016
Bondstec	1008, 1030	Graetz	1027	MEI	1068	Roadstar	1008, 1009, 1025, 1029, 1031
Broksonic	1100	Granada	1028	Memorex	1023, 1026, 1031, 1065, 1068, 1069, 1070, 1071, 1098, 1114	Royal	1008
Bush	1008, 1009, 1024, 1025, 1029, 1049, 1051, 1063, 1217	Grandin	1008, 1009, 1025, 1026, 1029, 1030, 1031	Memphis	1008, 1029	Runco	1114
Calix	1071	Grundig	1028, 1029	MGN Technology	1070	Saba	1027
Candle	1070, 1071	Hanseatic	1009, 1028, 1031	Micromaxx	1024	Saisho	1024, 1029
Canon	1068	Harley Davidson	1069	Microsoft	1016	Samsung	1002, 1034, 1041, 1043, 1057, 1060, 1070, 1084, 1110, 1116, 1122, 1124, 1220, 1222
Cathay	1009	Harman/Kardon	1064	Microstar	1024	Samurai	1008, 1030
Catron	1030	Harwood	1008	Migros	1026	Sanky	1114
CGE	1026, 1027	HCM	1008, 1029	Mind	1016	Sansui	1023, 1027, 1106, 1115
Cimline	1008, 1024, 1029	Headquarter	1065	Mitsubishi	1026, 1028, 1079	Sanyo	1032, 1065, 1070
CineVision	1104	Hewlett Packard	1016	Motorola	1068	Saville	1009
Citizen	1070, 1071	Hinari	1008, 1009, 1024, 1029	MTC	1070	SBR	1028
Clatronic	1008, 1030	Hisawa	1024	Multitech	1008, 1026, 1028, 1029, 1030, 1069, 1070	Schaub Lorenz	1026, 1027
Colortyme	1064	Hitachi	1011, 1026, 1027, 1028, 1046, 1062	Murphy	1026	Schneider	1008, 1009, 1024, 1025, 1026, 1028, 1029, 1030, 1031
Condor	1009, 1025, 1030	HNS	1110	NEC	1027, 1064, 1065	Sears	1065, 1068, 1071
Craig	1070, 1071	Howard Computers		Neckermann	1027, 1028	SEG	1008, 1009, 1029
Crown	1008, 1009, 1025, 1029, 1030	HP	1016	NEI	1028	SEI-Sinudyne	1028
Curtis Mathes	1064, 1068, 1070	HTS	1018	Nesco	1008, 1029	Seleco	1027
Cybernex	1070	Hughes	1111, 1113, 1122	Nikkai	1008, 1009, 1030	Sentra	1008, 1030
CyberPower	1016	Hughes Network Systems	1110, 1116	Nikko	1071	Sentron	1008, 1029
Daewoo	1009, 1025, 1030, 1038, 1069, 1223	Humax	1012, 1110, 1113	Niveus Media	1016	Sharp	1003, 1033, 1077, 1107, 1127, 1219
Dansai	1008, 1009, 1029	Hush	1016	Noblex	1070	Shintom	1008, 1029
Dantax	1024	Hypson	1008, 1009, 1024, 1029	Nokia	1009, 1027	Shivaki	1031
Daytron	1009, 1025	iBUYPOWER	1016	Nordmende	1027	Shogun	1070
DBX	1064	Impego	1030	Northgate	1016	Siemens	1031
De Graaf	1028	Imperial	1026	Oceanic	1026, 1027	Silva	1031
Decca	1026, 1027, 1028	Inno Hit	1008, 1009, 1025, 1028, 1029, 1030	Okano	1008, 1009, 1024	Silver	1009
Dell	1016	Innovation	1024	Olympus	1068	Singer	1068
Denko	1008	Instant Replay	1068	Optimus	1071		
DiamondVision	1096	Interbuy	1008, 1031	Orion	1023, 1024, 1051, 1115, 1217		
DigiFusion	1014			Orson	1026		
				Osaki	1008, 1026, 1029, 1031		

Sinudyne	1028	Accurian	2142	Dual	2380	LG	2002, 2033, 2038,
Solavox	1030	Advent	2155, 2251	Durabrand	2136		2057, 2129, 2133,
Sonic Blue	1022, 1123	AEG	2362	DVX	2355		2189, 2191, 2223,
Sonneclair	1008	Airis	2364	Easy Home	2359		2238, 2270, 2288,
Sonoko	1009, 1025	Aiwa	2322	Eclipse	2354		2335, 2373, 2375
Sontec	1031	Akai	2145, 2177, 2179,	E-Dem	2364	Life	2182
Sony	1001, 1016, 1048,		2248	Electrohome	2362	Lifetec	2182
	1053, 1073, 1074,	Akura	2356	Elin	2362	Limit	2355
	1080, 1081, 1082,	Alba	2064, 2165, 2186,	Elta	2341, 2361, 2362	Liquid Video	2158
	1083, 1108, 1118,		2337, 2346	Emerson	2129, 2137, 2150	Liteon	2043, 2051, 2142
	1216	Alco	2149	Enterprise	2129	Loewe	2320
Stack	1016	Alize	2361	Enzer	2380	LogicLab	2355
Stack 9	1016	Allegro	2133	Epson	2247	Magnavox	2025, 2050, 2137,
Standard	1009, 1025	Amitech	2362	ESA	2137		2150, 2159, 2224,
Stern	1009	Amphion MediaWorks	2195	Finlux	2354, 2362, 2367		2230, 2358
STS	1068			Fintec	2377	Magnex	2367
Sunkai	1024	AMW	2195, 2363	Fisher	2134	Majestic	2360
Sunstar	1026	Apex	2030, 2124, 2125,	Funai	2137	Marantz	2328
Suntronic	1026		2126, 2127, 2130,	Gateway	2051	Marquant	2362
Sunwood	1008, 1029		2131	GE	2029, 2131, 2156	Matsui	2148, 2378
Superscan	1020	Apple	2241	Gericom	2351	McIntosh	2199
Sylvania	1020, 1068, 1069,	Arrgo	2138	GFM	2226	Mecotek	2362
	1102, 1126	Asono	2364	Giec	2382	Medion	2182
Symphonic	1008, 1069, 1126	Aspire	2152, 2222	Global Solutions	2355	Memorex	2028, 2145, 2234
Systemax	1016	Astar	2240	Global Sphere	2355	MiCO	2354, 2382
Tagar Systems	1016	ATACOM	2364	Go Video	2133, 2213	Micromaxx	2182
Taisho	1024	Audiovox	2061, 2149	Goodmans	2165, 2280, 2291,	Microsoft	2156
Tandberg	1009	Avious	2367		2358, 2371, 2376,	Microstar	2182
Tandy	1065	Awa	2363		2382	Minoka	2362
Tashiko	1026, 1071	Axion	2249	GPX	2227	Minowa	2367
Tatung	1026, 1027, 1028	Bang & Olufsen	2128	Gradiente	2151	Mintek	2131, 2245
TCM	1015, 1024, 1042	Baze	2367	Graetz	2380	Mitsubishi	2003
Teac	1009, 1069	BBK	2364	Greenhill	2131	Mizuda	2358, 2359
Tec	1008, 1009, 1030	Bellagio	2363	Grundig	2349	Monyka	2380
Technics	1068	Best Buy	2359	Grunkel	2362, 2366	Mustek	2186
Teknika	1068, 1069, 1071	Blaupunkt	2131	GVG	2377	Mx Onda	2354
Teleavia	1027	Blue Parade	2157	H&B	2358	Mystral	2366
Telefunken	1027	Boghe	2382	H.her	2364	Naiko	2362
Teletex	1008, 1009	Brainwave	2362	Haaz	2354, 2355	Nesa	2131
Tenosal	1008, 1029	Brandt	2148, 2188	Haier	2254	Neufunk	2380
Tensai	1008, 1026, 1029,	Broksonic	2145, 2146	Harman/Kardon	2047, 2135	Nevir	2362
	1031	Bush	2064, 2110, 2170,	HiMAX	2359	Next Base	2143
	1024		2268, 2290, 2346,	Hitachi	2062, 2090, 2115,	Nexstech	2243
Tevion	1005, 1027		2358, 2367, 2383		2274, 2282, 2316,	NU-TEC	2383
Thomson	1027	California Audio Labs			2359, 2380	Onkyo	2159, 2368
Thorn	1027			Hiteker	2130	Oopla	2051
Tivo	1108, 1110, 1111,	Cambridge Audio	2354	Home Tech Industries		Oppo	2196, 2255
	1113, 1117, 1118,	CAT	2352, 2353		2364	Optim	2381
	1119, 1122	CAVS	2192	Hyundai	2366	Optimus	2180
TMK	1070	Centrum	2353	Ilo	2245	Orava	2358
Tokai	1008, 1029, 1031	CGV	2354, 2362	Initial	2131, 2245	Orbit	2363
Tonsai	1029	Changhong	2140	Innovation	2182	Orion	2073, 2110
Toshiba	1004, 1016, 1027,	Cinetec	2363	Insignia	2002, 2137, 2253	Oritron	2148, 2158
	1028, 1037, 1049,	CineVision	2133, 2237	Integra	2157	P&B	2358
	1052, 1086, 1087,	Clatronic	2358, 2367	Irradio	2053	Pacific	2355
	1097, 1109, 1112,	Coby	2031, 2046, 2360	iSymphony	2246	Panasonic	2011, 2024, 2034,
	1194	Conia	2383	JBL	2135		2042, 2058, 2062,
Totevision	1070, 1071	Continental Edison		JVC	2020, 2096, 2097,		2066, 2067, 2093,
Touch	1016		2363		2099, 2100, 2101,		2116, 2117, 2118,
Towada	1008, 1029	Crown	2362		2102, 2103, 2106,		2119, 2120, 2121,
Towika	1008, 1029	C-Tech	2355		2107, 2160, 2257,		2122, 2123, 2151,
TVA	1030	Curtis Mathes	2139		2260, 2262, 2263,		2159, 2164, 2166,
Uher	1031	CVG	2377		2321, 2324, 2326,		2167, 2172, 2173,
UltimateTV	1019	CyberHome	2022, 2098, 2138,		2327, 2343, 2464,		2175, 2209, 2214,
Ultravox	1009		2187, 2336		2465, 2468, 2469,		2275, 2277, 2278,
Unitech	1070	Cytron	2244		2471		2281, 2282, 2283,
United Quick Star	1009, 1025	Daenyx	2363	Jwin	2198		2301, 2374, 2470
Universum	1026, 1028, 1031	Daewoo	2001, 2133, 2276,	Kansai	2360	Parasound	2197
Vector Research	1064		2298, 2330, 2362,	Kawasaki	2149	peeKTON	2364
Video Concepts	1064		2363, 2377	Kennex	2362	Philips	2008, 2012, 2025,
Videon	1024	Daewoo International		Kenwood	2041, 2151, 2348		2044, 2050, 2051,
Videosonic	1070		2363	KeyPlug	2362		2053, 2060, 2072,
Viewsonic	1016	Dalton	2357	Kiiro	2362		2108, 2111, 2147,
Voodoo	1016	Dansai	2362, 2381	Kingavon	2358		2159, 2163, 2169,
Wards	1068, 1069, 1070,	Daytek	2184, 2195, 2363	Kiss	2380		2174, 2181, 2185,
	1071	Dayton	2363	KLH	2131, 2149		2230, 2261, 2266,
Weltblick	1031	DEC	2358	Koda	2358		2267, 2286, 2287,
XR-1000	1068, 1069	Decca	2362	Koss	2013, 2148, 2158		2289, 2295, 2300,
Yamaha	1064, 1065	Denon	2059, 2151, 2193,	KXD	2359		2302, 2317, 2328,
Yamashi	1008, 1029		2332	Landel	2143		2338, 2342, 2350,
Yokan	1008, 1029	Denver	2356, 2358, 2360,	Lasonic	2132		2467
Yoko	1008, 1029, 1030,		2370	Lawson	2355	Phonotrend	2367
	1031	Denzel	2380	Lecson	2381	Pioneer	2016, 2017, 2018,
Zenith	1114	Desay	2205	Lenco	2358, 2362, 2367		2019, 2035, 2092,
ZT Group	1016	Diamond	2354, 2355	Lenoxx	2136, 2153		2094, 2095, 2109,
		DiamondVision	2225, 2232				2157, 2180, 2190,
		Disney	2010, 2028				2212, 2269, 2272,
		DK Digital	2339				2299, 2304, 2305,
		Dmtech	2176				2306, 2307, 2308,

## DVD

4Kus 2051



	2309, 2310, 2311, 2344, 2345, 2347, 2379	Sylvania	2012, 2137, 2150, 2178, 2230, 2239
Pointer	2362	Symphonic	2108, 2230
Polaroid	2125, 2215, 2235	Synn	2355
Portland	2362	T.D.E. Systems	2366
Powerpoint	2363	Tatung	2001, 2362
Prima	2252	TCM	2182, 2297
Proceed	2130	Teac	2149, 2333, 2355, 2383
Proscan	2156	Tec	2356
Prosonic	2360, 2377	Technics	2151
Protron	2202	Technika	2362, 2367
Provision	2358	Telefunken	2353
Pye	2144	Tensai	2362
Qwestar	2148	Tevion	2182, 2355, 2357
Raite	2380	Theta Digital	2157
RCA	2021, 2029, 2104, 2105, 2131, 2149, 2156, 2157, 2229	Thomson	2183, 2188, 2334, 2372
RedStar	2356, 2360, 2362	Tokai	2356, 2380
Regent	2153	Top Sucess	2364
Reoc	2355	Toshiba	2032, 2036, 2037, 2039, 2048, 2049, 2054, 2055, 2072, 2073, 2076, 2078, 2079, 2086, 2145, 2159, 2218, 2233, 2256, 2259, 2296, 2369
Rimax	2361	TRANScontinents	2363, 2367
Rio	2133	Transonic	2367
Roadstar	2331, 2358	Trio	2362
Ronin	2363	Trutech	2242
Rotel	2203	TruVision	2359
Rowa	2154, 2383	TSM	2364
Rownsonic	2353	Umax	2361
Saba	2148, 2188	United	2367
Sabaki	2355	Urban Concepts	2159
Saivod	2362	US Logic	2245
Sampo	2141	Venturer	2149
Samsung	2000, 2045, 2077, 2112, 2113, 2114, 2115, 2151, 2200, 2216, 2219, 2228, 2264, 2265, 2271, 2279, 2294, 2303, 2329, 2365	Viewmaster	2364
Sansui	2073, 2145, 2354, 2355, 2362	Vocopro	2206
Sanyo	2134, 2145, 2217, 2292	VocoStar	2207
ScanMagic	2186	Waitec	2364
Schaub Lorenz	2362	Welltech	2382
Schneider	2176	Westinghouse	2063, 2250
Scientific Labs	2355	Wharfedale	2354, 2355
Scott	2161, 2357	Woxter	2361, 2364
Seeltech	2364	Xbox	2156, 2183
SEG	2162, 2355, 2363, 2380	Xlogic	2355, 2362
Sharp	2006, 2040, 2088, 2091, 2182, 2194, 2220, 2221, 2231, 2236, 2293, 2340	XMS	2362
Shinsonic	2245	Xoro	2382
Sigmatek	2359, 2364	Yamada	2051, 2361, 2363
Silva	2356	Yamaha	2056, 2064, 2065, 2080, 2081, 2082, 2083, 2089, 2118, 2151, 2323
Singer	2354, 2355	Yamakawa	2363, 2380
Skymaster	2325, 2355	Yukai	2186
Skyworth	2356	Zenith	2002, 2129, 2133, 2159, 2223
Slim Art	2362		
SM Electronic	2355		
Sonic Blue	2133		
Sontech	2366		
Sony	2004, 2005, 2007, 2009, 2014, 2015, 2023, 2026, 2027, 2052, 2068, 2069, 2070, 2071, 2074, 2075, 2084, 2085, 2087, 2168, 2171, 2208, 2210, 2211, 2258, 2273, 2284, 2285, 2312, 2313, 2314, 2315, 2318, 2319, 2466		
Soundmaster	2355		
Soundmax	2355		
Spectra	2363		
Spectroniq	2201		
Standard	2355		
Star Cluster	2355		
Starmedia	2358, 2364		
Sungale	2204		
Sunkai	2362		
Superscan	2150		
Supervision	2355		

### Blu-ray Disc

LG	2033
Panasonic	2011, 2209, 2214
Pioneer	2212
Samsung	2045, 2113
Sharp	2194, 2220, 2221
Sony	2075
Yamaha	2064

### DVR

Bush	2110
Hitachi	2090
Panasonic	2066, 2067, 2093, 2116, 2117, 2119, 2120, 2122, 2123
Philips	2108, 2111
Pioneer	2016, 2017, 2018, 2019, 2092, 2094, 2095, 2109
RCA	2105
Samsung	2113, 2219
Sharp	2088, 2091
Sony	2084, 2085, 2087
Toshiba	2086
Yamaha	2089, 2118

### DVD Recorder

Aspire	2222
Astar	2240
Broksonic	2146
Go Video	2213
Hitachi	2062
Insignia	2002
Irradio	2053
JVC	2100, 2101, 2106, 2107
LG	2033, 2057, 2223, 2238
Liteon	2043
Panasonic	2011, 2034, 2058, 2062, 2116, 2117, 2119, 2120, 2121, 2123
Philips	2008, 2044, 2050, 2051, 2147
Pioneer	2017, 2035
Pye	2144
Samsung	2000, 2112, 2216
Sansui	2073
Sanyo	2217
Sony	2004, 2005, 2007, 2052, 2068, 2069, 2074, 2208, 2210, 2211
Sylvania	2239
Toshiba	2032, 2036, 2037, 2039, 2049, 2054, 2055, 2076
Yamaha	2056

### Cable

ABC	3002, 3003, 3017, 3066, 3067, 3086, 3093, 3119, 3122
ADB	3020
Adelphia	3081
Alcatel	3016
Americast	3124
Amstrad	3022, 3098
Antronix	3065, 3070
Archer	3070
Arcon	3098
AT&T	3095
Axis	3098
Bell South	3124
Cable Vision	3092
Cabletenna	3065
Cabletime	3104
Cableview	3087
Clearmaster	3127
ClearMax	3127
Clyde Cablevision	3105
Colour Voice	3068
Comcast	3084, 3088, 3117
Comcrypt	3107
Comtronics	3069
Contec	3074
Coolmax	3127
COX	3084
Cryptovision	3110
Director	3084
Eastern	3075
Everquest	3123
Fidelity	3098
Filmnet	3107
Filmnet Cablecrypt	3111
Filmnet Comcrypt	3111
Finlux	3097
Focus	3126
Foxtel	3022
France Telecom	3100, 3101
Freebox	3023
GC Electronics	3070
GE	3066, 3093
GECC	3105
Gemini	3072, 3123
General Instrument	3017, 3025, 3066, 3084, 3090, 3096, 3117
Goldstar	3120
Gooding	3099
Grundig	3098, 3099
Hamlin	3073, 3078
Hirschmann	3097
Hitachi	3066
HomeChoice	3106
Humax	3021, 3080, 3083
ITT Nokia	3097
Jasco	3123
Jerrold	3017, 3018, 3025, 3066, 3072, 3084, 3090, 3096, 3119, 3123
JVC	3099
Kabel Deutschland	3024, 3027, 3121
Macab	3101
Magnavox	3079
Maspro	3099
Matsui	3099
MegaCable	3117
Memorex	3076, 3122
Minerva	3099
Mnet	3107
Motorola	3025, 3026, 3084, 3088, 3090, 3095, 3117
Movie Time	3077, 3109
Mr Zapp	3101
Multichoice	3107
Multitech	3127
NEC	3064
NET Brazil	3085
Nokia	3097
Noos	3101
NSC	3077
Oak	3074
Pace	3006, 3089, 3121
Palladium	3099
Panasonic	3112, 3118, 3122
Paragon	3122
Philips	3068, 3071, 3079, 3099, 3100, 3101, 3103
Pioneer	3001, 3006, 3094, 3098, 3114, 3116, 3120
Popular Mechanics	3126
Proscan	3066, 3093
Pulsar	3122
PVP Stereo Visual Matrix	3018
Quasar	3122
RadioShack	3123, 3127
RCA	3030, 3031, 3087, 3118
Realistic	3070
Reco-ton	3126
Regal	3078
Regency	3075
Rembrandt	3066
Runco	3122
Sagem	3101
Samsung	3069, 3089, 3114, 3120
SAT	3098
Scientific Atlanta	3000, 3001, 3002, 3003, 3006, 3028, 3029, 3081, 3086, 3089, 3094, 3095, 3108
Signal	3072, 3123
Signature	3066
Sony	3092, 3125
Sprucer	3118
Standard Component	3115
Starcom	3017, 3072, 3119, 3123
Stargate	3072, 3123
Starquest	3072, 3123
Supercable	3090
Supermax	3127
Tele+1	3107, 3111
Telepiu	3107
Thomson	3082, 3091
TIME WARNER	3084

Tocom	3067	Commlink	4005	Goldbox	4213	Max	4219
Torx	3017	Comtech	4050	GoldStar	4049	Mediabox	4213
Toshiba	3122	Condor	4008, 4024, 4219	Goodmans	4029, 4002, 4006	Mediamarkt	4011
Tristar	3127	Connexions	4014, 4024	Goodmind	4111	Mediasat	4009, 4213, 4218
Tudi	3102	Conrad	4024, 4215, 4218, 4219	Grandin	4031	Medion	4024, 4008, 4217
Tusa	3072, 3123			Grothusen	4001, 4049	Medison	4217
TV86	3077	Conrad Electronic	4217, 4219	Grundig	4006, 4004, 4015, 4035, 4211, 4218, 4222	Mega	4055, 4053
Unika	3065, 3070	Contec	4050			Memorex	4127
United Cable	3018, 3119	Coolsat	4096	Hänsel & Gretel	4219	Metronix	4031, 4028, 4001, 4004, 4005, 4010, 4217
Universal	3065, 3070	Cosat	4048	Hantor	4001, 4013	Metz	4015
Universon	3097, 3099	Coship	4109	Hanuri	4010	Micro electronic	4218, 4219, 4217
V2	3127	Crown	4011	Hauppauge	4044	Micro Technology	4217
Videoway	3019	Daeryung	4014	Heliocom	4219	MicroGem	4106
View Star	3074, 3077, 3079	Daewoo	4057, 4217	Helium	4219	Micromaxx	4024, 4008
Viewmaster	3127	DDC	4007	Hinari	4007	Microstar	4008
Vision	3127	Delega	4007	Hirschmann	4024, 4015, 4210, 4218, 4219, 4216	Microtec	4217
Visiopass	3097, 3100, 3101	Dew	4050	Hisawa	4013	Minerva	4015
Vortex View	3127	Diamond	4051	Hisense	4016	Mitsubishi	4006, 4015, 4202
Wittenberg	3098	Digiality	4219	Hitachi	4114, 4006, 4199, 4203	Mitsumi	4054
Zenith	3113, 3122, 3124	Digital Stream	4105			Morgan's	4011, 4054, 4055, 4053, 4217
Zentek	3126	DIRECTV	4056, 4064, 4067, 4068, 4070, 4071, 4074, 4107, 4116, 4119, 4121, 4122, 4123, 4127, 4192, 4193, 4194, 4195, 4196, 4197, 4198, 4199, 4200, 4201, 4202, 4203, 4206, 4207, 4221	Homecast	4087, 4084, 4085	Motorola	4090, 4091, 4088, 4019
		Discoverer	4212	Houston	4048	Multichoice	4222
<b>Sattelite</b>		Discovery	4216	HTS	4117	Multitec	4212
AB Sat	4216, 4217	Diseqc	4216	Hughes	4064, 4068, 4194, 4192, 4196, 4202	Muratto	4049
AccessHD	4104	Dish Network	4018, 4065, 4089, 4092, 4094, 4095, 4117	Hughes Network Systems	4071	Mysat	4217
ADB	4220			Humax	4097, 4025, 4030, 4060	Navex	4013
AGS	4216	Dishpro	4018, 4117	Huth	4005, 4011, 4012, 4013, 4050, 4048, 4219, 4223	Neuhaus	4009, 4048, 4218, 4219, 4217
Akai	4053, 4055	Distrisat	4053			Neusat	4217
Alba	4001, 4004, 4006, 4007, 4062, 4217	Ditristrad	4048	Hypson	4031	Next Level	4019
Aldes	4005, 4007, 4010	DNT	4014, 4053, 4055	Ilo	4016	NextWave	4223
Allsat	4048, 4053, 4055	Drake	4072	Imex	4031	Nikko	4011, 4217
Allsonic	4005, 4008, 4024	DStv	4222	Innovation	4008	Nokia	4006, 4040
Alltech	4217	Dune	4024	Insignia	4107	Nordmende	4001, 4006, 4007, 4010, 4052
Alpha	4053	Echostar	4014, 4018, 4065, 4089, 4117, 4217	Intertronic	4011	Nova	4222
Alpha Digital	4104	Einhell	4001, 4005, 4011, 4217, 4218	Intervision	4048, 4219	Novis	4013
Alphastar	4077	Elap	4216, 4217	ITT Nokia	4006	Oceanic	4051
Amitronica	4217	Elekta	4010	Jerrold	4019	Octagon	4001, 4004, 4050
Amstrad	4011, 4035, 4217, 4218	Elsat	4217	Johansson	4013	Okano	4011
Anglo	4217	Elta	4001, 4008, 4024, 4048, 4053, 4055	JOK	4216	Optex	4048
Ankaro	4005, 4008, 4024, 4217	Emanon	4001	JSR	4048	Optus	4213, 4222, 4223
Antron	4001, 4004	Emme Esse	4008, 4024	JVC	4089, 4065, 4117, 4029	Orbitech	4001, 4212, 4213, 4218
Apollo	4001	Engel	4217			OSat	4004
Armstrong	4011, 4053	Ep Sat	4006	Kamm	4217	Otto Versand	4015
Artec	4100	EURIEULT	4031	Kathrein	4015, 4055, 4053, 4063, 4034, 4042, 4215, 4216, 4217	Pace	4006, 4015, 4035, 4043, 4047, 4216
Asat	4053, 4055	Eurodec	4052			Pacific	4051
ASLF	4217	Europan	4053, 4218, 4219	Kathrein Eurostar	4215	Packsat	4216
Astacom	4216	Europhon	4219	Klap	4216	Palcom	4007
Astra	4009, 4011, 4054, 4217, 4219	Eurosats	4011	Konig	4219	Palladium	4011, 4218
Astro	4004, 4008, 4010, 4015, 4024, 4213, 4218, 4219	Eurosky	4024, 4011, 4008, 4215, 4218, 4219	Kosmos	4049	Palsat	4212, 4218
AudioTon	4004, 4048			KR	4004	Panasat	4222
Aurora	4222	Eurostar	4011, 4215, 4219	Kreiselmeyer	4015	Panasat	4217
Austar	4222	Eutelsat	4217	K-SAT	4217	Panasonic	4121, 4126, 4124, 4006, 4035, 4036, 4221, 4198
Axiel	4216	Exator	4001, 4004	Kyostar	4001	Panda	4006, 4219
Axis	4008, 4009, 4024, 4050	Expressvu	4117	L&S Electronic	4024	Pansat	4125
Best	4008, 4024	Fenner	4024, 4212, 4217	Lasat	4024, 4010, 4008, 4054, 4215, 4212, 4219	Patriot	4216
Blaupunkt	4015	Ferguson	4006, 4052, 4214			Paysat	4127
Blue Sky	4217	Fidelity	4218	Lasonic	4108	PCT	4110
Boca	4011, 4054, 4059, 4217	Finlandia	4006	Lenco	4024, 4001, 4049, 4215, 4219, 4217	Philco	4101
Boston	4216	Finlux	4006	Leng	4013	Philips	4071, 4068, 4127, 4006, 4055, 4053, 4061, 4033, 4213, 4216, 4196, 4202, 4203, 4201, 4206
Brain Wave	4013	FinnSat	4050, 4052	Lennox	4048	Phoenix	4050
Broadcast	4012	Flair Mate	4217	Lenson	4218	Phonotrend	4006, 4005, 4048
Broco	4217	Foxtel	4222	Lexus	4053	Pioneer	4046, 4213
BSkyB	4035, 4041	Freecom	4001, 4049, 4218	LG	4103, 4107, 4049	Polsat	4052
BT	4216	FTEmaximal	4024, 4217	Lifesat	4024, 4008, 4212, 4217	Predki	4013
Bubu Sat	4217	Fuba	4024, 4001, 4008, 4014, 4015, 4055, 4215			Premiere	4048, 4213
Bush	4006, 4045	Galaxis	4024, 4005, 4008, 4009, 4050, 4048, 4215, 4222	Lifetec	4008	Priesner	4011
Cambridge	4218			Lorenzen	4219	Primestar	4076
Canal Satellite	4213			Lorraine	4049	Profile	4216
Canal+	4213			Lupus	4024, 4008	Promax	4006
CaptiveWorks	4099			Luxor	4218	Prosat	4007, 4005
Channel Master	4007, 4110			Lyonnaise	4052	Proscan	4093, 4066, 4122, 4197
Chaparral	4075			Macab	4052	Protek	4051
CHEROKEE	4216			Magnavox	4127, 4101	Proton	4016
Chess	4212, 4217			Manata	4031, 4216, 4217	Provision	4010
CityCom	4006, 4215, 4219			Manhattan	4006, 4010, 4048, 4216		
Clatronic	4013			Marantz	4055		
CNT	4010			Mascom	4010		
Comag	4080, 4081, 4082, 4083, 4086			Maspro	4006, 4217		
				Matsui	4216		

Quadral	4024, 4007, 4005, 4008, 4216	Skinsat	4218	Thomson	4020, 4006, 4052, 4058, 4208, 4215, 4213, 4219, 4216, 4217
Quelle	4015, 4215, 4219	SKR	4217	Thorens	4051
Quiero	4052	Skymaster	4017, 4022, 4005, 4212, 4217	Thorn	4006
RadioShack	4019	Skymax	4055, 4053	Tivax	4104
Radiola	4055, 4053	SkySat	4212, 4218, 4219, 4217	Tivo	4196
Radix	4014, 4037	Skyvision	4048	Tokai	4053
Rainbow	4004	SM Electronic	4212, 4217	Tonna	4006, 4012, 4048, 4218, 4217
RCA	4093, 4066, 4112, 4113, 4118, 4119, 4116, 4122, 4197, 4207	Smart	4215, 4217	Toshiba	4194, 4202, 4203
Realistic	4078	Sony	4067, 4070, 4213	Triad	4049
Redpoint	4009	SR	4011, 4054	Triasat	4218
Redstar	4024, 4008	Star Choice	4019	Triax	4015, 4215, 4218, 4217
RFT	4005, 4055, 4053	Starland	4217	Turnsat	4217
Roadstar	4217	Starring	4013	Tvonic	4214
Roch	4031	Start Trak	4001	Twiner	4031, 4217
Rover	4024, 4217	Strong	4024, 4001, 4004, 4008, 4049, 4222	UEC	4222
Saba	4010, 4215, 4219, 4216	STS	4115	Uher	4212
Sabre	4006	STVI	4031	UltimateTV	4070
Sagem	4023, 4052	Sumida	4011	Uniden	4079, 4127
Sakura	4050	Sunny Sound	4024	Unisat	4011, 4050, 4053
Samsung	4064, 4071, 4069, 4123, 4120, 4003, 4000, 4001, 4032, 4196, 4200	Sunstar	4217	Unitor	4013
SAT	4007, 4218	Supermax	4223	Universum	4015, 4215, 4219
Sat Cruiser	4223	Tandberg	4052	US Digital	4016
Sat Partner	4001, 4004, 4010, 4013, 4049, 4218	Tandy	4004	Variosat	4015
Sat Team	4217	Tantec	4006	Vega	4024
Satcom	4012, 4219	TCM	4008	Ventana	4055, 4053
Satec	4217	Techniland	4012	Viewsat	4098
Satelco	4024	TechniSat	4021, 4026, 4027, 4014, 4053, 4038, 4039, 4212, 4213, 4218	Visiosat	4013, 4048, 4216, 4217
Satford	4012	Technology	4222	Voom	4019
Satmaster	4012	Technosat	4223	Vortec	4001
Satplus	4212	Technowelt	4219	Welltech	4212
Schneider	4008, 4212, 4216	Teco	4011, 4054	WeTeKom	4212, 4218
Schwaiger	4051, 4212, 4219	Telanor	4007	Wevasat	4006
SCS	4215	Telasat	4215, 4219	Wewa	4006
Seemann	4011, 4009, 4014	Telecom	4217	Winersat	4013
SEG	4024, 4001, 4008, 4013	Telefunken	4017, 4001, 4216	Wisi	4006, 4014, 4015, 4218, 4219
Seleco	4048	Teleka	4004, 4011, 4014, 4218, 4219	Woorisat	4010
Servi Sat	4031, 4217	Telemaster	4010	Worldsat	4216
Siemens	4015	Telesat	4219	Xrypton	4024
Silva	4049	Telestas	4212, 4213, 4218	XSat	4217
Skantin	4217	Televs	4006, 4218	Zehnder	4024, 4010, 4008, 4209, 4215
Skardin	4009	Telewire	4048	Zenith	4102, 4107, 4195
		Tempo	4223	Zodiac	4004
		Tevion	4008, 4217		

---

## CD

Yamaha 5082, 5095

---

## CD Recorder

Yamaha 5083

---

## MD

Yamaha 5080, 5081, 5086

---

## Tape

Yamaha 5084, 5087

---

## Tuner

Yamaha 5066, 5071, 5085, 5088, 5090, 5092, 5094

---

## XM

Yamaha 5091, 5093

---

## SIRIUS

Yamaha 5064, 5067

---

## DOCK

Yamaha 5068, 5089

---

## NET

Yamaha 5076, 5079

---

## LD

Yamaha 2080

---

## Amplifier

Yamaha 5019, 5020



# **RX-V567**

# **RX-V467**

---

**AV Receiver**

**English**

**Safety Brochure**

# IMPORTANT SAFETY INSTRUCTIONS

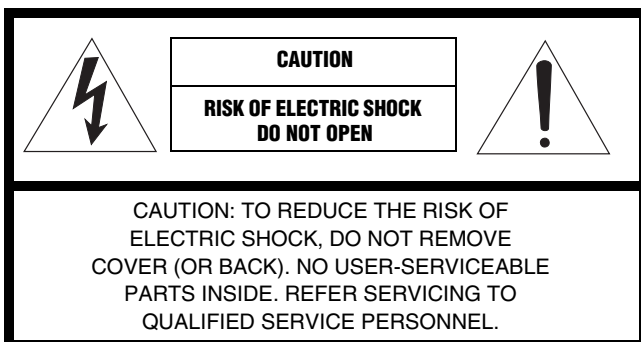

## • Explanation of Graphical Symbols



The lightning flash with arrowhead symbol, within an equilateral triangle, is intended to alert you to the presence of uninsulated “dangerous voltage” within the product’s enclosure that may be of sufficient magnitude to constitute a risk of electric shock to persons.



The exclamation point within an equilateral triangle is intended to alert you to the presence of important operating and maintenance (servicing) instructions in the literature accompanying the appliance.

- 1 Read these instructions.
- 2 Keep these instructions.
- 3 Heed all warnings.
- 4 Follow all instructions.
- 5 Do not use this apparatus near water.
- 6 Clean only with dry cloth.

- 7 Do not block any ventilation openings. Install in accordance with the manufacturer’s instructions.
- 8 Do not install near any heat sources such as radiators, heat registers, stoves, or other apparatus (including amplifiers) that produce heat.
- 9 Do not defeat the safety purpose of the polarized or grounding-type plug. A polarized plug has two blades with one wider than the other. A grounding type plug has two blades and a third grounding prong. The wide blade or the third prong are provided for your safety. If the provided plug does not fit into your outlet, consult an electrician for replacement of the obsolete outlet.
- 10 Protect the power cord from being walked on or pinched particularly at plugs, convenience receptacles, and the point where they exit from the apparatus.
- 11 Only use attachments/accessories specified by the manufacturer.
- 12 Use only with the cart, stand, tripod, bracket, or table specified by the manufacturer, or sold with the apparatus. When a cart is used, use caution when moving the cart/apparatus combination to avoid injury from tip-over.
- 13 Unplug this apparatus during lightning storms or when unused for long periods of time.
- 14 Refer all servicing to qualified service personnel. Servicing is required when the apparatus has been damaged in any way, such as power-supply cord or plug is damaged, liquid has been spilled or objects have fallen into the apparatus, the apparatus has been exposed to rain or moisture, does not operate normally, or has been dropped.



## FCC INFORMATION (for US customers)

### 1 IMPORTANT NOTICE: DO NOT MODIFY THIS UNIT!

This product, when installed as indicated in the instructions contained in this manual, meets FCC requirements. Modifications not expressly approved by Yamaha may void your authority, granted by the FCC, to use the product.

- 2 **IMPORTANT:** When connecting this product to accessories and/or another product use only high quality shielded cables. Cable/s supplied with this product **MUST** be used. Follow all installation instructions. Failure to follow instructions could void your FCC authorization to use this product in the USA.

- 3 **NOTE:** This product has been tested and found to comply with the requirements listed in FCC Regulations, Part 15 for Class “B” digital devices. Compliance with these requirements provides a reasonable level of assurance that your use of this product in a residential environment will not result in harmful interference with other electronic devices.

This equipment generates/uses radio frequencies and, if not installed and used according to the instructions found in the users manual, may cause interference harmful to the operation of other electronic devices.

Compliance with FCC regulations does not guarantee that interference will not occur in all installations. If this product is found to be the source of interference, which can be determined by turning the unit “OFF” and “ON”, please try to eliminate the problem by using one of the following measures:

Relocate either this product or the device that is being affected by the interference.

Utilize power outlets that are on different branch (circuit breaker or fuse) circuits or install AC line filter/s.

In the case of radio or TV interference, relocate/reorient the antenna. If the antenna lead-in is 300 ohm ribbon lead, change the lead-in to coaxial type cable.

If these corrective measures do not produce satisfactory results, please contact the local retailer authorized to distribute this type of product. If you can not locate the appropriate retailer, please contact Yamaha Electronics Corp., U.S.A. 6660 Orangethorpe Ave, Buena Park, CA 90620.

The above statements apply **ONLY** to those products distributed by Yamaha Corporation of America or its subsidiaries.

### ⏻ (Power key)

Turns on the power of this unit or sets it to the standby mode.

# CAUTION: READ THIS BEFORE OPERATING YOUR UNIT.

- 1 To assure the finest performance, please read this manual carefully. Keep it in a safe place for future reference.
- 2 Install this sound system in a well ventilated, cool, dry, clean place - away from direct sunlight, heat sources, vibration, dust, moisture, and/or cold. For proper ventilation, allow the following minimum clearances.  
Top: 30 cm, Rear: 20 cm, Sides: 20 cm
- 3 Locate this unit away from other electrical appliances, motors, or transformers to avoid humming sounds.
- 4 Do not expose this unit to sudden temperature changes from cold to hot, and do not locate this unit in an environment with high humidity (i.e. a room with a humidifier) to prevent condensation inside this unit, which may cause an electrical shock, fire, damage to this unit, and/or personal injury.
- 5 Avoid installing this unit where foreign object may fall onto this unit and/or this unit may be exposed to liquid dripping or splashing. On the top of this unit, do not place:
  - Other components, as they may cause damage and/or discoloration on the surface of this unit.
  - Burning objects (i.e. candles), as they may cause fire, damage to this unit, and/or personal injury.
  - Containers with liquid in them, as they may fall and liquid may cause electrical shock to the user and/or damage to this unit.
- 6 Do not cover this unit with a newspaper, tablecloth, curtain, etc. in order not to obstruct heat radiation. If the temperature inside this unit rises, it may cause fire, damage to this unit, and/or personal injury.
- 7 Do not plug in this unit to a wall outlet until all connections are complete.
- 8 Do not operate this unit upside-down. It may overheat, possibly causing damage.
- 9 Do not use force on switches, knobs and/or cords.
- 10 When disconnecting the power cable from the wall outlet, grasp the plug; do not pull the cable.
- 11 Do not clean this unit with chemical solvents; this might damage the finish. Use a clean, dry cloth.
- 12 Only voltage specified on this unit must be used. Using this unit with a higher voltage than specified is dangerous and may cause fire, damage to this unit, and/or personal injury. Yamaha will not be held responsible for any damage resulting from use of this unit with a voltage other than specified.
- 13 To prevent damage by lightning, keep the power cable and outdoor antennas disconnected from a wall outlet or this unit during a lightning storm.
- 14 Do not attempt to modify or fix this unit. Contact qualified Yamaha service personnel when any service is needed. The cabinet should never be opened for any reasons.
- 15 When not planning to use this unit for long periods of time (i.e. vacation), disconnect the AC power plug from the wall outlet.
- 16 Be sure to refer to the “Troubleshooting” section of the Owner’s Manual on the CD-ROM for common operating errors before concluding that this unit is faulty.
- 17 Before moving this unit, press  $\Phi$  to set it to standby mode and disconnect the AC power plug from the wall outlet.
- 18 **VOLTAGE SELECTOR** (Asia and General models only)  
The **VOLTAGE SELECTOR** on the rear panel of this unit must be set for your local main voltage **BEFORE** plugging into the AC wall outlet. Voltages are:
  - .....AC 110/120/220/230-240V, 50/60Hz (General model)
  - ..... AC 220/230-240V, 50/60Hz (Asia model)
- 19 Condensation will form when the surrounding temperature changes suddenly. Disconnect the power cable from the outlet, then leave this unit alone.
- 20 When using this unit for a long time, this unit may become warm. Turn the power off, then leave this unit alone for cooling.
- 21 Install this unit near the AC outlet and where the AC power plug can be reached easily.
- 22 The batteries shall not be exposed to excessive heat such as sunshine, fire or the like. When you dispose of batteries, follow your regional regulations.
- 23 Excessive sound pressure from earphones and headphones can cause hearing loss.
- 24 When replacing the batteries, be sure to use batteries of the same type. Danger of explosion may happen if batteries are incorrectly replaced.

This unit is not disconnected from the AC power source as long as it is connected to the wall outlet, even if this unit itself is turned off by  $\Phi$ . This state is called the standby mode. In this state, this unit is designed to consume a very small quantity of power.

**WARNING**  
TO REDUCE THE RISK OF FIRE OR ELECTRIC SHOCK,  
DO NOT EXPOSE THIS UNIT TO RAIN OR MOISTURE.

## ■ Notes on remote controls and batteries

- Do not spill water or other liquids on the remote control.
- Do not drop the remote control.
- Do not leave or store the remote control in the following conditions:
  - places of high humidity, such as near a bath
  - places of high temperatures, such as near a heater or stove
  - places of extremely low temperatures
  - dusty places
- Insert the battery according to the polarity markings (+ and -).
- Change all batteries if you notice the following conditions:
  - the operation range of the remote control narrows
  - the transmit indicator does not flash or is dim
- If the batteries run out, immediately remove them from the remote control to prevent an explosion or acid leak.
- If you find leaking batteries, discard the batteries immediately, taking care not to touch the leaked material. If the leaked material comes into contact with your skin or gets into your eyes or mouth, rinse it away immediately and consult a doctor. Clean the battery compartment thoroughly before installing new batteries.
- Do not use old batteries together with new ones. This may shorten the life of the new batteries or cause old batteries to leak.
- Do not use different types of batteries (such as alkaline and manganese batteries) together. Specification of batteries may be different even though they look the same.
- Before inserting new batteries, wipe the compartment clean.
- If the remote control is without batteries for more than 2 minutes, or if exhausted batteries remain in the remote control, the contents of the memory may be cleared. In such a case, install new batteries and set the remote control code.
- Dispose of batteries according to your regional regulations.

### FOR CANADIAN CUSTOMERS

To prevent electric shock, match wide blade of plug to wide slot and fully insert.

This Class B digital apparatus complies with Canadian ICES-003.

### POUR LES CONSOMMATEURS CANADIENS

Pour éviter les chocs électriques, introduire la lame la plus large de la fiche dans la borne correspondante de la prise et pousser jusqu'au fond. Cet appareil numérique de la classe B est conforme à la norme NMB-003 du Canada.

### IMPORTANT

Please record the serial number of this unit in the space below.

MODEL:

Serial No.:

The serial number is located on the rear of the unit. Retain this Owner's Manual in a safe place for future reference.

## ■ For U.K. customers

If the socket outlets in the home are not suitable for the plug supplied with this appliance, it should be cut off and an appropriate 3 pin plug fitted. For details, refer to the instructions described below.

### Note

The plug severed from the mains lead must be destroyed, as a plug with bared flexible cord is hazardous if engaged in a live socket outlet.

## ■ Special Instructions for U.K. Model

### IMPORTANT

THE WIRES IN MAINS LEAD ARE COLOURED IN ACCORDANCE WITH THE FOLLOWING CODE:

Blue: NEUTRAL

Brown: LIVE

As the colours of the wires in the mains lead of this apparatus may not correspond with the coloured markings identifying the terminals in your plug, proceed as follows:

The wire which is coloured BLUE must be connected to the terminal which is marked with the letter N or coloured BLACK. The wire which is coloured BROWN must be connected to the terminal which is marked with the letter L or coloured RED.

Making sure that neither core is connected to the earth terminal of the three pin plug.

## We Want You Listening For A Lifetime



Yamaha and the Electronic Industries Association's Consumer Electronics Group want you to get the most out of your equipment by playing it at a safe level. One that lets the sound come through loud and clear without annoying blaring or distortion – and, most importantly, without affecting your sensitive hearing. Since hearing damage from loud sounds is often undetectable until it is too late, Yamaha and the Electronic Industries Association's Consumer Electronics Group recommend you to avoid prolonged exposure from excessive volume levels.

## Limited Guarantee for European Economic Area (EEA) and Switzerland

Thank you for having chosen a Yamaha product. In the unlikely event that your Yamaha product needs guarantee service, please contact the dealer from whom it was purchased. If you experience any difficulty, please contact Yamaha representative office in your country. You can find full details on our website (<http://www.yamaha-hifi.com/> or <http://www.yamaha-uk.com/> for U.K. resident).

The product is guaranteed to be free from defects in workmanship or materials for a period of two years from the date of the original purchase. Yamaha undertakes, subject to the conditions listed below, to have the faulty product or any part(s) repaired, or replaced at Yamaha's discretion, without any charge for parts or labour. Yamaha reserves the right to replace a product with that of a similar kind and/or value and condition, where a model has been discontinued or is considered uneconomic to repair.

### Conditions

- 1 The original invoice or sales receipt (showing date of purchase, product code and dealer's name) MUST accompany the defective product, along with a statement detailing the fault. In the absence of this clear proof of purchase, Yamaha reserves the right to refuse to provide free of charge service and the product may be returned at the customer's expense.
- 2 The product MUST have been purchased from an AUTHORISED Yamaha dealer within the European Economic Area (EEA) or Switzerland.
- 3 The product must not have been the subject of any modifications or alterations, unless authorised in writing by Yamaha.
- 4 The following are excluded from this guarantee:
  - a. Periodic maintenance and repair or replacement of parts due to normal wear and tear.
  - b. Damage resulting from:
    - (1) Repairs performed by the customer himself or by an unauthorised third party.
    - (2) Inadequate packaging or mishandling, when the product is in transit from the customer. Please note that it is the customer's responsibility to ensure the product is adequately packaged when returning the product for repair.
    - (3) Misuse, including but not limited to (a) failure to use the product for its normal purpose or in accordance with Yamaha's instructions on the proper use, maintenance and storage, and (b) installation or use of the product in a manner inconsistent with the technical or safety standards in force in the country where it is used.
    - (4) Accidents, lightning, water, fire, improper ventilation, battery leakage or any cause beyond Yamaha's control.
    - (5) Defects of the system into which this product is incorporated and/or incompatibility with third party products.
    - (6) Use of a product imported into the EEA and/or Switzerland, not by Yamaha, where that product does not conform to the technical or safety standards of the country of use and/or to the standard specification of a product sold by Yamaha in the EEA and/or Switzerland.
- 5 Where the guarantee differs between the country of purchase and the country of use of the product, the guarantee of the country of use shall apply.
- 6 Yamaha may not be held responsible for any losses or damages, whether direct, consequential or otherwise, save for the repair or replacement of the product.
- 7 Please backup any custom settings or data, as Yamaha may not be held responsible for any alteration or loss to such settings or data.
- 8 This guarantee does not affect the consumer's statutory rights under applicable national laws in force or the consumer's rights against the dealer arising from their sales/purchase contract.

### Information for Users on Collection and Disposal of Old Equipment and Used Batteries



These symbols on the products, packaging, and/or accompanying documents mean that used electrical and electronic products and batteries should not be mixed with general household waste.

For proper treatment, recovery and recycling of old products and used batteries, please take them to applicable collection points, in accordance with your national legislation and the Directives 2002/96/EC and 2006/66/EC.



By disposing of these products and batteries correctly, you will help to save valuable resources and prevent any potential negative effects on human health and the environment which could otherwise arise from inappropriate waste handling.



For more information about collection and recycling of old products and batteries, please contact your local municipality, your waste disposal service or the point of sale where you purchased the items.

#### [Information on Disposal in other Countries outside the European Union]

These symbols are only valid in the European Union. If you wish to discard these items, please contact your local authorities or dealer and ask for the correct method of disposal.



#### Note for the battery symbol (bottom two symbol examples):

This symbol might be used in combination with a chemical symbol. In this case it complies with the requirement set by the Directive for the chemical involved.

**Pb**



