

GPS 155XL



PILOT'S GUIDE AND REFERENCE





INTRODUCTION

Foreword

This manual is written for software version 2.04 or above, and is not suitable for earlier software versions.

© 1999 GARMIN Corporation

GARMIN International, Inc., 1200 East 151st Street, Olathe, Kansas 66062 USA
Tel: 913-397-8200 Fax: 913-397-8282

GARMIN (Europe) LTD, Unit 5, The Quadrangle, Abbey Park, Romsey, Hampshire S051 9AQ, UK
Tel: 011-44-1794-519944 Fax: 011-44-1794-519222

GARMIN (Asia) Corp., 3rd Fl., No. 1, Lane 45, Pao-Hsing Road, Hsin Tien, Taipei, Taiwan R.O. C.
Tel: 011-886-02-2917-3773 Fax: 011-886-02-2917-1758

Web Site Address: www.garmin.com

All rights reserved. No part of this manual may be reproduced or transmitted in any form or by any means, electronic or mechanical, including photocopying and recording, for any purpose without the express written permission of GARMIN.

Information in this document is subject to change without notice. GARMIN reserves the right to change or improve their products and to make changes in the content of this material without obligation to notify any person or organization of such changes or improvements.

GARMIN, GPS 155XL, Spell'N'Find, AutoLocate, PhaseTrac12, and AutoStore are trademarks of GARMIN and may only be used with permission.

NavData® is a registered trademark of Jeppesen, Inc.

All rights reserved.



INTRODUCTION

Cautions

NOTE: This device complies with Part 15 of the FCC limits for Class B digital devices. This equipment generates, uses, and can radiate radio frequency energy and, if not installed and used in accordance with the instructions, may cause harmful interference to radio communications. Furthermore, there is no guarantee that interference will not occur in a particular installation.

If this equipment does cause harmful interference, the user is encouraged to try to correct the interference by relocating the equipment or connecting the equipment to a different circuit than the affected equipment. Consult an authorized dealer or other qualified avionics technician for additional help if these remedies do not correct the problem.

Operation of this device is subject to the following conditions: (1) This device may not cause harmful interference, and (2) this device must accept any interference received, including interference that may cause undesired operation.

The GARMIN GPS 155XL does not contain any user-serviceable parts. Repairs should only be made by an authorized GARMIN service center. Unauthorized repairs or modifications could void your warranty and authority to operate this device under Part 15 regulations.

CAUTION

The Global Positioning System is operated by the United States government, which is solely responsible for its accuracy and maintenance. The system is subject to changes which could affect the accuracy and performance of all GPS equipment. Although the GARMIN GPS 155XL is a precision electronic NAVigation AID (NAVAID), any NAVAID can be misused or misinterpreted and therefore become unsafe.

Use the GPS 155XL at your own risk. To reduce the risk of unsafe operation, carefully review and understand all aspects of this Owner's Manual and the Flight Manual Supplement, and thoroughly practice using the simulator mode prior to actual use. When in actual use, carefully compare indications from the GPS 155XL to all available navigation sources, including the information from other NAVAIDS, visual sightings, charts, etc. For safety, always resolve any discrepancies before continuing navigation.

The altitude calculated by the GPS 155XL is geometric height above mean sea level and could vary significantly from altitude displayed by pressure altimeters in aircraft. **Never** use GPS altitude for vertical navigation.

The Jeppesen database incorporated in the GPS 155XL must be updated regularly in order to ensure that its information is current. Updates are released every 28 days. A database information packet is included in your GPS 155XL package.

Pilots using an out-of-date database do so entirely at their own risk.

Accessories & Packing List

Congratulations on choosing the finest, most advanced panel mount IFR GPS receiver available. The GPS 155XL represents GARMIN's commitment to provide an accurate, easy-to-use GPS for all of your aviation needs.

Before installing and getting started with your unit, please check to see that your package includes the following items. If any parts are missing or damaged, please see your GARMIN dealer immediately.

Standard Package:

- GPS 155XL Unit & NavData® Card
- GPS Antenna
- Installation Rack & Connectors
- Pilot's Guide & Quick Reference Guide
- Database Subscription Packet
- Warranty Registration Card

Optional Accessories:

- Remote Battery Pack
- AC Adapter
- PC Software/Interface Kit
- User Data Card
- 28 to 14 volt DC converter
- MD-41 External Switch/Annunciator



INTRODUCTION Accessories and Packing List

*To obtain accessories for your GPS 155XL,
please contact your nearest GARMIN dealer.*





INTRODUCTION

Warranty

To obtain warranty service, see your local dealer or call the GARMIN Customer Service department for a returned merchandise tracking number. The unit should be securely packaged with the tracking number clearly marked on the outside of the package, and sent freight prepaid and insured to a GARMIN authorized warranty service facility.

GARMIN is fully committed to your satisfaction as a customer. If you have any questions regarding the GPS 155XL, please contact our customer service department at:

*GARMIN International, Inc.
1200 East 151st Street
Olathe, KS 66062-3426
(913) 397-8200
FAX (913) 397-8282*

Every GARMIN GPS is built to exacting standards to provide years of trouble-free service. GARMIN warrants this product to be free from defects in materials and workmanship for one year from the date of purchase.

GARMIN International, Inc. will at its sole option, repair or replace any components which fail in normal use. Such repairs or replacement will be made at no charge to the customer for parts or labor. The customer is, however, responsible for any transportation costs. This warranty does not cover failures due to abuse, misuse, accident or unauthorized alteration or repairs. GARMIN International, Inc. assumes no responsibility for special, incidental, punitive or consequential damages, or loss of use.

THE WARRANTIES AND REMEDIES CONTAINED HEREIN ARE EXCLUSIVE, AND IN LIEU OF ALL OTHER WARRANTIES EXPRESSED OR IMPLIED, INCLUDING ANY LIABILITY ARISING UNDER WARRANTY OF MERCHANTABILITY OR FITNESS FOR A PARTICULAR PURPOSE, STATUTORY OR OTHERWISE. THIS WARRANTY GIVES YOU SPECIFIC LEGAL RIGHTS, WHICH MAY VARY FROM STATE TO STATE.

PART ONE: INTRODUCTION

Foreword	i
Cautions	ii
Accessories/Packing List	iii
Warranty	iv
Table of Contents	v-vi
Key and Knob Functions	vii-viii
GPS 155XL Takeoff Tour	1-9

PART TWO: REFERENCE

Section 1: Navigation with the GPS 155XL (NAV key)	10
Navigating and planning functions	
Section 2: Waypoint and Database Information (WPT key)	32
Finding and using database and waypoint information	
Section 3: Nearest Waypoints (NRST key)	53
Finding nearest waypoints, SUAs and FSS/ARTCC frequencies	
Section 4: Direct-to (→ key) & Route Navigation (RTE key)	58
Creating and using routes	
Section 5: Approaches, SIDs and STARs (RTE key)	74
Selecting and flying non-precision approaches	
Section 6: Messages and Unit Settings (MSG key)	96



To quickly and easily locate information on specific tasks, please refer to the Index on page 130.



INTRODUCTION

Table of Contents

Appendix A: NavData [®] and User Data Card Use	108
Appendix B: Installation and Maintenance of the GPS 155XL	110
Appendix C: Simulator	111
Appendix D: GPS 155XL Messages and Abbreviations	113
Appendix E: Specifications	121
Appendix F: Map Datums	122
Appendix G: Troubleshooting Q & A	124
Appendix H: Index	130

Key and Knob Functions



The **power/intensity knob** controls unit power and display intensity.



The **zoom-in key** is used to zoom in to the next smaller scale setting when viewing the map page.



The **zoom-out key** allows you to zoom out to the next larger scale setting when viewing the map page.

NRST

The **nearest key** is used to obtain information on the 9 nearest airports, VORs, NDBs, intersections, user waypoints and 2 nearest FSS/ARTCC points of communication. The nearest key also accesses any active SUA information. See Section 3 for more information on the nearest waypoints.

RTE

The **route key** enables you to create, edit, activate and invert routes, and access approaches, SIDs and STARs. Search-and-rescue, parallel offset and closest point of approach functions are also performed using the route key. See Section 4 for more information on routes and Section 5 for more information on approaches, SIDs and STARs.

WPT

The **waypoint key** is used to view information such as runways, frequencies, position and comments on airports, VORs, NDBs, intersections and user waypoints. See Section 2 for more waypoint information.

NAV

The **navigation key** is used to view navigation and position information. Planning operations are also performed using this key. See Section 1 for more information on navigation and planning operations.



INTRODUCTION

Key and Knob Functions

The GPS 155XL is designed to minimize keystrokes when performing operations. There are typically several ways to perform the same operation. In general, using the knobs will decrease keystrokes and time spent using the GPS 155XL. Experiment to find the most effective way to use the GPS 155XL to your advantage.

INTRODUCTION

Key and Knob Functions

This manual will describe entering data using the  and  knobs. Experiment with them and become efficient in entering data with the concentric knobs. This will greatly reduce the amount of time required to navigate with the GPS 155XL.

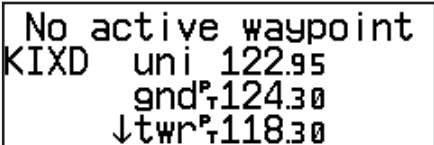

```
No active waypoint
KIXD uni 122.95
gndP 124.30
↓twrP 118.30
```

Whenever the GPS 155XL is displaying a list of information that is too long for the display screen, the scrolling arrow prompt will indicate which direction to scroll to view additional information. To scroll through a list (with the cursor active), simply rotate the outer knob. When the cursor is not active, use the inner knob to view additional information.

MSG

The **message key** is used to view system messages and to alert you to important warnings and requirements. This key is also used to access the GPS 155XL's unit settings. See Section 6 for more information on messages and unit settings.

→

The **direct-to key** performs an instant direct-to, allows you to enter a waypoint, and sets a direct course to the destination. See Section 4.

CLR

The **clear key** is used to erase information or cancel an entry.

ENT

The **enter key** is used to approve an operation or complete data entry. It is also used to confirm information, such as during power on.

CRSR

The **cursor key** is used to activate/deactivate the cursor on the GPS 155XL's display. Pressing once will activate the cursor (indicated by high-lighted characters on a data field), which is used to highlight fields for data entry, changing information or cycling through available options. Press a second time to deactivate the cursor.



The **outer knob** is used to advance through pages, advance the cursor or move through data fields.



The **inner knob** is used to change data or scroll through information that cannot fit on the screen all at once.

The GARMIN GPS 155XL is a powerful navigational tool that provides pilots with accurate navigational data, including non-precision approaches, SIDs and STARs. The Takeoff Tour is designed to familiarize you with the operation of the GPS 155XL, including powering up the unit, entering data and performing a simple direct-to, and provide a limited introduction to the 'Nearest' functions. In addition, this section also briefly covers the position, NAV summary, map and frequency pages available from the NAV key. These pages will be used for most of your in-flight navigation.

The Takeoff Tour assumes that the receiver and antenna have been properly installed and you have not changed any of the GPS 155XL's default settings. If you have changed any of the factory default settings (position format, units of measure, selectable fields, etc.), the pictures shown here may not match your configuration. Prior to using your GPS 155XL for the first time, we recommend that you taxi to a location that is well away from buildings and other aircraft so the unit can collect satellite data without interruption.

Powering up the GPS 155XL

The GPS 155XL's power and display intensity are controlled using the  knob at the bottom left of the unit. Rotating it clockwise will turn unit power on and progressively increase the display intensity. After turning the unit on, a **welcome page** will be displayed while the unit performs a self test.

The **database page** will appear next, showing the current database information on the NavData card, with the valid operating dates, cycle number and database type indicated. The database is updated every 28 days, and must be current for approved approach and IFR operations. Information on database subscriptions is available inside your GPS 155XL package.

To acknowledge the database information:

1. Press the  key.

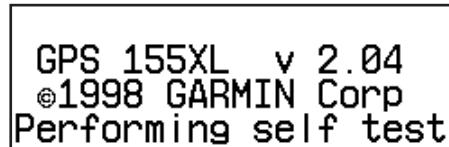

The welcome page appears when the GPS 155XL is turned on. During the time this screen is displayed, the GPS 155XL performs a self test to ensure proper operation.

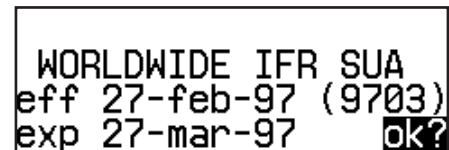

The database confirmation page shows the effective and expiration dates of the Jeppesen database on the NavData Card.

TAKEOFF TOUR

Acquiring Satellites





```
No gps position
Acquiring epe____f
sat 1 3 5 6 9 13 17 19→
sgl 9 6 - 3 - 7 9 -
```



The satellite status page shows the ID numbers for the satellites and the relative signal strength of each satellite received. Turn the  knob to view additional satellites.

```
No gps position
Search Sky epe____f
sat 1
sgl -
```

'Search Sky' indicates that satellite almanac data is not available or has expired (if the unit hasn't been used for six months or more). The data will be recollected from the first available satellite.

Once the database has been acknowledged, the **satellite status page** will appear, and the GPS 155XL will begin to collect satellite information. An 'Acquiring' status will be displayed on the satellite status page, and the signal values on the bottom line of the page will begin displaying numeric values. This is a good indication that you are receiving signals and satellite lock will occur. Following the first-time use of your GPS 155XL, the time required for a position fix will vary — usually from one to two minutes.

If the unit can only obtain enough satellites for 2D navigation (no altitude), the unit will use the altitude provided by your altitude encoder, if one is connected and working. If not, you will be prompted to enter the altitude with a 'Need alt- Press NAV' message. If this message occurs, press the  key and use the  and  knobs to enter the altitude shown on your altimeter. Press  when finished.

If the GPS 155XL has not been operated for a period of six months or more, it may have to 'Search the Sky' to collect new data. This means the unit is acquiring satellite data to establish almanac and satellite orbit information, which can take 5 to 10 minutes. The satellite status page will display a 'Search Sky' status, and the message annunciator () next to the  key, will also flash to alert you of a system message — 'Searching the Sky'.

To view a system message:

1. Press .

The **message page** will appear and display the status or warning information applicable to the receiver's current operating condition.

To return to the previous page after viewing a message:

1. Press  again.

After the GPS 155XL acquires satellites and computes a position, the **position page** will appear automatically, and you'll be informed with 'Ready for navigation' on the message page.

Altitude, MSA or ESA

Position (lat/lon)

```
No active waypoint
alt 1911F
N38° 51.245' W094° 55.473'
frapt KIXD 305° 2.11N
```

Reference Waypoint Field

The position page displays your present latitude and longitude, altitude and a reference waypoint field. The altitude and reference waypoint fields are also selectable (see Section 1 for more information) to allow you to configure the unit to your own preferences. The default settings are:

- **Altitude**— Your present GPS altitude
- **Present Position**— Latitude and longitude displayed in degrees/minutes
- **Reference Waypoint**— The bearing and distance to the nearest airport

The position page is one of seven pages available under the GPS 155XL's **NAV** key:

- **NAV summary page**
- **NAVCOM page**
- **Satellite status page**
- **NAV menu 2**
- **Map page**
- **Position page**
- **NAV menu 1**

During most flights, the position, NAV summary, map and NAVCOM pages will be the primary pages used for navigation. The pages are accessible by pressing the **NAV** key and rotating the outer knob, or by pressing the **NAV** key repeatedly.

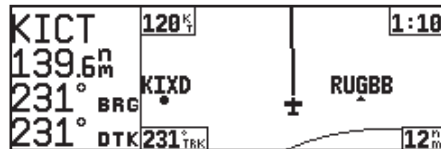

The map page combines a moving map display and navigation data for complete situational awareness.

```
No active waypoint
KIXD uni 122.95
gndF 124.30
↓twrF 118.30
```

The navigation communications (NAVCOM) page provides a complete list of airport frequencies at your departure and arrival airports.

TAKEOFF TOUR

Direct-To Navigation NAV Summary Page

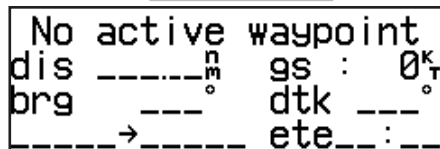

No active waypoint
dis _____ⁿ_m gs : 0^K_T
brg _____ dtk ____
----->----- ete__:_

The NAV summary page without a direct-to destination or active route appears blank, except for ground speed (GS) and track (TRK) figures, if displayed.

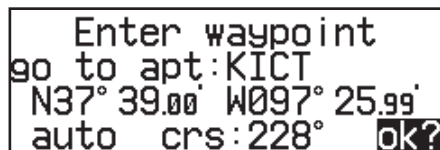





Enter waypoint
go to apt: KICT
N37° 39.00' W097° 25.99'
auto crs: 228° ok?

When a destination is selected, the direct-to confirmation page appears to verify the destination you selected.

The GPS 155XL uses direct point-to-point navigation to guide you from takeoff to touchdown in the IFR environment. Once a destination is selected, the unit will provide speed, course and distance data based upon a direct course from your present position to your destination. A destination can be selected from any page using the  (**direct-to**) key.

To select a direct-to destination:

1. Press the  key. The NAV summary page will appear with the destination field highlighted.
2. Rotate the  knob to enter the first letter of the destination waypoint identifier. The destination waypoint may be an airport, VOR, NDB, intersection or user waypoint, as long as it is in the database or stored in memory as a user waypoint.
3. Rotate the  knob to the right to move the cursor to the next character position.
4. Repeat steps 2 and 3 to spell out the rest of the waypoint identifier.
5. Press  to confirm the identifier. The direct-to confirmation page will appear.
6. Press  to confirm the destination.

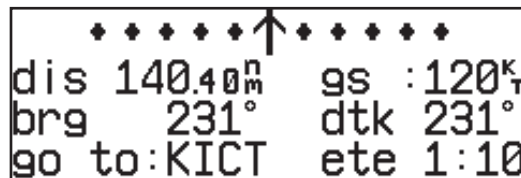

♦ ♦ ♦ ♦ ♦ ↑ ♦ ♦ ♦ ♦ ♦
dis 140.40ⁿ gs : 120^K_T
brg 231° dtk 231°
go to: KICT ete 1:10

Once the direct-to destination is confirmed, the **NAV summary page** will appear with the destination indicated in the lower left hand corner of the screen. Your present speed and track over the ground, and the distance and estimated time enroute to your destination are also displayed. The graphical CDI (course deviation indicator), located at the top of the screen, displays your position relative to the desired course and provides turn anticipation and waypoint messages during route navigation.

In addition to the destination field and graphical CDI, the GPS 155XL NAV summary page features five selectable fields for various navigation data so that the page may be configured to your own preferences (see Section 1 for more information). The default settings for the NAV summary page are:

- **Distance (dis)**— The distance to your destination in nautical miles
- **Ground Speed (gs)**— Your present speed over the ground in knots
- **Bearing (brg)**— The direction from present position to your destination
- **Desired Track (dtk)**— The course between the 'from' and 'to' waypoints
- **Estimated Time Enroute (ete)**— The time to your destination (in hours and minutes) based upon your present speed and course

The next page available from the **NAV** key is the **map page**. The map page combines the primary navigation information from the NAV summary page – distance to waypoint, ground speed, bearing, desired track and ETE – with a moving map display. The moving map display shows your current position (using an airplane symbol or a diamond symbol) relative to nearby airports, VORs, NDBs, intersections, user waypoints and airspace boundaries. Notice that the graphical CDI does not appear on the map page; the graphical CDI does appear on all other GPS 155XL pages.

The map page can be divided into two main sections:

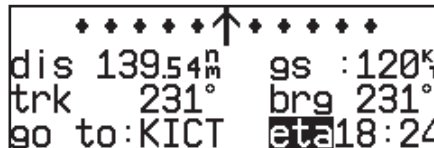
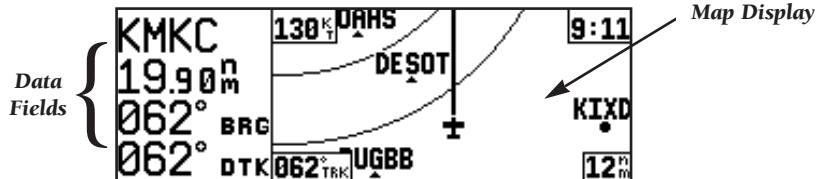

NAV summary page with 'trk', 'brg' and 'eta' displayed.

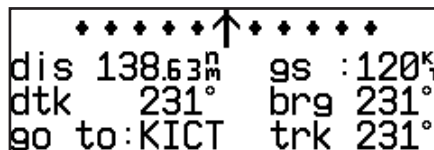

NAV summary page with 'dtk', 'brg' and 'trk' displayed.

TAKEOFF TOUR

Map Page



The map display may be oriented along your ground track (track up), course (desired track up) or fixed at north up. Desired track up or north up settings show your present position with a diamond symbol instead of the airplane symbol.

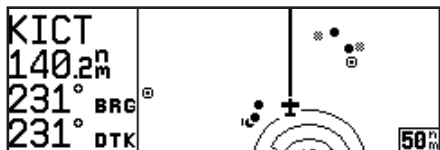

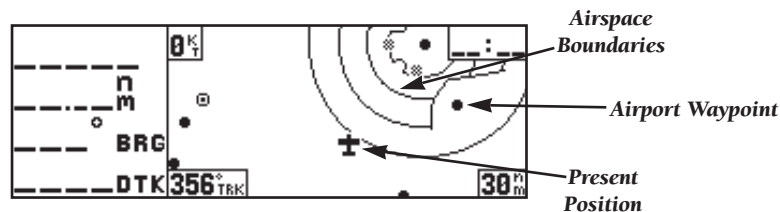

Distance and bearing to waypoint, destination waypoint name and desired track are shown on the left hand side of the map page. To remove the data fields that border the map display, press **CLR**.



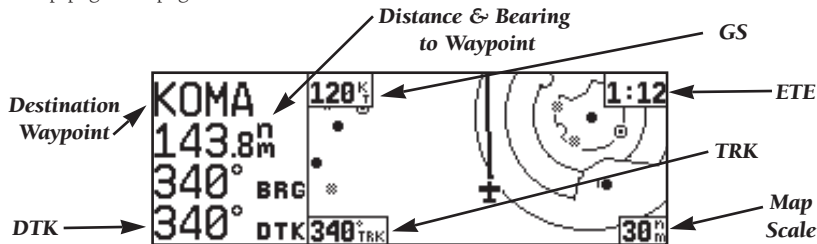



The **map display** occupies the right side of the display. Your present position is indicated by a plane symbol (in track up mode) or a position diamond (in other orientation modes), with your route displayed as a solid line. Nearby airports, nav aids and user waypoints may be depicted on the map—with unique identifying symbols for each waypoint type. Boundaries for special use and controlled airspaces can also appear on the map display. You may select which features are shown on the map using the map setup page (see page 97).





The **data fields** on the map page indicate distance and bearing to destination waypoint, desired track, ground track, ground speed, time to waypoint and map scale. The destination waypoint name, bearing to waypoint, distance to waypoint and desired track appear on the left side of the page. The other data fields are located at the corners of the map display, as shown in the illustration above, and may be removed by pressing **CLR**.

The map display has 14 available scales from 0.5 to 300 (nautical miles, statute miles or kilometers) representing the vertical height of the map. The map scale is controlled by the  and  keys, with the current scale displayed in the lower right corner.

To select a map scale:

1. Press  to increase the map scale and show a larger area (or turn  to the right).
2. Press  to decrease the map scale and show a smaller area (or turn  to the left).



Another page available under the GPS 155XIs  key is the **navigation communications (NAVCOM) page**. It provides you with a complete list of airport frequencies at your departure and arrival airports, allowing convenient selection of frequencies you'll need along your flight path. If you do not have an active departure airport, the navigation communications page will display the frequencies for the airport nearest your departure position.

To view the NAVCOM page from the map page, rotate  one stop to the right.



The NAVCOM page lists your departure and arrival airports on the left side of the page, with all the database frequencies listed in a column down the right side of the page. To scroll through the list of frequencies, simply rotate the inner knob () in the direction of the arrow prompts at the bottom left of the page.

Once a direct-to is activated, the NAV summary page will provide navigation to the destination until the direct-to is cancelled or another direct-to destination is activated.

To cancel a direct-to from the NAV summary page:

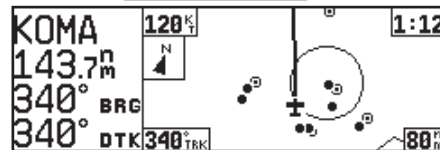
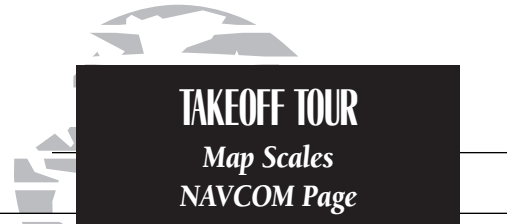
1. Press the  key to activate the cursor in the destination field.
2. Press .
3. Press .



To change the map scale press  to increase the scale or  to decrease the scale.

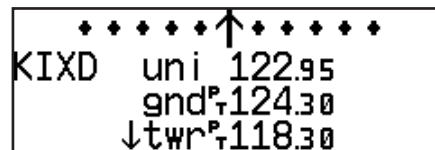

The NAVCOM page lists the frequencies for your departure (or nearest) and arrival airports.

TAKEOFF TOUR

Nearest Waypoints



◆◆◆◆◆↑◆◆◆◆◆
nr1 apt KIXD 1090^f
148° 6.59^m twr 118.30
rnwy 17 /35 7300^f

The nearest airport page shows up to nine nearest airports from your present position.

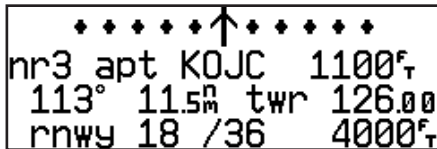

◆◆◆◆◆↑◆◆◆◆◆
nr3 apt KOJC 1100^f
113° 11.5^m twr 126.00
rnwy 18 /36 4000^f



To view additional nearest airports, rotate the  knob.

The GPS 155XIs **NRST** key provides the nine nearest airports, VORs, NDBs, inter-sections, user waypoints and any SUA (special use airspace) alerts, as well as the two closest FSS (Flight Service Station) and center (ARTCC) frequencies for your present position. The nearest waypoint feature is a handy safety feature that may be used to execute a quick direct-to in case of an in-flight emergency or to review the closest facilities to your present position. The nearest feature can also be used to quickly find the contact frequency of the nearest airport.

To view the nine nearest airports:

1. Press the **NRST** key. The nearest airport will be displayed, with the range and bearing from your present position, along with elevation, frequency and runway data.
2. To review the rest of the nearest airport list, rotate the  knob to the right.

To view the nearest list for other waypoint categories (VOR, NDB, etc.):

1. Rotate the  knob to the right, or press the **NRST** key repeatedly.
2. Rotate  to scroll through the list.

Once the nearest airport (or any other nearest waypoint) page is displayed, the selected waypoint can be quickly reviewed or selected as a direct-to destination.

To review the selected waypoint from the nearest waypoint list:

1. Press **CRSR** to activate the waypoint field.
2. Press **ENT** to display the waypoint identification page.
3. Rotate  to view any additional waypoint information available.
4. Press **NRST** to return to the nearest waypoint page.

To select a nearest waypoint as a direct-to destination:

1. Press the **→** key. The direct-to confirmation page for the selected waypoint will appear.
2. Press **ENT** to confirm.

Congratulations! You've covered the basic operation of the GPS 155XL. We encourage you to experiment with your new GPS receiver to get to know all the advanced navigation features it has to offer. If you'd like a little more practice, try using the built-in simulator described in Appendix C. An optional AC adapter will even let you plan and simulate flights in the comfort of your home or office.

To turn the GPS 155XL off:

1. Turn the **⦿** knob to the left until the unit shuts off.

NOTE: The GPS 155XL is normally connected to power through the avionics master switch. With the optional remote battery installed, the unit will display a power down warning when the master switch is turned off. This warning page features a timer which will count down from 30 seconds when the unit senses that power is off. After 30 seconds, the GPS 155XL will shut off. If you wish to continue operating the unit, press any key during the countdown period, and the GPS 155XL will continue operating from the backup battery.



apt:KIXD N CEN USA
OLATHE KS
NEW CENTURY AIRCENTE

To review a nearest waypoint, highlight the identifier and press **ENT**.

Enter waypoint
go to apt:KIXD
N38° 49.90' W094° 53.39'
auto crs:118° ok?

To select a nearest waypoint as your direct-to destination, press **→** and **ENT**.

SECTION 1

NAV KEY Overview

```

No active waypoint
3D Nav          dop 2.0
sat 1 3 5 6 9 13 17 19→
sgl 9 6 - 3 - 7 9 -
    
```

Remember! The NAV pages will only display information **AFTER** the position and navigational information has been calculated from the satellites. If you are on the position page before the unit has calculated a position, you will be able to enter an approximate position and altitude. This is helpful in speeding satellite acquisition if the unit has moved a great distance with the power off.

If you are not sure the GPS is actively calculating position, check the receiver status field for '2D NAV' or '3D NAV' by pressing the **NAV** key and rotating the outer knob until the satellite status page appears. The current receiver status is displayed at the top left of the page.

Section 1 Navigation Key

The GPS 155XL features seven navigation pages to provide various position, course, speed, status and planning information. The pages may be viewed by pressing the **NAV** key and rotating the outer knob, or by pressing the **NAV** key repeatedly.

NAV Summary Page

```

*****↑*****
dis 143.76M  gs :130%
prg 340°  dtk 340°
go to: KOMA  ete 1:06
    
```

Map Page

NAVCOM Page

```

*****↑*****
KIXD uni 122.95
      snd 124.30
      ↓tr 118.30
    
```

NAV Menu 2

```

*****↑*****
Appr Time? Clock?
Trip Time? RAIM Prd?
Scheduler? Sunrise?
    
```



Position Page

```

*****↑*****
alt 1081.7
N39° 02.675 W095° 01.000
Eapt KIXD 331° 14.08M
    
```

```

*****↑*****
Trip Plan? Dalt/tas?
Fuel Plan? Winds?
Vnav Plan? Chklist?
    
```

NAV Menu 1

```

*****↑*****
3D Nav          dop 2.0
sat 1 3 5 6 9 13 17 19→
sgl 9 6 - 3 - 7 9 -
    
```

Satellite Status Page

The **NAV summary**, **map**, **NAVCOM** and **position** pages are the primary pages used during in-flight navigation, while the nav menu and status pages offer access to planning, calculation and status functions. Note that rotating the outer knob clockwise will continuously cycle through all the nav pages, whereas turning the knob counterclockwise will stop the page selection sequence at the NAV summary page.

Whenever the **NAV** key pages are in use, the indicator light (D) next to the **NAV** key will illuminate. If the GPS 155XL requires you to enter data on a navigation page, a message prompt with specific instructions will appear and the indicator will flash. If you leave the NAV page sequence for another set of pages, the last NAV page displayed will reappear when you return to the nav sequence.

The GPS 155XL's **NAV summary page** provides you with the important information needed to navigate directly to your destination. The destination field, located at the bottom left of the page, displays the current destination waypoint or active route leg being navigated. If no direct-to destination, route or approach is being navigated, the destination field will remain blank.

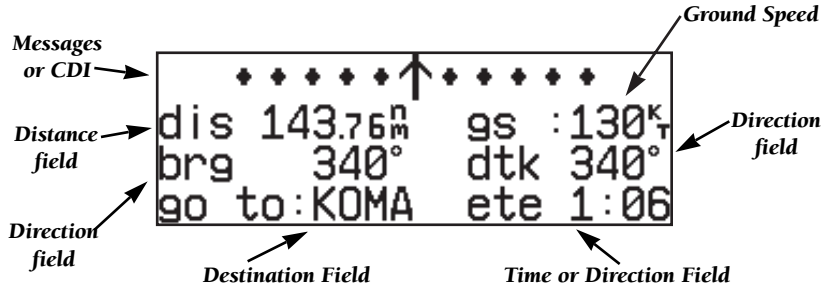

The **graphical CDI** (course deviation indicator) at the top of the page shows your position relative to the desired course (the moving D-bar) to the destination waypoint. The **TO/FROM arrow** in the center of the scale indicates whether you are heading to (an up arrow) the waypoint or if you have passed the waypoint (a down arrow). Note that the GPS 155XL always navigates TO a waypoint unless the GPS SEQ switch is set to the HOLD position, or you have passed the last waypoint in a route. The default setting of the CDI scale is 'Auto'. If you are not navigating to a destination, the CDI field will display a 'No active waypoint' message, and only speed and track data will be available. The CDI field is also used to display the GPS 155XL's turn anticipation and waypoint alert data during route and approach operations (see sections 4 and 5).

In addition to displaying your active destination and the course deviation scale, the NAV summary page features five selectable fields for various distance, direction, speed and time options. This allows you to configure the NAV summary page to your preferences. The default settings displayed are distance, ground speed, bearing, desired track and estimated time enroute.

NAV KEY
NAV Summary Page

SECTION
1

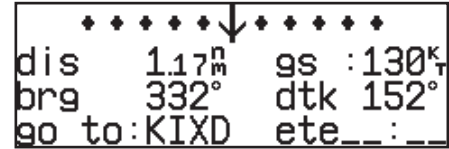

The TO/FROM arrow indicates whether you are heading to (an up arrow) the waypoint or if you've passed the waypoint (a down arrow).

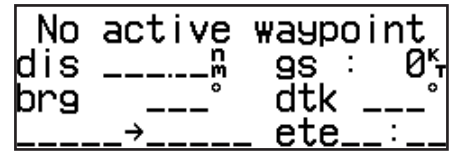

'No Active Waypoint' appears on the CDI field if there is no destination waypoint selected using the **→** key and no active route.

SECTION

1

NAV KEY

Configuring the NAV Summary Page

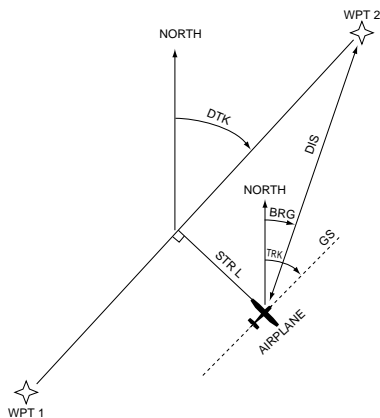

The following functions may be displayed in the distance field:

- **dis**— Distance from present position to the 'active to' waypoint.
- **str**— Steer direction and distance, or digital crosstrack error. An 'L' or 'R' indicates which direction to steer, while the distance value indicates how far you are off course.

The following functions may be displayed in the ground speed field:

- **gs**— Your present speed over the ground.
- **str**— Steer direction and distance, or digital crosstrack error. An 'L' or 'R' indicates which direction to steer, while the distance value indicates how far you are off course.

The following steering functions may be displayed in the direction fields:

- **brg**— Bearing, the direction from your present position to the waypoint.
- **cts**— Course to steer to reduce cross track error and re-intercept course.
- **dtk**— Desired track, the course between the active from and to waypoints.
- **trk**— Track, the direction of movement relative to the ground.
- **trn**— Turn, the direction and degrees to turn to get back on course.

The following information can be displayed in the time field:

- **eta**— Estimated time of arrival (at the active to waypoint).
- **ete**— Estimated time enroute (to the active to waypoint).
- **trk**— Track, or the direction of movement relative to the ground.
- **vn**— Vertical navigation, or VNAV. If VNAV has been activated, this field indicates either the elapsed time before the VNAV maneuver is to begin or the VNAV altitude (the suggested altitude you should be flying in order to complete the maneuver).

To change any of the selectable fields on the NAV summary page:

1. Press **CRSR** to activate the cursor.
2. Rotate **○** to highlight the field you would like to change.
3. Rotate **●** to change the field to display the desired information.
4. Rotate **○** to highlight another field, or **CRSR** to finish.

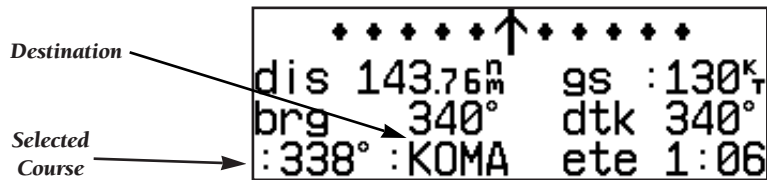

The GPS 155XL's **course select feature** allows the pilot to define the inbound course to, or outbound course from, the 'active' waypoint, using an external HSI. Once the course select function is activated, the selected course will be displayed next to the destination waypoint identifier and the CDI will provide guidance relative to the desired course. The course select feature is only available during route, approach or direct-to navigation. For more information on the course select feature and the GPS SEQ switch, see Section 5.

To set a desired inbound course:

1. Dial the desired course on the HSI.
2. Set the external GPS SEQ switch to the HOLD position.
3. To stop the course select function, set the GPS SEQ switch back to the AUTO position.

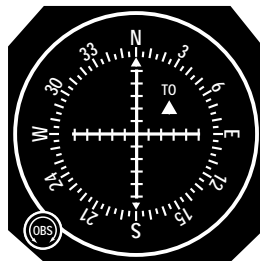
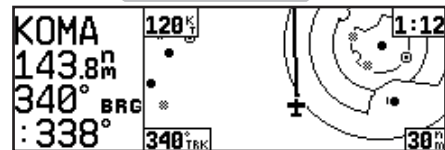

The GPS 155XL's course select feature uses the external GPS SEQ switch, allowing you to dial in the desired course to or from your destination directly from your HSI.

NAV KEY SECTION 1

NAV Summary & Course Select

SECTION 1

NAV KEY Map Page

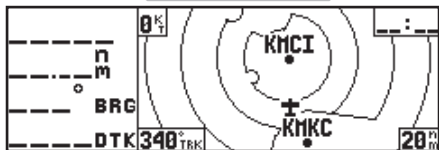

The map page, showing only airports and airspaces on the map display.

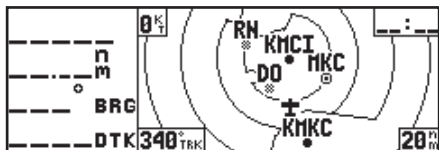

The map page, showing airports, airspaces, VORs and NDBs on the map display.

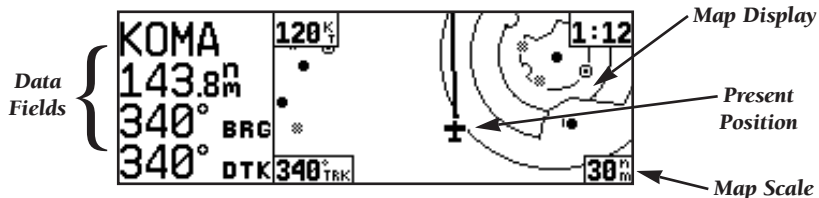





The next page available from the GPS 155X's **NAV** key is the **map page**. The map page displays your present position, using an airplane symbol (in track up mode) or a position diamond (in other orientation modes), along with nearby airports, VORs, NDBs, intersections, user waypoints and airspace boundaries. **Note:** If the GPS 155X is unable to determine a GPS position, the present position symbol will not appear on the map page.

The map display occupies the right side of the display and shows your position relative to nearby airports, nav aids, user waypoints and airspaces. Different symbols are used to distinguish between waypoint types. The identifiers for any on-screen waypoints can also be displayed. Special-use and controlled airspace boundaries appear on the map, showing the individual sectors in the case of Class B or Class C airspace. The map display can be configured to display airports, nav aids, user waypoints, airspaces only at certain scales or these items may be disabled entirely (see page 95). This allows you to de-clutter the map display at larger scale settings.

The map display can be set to 14 different scale settings (from 0.5 to 300 nautical miles, statute miles or kilometers) during en route operation; while in terminal or approach mode 12 different scale settings are available (with the two highest en route scales disabled). The scale represents the top-to-bottom distance covered by the map display.

To select a map scale:

1. Press  to increase the map scale and show a larger area (or turn  to the right).
2. Press  to decrease the map scale and show a smaller area (or turn  to the left).

An autozoom feature is available which will automatically adjust from an en route scale of 300 through each lower scale, stopping at a scale of 1 as you approach your destination waypoint. The autozoom feature is turned on/off from the map setup page described on page 97.

The orientation of the map may be fixed at 'north up' (nrthup), or set to 'desired track up' (dtk up) or 'track up' (trk up). The 'north up' setting will keep the top of the map display fixed on north. 'Track up' will cause the map to rotate so the top of the map is the direction you are heading. 'Desired track up' keeps the map display fixed along your desired course. Map orientation is changed on the map setup page described on page 97.

Navigation data is also provided on the map page to guide you during your flight. The destination waypoint name, distance & bearing to waypoint, and desired track (dtk) appear on the left side of the page. Four additional data fields are located at the corners of the map display (and may be removed by pressing ) , as follows:

- | | |
|-------------------------------|--|
| Ground speed (gs) | - upper left corner |
| Ground track (trk) | - lower left corner |
| Estimated time en route (ETE) | - upper right corner |
| Map scale | - lower right corner (cannot be removed) |

NAV KEY Map Page

SECTION 1



To change the map scale press the  key to increase the scale or  to decrease the scale.

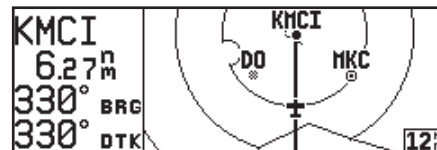

To remove the North indicator and/or data fields from the map display, press .

SECTION

1

NAV KEY

NAVCOM Page

```

* * * * * ↑ * * * * *
KACY  ats 108.60rx
      apr 124.60 brg?
      ↓apr 134.25 brg?

```

The NAVCOM page lists the frequencies for your departure (or nearest) and arrival airports in the following order:

Departure

- Unicom
- ATIS
- Clearance Delivery
- Clearance Pretaxi
- Ground
- Tower
- Multicom
- Other
- Departure
- TCA
- TMA
- CTA
- ARSA
- TRSA

Arrival

- ATIS
- Approach
- Arrival
- TCA
- TMA
- CTA
- ARSA
- TRSA
- Tower
- Multicom
- Other
- Ground
- Unicom

```

* * * * * ↑ * * * * *
KIXD  uni 122.95
      gndr124.30
      ↓twrr118.30

```

The next page available from the GPS 155XIs **NAV** key is the **navigation communications (NAVCOM) page**. The NAVCOM page provides a list of the airport frequencies at your departure and arrival airports, allowing convenient selection of frequencies you'll need along your flight path. To scroll through the list of frequencies, rotate the inner knob (●) in the direction of the arrow prompts at the bottom left of the page.

The frequencies displayed for the departure and arrival airports are listed in the order you are most likely to use them (see left), with the available frequencies displayed to the right of the airport identifier. If you do not have an active route with a departure airport, the NAVCOM page will display the frequencies for the airport nearest your departure position.

If a frequency has sector or altitude restrictions, the frequency will be followed by a 'brg?' indication.

To view restrictions on a frequency:

1. Press **CRSR** to activate the cursor.
2. Rotate ● to highlight the 'brg?' next to the frequency you wish to view.
3. Press **ENT** to begin viewing restrictions.

NAV KEY **SECTION**
NAVCOM & **1**
Position Pages

Once you begin viewing restrictions, you can view any additional frequencies for the selected airport by rotating . (Note: An arrow prompt displayed next to the airport identifier indicates additional frequencies are available.) You can also view the other airport information pages by rotating . Information contained on these pages is covered in Section 2. To return to the NAVCOM page, press .

Some frequencies in the NAVCOM page have tags which designate their usage:

- 'tx' – transmit only
- 'rx' – receive only
- 'pt' – part time frequency

The GPS 155XL **position page** displays the graphical CDI along with your present latitude and longitude, altitude and a reference waypoint field. The altitude and reference waypoint fields are selectable to configure the page to your own preferences and current navigation needs.

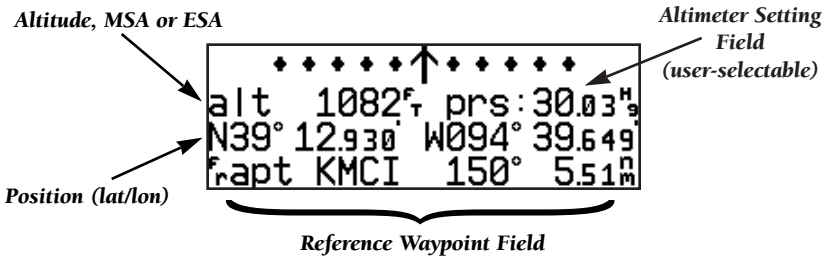

An altimeter setting field appears on the position page when you are within 30 nm of a destination airport. The altimeter setting field allows you to define the current barometric pressure, which is used by the integrity monitoring to crosscheck altitude.

The altitude field can display either the present altitude, minimum safe altitude (MSA) or enroute safe altitude (ESA). MSA is the recommended minimum altitude within a ten mile radius of your present position. ESA is the recommended minimum altitude within ten miles of your course on an active route or direct-to. MSA and ESA altitudes are calculated from information contained in the database and generally include mountains, buildings and other permanent features (see following page).

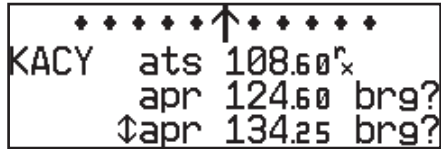

NAVCOM page with receive only (rx) frequency and frequencies with restrictions (brg).



Frequency restrictions on 124.60, showing range of applicable radials from 130° through 309°.

SECTION

1

NAV KEY

Position Page &
Reference Waypoints

```

* * * * * ↑ * * * * *
msa 3200f
N39° 12.930' W094° 39.649'
rapt KMCI 150° 5.51m

```

The position page displaying MSA. MSA and ESA are based on data stored in the NavData card. This information cannot be solely relied upon as an absolute measure of safe altitude in your area. Consult current charts and NOTAMS.



```

* * * * * ↑ * * * * *
alt 1082f
N39° 12.930' W094° 39.649'
r:wpt: TOP 078° 41.71m

```

Position page displaying the 'TOP' VOR as the reference waypoint. This configuration can be used to help monitor your distance and radial from a waypoint of your choice. (Note: the waypoint category is listed as 'wpt' rather than 'VOR' because the GPS 155XL is not using the nearest VOR.)

To change the altitude field:

1. Press **CRSR** to obtain a cursor.
2. Rotate until the 'alt/esa/msa' field is highlighted.
3. Rotate to display the desired data. Press **CRSR** to return to normal navigation.

The position page also features a **reference waypoint field**, located at the bottom of the page, to indicate your bearing and distance from a selected waypoint. The reference waypoint field can display the following:

- Range, bearing and identifier from the nearest airport (default), VOR, NDB, intersection, or user waypoint
- Range, bearing and identifier from a user specified waypoint

During DME arc approach operations, the reference field will automatically display the DME reference as long as the 'active to' waypoint is part of the DME arc.

To change the reference waypoint field to display the nearest airport, VOR, NDB, intersection, user waypoint or the range and bearing from a user selected waypoint:

1. Press **CRSR** to activate the cursor.
2. Rotate to highlight the category field after the ^fr.
3. Use to choose which waypoint type you would like displayed. (Choose 'wpt' if you would like range and bearing from a specific waypoint to be displayed.)
4. Press **CRSR** to remove the cursor, or:

If you have selected 'wpt':

5. Rotate to advance the cursor to highlight the identifier field.
6. Use the and knobs to enter the identifier name. (This waypoint identifier can be an airport, VOR, NDB, intersection, or user waypoint.) Press **ENT**.
7. Press **CRSR** to confirm the selection.

This allows the distance and bearing from any waypoint to be displayed continuously, which may be useful when an approach reference is not the closest navaid.

The GPS 155XL's **satellite status page** provides satellite information to monitor GPS coverage and receiver performance. This is helpful when you may be experiencing low signal levels due to poor coverage or installation problems.

To view the satellite status page:

1. Press **NAV** and rotate  until the satellite status page appears.

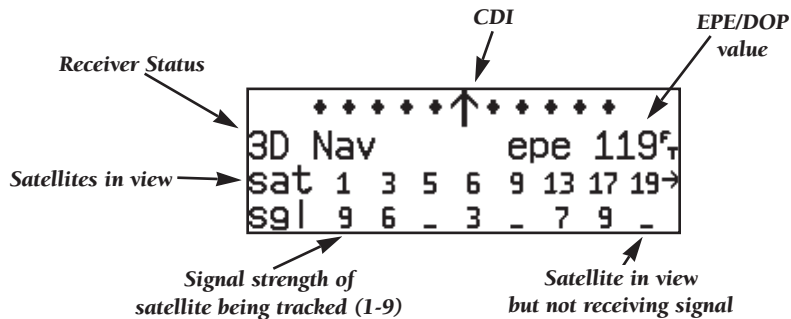

The top lines of the status page display a graphical CDI, followed by the receiver status and the current position accuracy in DOP or EPE. The default setting is DOP.

The following functions may be displayed in the DOP/EPE field:

- **dop**— Dilution of Precision, a measure of the satellite geometry quality and relative accuracy of your position, with 1 indicating good geometry and 10 meaning poor.
- **epe**— Estimated Position Error, an overall measure of your positional accuracy in feet or meters using signal and data quality, receiver tracking status and DOP.

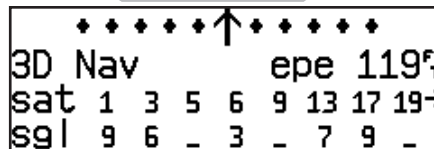
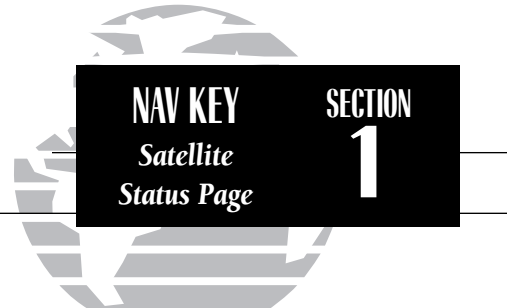

Satellite status page with 'EPE' displayed. Estimated Position Error (EPE) gives an overall measure of your position accuracy in feet or meters.

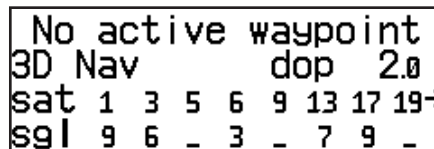

Satellite status page with 'DOP' displayed. Dilution of Precision (DOP) measures relative accuracy from 1 to 10.

SECTION

1

NAV KEY

Receiver Status Field

```
No gps position
Acquiring epe____f
sat 1 3 5 6 9 13 17 19→
sgl 9 6 - 3 - 7 9 -
```

'Acquiring' satellites for navigation. In this case, the satellites are being received, but the data is still being collected before a position can be determined.

```
No gps position
Search Sky epe____f
sat 1
sgl -
```

'Searching the Sky' for satellites. No satellite almanac data exists in the GPS 155XL. It must be recollectd from the first available satellite.

To change the DOP/EPE field:

1. Press **NAV** and rotate **○** to display the satellite status page.
2. If the desired field (EPE or DOP) is not displayed, press **CRSR**.
3. Use **○** to change between 'epe' and 'dop'. Press **CRSR** to finish.

The **receiver status field**, located on the second line (left side) of the page, will display the following messages under the appropriate conditions:

- Search Sky** - The GPS 155XL is searching the sky for visible satellites. You will be informed with the message 'Searching the Sky'.
- Acquiring** - The GPS 155XL is acquiring satellites for navigation.
- 2D Nav** - The GPS 155XL is in 2D navigation mode. If your installation does not include an altitude serializer, you must enter the altitude manually (see page 2). '2D Dif Nav' will appear when you are receiving DGPS corrections in 2D mode.
- 3D Nav** - The GPS 155XL is in 3D navigation mode and will compute altitude. '3D Dif Nav' will appear when you are receiving DGPS corrections in 3D mode.
- Simulator** - The GPS 155XL is in simulator mode, which should only be used for practice and trip planning. **Never** use simulator mode for actual navigation.
- Poor Cvrge** - The GPS 155XL cannot acquire sufficient satellites for navigation.
- Need Alt** - The GPS 155XL needs altitude in order to start/continue navigation. Press **NAV** to display the position page and enter altitude.
- Not Usable** - The GPS 155XL is unusable due to incorrect initialization or abnormal satellite conditions. Turn the unit off and on again.
- AutoLocate** - The GPS 155XL is looking for any satellite whose almanac has been collected. This process can take up to five minutes.





The third and fourth lines of the satellite status page provide the satellite number and signal strength of each satellite in view. The satellite status page shows signal strength for up to eight satellites at a time. If additional satellites are being received an arrow on the 'sat' line will indicate additional data is available.

To view additional satellites:

1. Rotate  to view more satellites.



Additional information regarding each satellite's azimuth, elevation and other data is also available.

To view individual satellite information:

1. Press  and use  to display the satellite status page.
2. Press  to activate the cursor.
3. Use  to highlight the satellite number you wish to view and press .

This will display the satellite data page, showing the selected satellite's number, elevation angle, rise or fall indication, User Range Accuracy (URA, or the range measurement accuracy as determined by the satellite), azimuth and signal strength.

To view other satellites:

4. Rotate  to view information for the next satellite.
5. Rotate  and press  on the satellite status page when you are finished.

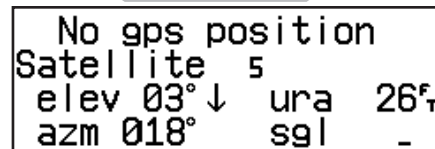
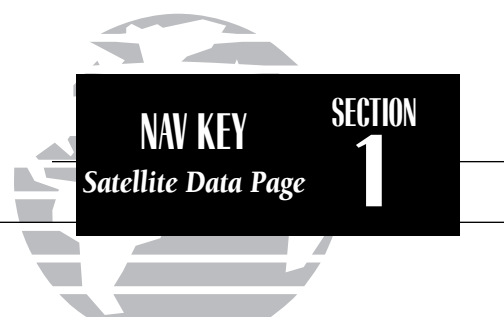

Viewing individual satellite information.

SECTION

1

NAV KEY

NAV Menu 1 Trip Planning

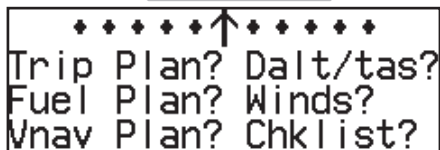

```
♦ ♦ ♦ ♦ ♦ ↑ ♦ ♦ ♦ ♦ ♦
Trip Plan? Dalt/tas?
Fuel Plan? Winds?
Vnav Plan? Chklist?
```

NAV Menu 1

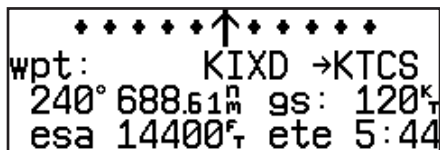

```
♦ ♦ ♦ ♦ ♦ ↑ ♦ ♦ ♦ ♦ ♦
Wpt: KIXD →KTCS
240° 688.61M gs: 120KT
esa 14400f ete 5:44
```

Trip planning with values calculated between two waypoints.

In addition to the five other navigation pages, the GPS 155XL features two menu pages to perform a host of planning and navigation functions. **NAV Menu 1** provides access to the following functions:

- **Trip Planning**
- **Fuel Planning**
- **VNAV Planning**
- **Density altitude/true airspeed calc.**
- **Winds aloft calculations**
- **Checklists**

To display NAV Menu 1:

1. Press **NAV**.
2. Rotate **○** until NAV Menu 1 is displayed.







Trip Plan is the first function listed on NAV Menu 1 and allows the pilot to view distance, ESA, bearing and estimated time enroute (ETE) between any two waypoints, and for programmed route legs. The ground speed can be varied manually to calculate several possible ETEs.

To use the trip planning function:

1. Press **NAV** and rotate **○** until NAV Menu 1 is displayed.
2. Press **CRSR**, then **ENT** to access trip planning.
3. Rotate **●** to select waypoint mode or desired route number and press **ENT**.
4. For direct-to navigation, use **●** and **○** to enter the 'to' and 'from' waypoints. Press **ENT** to accept the waypoints. To use your present position as a waypoint, leave the waypoint field blank.
5. For route calculations, choose either 'cum' for cumulative data (from beginning to end) or the leg desired by rotating **●**.
6. Use **●** and **○** to enter the ground speed. Press **ENT** to calculate the values and **CRSR** to finish.

The **density altitude/true airspeed function** is also accessed from NAV Menu 1. Density altitude is the theoretical altitude at which your aircraft will perform depending on several environmental conditions, including air pressure and total air temperature (the temperature including the heating effect of speed, read on a standard outside temperature gauge on most aircraft). True airspeed considers the same factors.

To calculate the density altitude and true air speed:

1. Press **NAV** and rotate **○** until NAV Menu 1 is displayed.
2. Press **CRSR** and rotate **○** to highlight 'Dalt/tas?'.

3. Press **ENT** to access the density altitude page.

4. Use **●** and **○** to enter the indicated altitude ('ialt') and press **ENT**.

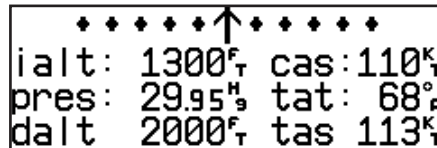
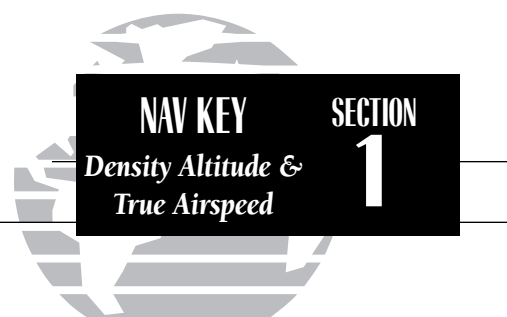
5. Use **●** and **○** to enter the calibrated airspeed ('cas'). Press **ENT**.

6. Use **●** and **○** to enter the air pressure ('pres') and press **ENT**.

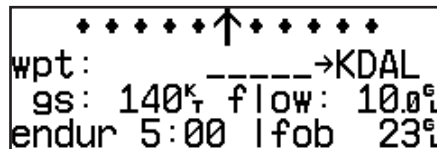
7. Use **●** and **○** to enter the total air temperature ('tat').
8. Press **ENT** and the density altitude and true airspeed will be calculated and displayed.

9. Press **CRSR** to remove the cursor.

If your installation includes components to provide any of the information required on the density altitude page, they will be used as the defaults.

The **fuel planning** page will display fuel requirements for both direct-to navigation and programmed routes. The fuel planning function requires the pilot to enter the initial amount of fuel on board and the flow rate. You may also enter different ground speeds to view information based on different travel times. If your installation is interfaced to a fuel flow sensor, the flow rate and other information will be supplied by the fuel flow sensor, and need not be entered manually.



Density altitude/true airspeed page



Fuel planning page showing calculation from present position to 'KDAL'.

SECTION

1

NAV KEY

NAV Menu 1
Fuel Planning

```

♦ ♦ ♦ ♦ ♦ ↑ ♦ ♦ ♦ ♦ ♦
wpt:      KICT →KFOE
fob:      23g flow: 6.5g
rng 495.4m lfob 18g

```

Fuel planning page showing calculations between two waypoints.







```

♦ ♦ ♦ ♦ ♦ ↑ ♦ ♦ ♦ ♦ ♦
wpt:      KICT →KFOE
fob:      23g flow: 6.5g
endur 3:32 rsv 2:43

```

Fuel planning page with other information indicating 'endurance' and 'reserve' times.









To perform fuel planning operations:

1. Press **NAV** and rotate  until NAV Menu 1 is displayed.
2. Press **CRSR** and rotate  until 'Fuel Plan?' is highlighted. Press **ENT**.
3. Rotate  to select either 'wpt' for direct navigation or the desired route number. Press **ENT**.
4. For waypoint-waypoint navigation, use  and  to enter the 'to' and 'from' waypoints. Press **ENT** to accept the waypoints. To use the present position as a waypoint, leave the corresponding waypoint field blank.
5. For route calculations, choose either 'cum' for cumulative route fuel requirements (from beginning to end) or the leg desired by rotating .

If leg is selected, it displays the amount of fuel required to fly until that leg is complete.

For example: The fuel required to complete leg 2 is leg 1 + leg 2.

Fuel required to complete leg 4 is leg 1 + leg 2 + leg 3 + leg 4.

6. Rotate  to advance the cursor to 'fob:' or 'gs:' (depending on which is displayed).
7. Use  and  to enter the fuel on board or the ground speed. Press **ENT**.
8. Rotate  back two positions to highlight the 'fob:' or 'gs:' field again.
9. Rotate  to display the other information. Press **ENT**.
10. Use  and  to enter the remaining data. Press **ENT**.
11. Use  and  to enter the flow rate, in units per hour, if needed. Press **ENT**.

The GPS 155XL will calculate the range and endurance (i.e., how long the fuel will last) of your aircraft. These are found in the first field on the bottom row of the page. The amount of fuel left on board (lfob) and reserve time after the selected direct-to, leg or route is flown are displayed in the second field on the bottom row.

The GPS 155XI's **winds aloft function** is used to calculate the true direction and speed of any winds, and indicates whether you are flying with a head wind or tail wind, and the wind speed.

To calculate winds aloft:

1. Press **NAV** and rotate **○** until NAV Menu 1 is displayed.
2. Press **CRSR** and rotate **○** until 'Winds?' is highlighted. Press **ENT**.
3. Use **○** and **○** to enter your present heading in the 'hdg:' field. If your installation includes a fuel/air data computer, this will be displayed automatically. Press **ENT**.
4. Use **○** and **○** to enter your true airspeed (TAS) in the 'tas:' field. If you have previously calculated it using the density altitude/true air speed function, it will be displayed as the default. Press **ENT**. The wind direction and speed and head/tail wind will be displayed.

The **VNAV function** calculates vertical speed requirements to reach a desired altitude before or after a specified distance from a waypoint. This is helpful when you'd like to descend to a certain altitude near an airport or climb to an altitude before reaching a route or direct-to waypoint.

To calculate vertical navigation parameters:

1. Press **NAV** and rotate **○** until NAV Menu 1 is displayed.
2. Press **CRSR** and rotate **○** until 'Vnav Plan?' is highlighted. Press **ENT**.
3. Use **○** and **○** to enter the initial (from) altitude. Your current GPS altitude will be displayed as the default. Press **ENT**.
4. Use **○** and **○** to enter the desired final (to) altitude. Press **ENT**.
5. Use **○** and **○** to enter the distance from the waypoint. Press **ENT**.
6. Use **○** to select 'before' or 'after' the waypoint. Press **ENT**.
7. Use **○** and **○** to select the waypoint identifier (it must be a waypoint in the active route or a direct-to waypoint). Press **ENT**.

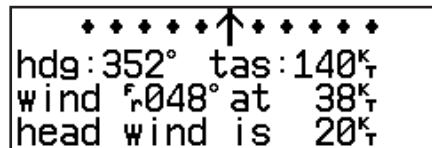

Winds aloft page

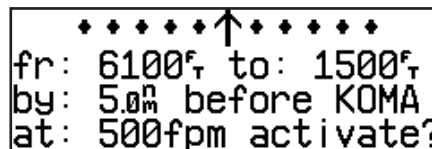

Vertical navigation page

SECTION

1

NAV KEY

NAV Menu 1
VNAV & Checklists

dis 16.58^N gs : 120^K_T
brg 064° dtk 064°
go to: KMKC vn 4500^F_T

VNAV displayed on NAV summary page. The VNAV altitude should be compared with the reading on the aircraft altimeter to ensure you are on the proper climb/descent angle.

Select check list
:PRE TAXI
↓ :EMERGENCY

Checklist catalog page.

You will now notice that the vertical speed has been calculated, based on your present speed. If you desire a more rapid climb or descent rate:

- Use and to enter the new desired vertical speed, or press to accept the calculated value.
- Press to activate the vertical navigation function.

If you enter a value greater than the value computed by the GPS 155XL, the time remaining before the maneuver is to begin will be displayed. When the countdown reaches 15 seconds, you will be informed with the message 'Start altitude chng'. The VNAV function will automatically be cancelled if the active direct-to or route is changed in any way, and you will be informed with a 'VNAV cancelled' message.

The GPS 155XL will allow you to create up to nine **checklists** with 30 items each to remind you of repetitive tasks (that can be called up at any time for review). The checklist feature is useful for creating pre-flight checklists, landing checklists, emergency procedures, etc. Each name or function can have up to 16 characters each.

To create a checklist:

- Press and rotate until NAV Menu 1 is displayed.
- Press and rotate until 'Chklist?' is highlighted. Press .
- Press and use to highlight the checklist you would like to create or edit. Press .
- Use and to enter the title of the checklist. Press .

This will display the checklist items page. On this page you can enter each task, such as 'Check Fuel'.

- Use and to enter the checklist item. Press .
- You may repeat step 5 to enter additional items, or press to finish.

To execute a checklist:

1. Press **NAV** and rotate **○** until NAV Menu 1 is displayed.
2. Press **CRSR** and rotate **○** until 'Chklist?' is highlighted. Press **ENT**.
3. Use **○** to highlight the checklist you would like to see. Press **ENT**.
4. Press **ENT** to check off list items.

To delete a checklist item or an entire checklist:

1. To delete a checklist item, highlight the desired item and press **CLR**, followed by **ENT**.
2. To delete an entire checklist, highlight the desired list and press **CLR**, followed by **ENT**.

The GPS 155X1's **NAV Menu 2** provides access to various timer and planning functions, including:

- **Approach timer**
- **Trip Timer**
- **Scheduler messages**
- **Clock (Date and time)**
- **RAIM Prediction**
- **Sunrise and sunset calculations**

The **approach timer** acts as either a count up or a count down timer that can be set or reset at any time.

To activate/change/view the approach timer:

1. Press **NAV** and rotate **○** until NAV Menu 2 is displayed.
2. Press **CRSR** and rotate **○** until 'Appr Time?' is highlighted. Press **ENT**.
3. Rotate **●** to select either 'Count up' or 'Count down'. Press **ENT**.
4. Use **●** and **○** to set the time to begin counting from. Press **ENT**.
5. Rotate **○** to select the desired function: 'Start', 'Stop', or 'Reset'. Press **ENT** to execute.



Executing a checklist.

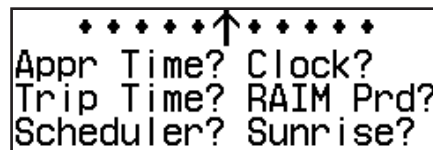

NAV Menu 2

SECTION

1

NAV KEY

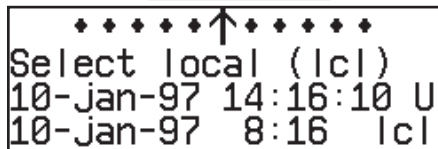
Clock Function
Trip Timer

Select local (lcl)
10-jan-97 14:16:10 U
10-jan-97 8:16 lcl

Clock function set to display local time in the time fields of all other GPS 155XL pages.

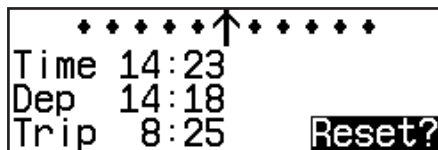







Time 14:23
Dep 14:18
Trip 8:25 **Reset?**

To reset the trip timer, highlight 'Reset?' and press **ENT**.

When the countdown timer reaches zero, you will be informed with a 'Timer expired' message. The timer will then begin to count up, displaying the time since it expired. The timer runs, if not altered, whenever the GPS 155XL is turned on.



The GPS 155XL **clock function** keeps track of both UTC time (Greenwich Mean Time or Zulu Time calculated from the satellites) and local time, and allows you to designate which format to use in all time displays. The local time and date can be set without displaying local time on other GPS 155XL pages.

To set the local date/time:

1. Press **NAV** and rotate  until NAV Menu 2 is displayed.
2. Press **CRSR** and rotate  until 'Clock?' is highlighted. Press **ENT**.
3. Use  to select either 'utc' or 'local' time to be displayed in the time fields. Press **ENT**.
4. Use  and  to set the local date. Press **ENT**.
5. Use  and  to set the local time. Press **ENT**.
6. Press **CRSR** to complete.









The GPS 155XL's **trip timer** will automatically keep track of the duration of your current trip and can be configured to run when the GPS 155XL is on, or only when your ground speed exceeds a specified value (see Section 6).

To view or reset the trip timer:

1. Press **NAV** and rotate  until NAV Menu 2 is displayed.
2. Press **CRSR** and rotate  until 'Trip Time?' is highlighted. Press **ENT**. The current time of day, departure time and time enroute will be displayed.
3. To reset the timer, press **ENT**. To skip resetting the timer, press **CRSR**.

The **RAIM Prediction function** allows you to confirm that GPS coverage is available for your current location or at a specified waypoint any day of the year. **Receiver Autonomous Integrity Monitoring** performs checks to ensure that the GPS 155XL will have adequate satellite geometry to work with during your flight. RAIM availability will be near 100% in Oceanic, En route and Terminal phases of flight. Because the FAA's TSO requirements for non-precision approaches specify significantly better satellite coverage than other flight phases, RAIM may not be available when flying some approaches. The GPS 155XL will automatically monitor RAIM during approach operations and warn you if RAIM is not available. RAIM prediction will help you plan for a pending flight to confirm GPS operation during an approach.

To predict RAIM availability:

1. Press **NAV** and rotate  until NAV Menu 2 is displayed.
2. Press **CRSR** and rotate  to highlight 'RAIM Prd?'. Press **ENT**.
3. Rotate  to highlight the field which you would like to change.
4. Use  and  to enter the waypoint name, or leave it blank to use your current position. Press **ENT** to accept.
5. Use  and  to enter the ETA in hours and minutes (in local or UTC time, whichever you have selected from the clock display), and the day, month and year. The current date will be displayed automatically. Press **ENT** to accept.
6. Rotate  to highlight 'Compute RAIM?'. Press **ENT** to compute information.

When the computations are complete, the GPS 155XL will display whether or not RAIM is available for the specified waypoint at the specified date and time, +/- 15 minutes of your ETA. Refer to the table on page 99 for specific RAIM protection limits as they relate to CDI scale figures.



```

  * * * * * ↑ * * * * *
wpt:KTCS
eta:23:50 10-jan-98
Compute RAIM?
  
```

Enter the location, time and date for RAIM prediction.

```

  * * * * * ↑ * * * * *
wpt:KTCS
eta:23:50 10-jan-98
RAIM Available
  
```

RAIM available for the entered time, date and waypoint location.

SECTION

1

NAV KEY

NAV Menu 2

Scheduler

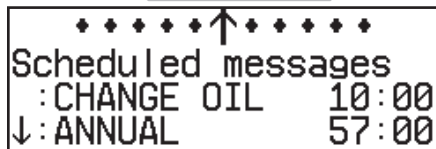

The scrolling arrow prompt indicates which direction to scroll to view additional listings.

No gps position
CHANGE OIL

The scheduled message will appear after the timer expires and reappear every time the GPS 155XL is powered on until the message is changed.

The **scheduler function** will display reminder messages (such as ‘Change oil’, ‘Switch fuel tanks’, ‘Overhaul’, etc) after a specified time has elapsed. For example, if you enter ‘Change oil’ to be displayed in 30 hours, the message ‘Change oil’ will be displayed after the GPS 155XL has been running in Normal mode for 30 hours. After appearing, the message will be displayed each time the GPS 155XL is turned on until it is changed or deleted.

To enter a scheduled message:

1. Press **NAV** and rotate to display NAV Menu 2.
2. Press **CRSR** and rotate until ‘Scheduler?’ is highlighted.
3. Press **ENT**.
4. Rotate to highlight the message you would like to edit. To delete, press **CLR**, then **ENT**.
5. Use and to enter the message. Press **ENT**.
6. Use and to set the time to elapse before the message is displayed, in hours and minutes, up to 99 hours and 59 minutes (this time is cumulative and counts whenever the GPS 155XL is on in Normal operating mode).
7. Press **ENT**.

You may edit another scheduled message by repeating steps 4, 5, 6 and 7 or if you are finished, press **CRSR**.

The GPS 155XI's **sunrise/sunset planning function** allows you to calculate the time of sunrise or sunset at any waypoint or your present position for a specified date.

To calculate sunrise and sunset times at a waypoint or at your present location:

1. Press **NAV** and rotate **○** until NAV Menu 2 is displayed.
2. Press **CRSR** and rotate **○** to highlight 'Sunrise?'. Press **ENT**.
3. Use **○** and **○** to enter the waypoint identifier, or leave blank to use current position. Press **ENT**.
4. Press **ENT** to accept the waypoint information.
5. Use **○** and **○** to enter the date desired.
6. Press **ENT** and the sunrise and sunset times will be calculated and displayed. The times will be displayed in your local time or UTC time, whichever is specified from the clock function on NAV Menu 2.

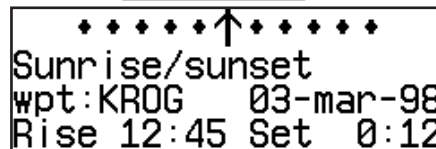
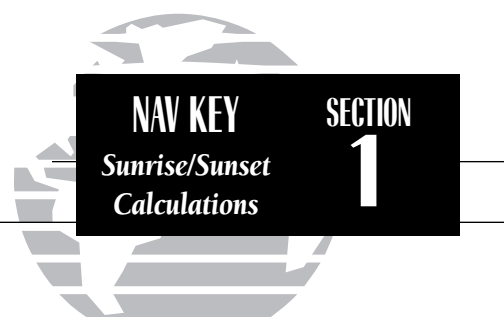

Sunrise/sunset planning page showing UTC (Zulu) sunrise and sunset times for 'KROG'.

SECTION 2

WPT KEY Overview

Please note that your GPS 155XL uses ICAO identifiers for all airports. All U.S. airport identifiers which contain only letters use the prefix 'K'. For example, Los Angeles International is KLAX under the ICAO standard. Other airports, such as Otten Memorial (3VS), that contain numbers in the identifier do not require the 'K' prefix. Many foreign countries use two letter prefixes. For more information on ICAO identifiers, contact:

Document Sales Unit
International Civil Aviation Organization
999 University Street
Montreal, Quebec
Canada H3C 5H7

Section 2 Waypoint and Database Information

The GPS 155XL uses a Jeppesen NavData® card to provide position and facility information for thousands of airports, VORs, NDBs and intersections. Each facility in the database is stored as a waypoint with its own latitude/longitude, identifier (up to five letters and/or numbers), and other pertinent information. Up to 1,000 user waypoints may also be created and stored in the GPS 155XL's internal memory.

Waypoint Menu Page

```
*****↑*****  
Select waypoint type  
apt? vor? ndb?  
int? user?
```

Proximity Waypoints Page

```
*****↑*****  
Proximity waypoints  
:KACY dis:15.0M  
:_____ dis:____M
```



```
*****↑*****  
Wpts with comments  
KACY KIXD KLAX  
KSUSM
```

Waypoints With Comments List

```
*****↑*****  
3 user waypoints  
HOME  
KSUSM in rt 2
```

User Waypoint List

Waypoint information is available through four primary waypoint pages accessible from the GPS 155XL's **WPT** key. The waypoint pages may be scrolled through by pressing the **WPT** key and rotating the outer knob until the desired page is displayed, or by pressing the **WPT** key repeatedly.

The GPS 155XL organizes waypoints into one of five waypoint categories for your convenience. Each waypoint category provides different types of detailed information for a selected facility:

- **Airports** - Identifier, city/state, country, facility name, position (lat/lon), elevation, fuel services, control and approach information, IFR procedures, runways and communication frequencies.
- **VORs** - Identifier, city/state, country, facility name, position (lat/lon), frequency, magnetic variation, co-located DME or TACAN and weather broadcast indication.
- **NDBs** - Identifier, city/state, country, facility name, position (lat/lon), frequency and weather broadcast indication.
- **Intersections** - Identifier, country, position (lat/lon) and nearest VOR.
- **User** - Identifier (name), position (lat/lon) and reference waypoint.

To view detailed waypoint information for a desired waypoint, select the appropriate waypoint category from the waypoint menu page.

To choose a waypoint category (for viewing information):

1. Press **WPT** and rotate **○** to display the waypoint menu page. (If pressing **WPT** once does not display the waypoint menu page, press **WPT** a second time.)
2. Press **CRSR** and rotate **○** to highlight the desired waypoint category.
3. Press **ENT** to accept the waypoint category. The waypoint identification or position page for the selected category will appear with the waypoint identifier field ready for entry.



WPT KEY SECTION

Waypoint Categories & Menu Page 2

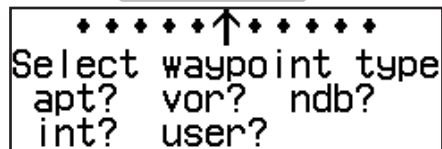

The waypoint menu page allows you to select the desired waypoint type (or category).

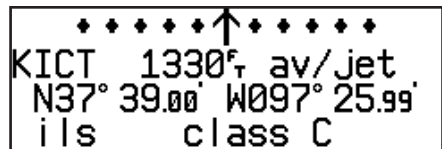

The airport position page shows the position, field elevation and available fuel types for the selected airport.

SECTION

2

WPT KEY

Entering Waypoints



```

♦ ♦ ♦ ♦ ♦ ↑ ♦ ♦ ♦ ♦ ♦
apt: KUK N CEN USA
BURLINGTON KS
COFFEY CO
  
```

Entering a waypoint by identifier.



```

♦ ♦ ♦ ♦ ♦ ↑ ♦ ♦ ♦ ♦ ♦
apt: KSTL N CEN USA
ST LOUIS MO
LAMBERT ST LOUIS INT
  
```

Entering a waypoint by city. Note that punctuation marks are not used when entering locations or names. Use spaces, where appropriate, to identify these marks. For example, St. Louis would be entered as "ST LOUIS" without a period.











After a waypoint category is selected, information for a waypoint may be viewed by entering the identifier or name of the desired waypoint. Airports, VORs and NDBs may be entered by either the identifier, name or the location (city) of the facility. Intersections and user waypoints must be entered by the identifier.



To enter a waypoint identifier:

1. With the cursor over the waypoint field, use  and  to enter the waypoint identifier.

As the identifier is entered, the GPS 155XL's Spell'N'Find™ feature will scroll through the available database, displaying those waypoints matching the identifier letters you have entered to that point. When the desired waypoint is displayed, press  to remove the cursor.

To obtain waypoint information by entering the facility name of the airport or navaid, or its location:

1. Press  and rotate  to display the waypoint menu page.
2. Press  and rotate  to highlight the desired waypoint category.
3. Press  to accept the waypoint category.
4. Rotate  to highlight the middle field to enter location (city) **OR**:
Rotate  to highlight the bottom field to enter facility name or VOR/NDB name.
5. Use  and  to enter the location or the name, and press  to finish.

As the information is entered, the GPS 155XL will display any entries in its database that match the letters you have entered. If duplicate entries exist for the entered identifier, name or location, additional entries may be viewed by rotating . Once the desired waypoint is displayed, press  to continue.

Once a waypoint category and identifier have been selected, the GPS 155XL will provide extensive information through a set of waypoint pages for the selected category. The pages available for each waypoint category are presented here in the order they appear on the waypoint menu page: airports, VORs, NDBs, intersections and user waypoints.

Airport Information

Airport Identification Page

```

*****↑*****
apt:KICT N CEN USA
WICHITA KS
WICHITA MID CONTINEN
  
```

Airport Comments Page

```

*****↑*****
apt:KICT comments
INTENSIVE FLIGHT
TRAINING
  
```

Airport Position Page

```

*****↑*****
KICT 1330' av/jet
N37° 39.00' W097° 25.99'
ils class C
  
```

```

*****↑*****
KICT↓ 01L/19R 10300'
hard srfc ft lights
ils ITWI 109.10 rw01L
  
```

Airport Runway Page

```

*****↑*****
KICT↓ ats%125.15
clr 125.70 gnd 121.90
twr 118.20 uni 122.95
  
```

Airport Communication Page

```

*****↑*****
KICT approach
ndb rw01R
☪ rnav rw01L
  
```

Airport Procedures Page

```

*****↑*****
apt:KTCS SW USA
TRUTH OR CONSEQUENCE NM
OR CONSEQUENCES MUN
  
```

If the city or facility name information is too long to fit the screen, the name will scroll across the page every few seconds so the complete name can be read.

```

*****↑*****
KICT 1330' av/jet
N37° 39.00' W097° 25.99'
ils class C
  
```

The airport position page shows the position, field elevation and available fuel types for the selected airport.

To scroll through the airport pages:

1. Make sure the cursor is not present. If it is, press **CRSR**.
2. Rotate  in either direction to scroll through the available pages.



SECTION

2

WPT KEY

Airport Pages

```

*****↑*****
KICT↓      atsr125.15
clr 125.70  gnd 121.90
twr 118.20  uni 122.95
    
```

Airport communication page. The down arrow next to the identifier indicates additional frequencies may be displayed by rotating the  knob.

```

*****↑*****
KICT↓ 01L/19R 10300r
hard srfc  ft lights
ils ITWI 109.10  rw01L
    
```

Airport runway page. The down arrow next to the identifier indicates additional runways may be displayed by rotating the  knob.

The GPS 155XL features six airport pages:

airport identification— allows entry of desired airport by identifier, facility name or city; displays region and/or country of facility.

airport position— allows entry of desired airport by identifier; displays latitude, longitude and elevation; indicates usage and fuel availability; displays available approaches and airport control/radar capability.

airport procedures— allows entry of desired airport by identifier; displays all available approaches, SIDs and STARs at the selected facility.

airport communication— allows entry of desired airport by identifier; displays radio frequencies/usage, and sector and altitude restrictions.

airport runway— allows entry of desired airport by identifier; indicates runway designations, length, surface and lighting information; displays ILS/localizer and/or pilot-controlled lighting frequencies.

airport comments— allows entry of desired airport by identifier; displays user comments for the selected airport.

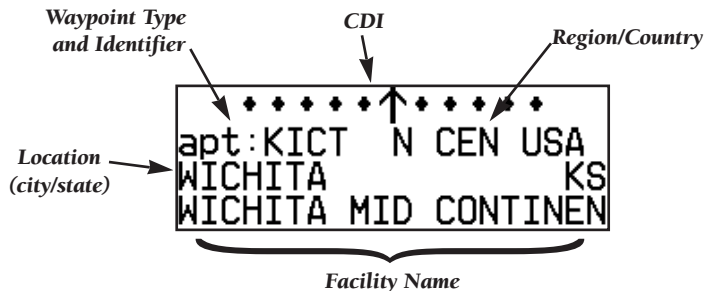

The **airport identification page** displays a selected airport's identifier, region and country, city/state and facility name. The identification page is always the first airport page available, allowing you to quickly review an airport facility or select another facility by entering the identifier, facility name or city of the desired airport.

The **airport position page** displays the latitude, longitude and elevation of the selected airport, as well as usage or fuel availability, available approaches and airport control/radar capability. The following descriptions and abbreviations are used on the airport position page:

Elevation— In feet or meters

Usage/Fuel— If the airport is for military use, it will display ‘military’.

If it is private, the GPS 155XL will display ‘private’. If it is a public airport, it will display the fuel type(s) available:

- **av gas**— 80-87 octane, 100 LL, 100-130 octane, or mogas is available
- **jet**— Jet A, Jet A-1 or Jet A+ fuel is available
- **av/jet**— Both av gas and jet fuel are available

Position— In degrees/minutes or degrees/minutes/seconds of latitude and longitude

Approach Information— displays the airport approaches available

- **no apr**— No approach is available
- **np-apr**— Non-precision approach is available
- **loc**— Localizer approach is available
- **ils**— ILS approach is available

Controlled Airspace Information— displays controlled airspace type

- **class B**
- **class C**
- **cta**
- **tma**

Radar— displays approach/departure radar capability

- **radar**— indicates radar is present

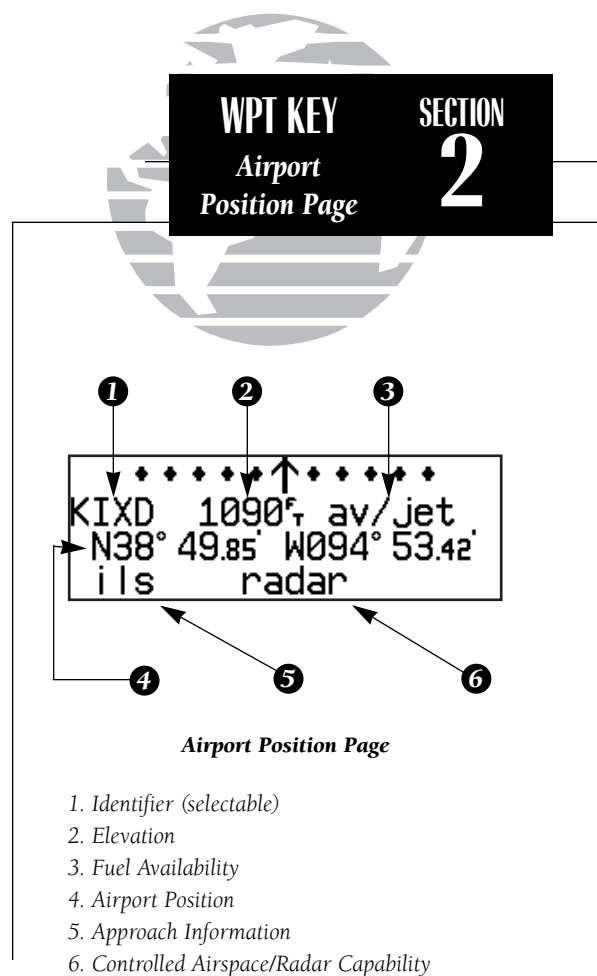

SECTION

2

WPT KEY

Airport Procedures
Page

SID Procedures Page



STAR Procedures Page

The **airport procedures page** displays all the available approaches, SIDs and STARs at any selected airport in the database, without placing a specific approach, SID or STAR in the active route. This allows the pilot to quickly scan the procedures of any nearby airport in case of an emergency or help plan future flights. You may view the available non-precision approaches, SIDs or STARs by selecting the desired list from the procedure type field.

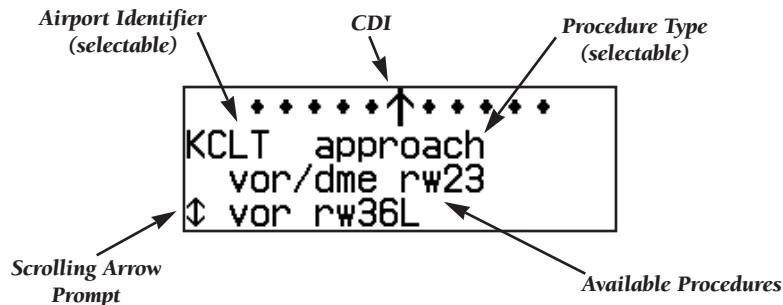

**To view the available procedures for a selected airport:**

1. Press **WPT** and rotate to display the airport procedures page.
2. Press **CRSR** and rotate to highlight the procedure field.
3. Rotate to select the approach, SID or STAR list.
4. Press **CRSR** to remove the cursor.

Whenever there are more than two available procedures for a selected category, the GPS 155XL will display a scrolling arrow prompt on the left side of the list. To view additional procedures, simply rotate with the cursor removed. As you scroll through the list, the arrow prompt will point “down” to indicate additional listings below the displayed procedures, “up” to indicate additional listings above, or a “double arrow” to indicate the list may be scrolled up or down.

The **airport communication page** displays the radio frequencies and usage for the selected airport, as well as sector and altitude restrictions.

To view the communication page from any of the airport information pages:

1. Rotate  with the cursor removed to display the communication page.
2. Rotate  in the direction of the arrow prompt to view additional frequencies. You may also view additional frequencies with the cursor on the page by rotating the  knob.

The following descriptions and abbreviations are used on the communication page:

Frequencies without restriction information:

- **ats** - Automatic terminal information service (ATIS)
- **ptx** - Pre-taxi
- **clr** - Clearance delivery
- **gnd** - Ground
- **twr** - Tower
- **uni** - Unicom
- **mul** - Multicom
- **atf** - Aerodrome traffic frequency
- **ctf** - Common traffic advisory frequency (CTAF)
- **mf** - Mandatory frequency
- **oth** - Other frequencies

Frequencies with restriction information:

- **dep** - Departure
- **apr** - Approach
- **arrv** - Arrival
- **class B**
- **cta** - ICAO control area
- **tma** - ICAO terminal control area
- **class C**
- **trsa** - Terminal radar service area

'Receive only' frequencies will be followed by an 'rx' indicator, while 'transmit only' frequencies will display a 'tx'. If a frequency has sector and/or altitude restrictions, they will also be displayed. Sector restrictions define a range of radials from the facility, while altitude restrictions may describe an area above, below or between altitudes. Additional instructions, if available, will be displayed on the bottom line.



Airport communications page for KCLT.

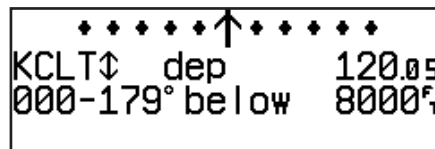

Frequency page with sector restrictions.

SECTION

2

WPT KEY

Airport Runway Page

```
*****↑*****
KICT↓ 01L/19R 10300ft
hard srfc ft lights
ils ITWI 109.10 rw01L
```

Airport runway page for KICT.

```
*****↑*****
KICT↓ 01R/19L 7300ft
hard srfc ft lights
ils IICT 110.30 rw01R
```

To view additional runways, rotate the ● knob in the direction of the arrow prompts.

The **airport runway page** displays runway designations, length, surface and lighting for the selected airport, as well as ILS/localizer and/or pilot-controlled lighting frequencies.

To view the runway page from any of the airport information pages:

1. Rotate ● with the cursor removed to display the runway page.
2. To view additional runway information, rotate ● with the cursor removed.
The scrolling arrow prompt, located beside the identifier field, indicates which direction to scroll for additional runway information.

If a localizer and/or ILS are used on the same runway, rotating ● will sequence through both sets of information.

The following descriptions and abbreviations are used on the airport runway page:

Runway surfaces:

- **hard** - Hard (concrete, asphalt, etc.)
- **seal** - Sealed surface
- **dirt** - Dirt surface
- **unkn** - Unknown surface
- **turf** - Turf (grass)
- **grav** - Gravel surface
- **soft** - Unknown soft surface
- **watr** - Water landing site

Runway lighting:

- **pt lights** - Part-time lights
- **ft lights** - Full-time lights
- **pc** - Pilot-controlled (with frequency) lights
- **no lights** - No runway lighting

VOR Information

The GPS 155XL features three VOR waypoint pages:

VOR identification— allows entry of desired VOR by identifier, facility name or city; displays region and/or country of facility.

VOR position— allows entry of desired VOR by identifier; displays latitude, longitude and frequency; provides magnetic variation, weather broadcasts and DME/TACAN information.

VOR comments— allows entry of desired VOR by identifier; displays user comments for the selected facility.

VOR information is accessed by entering the desired facility by identifier, city or facility name (see page 34) on any VOR waypoint page. The VOR identification and comments pages are identical in form and function to their airport page counterparts.

To scroll through the VOR pages:

1. Make sure the cursor is not present. If it is, press **CRSR**.
2. Rotate **⊙** in either direction to scroll through the available pages.

In addition to displaying the VOR frequency, magnetic variation and position, the VOR position page indicates if a DME or TACAN is co-located at the facility. The 'wx bdcst' field indicates that the VOR also transmits weather information.

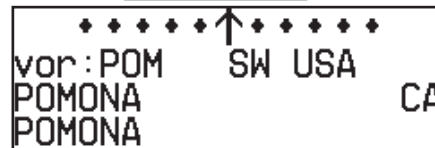

VOR identification page

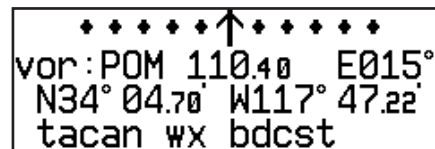

VOR position page showing co-located TACAN facility and weather broadcast.

SECTION

2

WPT KEY

NDB Information

 A screenshot of the NDB identification page. At the top, there is a row of 12 diamond-shaped icons with an upward-pointing arrow above the 6th icon. Below this, the text is displayed in a monospaced font: "ndb: AM" on the first line, "TAMPA" on the second line, and "PICNY" on the third line. To the right of "ndb: AM" is "SE USA" and "FL" is on the far right.

```

ndb: AM      SE USA
TAMPA
PICNY      FL
  
```

NDB identification page



 A screenshot of the NDB comments page. At the top, there is a row of 12 diamond-shaped icons with an upward-pointing arrow above the 6th icon. Below this, the text is displayed in a monospaced font: "ndb: AM" on the first line, "WX BDCST" on the second line, and "comments" on the third line, followed by "INOP" on the fourth line.

```

ndb: AM      comments
WX BDCST    INOP
  
```

NDB comments page

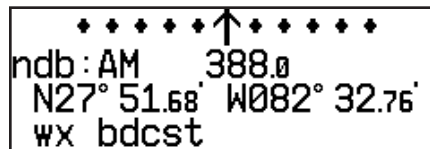
NDB Information

 A screenshot of the NDB position page. At the top, there is a row of 12 diamond-shaped icons with an upward-pointing arrow above the 6th icon. Below this, the text is displayed in a monospaced font: "ndb: AM" on the first line, "388.0" on the second line, "N27° 51.68' W082° 32.76'" on the third line, and "WX bdcst" on the fourth line.

```

ndb: AM      388.0
N27° 51.68' W082° 32.76'
WX bdcst
  
```

NDB Position Page

The GPS 155XL also uses identification, position and comments pages for NDB information. The NDB waypoint pages are used in the same manner as VOR pages: NDB information is accessed by entering the desired facility's identifier, city or name (see page 34) on the NDB identification page.

To scroll through the NDB pages:

1. Make sure the cursor is not present. If it is, press **CRSR**.
2. Rotate **⊙** in either direction to scroll through the available pages.

The NDB position page (see above) displays the selected facility's identifier, frequency and position, as well as any weather broadcasts available. The NDB comment page will display any user comments for the selected NDB (see page 50 for instructions on entering user comments).

Intersection Information



Intersection Position Page

The last database waypoint category available is intersections. Two intersection pages are available: intersection position and intersection comments. Intersections may be entered by identifier only (not city or name) on either intersection page.

To scroll through the intersection pages:

1. Make sure the cursor is not present. If it is, press **CRSR**.
2. Rotate **○** to toggle between the available pages.

The intersection position page displays the selected facility's identifier, region and/or country, latitude and longitude, and the identifier, distance and bearing to the nearest VOR (not necessarily the VOR used to define the intersection). The intersection comment page will display any user comments for the selected intersection (see page 50).



Intersection comments page

SECTION

2

WPT KEY

User Waypoints



A monochrome LCD display showing a user waypoint page. At the top, there is a row of 12 diamond-shaped icons with an upward-pointing arrow in the center. Below this, the text reads: "usr : KSUSM", "N39° 12.37' W096° 35.41'", and "fr : KTOP 275.9° 45.9M".

User waypoint page





A monochrome LCD display showing a user waypoint comments page. At the top, there is a row of 12 diamond-shaped icons with an upward-pointing arrow in the center. Below this, the text reads: "usr : KSUSM comments" and "KSU FOOTBALL STADIUM".

User waypoint comments page

User Waypoint Information







In addition to the airport, VOR, NDB and intersection waypoints contained in your NavData® card, the GPS 155XL allows you to store up to 1,000 user-defined waypoints. Once a user waypoint is created, two user waypoint pages will display the following information:

- Waypoint identifier
- Position in latitude and longitude
- Identifier, range and bearing from a reference waypoint
- User comments

To scroll between the user waypoint position page and the user comments page, rotate . User waypoints may be created or modified using the  key. After selecting the waypoint identifier, as shown on page 34, you will be prompted to enter information if the waypoint is new. There are three ways to create a user waypoint's position from the  key:

1. Enter the exact position of the new waypoint.
2. Reference a known waypoint by range and bearing.
3. Enter a range and bearing from your current position.

To create or edit a user waypoint:







1. Press .
2. Press  and use  to highlight the 'user?' field. Press .
3. Use  and  to enter the waypoint identifier. Press .

If the waypoint identifier entered does not exist, you will be prompted to select a method to enter the new waypoint's position into memory. If the waypoint exists (i.e., you're just reviewing or editing a user waypoint), skip step 4 and move on to the next set of instructions.



4. Select the desired waypoint entry method using  and press .

You will automatically be placed on the latitude and longitude field (if you selected 'enter posn?'), the 'from' field (if you select 'ref wpt?') or the 'bearing' field (if you select 'rng/brg from posn?').

To enter/edit the position of the user waypoint:

1. Use  and  to enter the latitude. You may select either north or south and enter a latitude up to (but not including) 90°.
2. Press .
3. Use  and  to enter the longitude. You may select either east or west and enter a longitude up to (but not including) 180°.
4. Press .

Once the latitude and longitude have been entered, the cursor will move to the reference waypoint field, where you may enter a reference waypoint to calculate a bearing and distance to the new waypoint position. If you are not entering a reference waypoint:

5. Press  to advance the cursor to the 'ok?' prompt and press  to save the new waypoint in internal memory.

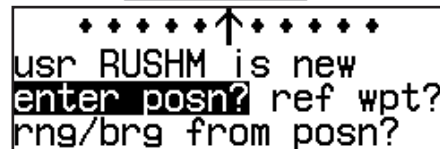
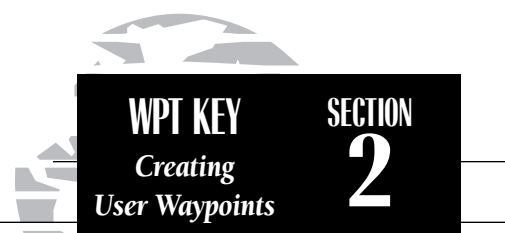

Selecting a method to enter a new user waypoint.

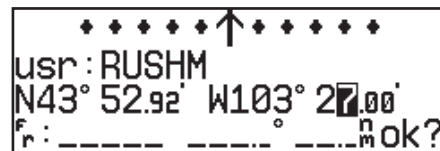

Entering the user waypoint's exact position.

SECTION**2****WPT KEY****Reference
Waypoints**

```

usr: GARMN
N38° 51.33' W094° 48.05'
fr: KOJC 275.0° 3.0M ok?

```

Creating a user waypoint by referencing another waypoint.

```

usr: WAIME
N21° 38.32' W158° 03.28'
fr: _____ 267.2° 12.0M ok?

```

To create a user waypoint from your present position, leave the reference waypoint field blank and enter a bearing and distance from your present position. The GPS 155XL will calculate the new waypoint's coordinates automatically.

To enter/edit a user waypoint position from a reference waypoint:

1. Use and to enter the reference waypoint's identifier.
2. Press **ENT**. The waypoint's position will appear.
3. Use and to enter the bearing from the reference waypoint.
4. Press **ENT**.
5. Use and to enter the distance from the reference waypoint.
6. Press **ENT**. The latitude and longitude will be calculated for the waypoint.
7. Press **ENT** to confirm the 'ok?' prompt and save the waypoint position.

If you have chosen to create a waypoint at a certain bearing and distance from your current position, your current position will be displayed and you will enter the bearing and distance at which you would like the new waypoint to be located.

To create a user waypoint offset from your present position:

1. Use and to enter the bearing from your position.
2. Press **ENT**.
3. Use and to enter the distance from your position.
4. Press **ENT**. The latitude and longitude will be calculated for the new waypoint.
5. Press **ENT** to confirm the 'ok?' prompt and save the waypoint position.



The GPS 155XL's **AutoStore™ function** provides another method of creating user waypoints. AutoStore is used to instantly capture your present position as a user waypoint with a touch of a button and add the new waypoint to the end of a specified route, if desired.

To perform an AutoStore:

1. Press **NAV** and rotate  to display the position page or map page.
2. Press **ENT**.

This will display the 'Save waypoint' screen, which will allow you to rename the waypoint and choose the route to which it should be added. The GPS 155XL will assign the next available three-digit number as the default waypoint name, preceded by a '+' sign. This will help you differentiate AutoStore waypoints from other user waypoints.

To change the default name or route of an AutoStore waypoint:

1. Rotate  to select the name or route number field.
2. Use  and  to enter the name or route number. If you do not want to add the waypoint to a route, be sure to keep the route field blank.
3. Press **ENT** to accept.
4. Press **ENT** to confirm the 'ok?' prompt.

If the waypoint name you entered is already assigned to another waypoint, you will be informed with the message 'WPT exists ____'. The default waypoint name will be redisplayed, and you may enter a different name. The new waypoint will only be added to a route if the desired route number is manually entered in the route field.



AutoStore waypoint with default name.

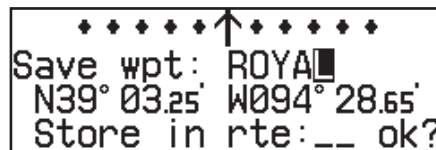

The default waypoint name may be changed before saving the waypoint.

SECTION

2

WPT KEY

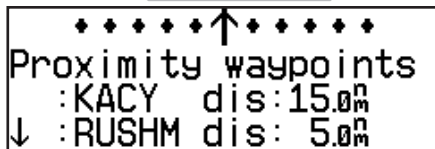
Proximity
Waypoints

Proximity waypoints
:KACY dis: 15.0M
↓ :RUSHM dis: 5.0M

Proximity waypoints page

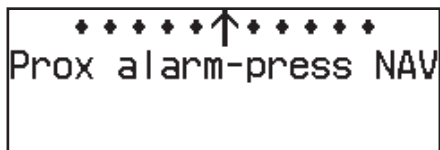

Prox alarm-press NAV

Proximity alarm message. Pressing **NAV** will display the position page with the bearing and distance from the proximity waypoint indicated on the bottom line.

The second page available from the GPS 155XL's **WPT** key is the **proximity waypoints page**. This page allows you to define an alarm circle around a selected waypoint and is useful in defining alarm circles around towers or obstructions. Up to nine proximity waypoints can be entered, each with an alarm radius of up to 99.9 nm.

To create or edit a proximity waypoint:

1. Press **WPT** and use **↑** to display the 'Proximity waypoints' page.
2. Press **CRSR** and use **↑** to highlight the first available field.
3. Use **←** and **→** to enter the identifier. It may be an airport, VOR, NDB, intersection or user waypoint. Press **ENT**.
4. Use **←** and **→** to enter the radius of the alarm circle. Press **ENT**.

If two proximity waypoints are entered and their regions overlap, you will be informed with the message 'Proximity overlap'. This message will be displayed each time you turn on the GPS 155XL for as long as the overlap remains. **Warning:** If you enter the overlap area you will only be informed of the *nearest* proximity waypoint.

To remove a waypoint from the proximity waypoints page:

1. Press **CRSR** if necessary, to obtain a cursor.
2. Press **CLR** to erase the name, and then **ENT** to delete.

To scroll through the proximity waypoints list:

1. Rotate **▲** with the cursor inactive (or use **↑** with the cursor active) to scroll through the available proximity waypoints. The arrow prompt will indicate the direction to scroll to view additional waypoints, if available.

The third page available from the GPS 155XL's **WPT** key is the **user waypoint list**, which can be used to quickly scan, review, rename or delete user waypoints.

To display the user waypoint list:

1. Press **WPT** and use **○** to display the user waypoint list.
2. To scroll through the list, rotate **●**.

The total number of user waypoints is displayed at the top of the page, with the individual user waypoints listed two at a time in alphabetical order below. The arrow prompt, located at the top left of the page, will indicate which direction to scroll to view additional waypoints. The status of each waypoint will be displayed to the right of the identifier when it is the active-to waypoint, part of an active or stored route or a proximity waypoint. To edit, rename or delete waypoints, the cursor must highlight the desired waypoint.

To highlight a waypoint:

1. Press **CRSR** and use **○** to highlight the desired waypoint.

To edit a highlighted waypoint's position:

1. Press **ENT** to obtain the waypoint position page. Edit the waypoint position as described on page 45. (**Note:** The active-to waypoint cannot be edited.)

To delete a waypoint from the list:

1. Highlight the desired waypoint and press **CLR**. Press **ENT** to confirm the deletion.

To rename a waypoint from the list:

1. Highlight the desired waypoint. Use **●** and **○** to enter a new identifier for the waypoint.
2. Press **ENT** on the confirmation page to change the name, or press **CLR** to cancel.

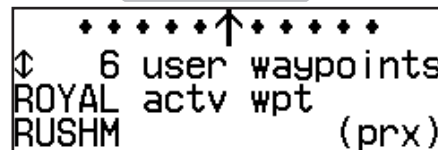

User waypoint list showing the current active-to waypoint and a proximity waypoint.



Renaming a user waypoint.

SECTION

2

WPT KEY

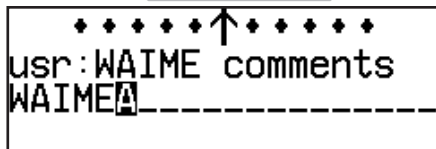
Waypoint
Comments*Entering waypoint comments**Waypoints with comments page*

The last page available through the GPS 155XL's **WPT** key is the **waypoints with comments page**, which lists all waypoints that have a user comment. User comments may be added to 250 waypoints stored in the user or NavData® database, and allow you to note two lines of special information concerning a particular waypoint.

To enter user comments:

1. Enter the waypoint identifier from any waypoint page (see page 34), and press **CRSR** to remove the cursor.
2. Rotate **○** to display the 'comments' page.
3. Press **CRSR** and use **○** to highlight either the second or third line.
4. Use **○** and **○** to enter the comment.
5. Press **ENT** to accept, and repeat steps 4 and 5, if necessary, to enter information on the other line.
6. Press **CRSR** to remove the cursor.

To view the 'waypoints with comments' list:

1. Press **WPT** and use **○** to display the 'Wpts with comments' page.
2. Use **○** to scroll through the list.

The GPS 155XL will display the waypoints with comments in alphabetical order, with up to six waypoints at a time. The scrolling arrow prompt will indicate which direction to scroll to view additional waypoints.

To view comments for a selected waypoint:

1. Highlight the desired waypoint and press **ENT** (or press **CLR** and **ENT** to delete).
2. Rotate **○** to display any other available pages for the selected waypoint.

The GPS 155XL's extensive waypoint database makes it possible for several waypoints to share the same identifier. To ensure that you are selecting the waypoint desired, the GPS 155XL will always offer the **waypoint confirmation page** (which shows the waypoint's position) when an identifier is entered for a particular function.

To accept the waypoint position:

1. Press **ENT** with the cursor over the 'ok?' prompt.

To reject the waypoint position:

1. Press **CLR** with the cursor over the 'ok?' prompt.

Once a waypoint has been accepted or rejected, the previous page will be displayed. If there is more than one waypoint available for a selected identifier, the GPS 155XL will display a duplicate waypoint page for you to choose the desired waypoint. The waypoint identifier and number of duplicates will be shown at the top of the page, with the waypoint type and region of each duplicate indicated below. The waypoints listed are sorted by the distance from your present position.

To scroll through additional duplicate waypoints:

1. Rotate  with the cursor active, or  with the cursor inactive.

To select the desired waypoint from the duplicate list:

1. Activate the cursor and rotate  to highlight the desired waypoint.
2. Press **ENT**. The waypoint confirmation page will appear.
3. Press **ENT** over the 'ok?' prompt to accept the waypoint or **CLR** to reject the waypoint and return to the duplicate waypoints list.

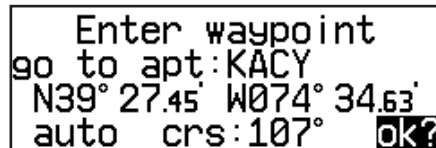
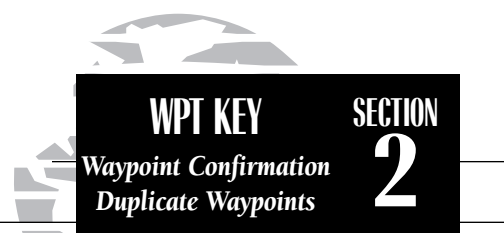

Waypoint confirmation page



Duplicate waypoints page

SECTION

2

WPT KEY

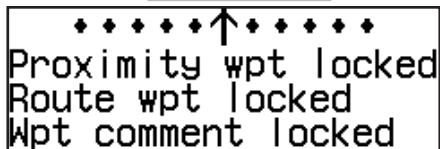
Locked Waypoints
Waypoint Scanning

```

* * * * * ↑ * * * * *
Proximity wpt locked
Route wpt locked
Wpt comment locked

```

Possible messages for locked waypoints.

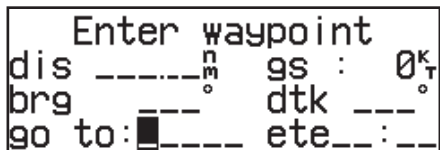

```

Enter waypoint
dis  _____n  gs :  0KT
brg  _____o  dtk  _____o
go to: █ _____ ete__ :__

```

To blank a waypoint field, highlight the field and press the **CLR** key.

Because the GPS 155XL relies on a NavData card for most waypoint information, there may be instances when waypoint information is not available for use. **Locked waypoints** exist when a waypoint contained in a route, used as a proximity waypoint or with a comment, is not contained on the NavData card, or no card is inserted in the unit. If this condition exists, you'll be alerted with a 'Proximity wpt locked', 'Route wpt locked' or 'Wpt comment locked' message when the unit is powered up. The identifier of a locked waypoint will be replaced with a 'lockd' message, which indicates you cannot obtain waypoint information or navigate to the waypoint. The identifier of a locked waypoint may be displayed by highlighting 'lockd' and pressing **ENT**. Locked waypoints may be deleted from routes, the proximity waypoints list or waypoints with comments page by following the instructions in the appropriate section of this manual.

The **waypoint scanning feature** provides a fast way to scan through airports, VORs, NDBs and intersections in the database by identifier, facility name or city. Waypoint scanning may be used from any blank waypoint identifier field.

To enter a waypoint by scanning the identifier, facility name or city:

1. With the cursor over a blank identifier field, press **WPT**. If the identifier field is not blank, highlight the field with the cursor and press **CLR** before pressing **WPT**.
2. Use **○** to highlight the waypoint category you wish to scan.
3. Press **ENT** to activate the scanning mode.
4. Rotate **○** to place the cursor over the field you want to scan (identifier, facility or city name).
5. Use **●** and **○** to enter the letters of the identifier, city or facility name. The GPS 155XL will scan the database and display the first waypoint that matches your entry.
6. Press **ENT** to accept the waypoint, and **ENT** again to confirm the waypoint for the function being used.

Section 3 Nearest Waypoints

The GPS 155XIs **NRST** key provides detailed information on the nine nearest airports, VORs, NDBs, intersections and user waypoints within 200 nm of your current position. In addition, it will display the two nearest Flight Service Station (FSS) and center (ARTCC/FIR) points of communication, plus alert you to any Special Use Airspace (SUA) you may be in or near. The **NRST** key can be used in conjunction with the GPS 155XIs direct-to function to quickly set a course to a nearby facility in case of an in-flight emergency.

To view the nearest waypoint information:



1. Press **NRST**

This will display the airport nearest to your present position, subject to the runway surface type and minimum runway length selected (see page 100).

To scroll through the next eight nearest airports, rotate .

You may examine both the communication frequencies and the runway information directly from the nearest airport page.

To view more comm/runway information:

1. Press **CRSR** and rotate  to highlight the comm field or the runway field.
2. Rotate  to scroll through more information, if available.

To perform a direct-to on any of the nearest waypoint pages:

1. Press **→**. The waypoint confirmation page will appear.
2. Press **ENT** to accept the waypoint or **CLR** to cancel.

NRST KEY
Overview

SECTION
3



```
*****↑*****  
nr1 apt KIXD 1090F  
154° 5.50M twr 118.30  
rnwy 17 /35 7300F
```

*Nearest airport with other frequency information. If an airport has multiple frequencies available, they may be quickly viewed without activating the cursor by pressing the **CLR** key repeatedly.*



```
*****↑*****  
nr1 fss COLUMBIA  
122.15
```

Nearest FSS page. To view additional frequencies (if available), highlight the frequency and rotate the  knob.

SECTION

3

NRST KEY

Special
Use Airspace

```

* * * * * ↑ * * * * *
sua1 near&ahead 1:24
KANSAS CITY CI B
KMCI 8000fM- 4000fM

```

Nearest SUA

```

* * * * * ↑ * * * * *
sua1 near&ahead 1:09
KANSAS CITY APP
KMCI 8000fM- 4000fM

```

Nearest SUA with controlling agency displayed.

NOTE: The GPS 155XL will flash the **NRST** key next to the **MSG** key to inform you of SUA alerts. You do not have to repeatedly check the Nearest Waypoint page for SUA information. It is provided to supply more information on the SUA and its boundaries. The GPS 155XL will not flash alerts, however, if it has been turned off or if your altitude is such that you will not enter the buffered airspace. Turning off SUA alerts and setting the altitude buffer is described on page 105.

The nearest waypoints for other categories (VORs, NDBs, etc.) may be viewed by rotating **NRST**. Rotating **NRST** continuously to the left will stop page selection on the nearest airport category.

The next page available under the GPS 155XL's **NRST** key is the **SUA (special-use airspace) alert page**. The SUA alert page will alert you to as many as nine controlled or restricted airspaces near or in your flight path, according to the following conditions:

- If your projected course will take you inside an SUA within the next 10 minutes, the message **'SUA ahead < 10 min'** will be displayed.
- If you are within two nautical miles of an SUA and your current course will take you inside, the message **'SUA near & ahead'** will be displayed.
- If you are within two nautical miles of an SUA and your current course will **not** take you inside, the message **'Near SUA < 2nm'** will be displayed.
- If you have entered an SUA, the message **'Inside SUA'** will be displayed.

Note that the GPS 155XL's SUA alerts are based on three-dimensional data (latitude, longitude and altitude) to avoid nuisance alerts. The alert boundaries for controlled airspace are also sectorized to provide complete information on any nearby airspace. Once you have met one of the described conditions, the message annunciator will flash, alerting you of an SUA message.

To view an SUA message:

1. Press the **MSG** key.
2. Press **NRST** again to return to the previous page.

Once you are notified of an SUA alert, detailed information concerning the specific SUA is provided by the **NRST** key.



To view the SUA alert page:

1. Press the **NRST** key.
2. Rotate **○** one stop to the right to view the SUA alert page.

The SUA alert page contains the following information:

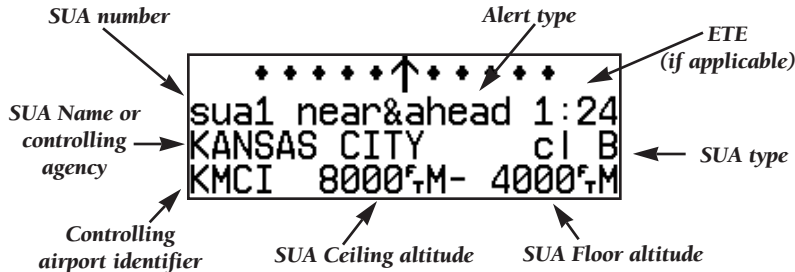

The 'SUA number' field displays which SUA you are viewing (you may be alerted to up to nine SUAs). SUAs are ranked with 'sua1' being the highest priority, and 'sua9' being the lowest priority from your current position. The 'SUA alert' field displays the corresponding alert message for this SUA, such as 'near', 'near & ahead', etc. (see page 54). The ETE (estimated time enroute), located at the top right of the page, will only be displayed if you are projected to enter the airspace.

The second line of the SUA alert page displays the name or controlling agency of the SUA, along with the type of SUA to which you are being alerted.

To toggle between the SUA name and controlling agency display:

1. Rotate **●** one stop in either direction.

If the SUA name or controlling agency is too long to fit on the display, the GPS 155XL will automatically scroll to display the rest of the information.

SECTION 3

NRST KEY SUA Messages

```

*****↑*****
sua1 near&ahead 1:24
KANSAS CITY      cl B
KMCI 8000fM- 4000fM
  
```

SUA alert page

```

*****↑*****
KMCI↕ class B 118.90
SOUTH OF A LINE FROM
  
```

Frequency information for SUA. If the information is too long to fit on the display, the GPS 155XL will automatically scroll to display the rest of the information.

The following SUA types can appear in the SUA type field:

Message	Airspace Type
alrt	- Alert
caut	- Caution
cl B	- Class B
cl C	- Class C
cta	- ICAO Control Area
dngr	- Danger
moa	- Military Operations Area
proh	- Prohibited
rstc	- Restricted
tma	- ICAO Terminal Control Area
trng	- Training
trsa	- Terminal Radar Service Area
unsp	- Unspecified
warn	- Warning

The last line on the SUA alert page displays the SUA's controlling airport identifier and the ceiling and floor altitudes for the SUA alert. Controlling agency frequencies may be viewed by highlighting the controlling airport identifier with the cursor and pressing **ENT**. The following are examples of what can appear in the altitude fields:

Message	Meaning
8000 ^f M	- 8000 feet mean sea level (MSL)
3000 ^f A	- 3000 feet above ground level (AGL)
ground	- Ground level
msl	- Mean sea level
notam	- See Notice to Airmen (NOTAM) for altitude restrictions
not sp	- Altitude is not specified
unlmt	- Altitude is unlimited

```

      * * * * * ↑ * * * * *
cl B/cta on moa on
cl C/tma on oth on
alt: 200f rstcd on
  
```

SUA Settings Page

All SUA alert messages except for prohibited areas may be turned on or off through the GPS 155XL's unit settings options, found under the **MSG** key (see page 105). Alerts for prohibited areas will always be displayed, regardless of unit settings or operating mode. SUA alerts may be turned off so the pilot can avoid continuous alerts in areas with extensive special use airspace. SUA alerts are automatically disabled during approach operations.

Important: Turning off the SUA alerts only stops the display of SUA messages. Any applicable SUA alert pages will still be available from the **NRST** key.

The GPS 155XL also features an altitude buffer which may be set to provide a greater level of protection from penetrating an SUA. By specifying an altitude in the buffer, you can effectively stretch an SUA's altitude boundaries in both directions. This allows the pilot to add an extra margin of prevention around controlled or restricted airspace. For instructions on setting the altitude buffer, see page 105.



```

      * * * * * ↑ * * * * *
cl B/cta on moa on
cl C/tma on oth on
alt: 500f rstcd on
  
```

Altitude buffer set at 500 feet. This provides an added 500 foot margin beyond the floor and ceiling limits for an airspace.

SECTION 4

DIRECT-TO & ROUTE NAV

ROUTE TERMINOLOGY

The diagram at the right shows a basic route consisting of five waypoints and four legs.

The waypoint you are travelling to is called the **'active to'** waypoint, and the waypoint immediately behind you is called the **'active from'** waypoint. The course line between the active from and the active to waypoint is called the **'active leg'**.

Section 4 Direct-to & Route Navigation

One of the many benefits of GPS navigation is the ability to fly directly to a waypoint or fly a chain of waypoints without using ground-based navigation aids. To take advantage of the convenience and efficiency provided by point-to-point GPS navigation, the GPS 155XL provides two basic methods of selecting a destination for your flight: **direct-to** and **route navigation**. The direct-to function provides a fast way to set a course to a destination waypoint from your present position. The route function allows the pilot to create a chain of waypoints to fly in sequence and provides access to the GPS 155XL's approach, SID and STAR capabilities.

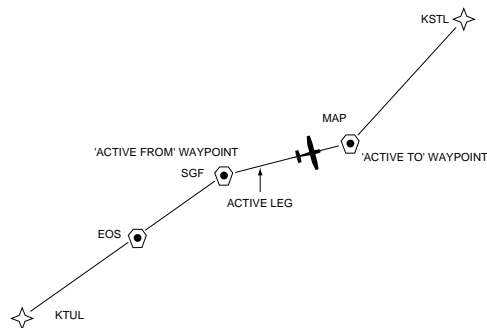

As you pass each waypoint in the route, the GPS 155XL's automatic leg sequencing and turn anticipation features will automatically select the next waypoint as the **'active to'** waypoint and provide smooth steering guidance around the turn. If you are not currently navigating a particular route leg (e.g., your starting position is not a route waypoint), the unit will select the appropriate leg as the active route segment.

DIRECT-TO SECTION 4

Selecting and Cancelling a Direct-To

The GPS 155XL's **direct-to function** provides a quick method of setting a course to a destination waypoint. Once a direct-to destination is activated, the GPS 155XL will establish a point-to-point route line along the great circle from your present position to the destination and provide steering guidance and navigation data to the waypoint until it is cancelled. If you are navigating to a waypoint and get off course, the direct-to function may also be used to re-center the d-bar to proceed to the same waypoint.

To select a direct-to destination:

1. Press the **→** key. The NAV summary page appears with the destination field highlighted.
2. Use **▲** and **▼** to enter the identifier of the desired waypoint.
3. Press **ENT** to confirm the identifier, and **ENT** to accept the direct-to confirmation page.

To re-center the d-bar to the same active-to waypoint:

1. Press the **→** key, followed by **ENT** twice. **NOTE:** If you're navigating an active approach with the MAP as the active waypoint, the approach will be cancelled.

A direct-to may also be quickly activated from many pages that display a single waypoint identifier (e.g., the nearest airport page) by simply pressing **→** and **ENT**. For pages that display a list of waypoints (e.g., the user waypoint list page), you must highlight the desired waypoint with the cursor before pressing the **→** key. Once a direct-to is activated, the GPS 155XL will provide navigation guidance until the direct-to is cancelled or the unit is turned off.

To cancel a direct-to destination:

1. Place the cursor over the destination field on the NAV summary page.
2. Press **CLR**. The destination field will go blank.
3. Press **ENT**. The GPS 155XL will resume navigating Route 0 (the active route) if available.

```
Enter waypoint
dis -----H  gs : 0KT
brg          M  dtk
go to: KCO go to: 356°
```

To select a direct-to destination, press the **→** key and enter the waypoint identifier using **▲** and **▼**.

```
*****↑*****
nr1 apt KIXD 1090F
154° 5.50M twr 118.30
rnwy 17 /35 7300F
```

To quickly select a direct-to from any page that displays a single waypoint identifier (e.g., the nearest airport page), press **→**, followed by **ENT**.

SECTION

4

DIRECT-TO

Manually Selecting
A Course

```

Enter waypoint
go to apt:KICT
N37° 39.00' W097° 25.99'
hold crs 228° ok?
  
```

The waypoint sequencing field, located at the bottom left of the direct-to confirmation page, displays the current status of the external GPS SEQ switch.

To manually set your course from the course select field, set the GPS SEQ switch to the 'AUTO' position and enter the selected course in the course select field. NOTE: Whenever the GPS SEQ switch is set to the 'HOLD' position, the selected course will be determined by the external OBS/HSI.

When using the course select feature on the direct-to confirmation page or when the GPS SEQ switch is set to the 'HOLD' position and external course input is not present, you may also enter the desired course from the NAV summary page using the course field at the bottom of the page.

Whenever you perform a direct-to, the GPS 155XL will set a point-to-point great circle course to your destination. You can also manually define the course to your destination with the GPS 155XL's **Course Select** feature. The course select feature is available from the bottom line of the **direct-to confirmation page** whenever the external GPS SEQ switch is in the 'Auto' position.

Waypoint Position, Facility
Name or City/Region
(selectable)

Waypoint Identifier Field

Waypoint
Sequencing Field

```

Enter waypoint
go to apt:KICT
N37° 39.00' W097° 25.99'
auto crs:228° ok?
  
```

Course Select Field

To manually set a course:

1. Set/confirm the GPS SEQ switch in the 'AUTO' position.
2. Press the **→** key. The direct-to confirmation page will appear.
3. Rotate **○** to place the cursor on the course select field.
4. Use **●** to begin entry of the selected course (the **○** and **●** knobs may be used once you have started editing the course select field).
5. Press **ENT** to accept the course, and **ENT** again to acknowledge the 'ok?' prompt.

The GPS 155XL will now use the selected course for your CDI and DTK steering guidance. To reset the course to a GPS-calculated course from your present position, simply press **→**, followed by **ENT**.

The GPS 155XL lets you create up to 20 routes (numbered 0 through 19), with up to 31 waypoints each. Routes are created, copied and edited through the **RTE** key, which features five route pages selectable from the GPS 155XL's outer knob.

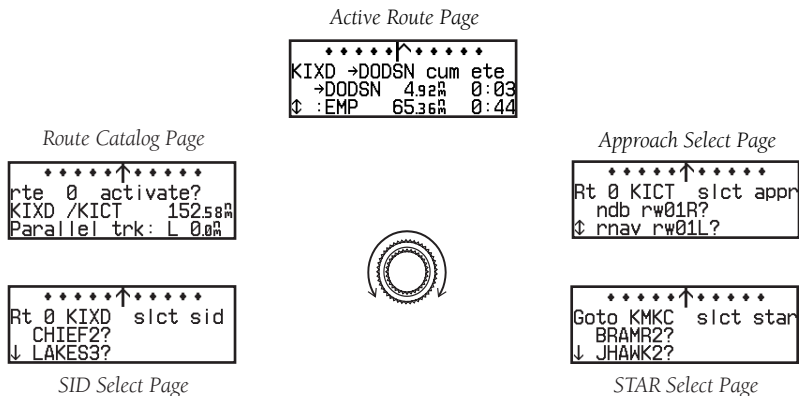

The five route pages can be divided into two types: **active route pages** and a **route catalog page**. Active route pages provide information and editing functions for route 0, which always serves as the route you are currently navigating. The route catalog page serves as the main page for creating, editing, activating, deleting, and copying all routes.

Routes 1-19 are used as storage routes, which are stored in the GPS 155XL's internal memory. Once a storage route is 'activated', a copy is placed into route 0 for navigation until it is cancelled, overwritten by activating another route or erased when the unit is turned off. If you want to save a route currently in route 0, be sure to copy it to an open storage route (routes 1-19) before it is cancelled, overwritten or erased.

ROUTE NAV SECTION 4

Route Pages



REMEMBER!

If you want to save the active route, be sure to copy it to an empty storage route (1-19) before turning the GPS 155XL off or activating a new route (or direct-to destination). See page 65 for instructions on copying routes.

SECTION 4

ROUTE NAV Route Catalog Page

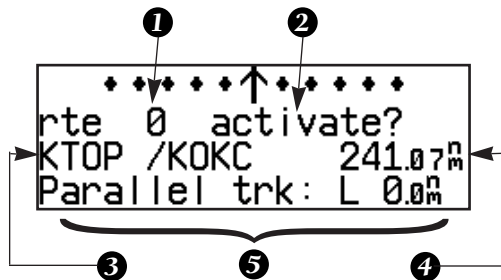

Route Catalog Page

1. Route selection field
2. Route action field
3. Departure/Arrival waypoints
4. Cumulative distance of route
5. Comments/Parallel track offset field

The GPS 155XI's **route catalog page** is used to create, edit, delete or copy routes, and serves as the main page for a host of functions. These include route activation, determining the closest point of approach and search-and-rescue operations. It also displays a summary of routes currently stored in memory, with the departure and arrival route waypoints and total distance for the selected route number. To scroll through the available routes, rotate . A one-line user comment may be added to any storage route, which will be displayed on the route catalog page.

To add user comments to any route (except route 0):

1. Rotate to display the route you would like to add comments to.
2. Press and use to highlight the bottom row.
3. Use and to enter comments, and press . To erase press , then .

The **route action field**, located at the top right of the page, is used to select the desired route operation. The following functions are available:

- **Activate** - activate the route for navigation
- **Reverse** - activate a route in reverse order
- **Edit** - create a new route, or edit an existing route
- **Approach** - select an approach for the route (see Section 5)
- **Star** - select a STAR for the route (see Section 5)
- **Sid** - select a SID for the route (see Section 5)
- **Delete** - delete a route
- **Copy** - copy the current route to an empty route
- **CPA** - calculate the closest point of approach
- **Search** - perform search-and-rescue ladder operations
- **RAIM prd** - evaluate enroute RAIM availability over the entire route

The **route editing function** allows you to create new routes and edit existing routes. Creating routes before takeoff can help make route operations faster and easier during your flight.

To create or edit a route from the route catalog page:

1. Use to display the route number you would like to edit.
2. Press .
3. Use to select 'edit?'. Press . The route review page will appear.

To add a waypoint:

4. Rotate to highlight the first blank waypoint field or the point where you want to enter the new waypoint. The first waypoint field will already be highlighted if you're creating a new route.
5. Use and to enter the waypoint's identifier. Press .
6. Press to confirm the 'ok?' prompt on the waypoint confirmation page.
7. Repeat steps 4 through 6 to add the next waypoint, or press to finish.

To delete a waypoint:

1. Rotate to highlight the waypoint you wish to delete.
2. Press to remove the name, then press to delete.
3. Repeat steps 1 and 2 to delete additional waypoints, or press to finish.

To delete an entire route:

1. Use to display the route number you would like to delete (route 0 for the active route).
2. Press and use to highlight the action field.
3. Use to select 'delete?'. Press to delete.



Selecting the route edit function.



Adding a waypoint to route 1.

SECTION

4

ROUTE NAV

Deleting &
Activating Routes

A screenshot of a GPS display. At the top, there is a row of 12 asterisks with an upward-pointing arrow in the center. Below this, the text reads: 'rte 0 delete?' where 'delete?' is highlighted with a black background. Underneath, it shows 'KTOP /KOKC 241.07m' and 'Parallel trk: L 0.0m'.

Deleting route 0.

A screenshot of a GPS display. At the top, there is a row of 12 asterisks with an upward-pointing arrow in the center. Below this, the text reads: 'rte 0 reverse?' where 'reverse?' is highlighted with a black background. Underneath, it shows 'KTOP /KOKC 241.07m' and 'Parallel trk: L 0.0m'.

Reversing route 0.

Once a route is defined through the route catalog page, it may be activated from the route catalog page. Activating or reversing a route places the selected route into route 0 and overwrites the existing active route.

To activate a route:

1. Press **RTE** and use **○** to display the route catalog page.
2. Rotate **●** to display the route you would like to activate.
3. Press **CRSR** and use **●** to display 'activate?'. Press **ENT**.

After travelling a route or creating a route with the GPS 155XI's AutoStore™ feature, the route activation field may be used to activate the route in reverse order.

To activate a route in reverse order:

1. Press **RTE** and use **○** to display the route catalog page.
2. Use **●** to display the route number you would like to reverse.
3. Press **CRSR** and use **●** to display 'reverse?'. Press **ENT**.

This will copy the reversed route to route 0 and display the active route page. The original route will remain intact in its storage route location.

The route action field also features a **copy function** that permits you to copy any route to another open storage route. The copy function can be used to save the contents of the active route (route 0) to an open storage route.

To copy a route:

1. Press **RTE** and use **○** to display the route catalog page.
2. Use **○** to display the route to which you would like to copy. The route must be empty.
3. Press **CRSR** and rotate **○** to select 'copy?'. Press **ENT**.
4. Use **○** to enter the route you would like to copy. The departure/arrival identifiers will be displayed for your reference. Press **ENT** to copy the route.

The **CPA function** calculates the closest distance that a route will pass to a reference waypoint, and helps when creating new route waypoints referenced to a NAVAID.

To calculate the closest point of approach (CPA) from the route catalog page:

1. Use **○** to display the route you would like to use for the CPA function. The route must consist of at least two waypoints, and the reference facility must fall between the waypoints of a route leg.
2. Press **CRSR** and rotate **○** to select 'cpa?'. Press **ENT**.
3. Use **○** and **○** to enter the identifier of the reference waypoint.
4. Press **ENT**. The bearing and distance of the closest point on the route will be displayed.
5. Press **ENT** to add the cpa waypoint to the route, or **CLR** to finish. If you do add the cpa waypoint to the route, it will be named based on the reference waypoint plus a number (0-9) added to the end (e.g., KMCI3 for KMCI). If the waypoint does not fall between waypoints on the route, the reference waypoint does not exist or a unique name cannot be assigned to the CPA waypoint, you will be informed with the 'Invalid CPA wpt _____' message.

ROUTE NAV SECTION 4

Copying Routes CPA Function

```
*****↑*****
Closest pt of apprch
route 3 KDAL /KLIT
fr:TXK 327° 26.7nm OK?
```

Calculating closest point of approach.

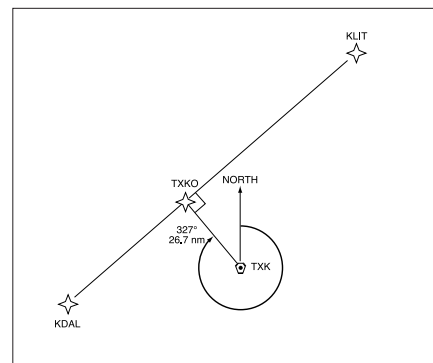

Closest point of approach to 'TXK'.

SECTION

4

ROUTE NAV

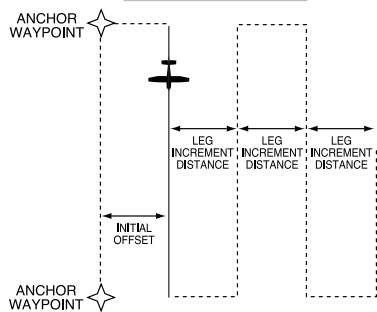
Search & Rescue
Operations

The map page will show the active leg of the search and rescue pattern as a solid line with the anchor waypoints joined together by a dashed line.

```

♦ ♦ ♦ ♦ ♦ ^ ♦ ♦ ♦ ♦ ♦ →
Route 0 KTOP /KFOE
initial offst:L 0.0m
increment:R 0.5m OK?

```

Performing a search-and-rescue operation.

The GPS 155XI's **search-and-rescue function** provides navigation guidance for search-and-rescue operations, navigating in a ladder pattern to maximize coverage and efficiency. This is done in reference to two waypoints called 'anchor waypoints'. The first leg will be a specified distance from the line connecting the anchor waypoints. This is called the 'offset distance'. The 'increment distance' is the distance between each subsequent leg. The ladder can be created on either side of the anchor waypoints.

To perform a search-and-rescue operation:

1. Create a route of **only** two waypoints.
2. Press **RTE** and use **○** to display the route catalog page.
3. Use **●** to select the 2-waypoint route.
4. Press **CRSR** and use **●** to display 'search?'. Press **ENT**.
5. Use **●** and **○** to enter the leg increment value and R or L. Press **ENT**.
6. Rotate **○** to highlight the initial offset, and use **●** and **○** to enter the initial offset value, and R or L.
7. Press **ENT** three times to accept the operation values and begin navigation.

After activating a search-and-rescue, you will be informed with an 'Offset nav in effect' message each time you traverse the route offset from the anchor waypoints. The NAV summary page will guide you along each leg of the ladder pattern. Note that bearing and distance information are referenced to the anchor waypoints. Once you've arrived at the destination waypoint, the leg increment will be added to your present offset, and the route will be automatically reversed. If a search-and-rescue is interrupted, note the parallel track direction (R or L) and distance on the catalog page for route 0. When you resume search-and-rescue operations, use this as the initial offset.

The GPS 155XI's Route RAIM Prediction Function evaluates enroute RAIM availability over the entire route that the pilot intends to fly. Route RAIM Prediction ensures that satellite coverage will be sufficient to meet the protection limits defined by BRNAV/RNP-5 (FAA Advisory Circular 90-96).

To use the Route RAIM Prediction Function:

1. From the Route Catalog Page (Figure 1), select the desired route for RAIM prediction (if the route is empty, enter the route first).
2. Highlight the route action field by pressing **CRSR**, rotate **▲** to select 'RAIM prd?' and press **ENT**. The Route RAIM Prediction Page will be displayed (Figure 2).
3. Highlight and enter departure time, departure date, enroute altitude, and enroute ground speed (valid enroute ground speed is "65 nm or greater"). Press **ENT** to accept.
4. When all parameters are properly entered, move the cursor to the 'Compute?' field, and press **ENT**. The unit will start to predict the RAIM availability over the entire route, and will switch to 'WAIT ->', with the arrow sign continually rotating, indicating that the prediction computation is in progress.
5. If RAIM is available for the entire route 'RAIM OK' will appear on the Route RAIM Prediction Page, as shown in Figure 3 (pg. 68).

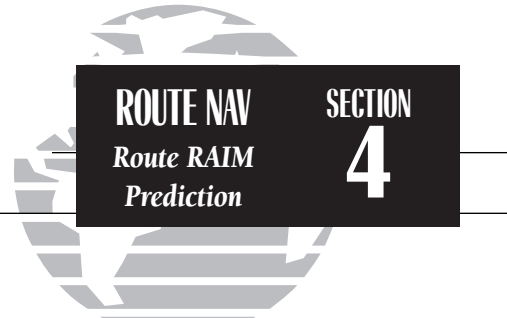

Figure 1

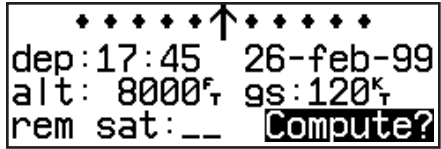

Figure 2

SECTION

4

ROUTE NAV

Route RAIM
Prediction

dep:17:45 26-feb-99
alt: 8000_r gs:120_k
rem sat: __ RAIM OK

Figure 3

dep:10:00 26-feb-99
alt: 8000_r gs:120_k
rem sat: 9 NO RAIM



Figure 4

The time required for RAIM prediction computation depends on the route distance (i.e., 1000 nautical miles = approximately 2 minutes) and the enroute speed. The longer the route distance and the slower the enroute speed, the longer the time. If RAIM unavailability is detected based on the associated requirement, the prediction process will stop immediately and display 'NO RAIM' as shown in Figure 4.

'NO RAIM' does not mean RAIM is unavailable for the entire route. This message results when RAIM unavailability is detected for more than 5 minutes at any point along the intended flight (based on BRNAV requirements).

If a satellite is listed as 'out of service' by NOTAM, you may use the 'rem sat' (remove satellite) field to prevent a particular satellite from being used in the Route RAIM prediction (e.g., removing satellite 9 in Figure 4).

To exclude a satellite from the Route RAIM prediction:

1. Highlight the 'rem sat' field.
2. Rotate  to select the satellite to be excluded.
3. Press  to accept.
4. Press  again to begin Route RAIM Prediction without using the selected satellite.

ROUTE NAV SECTION 4

Parallel Track Offset Navigation

During route navigation, it is sometimes desirable to navigate a specified distance away from the 'active leg' to help avoid certain airspaces or regions. The GPS 155X1s **parallel track feature** will automatically guide you along a selected offset from the active leg. Bearing and distance information will be to the waypoints along the original course, with the CDI centered on the offset course.

To use offset navigation, or 'parallel track':

1. Press **RTE** and use **0** to display the route catalog page.
2. Use **0** to display route 0 (parallel track can only be used on the active route).
3. Press **CRSR** and use **0** to highlight the parallel track value field.
4. Use **0** and **0** to enter the desired distance and direction (R or L) from the leg.
5. Press **ENT** to accept. The Map Page will display the offset route as a solid line and the original route as a dashed line.

It is important to note that offset navigation is only available on route navigation, not direct-to navigation. If an approach is present in the active route, parallel offset navigation is cancelled when entering the 30 nm terminal area. Offset navigation is **NOT** valid for IFR approach procedures. "Approach not active" message will display if parallel navigation is re-instated after approach navigation has been armed. When offset navigation is activated, an 'Offset nav in effect' message will be displayed with the distance and direction noted on the route catalog page for route 0. If you enter an offset which causes a leg to be reversed, you'll be informed with the message 'Ofst too big for rte'. If you change the active route in any way or perform a direct-to, you'll be informed with an 'Offset nav cancelled' message.

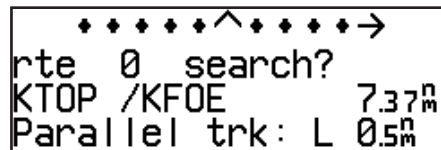

Enter parallel track value after route activation.

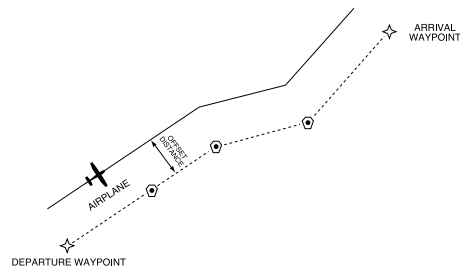

Parallel Track

SECTION

4

ROUTE NAV

Active Route

Page

```

* * * * * ^ * * * *
KTOP →KSLN cum etc
→KSLN 100.4M 0:51
↓ :KCOS 431.0M 3:43

```



USING THE ACTIVE ROUTE PAGE

The GPS 155XL's active route page provides a working list of all waypoints for the route you are navigating, along with distance, timing or desired track information. The scrolling arrow prompt to the left of the route waypoint list indicates which way to scroll to view additional route waypoints.

The active route page can also be used to manually select your next 'active-to' destination (using ) , which allows you to fly directly to any waypoint in the route without modifying the route itself. The GPS 155XL will resume navigation of the remainder of the route in sequence once you arrive at the selected waypoint.

Flying and Modifying the Active Route

Once a route has been created and activated, the GPS 155XL will provide navigation to each route waypoint through the active route, NAV summary and map pages. From the active route page, you may also create and modify the active route, and insert an approach, SID or STAR. The NAV summary page will display detailed navigation data on your progress to each route waypoint, and provide turn anticipation, waypoint arrival and next desired track information. By understanding the relationship between the active route and NAV summary pages and the role of the waypoint sequencing (GPS SEQ) switch, you'll be able to get the most out of the GPS 155XL's advanced route and approach features.

Whenever the GPS 155XL is navigating an approach, route or an on-route direct-to, the **active route page** will provide a list of the route waypoints in sequence, along with distance, time and course information. You may also create and edit a route directly from the active route page. If you want to save a route created from the active route page (route 0), you must copy it to an open storage route (see page 65) before turning the unit off or activating another route. The active route page may be displayed by pressing the  key and rotating  left continuously. It will also appear automatically whenever an approach, route, SID or STAR is activated.



To scroll through the active route waypoints:

1. Rotate  with the cursor inactive (or  with the cursor active).

The active leg identifiers field, located at the top left of the page, displays the waypoint identifiers of the route leg you are currently navigating. The first waypoint identifier displayed is the '**active from**' waypoint. The second waypoint is the '**active to**' waypoint. The line connecting these waypoints is known as the '**active leg**'. If you are navigating a direct-to, the field will display the 'goto' destination only.







The distance field can be selected to display cumulative ('cum') distance or the distance for each route leg ('leg'). If cumulative is selected, the first leg's distance will be displayed. The second leg will represent the first leg's distance plus the second leg, and so on. The time field may be configured to display the estimated time enroute (ete), estimated time of arrival (eta) or desired track (dtk) for each leg.

To change the distance and time fields:

1. With the cursor active, rotate  to highlight the field you want to change.
2. Rotate  to select the desired setting and press .

The active route page may also be used to create a new route or edit the route you are currently navigating (approach, SID or STAR waypoints cannot be edited), and provides a fast method of selecting any route waypoint as your next destination waypoint without modifying the active route. If you are editing the active route and want to save it in its original form, copy it to an open storage route before editing.

To add waypoints to the active route:

1. Press  if necessary, to activate the cursor.
2. Use  to highlight the first blank waypoint field, *or* highlight the waypoint before which you would like to add the new waypoint.
3. Use  and  to enter the new waypoint identifier. Press .
4. Press  to accept or  to cancel. The cursor will automatically move to the next waypoint field, and the remaining route waypoints (if any are present) will move down the list accordingly.

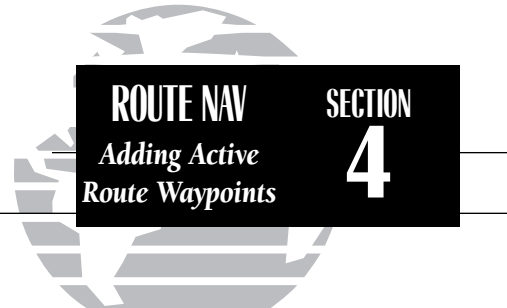

♦ ♦ ♦ ♦ ♦ ^ ♦ ♦ ♦ ♦ ♦			
KTOP	→KSLN	cum	dtk
	→KSLN	98.79 ⁿ	256°
↓	: KCOS	429.4 ⁿ	267°

Active route page with cumulative distance (cum) and desired track (dtk) displayed.

♦ ♦ ♦ ♦ ♦ ^ ♦ ♦ ♦ ♦ ♦			
KTOP	→KSLN	leg	ete
	→KSLN	97.90 ⁿ	0:39
↓	: KCOS	330.6 ⁿ	2:53

Active route page with leg distance and estimated time enroute displayed.

SECTION

4

ROUTE NAV

On-Route
Direct-To

```

Enter waypoint
go to usr:KSLN
N38° 47.50' W097° 39.06'
hold crs 261° ok?
  
```

You can hold on a destination waypoint by setting the GPS SEQ switch to the 'HOLD' position. The GPS 155XL will hold on the current 'active to' waypoint as your navigation reference and prevents the unit from sequencing to the next waypoint in the route. A user-defined course may also be selected on the external HSI (OBS).

```

|♦♦♦♦♦^♦♦♦♦♦
dis 85.32M gs :160K
dtk 263° brg 260°
:261° :KSLN trk 218°
  
```

Whenever waypoint sequencing is set to 'hold', the desired course is displayed at the bottom left of the NAV summary page. See page 60 for more details.

To delete a waypoint from the active route:

1. Press **CRSR** if necessary, to activate the cursor.
2. Use **○** to highlight the waypoint you would like to delete from the active route.
3. Press **CLR**, followed by **ENT**. The next route waypoint (if available) will move up to take the position of the deleted waypoint.

The active route page also allows you to select your next destination waypoint manually from the active route waypoint list and resume the remainder of the route in sequence. This procedure, referred to as an '**on-route direct-to**', allows the pilot to fly directly to any waypoint in the active route without editing the active route, approach, SID or STAR itself. For example, if you are flying a route with an armed approach, the GPS 155XL will automatically provide the initial approach fix (IAF) for the selected approach as your 'active to' waypoint. If you have been vectored directly to the final approach fix (bypassing the IAF), you can manually "skip ahead" to the final approach fix as your next active to waypoint.

To perform an on-route direct-to from the active route page:

1. Press **CRSR** and rotate **○** to highlight the desired waypoint.
2. Press **→**, followed by **ENT** to confirm the 'ok?' prompt on the waypoint confirmation page.

The GPS 155XL will now provide guidance to the selected waypoint and resume navigating the remainder of the route in sequence once you arrive at the next destination waypoint. The **waypoint sequencing field**, located at the bottom left of the direct-to confirmation page, indicates the current status of the waypoint sequencing (GPS SEQ) switch. For more information on the waypoint sequencing switch and waypoint 'hold' operations, see Section 5.

During route operations, the NAV summary page is used to provide turn anticipation, next desired track and waypoint arrival information to the pilot. The GPS 155XL's **turn anticipation feature** will smooth out the transition between adjacent route legs by providing CDI guidance along a curved path segment. This leg transition is based on the aircraft's actual ground speed and the difference between the course angle of the two legs. The GPS 155XL will automatically sequence to the next leg when you are abeam the 'active to' waypoint on the curved transition segment, and the to/from indicator on the CDI will flip momentarily. During the transition, the CDI display will be referenced to the dotted line illustrated at the right. Turn anticipation will not be provided in the following scenarios:

- Waypoint/fix crossing is a requirement of the approach, SID or STAR you're navigating.
- The GPS SEQ switch is in the HOLD position.
- Your current ground speed and the course angle between the two legs require a bank angle greater than 25° (see right).

As you approach a route waypoint, the GPS 155XL's external waypoint annunciator will flash 15 seconds before the turn anticipation point, and the graphical CDI will be replaced by a flashing 'Next dtk xxx°' prompt (and the desired track readout on the map page will flash), indicating the desired track of the next route leg.

To use the turn anticipation feature, note the 'Next dtk' heading when the external waypoint annunciator begins to flash, and start the turn when the annunciator glows steadily (approximately 2 seconds before the turn anticipation point). Once you've reached the turn anticipation point, the desired track (dtk) field on the NAV summary page will change to display the course for the next leg. If you have not adjusted your HSI course selector before the turn, the 'Next dtk' will continue to flash until you have reached the midpoint of the turn. Please refer to your aircraft flight manual supplement for specific turn anticipation instructions.

Since the **approach select**, **STAR select** and **SID select pages** relate to the GPS 155XL's approach features, these pages and their functions are described in Section 5.

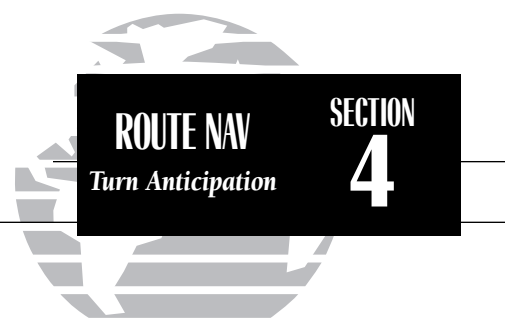

```
Next dtk 034°
dis 150M gs :160K
dtk 109° brg 108°
KTOP →KIXD trk 108°
```

As you approach a route waypoint, the graphical CDI will be replaced by a flashing 'Next dtk xxx°' prompt indicating the desired track of the next leg. When using the map page, the desired track readout will flash and indicate the dtk for the next leg.

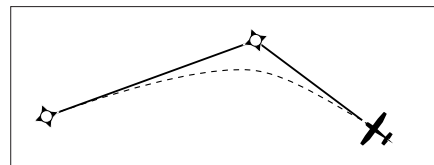

If the turn angle and your present speed will require a bank angle that exceeds 25°, you'll be notified with a 'Steep turn ahead' message approximately 90 seconds before arrival at the active to waypoint.

SECTION

5

APPROACH NAV

Overview

```

*****↑*****
go to ANX cum ete
F→ANX 40.93nm 0:22
↓:SLIMS 57.34nm 0:31
  
```

Once an approach is selected, the GPS 155XL will replace the destination airport with the appropriate approach waypoints. The initial approach fix, final approach fix and missed approach point waypoints are indicated by an 'if', 'ff' and 'mp' designation to the immediate left of the waypoints.

In many instances, there may be approach waypoints in the GPS approach that are not shown on the approach plate. These approach waypoints are usually intermediate fixes designed to help the GPS provide smooth navigation along the approach path.

Section 5

Approaches, SIDs and STARs

The GPS 155XL's approach navigation mode allows you to fly non-precision approaches to airports with GPS and overlay procedures using information contained on your Jeppesen NavData® card. GPS approaches are similar to existing IFR approach procedures, but provide additional course and distance information for a higher level of accuracy, efficiency and safety. The non-precision approaches available in the GPS 155XL are executed using the GPS route features covered in Section 4, so it's important to understand routes before attempting approach navigation. A **GPS approach** is a sequence of waypoints linked together as an approach route which replaces your destination airport waypoint when selected. It may be based on an existing RNAV, VOR or NDB approach procedure, or be an entirely new approach created specifically for GPS. Regardless of the type of approach on which a GPS procedure is based, the procedure is flown as a sequence of route legs in the active route.

The GPS 155XL's **auto-arming** feature provides automatic control of the two phases of approach operations: **arm approach** and **active approach**. The arm approach phase consists of selecting an approach from the database and ensuring that the receiver is ready to begin the tighter integrity monitoring and CDI adjustment required for approach navigation. The active approach phase tightens the accuracy requirements and sensitivity one step further to meet TSO standards for the non-precision approach. Auto-arming of the approach will occur once you are within 30 nm of the destination airport, and will be indicated by an 'ARM' message on the external GPS APR switch. The approach will then transition to the active phase when the aircraft is within 2 nm of the FAF along the inbound course to the final approach fix.

The GPS 155XL works in conjunction with a set of external switches and your HSI (OBS) to fly GPS approaches. The external switches are used to control GPS functions, and contain illuminated annunciators to indicate when functions are active. Your installation must also have annunciators for waypoint arrival and GPS messages.

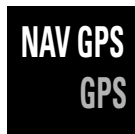
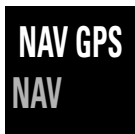

The **NAV/GPS switch** determines which data (GPS or NAV1) will be displayed on the HSI and used by the autopilot/flight director. The current selection will be indicated by an annunciator light. If power to the GPS 155XL is lost, the system will automatically revert to NAV1.

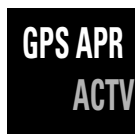
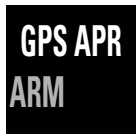
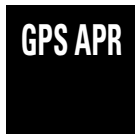

The **GPS APR switch** is used to arm or deactivate an approach, and indicates the current approach phase status ('ARM' or 'ACTV'). The GPS 155XL will automatically arm a selected approach 30 nm from the airport. If the pilot wishes to terminate the approach or fly the missed approach, the GPS APR switch may be pressed to disarm/deactivate the approach at any time and return the CDI scale sensitivity to the 1.0 nm setting. The GPS APR switch may also be used to re-arm the approach at any time before reaching the FAF. If the selected approach is disarmed before the FAF, the unit will prompt you to re-arm the approach 3 nm before the final approach fix.



Arm Approach Mode

The external GPS APR switch will automatically be set to the ARM position 30 nm from the destination airport. Once the approach is armed, the unit will provide a smooth transition from the 5.0 to 1.0 nautical mile CDI scale, and down to 0.3 nm within 2 nm inbound to the FAF. If the approach is manually disarmed, it may be re-armed at any time (before reaching the FAF) by pressing the GPS APR switch.

SECTION 5

APPROACH NAV Basic Rules of GPS Approaches

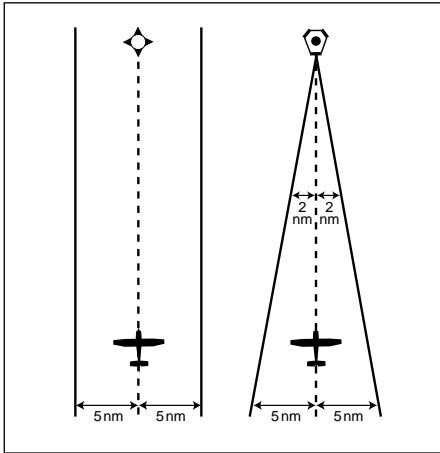

Unlike a VOR, GPS CDI deflection is based on the cross-track distance to the desired course, regardless of how far away you are from the destination.

- If you cross the same waypoint twice in succession during an approach (e.g., the IAF and FAF at the same waypoint, or radar vectors to the FAF), you must set the GPS SEQ switch to the HOLD position **prior** to crossing the fix the first time to prevent the GPS from sequencing to the next waypoint.
- During a GPS approach, keep in mind that your external HSI will display the same CDI needle deflection and scale as the CDI on the GPS 155XL, which will transition from 5.0 to 0.3 nm through the approach. Also note that unlike a VOR CDI, the GPS CDI scale is based on the **cross-track distance** to the desired course (the distance to the reference waypoint does not have an effect on the CDI scale, see illustration left).
- The HSI course select should always be set 2 seconds **before** changing the GPS SEQ from HOLD to AUTO to ensure the desired course to the next waypoint is settled prior to use by the GPS and give the autopilot sufficient time to react to the heading change.
- GPS always displays distance from the currently active waypoint. When determining distance along the approach, use caution to determine the correct distance from the approach chart.
- RAIM must be available (the GPS 155XL automatically monitors RAIM, and will display a message if it is not available) from the FAF to the MAP. If RAIM is not available or becomes unavailable during this leg, the HSI NAV flag will appear, and you must fly the missed approach procedure.
- When flying a missed approach, SID or STAR, you must fly all published procedures and ensure that all printed course and altitude restraints are achieved.
- If you are off course to the MAP waypoint and use a direct-to to re-center the d-bar, the active approach will be cancelled.
- SUA alerts are disabled when an approach is selected and armed and the aircraft is less than 30 nm from the destination airport. SUA information is still available from the NRST key at all times.

Flying A Typical Approach

The non-precision approaches available from the GPS 155XL will all follow the same general flow of events described below. Specific details and instructions relating to each step, along with several approach examples are provided later in this chapter.

1. Create a direct-to or route with an airport as the final destination

To save time during your flight, you may wish to create a route and select an approach before takeoff using the route catalog page.

2. Select an approach for the destination airport

An approach may be selected at any time, but must be loaded before reaching the final approach fix. Once an approach is selected, the approach waypoints will replace the destination airport and the GPS 155XL will provide navigation to the Initial Approach Fix.

3. Transition to the Arm Approach Phase

The GPS 155XL will automatically arm the approach 30 nm from the destination airport. The CDI scale will begin to ramp down from the 5.0 nm to the 1.0 nm scale, and the GPS APR annunciator will indicate an 'ARM' status.

4. Establish yourself on the final approach course

- No procedure turn approach— no special requirements
- Radar vectors— requires use of GPS SEQ switch to hold on designated approach waypoint
- Procedure turn— requires use of GPS SEQ switch to hold on active waypoint
- DME arc— requires use of position page to monitor distance from reference waypoint

(continued on the next page...)



A simulated GPS display screen. At the top, there is a row of asterisks with an upward-pointing arrow in the center. Below this, the text reads "Goto KACY slct appr" on the first line, "vor rw13?" on the second line, and "↓ vor rw22?" on the third line. The text is in a monospaced font.

Select the approach.



The GPS 155XL will automatically arm the approach 30 nm from the destination airport.

SECTION

5

APPROACH NAV

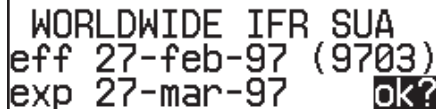
Typical Approach
Procedures

WORLDWIDE IFR SUA
eff 27-feb-97 (9703)
exp 27-mar-97 ok?

GPS approaches must be in the current aviation database to be approved.

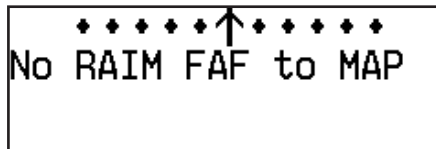

◆ ◆ ◆ ◆ ◆ ↑ ◆ ◆ ◆ ◆ ◆
No RAIM FAF to MAP

TSO C-129a requires that satellite coverage and navigational accuracy provided by the GPS system meet minimum standards. A 'No RAIM from FAF to MAP' message will appear if RAIM is predicted to be unavailable for an approach. If you receive a RAIM message, continue the approach ONLY if the ACTV annunciator remains illuminated to the MAP. If the ACTV annunciator does not stay illuminated, your HSI NAV flag will appear, and you must fly the missed approach procedure.

5. Transition to Active Approach Phase

The approach will automatically transition to the active approach stage and the GPS APR annunciator will indicate an 'ACTV' status if the following conditions are met:

- The approach is armed
- The aircraft is 2 nm from the FAF on an inbound course
- The GPS SEQ switch is set to the 'AUTO' position
- The FAF is the active-to waypoint
- The GPS 155XL confirms that integrity monitoring will be available to complete the approach

Once the active approach phase begins, the CDI scale will begin to gradually transition from the 1.0 nm scale to the 0.3 nm scale, and remain at the 0.3 nm scale from the FAF to the MAP unless the approach is cancelled by pressing the external GPS APR switch, setting the GPS SEQ switch to 'HOLD' or by initiating a direct-to operation.

WARNING: You are not authorized to fly the final portion of the approach unless the external GPS APR annunciator indicates an 'ACTV' status.

6. Missed Approach Procedure

The GPS 155XL's automatic waypoint sequencing stops at the missed approach point. Once you have crossed the MAP, the GPS 155XL will give you the option of flying direct to the missed approach holding point:

- Press the GPS APR switch to return the CDI to the 1.0 nm scale.
- AFTER crossing the MAP, press **→**, followed by **ENT** to fly directly to the missed approach holding point.

WARNING! A direct course to the missed approach holding point may not correspond to the published missed approach procedure. Always fly all published procedures before selecting the holding fix on the GPS.

Selecting and Loading an Approach

When an arrival airport is selected with the direct-to key (or created and activated in a route to the arrival airport), the approaches for your arrival airport become available through the **approach select page**, which can be viewed by pressing **RTE** and rotating the outer knob. Remember that an airport must be the last waypoint in a route to select an approach.

To select an approach:

1. Select the destination airport using the **->** key, or create and activate a route to the destination airport (see Section 4).
2. Press **RTE** and rotate **○** to display the approach select page.
3. Rotate **●** (or **○** with the cursor active) to display the desired approach procedure.
4. Press **CRSR** twice (if necessary) and rotate **○** until the desired approach is highlighted.
5. Press **ENT** to select the approach.

If an approach procedure has more than one Initial Approach Fix (IAF), you'll need to select the desired IAF identifier for your approach.

To select an IAF:

1. Rotate **○** until the desired IAF is highlighted.
2. Press **ENT**.

Once the IAF is selected, the approach waypoints will be inserted into Route 0, replacing the destination airport, and the active route page will be displayed. To review the active route, rotate the **●** knob. The scrolling arrow prompt will indicate which direction to scroll to view additional waypoints, while the 'if', 'ff' and 'mp' designators will indicate the IAF, FAF and MAP respectively.



Select the Initial Approach Fix.

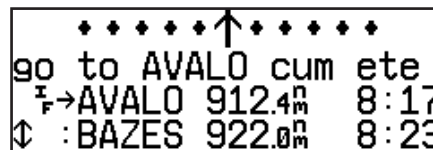

Once the approach is loaded, the active route page will appear.

SECTION

5

APPROACH NAV

Flying the Approach



CDI Settings
scale Auto ± 1.0^{nm}

The GPS APR switch will indicate 'ARM' when the approach is armed. This will begin automatic CDI scale transitioning from 5.0 nm to 1.0 nm as you make your way to the FAF.



Next dtk 304°
dis 5.57^{nm} gs : 300^{kt}
brg 060° dtk 062°
AVALO→BAZES ete 1:07

The 'Next dtk' prompt will flash to indicate the desired course for the leg of the approach route. Set the HSI course select to the next dtk value when the waypoint annunciator starts flashing.

When the aircraft is within 30 nautical miles of the destination airport, the GPS 155XL will automatically arm the approach, and the GPS APR switch will indicate an 'ARM' status.

To fly the GPS approach (without radar vectors):

1. Confirm that the GPS APR switch indicates an 'ARM' status. The CDI scale will begin a steady transition from the 5.0 nm to the 1.0 nm scale as you make your way to the FAF. If the approach has been disarmed and the aircraft is within 3 nm of the FAF, the GPS 155XL will prompt you to re-arm the approach.
2. The GPS 155XL will automatically sequence to each waypoint in the approach, with CDI, course and timing guidance to each waypoint. For each waypoint in the approach, the GPS 155XL's turn anticipation and waypoint alerting features will provide three pilot cues:
 - a. The waypoint annunciator will flash approximately 15 seconds before reaching the turning point for each approach waypoint, and glow steadily approximately 2 seconds prior to the turn anticipation point.
 - b. The 'Next dtk' prompt will flash in the CDI field when the 'WPT' annunciator begins flashing. Set the HSI course select to the next dtk value when the waypoint annunciator starts flashing. Start the turn when the annunciator glows steadily.
 - c. The To/From indicator flag on the GPS CDI will flip momentarily to indicate you have transitioned to the next approach leg.

For more information on turn anticipation and waypoint alerting, please refer to Section 4.

3. If a procedure turn is required:
 - a. 2 miles prior to crossing the waypoint outbound, set the GPS SEQ switch to HOLD.
 - b. At the waypoint, set the outbound course on the HSI.
 - c. Fly the procedure turn. After the procedure turn outbound, set the inbound course on the HSI.
 - d. On the inbound intercept to the final course, fly to center the CDI.

(continued on next page)

- e. Set the GPS SEQ switch to the AUTO position. The GPS 155XL will resume automatic waypoint sequencing for the remaining approach waypoints.
4. Once the aircraft is within 2 nm of the FAF (and the approach is armed), the 'ACTV' annunciator will illuminate and the CDI scale will ramp down to 0.3 nm.
NOTE: If the ACTV annunciator does not illuminate, do not descend after crossing the FAF and fly all published missed approach procedures.
5. Upon reaching the FAF, the GPS 155XL will automatically sequence to the MAP waypoint.

To fly a missed approach procedure:

If an approach is terminated, the GPS 155XL may be used to navigate to the missed approach holding point using one of the following procedures.

NOTE: To comply with TSO specifications, the GPS 155XL will not automatically sequence to the missed approach holding point. The missed approach holding point will be displayed as the next available waypoint, which the pilot may activate when authorized. You must fly all published missed approach procedures before selecting the missed approach holding point on the GPS. If you want to disarm the approach and return the CDI scale to the 1 nm sensitivity, press the GPS APR switch.

If the approach procedure permits navigation direct from the MAP to the missed approach holding point:

1. After the MAP has been crossed, press the **→** key. The GPS 155XL will automatically display the first waypoint of the missed approach as the next approach waypoint.
2. Press **ENT** to confirm the destination. The GPS 155XL will provide a direct navigation course to the waypoint.



```

Enter waypoint
go to int:SMITS
N39° 29.25' W074° 20.59'
auto crs:091° ok?
  
```

After crossing the MAP, press the **→** key to display the missed approach holding point.

```

♦ ♦ ♦ ♦ ^ | ♦ ♦ ♦ ♦
dis 10.47M gs :110K
brg 093° dtk 092°
go to:SMITS ete 7:20
  
```

If you have clearance directly to the holding point, press **ENT**. You must fly all published missed approach procedures before navigating to the holding point.

SECTION

5

APPROACH NAV

Missed Approach

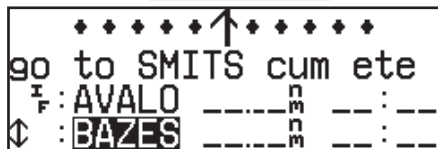

Select the waypoint to which you have been given clearance on the active route page and press **→**.

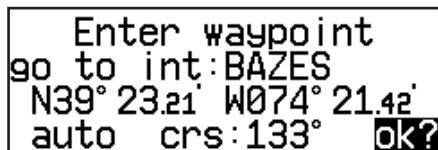

Confirm the starting waypoint for the next attempt by pressing **ENT**.

If you're not authorized to fly direct-to the missed approach holding point:

1. After the MAP has been crossed, press the **→** key. The GPS 155XL will automatically display the first waypoint of the missed approach procedure as the next approach waypoint.
2. Press **ENT** to confirm the destination.
3. Stop automatic waypoint sequencing by setting the GPS SEQ switch to the HOLD position.
4. Fly the missed approach procedure. Remember to select the desired inbound course to the missed approach holding point before setting the GPS SEQ switch to the AUTO position.
5. Set the GPS SEQ switch to the AUTO position for navigation to the missed approach holding point.





After a missed approach, the GPS 155XL will allow you to repeat the same approach procedure and select the approach waypoint to which you have been cleared as the next active to waypoint. Before reactivating the approach, make sure you fly all published missed approach procedures.

To reactivate the same approach for another attempt:

1. Press the **RTE** key and rotate **○** to select the active route page.
2. Press **CRSR** and rotate **○** to place the cursor over the identifier of the approach waypoint to which you have been given clearance.
3. Press the **→** key, followed by **ENT**. The GPS 155XL will provide navigation for the repeat approach, starting with the approach waypoint you have selected.





The GPS 155XI's **approach select page** allows you to review the available approach procedures at the destination airport. From the procedures list, you may select and activate a new procedure on the fly. The active approach is indicated by an on-screen asterisk, and the scrolling arrow prompt indicates which direction to scroll to view additional procedures.

To select or replace a procedure from the approach select page:

1. Press the **RTE** key and rotate  until the approach select page appears.
2. To review all available procedures, rotate . "Unkn" (unknown) is displayed on the Approach Select Page when the unit software does not know how to display a new approach type in the database. DO NOT USE THIS APPROACH TYPE.
3. To review all available procedures, rotate .
4. To select a procedure, press **CRSR** and rotate  to highlight the desired procedure.
5. Press **ENT**. If there are multiple IAFs for the selected approach, rotate  to select the desired IAF and press **ENT**.

You may also replace or delete the active approach from the route catalog page.

To replace or delete an approach from the route catalog page:

1. Press the **RTE** key and rotate  until the route catalog page appears.
2. Press **CRSR** and rotate  until the 'approach?' prompt appears. Press **ENT**.
3. To replace the active approach procedure, rotate  to highlight the desired procedure and press **ENT**. If there are multiple IAFs for the selected approach, rotate  to select the desired IAF and press **ENT**.
4. To delete the active approach (denoted by an asterisk), highlight the approach and press **CLR**, followed by **ENT**.

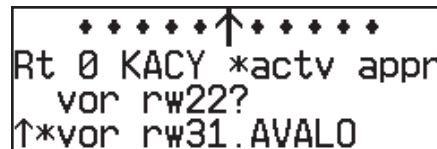

Approach Select Page

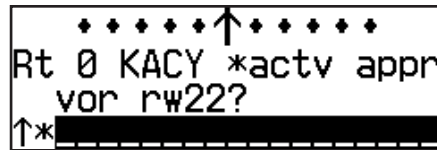

The Approach Select Page after deleting the active approach. If direct-to navigation to a SID/STAR/Approach waypoint is active when the procedure is deleted, the direct-to waypoint will be retained as an "off route" destination.

SECTION

5

APPROACH NAV

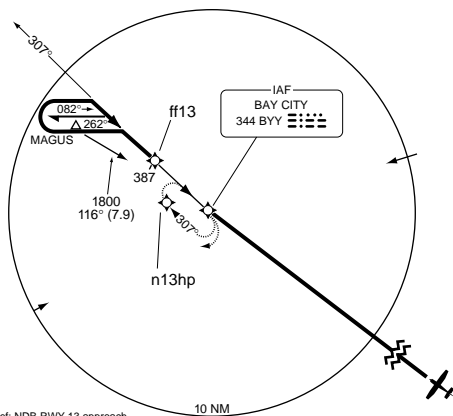
GPS Approach
Examples

GPS APPROACH EXAMPLES

In the examples that follow, the GPS waypoints are shown along the approach path. In some cases, intermediate database waypoints have been added to approaches. These waypoints are named using lower case letters using the following convention (the most common database waypoints are defined below). Note that these waypoints are not charted on NOS approach plates. They do appear on current Jeppesen approach charts.

- **dyyyj**— DME arc waypoint where yyy is the radial from the reference facility (VOR) and j represents the arc radius (e.g., “a” = 1 nm, “b” = 2 nm, etc.)
- **cfxx or cfxxx**— course fix for runway xx or radial xxx
- **ffxx or ffxxx**— final approach fix for runway xx or radial xxx
- **rwxx**— runway xx threshold
- **nxxhp**— NDB approach runway xx intermediate holding pattern waypoint
- **maxx or maxxx**— missed approach point for runway xx or radial xxx
- **vxxhp**— VOR approach runway xx intermediate holding pattern waypoint

APPROACH NAV SECTION 5

GPS Only Approach Example

EXAMPLE 1— GPS ONLY APPROACH

Example 1 uses the GPS approach into Frederick Municipal Airport (KFDK) and illustrates the basic sequence of selecting and flying a GPS approach, and flying directly to a missed approach holding point. Please refer to the previous sections of this chapter for expanded keystroke instructions.

1. Select the destination airport (KFDK) using the **→** key, or create and activate a route to the destination airport.
2. Select the desired approach (GPS RW05) from the approach select page. The GPS 155XL will automatically select MRB as the IAF since it is the only IAF available.
3. Confirm that the GPS APR switch indicates an 'ARM' status 30 nm from the airport. The CDI will automatically begin a smooth transition from the 5.0 nm to the 1.0 nm scale.
4. Fly the approach. The GPS will provide navigation to each approach waypoint in sequence:
 - MRB (initial approach fix)
 - SUSII
 - BAKEE (final approach fix)
 - MYRTA (missed approach point)
 - RUSSY (missed approach holding point)
5. Set the HSI course to DTK at each waypoint. Confirm that the GPS APR switch indicates an 'ACTV' status within 2 nm of the FAF (BAKEE). The CDI will automatically transition from the 1.0 nm to 0.3 nm scale as you approach the FAF, and the unit will warn you if RAIM is not available for your approach.
6. Complete the approach by landing or perform the missed approach procedure.
7. For direct navigation guidance to the missed approach holding point (RUSSY), press **→** followed by **ENT** after crossing the MAP (MYRTA).

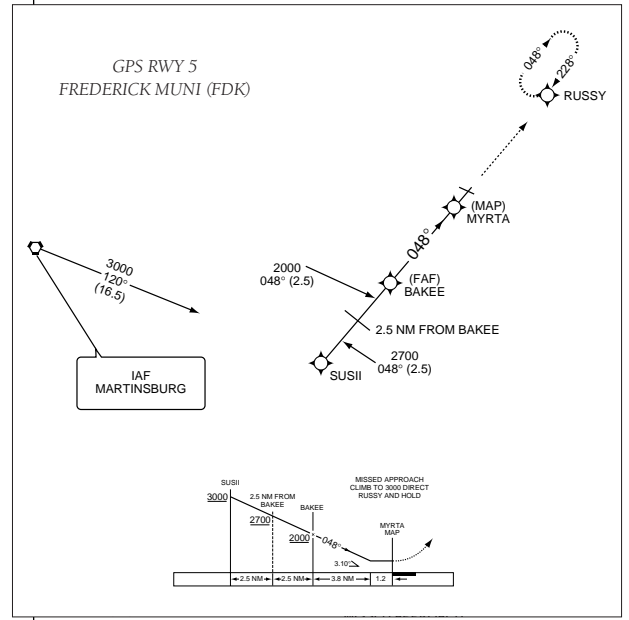

DO NOT USE FOR NAVIGATION

SECTION 5

APPROACH NAV VOR/GPS Overlay Example

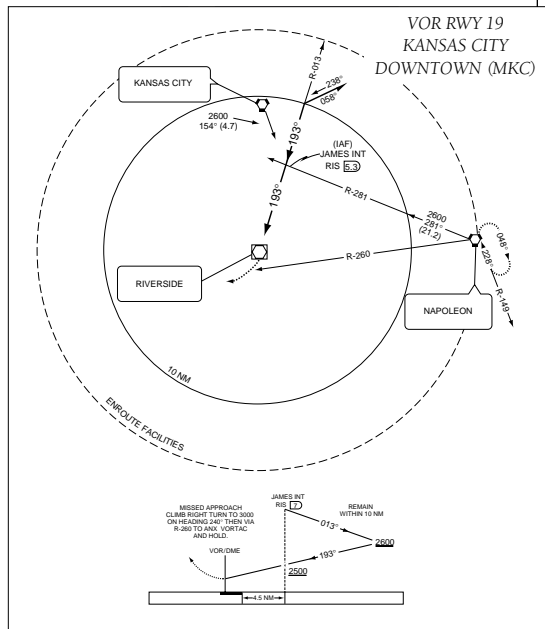

DO NOT USE FOR NAVIGATION

EXAMPLE 2 – VOR/GPS OVERLAY APPROACH

Example 2 uses the VOR/GPS RWY 19 approach into Kansas City Downtown Airport (KMKC) from the south and illustrates an approach with a procedure turn, which requires the pilot to set the GPS SEQ switch to the HOLD position prior to crossing the IAF the first time. This example also illustrates the procedures required when direct navigation to the missed approach holding point is not available.

1. Select the VOR/GPS RWY19 approach and confirm that the GPS APR switch indicates an 'ARM' approach status.
2. Fly towards the IAF (JAMES) of the approach.
3. Two nautical miles *before* crossing the IAF, set the GPS SEQ switch to the HOLD position. This prevents the GPS 155XL from automatically sequencing to the MAP (Riverside) before the required procedure turn is completed.
4. After crossing the IAF, set the 013° outbound course on the HSI.
5. Initiate the procedure turn and set the 193° inbound course on the HSI. As you turn to the inbound intercept heading, set the GPS SEQ switch to the AUTO position. The GPS SEQ switch must be set to the AUTO position for the approach to go active.
6. Confirm that the GPS APR switch indicates an 'ACTV' approach status within 2 nm of the FAF. Complete the approach by landing, or follow the missed approach procedure.
7. To fly the missed approach procedure, cross the MAP (Riverside), climb to 3000 feet via heading 240° and press **→** followed by **ENT**. This will select the missed approach holding point (ANX) as your 'active to' waypoint.
8. Since direct navigation to the holding waypoint is not authorized, set the GPS SEQ switch to the HOLD position to prevent automatic waypoint sequencing.
9. Set the HSI to the 080° heading and turn left to intercept the inbound course to the holding point.

EXAMPLE 3 – VOR/DME ARC OVERLAY APPROACH

Example 3 uses the VOR/DME RWY 21 approach into Topeka/Forbes Field Airport (KFOE) and illustrates an approach based on a DME arc. Although DME arc approaches are not based on a direct course, the GPS 155XL will still provide approach navigation guidance through the arc by constantly displaying your distance and bearing from the DME reference navaid on the **position page**. To fly the arc, monitor the distance displayed on the position page and manually adjust your heading to maintain the course along the arc. When flying a DME arc, the GPS SEQ switch must be set to the HOLD position to ensure proper CDI operation.

1. Select the VOR RWY21 approach and select the D094G initial approach fix to fly the left hand arc from the 094° radial. Thirty nautical miles from the airport, confirm that the GPS APR switch indicates an 'ARM' status.
2. Fly towards the IAF (D094G). The GPS WPT annunciator will flash 15 seconds before you reach the waypoint.
3. After crossing the IAF, set the GPS SEQ switch to the HOLD position.
4. Set the desired inbound course (205°) on the CDI/HSI.



5. Press **NAV** and rotate **⊙** to display the position page. The position page will display the DME navaid as the reference waypoint (on the bottom line) as long as your 'active' waypoint is part of the DME arc you are flying.

(continued on next page)

APPROACH NAV SECTION

VOR/DME ARC 5

Example

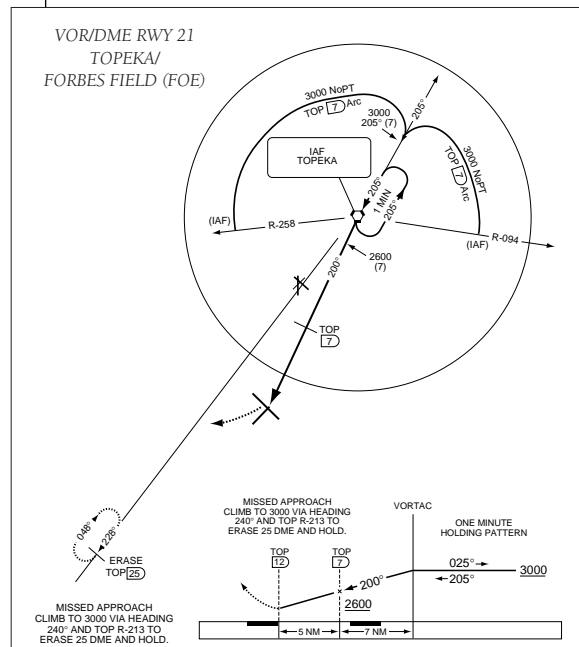

DO NOT USE FOR NAVIGATION

EXAMPLE 4— RADAR VECTORS TO FINAL APPROACH COURSE

Example 4 uses the same VOR/DME RWY 21 approach into Topeka/Forbes Field Airport (KFOE) used in Example 3 and illustrates an approach using radar vectors to a point 3 miles out from the final approach fix. To fly a radar vector approach, you must still select a desired approach and IAF from the database and set the GPS SEQ switch to HOLD while you fly the vectors to the active approach waypoint. To accommodate radar vectors, the GPS 155XL allows manual selection of any approach waypoint as the destination waypoint.

1. Select the desired approach and initial approach fix. Thirty nautical miles from the airport, confirm that the GPS APR switch indicates an 'ARM' status.
2. When you are advised by the controller that you will be receiving radar vectors to the final approach course:
 - a. Activate the final approach fix waypoint from the active route page:
 - i. Press the **RTE** key and rotate **TOP** until the active route page appears.
 - ii. Rotate **TOP** until 'ff21' is displayed.
 - iii. Press **CRSR** to activate the cursor.
 - iv. Rotate **TOP** until 'ff21' is highlighted.
 - v. Press **→**, followed by **ENT**.
 - b. Set the GPS SEQ switch to the HOLD position.
3. Set the 200° inbound course on the HSI. As the CDI needle begins to center to the final approach course, set the GPS SEQ switch to the AUTO position.
4. Confirm that the GPS APR switch indicates an 'ACTV' status 2 nm from the FAF. Complete the approach by landing or perform the missed approach procedure.

APPROACH NAV

Radar Vector Example

SECTION 5

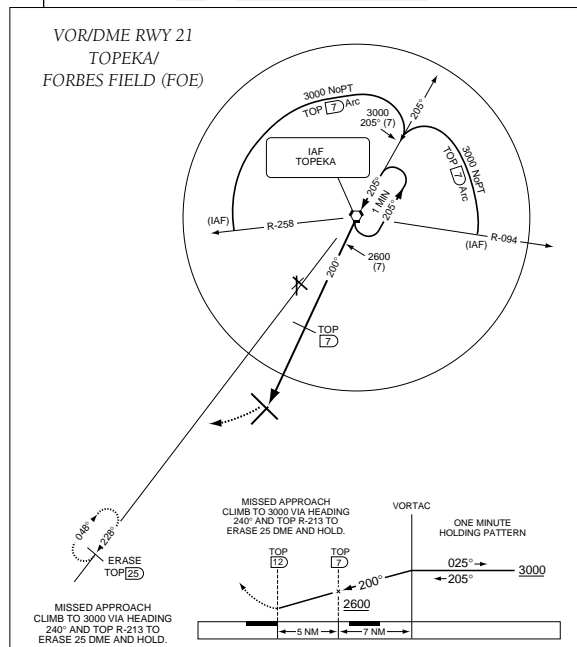

DO NOT USE FOR NAVIGATION

SECTION

5

APPROACH NAV

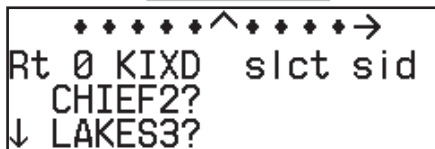
Selecting &
Activating SIDs

```

♦ ♦ ♦ ♦ ♦ ^ ♦ ♦ ♦ ♦ ♦ →
Rt 0 KIXD slct sid
  CHIEF2?
↓ LAKES3?

```

Selecting a SID.

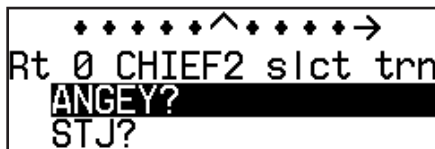

```

♦ ♦ ♦ ♦ ♦ ^ ♦ ♦ ♦ ♦ ♦ →
Rt 0 CHIEF2 slct trn
  ANGEY?
  STJ?



```

Selecting a SID transition.

The Jeppesen database used in the GPS 155XL features **standard terminal arrival routes** (STARs) and **standard instrument departures** (SIDs) that may be placed into any active or stored route.

Available SIDs may be selected for the departure airport at any time in the active route as long as the departure airport is the first route waypoint and the route contains more than one waypoint. SIDs may be selected for the nearest airport when the first route waypoint is not an airport or the route contains less than two waypoints. Activating a SID will modify the waypoint sequence of Route 0. If you'd like to save the contents of Route 0, be sure to copy it to an empty storage route first.

To select and activate a SID:

1. Press **RTE** and rotate  until the SID select page appears.
2. With the cursor inactive, rotate  until the desired SID name appears.
3. Press **CRSR** and rotate  until the SID name is highlighted.
4. Press **ENT**. The SID waypoints will be inserted in the route.

If a SID has more than one runway or transition, the SID select page will display the available runway designations and/or transitions.

To select a transition:

1. Rotate  until the transition name is highlighted and press **ENT**.

To select a runway:

1. Rotate  until the runway designation name is highlighted and press **ENT**.

The SID select page also allows you to review all the available SIDs for the departure airport and select, delete or change the active SID.

To replace/delete the active SID:

1. Press **RTE** and rotate **○** until the SID select page appears.
2. Press **CRSR**. The active SID (denoted by an asterisk) is highlighted.
3. To replace the active SID with another available SID, rotate **○** to highlight the desired SID. Complete the selection by pressing **ENT**.
4. To delete the active SID, press **CLR**, followed by **ENT**. The SID waypoints will be removed from the active route.

SIDs can also be selected and deleted from storage routes through the Route Catalog page.

To select a SID from the route catalog page:

1. Display the desired route on the route catalog page.
2. Select 'sid?' in the route operations field and press **ENT**.
3. Select the desired SID and transitions.
4. The SID waypoints will be inserted into the route and the route review page will be displayed.

To delete a SID from the route catalog page:

1. Display the desired route on the route catalog page.
2. Select 'sid?' in the route operations field and press **ENT**.
3. Rotate **○** to highlight the selected SID (denoted by an asterisk). Press **CLR**, then **ENT**.

```

      * * * * * ^ * * * * * →
Rt 0 KIXD *actv sid
  *ALL.CHIEF2.ANGEY
↓ LAKES3?
  
```

The SID select page allows you to select a new SID on the fly.

```

      * * * * * ^ * * * * * →
Rt 6 KIXD slct sid
  CHIEF2?
↓ LAKES3?
  
```

SIDs may be saved with any stored route.

SECTION

5

APPROACH NAV

Selecting &
Activating STARs

```

  * * * * * ^ * * * * * →
Rt 0 KMCI slct star
  BRAMR2?
↓ JHAWK2?

```

Selecting a STAR.

```

  * * * * * ^ * * * * * →
Rt 0 JHAWK2 slct trn
  CNU?
  EMP?

```

Selecting a STAR transition.

Standard Terminal Arrival Routes (STARs) used in the GPS 155XL are selected and activated with the same procedures as SIDs. Available STARs may be selected for the destination airport at any time in the active route as long as the destination airport is the last waypoint in the active route or the direct-to waypoint. Activating a STAR will modify the sequence of waypoints in Route 0. If you'd like to save the contents of Route 0, be sure to copy it to an empty storage route first.

To select and activate a STAR:

1. Press **RTE** and rotate until the STAR select page appears.
2. Press **CRSR** and rotate until the desired STAR is highlighted.
3. Press **ENT**. The STAR waypoints will be inserted in the route.

If a STAR has more than one transition or runway, the STAR select page will display the transitions and/or runway designations available.

To select a transition:

1. Rotate until the desired transition is highlighted and press **ENT**.

To select a runway:

1. Rotate until the runway designation is highlighted and press **ENT**.

The STAR select page also allows you to review all available STARS for the destination airport and select, delete or change the active STAR.

To replace/delete a STAR:

1. Press **RTE** and rotate **○** until the STAR select page appears.
2. Press **CRSR**. The active STAR (denoted by an asterisk) is highlighted.
3. To replace the active STAR with another available STAR, rotate **○** to highlight the desired STAR. Complete the selection by pressing **ENT**.
4. To delete the active STAR, press **CLR**, followed by **ENT**. The STAR waypoints will be removed from the active route.

STARS can also be selected and deleted from storage routes through the route catalog page.

To select a STAR from the route catalog page:

1. Display the desired route on the route catalog page.
2. Select 'star?' in the route operations field and press **ENT**.
3. Select the desired STAR and transitions.
4. The STAR waypoints will be inserted into the route and the route review page will be displayed.

To delete a STAR from the route catalog page:

1. Display the desired route on the route catalog page.
2. Select 'star?' in the route operations field and press **ENT**.
3. Rotate **○** to highlight the selected STAR (denoted by an asterisk). Press **CLR** followed by **ENT**. The STAR waypoints will be deleted from the route.

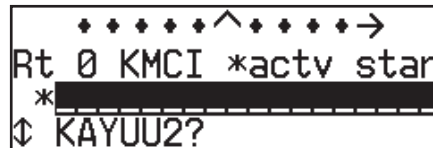

Deleting the active STAR.

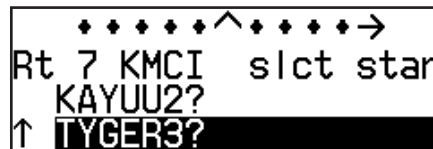

STARS may be saved in any storage route.

SECTION 6

UNIT SETTINGS Messages & Settings Submenus

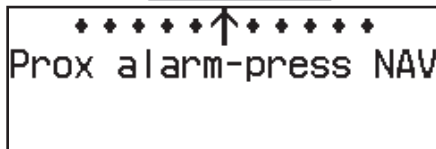

To view a message, press **MSG**.

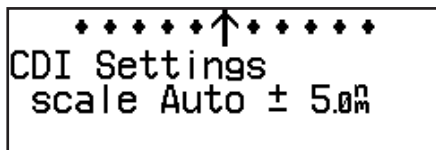

To access the settings submenu pages, press and hold the **MSG** key for two seconds. The GPS 155XL will return to the last submenu viewed the next time you access the unit settings.

Section 6 Messages and Unit Settings

The GPS 155XL's **MSG** key provides access to system messages and allows you to customize the unit to your own preferences through a settings submenu. Whenever the GPS 155XL needs to alert you to a navigation or system message, the annunciator light **(P)** next to the **MSG** key will flash. Some messages are advisory in nature (e.g., the arrival and countdown alarms), while others may require your immediate attention (e.g., poor GPS coverage). For a complete list of GPS 155XL messages, please see Appendix D.

To view a message, press **MSG. Press **MSG** again to return to the previous page.**

The GPS 155XL's settings submenu is also accessed from the **MSG** key.

To view the settings submenu, press and hold **MSG for more than 2 seconds.**

Once the settings submenu has been accessed, the following setup pages are available by rotating **(C)** with the cursor inactive:

- Map page settings
- Nearest airport search
- Battery saver
- Backlighting settings
- Navigation units
- Map datums
- CDI scale settings
- Mag. var./arrival alarm settings
- Display screen settings
- Trip timer settings
- SUA settings
- I/O Settings (channel 2 only)

SECTION 6

UNIT SETTINGS Map Page Setup

The GPS 155XI's map page is designed to be a flexible tool that can be customized to your navigation needs. The **map setup page** provides access to many of the features and functions that will help you configure the map page to your own preferences. From the map setup page you can set the map orientation, automatic zoom, and specify which waypoints and airspace boundaries you wish to display.

The map orientation setting allows you to orient the top of the map display to your current ground track ('trk up'), fix the top of the map to north like a paper chart ('nrth up') or set the top of the map along your desired track ('dtk up').

To change the map orientation:

1. Press and hold **MSG**, then rotate **○** to select the 'MAP Setup' page.
2. Press **CRSR** to highlight the orientation field.
3. Rotate **○** to select 'trk up', 'dtk up' or 'nrth up'.

The automatic zoom feature will automatically adjust the map display scale during your flight. Starting at an en route scale of 300 (nautical miles, statute miles or kilometers) the scale will adjust through each lower scale, stopping at a scale of 1 as you approach your destination waypoint.

To turn the automatic zoom feature on or off:

1. Press and hold **MSG**, then rotate **○** to select the 'MAP Setup' page.
2. Press **CRSR** and rotate **○** to highlight the 'auto zoom' field.
3. Rotate **○** to select 'on' or 'off'.



MAP Setup
orientation trk up
auto zoom on↓

Map setup page



MAP Setup
orientation nrthup
auto zoom on↓

The map orientation may be set to north up, track up or desired track up. This determines what direction the top of the map display is oriented to.

SECTION 6

UNIT SETTINGS Map Page Setup



The automatic zoom feature will automatically adjust the map display through progressively lower scale settings as you approach your destination waypoint.



A scale setting of '200' for airports will display airport locations on the map display for all scales from '200' and lower. Airports will not appear on the map display at a scale setting of '300'.

The map setup page also allows you to control whether or not the various waypoint types and the identifiers for these waypoints are displayed. Settings for each waypoint type allow you to select the maximum scale at which that feature should be displayed, or you may turn that waypoint type off for all scales. For example, by setting 'VOR' at 80, VOR waypoints will appear on the map display at all scales from 80 on down, but not at 120, 200 or 300.

To display airports, nav aids and/or user waypoints:

1. Press and hold **MSG**, then rotate to display the 'MAP Setup' page.
2. Press **CRSR** and rotate to highlight 'apt', 'vor', 'ndb', 'int' or 'user'.
3. Rotate to select the maximum map scale for that waypoint type, or select 'off' to disable the waypoint type entirely.

To display waypoint identifiers:

1. Press and hold **MSG**, then rotate to display the 'MAP Setup' page.
2. Press **CRSR** and rotate to highlight 'apt ident', 'vor ident', 'ndb ident', 'int ident' or 'user ident'.
3. Rotate to select the maximum map scale for that waypoint category, or select 'off' to disable the waypoint identifiers.

The boundaries for airspaces that appear on the map display may be enabled or disabled by airspace type. As described above for waypoints, you select the maximum scale at which the airspace should appear or turn the airspace type off entirely. Airspace categories for Class B/CTA, Class C/TMA, MOA, restricted and other SUAs are provided. 'Other sua' includes alert, caution, danger, training and warning areas.

To enable/disable airspace boundaries on the map:

1. Press and hold **MSG**, then rotate **○** to select the 'MAP Setup' page.
2. Press **CRSR** and rotate **○** to highlight 'class B/cta', 'class C/tma', 'moa', 'restricted' or 'other sua'.
3. Rotate **●** to select the maximum map scale for the designated airspace type, or select 'off' to never display.

The next page under the settings submenu is the **CDI settings page**, which allows you to define the scale of the GPS 155XL's course deviation indicator.

To change the CDI scale:

1. Press and hold **MSG**, and rotate **○** to select the 'CDI Settings' page.
2. Press **CRSR** and rotate **●** to select 'Auto', '±5.0 nm', '±1.0 nm' or '±0.3 nm'.
3. Rotate **○** to highlight 'ok?' and press **ENT** to approve.
(Note: The selected CDI scale will not take effect until approved.)

The scale values represent full scale deflection of the CDI to either side. The default setting is 'Auto'. The 'Auto' setting will start the CDI scale at 5 nm (en route), and gradually ramp down the scale to the 1 nm range once you are within 30 nm of a departure or arrival airport (terminal area). For auto CDI scaling to occur, you must have an active direct-to or route with an airport as your final destination waypoint, or be within 30 nm of a departure airport. Note that the **Receiver Autonomous Integrity Monitoring (RAIM)** protection limits listed below follow the selected CDI scale, changing automatically with the 'Auto' setting:

CDI Scale	RAIM Protection
+/-5.0 nm or Auto (en route)	2.0 nm
+/- 1.0 nm or Auto (terminal)	1.0 nm
+/- 0.3 nm	0.3 nm

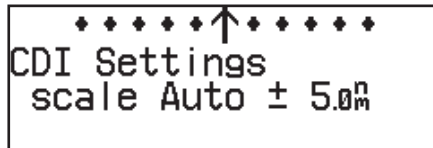
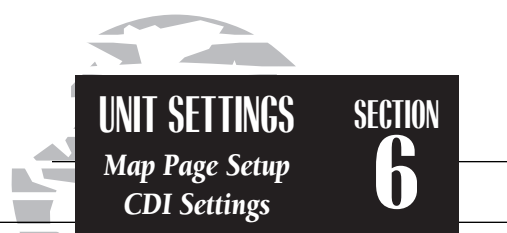

When the 'Auto' CDI setting is selected, the GPS 155XL will automatically change the CDI scale when you are within 30 nm of a departure or arrival airport. The CDI setting will be reset to 'Auto' during approach operations, to provide a smooth CDI transition from 5.0 nm to 0.3 nm scales.



The 'auto mag' setting will automatically calculate the magnetic variation based upon your current position.

SECTION

6

UNIT SETTINGS

Magnetic Variation
Arrival Alarm

Setting the arrival alarm to 10 nautical miles.

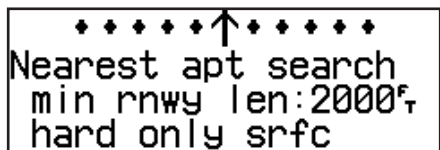

The runway length and surface type settings allow pilots of large, high-performance aircraft to direct the **NRST** key function to ignore those airports at which it would be difficult, if not impossible, to land their aircraft.

The GPS 155XL has three **magnetic variation options**: true, auto, or user-defined.

To set the magnetic variation:

1. Press and hold **MSG** and use **↑** to display the 'Mag Var/Arvl Alarm' page.
2. Press **CRSR** and use **↓** to select 'auto mag', 'true hdg' or 'user mag'.
3. If user is selected, use **↑** to highlight the magnetic variation value, and use **←** and **→** to enter the value and 'E' or 'W'. Press **CRSR** to finish.

If 'auto' mag var is selected, all track, course and heading information will be corrected to the magnetic variation computed by the GPS receiver. The 'true' setting will reference all information to true north, and the 'user' setting will correct information to an entered value.

The GPS 155XL's **arrival alarm** can be set to notify the pilot with a message when you have reached a user-defined distance to a final destination waypoint (the direct-to waypoint or the last waypoint in a route). Once you have reached the set distance (up to 99.9 units), an 'Arrival at ____' message will be displayed.

To set the arrival alarm distance:

1. Press and hold **MSG** and use **↑** to display the 'Mag Var/Arvl Alarm' page.
2. Press **CRSR** and use **↓** to select the arrival distance field.
3. Use **←** and **→** to enter the desired distance. Press **CRSR** to finish.

The **nearest airport search** settings allow you to define the runway length and surface type used in determining the nine nearest airports displayed. A minimum runway length and surface type may be entered to prevent airports with small runways, or runways that are not of appropriate surface, from being displayed. The default settings are '0 ft/mt' for runway length and 'any' for runway surface type.

To set the minimum runway length and runway surface:

1. Press and hold **MSG** and use **○** to display the 'Nearest apt search' page.
2. Press **CRSR** and use **○** and **○** to enter the minimum runway length upon which your aircraft can land (up to 9999 units). Press **ENT** to accept the distance.
3. Rotate **○** to display the surface selection you desire. Choices include:
 - any surface
 - hard only surface
 - soft/hard surface
 - water only surface
4. Use **○** to select 'ok?' and press **ENT** to confirm.

The GPS 155XL's **battery saver feature** can be programmed to automatically turn off the backlighting when using the optional remote battery pack. This will increase the remote battery life in the event of power failure. During this time, the GPS 155XL will continue to navigate and track satellites, but will not backlight the display until a key is pressed or a knob is turned.

To set the display timeout:

1. Press and hold **MSG** and rotate **○** to display the 'Battery saver' page.
2. Press **CRSR** to activate the cursor.
3. Rotate **○** until the desired value is displayed (0, 30, 60 or 90 seconds). Entering 0 will leave the display on at all times. Press **CRSR** to finish.

The GPS 155XL features automatic contrast and backlighting control to adjust the display for optimum viewing in any condition. This is done using a photocell at the top left corner of the display bezel. It is important that this photocell not be covered to ensure proper display adjustment. You may also select manual control of the display contrast and backlighting to tailor the GPS 155XL to your needs.

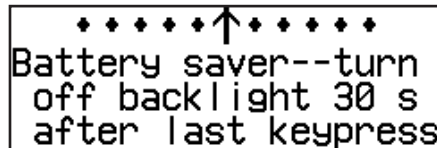
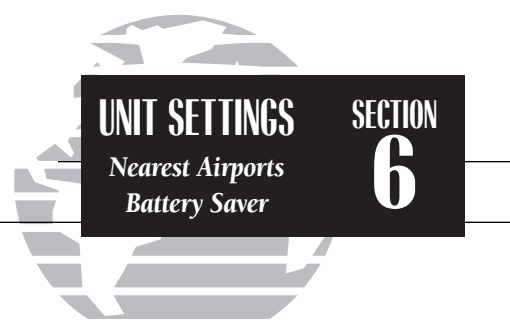

Display timeout settings. As shown, the display backlight will turn off after 30 seconds to conserve power in the optional battery pack.

SECTION 6

UNIT SETTINGS Display Settings



The display contrast may be set to automatically adjust to varying lighting conditions, using the built-in photocell.



Setting the display mode to 'negative' will display on-screen characters as light green on a black background. This setting is suitable for night operation.

To change the display contrast settings:

1. Press and hold **MSG** and rotate **○** to show the 'Display' page.
2. Press **CASR** and use **○** to select 'auto' or 'manual' control.
3. Press **ENT**.
4. If 'manual' is selected, use **○** to set the display contrast level. (If 'auto' is selected you may also change the offset level to your preference.)
5. Press **CASR** to complete.

The 'mode' selection allows you to display on-screen characters as black on a light green background (positive) or light green on a black background (negative). With the 'auto' setting the photocell selects the best mode for day or night viewing.

To change the display mode settings:

1. Press and hold **MSG** and rotate **○** to show the 'Display' settings page.
2. Press **CASR** and use **○** to highlight the 'mode' field.
3. Rotate **○** to select 'pstv', 'ngtv' or 'auto'.
4. If 'auto' is selected, rotate **○** to highlight the threshold level, and use **○** to select the level where the display will switch from positive to negative for night time use. (Note: Some experimentation may be necessary to obtain the desired response level.)

The backlight intensity settings control the backlighting level and allow for automatic adjustment using the built-in photocell or manual adjustment.

To change the backlighting intensity:

1. Press and hold **MSG**, and rotate **○** to display the 'Backlight intensity' page.
2. Press **CRSR** to highlight the 'mode' field.
3. Rotate **○** to select 'auto' or 'manual'.
4. If 'manual' is selected, rotate **○** to select the desired backlighting level.

The **trip timer** provides a running clock on NAV Menu 2 (see page 28) which can be configured to run either when power is on or when your ground speed exceeds a user-defined minimum.

To change the trip timer settings:

1. Press and hold **MSG**, and use **○** to display the trip timer settings page.
2. Press **CRSR** to activate the cursor.
3. Use **○** to select either 'pwr is on' or 'gs exceeds'.
4. If you choose 'pwr is on', press **CRSR** to complete.
5. If you choose 'gs exceeds', use **○** to highlight the speed field.
6. Enter the speed using **○** and **○**.
7. Press **ENT** to accept, and press **CRSR** to complete.

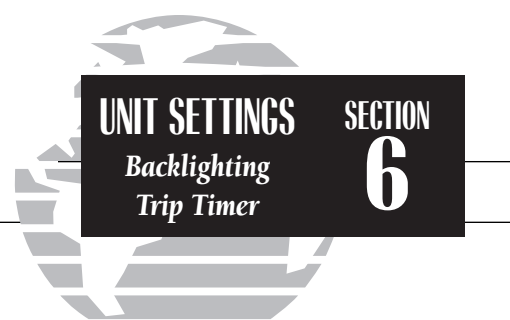

The backlight intensity settings page is used to set/adjust the screen backlighting for day or night operation.

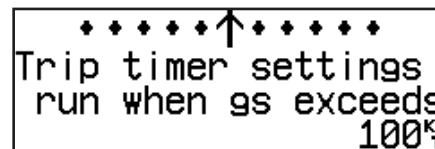

Trip timer settings, showing timer active when ground speed exceeds 100 knots.

SECTION 6

UNIT SETTINGS Units of Measure

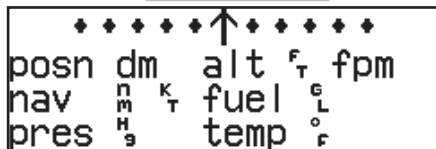

Default units of measure settings.

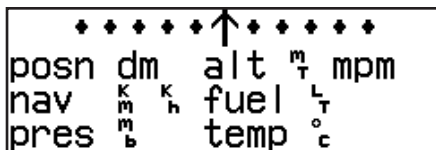

Units of measure settings with all metric values displayed.

The GPS 155XL can be configured to display data in standard or metric **units of measure**. These apply to: distance, position, speed, altitude, fuel, pressure and temperature.

To change the units of measure:

1. Press and hold **MSG** and rotate to display the nav units page.
2. Press **CRSR** and rotate to highlight the field you would like to change.
3. Use to change the unit of measure.
4. Rotate to advance to the next field, or press **CRSR** when finished.

The available units of measure are:

- position :**
- degrees, minutes and seconds (dms) [hddd° mm' ss.s"]
 - degrees and minutes (dm) [hddd° mm.mmm']
- altitude :**
- feet (ft)
 - meters (m)
- vertical speed :**
- feet per minute (fpm)
 - meters per minute (mpm)
 - meters per second (mps)
- nav units :**
- nautical miles and knots (nm, kt)
 - statute miles and miles per hour (mi, mh)
 - kilometers and kilometers per hour (km, kh)
- fuel :**
- gallons (gl)
 - imperial gallons (ig)
 - kilograms (kg)
 - pounds (lb)
 - liters (lt)
- pressure :**
- inches of mercury (hg)
 - millibars (mb)
- temperature :**
- degrees Fahrenheit (°f)
 - degrees Celsius (°c)

UNIT SETTINGS

SUA Settings Altitude Buffer

SECTION 6

The **Special Use Airspace settings page** will allow you to turn the controlled/restricted airspace message alerts on or off. This will not affect the alerts listed on the nearest page. It will simply turn off the warning message when you are approaching or near an SUA. Warnings can be turned on/off for the following airspaces:

class B/cta:	ICAO control area	moa:	Military operations area
class C/tma:	ICAO Terminal Control Area	other:	Other areas includes: alert, caution, danger, training, warning
rstcd:	Restricted areas		

SUA warnings for prohibited airspace cannot be turned off. The 'alt' field, located at the bottom of the SUA settings page, is an altitude buffer which 'expands' the vertical range of the SUA, so you will be notified if you are within a certain range of an SUA. For example, if the buffer is set at 500 feet, and you are more than 500 feet above or below an SUA, you will not be notified with an alert message; if you are less than 500 feet above or below an SUA and projected to enter it, you will be notified with an alert message. The default setting for the altitude buffer is 200 feet.

To set the warnings or change the altitude buffer:

1. Press and hold **MSG**, and use **↑** to display the SUA settings page.
2. Press **CRSR**.
3. Rotate **○** to highlight the field you would like to change.
4. Use **○** to change to 'on' or 'off'.
5. To change the altitude buffer, highlight the buffer value, and use **○** and **○** to change the data. Press **ENT** to accept.
6. Press **CRSR** to complete.

*****↑*****
cl B/cta on moa on
cl C/tma on oth on
alt: 100_m rstcd on

The SUA settings page with all airspace alerts enabled and the altitude buffer set to 100 meters.

*****↑*****
cl B/cta on moa on
cl C/tma on oth off
alt: 500_f rstcd on

The SUA settings page with 'other' airspaces disabled and the altitude buffer set to 500 feet.

SECTION 6

UNIT SETTINGS

Map Datums

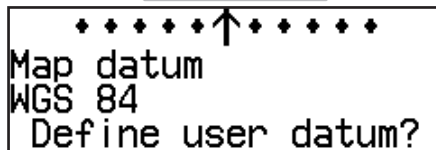

Map datum page showing the default WGS 84 datum. This setting should be used unless your paper chart specifies a different datum.

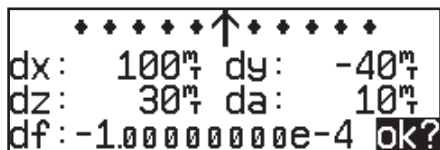

User datum page. To use this function you must enter the parameters as differences from the WGS 84 default.

The NavData card contains over 100 map datums for you to use when navigating. By default, your unit calculates positions using the WGS 84 map datum. If you are using charts based on another datum, you must set the GPS 155XL to use the same datum. Using a map datum that does not match the charts you are using can result in significant differences in position information. If you are using maps for reference only, the GPS 155XL will provide correct navigation guidance to the waypoints contained in the database, regardless of the datum selected.

To change the map datum to one listed in Appendix F:

1. Press and hold **MSG**, and use **○** to display the map datum page.
2. Press **CRSR** to highlight the current map datum.
3. Use **○** to change the datum.
4. Press **CRSR** to complete.

To create a user datum:

1. Press and hold **MSG**, and use **○** to display the map datum page.
2. Press **CRSR**.
3. Use **○** to highlight 'Define user datum?'. Press **ENT**.
4. Enter the five parameters of the map datum using **○** and **○**. Press **ENT** to accept a field. The signs of each value (+/-) should follow the convention: WGS84-local geodetic system.
5. Use **○** to highlight 'ok?', and press **ENT**.
6. To activate the user datum, select 'USER' on the map datum page as described above.

The last page available under the GPS 155XL's setup menu is the **I/O setup page**. The I/O setup page lets you configure the GPS 155XL to input RTCM SC-104 correction data, output to an RS-232 mapping device or a PC (with the optional GARMIN PC Kit or other mapping software) and select the appropriate baud rate. The I/O setup page only provides access to I/O channel 2 input/output. For information on using I/O channel 1, please see your GPS 155XL installation manual.

To change the output settings for I/O channel 2:

1. Press and hold **MSG**, and rotate **○** until the I/O setup page is displayed.
2. Press **CRSR**, and rotate **●** to select 'off' or 'rtcm' to receive DGPS correction data.
3. Rotate **○** to advance the cursor to the output field.
4. Use **●** to select 'off' or 'plotting' for output to an RS-232 device.
5. Rotate **○** to advance the cursor to the baud rate field.
6. Use **●** to select the desired baud rate (300, 1200, 2400, 4800, 9600).
7. Press **CRSR** to finish.



```

* * * * *
I/O Channel 2
in  off
out off          9600

```

I/O setup page

UNIT SETTINGS

I/O Settings

SECTION

6

APPENDIX

A

NAVDATA CARD

Saving User Data

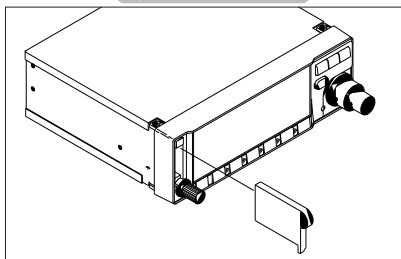

Insert the card with the thumb tab at the top, and the beveled corner on the bottom right.

No data card present
Reinit in 29 seconds
or ENT to reinit

Data card warning

Appendix A

NavData® and User Data Installation/Operation

The NavData card supplied with your GPS 155XL can be installed or removed when the GPS 155XL is on or off. Insert the card with the thumb tab at the top, and the beveled corner at the bottom. If the NavData card is not present when the unit is powered on, you will receive a 'No Jeppesen database' message on the database confirmation page, and you will only be able to use user waypoints for navigation. If the NavData card is removed during operation, a 'No data card present' warning will appear, asking you to reinsert the data card within 30 seconds. If the card is not replaced within 30 seconds, the GPS 155XL will automatically reinitialize. You may also reinitialize the unit manually by pressing **ENT**.



An optional **user data card** can be used to make a backup of user waypoints, routes, etc. and transfer information to another GPS 155XL.

To save user data to the user data card:

1. Install the user data card.
2. Rotate **○** to highlight 'Save user data?'. Press **ENT** to confirm.

The message 'Saving to card' is displayed while the GPS 155XL transfers all user data to the User Data card. It may take a few minutes to complete the transfer. When all user data is transferred, the GPS 155XL will instruct you to turn the unit off, remove the user card and insert the Jeppesen NavData card. After this is complete, the GPS 155XL is ready for normal operation.



To restore user data from a user data card to the GPS 155XL:

1. Install the user data card.
2. Rotate  to highlight 'Restore user data?'.
3. Press .

The GPS 155XL will ask you which type of data to replace. You may choose checklists, scheduler messages, user waypoints, proximity waypoints, routes, waypoint comments, or all data.

4. Rotate  to select the type of data to replace.

You may either replace or update the information in the database. Replacing the data will replace **ALL** user data with the data from the card. Updating the data will not delete unrelated material, but will only change what is necessary to use the data received from the user data card.

5. Rotate  to select either 'Replace?' or 'Update?'.
6. Press  to begin transferring data to the GPS 155XL. The GPS 155XL will now transfer all of the data requested. This may take a few minutes.
7. To continue with more data transfer types, repeat steps 4, 5 and 6. Otherwise, press  when 'ok?' is highlighted.
8. Turn the GPS 155XL off and replace the user data card with a NavData card. The GPS 155XL is now ready for normal operation.



Data transfer page

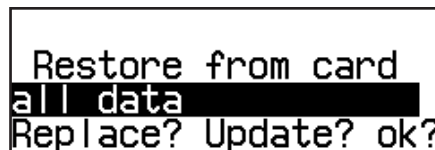

Restore data page

APPENDIX B

INSTALLATION & MAINTENANCE

The GPS 155XL is built to exacting standards and does not require user maintenance. If the faceplate and lens require cleaning, use a soft cloth and non-abrasive cleaner.

The user data is maintained by an internal battery with a projected life of 3 to 5 years. If the GPS 155XL detects a low memory battery, you will be informed with the message 'Memory battery low'. Failure to have the battery replaced may result in loss of data each time you turn your unit off. This will **greatly** increase satellite acquisition time and no user data will be saved. This condition will be accompanied by the message 'Stored data lost'.

The GPS 155XL contains a crystal oscillator which may drift after many years of operation. If the unit detects excessive oscillator drift, you will be informed with the message 'Osc needs adjustment'. When this occurs, contact an authorized GARMIN service center for service. Failure to do so may result in severely degraded acquisition performance.

Appendix B Installation, Removal and Maintenance of the GPS 155XL

The aviation rack is designed to allow easy removal of the GPS 155XL. This enables you to use the unit at home to create routes, interface to a PC, etc. using an optional AC adapter.

To install the GPS 155XL into the aviation rack:

1. Insert a 3/32" allen wrench in the small hole adjacent to the dual knob.
2. Rotate the wrench counterclockwise until it stops to ensure the pawl latch is in the proper position.
3. Insert the GPS 155XL into the aviation rack and rotate the wrench clockwise to secure the unit. To ensure proper connector seating, gently press on the left side of the unit until tightened.

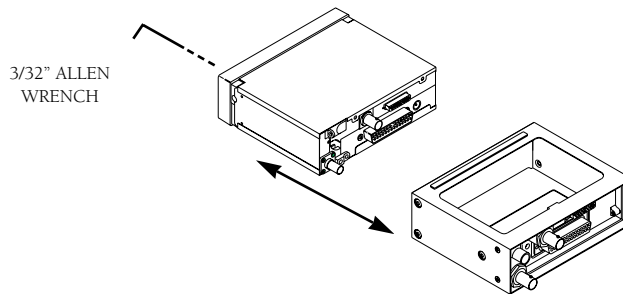





To remove the GPS 155XL from the aviation rack:

1. Insert a 3/32" allen wrench in the small hole adjacent to the dual knob.
2. Rotate the wrench counterclockwise until the GPS 155XL can be removed from the rack.

The GPS 155XL's simulator mode allows you to plan and practice flights in your home and office using an optional remote battery pack or AC adapter. **The simulator is not accessible when the GPS 155XL is running off the master avionics switch.** All waypoint and route planning done in simulator mode will be saved in the unit's internal memory.

To operate the GPS 155XL in simulator mode:

1. Turn the unit on by rotating the  knob clockwise. The welcome page will appear while the unit conducts a self test. Once the self test is complete, the welcome page will be replaced by the operating mode page.
2. Rotate  to move the cursor over the operating mode field ('Normal').
3. Rotate  to select 'Simulator' and press the  key. The cursor will advance to the 'ok?' prompt.
4. Press  to confirm.

Once the GPS 155XL has been placed in simulator mode, the database confirmation page will appear, showing the operating dates, cycle number and database type available.

To acknowledge the database information:

1. Press .

After the database has been acknowledged, the initial position reference page will appear, where you may specify the starting position for your simulated trip. You can define the initial position by entering a waypoint identifier in the reference field, or by manually entering coordinates in the lat/lon field.

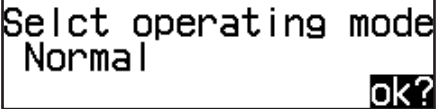

Select operating mode
Normal 

Operating mode page



Select operating mode
Simulator 

Selecting the simulator mode.

```

WORLDWIDE IFR SUA
eff 27-feb-97 (9703)
exp 27-mar-97    OK?
  
```





Database confirmation page

```

No active waypoint
Init posn ref:KIXD_
N38° 58.70' W094° 54.32'
                                OK?
  
```









Entering an initial position reference.

To enter an initial position reference by waypoint identifier:

1. Rotate  to highlight the waypoint identifier field.
2. Use  and  to spell out the identifier of the desired airport, navaid or user waypoint.
3. Press  to confirm the identifier. The waypoint confirmation page will appear, displaying the waypoint's position.
4. Press  to confirm the 'ok?' prompt.

The position page will now appear, and you may now use most of the GPS 155XL navigation features for practice and planning. You'll also receive a 'Do not use for nav' message to remind you that the simulator mode should never be used for actual navigation. During simulator operation, you will be able to enter a ground speed from the NAV summary page, and define a course to a destination from the direct-to confirmation page. Altitude may only be entered by using the VNAV function available from the NAV menu 1 page (see page 25).

To enter a ground speed from the NAV summary page:

1. Press  and rotate  to display the NAV summary page.
2. Press  to activate the cursor.
3. Rotate  to highlight the ground speed field.
4. Use  and  to enter the desired speed. Press  to accept, and  to finish.

To exit the simulator mode, the GPS 155XL must be turned off by rotating the  knob counterclockwise until the unit shuts down. All waypoints and routes created in simulator mode will be retained in the GPS 155XL's internal memory.

Appendix D

GPS 155XL Messages and Abbreviations



The GPS 155XL uses the Message Page to communicate important information to you. Some messages are advisory in nature, others are warnings that may require your intervention. This appendix provides a complete list of GPS 155XL messages and their meanings.

- | | | | |
|----------------------------|---|-----------------------------|---|
| Altitude input fail | - The altitude serializer input is not available for the GPS 155XL. Check the I/O settings and/or the serializer installation. If enough satellites are available for a 3D position fix, no pilot action is required, providing no RAIM warnings are present. If only a 2D fix is possible, the pilot should enter an altitude within 1,000 feet of the current indicated altitude. | Arrvl at offst _____ | - Your craft has entered the arrival alarm circle for the indicated waypoint offset by the parallel track distance. |
| Appr switch stuck | - The GPS APR switch is stuck in the 'pressed' position. Check the switch/installation. | Auto CDI slctd | - The GPS 155XL has reset the CDI scale preference to the AUTO setting to permit approach navigation. |
| Approach deleted | - The selected approach was deleted from the route because not enough room existed to insert a SID or STAR. | Battery low | - The optional remote battery pack is low on power and limited operating time remains. The battery should be recharged for continued use. |
| Approach not active | - The approach could not transition to the active phase because the GPS SEQ switch is set to the HOLD position, the automatic CDI scale is not selected, or RAIM is not predicted to be available from FAF to MAP. Do not descend to the FAF. | Battery rqrs service | - A problem has been detected in the optional remote battery pack. The battery should be serviced at an authorized GARMIN service center. |
| Arm approach mode | - Approach navigation is available. Set the GPS APR switch to the ARM position. | Cannot chng actv wpt | - An attempt has been made to modify the position of the 'active to' or 'active from' waypoint. The GPS 155XL will not allow the modifications. |
| Arrival at _____ | - Your craft has entered the arrival alarm circle for the indicated waypoint. | Cannot chng wpt sqnc | - An attempt has been made to modify an approach, SID or STAR. The waypoint sequence of approaches, SIDs and STARs may not be modified. |
| | | Cannot nav lockd rte | - An attempt has been made to activate a route containing a locked waypoint. The GPS 155XL cannot perform navigation in this situation. |



**APPENDIX
D**

**MESSAGES &
ABBREVIATIONS**

- Cannot ofst goto rte** - An attempt has been made to engage the offset navigation feature while the GPS 155XL is navigating using a single waypoint route. The GPS 155XL will not allow offset navigation in this situation.
- Checklist is full** - The selected checklist is full. No new items can be added until existing items are deleted.
- Comment memory full** -The waypoint comment memory is full. You must delete existing waypoint comments before adding new ones.
- Configuration reset** - The GPS 155XL has detected a failure in its installation configuration memory. Data from the user memory has been used to reset the configuration. Check the installation settings for correctness. If the message persists, the unit is not usable and should be taken to an authorized service center for repair.
- Course input fail** - The course input from RS-422 or ARINC 429 is not available to the GPS 155XL. Check the I/O settings and/or have the installation checked by a certified technician.
- Data card failed** - The GPS 155XL has detected a problem with the

data card. The data is not usable and the card should be returned to Jeppesen or an authorized GARMIN service center.

- Data card write fail** - The user data card failed to program. The card should be returned to an authorized GARMIN service center.
- Degraded accuracy** - The GPS 155XL has detected poor satellite geometry while RAIM is not available. Additional cross-checking with a secondary navigation source should be performed to verify the integrity of the GPS position.
- Do not use for nav** - The GPS 155XL is in the simulator mode and must not be used for actual navigation.
- EEPROM write fail** - The GPS 155XL has detected a failure while programming its installation configuration memory. The unit is not usable and should be taken to an authorized service center.
- Final altitude alert** - The suggested altitude is within 1000 feet of the final altitude entered on the VNAV Planning page.
- Fuel/Air input fail** - The fuel and/or air data input is not available to the GPS 155XL. Check the I/O settings or fuel/air data system installation.
- Heading input fail** - The heading input from ARINC 429 is not available to the unit. Check the I/O settings and/or have the installation checked by a technician.
- Inside SUA** - You have entered a Special Use Airspace.
- Invalid CPA wpt _____** - The closest point of approach cannot be created from the waypoint entered on the CPA Page. This occurs when the computed point does not fall on one of the route legs, or when a unique waypoint name for the closest point of approach cannot be found.



- Invalid copy route** - A non-empty route was selected for a copy operation. A route must be empty before another route can be copied to it.
- Invalid CPA route** - The selected route contains less than two waypoints and cannot be used for CPA operations.
- Invalid SAR route** - The selected route does not contain exactly two waypoints and cannot be used for SAR operations.
- Leg not smoothed** - The upcoming leg is too short for smooth waypoint transitions. Expect a rapid change in the CDI.
- Memory battery low** - The battery that sustains user memory is low and should be replaced by an authorized GARMIN service center as soon as possible. Failure to do so may result in loss of stored data, including all user waypoints and routes.
- Near SUA < 2 nm** - Your position is within 2 nautical miles of an SUA, and your current course will **not** take you inside.
- Need alt - press NAV** - The GPS 155XL needs altitude input in order to start and/or continue 2D navigation. Press the NAV key and enter your antenna altitude on the position page. The altitude you enter should be as accurate as possible. An inaccurate altitude will directly translate into inaccurate position information.
- No altitude input** - The GPS 155XL has failed to receive altitude data from the parallel input. Check the I/O settings and/or the installation. If enough satellites are available for a 3D fix, no pilot action is required, provided no RAIM warnings are present. If only a 2D fix is possible, the pilot should maintain the GPS altitude within 1,000 feet of pressure altitude, using the position page.
- No course input** - The GPS SEQ switch is set to the HOLD position and has no selected course input from the CDI/HSI. Check the state of configuration switches if installed, or check the CDI/HSI unit.
- No DGPS position** - Not enough data is available to compute a differential GPS (DGPS) position.
- No RAIM FAF to MAP** - RAIM is predicted to NOT be available from the final approach fix to the missed approach point. The approach is no longer active.
- No RTCM input** - DGPS data, in an RTCM SC-104 format, is not available.
- Offset nav cancelled** - Offset navigation has been cancelled due to a direct-to operation or modification of the active route.
- Offset nav in effect** - Offset navigation mode is in effect.
- Ofst too big for rte** - The parallel track distance is too large for the active route.
- Osc needs adjustment** - The GPS 155XL has detected excessive drift in its internal crystal oscillator which may result in longer acquisition time. The unit should be taken to an authorized service center immediately.



APPENDIX
D

**MESSAGES &
ABBREVIATIONS**

- Poor GPS coverage** - The GPS 155XL cannot acquire sufficient satellites necessary to provide navigation.
- Prox alarm-press NAV** - Your craft has penetrated the alarm circle of a proximity waypoint. Press NAV to see the bearing and distance to the proximity waypoint.
- Proximity overlap** - The circles defined by two proximity waypoints overlap. When entering the area of the overlap, the GPS 155XL will warn you of the closest proximity waypoint, but not both. You should be certain this condition is desirable.
- Proximity wpt locked** - At least one proximity waypoint is locked because the waypoint has been removed from the Jeppesen NavData®, the data card is missing, or the data card has failed.
- Proximity wpt moved** - One or more proximity waypoints were moved at least 0.33 arc minutes due to a database change.
- Proximity wpt deleted** - One or more proximity waypoints were deleted while receiving data from the PC Interface Kit.
- Pwr down and re-init** - The GPS 155XL is unusable until power has been cycled and the unit re-initialized. Abnormal satellite conditions may exist.
- RAIM not available** - RAIM is unavailable for the phase of flight you are currently in (the HSI NAV flag should also appear). Revert to alternate navigation.
- RAIM position warn** - RAIM has detected position errors exceeding those allowed for the current phase of flight. Revert to an alternate source of navigation.
- RAM failed** - The GPS 155XL has detected a failure in its internal memory. If the message persists, the GPS 155XL is unusable and should be taken to an authorized GARMIN service center.
- Rcvr needs service** - The GPS 155XL has detected a condition requiring service in the receiver hardware. The GPS 155XL should be taken to an authorized GARMIN service center.
- Ready for navigation** - The GPS 155XL is ready for navigation.
- Receiver failed** - The GPS 155XL has detected a failure in the receiver hardware. If the message persists, the GPS 155XL is unusable and should be taken to an authorized GARMIN service center.
- Remote ENT key stuck** - The remote ENT key is stuck in the 'pressed' position. Check the key/installation.
- ROM failed** - The GPS 155XL has detected a failure in its permanent memory. If this message occurs, the unit is unusable and should be taken to an authorized GARMIN service center.
- Route is empty** - An attempt was made to activate an empty route.
- Route is full** - An attempt has been made to add more than 31 waypoints to a route. The GPS 155XL will not allow more than 31 waypoints per route.
- Route truncated** - The route was truncated because not enough room existed to insert a SID, STAR or approach.



- Route wpt deleted** - One or more route waypoints were deleted while receiving data from the optional PC Interface Kit.
- Route wpt locked** - At least one route waypoint is locked because the waypoint has been removed from the Jeppesen NavData®, the data card is missing, or the data card has failed.
- Route wpt moved** - One or more route waypoints were moved at least 0.33 arc minutes due to a database change.
- RTCM input fail** - The DGPS data signal was being received but has now been lost. Check wiring.
- SID deleted** - The SID was deleted from the route because of insufficient space in the route.
- STAR deleted** - The STAR was deleted from the route because of insufficient space in the route.
- Searching the sky** - The GPS 155XL is in the search-the-sky mode. Allow the unit to complete data collection before turning it off.
- Select auto seq mode** - The GPS SEQ switch should be set to the 'Auto' position to continue navigation.
- Set course to ____°** - The CDI/HSI should be set to the specified course.
- Start altitude chng** - The altitude change entered on the VNAV Planning page is about to begin.
- Steep turn ahead** - This message appears approximately 90 seconds prior to a turn that requires a bank angle in excess of 25 degrees in order to stay on course. Turn anticipation will not be provided for the turn.
- Stored data lost** - Stored user data, including waypoints, routes and satellite orbital data have been lost due to a low memory battery or inadvertent master reset.
- SUA ahead < 10 min** - The projected course and current speed will take you inside an SUA within the next 10 minutes.

- SUA near & ahead** - Your position is within two nautical miles of an SUA and your current course will take you inside.
- Timer expired** - The approach timer has expired.
- User data RX started** - Data receive operations have started.
- Usr data TX complete** - Data transmit operations are complete.
- VNAV cancelled** - The VNAV function has been cancelled due to a change in the active route.
- WGS 84 datum selectd** - The system map datum was changed to WGS 84 because the selected map datum has been removed from the NavData card, the data card is missing, or the data card has failed.
- Wpt comment locked** - At least one waypoint comment is locked because the waypoint has been removed from the Jeppesen NavData®, the data card is missing, or the data card has failed.
- Wpt exists _____** - You have entered a waypoint name on the AutoStore™ page or user waypoint catalog page that already exists in memory. Enter a waypoint name that does not exist.
- Wpt memory full** - The waypoint memory is full. You should delete unused waypoints to make room for new waypoints.



**APPENDIX
D**

**MESSAGES &
ABBREVIATIONS**

This section of Appendix D provides a complete list of GPS 155XL abbreviations and their meanings.

ALT-	Altitude	DEG-	Degrees
APP-	Approach	DEP-	Departure
APR-	Approach	DIS-	Distance To Waypoint
APT-	Airport Waypoint	DME -	Distance Measuring Equipment
ARTCC-	Air Route Traffic Control Center	DOP-	Dilution of Precision
ARV-	Arrival	DTK-	Desired Track
ATF-	Aerodrome Traffic Frequency	ELEV-	Elevation
ATS-	Automatic Terminal Information Service (ATIS)	ENDUR-	Endurance
AVGS-	Aviation Gas	EPE-	Estimated Position Error
AZM-	Azimuth (bearing)	ESA-	Enroute Safe Altitude
BRG-	Bearing	ETA-	Estimated Time of Arrival
CAS-	Calibrated Airspeed	ETE-	Estimated Time Enroute
CDI-	Course Deviation Indicator	FIR-	Flight Information Region
CL B-	Class B	FLOW-	Fuel Flow Rate
CL C-	Class C	FOB-	Fuel On Board
CLR-	Clearance Delivery	FPM-	Feet Per Minute
CPA-	Closest Point of Approach	FR-	From
CTA-	ICAO Control Area	FSS-	Flight Service Station
CTAF-	Common Traffic Advisory Frequency	FT-	Feet
CTF-	Common Traffic Advisory Frequency	FT-	Full Time
CTR-	Center (ARTCC)	GL-	Gallons
CTS-	Course To Steer	GND-	Ground
CUM-	Cumulative	GPS-	Global Positioning System
DALT-	Density Altitude	GS-	Ground Speed
		HDG-	Heading
		HG-	Inches of Mercury
		IALT-	Indicated Altitude



**MESSAGES &
ABBREVIATIONS**

**APPENDIX
D**

ILS-	Instrument Landing System	NM-	Nautical Miles
IG-	Imperial Gallons	NP-	Non-Precision
INT-	Intersection Waypoint	NR-	Nearest
JET A-	Jet Fuel - Type A	OBS-	Omni-directional Bearing Select (Inbound Course Select)
JET B-	Jet Fuel - Type B	OTH-	Other
KH-	Kilometers Per Hour	°C-	Degrees Celsius
KM-	Kilometers	°F-	Degrees Fahrenheit
KT-	Knots	PC-	Pilot Controlled
LB-	Pounds	POSN-	Position
LCL-	Local	PRES-	Barometric Pressure (Altimeter Setting)
LEN-	Length	PROX-	Proximity
LFLOW-	Left Fuel Flow	PRX-	Proximity
LFOB-	Leftover Fuel On Board	PT-	Part Time
LOC-	Localizer	PTX-	Pre-Taxi
LT-	Liters	PWR-	Power
MAG VAR-	Magnetic Variation	RDR-	Radar
MB-	Millibars Of Pressure	REQ-	Required
MF-	Mandatory Frequency	RF-	Reference
MH-	Statute Miles Per Hour	RFLOW-	Right Fuel Flow
MI-	Statute Miles	RNG-	Range
MIN-	Minimum	RNWX-	Runway
MIN -	Minutes	RSTCD-	Restricted
MOA-	Military Operations Area	RSV-	Reserves
MPM-	Meters Per Minute	RTE-	Route
MPS-	Meters Per Second	RX-	Receive Only
MSA-	Minimum Safe Altitude	SAR-	Search And Rescue
MT-	Meters	SEC-	Seconds
MUL-	Multicom		
NDB-	NDB Waypoint		

SEQ-	Sequence	VN-	VNAV or Vertical Navigation
SGL-	Signal	VNAV-	Vertical Navigation
SID-	Standard Instrument Departure	VOR-	VOR Waypoint
SLCT-	Select	WPT-	Waypoint
SRFC-	Surface	WX-	Weather
STAR-	Standard Terminal Arrival Route		
STR-	Steer To		
TACAN-	TACTical Area Navigational Aid		
TAS-	True Airspeed		
TAT -	Total Air Temperature		
TEMP-	Temperature		
TMA-	ICAO Terminal Control Area		
TRK-	Track Angle		
TRN-	Transition		
TRN-	Turn Angle		
TRSA-	Terminal Radar Service Area		
TWR-	Tower		
TX-	Transmit Only		
U-	UTC Time		
UNI-	Unicom		
URA-	User Range Accuracy		
USER-	User Waypoint		
USR-	User Waypoint		
UTC-	Universal Time Coordinated (GMT/ Zulu)		

Appendix E Specifications



PHYSICAL

Size: 6.25"W x 5.8"D x 2"H (159mm x 147mm x 51mm)
Weight: 27.2 ounces (.77 kg)
Rack Size: 6.32"W x 5.64"D x 2"H (161mm x 143mm x 51mm)
Rack Weight: 11 ounces (0.31kg)

POWER

Input: 10-33V DC with power cable (aircraft power)
Optional remote battery pack
115V or 230V AC w/ optional adapter

ENVIRONMENTAL

Temperature: -4° F to 158° F (-20°C to 70°C) Operating
-67°F to 185°F (-55°C to 85°C) Storage

PERFORMANCE

Receiver: 12 channel PhaseTrac12™
Acquisition Time: 45 seconds (typical)
15 seconds (warm start, with ephemeris)
Update Rate: 1 per second, continuously
Accuracy: 15 meters (49ft.) RMS**
Dynamics: 999 knots velocity, 3g acceleration

INTERFACES

ARINC 429, Plotting (NMEA 0183 V2.0), Aviation, PC Interface, Altitude
Serializer, Fuel Sensor, Fuel/Air Data Computer

*** Subject to accuracy degradation to 100m 2DRMS under
the US DOD-imposed Selective Availability Program.*

Turning off 29 scnds
Press any key to
continue navigation

*Whenever the GPS 155XL is connected to the
optional remote battery pack and power from the
master switch is lost, the unit will revert to battery
power. To continue navigation, press any key when
the power down page appears.*

Appendix F

Map Datums

ADINDAN	Ethiopia, Mali, Senegal, Sudan	DOS 1968	Gizo Island (New Georgia Islands)
AFGOOYE	Somalia	EASTER ISLAND 1967	Easter Island
AIN EL ABD 1970	Bahrain Island, Saudi Arabia	EUROPEAN 1950	Austria, Belgium, Denmark, Finland, France, Germany, Gibraltar, Greece, Italy, Luxembourg, Netherlands, Norway, Portugal, Spain, Sweden, Switzerland
ANNA 1 ASTRO 1965	Cocos Islands		
ARC 1950	Botswana, Lesotho, Malawi, Swaziland, Zaire, Zambia, Zimbabwe	EUROPEAN 1979	Austria, Finland, Netherlands, Norway, Spain, Sweden, Switzerland
	Kenya, Tanzania		
ARC 1960	Ascension Island	FINLAND HAYFORD 1910	Finland
ASCENSION IS 1958	Tern Island	G. SEGARA	Borneo
ASTRO B4 SOROL ATOLL	Iwo Jima Island	GANDAJIKA BASE	Republic of Maldives
ASTRO BEACON "E"	St. Helena Island	GEODETIC DATUM 1949	New Zealand
ASTRO DOS 71/4	Marcus Island	GGRS 87	Greece
ASTRONOMIC STN 1952	Australia, Tasmania Island	GUAM 1963	Guam Island
AUSTRALIAN GEOD 1966	Australia, Tasmania Island	GUX 1 ASTRO	Guadalcanal Island
AUSTRALIAN GEOD 1984	Austria	HERAT NORTH	Afghanistan
AUSTRIA NS	Belgium	HJORSEY 1955	Iceland
BELGIUM 1950	Efate and Erromango Islands	HONG KONG 1963	Hong Kong
BELLEVUE (IGN)	Bermuda Islands	HU-TZU-SHAN	Taiwan
	Colombia	INDIAN BNGLDSH NEPAL	Bangladesh, India, Nepal
BERMUDA 1957	Indonesia	INDIAN MEAN VALUE	India
BOGOTA OBSERVATORY	Antarctica	INDIAN THAILAND VIETN	Thailand, Vietnam
BUKIT RIMPAH	Argentina	INDONESIA 74	Indonesia
CAMP AREA ASTRO	South Africa	IRELAND 1965	Ireland
CAMPO INCHAUSPE	Phoenix Islands	ISTS 073 ASTRO 1969	Diego Garcia
CANTON ASTRO 1966	South Africa	JOHNSTON ISLAND 1961	Johnston Island
CAPE	Florida, Bahama Islands	KANDAWALA	Sri Lanka
CAPE CANAVERAL	Tunisia	KERGUELEN ISLAND	Kerguelen Island
CARTHAGE	Switzerland	KERTAU 1948	West Malaysia, Singapore
CH-1903	Chatham Island (New Zealand)	L.C. 5 ASTRO	Cayman Brac Island
CHATHAM 1971	Paraguay	LIBERIA 1964	Liberia
	Brazil	LUZON MEAN VALUE	Philippines
CHUA ASTRO	Denmark	LUZON MINDANAO IS	Mindanao Island
CORREGO ALEGRE	Sumatra Island (Indonesia)		
DANISH GI 1934			
DJAKARTA (BATAVIA)			

LUZON PHILIPPINES Philippines
(excluding Mindanao Isl.)

MAHE 1971 Mahe Island

MARCO ASTRO Salvage Islands

MASSAWA Eritrea (Ethiopia)

MERCHICH Morocco

MIDWAY ASTRO 1961 Midway Island

MINNA Nigeria

NAD27 ALASKA North American 1927- Alaska

NAD27 BAHAMAS Bahamas (excluding San Salvador Island)

NAD27 CANADA Canada (including Newfoundland Island)

NAD27 CANAL ZONE Canal Zone

NAD27 CARIBBEAN Caribbean (Barbados, Caicos Islands, Cuba, Dom. Rep., Grd. Cayman, Jamaica, Leeward and Turks Islands)

NAD27 CENTRL AMERICA Central America (Belize, Costa Rica, El Salvador, Guatemala, Honduras, Nicaragua)

NAD27 CONUS Mean Value (CONUS)

NAD27 CUBA Cuba

NAD27 GREENLAND Greenland (Hayes Peninsula)

NAD27 MEXICO Mexico

NAD27 SAN SALVADR IS San Salvador Island

NAD83 North American 1983- Alaska, Canada, Central America, CONUS, Mexico

NAHRWAN MASIRAH IS Masirah Island (Oman)

NAHRWAN SAUDI ARABIA Saudi Arabia

NAHRWAN UNITD ARAB E United Arab Emirates

NAPARIMA BWI Trinidad and Tobago

NETHERLAND TRIAG '21 Netherlands

NOU TRIAG FRANCE France

NOU TRIAG LUXEMBOURG Luxembourg

OBSERVATORIO 1966 Corvo and Flores Islands (Azores)

OLD EGYPTIAN Egypt

OLD HAWAIIAN KAUII Kauai

OLD HAWAIIAN MAUI Maui

OLD HAWAIIAN MAUI Mean Value

OLD HAWAIIAN OAHU Oahu

OMAN Oman

ORD SRV GRT BRITAIN England, Isle of Man, Scotland, Shetland Islands, Wales

PICO DE LAS NIEVES Canary Islands

PITCAIRN ASTRO 1967 Pitcairn Island

PORTUGUESE 1973 Portugal

POTSDAM Germany

PROV SO AMERICAN '56 Bolivia, Chile, Colombia, Ecuador, Guyana, Peru, Venezuela

PROV SO CHILEAN 1963 South Chile

PUERTO RICO Puerto Rico & Virgin Isl.

PUERTO NATIONAL Qatar

QORNOQ South Greenland

REUNION Mascarene Island

ROME 1940 Sardinia Island

RT 90 Sweden

SANTO (DOS) Espirito Santo Island

SAO BRAZ Sao Miguel, Santa Maria Islands (Azores)

SAPPER HILL 1943 East Falkland Island

SCHWARZECK Namibia

SOUTH AMERICAN 1969 Argentina, Bolivia, Brazil, Chile, Colombia, Ecuador, Guyana, Paraguay, Peru, Venezuela, Trinidad/Tobago

SOUTH ASIA Singapore

SOUTHEAST BASE Porto Santo and Madeira Islands

SOUTHWEST BASE Faial, Graciosa, Pico, Sao Jorge and Terceira Islands (Azores)

TANANARIVE OBSV 1925 Madagascar

TIMBALAI 1948 Brunei and East Malaysia (Sarawak and Sabah)

TOKYO Japan, Korea, Okinawa

TRISTAN ASTRO 1968 Tristan da Cunha

USER User datum

VITI LEVU 1916 Viti Levu Island/Fiji Islands

WAKE-ENIWETOK 1960 Marshall Islands

WGS 72 World Geodetic System 1972

WGS 84 World Geodetic System 1984

YACARE Uruguay

ZANDERIJ Surinam





APPENDIX
G

**TROUBLE-
SHOOTING**
Q & A

Appendix G Troubleshooting Q & A

The GPS 155XL is a precision navigation instrument that offers a wide array of performance navigation features. The 'Q & A' section is designed to answer some of the common questions regarding the GPS 155XL's capabilities and operation. If you have a problem operating your unit, go through the troubleshooting section and refer to the reference section noted. If your problem is not listed in the Q & A section, use the index to find the appropriate reference in the manual. If you still encounter a problem, please see your authorized dealer or call or fax our customer support staff at 913-397-8200 or 913-397-8282 FAX. GARMIN is dedicated to supporting its products and customers.

What is RAIM, and how does it affect approach operations?

RAIM is an acronym for Receiver Autonomous Integrity Monitoring, a receiver function that performs a consistency check on all tracked satellites. RAIM ensures that the available satellite geometry will allow the receiver to calculate a position within a specified protection limit (2 nm for oceanic and en route, 1 nm for terminal and 0.3 nm for non-precision approaches).

During oceanic, enroute and terminal phases of flight, RAIM will be nearly 100%. Because of the tighter protection limit on approaches, there may be times when RAIM is not available. The GPS 155XL automatically monitors RAIM and will warn you with an alert message (see Appendix D) when it is not available. If RAIM is not available when crossing the FAF, the ACTV annunciator will not illuminate and the pilot must fly the missed approach procedure. The GPS 155XL's RAIM prediction function (see page 29) will also allow you to see whether RAIM will be available for a specified date and time. NOTE: If RAIM is not predicted to be available for the final approach course, the approach will not become active, as indicated by the ACTV annunciator.



Why aren't there any approaches available for my route?

Approaches are only available when the final route waypoint or direct-to destination is an airport (some VOR/VORTAC identifiers are similar to airport identifiers). If a destination airport does not have a GPS approach, the GPS 155XL will display a 'no procedures in database' message. For more on selecting an approach, see page 85.

What happens when I select an approach? Can I store a route with an approach, SID or STAR?

Whenever you load an approach or STAR into the active route, the arrival airport is moved, and a set of approach or arrival waypoints is inserted. If a SID is loaded into the active route, the SID waypoints will be inserted following the departure airport in the active route. Note: these modifications only apply to the active route, and will not affect the corresponding stored route (if you have activated one). Routes can be stored with an approach, SID or STAR. Keep in mind that the active route is erased when the unit is turned off and overwritten when another route is activated.

When storing routes with an approach, SID or STAR, the GPS will use the waypoint information from the current database to define the waypoints. If the database is changed or updated, the GPS 155XL will automatically update the information if the procedure name has not changed. If an approach, SID or STAR procedure is no longer available, the route will become locked until the procedure is deleted from the route or the correct database is installed. For information on loading an approach, SID or STAR, see pages 74-91. See page 65 for instructions on saving and copying routes.

Can I file slant Romeo 'R' using my GPS?

Yes, you may file your flight plan as /R if your GPS 155XL is a certified A1 or A2 installation. If you are flying enroute, you may fly /R with an expired database **only** after you have verified all route waypoints. Non-precision approaches **may not** be flown with an expired database. See your approved Airplane Flight Manual Supplement for more information.

What does the GPS APR switch do? What is ‘arming’ an approach?

The GPS APR switch must be set to the ARM position for an approach to enter the active phase. It may be left in the ARM position to simplify approach operation. Its main function is to provide the pilot with a quick method of deactivating the approach and returning the CDI scale to the 1 nm scale in the event of a missed approach. For more on the GPS APR switch and arming approaches, see pages 74-75.

What does the GPS SEQ switch do and when do I use it?

The GPS SEQ switch is used to select manual or automatic waypoint sequencing of waypoints. Setting the GPS SEQ switch to the HOLD position holds your current ‘active to’ waypoint as your navigation reference and prevents the GPS from sequencing to the next waypoint. When the GPS SEQ switch is set to the AUTO position, automatic waypoint sequencing is selected, and the GPS will automatically select the next waypoint in the route once the aircraft has crossed the present active-to waypoint.

AUTO

Automatic sequencing of waypoints
Change in HSI does not affect CDI deflection
Always navigates ‘TO’ the active waypoint
Must be set to AUTO for approach to go active

HOLD

Manual sequencing- ‘HOLDS’ on selected waypoint
Manually select course to next waypoint from HSI
Will indicate ‘TO’ or ‘FROM’ waypoint
Approach will not go active

The GPS SEQ switch must be set to the HOLD position any time you are deviating from the flight sequence of an approach (e.g., when you are flying radar vectors) or when you must cross the same waypoint twice in succession (e.g., a procedure turn or holding pattern). Whenever the GPS SEQ switch is set to the HOLD position, the GPS 155XL allows you to select the desired course to/from a waypoint using the HSI, much like a VOR, and display a to/from flag for the active-to waypoint. In the AUTO position, the CDI will always display a ‘TO’ indication for the next waypoint once you’ve crossed the active waypoint. Refer to page 88 for an approach example using a HOLD.



When should I switch from HOLD to AUTO, and what happens when I do?

Once you are ready to resume automatic waypoint sequencing, you must set the desired course on your HSI two seconds before changing the GPS SEQ switch to the AUTO position. This allows the the desired course to 'settle' prior to the GPS 155XL using it. Once the GPS SEQ switch is set back to the AUTO position, the GPS 155XL will use the HSI course until you have crossed the active-to waypoint and sequenced to the next route waypoint. See page 76 for more information on the GPS SEQ switch.

Why won't my unit automatically sequence to the next waypoint?

The GPS 155XL will only sequence approach, SID or STAR waypoints when the GPS SEQ switch is in the AUTO position. For automatic sequencing to occur, you must also cross the bisector of the turn you are navigating.

How do I skip a waypoint in an approach, SID or STAR?

The GPS 155XL allows you to manually select any approach, STAR or SID waypoint as your next 'active to' destination. This procedure, called an on-route direct-to, is performed from the active route page by highlighting the desired waypoint and pressing **→**, then **ENT** to approve the selection. The GPS will then provide navigation directly to the selected waypoint, so be sure you have clearance directly to that position. See pages 59 & 72 for more information.

How do I fly the GPS with an autopilot and DG heading bug?

If you do not have an HSI, you should make your course selections on the OBS and the DG heading bug.

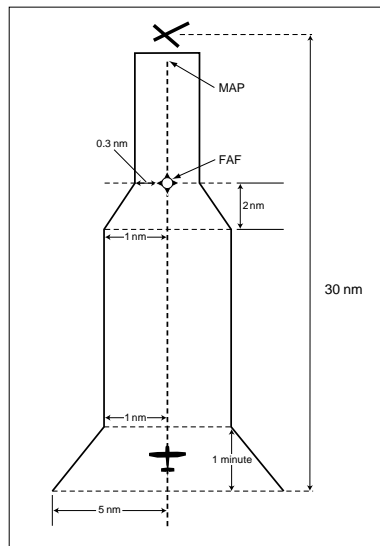

CDI Scale Transition

When does turn anticipation begin, and what bank angle is expected?

The GPS 155XL will smooth adjacent leg transitions based upon a nominal 15° bank angle (with the ability to roll up to 25°) and provide three pilot cues for turn anticipation: 1) The waypoint annunciator will flash 15 seconds before the turn point and glow steadily 2 seconds prior to the turn anticipation point. Begin the turn when the annunciator goes steady. 2) A flashing 'next dtk' prompt will appear on the GPS 155XL's CDI field. Set the HSI to the next dtk value when the waypoint annunciator starts flashing. 3) The To/From indicator on the GPS CDI will flip momentarily to indicate that you have crossed the midpoint of the turn. For more information on turn anticipation, see page 73.

When does the CDI scale change, and what does it change to?

Whenever an approach is selected and armed, the GPS 155XL will begin a smooth CDI scale transition from the 5.0 nm to the 0.3 nm scale 30 nm from the destination airport (see left). The CDI scale will remain at the 0.3 nm scale from the FAF to the MAP during the active approach. If you are in a missed approach situation, and would like to return the CDI to the 1 nm scale, you may deactivate the approach by releasing the GPS APR switch from the ARM position.

Why does my CDI not respond like a VOR when the GPS SEQ switch is set to HOLD?

Unlike a VOR, the CDI scale used on GPS equipment is based on the cross-track distance to the desired course, not an angular relationship to the destination. Therefore, the CDI deflection on the GPS will be consistent regardless of the distance to the destination, and will not become less sensitive when you are further away from the destination. For more information on the CDI scale, see page 99.

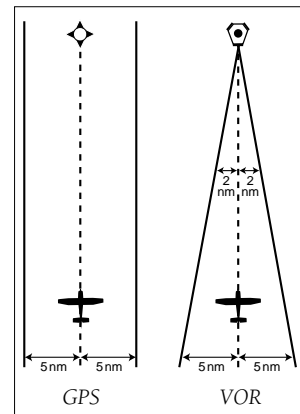



What is the correct missed approach procedure? How do I select the missed approach holding point?

To comply with TSO specifications, the GPS 155XL will not automatically sequence to the missed approach holding point. The first waypoint in the missed approach procedure will be displayed as the next approach waypoint when the pilot performs a direct-to AFTER crossing the MAP, which the pilot may activate when authorized. All published missed approach procedures must be flown before activating navigation to the holding point. To begin the missed approach procedure prior to the MAP, the GPS APR switch must be released from the 'ARM' position to disarm the approach and begin transition of the CDI to the 1.0 nm scale.

To activate navigation to the first missed approach waypoint after crossing the MAP, press **→**, then **ENT**. The GPS 155XL will provide direct navigation to the holding point. If you do not have direct clearance to the holding point, set the GPS SEQ switch to the HOLD position until you have intercepted the inbound course to the holding point. See page 83 for more information on missed approaches.

How do I re-select the same approach or activate a new approach after a missed approach?

After flying all missed approach procedures, you may reactivate the same approach for another attempt from the active route page. Once you have been given clearance for another attempt, select the starting waypoint from the active route list by highlighting the waypoint identifier and pressing **→**, followed by **ENT**. The GPS 155XL will provide direct navigation to the selected waypoint and rejoin the approach in sequence from that point on. If you have disarmed the previous approach, remember to set the GPS APR switch to the 'ARM' position.

To activate a new approach, you must select the new procedure from the approach select page. To view the approach select page, press **RTE** and rotate **○** until the approach select page appears. Press **CRSR** and rotate **○** to highlight the new approach you want to fly. To activate the new approach, press **ENT** and select the IAF, if necessary. See page 84 for more information on reactivating an approach.



**APPENDIX
H**

INDEX

Appendix H Index

A

Abbreviations	118-120
Accessory list	iii
Activating a route	64
Activating a route in reverse	64
Active to & from waypoints	58, 70
Active route page	70
Adding waypoints to a route	63, 71
Airport comments page	33-36, 50
Airport communications page	35-36, 39
Airport runway page	35-36, 40
Airport position page	35-37
Airport identification page	35-36
Airport information	35
Altitude	17
Altitude buffer	105
Approach procedures	36-38
Approach select page	61, 85
Approach timer	27
Approaches	74-91, 124-129
Arrival alarm setting	100
Automatic zoom	97
AutoStore™	47

B

Backlighting	101, 103
Battery saver	101

C

Cautions	ii
CDI	4-5, 11, 99
CDI sensitivity setting	11, 99
Channel 2 I/O	107
Checking GPS coverage	19-21, 29
Checklists	26-27
Clear key	viii
Clock function	28
Closest point of approach (CPA)	65
Communications page	39
Communication frequencies	3, 16, 39
Contrast	102
Controlled airspace	37, 54-57, 105
Course select	13, 60
Copying routes	65
Creating user waypoints	44-47
Cursor key	viii

D

Database	1, 32-33
Data fields	6, 11-13
Date & time	28
Deleting user waypoints	49
Deleting routes	63
Deleting waypoints from routes	63, 72
Density altitude	23
Direct-to, cancelling	59
Direct-to key	viii, 4, 59
Direct-to navigation	58-60

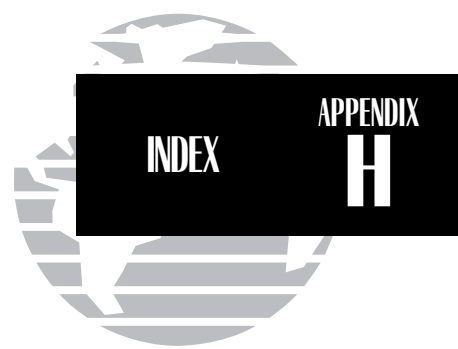

Display contrast 102
Display mode 102
Displaying airports 98
Displaying identifiers 98
Displaying airspace boundaries 99
DOP 19
Downloading data to another GPS155XL 108
Duplicate waypoints 51

E

Editing routes 63, 71
Editing user waypoints 44-46, 49
ENT key viii
Entering waypoints 34, 44-46
EPE 19
ETE 15

F

Foreword i
Frequency restrictions 16, 39
Fuel planning 23-24

G

Going to a nearest airport 53
GPS APR switch 75
GPS planning 29
GPS SEQ switch 76
Ground speed 15
Ground track 15

H

'Hold' on a waypoint 72, 76

I

Inner knob viii
Installation of the GPS 150 XL 110
Intersections 33, 43
I/O Outputs 107, 121

K

Key functions vii, viii
Knob functions vii, viii

L

Locked waypoints 52

M

Magnetic variation 100
Map datums 106, 122-123
Map display 5-6, 14
Map orientation 15, 97
Map page 5-7, 10, 14-15
Map scales 7, 15
Map setup 97-99
Measurement units 104
Messages 2, 26, 30, 52, 54, 113-117
Missed approaches 78, 80, 83-84, 129
MSG key viii, 96

N

NAV/GPS switch 75
NAV Key vii, 3, 10
NAV menu 1 10, 22-27
NAV menu 2 10, 27-31
NAV summary page 3-5, 10-13
NAVCOM page 3, 7, 10, 16-17

NavData cards	32, 108-109	Reversing a route	64
Navigation terms	12	Route catalog page	62
NDBs	33, 42	Route comments	62
NRST key	vii, 8, 53	Route key	vii
Nearest airport	8, 53, 100	Route navigation	58, 70
Nearest SUA	54-57	Route RAIM prediction	67-68
Nearest waypoints	8, 53	Routes	58-73
		Runway page	40
O		Runway surface	40, 100
Offset navigation	66		
Orientation	15	S	
Outer knob	viii	Satellite acquisition	2
		Satellite data page	21
P		Satellite information	20-21
Packing list	iii	Satellite status page	2, 10, 19-21
Parallel track	62, 66	Scheduler	30
Position page	3, 10, 17-18	Search-and-rescue operations	66
Power/intensity knob	vii, 103	Settings submenus	96
Power on (normal)	1	SIDs	36-38, 61-62, 92-93
Power off	9	Simulator mode	111
Procedure turns	76, 79, 82, 126	Special Use Airspace (SUA)	54-57
Procedures page	36-38	Specifications	121
Proximity Waypoints	32, 48	STARs	36-38, 61-62, 94-95
		Storing user data	108
R		SUA alert messages	54, 57
RAIM prediction	29	SUA alert page	55
RAIM protection	124	SUA altitude fields	56
Radar information	37	SUA settings page	57, 98
Receiver status	19-20	Sunrise/sunset planning	31
Reference waypoint	18		
Removal of the GPS 155XL	110	T	
Renaming user waypoints	49	Table of contents	v-vi
Restoring user data	109	Time	28

Trip planning	22
Trip timer	28, 103
Trip timer settings	103
True air speed	23
Turn anticipation	73

U

Unit settings	96-107
Units of measure	104
User data cards	108
User waypoints	33, 44-47, 49

V

Vertical navigation (VNAV)	25-26
VORs	33, 41

W

Warranty	iv
Waypoint categories	33
Waypoint comment list	32, 50
Waypoint comments page	50
Waypoint confirmation page	51
Waypoint entry	34
Waypoint holding	72
Waypoint identification page	34
Waypoint information	32-52
Waypoint key	vii, 32
Waypoint list	49
Waypoint menu	32-33
Waypoint scanning	52
Waypoint sequencing	72-73
Waypoints with comments	50
Winds aloft	25

Z

Zoom in/out keys	vii, 7, 15
----------------------------	------------





Guidance by
GARMIN



© 1999 GARMIN Corporation

GARMIN International, Inc.
1200 East 151st Street Olathe, KS 66062

GARMIN (Europe) LTD
Unit 5, The Quadrangle, Abbey Park Industrial Estate, Romsey, SO51 9AQ, UK

GARMIN (Asia) Corp.
3rd Fl., No. 1, Lane 45, Pao-Hsing Road, Hsin Tien, Taipei, Taiwan R.O.C.

Web Site Address: www.garmin.com

Part No. 190-00067-20 Rev. B