

**Gebrauchsanleitung
Instruction Manual**

Rollei



Rollei Prego da6

This manual is designed to assist you in using this 6 Mega Pixels Digital Camera. Information in this document has been carefully checked for accuracy; however, no guarantee is given to the correctness of the contents. The information in this document is subject to change without notice.

Edition

First Edition, July 2004

Copyright

© Copyright 2004

This document contains proprietary information protected by copyright. All rights are reserved. No part of this manual may be reproduced by any mechanical, electronic or other means, in any form, without prior written permission of the manufacturer.

Federal Communications Commission (FCC) Compliance

This equipment has been tested and found to comply with the limits for a Class B digital device, pursuant to Part 15 of the FCC Rules. These limits are designed to provide reasonable protection against harmful interference in a residential installation. This equipment generates, uses, and can radiate radio frequency energy and, if not installed and used in accordance with the instructions, may cause harmful interference to radio communications. However, there is no guarantee that interference will not occur in a particular installation. If this equipment does cause harmful interference to radio or television reception, which can be determined by turning the equipment off and on, the user is encouraged to try to correct the interference by one or more of the following measures:

- Reorient or relocate the receiving antenna.
- Increase the separation between the equipment and the receiver.
- Connect the equipment to an outlet on a circuit different from that to which the receiver is connected.
- Consult the dealer or an experienced radio/TV technician for help.

Warning: A shielded-type power cord is required in order to meet FCC emission limits and to prevent interference to the nearby radio and television reception. Use only shielded cables to connect I/O devices to this equipment.

You are cautioned that changes or modifications not expressly approved by the party responsible for compliance could void your authority to operate the equipment.

Declaration of Conformity

This device complies with part 15 of the FCC rules. Operation is subject to the following conditions:

- This device may not cause harmful interference.
- This device must accept any interference received, including interference that may cause undesired operation.

Trademark Recognition

Windows, Windows 98, Windows 2000, Windows ME, Windows XP are registered Trademarks of the Microsoft Corporation of the U.S. registered in the USA and other countries. Windows in an abbreviated term referring to the Microsoft Windows Operation System. Adobe is a trademark of Adobe Corporation. Ulead is the trademark of Ulead Systems, Inc.,.

Other companies or product names are trademarks or registered trademarks of the respective companies.

Safety & Handling Precautions

Camera Information

- Do not take apart or attempt to service the camera yourself.
- Do not expose the camera to moisture, or extremes in temperature.
- Let the camera warm up when moving from a cold to a warm temperature.
- Do not touch the lenses of the camera.
- Do not expose the lens to direct sunlight for extended periods.

Battery Information

- Turn off the camera before installing or removing batteries.
 - Use only AA NiMH batteries or CRV3 Lithium battery.
 - Always replace batteries with two new or freshly charged batteries.
 - Do not use batteries that are leaking, corroded, or damaged.
 - Do not attempt to recharge non-rechargeable batteries.
 - When charging rechargeable batteries, use a battery charger specifically designed for the type of battery. If the charger is designed to accommodate multiple battery types, be sure to adjust its settings to match the type of battery you are recharging.
 - Download all pictures and remove the batteries from the camera if you are going to store the camera for extended periods.
-

Contents

Unpack Your Camera	1
Package Contents.....	1
Optional Accessories	1
System Requirements.....	1
Important Notes.....	1
Getting Acquainted with Your Camera	2
Top & Front View.....	2
Rear & Bottom View.....	2
LCD Monitor Display	3
Mode Dial Selector.....	4
LED Status	4
Navigation Switch	5
Shutter Button	5
Getting the Camera Ready	6
Installing Memory SD/MMC Card and Battery	6
Switching the Camera ON/OFF	6
Viewing the Total/Remaining Shots Available	6
Battery Low Alert.....	6
Setting the Language and Date & Time.....	7
Setting Language.....	7
Setting Date & Time.....	7
Capturing Still Images	8
Full Auto Mode	8
Portrait Mode.....	8
Landscape Mode	8
Close-up Mode.....	8
Shooting with Scene Mode	9
Sports Mode.....	9
Night Landscape Mode.....	9
Night Portrait Mode.....	9
Museum Mode	9
Backlight Mode	9
Recording Videos	10
Setting Self-Timer	11
Playback Still Images	12
Playback a Still Image.....	12
Magnifying a Still Image.....	12
Playback Video Images	13
Playback Video Images Frame by Frame.....	13
Playback Images in Slideshow	14
Setting the Slideshow Display Time Interval.....	14

Setting the Single-loop/Endless-loop Slideshow	14
Playback on TV	15
Display Image Properties.....	16
Rotating a Still Image	17
Deleting Images	18
Deleting Single Image in QuickView	18
Deleting Single Image in Playback	18
Deleting All Images	19
Formatting Memory Card or Internal Memory.....	19
Settings Capture Mode	20
Switching LCD Off between Shots.....	20
Setting LCD Off When Camera Power On	20
Setting Flash Mode	21
Setting Drive Mode	21
Setting Auto Focus (AF) Selection.....	22
Setting Image Resolution.....	22
Setting Image Quality.....	23
Setting Exposure Compensation	23
Setting White Balance.....	23
ISO Speed	24
Setting Auto-Exposure (AE) Metering	24
Setting Sharpness	24
Setting Color Mode	25
Setting DPOF Print	26
Setting DPOF for Printing a Single Image	26
Setting DPOF for Printing All Images in the Memory	26
Setting Protect Image	27
Move Images from Internal Memory to Card	28
Camera Setup.....	29
Factory Default Settings.....	29
Reset Camera Settings.....	30
Setting Digital Zoom.....	30
Setting Camera Sound Volume.....	31
Setting Image Storage	31
Setting Date Stamp	32
Setting Customize.....	33
Software Installation	34
Installation Software/Hardware Driver	34
Automatic Installation	34
Custom Installation	35
Downloading & Transferring Files to Computer	35
How to download Pictures via Ulead Photo Explorer	36
Troubleshooting	37
Specification	38

Unpack Your Camera

Package Contents

1. Digital Camera
2. Wrist Strap
3. USB Cable
4. AV Cable
5. 2 AA Ni-MH Batteries
6. Software CD containing
 - Camera Driver for Windows 98SE
 - Ulead Photo Explorer
 - Ulead Video Studio
 - Adobe Acrobat Reader
 - Owner's Manual (PDF)
7. Quick Start Guide

Optional Accessories

- Tripod
- AC adapter (3V, 2.5 A, center positive)
- SD/MMC card
- Charger

System Requirements

For optimal use of this camera, your computer should have the following minimum system requirements:

- PC Pentium processor
- Microsoft Windows XP/2000/ME/98SE
- 128 MB RAM
- 90 MB of hard drive space
- USB interface
- CD-ROM drive
- VGA monitor

Important Notes:

- Due to varying compatibility among USB HUBS, compatibility is not guaranteed.
- Due to varying compatibility among USB interface cards, compatibility is not guaranteed.

Getting Acquainted with Your Camera

Congratulations on your purchase of this digital camera. Your digital camera has been designed with a 6 Mega Pixels CCD image sensor and 3X optical zoom lens, which allow you to quickly and easily take high quality digital pictures.



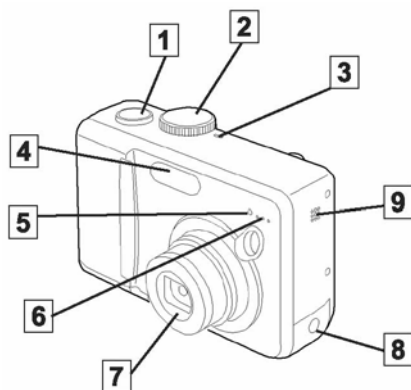





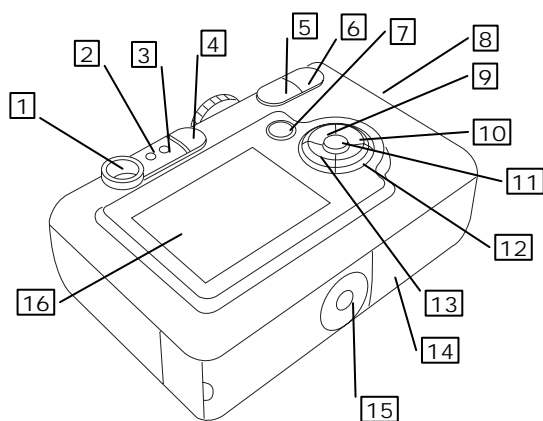

Top & Front View



1. Shutter button
2. Mode Dial Switch
3. Power LED
4. Flash
5. Self-timer LED
6. Microphone
7. 3X Optical Zoom Lens
8. DC-in Jack, USB/AV connector compartment
9. Speaker

Rear & Bottom View



1. Viewfinder
2. AF LED (green)
3. Flash LED (red)
4. Flash/Delete button ()
5. Zoom-out button ( , )
6. Zoom-in button ( , )
7. Playback button ()
8. Strap eyelet
9. Up-arrow/Self-timer button ()
10. Right-arrow button ()
11. <Menu/OK> button (OK)
12. Down-arrow/Burst button ()
13. Left-arrow/LCD on-off button ()
14. Battery/Memory card compartment
15. Tripod socket
16. LCD Monitor

LCD Monitor Display

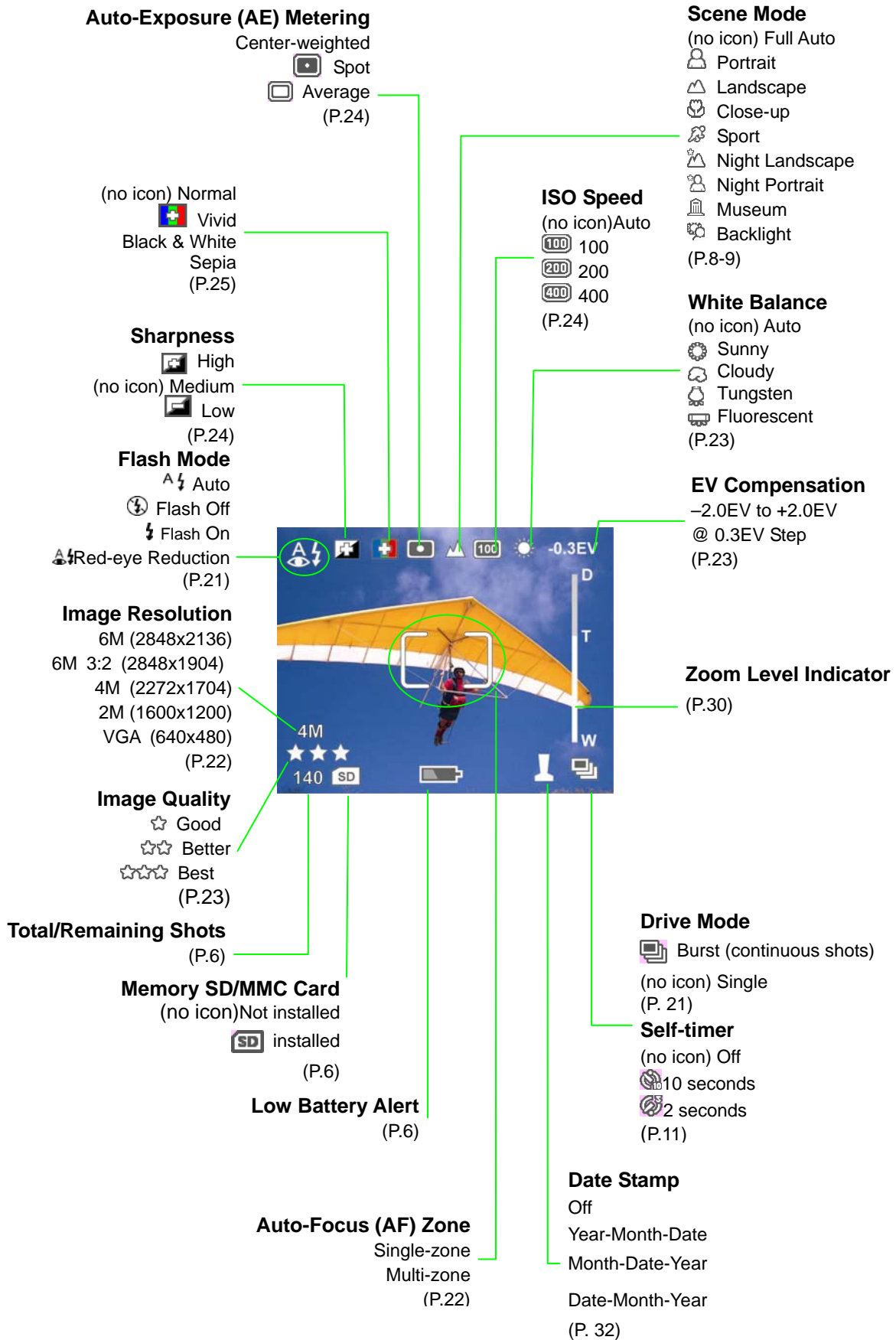

Mode Dial Selector

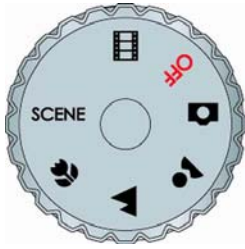

Icon	Mode	Function
OFF	Off	Camera power off.
	Full Auto	Capture - Full Auto Mode
	Movie	Capture - Movie mode.
	Portrait	Capture - Portrait mode.
	Landscape	Capture - Landscape mode.
	Close-up	Capture - Macro mode.
SCENE	Scene	More Scene modes available for Capture.

(Refer to P. 8 to 9 for details.)

LED Status

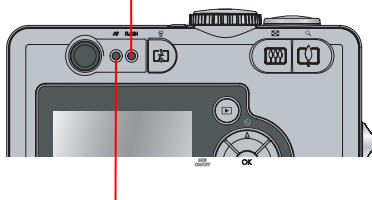
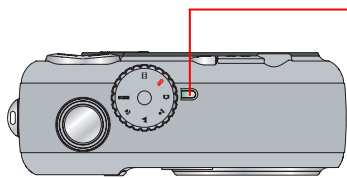

LED Type	LED Status	Camera Status
Power LED	Off	Power OFF
	Green Steady	Ready for taking pictures
	Green Blinking	Busy mode when camera in -Processing of image reproduction -PC link
	Red Steady	Camera in error modes: -Card/memory full -Card corrupted -Card protected
	Red Blinking	Insufficient battery
Self-timer LED	Off	Self-timer off.
	Red Steady	Video is recording.
	Red Blinking Slow	Self-timer countdown for the first 8 seconds
	Red Blinking Fast	Self-timer countdown for the last 2 seconds
Flash LED	Off	Flash off
	Red Steady	Flash will fire at next shooting.
	Red Blinking	Flash is charging.
AF LED	Off	Shutter at released position
	Green Steady	Auto Focus is achieved while shutter is pressed down halfway (S1 position).
	Green Blinking	Auto Focus is in progress while shutter is pressed down halfway (S1 position).

Navigation Switch

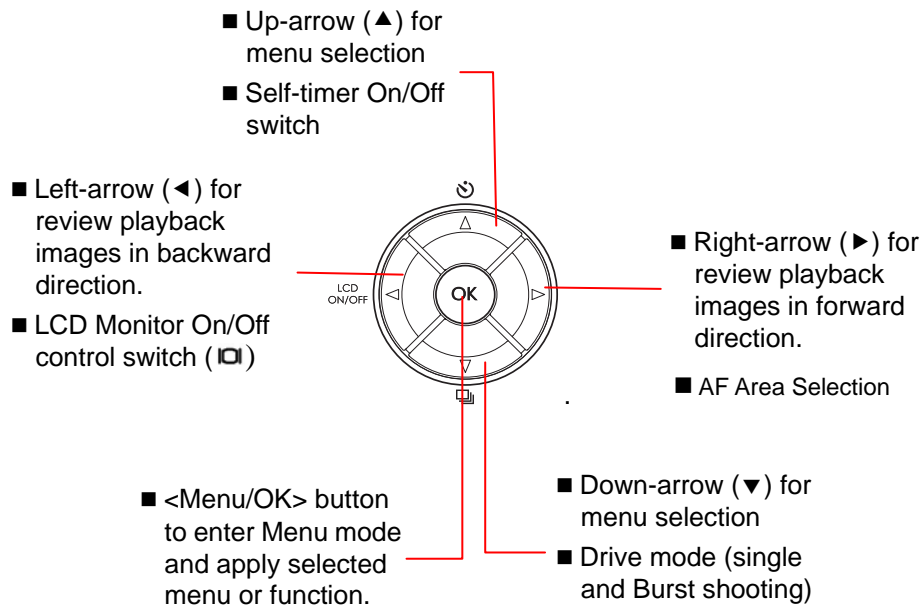

Shutter Button

- S0** Released position. Shutter is OFF.
- S1** Focus position. Shutter is pressed down halfway and the AF Green LED blinks while camera is doing Auto Focus (AF), Auto Exposure (AE) and Auto White Balance (AWB).
- S2** Capture position. When the AF Green LED ceases to blink, Shutter is pressed all the way down to capture the image.

- S0** Released position
- S1** Pressed halfway
- S2** Pressed all the way down

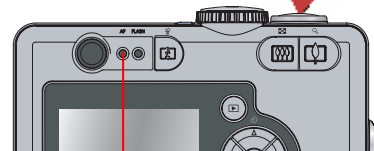

Auto Focus (AF) Green LED

Getting the Camera Ready

Installing Memory SD/MMC Card and Battery

- 1 Open the battery/memory card cover and slide the memory SD/MMC card (optional) and two new AA Ni-MH batteries or one CRV3 Lithium battery into compartments.
- 2 Close cover securely until it clicks shut.
- 3 Battery level is shown in 3 stages, Full Battery, Low Battery, and Insufficient Battery. Only Low Battery and Insufficient Battery are indicated on LCD screen.

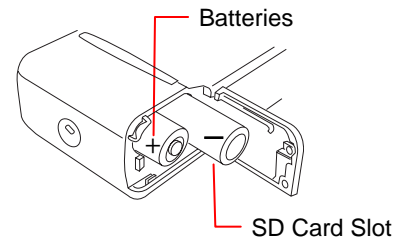

NOTE

- Be sure the correct orientations of the batteries and SD/MMC card.
- Remove batteries if camera is not used.
- Danger of explosion if battery is incorrectly replaced. Replace only with the same or equivalent type recommended by the manufacturer. Dispose of used batteries properly.

Switching the Camera ON/OFF

- 1 To switch ON, turn Mode Dial from OFF to the desired shooting mode (). Use "Full Auto" () mode if it's your first time to use. Green power LED lights up when power is ON.
- 2 To switch OFF, simply return the Mode Dial back to "Off" position and the Green Power LED lights OFF.

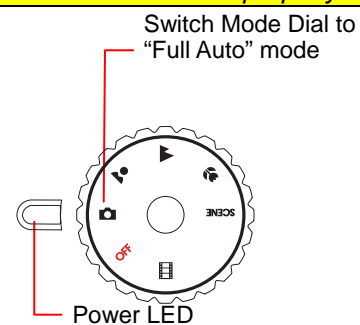

Note: The camera will power off automatically if camera inactivity for 8 minutes from the LCD time out.

Viewing the Total/Remaining Shots Available

- 1 Turn ON the camera.
- 2 The total/remaining shots number of internal memory is displayed. If a memory SD/MMC card is installed, the LCD will display the total/remaining shots number of the SD/MMC card.

Note: The displayed remaining shots number will vary according to the set of image resolution and quality.

Battery Low Alert

When the battery becomes low, a low battery icon will display and the red Power LED will blink. Replace batteries when power is low.



Setting the Language and Date & Time

The Language selection will display the first time you power on the camera. After selecting the language, the Date & Time Menu will bring up automatically.

Setting Language

- 1 Press Up or Down arrow (▲▼) button to select the desired language.
- 2 Press <Menu/OK> button to setup.

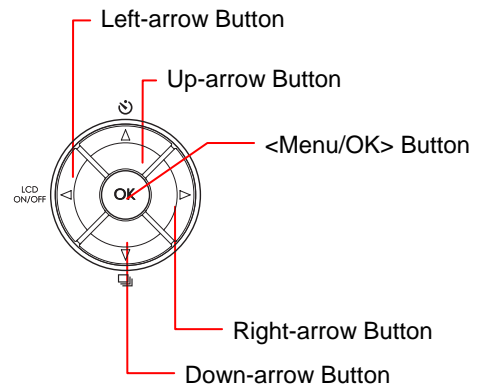

Setting Date & Time

- 1 Press Left-arrow (◀) and Right-arrow (▶) to select the "Year", "Month", "Date", "Hour" and "Min.".



- 2 Use Up-arrow (▲) and Down-arrow (▼) to change the values.
- 3 Press <Menu/OK> button to apply the settings.

Capturing Still Images

Full Auto Mode

Recommend to use Full Auto Mode for beginners. While in Full Auto mode, you just shoot on your subject.

Portrait Mode

Use this mode to take a distinctive portrait with a blurred background.







Landscape Mode

Use this mode to take a scenic photograph.

Close-up Mode

Use this mode to take a close-up picture of small objects.

The focus range is 15cm to 50 cm.

- 1 Switch Mode Dial to Full Auto, Portrait, Landscape, or Close-up mode (   ).
- 2 Frame the subject on the LCD monitor or look through the viewfinder. Press the Zoom-in () or Zoom-out () to adjust the focus.
- 3 Press Shutter button halfway to get the best focus.
- 4 When the Green AF LED ceases to blink, press Shutter button down fully to capture the image.
- 5 The LCD Monitor will have a QuickView of the just captured image for about 3 seconds.

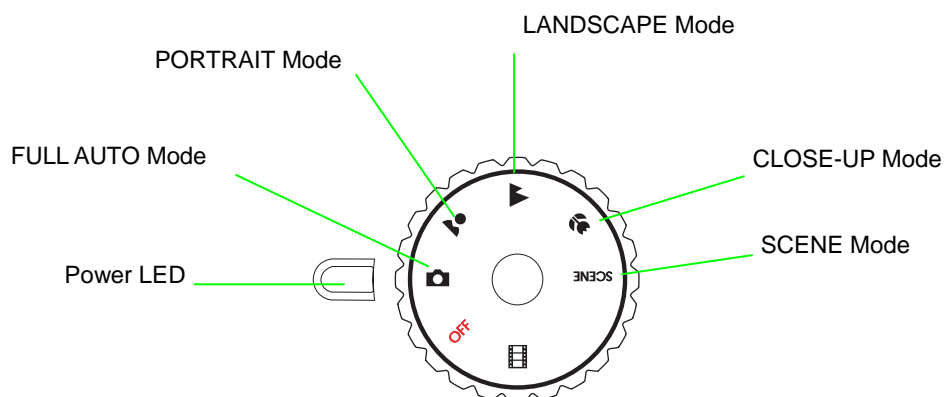
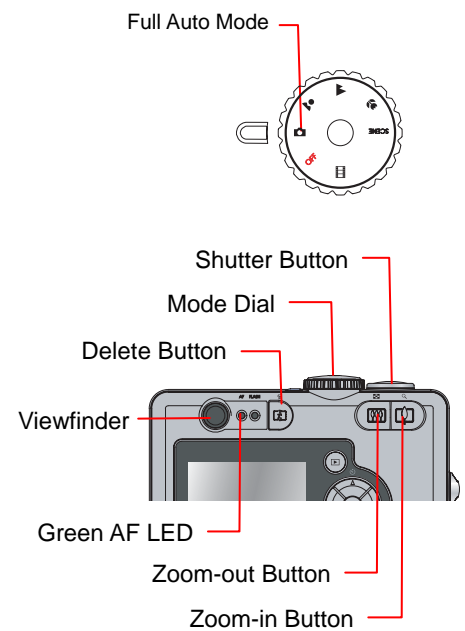

Shooting with Scene Modes

In addition to Full Auto, Portrait, Landscape, Movie, Close-up mode on the Mode Dial, the camera offers more programmed scenes - Sports, Night Landscape, Night Portrait, Museum, Backlight, for pre-setting.

Sports Mode <🏃>

Use this mode to take a frozen picture of fast moving objects.

Note : Recommend to use Burst during Sports. In Burst mode, self-timer, flash and QuickView cannot function.

Night Landscape Mode <🌃>

Use this mode to take landscape scenery at night or twilight.

Note: This mode sets the camera with Flash Off and at a lower shutter speed. Tripod is recommended to use.

Night Portrait Mode <👤>

Use this mode to take portrait pictures at night, twilight or indoors with a blurred background.

Note: This mode sets the camera with Red-eye deduction and at a slower shutter speed. Tripod is recommended to use.

Museum Mode <🏛️>

Use this mode to take indoor scene.

Note: This mode sets the camera with Flash Off and at a lower shutter speed. Tripod is recommended to use.

Backlight Mode <👤>

Use this mode to take pictures of subjects with strong backlight

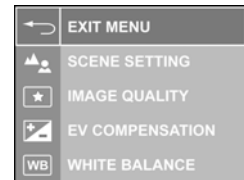
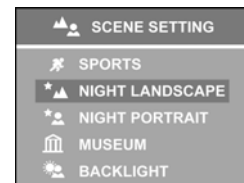
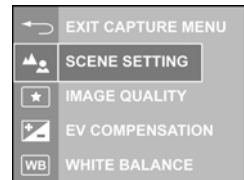

Note : When taking silhouetted scenes, please turn the Flash Off.

- 1 Switch Mode Dial to SCENE mode.
- 2 Press <Menu/OK> button to enter the Capture Menu mode. Press Down-arrow (▼) button to select “SCENE SETTING” and press<Menu/OK> button again.
- 3 Press Up-arrow (▲) or Down-arrow (▼) button to select the desired SCENE modes, Sports<🏃>, Night Landscape <🌃>, Night Portrait<👤>, Museum <🏛️>or Backlight<👤>.
- 4 Press <Menu/OK> button to return.
- 5 Press Up-arrow (▲) button to select “EXIT MENU” and press <Menu/OK> button to return to LiveView mode.
- 6 The selected Scene mode icon is displayed at the center-top of the LCD Monitor.



Recording Videos

Video mode allows you to shoot movie scenario.

- 1 Switch the Mode Dial to Video Mode  The Video icon  is displayed on the LCD Monitor.

Note : Flash and Digital Zoom cease to function in video mode. The Optical Zoom is also disabled during video recording.

- 2 Frame the subject on the LCD Monitor.



- 3 Press Shutter button to start video recording. The message "REC" will display on the LCD Monitor. Press the Shutter button to stop recording.

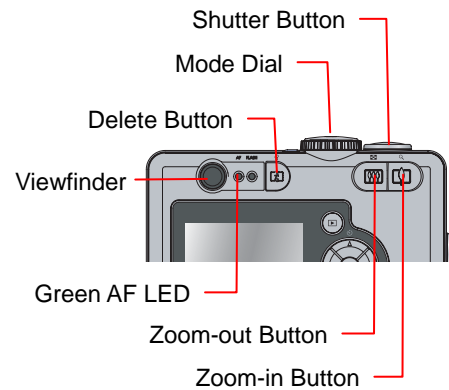
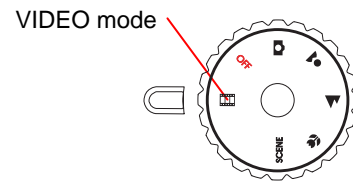

Setting Self-Timer

This camera provides 10 seconds (🕒₁₀), 2 seconds (🕒₂) and Off (no icon) for the self-timer.

- 1 In Capture mode, press Up-arrow/Self-timer button (▲ 🕒).
The Self-timer screen will display on the LCD monitor for 3 seconds. To change the Self-timer mode, repeatedly press the Self-timer button (🕒).

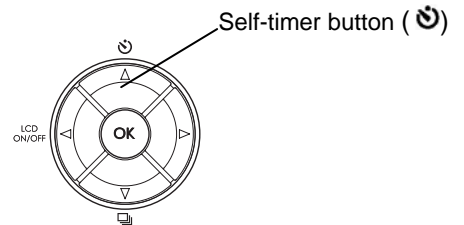

The Self-timer icon (🕒₁₀) or (🕒₂) will display on the LCD monitor.



- 2 Press the Shutter button.
- 3 Camera starts to countdown with a beep.



- 4 After image is captured, the Self-timer will turn off automatically.

Note: When the Burst mode is selected, the Self-timer will be turned off automatically.

Playback Still Images

Playback a Still Image

- 1 Turn on camera and press Playback (▶) button.
- 2 Press Left-arrow (◀) or Right-arrow (▶) button to navigate images. The sequence of the image viewed and the number of total stored images are display on the right-bottom corner of LCD display.



- 3 Press Playback (▶) button again to return Capture mode.

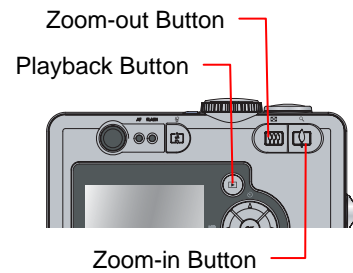

Magnifying a Still Image

The playback image can be magnified up to 6 times of its original size at an increment of 0.5 per step.

- 1 Follow Step 1-2 of "Playback a Still Image".
- 2 Press Zoom-In (⏏) or Zoom-Out (⏏) button to magnify or shrink the image. You may press and hold the Zoom-In (⏏) or Zoom-Out (⏏) button to swiftly magnify image up to its maximum size or back to its original size.
- 3 Press Playback (▶) button, camera will back to the original size. Press Playback (▶) button again to return Capture mode.



Playback Video Images

When you browse video images, the video will playback automatically.

- 1 Turn on camera and press Playback (▶) button.
- 2 Press Left-arrow (◀) or Right-arrow (▶) to select a video image. The video will start to playback.
- 3 Press Playback (▶) button to return Capture mode.



Total recording time of this video clip.

Playback Video Images Frame by Frame

When you playback a video clip, the video can be viewed in still mode by frame or by second.

- 1 Follow Step 1-2 of "Playback Video Images".
- 2 During video playback, press <Menu/OK> button to enter Video Still mode. LCD display stops at the current image. Press Left/Right arrow (◀▶) button to playback the video image frame by frame in backward or forward. Press Up/Down arrow (▲▼) button to skip the current frame and start to playback the beginning of previous/next second.
- 3 Press <Menu/OK> button to continue the normal video playback.

Playback Images in Slideshow

- 1 Follow Step 1-2 of "Playback a Still Image".
- 2 Press <Menu/OK> button to review Menu.
- 3 Press the Up-arrow (▲) or Down-arrow (▼) button to select "SLIDESHOW"
- 4 Press <Menu/OK> button to enter submenu.
- 5 Select "START" and press <Menu/OK> button. The slideshow will start from the 1st image in the current image storage.
- 6 The slideshow will stop after the last image is displayed if the Slideshow Loop setting is Off or whenever you press the <Menu/OK> button.



Setting the Slideshow Display Time Interval

- 1 Follow Step 1-4 of "Playback Images in Slideshow".
- 2 Select "INTERVAL". Press <Menu/OK> button.
- 3 Press Up-arrow (▲) or Down-arrow (▼) button to adjust the interval from 5 to 30 seconds.
- 4 Press <Menu/OK> button to set up. Press Up-arrow (▲) button to select "START" to playback the slideshow.



Setting the Single-loop/Endless-loop Slideshow

- 1 Follow Step 1- 4 of "Playback Images in Slideshow".
- 2 Select "LOOP". Press <Menu/OK> button.
- 3 Press the Up-arrow (▲) or Down-arrow (▼) button to set "ON" (Endless-loop) or "OFF" (Single-loop).
- 4 Press <Menu/OK> button again to start the slideshow.

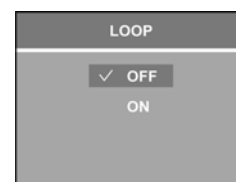

Playback on TV

- 1 Turn On camera. Press <Menu/OK> button.
- 2 Press the Up-arrow (▲) or Down-arrow (▼) button to select “SETUP” and press<Menu/OK> button.

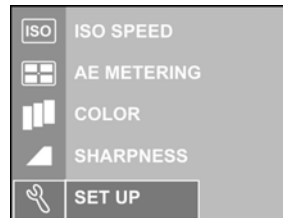

- 3 Press Up/Down arrow (▲/▼) button to select “VIDEO OUT” and press<Menu/OK> button.

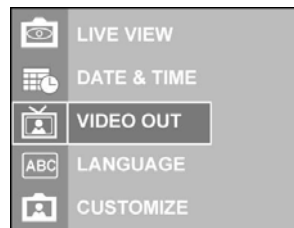

- 4 Set your video system format (NTSC or PAL).

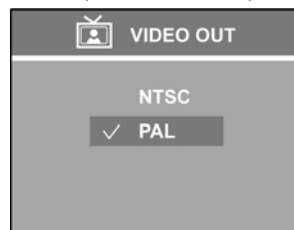

Note: For USA, Canada and Asian countries, please set to “NTSC”. For European countries and China, please set to “PAL”.

- 5 Connect the provided AV cable to the camera and the TV Video IN terminal.

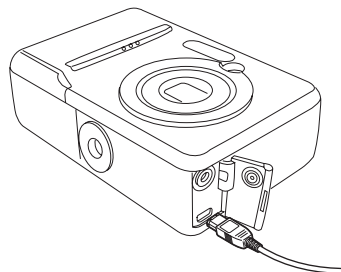

- 6 Turn the TV on and set the TV input switch to Video In. Turn the Camera ON.
- 7 The image will display on the TV screen.

Display Image Properties

This camera provides image property information, which includes:

- Image Quality & Resolution
- Image Filename
- Date & Time
- ISO Speed
- Shutter Speed
- Aperture Number
- Scene Mode
- EV Compensation
- Color Mode (if Vivid is applied)
- Sharpness

Playback Button

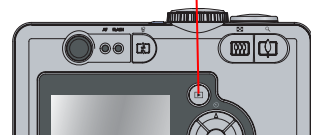

- 1 Turn On camera. Press Playback (▶) button.
- 2 Press <Menu/OK> button and press down arrow (▼) button to select "PICTURE INFO".



- 3 Press <Menu/OK> button to display.



- 4 Press Left-arrow (◀) or Right-arrow (▶) to navigate images.
- 5 Press Playback (▶) button to return Review mode. Or, press <Menu/OK> button and select "EXIT MENU". Press <Menu/OK> button again to go back Review mode. Press Playback (▶) button again to return Capture mode.

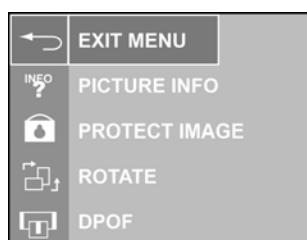

Rotating a Still Image

- 1 Turn On the camera. Press Playback (▶) button.
- 2 Press <Menu/OK>button. Press Left/Right button (◀▶) to select the image to be rotated.
- 3 Press the Up-arrow (▲) or Down-arrow (▼) button to select "ROTATE".



- 4 Press Right-arrow (▶), Left-arrow (◀), Down-arrow (▼) or Up-arrow (▲) button to rotate the image in 90° , 270° , 180° and original direction.
- 5 Press <Menu/OK> button to setup the rotation.



Deleting Images

Deleting Single Image in QuickView

- 1 After a picture is taken, the image will have a QuickView. While the image is on display, press the Delete (🗑️) button.



- 2 Press Down-arrow (▼) button to select “YES” and press <Menu/OK> button to delete image. Press “NO” if you want to keep the image.

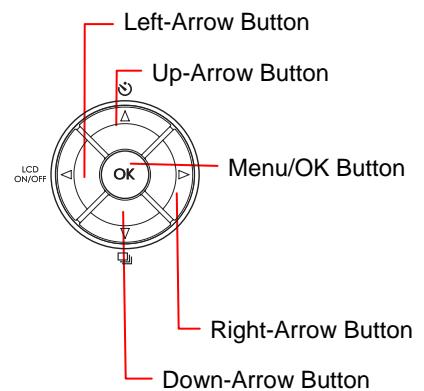
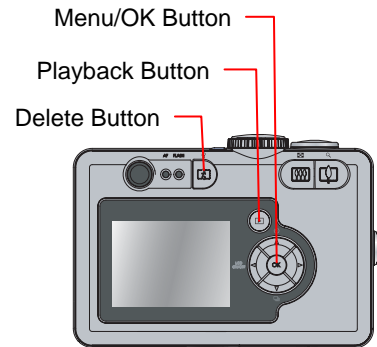

Deleting Single Image in Playback

- 1 Press Playback (▶️) button.
- 2 Press Left-arrow (◀️) or Right-arrow (▶️) to select the image to be deleted.
- 3 Press DELETE (🗑️) button and a delete confirmation screen will pop out. Press Down-arrow (▼) button to select “YES” and press <Menu/OK> button to delete.
- 4 Or, you may press <Menu/OK> button to select “DELETE” by pressing Up/Down arrow (▲/▼) button. Press <Menu/OK> button again to enter submenu.
- 5 Press Down-arrow (▼) button to select “THIS IMAGE”. Press <Menu/OK> button to delete. Press “EXIT” if you want to exit the Delete submenu. A “Deleting...” screen will pop out during the image being deleted.

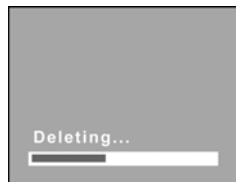

- 6 Press Playback (▶️) button to return. Or, press <Menu/OK> button and select “EXIT MENU”. Press <Menu/OK> button again. Press Playback (▶️) button again to return Capture mode.

Deleting All Images

- 1 Press Playback (▶) button.
- 2 Press <Menu/OK> button. Press Down-arrow (▼) or Up-arrow (▲) to select “DELETE” and press <Menu/OK> button to enter the DELETE submenu.
- 3 Select “All IMAGES”.
- 4 Press the <Menu/OK> button. Press UP/Down arrow (▲/▼) button to select “YES” to delete all images. While images being deleted, “Deleting.....” Will be on the LCD display.



Formatting Memory Card or Internal Memory

- 1 Follow Step 1-2 of “Deleting All Images”.
- 2 Select “FORMAT INTERNAL” or “FORMAT CARD” (if a memory card is installed).



- 3 Press <Menu/OK> button.
- 4 Press Down-arrow (▼) or Up-arrow (▲) to select “YES” and press <Menu/OK> button to format internal memory or SD/MMC card.

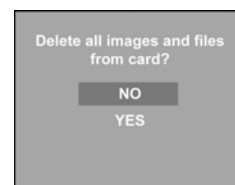
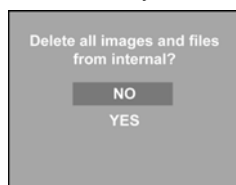



- 5 While images and files being formatted, “Formatting...” will pop out on LCD display.



Settings Capture Mode



Switching LCD Off between Shots

- 1 In Capture mode, press the LCD on/off button () to switch OFF the LCD monitor.
- 2 To switch On the LCD, press the LCD on/off button () again.

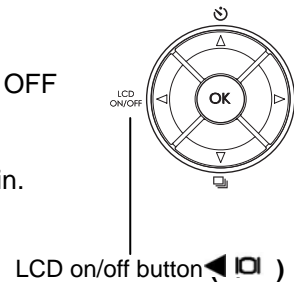
Note: The LCD will turn off automatically if camera inactivity for 1 minute.



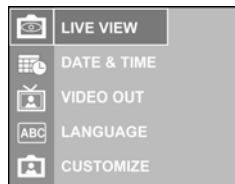
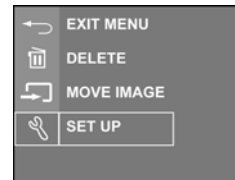

Setting LCD Off When Camera Power On

- 1 Press <Menu/OK> button.
- 2 Select "SETUP" Menu by pressing Down-arrow () or Up-arrow () button.
- 3 Press <Menu/OK> button.
- 4 Select "LIVEVIEW".



- 5 Press <Menu/OK> button.
- 6 Set "OFF" and press <Menu/OK> button to apply the setting.



- 7 Select "EXIT MENU" by pressing UP/Down arrow ( / ) button. Press <Menu/OK> button.



- 8 Select "EXIT MENU" by pressing Down arrow () button. Press <Menu/OK> button to return Capture mode.



Setting Flash Mode

The camera offers four Flash modes - **Auto** (A ⚡), **Flash Off** (⊗), **Flash On** (⚡) and **Red-eye Reduction** (A ⚡).

To select the Flash mode, repeatedly press the Flash (⚡) button under Capture mode. The following diagram shows the Flash mode cycle:

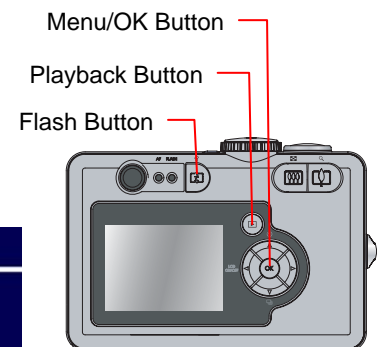

Setting Drive Mode

The camera provides Burst Mode to capture the image with five shots when the Shutter button is pressed.

Single Frame Mode: Only one shot is taken.

Burst Mode (⌂): Two shots are taken when you press the Shutter button. When Burst mode is set, the Self-timer and the Flash are disabled. Burst mode is cleared at power off.

- 1 Press Burst mode button (⌂) in Capture mode, the LCD will display the Burst mode for 4 seconds.
- 2 Press Burst mode button (⌂) to return to Single Frame mode.

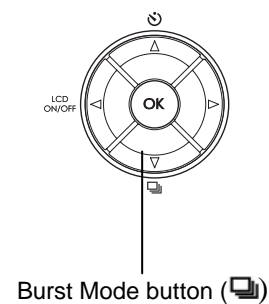
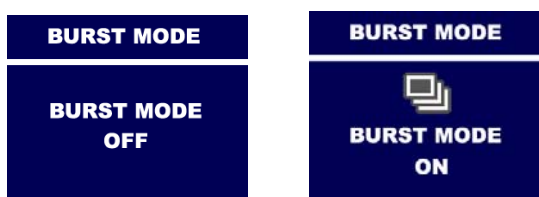

Setting Auto Focus (AF) Area Selection

This camera provides Single-zone Auto Focus (AF) and multi-zone AF area function. In LiveView mode, repeatedly press the Right arrow (▶) button

to select the AF Bracket from Center AF → Right AF

→ Left AF → Multi-zone AF as below diagram.

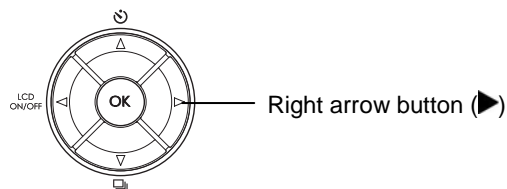

Note:

- When Digital Zoom function is enabled, the AF Area Selection cannot function.
- The AF Bracket will be in red color if AF cannot function.

Setting Image Resolution

This camera provides 5 kinds of image resolution for settings – 6M (2848 x 2136 pixels), 6M 3:2 (2848 x 1904 pixels), 4M (2272 x 1704 pixels), 2M (1600 x 1200) and VGA (640 x 480 pixels).

1 Press <Menu/OK> button.

2 Press Down-arrow (▼) or Up-arrow (▲) to select “RESOLUTION”.



3 Press <Menu/OK> button to enter the submenu.

4 Press Up-arrow (▲) or Down-arrow (▼) button to select.



5 Press <Menu/OK> button to apply the setting.

Setting Image Quality

This camera can set up the compression ratio of JPG image. The best Image Quality is selected, the less image ratio is compressed but more image capacity will be occupied the memory. Three optional modes-- **Best** (★ ★ ★), **Better** (★ ★) and **Good** (★) are offered.

- 1 Press the <Menu/OK> button.
- 2 Press UP/Down arrow (▲/▼) button to select "IMAGE QUALITY". Press <Menu/OK> button.
- 3 Press UP/Down arrow (▲/▼) button to setup the quality mode. Press the <Menu/OK> button.

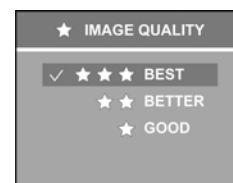

Setting Exposure Compensation

- 1 Press the <Menu/OK> button.
- 2 Press Up-arrow (▲) or Down-arrow (▼) button to select "EV COMPENSATION".
- 3 Press the <Menu/OK> button. Press Up-arrow (▲) or Down-arrow (▼) button to setup the EV value.
- 4 Press <Menu/OK> button to setup.

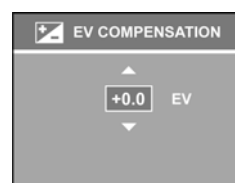
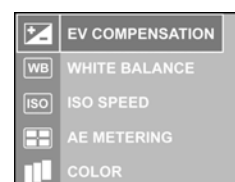

Setting White Balance

This camera provides **Auto** (no icon), **Sunny** (☀), **Cloudy** (☁), **Tungsten** (💡) and **Fluorescent** (💡) for White Balance settings.

- 1 Press <Menu/OK> button.
- 2 Press Up-arrow (▲) or Down-arrow (▼) button to select "WHITE BALANCE".
- 3 Press <Menu/OK> button.
- 4 Press Up-arrow (▲) or Down-arrow (▼) button to select the white balance settings.
- 5 Press <Menu/OK> button to apply the setting

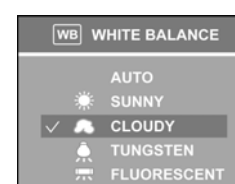
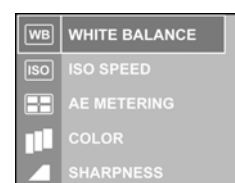

ISO Speed

- 1 Press the <Menu/OK> button.
- 2 Press Up/Down arrow (▲/▼) button to select “ISO SPEED”.
- 3 Press the <Menu/OK> button to enter submenu.
- 4 Select “Auto, ISO100/200/400”.
- 5 Press <Menu/OK> button to setup.

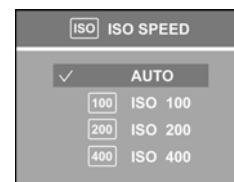
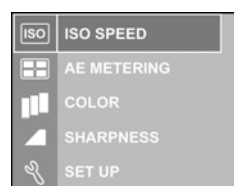

Setting Auto-Exposure (AE) Metering

This camera provides three modes of AE metering- **Average** (☐), **Center-weighted**, **Spot** (●) metering.

- 1 Press <Menu/OK> button.
- 2 Press Up-arrow (▲) or Down-arrow (▼) button to select the “AE METERING”
- 3 Press <Menu/OK> button.
- 4 Press Up-arrow (▲) or Down-arrow (▼) button to select the Metering Mode.
- 5 Press <Menu/OK> button to setup.

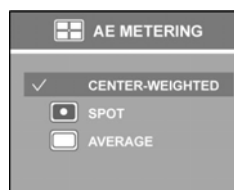

Setting Sharpness

This camera provides 3 levels of image sharpness- **High**, **Medium** and **Low**.

- 1 Press <Menu/OK> button.
- 2 Press Up-arrow (▲) or Down-arrow (▼) button to select “SHARPNESS”.
- 3 Press <Menu/OK> button.
- 4 Select Sharpness level.
- 5 Press <Menu/OK> button to apply the setting.

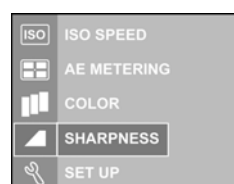

Setting Color Mode

This camera provides 4 levels of color mode- **Normal**, **Vivid** (🇺🇸), **Black & White** and **Sepia**.

- 1 Press <Menu/OK> button.
- 2 Press Up/Down arrow (▲/▼) button to select the “COLOR”.



- 3 Press <Menu/OK> button to enter submenu.
- 4 Set up the Color level.



- 5 Press <Menu/OK> button to apply the setting.

Setting DPOF Print

The DPOF (Digital Printer Order Format) settings allow you to select photo stores on a SD card. It is very convenient when you make a direct-print from a DPOF compatible printer.

Set DPOF for Printing a Single Image

- 1 Press Playback (▶) button.
- 2 Press Left-arrow (◀) or Right-arrow (▶) button to select the image to be printed.
- 3 Press <Menu/OK> button.
- 4 Press Down-arrow (▼) button to highlight “DPOF” and press <Menu/OK> button again to enter Printer Order submenu.
- 5 Press Down-arrow (▼) or Up-arrow (▲) button to highlight “THIS IMAGE” and press <Menu/OK> button display the copy quantity dialog.
- 6 Press Up-arrow (▲) button or Down-arrow (▼) button to setup the copy quantity from 0 to 99.
- 7 Press <Menu/OK> button to apply the DPOF setting.



to



Set DPOF for Printing All Images in the Memory

- 1 Follow Step 1 to 4 of “Set DPOF for Printing a Single Image”.
- 2 Select “ALL IMAGES” and press <Menu/OK> button to display the copy quantity dialog.
- 3 Repeat Step 6-7 of “Set DPOF for Printing a Single Image”.



Note : DPOF is not function in video mode.

Setting Protect Image

To prevent the stored images to be deleted by accident, you may protect the images stored in the memory card or internal memory by this setting.

- 1 Press Playback (▶) button.
- 2 Press Down-arrow (▼) or Up-arrow (▲) button to highlight “PROTECT IMAGE” and press <Menu/OK> button. Press <Menu/OK> button again to cancel the protection.



- 3 A protect icon (🔒) will display on the upper-right corner of LCD display.

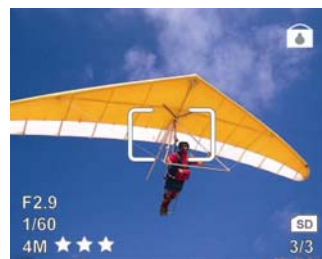

- 4 Press Up-arrow (▲) button to select “EXIT MENU” and press <Menu/OK> button to return Review mode. Press Playback (▶) button to return Capture mode.



Move Images from Internal Memory to Card

The camera has a built-in 16MB internal memory. When a memory card is inserted into the camera, you may move the images from the internal memory into the card.

Note : This feature is only function when the memory card is inserted.

- 1 Press Playback (▶) button.
- 2 Press <Menu/OK> button.
- 3 Press Up/Down (▲/▼) arrow button to select "MOVE IMAGE". Press <Menu/OK> button.



- 4 Select "THIS IMAGE" or "ALL IMAGES" to card and press <Menu/OK> button.



- 5 If "ALL IMAGES" is selected, a confirmation screen will pop out.

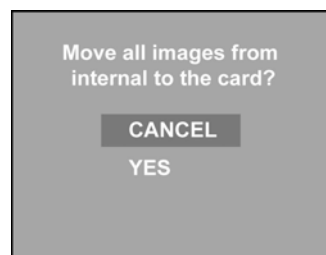

- 6 Select "YES" and press <Menu/OK> button. A "Moving..." will display on LCD screen. If SD/MMC card doesn't have enough memory space, the "First "n" images are moved." will be on LCD display.

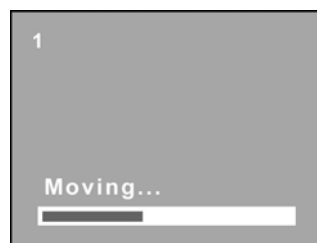

Camera Setup

Factory Default Settings:

Function	Factory Default Setting
Pre-set Scene	Sports
Self-timer	Off
Slide Show Interval	5 Seconds
Slide Show Loop	Off
Live View	On
Flash Mode	Auto
Drive Mode	Single
AF Area Selection	Central
Image Resolution	6M
Image Quality	Best
EV Compensation	0
White Balance	Auto
ISO Speed	Auto
AE Metering	Center-weighted
Sharpness	Medium
Color	Normal
Camera Sound Volume	Low
Digital Zoom	Enable
Date Stamp	Off

Reset Camera Setting

- 1 Press <Menu/OK> button.
- 2 Press Up/Down (▲/▼) arrow button to move highlight to “SETUP” Menu.
- 3 Press <Menu/OK> button.
- 4 Select “RESET SETTING”.
- 5 Press <Menu/OK> button.
- 6 Select “RESET” and press <Menu/OK> button to reset the parameters. Press “CANCEL” to keep your settings.

Select “EXIT MENU” by pressing UP/Down arrow (▲/▼) button. Press <Menu/OK> button.

Select “EXIT MENU” by pressing Down arrow (▼) button. Press <Menu/OK> button to return Capture mode.

Setting Digital Zoom

- 1 Press <Menu/OK> button.
- 2 Press Up/Down (▲/▼) arrow button to select “SETUP” Menu.
- 3 Press <Menu/OK> button.
- 4 Select “DIGITAL ZOOM” by pressing Up/Down (▲/▼) arrow button.
- 5 Press <Menu/OK> button.
- 6 Press “OFF” to disable Digital Zoom and press <Menu/OK> button to apply the settings. To enable this function, repeat above procedure and select “ON”.

Note: To activate the Digital Zoom function, the LCD display must turn on and the Optical Zoom of this camera must reach its maximum 3 times. Digital Zoom is increased from 1.1X to 3.3X with an increment of 0.1 per step.

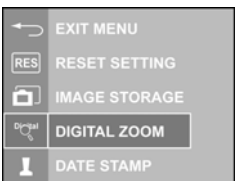

Setting Camera Sound Volume

The volume level of this camera can be set to **High**, **Low** and **Off**.

- 1 Press <Menu/OK> button.
- 2 Select "SETUP" Menu by pressing Up/Down (▲/▼) arrow button.
- 3 Press <Menu/OK> button
- 4 Press Up/Down (▲/▼) arrow button to select "CAMERA SOUNDS".
- 5 Press <Menu/OK> button.
- 6 Select the desired sound level and press <Menu/OK> button to setup.

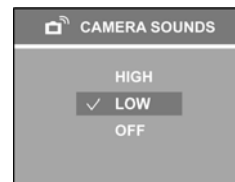
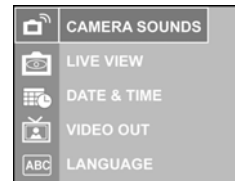
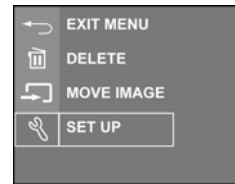

Setting Image Storage

This camera allows you to use either internal memory or card as the current image storage.

- 1 Press <Menu/OK> button.
- 2 Move highlight to "SETUP" Menu by pressing Up/Down (▲/▼) arrow button.
- 3 Press <Menu/OK> button.
- 4 Press Up/Down (▲/▼) arrow button to select "IMAGE STORAGE". Press <Menu/OK> button.
- 5 Select "AUTO" to SD/MMC card as current image storage if the card is inserted otherwise internal memory will be used. Select "INTERNAL" to always use the images as current image storage. Press <Menu/OK> button to apply the settings. A "Reading Memory Card..." or a "Reading Internal Memory..." will be on the LCD display.

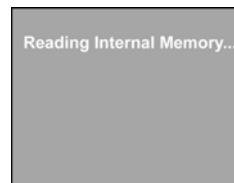
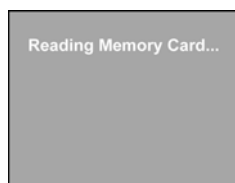

Setting Date Stamp

This camera can have a Date Stamp function on images. The Date Stamp can be set by **Off**, **Y**(Year)-**M**(Month)-**D**(Date), **M**(Month)-**D**(Date)-**Y**(Year), **D**(Date)-**M**(Month)-**Y**(Year).

- 1 Press <Menu/OK> button.
- 2 Move highlight to "SETUP" Menu by pressing Up/Down (▲/▼) arrow button.

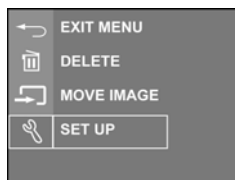

- 3 Press <Menu/OK> button.
- 4 Press Up/Down (▲/▼) arrow button to select "DATE STAMP". Press <Menu/OK> button.



- 5 Press Up/Down (▲/▼) arrow button to setup Date, Month and Year. Press <Menu/OK> button to apply the settings.

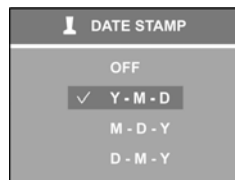

Setting Customize

This camera can be set to your favorite personal camera Opening Screen.

1 Press <Menu/OK> button.

2 Move highlight to "SETUP" Menu by pressing Up/Down (▲/▼) arrow button.



3 Press <Menu/OK> button.

4 Press Up/Down (▲/▼) arrow button to select "CUSTOMIZE". Press <Menu/OK> button.

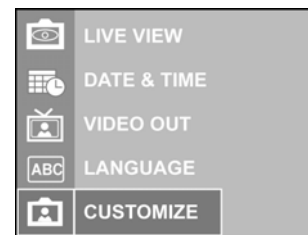

5 Select "NEW" to select an image from current image storage. Press Left/Right arrow button to navigate the images and press <Menu/OK> button to store current image into the favorite image buffer.

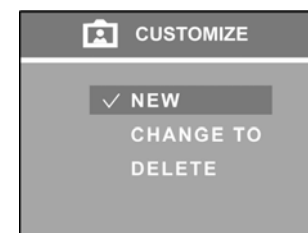

6 Press Left/Right arrow (◀▶) button to navigate the images in the favorite image buffer. Press Down arrow (▼) button to select "CHANGE TO", and press <Menu/OK> button to let the Opening Screen changed to the background image. The favorite image buffer can be stored up to 5 images, including the default Welcome Screen. Select "DELETE" can remove the image from the favorite image buffer. The "NEW" option will be disappeared if the favorite image buffer is full. The "DELETE" option will be disappeared if current background image is the default Welcome Screen. Once the favorite image buffer is full, to delete an image from the favorite image buffer is required before you add any new image into the favorite image buffer.

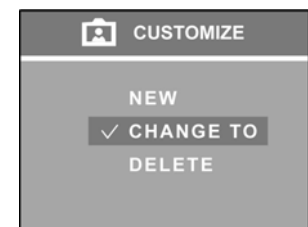

Software Installation

Installation Software/Hardware Driver

Insert the software CD into the CD-ROM drive. The CD should auto run and the installer menu will appear (see below). If the CD does not auto run; go to: Start → Run, and type in "D:\setup.exe" where D:\ is the CD-ROM drive.



Two installation options: *Automatic Installation* and *Custom Installation*. **Automatic Installation** is recommended.

Automatic Installation

The automatic installation will install all the software on the CD to the computer. When prompted to accept a license agreement with the third party software company at the beginning of the software installation, click "Yes" and continue the installation.

Ulead License Agreement

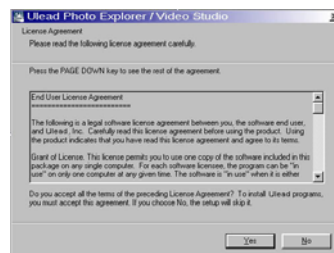

When prompted to restart the computer, save and close all running programs to prevent any loss of data, and then select "Yes, I want to restart my computer now." and click "OK" to finish the software installation. After restarting the computer, the driver will automatically install Acrobat Reader program. (Note: Please keep the CD inside the CD-ROM drive after restarting the computer. Remove the CD after all applications are successfully installed.)

Custom Installation

The custom installation allows individual selection of the software provided on the CD. From the previous Installer Menu select “Custom Installation” and click “Next”. The following screen will appear:



- 1 Check the desired application(s) and click “Next” to continue the software installation.
- 2 Follow the on-screen instructions to complete installing each software. The installation will be in the order of the menu above.
- 3 After ALL software are installed, select “Yes, I want to restart my computer now” and click “Finish”.

Note : For information on how to use Ulead Photo Explorer and Video Studio, please visit its website at www.ulead.com.

Downloading & Transferring Files to Computer

- 1 Plug the small end of the USB cable to the USB/AV port of your camera. Plug the other end of the USB cable to the USB port of your computer
- 2 **Set the camera to Power ON.** Be sure batteries are inside of the battery compartment.
- 3 Go to “My Computer” and open “Removable Disk (D:)” or the next available alphabet for the removable disk. (This camera uses mass storage so the computer will detect a hardware device.) You will see a folder labeled “DCIM” is inside this drive. Click to open this folder, and then click again to open the next folder “nnnSX630”.(where nnn =100~999). Your video and image files are stored under this folder.

NOTE: If you’re using Windows XP, the Windows Wizard will open and you can select the operations offered by Windows to download, view, or play your digital files (shown next page).

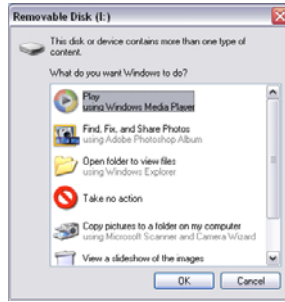

- 4 To download the files to your computer, highlight the files that you want to save, and choose one of the following way to move your files.

- a. Copy & Paste

Right-click on the highlighted files with and select “Copy” from the resulting menu. Go to the target location on your computer and right-click on it again, and select “Paste” from the resulting menu.

- b. Drag & Drop

With both source and target locations on display, click and hold on the highlighted files on source location. Drag the files to target location, and release the button.

How to Download Pictures via Ulead Photo Explorer

Follow the instructions below to transfer your digital files using third party applications.

- 1 Connect the camera to the computer.
- 2 **Power on the camera.**
- 3 Launch Ulead Photo Explorer by clicking Start → Programs → Ulead → Ulead Photo Explorer → Photo Explorer 8SE Basic.
- 4 Open the “Folders” from the top bar of the Photo Explorer screen.
- 5 Click Removable Disk (D:) or the next available letter for the removable disk.
- 6 Open the folders “DCIM” → “nnnSX630”.
- 7 The digital files are stored under this folder.

Note : Use Ulead Photo Explorer to open digital still images only. Use Ulead Video Studio or Windows Media Player to open digital video files.

Troubleshooting

Condition	Corrective Action
Camera cannot power on.	The batteries may be exhausted. <ul style="list-style-type: none"> ● Replace new batteries. ● The batteries are installed incorrectly. ● Reinstall the batteries with correct polarities.
Camera turns off automatically.	<ul style="list-style-type: none"> ● Press any button to restore power to the camera.
LCD turns off automatically.	<ul style="list-style-type: none"> ● Press any button to turn on the LCD.
Empty battery icon is displayed on LCD and turns off camera quickly.	Batteries are exhausted. <ul style="list-style-type: none"> ● Replace new batteries.
LCD display "The Card Requires Formatting".	Improper formatting of the memory card. <ul style="list-style-type: none"> ● Re-format the memory in the camera.
LCD display "Card Full".	Memory card has no more space to store the picture being taken. <ul style="list-style-type: none"> ● Replace new memory card or delete unnecessary images from the existing card.
The card is locked.	The card is protected by protect switch mechanism. <ul style="list-style-type: none"> ● Switch the protection switch to unlock position.
Insufficient memory space to complete request.	Insufficient room in the memory to rotate an image. <ul style="list-style-type: none"> ● Delete unnecessary images in the memory.
No image appears on the TV screen.	Incorrect TV out type was selected. <ul style="list-style-type: none"> ● Set correct TV out type to match your TV system.
Insufficient space on the card.	<ul style="list-style-type: none"> ● Delete unnecessary images from the memory.

Specifications

DESCRIPTION	SPECIFICATION.
Image sensor	1/1.8" CCD with 6 million square pixels
Still image output resolution	6M (2848 x 2136 pixels) 6M 3:2 (2848 x 1904 pixels) 4M (2272 x 1704 pixels) 2M (1600 x 1200 pixels) VGA (640 x 480 pixels)
Still image file formats	JPEG (Exif 2.2)
Movie mode resolution	320X240 @ 20 fps with audio
Movie file format	AVI
Internal memory	16MB
Memory card slot	SD/MMC
LCD monitor	1.8" LTPS (or 1.5" LTPS, depends on the product provided.)
Aperture	F2.8 - F4.8
Zoom	3X optical zoom, 5X digital zoom
Focal length	f =4 - 24 mm (equivalent 35 mm, f=39 - 117mm)
Focus range	Auto : 0.5M~ infinity Macro : 15cm ~ 50cm
Viewfinder	Optical
Date Stamp	Yes, user selectable
ISO equivalent	Auto, ISO100/200/400
Flash	Auto, On, Off, Red eye reduction
Shooting mode	Movie, Full Auto, Portrait, Landscape, Close-up, Preset Scene
Preset Scene	Sports, Night Landscape, Night Portrait, Museum, Backlight
Tripod mount	Yes
DPOF	Version 1.1
Exposure compensation	Selectable +/-2.0 EV with 0.3 EV steps
Auto exposure mode	Center weighted, Average evaluation, Spot
Self Timer	10 seconds, 2 seconds, Off
White Balance	Auto, Sunny, Cloudy, Tungsten, Fluorescent
Image parameter	Sharpness: High/Normal/Low Color Mode: Normal, Vivid, Black & White, Sepia
Audio/Video Out	PAL · NTSC
Speaker	Yes, Mono
Battery	2 x AA NiMH batteries (recommended) or 1x CRV3 Lithium battery
Host Platform	Windows 98SE/ME/2000/XP
Dimensions	95 mm (W) x 65 mm(H) x 34 mm(D) 3.7" (W) x 2.6" (H) x 1.3" (D)
Weight	170 g (without battery) 6 oz. (without battery)