

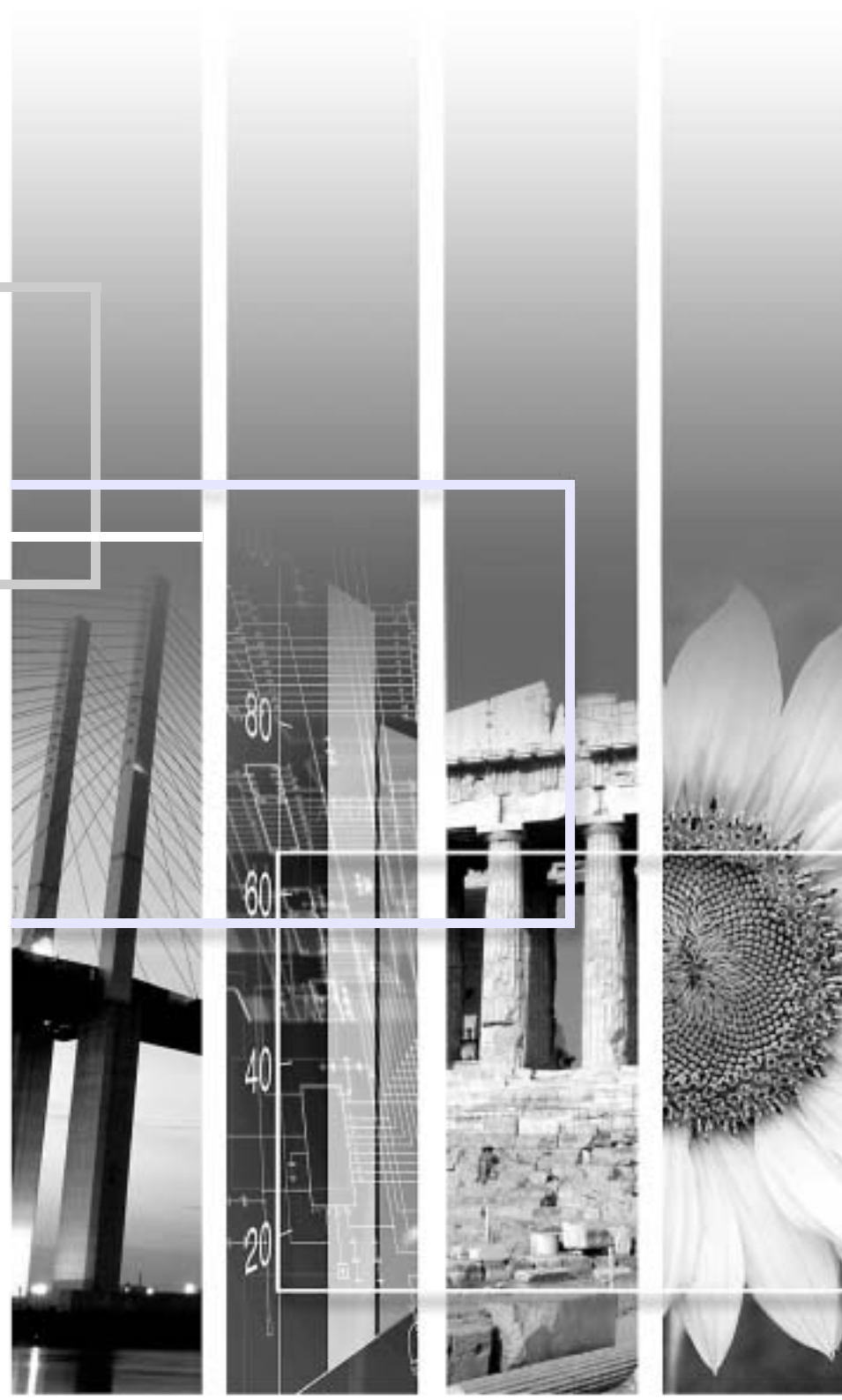



EPSON PowerLite® S1

User's Guide



Meaning of Symbols

	Indicates the possibility that people may be injured or the equipment may be damaged if these symbols are ignored.
	Indicates important related information or useful information and things you should know.
	Indicates related topics and pages which contain more detailed information.
	Provides terminology definitions. See “Glossary” on page 61 .

The terms ‘this unit’ and ‘this projector’ which appear in this manual may also refer to the accessories supplied with the projector and other optional products.

Copyright Notice

All rights reserved. No part of this publication may be reproduced, stored in a retrieval system, or transmitted in any form or by any means, electronic, mechanical, photocopying, recording, or otherwise, without the prior written permission of SEIKO EPSON CORPORATION. The information contained herein is designed only for use with this EPSON product. EPSON is not responsible for any use of this information as applied to other products.

Neither SEIKO EPSON CORPORATION nor its affiliates shall be liable to the purchaser of this product or third parties for damages, losses, costs, or expenses incurred by purchaser or third parties as a result of: accident, misuse, or abuse of this product or unauthorized modifications, repairs, or alterations to this product, or (excluding the U.S.) failure to strictly comply with SEIKO EPSON CORPORATION’s operating and maintenance instructions.

SEIKO EPSON CORPORATION shall not be liable for any damages or problems arising from the use of any options or any consumable products other than those designated as Original EPSON Products or EPSON Approved Products by SEIKO EPSON CORPORATION.

EPSON is a registered trademark of SEIKO EPSON CORPORATION.

EPSON Connection, EPSON Store, and Extra Care are service marks; and PrivateLine, Presenters Club, and PowerLite are registered trademarks of Epson America, Inc.

Pixelworks, DNX, and the DNX logo are trademarks of Pixelworks, Inc.

General Notice: Other product names used herein are for identification purposes only and may be trademarks of their respective owners. EPSON disclaims any and all rights in those marks.

Features

Auto setup (Computer connections)

The projector analyzes the signal of the computer to which it is connected and automatically makes adjustments to ensure optimal projection results. See [“Functions for Enhancing Projection” on page 29.](#)

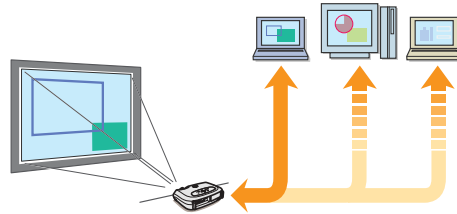

Color mode

Image quality can be selected according to the type of scene. See [“Selecting a color mode” on page 29.](#)

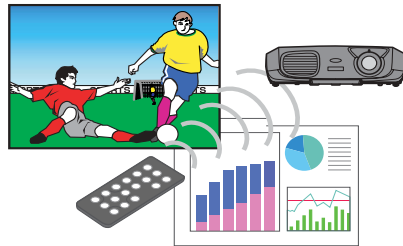

Compact and lightweight

The projector is compact and easy to carry.

- ▶ Dimensions:
10.4 (d) × 14.6 (w) × 4.2 (h) inches
26.5 (d) × 37 (w) × 10.6 (h) cm
- ▶ Weight:
approximately 7 lbs (3.2 kg)

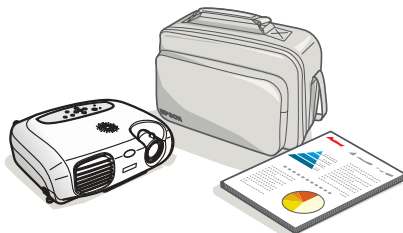

Clear, vivid, images

The projector's high resolution and high luminance achieves a legible display. Project sharp, detailed images, even in bright places.



Ease of use

Various projector operations can be easily performed using the included remote controls, as follows:

- ▶ pausing projection
- ▶ zooming in on important areas of an image



Unique presentation function

The mouse pointer can be moved around on the computer screen during projection using the included presentation remote control. (wireless mouse)

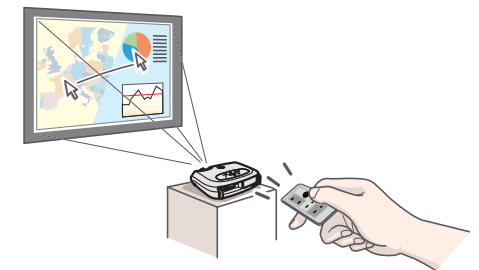

Contents

Before Using the Projector

Part Names and Functions	6
Front/Top	6
Control panel	7
Rear	8
Base	9
Remote Control	10
Installation	12
Installation method	12
Projection distance and screen size	12
Other installation methods	13
Connecting to a Computer	14
Compatible computers	14
Projecting images from a computer	14
Playing sound from a computer	15
Connecting to an external monitor	16
Presentation Remote Control	16
Connecting to Video Equipment	20
Projecting video images	20
Playing sound from video equipment	21

Basic Operation

Turning on the Projector	22
Turning off the Projector	24
Adjusting the Display	25
Adjusting the projection size	25
Setting the focus	25
Adjusting the projection angle	26
Keystone	27
Selecting the Input Source	28

Advanced Operation

Functions for Enhancing Projection	29
Adjusting computer generated images	29
Selecting a color mode	29
A/V Mute	30
Freeze	30
Projecting in widescreen (changing aspect ratio)	31
E-Zoom	31
Configuration Menus	32
Menu operation	33
Function list	36

Troubleshooting

When You Suspect a Problem	43
Power indicator	43
Warning indicator	44
When the indicators provide no help	45
Where to Get Help	53
Telephone Support Services	53

Appendix







Projector Care	54
Cleaning	54
Replacing consumables	56
Optional Accessories	60
Glossary	61
Cable Format	63
Supported Display Resolutions	64
Specifications	65
Important Safety Instructions	66
FCC Compliance Statement	68
Warranty	69

Index

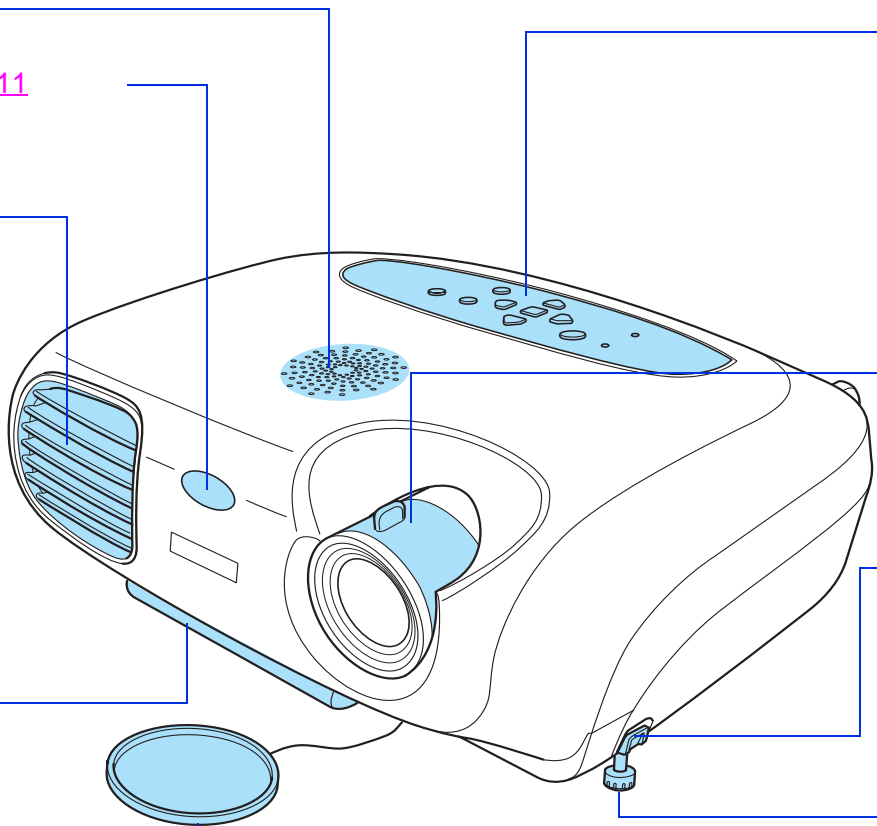
Before Using the Projector

Part Names and Functions

Front/Top

- 
- The diagram shows a top-down view of a projector with several parts highlighted in blue and labeled with callout lines. The parts include a speaker on the left side, a remote control infrared receiver on the top surface, a ventilation outlet on the top surface, a control panel on the top surface, a focus ring on the front lens, a handle on the bottom edge, a foot button on the bottom edge, and a front foot on the bottom edge. A lens cover is shown separately below the projector.
- **speaker**
 - **remote control infrared receiver**  [P. 11](#)
Receives signals from the remote control.
 - **ventilation outlet**
 - **control panel**  [P. 7](#)
 - **focus ring**  [P. 25](#)
Adjusts the image focus.
 - **foot button (left)**  [P. 26](#)
Another foot button is located on the right side.
Press both buttons when extending and retracting the front feet.
 - **handle**
Pull out this handle to use when carrying the projector.
 - **front foot (left)**  [P. 26](#)
Another front foot is located on the right side.
Extend and retract to adjust the projection angle.
 - **lens cover**
Attach when not using the projector to prevent the lens from becoming dirty or damaged.

Control panel

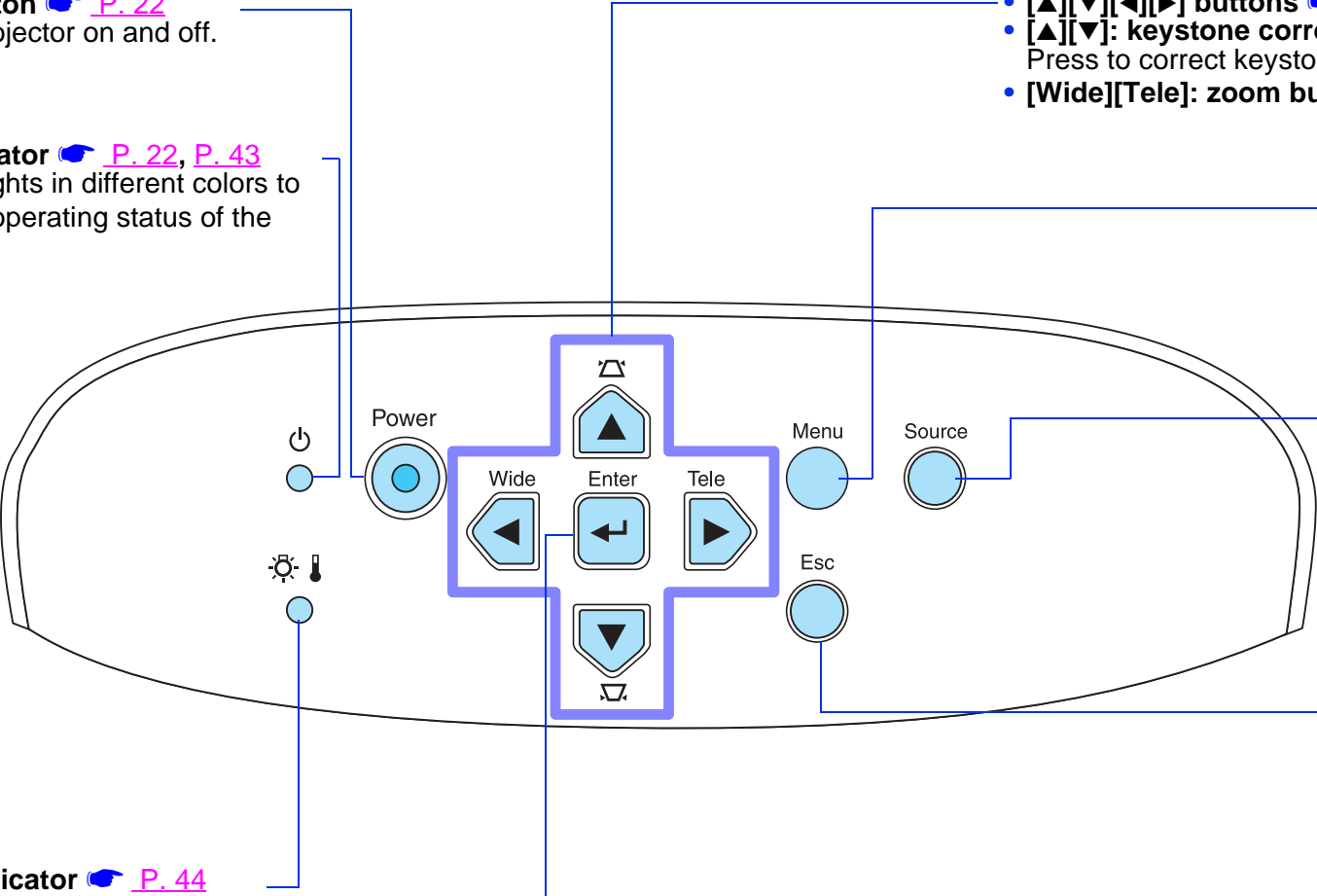
- 
- The diagram shows the control panel of a projector with various buttons and indicators. A blue box highlights the central navigation area containing the Wide, Enter, and Tele buttons, along with the four arrow keys (Up, Down, Left, Right) and the Keystone correction buttons (top and bottom triangles). Lines connect these elements to their respective descriptions in the surrounding text.
- **[Power] button** [P. 22](#)
Turns the projector on and off.
 - **Power indicator** [P. 22, P. 43](#)
Flashes or lights in different colors to indicate the operating status of the projector.
 - **Warning indicator** [P. 44](#)
Flashes or lights in different colors to alert you to problems with the projector.
 - **[▲][▼][◀][▶] buttons** [P. 33](#)
 - **[▲][▼]: keystone correction buttons** [P. 27](#)
Press to correct keystone distortion in images.
 - **[Wide][Tele]: zoom buttons** [P. 25](#)
 - **[Menu] button** [P. 32](#)
Displays or hides the configuration menus.
 - **[Source] button** [P. 28](#)
Switches the input source between the Computer/Component Video port, S-Video port and Video port each time the button is pressed.
 - **[Esc] button** [P. 35](#)
Stops the current function. Displays the previous screen or menu when viewing configuration menus.
 - **[↵] button** [P. 34](#)
Accepts a menu item or advances to the next screen or menu when viewing configuration menus.

Rear

- **Computer/Component Video port**  [P. 14](#), [P. 20](#)

Inputs analog video signals from a computer and [Component Video†](#) signals from other video sources.

- **Video port**  [P. 20](#)

Inputs [Composite Video†](#) signals to the projector.
Connect using an A/V cable.

- **S-Video port**  [P. 20](#)

Inputs [S-Video†](#) signals to the projector.
Connect using an S-Video cable.

- **Audio port**  [P. 15](#), [P. 21](#)

Inputs audio signals to the projector.
Connect using an A/V cable, or a stereo RCA cable.
When using computer and video equipment alternately, swap the cable or use an audio switch.

- **Control (RS-232C) port**  [P. 63](#)

Connects the projector to a computer using an RS-232C cable. This port is for control use and should not be used by the customer.

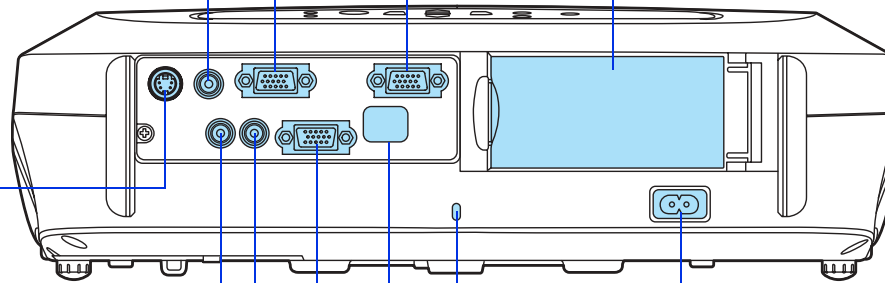

- **Monitor Out port**  [P. 16](#)

Outputs the projected analog computer signal to an external monitor. This feature is not available for video signals.

- **remote control holder**  [P. 11](#)

Store the remote control in here when not in use.

- **power inlet**  [P. 22](#)

Connects the power cable.

- **security lock**  [P. 62](#)

- **remote control infrared receiver**  [P. 11](#)

Receives signals from the remote control.

Base

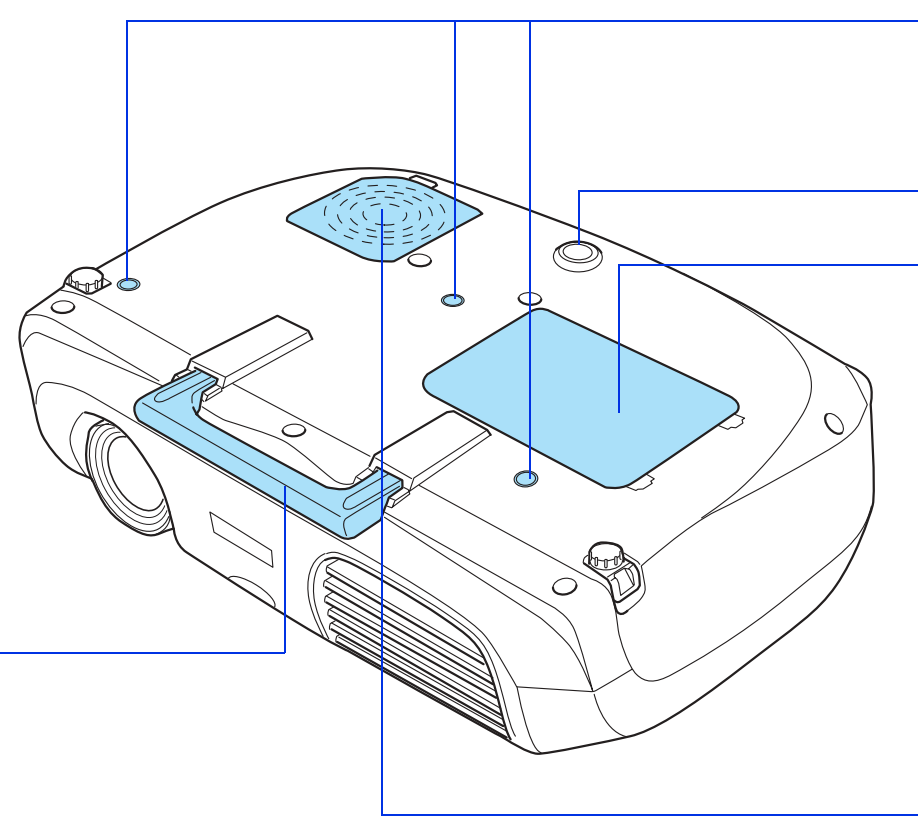

- **handle**
Pull out this handle to use when carrying the projector.

- **ceiling mount holes (3 points)**
Install the optional ceiling mount here when suspending the projector from the ceiling.

- **rubber foot**

- **lamp cover**  [P. 57](#)
Open this cover when replacing the lamp inside the projector.

- **air filter (air intake vent)**  [P. 55](#), [P. 59](#)
Prevents dust and other foreign particles from being drawn into the projector. When replacing the lamp, replace the air filter also.

Remote Control

- **remote control infrared transmitter**
Transmits remote control signals.

- **[E-Zoom] buttons** [P. 31](#)

- ⊕ : Enlarges part of the image without changing the size of the projection area.
- ⊖ : Reduces the part of the image that has been enlarged using the [⊕] button.

- **[Source] buttons** [P. 28](#)

- [Computer]: Switches to the signal source being input to the Computer/Component Video port.
- [S-Video/Video]: Switches between the signal source being input to the S-Video port and the Video port.

- **[Aspect] button** [P. 31](#)

- Changes the aspect ratio of images from 4:3 to 16:9.

- **[▲][▼][◀][▶] buttons** [P. 33](#)

- Selects menu items and setting values.

- **[◀][▶]: volume buttons**

- Adjusts the volume.

- **[Menu] button** [P. 32](#)

- Displays or hides the configuration menus.

- **[A/V Mute] button** [P. 30](#)

- Momentarily turns off the audio and video.

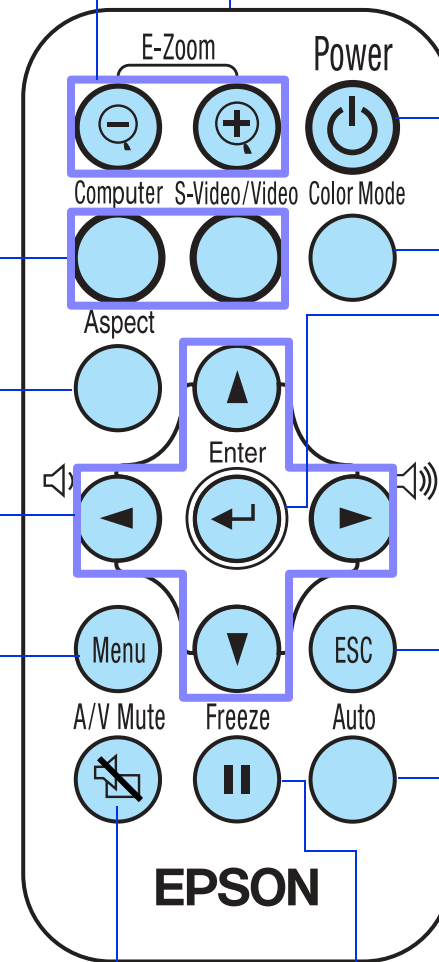

- **[Power] button** [P. 22](#)
Turns the projector on and off.

- **[Color Mode] button** [P. 29](#)
Selects the color mode. The color mode changes in the order of Dynamic, Presentation, Theatre, Living Room and sRGB† each time the button is pressed.

- **[↵] button** [P. 34](#)
Accepts a menu item or advances to the next screen or menu when viewing configuration menus.

- **[Esc] button** [P. 35](#)
Stops the current function.
Displays the previous screen or menu when viewing configuration menus.

- **[Auto] button** [P. 29](#)
Use this button to automatically adjust computer images to their optimum settings when automatic setup has been set to "OFF."

- **[Freeze] button** [P. 30](#)
Keeps the current image on the screen.

Before using the Remote Control

Remove the insulating tape.

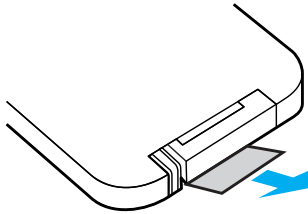

Using the Remote Control

Operate the remote control by aiming it at the remote control infrared receiver on the projector.

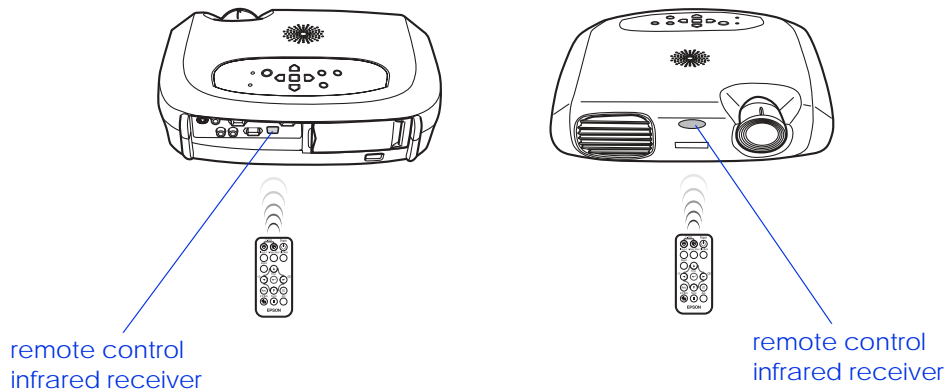

remote control
infrared receiver

remote control
infrared receiver

Operating range

Operable distance: Max. approximately 20 feet (6 m)
(May be shorter depending on conditions.)

Operable angle: approximately 30° horizontally, 15° vertically

* The remote control infrared receiver on the back of the projector can also be used under the same conditions.

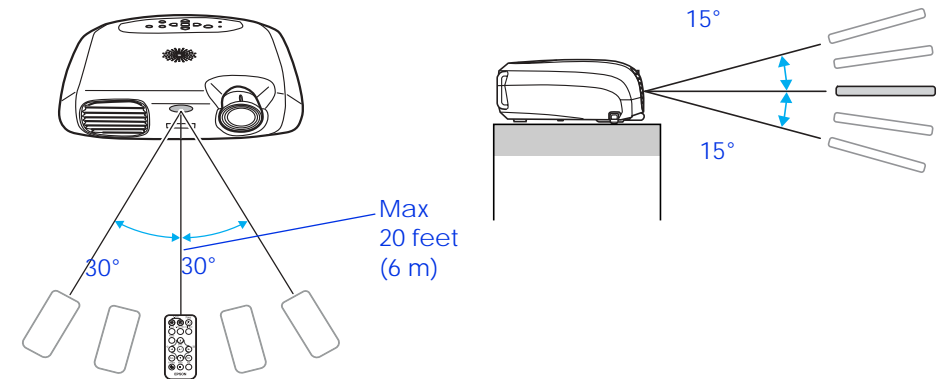

Storage

When not using the remote control, please store it in the remote control holder on the projector.

- 1 Open the remote control holder.
- 2 Place the remote control in the remote control holder.
- 3 Close the remote control holder until it clicks into place.

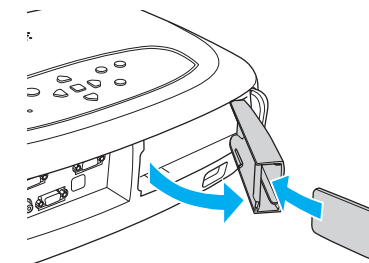

 **If direct sunlight or fluorescent lighting hits the remote control infrared receiver, you may not be able to use the remote control.**

Installation

! Be sure to read the [Important Safety Instructions](#) before installation.

Installation method

Set up the projector so that it is at right angles to a screen.

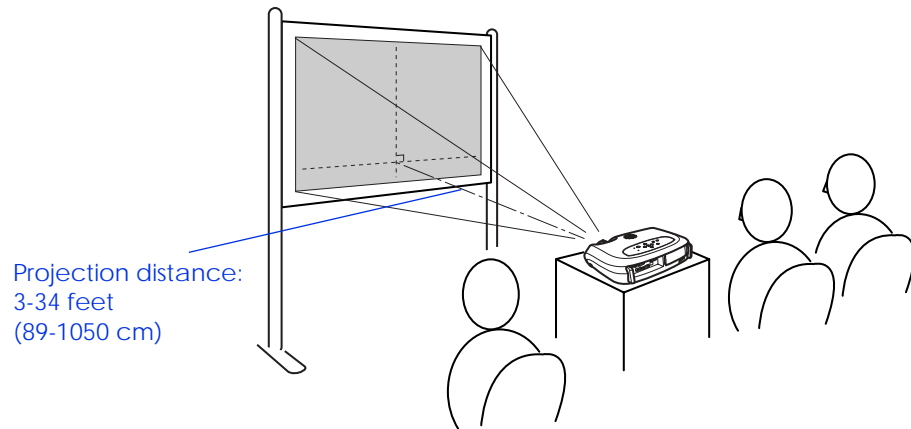

Projection distance and screen size

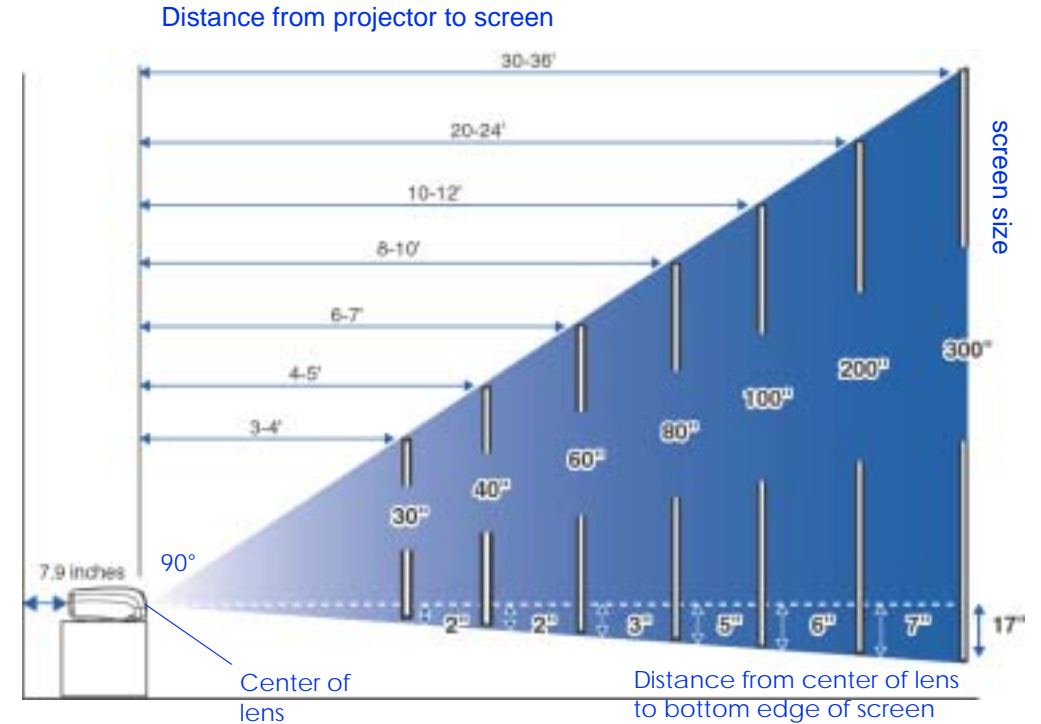

! When setting up the projector against a wall, leave a space of at least 7.9 inches (20 cm) between the projector and the wall.

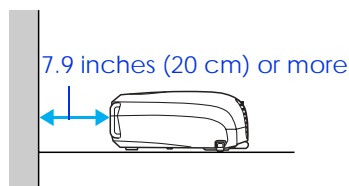

Other installation methods

Rear projection

(Using a translucent screen)

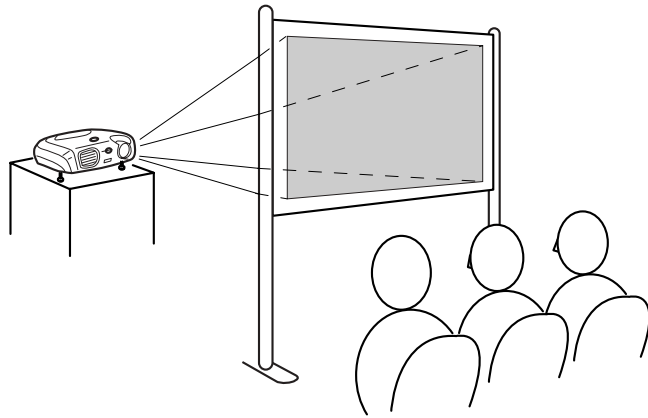

Ceiling projection

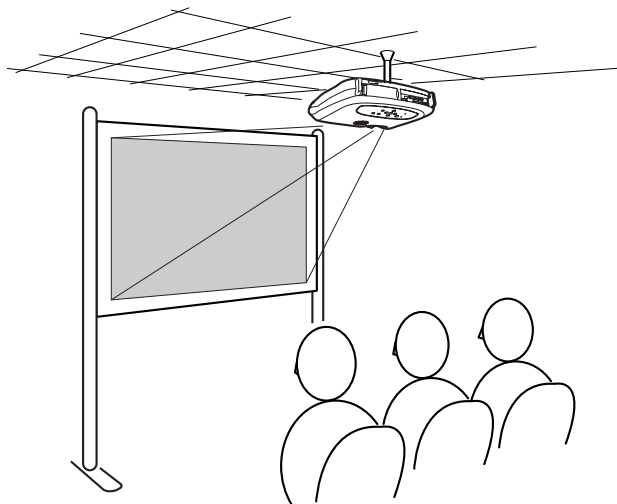

Ceiling/Rear projection

(Using a translucent screen)

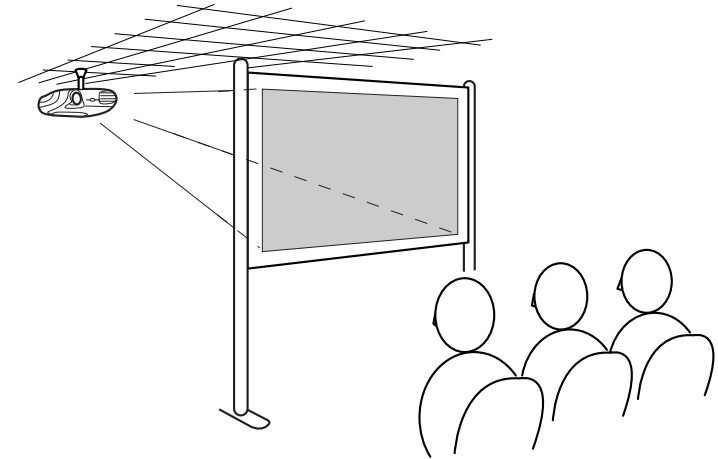

The optional ceiling mount is required when installing the projector from a ceiling. Please contact your dealer if you wish to use this method, as special equipment is required for installation. See ["Optional Accessories" on page 60](#).



When using rear projection, or projecting from a ceiling, select the appropriate mode in the "Setting" → "Screen" → "Projection" configuration menu. See ["Setting menu" on page 39](#).

Connecting to a Computer



When connecting, be sure to:

- **Turn off the power for both the projector and the computer.**
Damage may result if you try to make a connection when the power is switched on.
- **Check the connector types.**
Damage may result if you attempt to insert a connector into the incorrect port.

Compatible computers

Condition 1: Check that the computer has an image output port, such as an RGB port, monitor port or CRT port.

Some computers with a built-in monitor and some notebook computers may not be compatible. Please refer to your computer manual for further details.

Condition 2: The display frequency and resolution of the computer must correspond to that of the projector. See [“Supported Display Resolutions” on page 64](#).



You may need to purchase a separate adapter depending on the shape of the computer's port. Refer to the documentation provided with the computer for further details.

Notebook connection

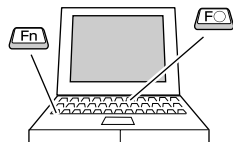

When using a notebook or a PC with a built-in monitor, select external video output on the computer.

Setup

Press and hold the [Fn] key, followed by the appropriate function number key that lets you display on an external monitor. Refer to your computer's documentation for further details.

- It may take a few moments until the computer image is projected.
- In Windows, a dialog box may appear to alert you that new display hardware has been found. Follow the on-screen instructions to proceed. If you have any problems, check the troubleshooting chapter for possible solutions. See [“Troubleshooting” on page 43](#).
- Depending on the PC, the monitor may go blank when using the external video output on the computer.

Projecting images from a computer

Different cables are used depending on whether the monitor port of your computer is a Mini D-Sub 15Pin, [5BNC†](#) or 13w3 port.

When using a Mini D-Sub 15 pin connector

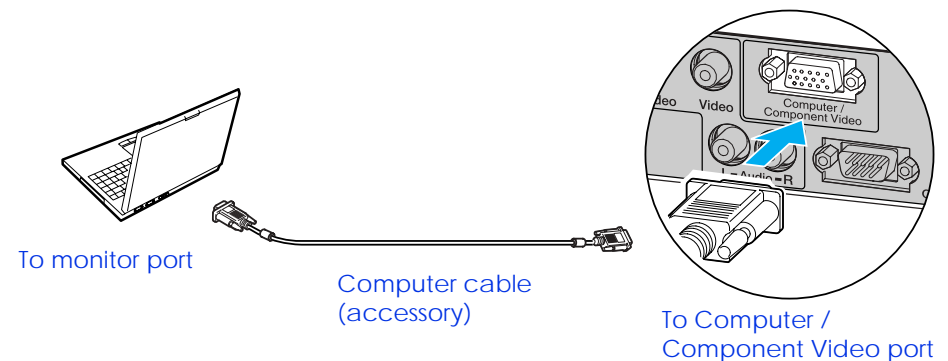

When using a 5BNC port

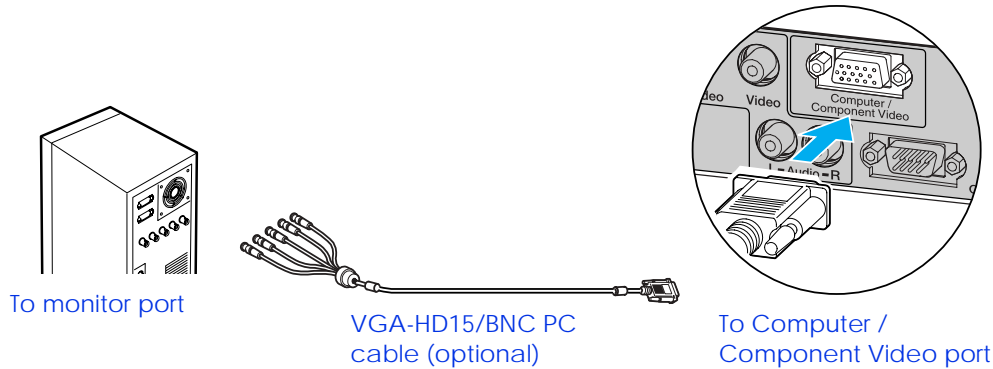

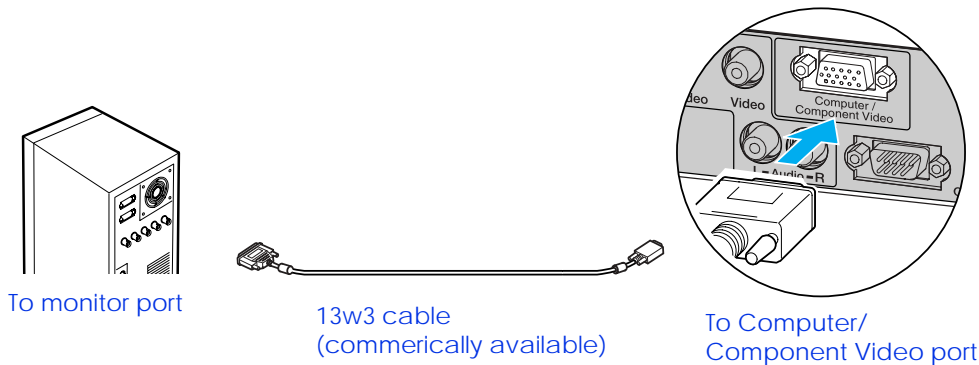

When using a 13w3 port

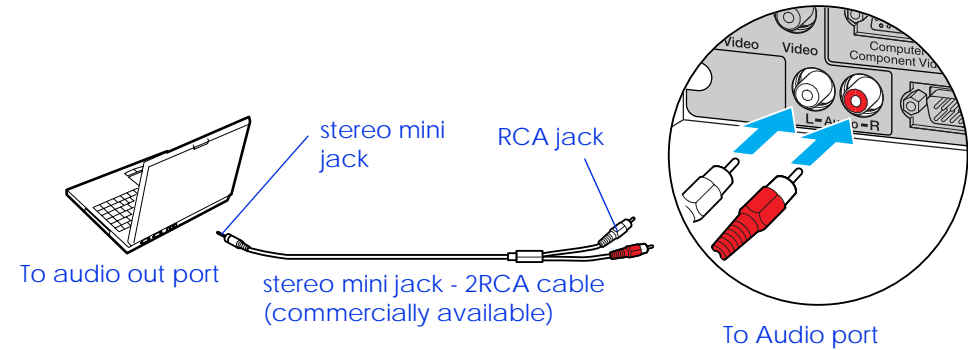

Playing sound from a computer

You can play sound from a computer through the projector's built-in speaker.



 When using computer and video equipment alternately, swap the cable or use an audio switch.

Volume adjustment

Press [◀] or [▶] on the remote control.

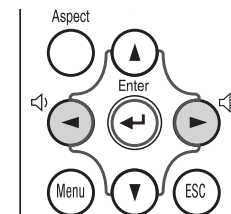

You can also adjust the volume from the configuration menu.

([Menu] button → "Setting" → "Volume") See ["Setting menu" on page 39](#).



- Select "Computer" in the "Image" → "Input signal" configuration menu. See ["Image menu" on page 36](#).
- Do not bind the power cable and computer cables together. Interference or operational problems may result.
- A particular type of cable may be required for some workstations. Please check with the maker of your workstation.

Connecting to an external monitor

The image being input into the projector can be displayed on a computer monitor.

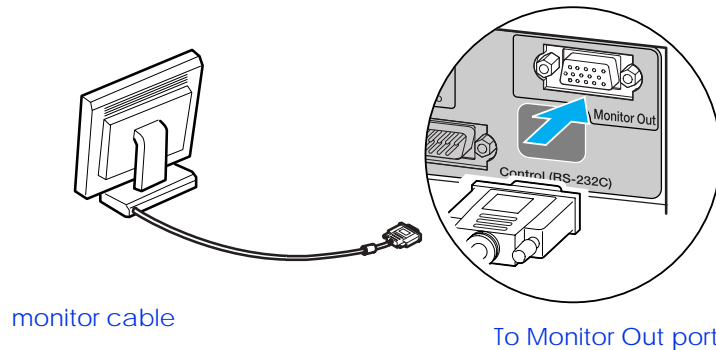

- **Video images cannot be output to an external monitor.**
- **Setting gauges (for keystone correction, etc.) and configuration menus will not be displayed on an external monitor.**

Presentation Remote Control

You can use the presentation remote control as a wireless mouse to control the mouse pointer on the computer screen. The presentation remote contains all the functions necessary for giving a presentation. Functions include: Page Up/Page Down, Left/Right mouse click, A/V mute, freeze, and mouse pointer.

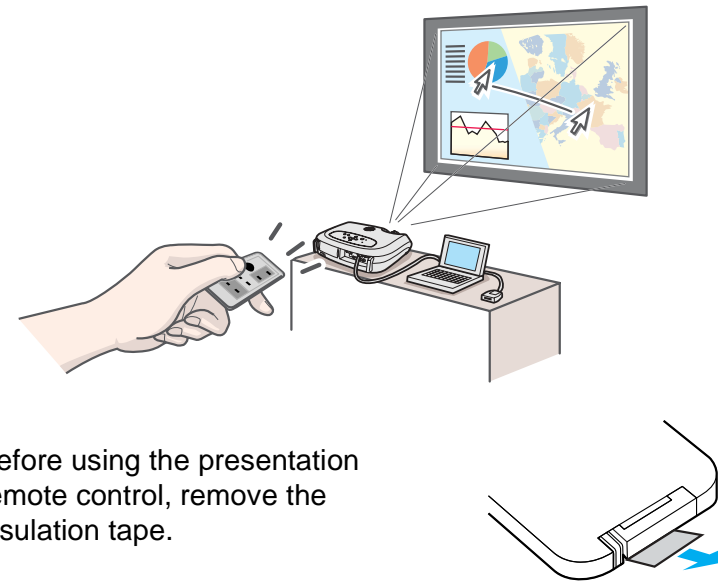

Compatible computers

Windows®: Windows 98/2000/Me/XP

(Only compatible with the full versions of Windows. Upgraded versions cannot be used.)

Macintosh®: Mac OS® 9.1 or later/OS X 10.1 or later



- **The presentation remote receiver can only be connected to computers with a standard USB interface.**
- **Some computer settings may have to be changed in order for the mouse function to be used. Refer to your computer's documentation for details.**

Installing the driver for Windows

Screen contents will differ according to the version of Windows you are using. This explanation uses screenshots taken from Windows 98.

Driver installation is not required for the Macintosh.

- 1 **Connect the accessory Presentation Remote Receiver to the USB port of the computer.**

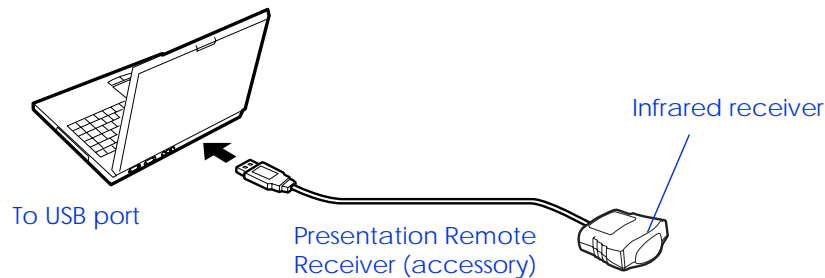

The “Add New Hardware” wizard is displayed.

Under normal circumstances, maintain the default settings and click “Next” to proceed.

- 2 **Click “Next.”**

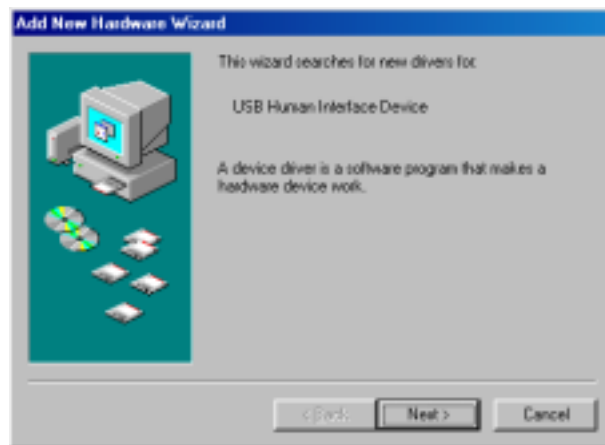

- 3 **Keeping the defaults, click “Next.”**

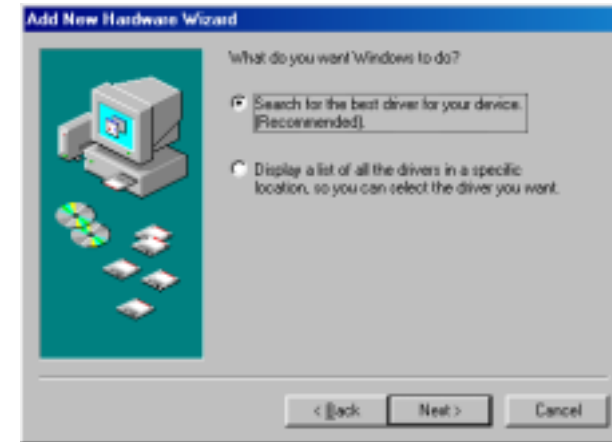

- 4 **Click the check box next to “Specify a location.” Type “C:\WINDOWS” and click “Next.”**

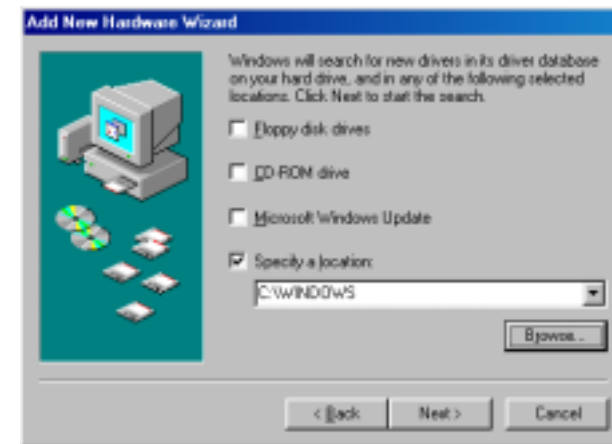

- You may need to enter a different location to search for the OS files that you are using.
- Click on “Browse” if you want to change the default search location.

- 5 Click on “Next” to confirm the message which is displayed.

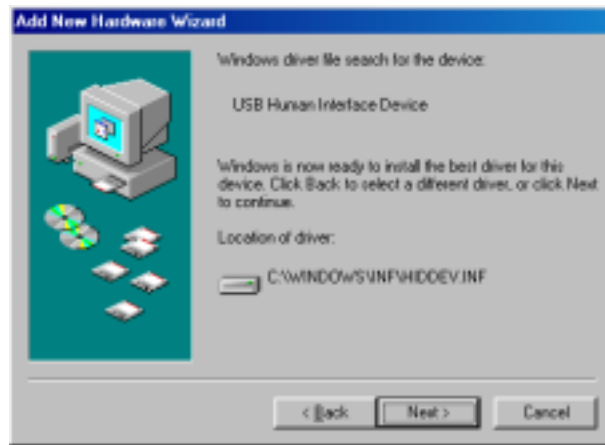

- 6 Click on “Finish.”

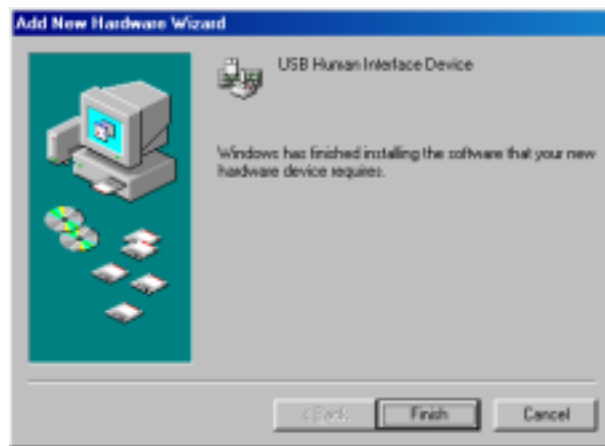

The installation of the driver is complete.



The driver installation screen is displayed a second time. (The presentation remote control driver has two parts; the mouse driver and the keyboard driver.) Follow the on-screen instructions to complete the installation.

Part Names and Functions

Operate the presentation remote control by aiming it at the presentation remote receiver.

When using the Freeze or A/V Mute functions, aim the presentation remote control towards the remote control infrared receiver of the projector.

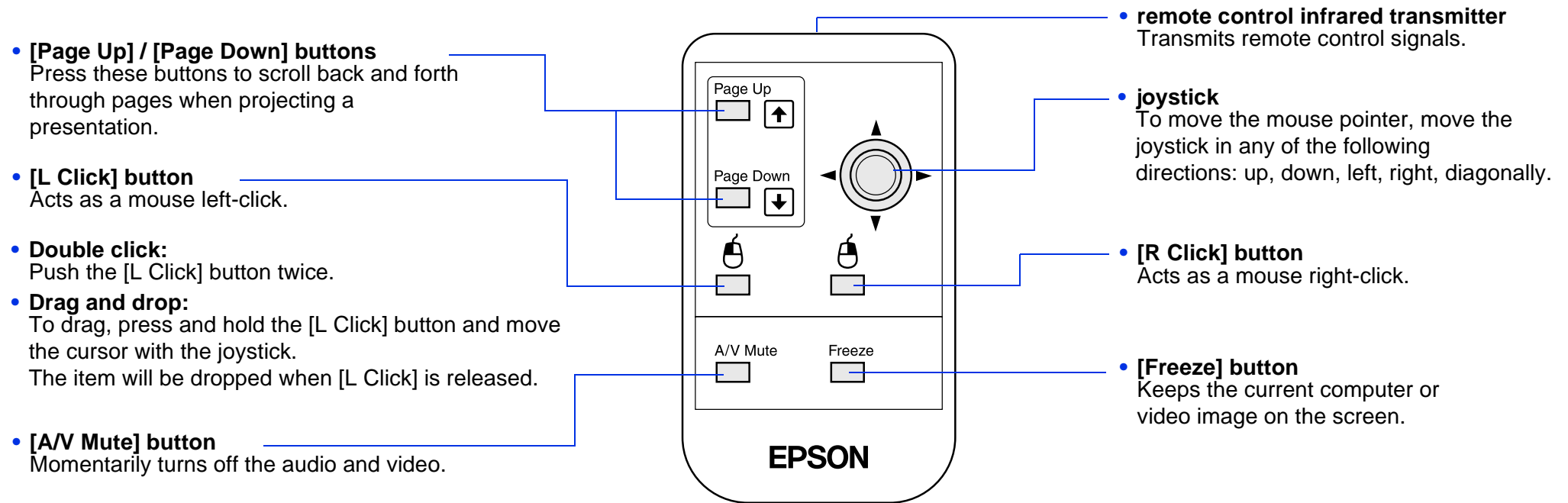

If the mouse button settings have been reversed on the computer, the operation of the remote control buttons will also be reversed.

Operating range

Operable distance: Maximum approximately 20 feet (6 m)
(may be shorter depending on conditions)

Operable angle: Approximately 30° horizontally, 15° vertically

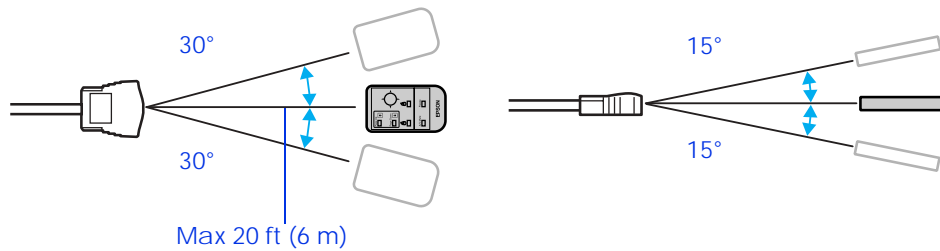

Connecting to Video Equipment



When connecting, be sure to:

- Turn off the power for both the projector and the video equipment. Damage may result if you try to make a connection when the power is switched on.
- Check the connector types. Damage may result if you attempt to insert a connector into the incorrect port.

Projecting video images

For Composite Video (DVD, VHS, Video games)

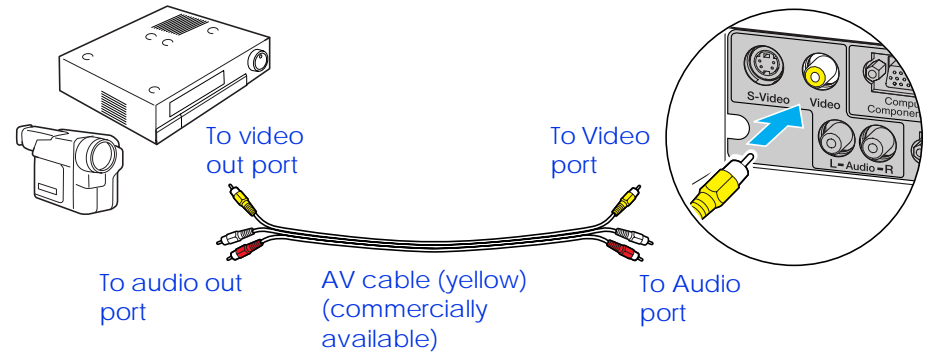

For S-Video (DVD, VHS, Video games)

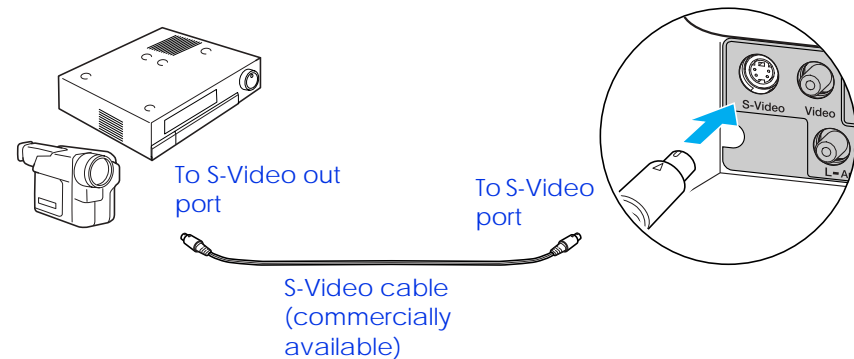

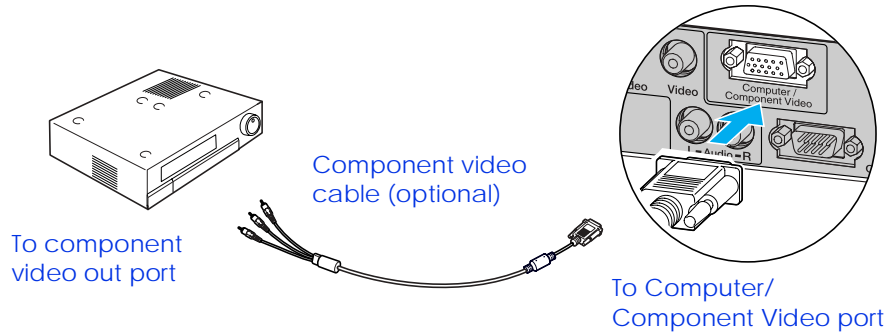

For Component Video (DVD, Video games)

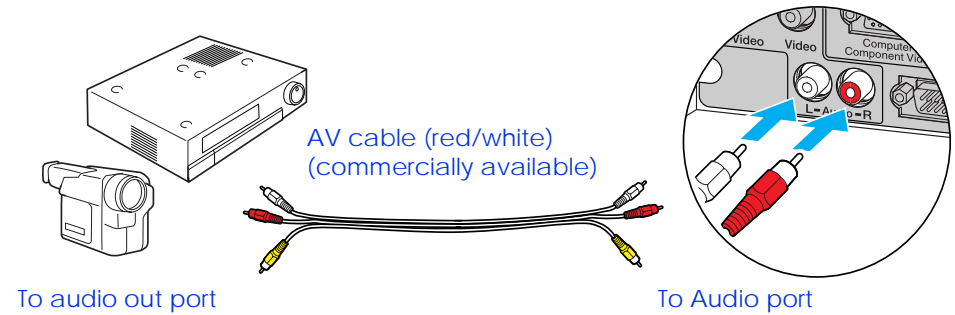

Playing sound from video equipment



 After projection starts, change the “Input Signal” setting in the “Image” menu to either “Component Video (YCbCr†)” or “Component Video (YPbPr†)” to match the signals from the video equipment.  [P.36](#)

 When using computer and video equipment alternately, swap the cable or use an audio switch.

For RGB Video

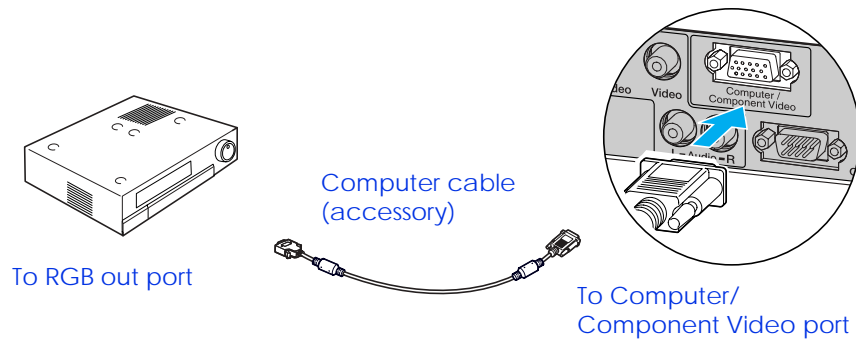

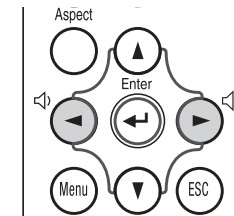

Volume adjustment

Press [◀] or [▶] on the remote control.



You can also adjust the volume with the configuration menu.

([Menu] button → “Setting” → “Volume”) See [“Setting menu” on page 39.](#)

-  After projection starts, change the “Input Signal” setting in the “Image” menu to “Computer.”  [P.36](#)
- For an RGB connection, a commercially available adapter or converter cable may be required.

Basic Operation

Turning on the Projector

! Turn off the power of the projector and the equipment you are connecting to.

1 Connect the computer/video.

See [“Connecting to a Computer” on page 14](#), [“Connecting to Video Equipment” on page 20](#).

2 Remove the lens cover.

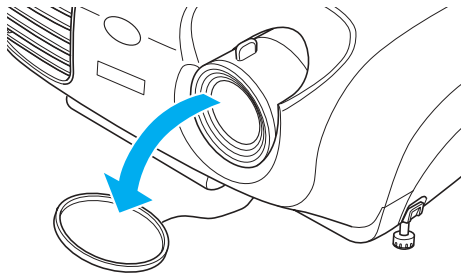

3 Attach the power cable to the projector.

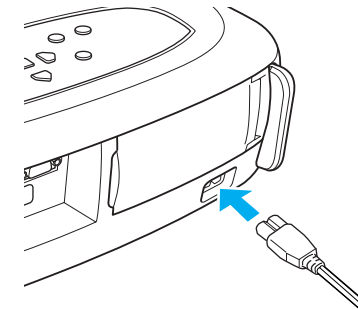

4 Insert the power plug into a wall socket.

The power indicator lights orange.

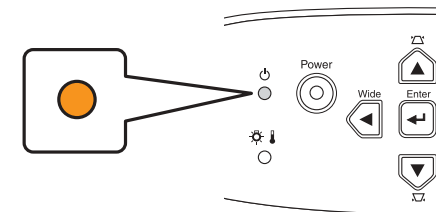

5 Turn on the power of the computer/video.

If connected to a video source, start playback.



When using a notebook or a PC with a built-in monitor, select external video output on the computer. [P.14](#)

6 Press the [Power] button.

The projector beeps and the power supply indicator begins to blink green.

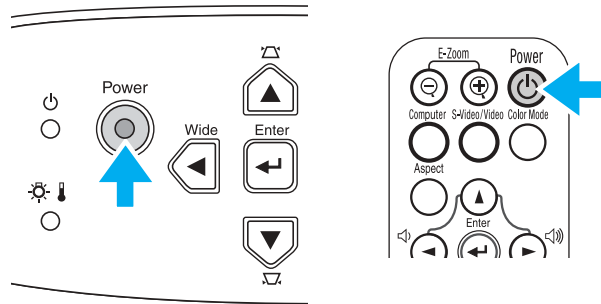
**7 Wait until the power indicator lights green.**

It takes about 35 seconds.

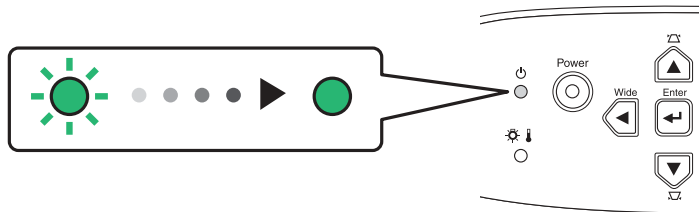

Adjusting the Display

Adjusting the projection size

The size of the projected image is basically determined by the distance from the projector to the screen. See [“Projection distance and screen size” on page 12.](#)

- 1 Press the [Wide] or [Tele] buttons on the control panel to adjust the projection size.

[Wide]: increase the size

[Tele]: reduces the size

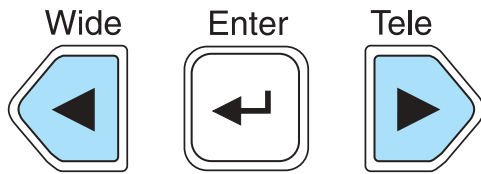

The image can be enlarged in this way to 1.2 times the normal size.

If you would like to enlarge the image further, move the projector further away from the screen.



- The default setting is wide.
- The E-Zoom function lets you enlarge parts of the image. See [“E-Zoom” on page 31.](#)

Setting the focus

Turn the focus ring to adjust the image focus.

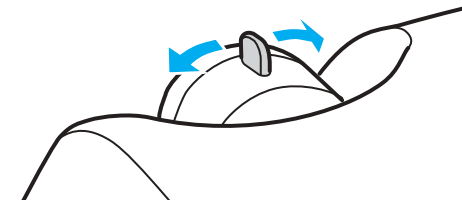

- If the surface of the lens is dirty, or misted over as a result of condensation, it may not be possible to adjust the focus correctly. If this happens, clean or de-mist the lens. See [“Cleaning the lens” on page 54.](#)
- If the projector is positioned outside the normal projecting range of 2.9-36.4 feet (87-1109 cm), it may not be possible to obtain the correct focus. If you have trouble obtaining the correct focus, check the projection distance.

Adjusting the projection angle

- 1 Set up the projector so that it is at right angles to the screen.

Seen from the side

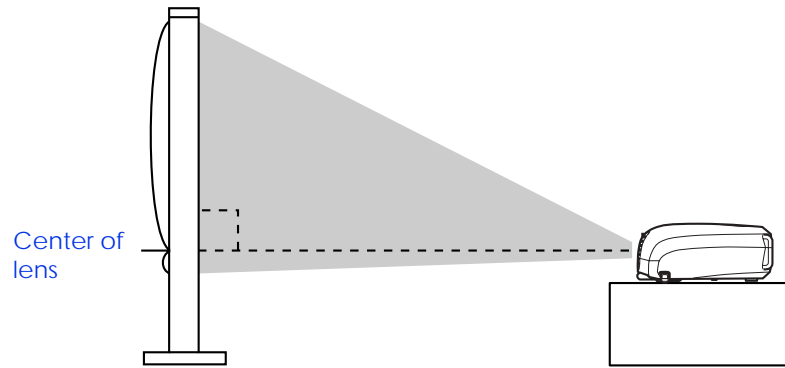

Seen from above

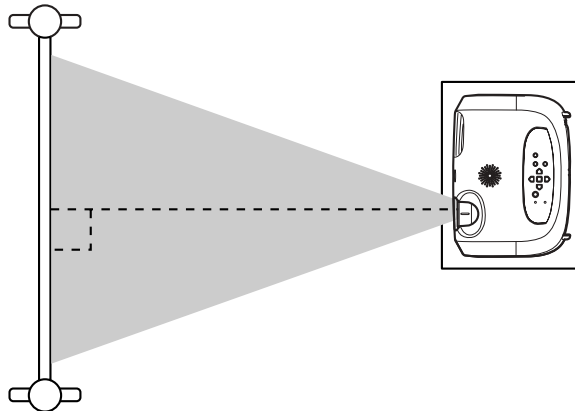

If it is not possible to set up the projector so that it is at right angles to the screen, it can be set up at a slight vertical angle instead. (Max 10°)

- 2 Raise the front of the projector while pressing the buttons on both sides.
- 3 Extend the front feet and release the buttons when the projector is adjusted to the desired height.

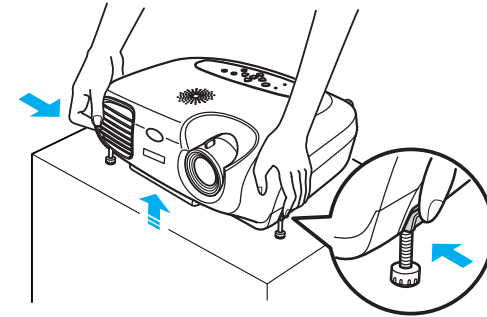

- *The height can be adjusted by turning the base of the front feet on either side.*

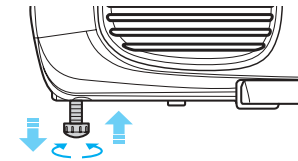

- *Press the front buttons on both sides and slowly lower the projector down to return to its normal position.*

Keystone

When the projector is not set at right angles to the screen, the display distorts in the shape of a trapezoid. This distortion can be corrected.



You can correct only vertical distortion with this function. Horizontal distortion cannot be corrected.

Press the [▲] or [▼] buttons.

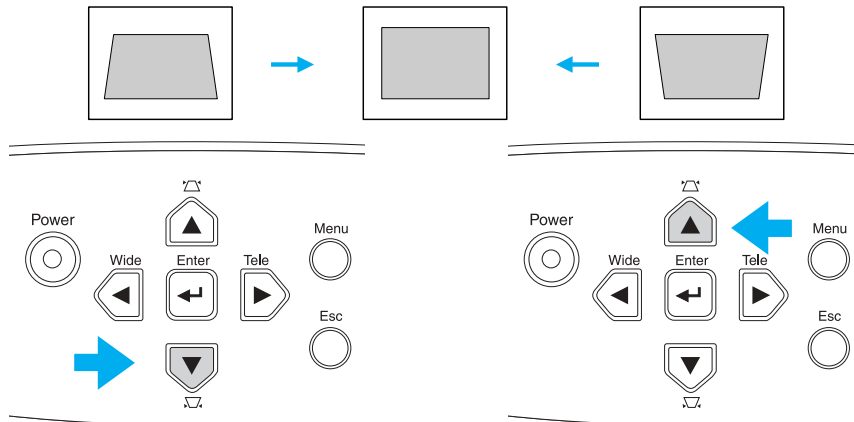

- *Screen size changes when keystone correction is performed.*
- *If the images become uneven in appearance after keystone correction is performed, decrease the sharpness setting. ([Menu] button → “Image” → “Picture Quality” → “Sharpness”) See [“Image menu” on page 36.](#)*

Images can be corrected without distortion when the projector is tilted to a maximum of $\pm 15^\circ$.

Approx. 15° above

Approx. 15° below

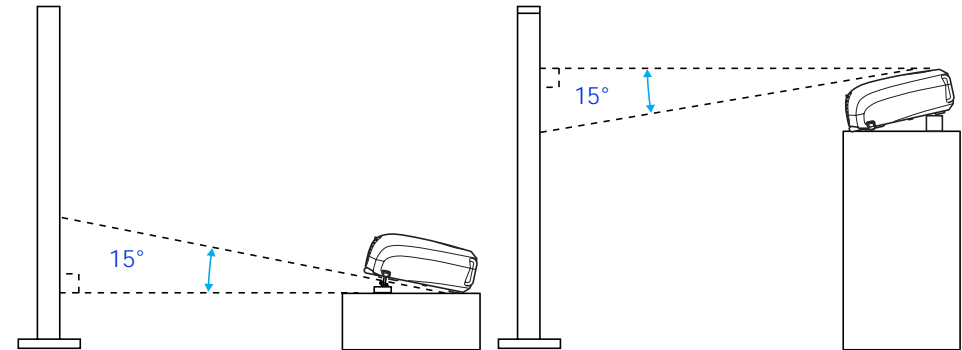

Selecting the Input Source

When a device is connected, projection commences automatically without having to select the input source, however when connected to two or more devices, you need to switch between the input sources.

Projector

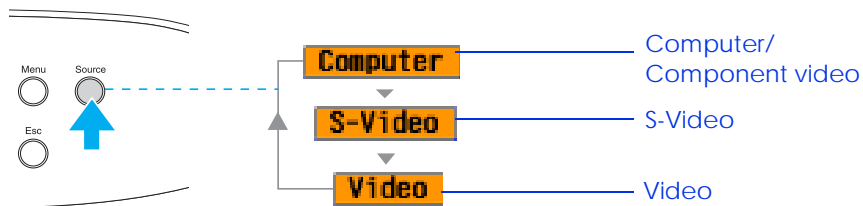

The input source changes each time [Source] is pressed.

The items selected using the “Input signal” command in the “Image” menu are displayed. See [“Image menu” on page 36](#).

- Computer**
- Component Video (YCbCr)**
- Component Video (YPbPr)**

Remote control

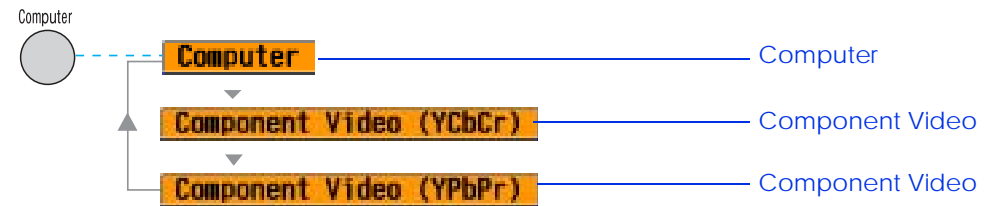
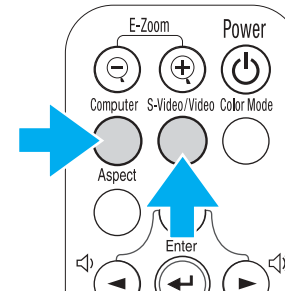

The input source switches between Computer and Component video whenever the [Computer] button is pressed, as shown above.

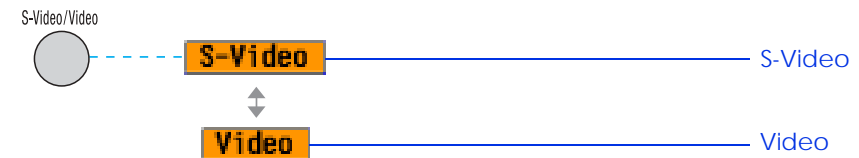

The input source switches between S-Video and Video whenever the [S-Video/Video] button is pressed, as shown above.



If two or more sources are connected, be sure to swap the audio cables between the connected equipment, when necessary.

Advanced Operation

Functions for Enhancing Projection

Adjusting computer generated images

The computer signal is analyzed and the following settings are adjusted to ensure the optimum image quality.

- ▶ [Tracking†](#)
- ▶ Position
- ▶ [Sync.†](#)



You can set Auto setup to off in the “Image” → “Auto Setup” configuration menu. (The default is ON) See [“Image menu” on page 36](#).

When Auto setup is set to off, press the [Auto] button on the remote control to perform auto setup.

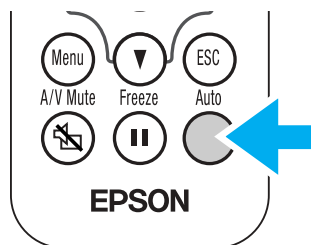

If you press the [Auto] button during E-Zoom or Freeze operation, or when a configuration menu is being displayed, the display will be halted and auto setup will take place.

Adjust the Tracking and Sync settings manually if Auto setup cannot be performed. ([Menu] button → “Image” → “Picture Quality” → “Tracking,” “Sync.”) See [“Image menu” on page 36](#).

Selecting a color mode

There are five present color modes available for use. Make a selection appropriate to the conditions in which you are projecting.

- **Dynamic**

Images are modulated and made crisper to emphasize brightness.

- **Presentation**

Brightness is emphasized. For presentations in bright rooms.

- **Theatre**

Best for watching movies in their natural tones.

- **Living Room**

Brightness is emphasized. Ideal for playing video games in bright rooms.

- **sRGB†**

Conforms to the sRGB color standard. If the connected source has an sRGB mode, set both the projector and the connected source to sRGB.

The color mode changes each time you press the [Color Mode] button on the remote control.

Dynamic → Presentation → Theatre → Living Room → sRGB

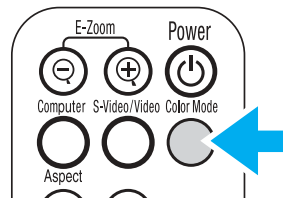

Default Value

- ▶ Computer input: Presentation
- ▶ Other input: Dynamic



You can set the color mode in the “Image” → “Color Mode” configuration menu.
See [“Image menu” on page 36](#).

A/V Mute

Temporarily stops the image and sound.

- ▶ Press the [A/V Mute] button on the remote control. The sound and image disappear.
- ▶ Projection is resumed when you press the [A/V Mute] button again or press the [Esc] button.

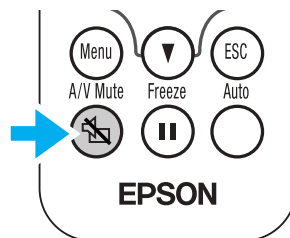

- The screen color during A/V Mute can be set to black or blue. The default setting is blue. ([Menu] button → “Setting” → “Display” → “Background Color”) See [“Setting menu” on page 39](#).
- When activated while projecting moving images, the sound and image will continue to be played back by the source, so it will not be possible to return to the point where A/V Mute was activated.

Freeze

Pauses the projected images.

- ▶ Press the [Freeze] button on the remote control. The projected image freezes.
- ▶ To cancel, press the [Freeze] button again, or press the [Esc] button.

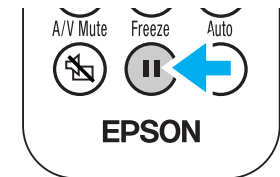

- During Freeze, moving images will continue to be played back by the source, so it will not be possible to return to the point where Freeze was activated.
- Pressing the [Freeze] button also clears configuration menus.

Projecting in widescreen (changing aspect ratio)

This function changes the **Aspect ratio†** of images from 4:3 to 16:9 when component video images (YCbCr and YPbPr) or video images (S-Video or composite video) are being projected. Images which have been recorded in digital video or onto DVDs can be viewed in 16:9 wide-screen format.

Press the [Aspect] button on the remote control to change the screen size as follows:

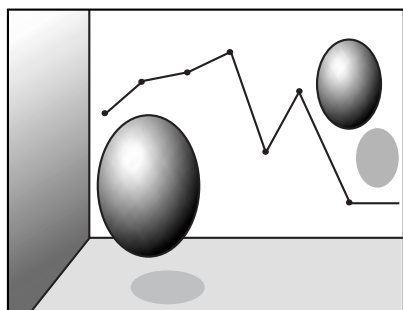
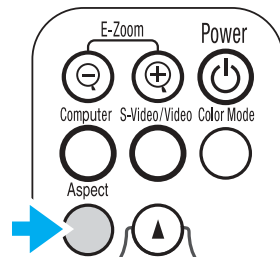

When images in **Squeeze mode†** are projected at 4:3

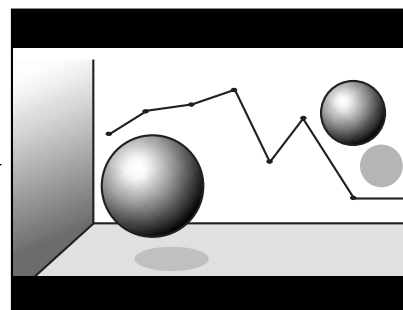

When images in Squeeze mode are projected at 16:9

E-Zoom

The image is enlarged or reduced.

- 1 Press the **[E-Zoom⊕]** button on the remote control.

A target scope is displayed on the screen.

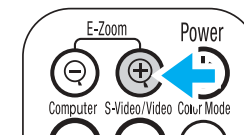

- 2 Press the **[▲][▼][◀][▶]** buttons to move the target scope to the center of the part you wish to enlarge/reduce.

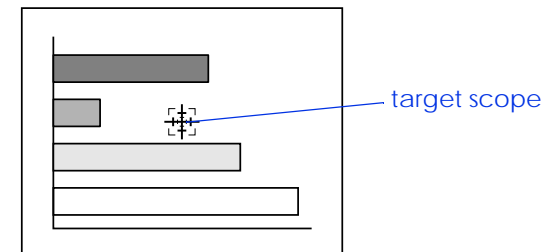

- 3 Push **[E-Zoom⊕]** to enlarge the image. Push **[E-Zoom⊖]** to reduce the enlarged image.

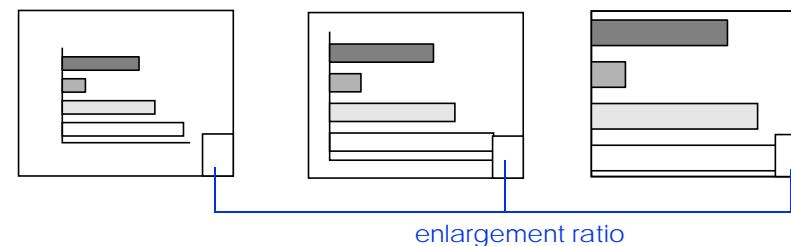

- [E-Zoom⊕]: Enlarges part of the image without changing the size of the projection area.
- [E-Zoom⊖]: Reduces the part of the image that has been enlarged using the [⊕] button.
- You can scroll with the [▲][▼][◀][▶] buttons.
- Press [Esc] to cancel.

Configuration Menus

Various adjustments and settings can be made within the configuration menus. Depending on your video source, some settings may not be available.

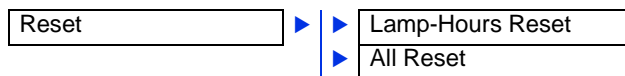
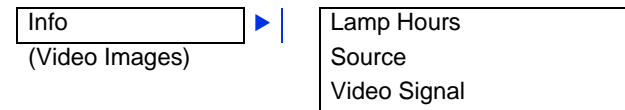
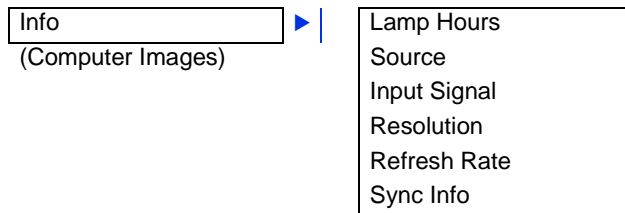
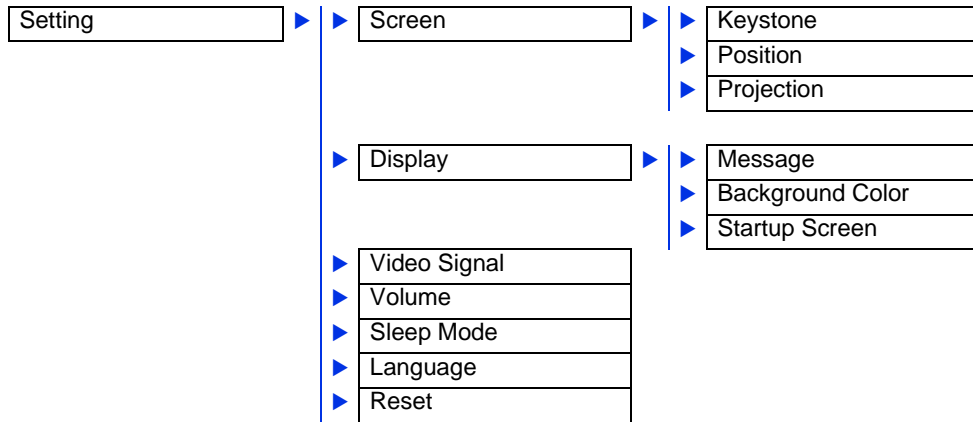
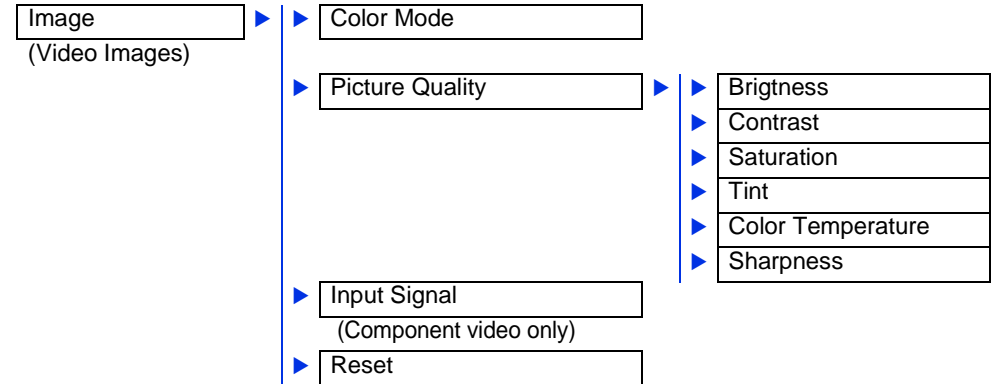
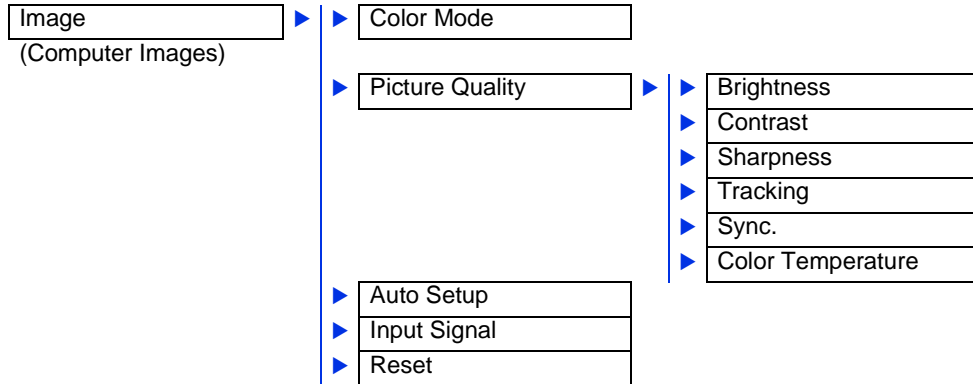

Menu operation

1 Press the [Menu] button

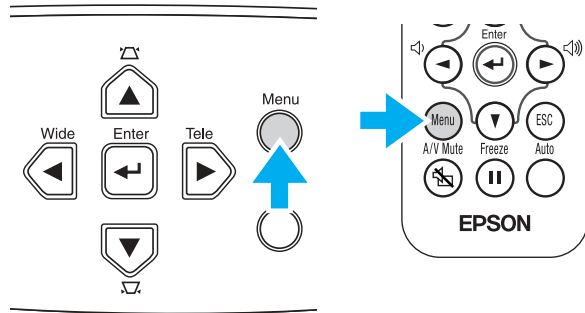

2 Press the [▲] or [▼] buttons to select the Top Menu item.

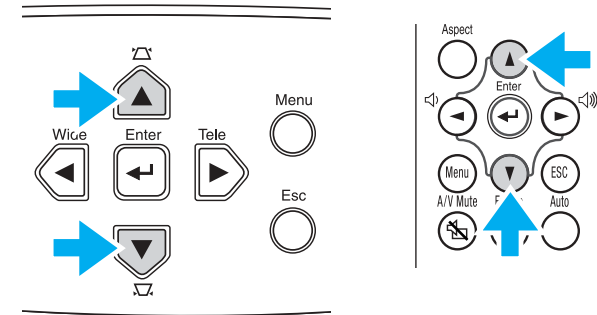

The top configuration menu is displayed.

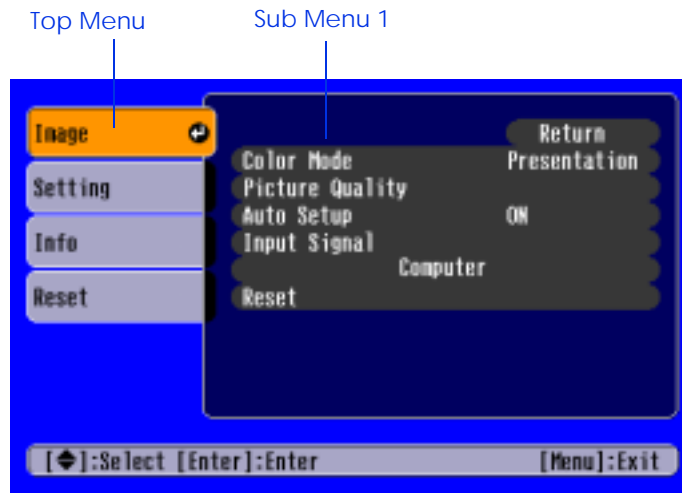

3 Press the [←] button.

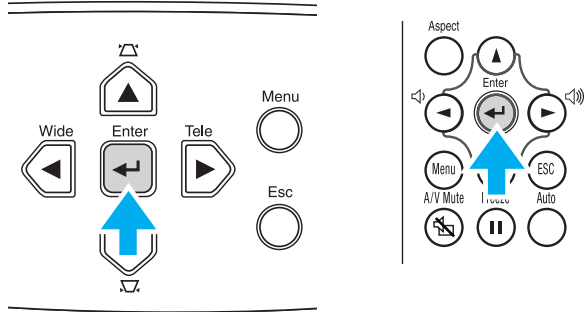

Sub Menu 1 is displayed.



4 Press the [▲] or [▼] buttons to select the Sub Menu 1 items, then press the [←] button.

5 For Sub Menu 2, press the [▲] or [▼] buttons in the same way, then press the [←] button.

6 Settings can be changed in the following ways:

(a) Press the [◀] or [▶] buttons to change the setting values.



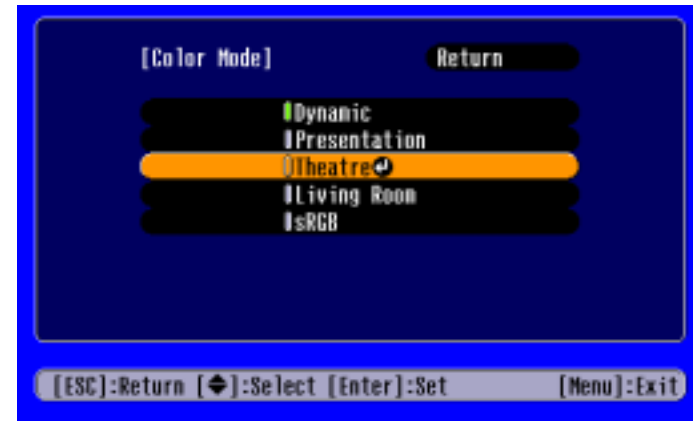

(b) Press the [▲] or [▼] buttons to select the menu item. Then press the [←] button.



 (Green): Item currently set.

 (Orange): Item currently selected.

Press the [←] button to confirm the selection.

 The  mark is displayed after items which perform a setting or lead to a sub menu.

(c) Press the [◀] or [▶] buttons to select the value.
Then, press the [↵] button.



(d) Press the [▲] [▼] [◀] [▶] buttons to move the image display position.



7 Set other items in the same way.

Press the [Esc] button to return to the previous item or menu, or select "Return."

8 Press the [Menu] button to finish.

Function list

Image menu

- When no signal is being input, only the settings for “Auto Setup” and “Input Signal” can be adjusted.
- The functions in the “Image” Menu will be different according to the type of signal which is being input.



Computer images

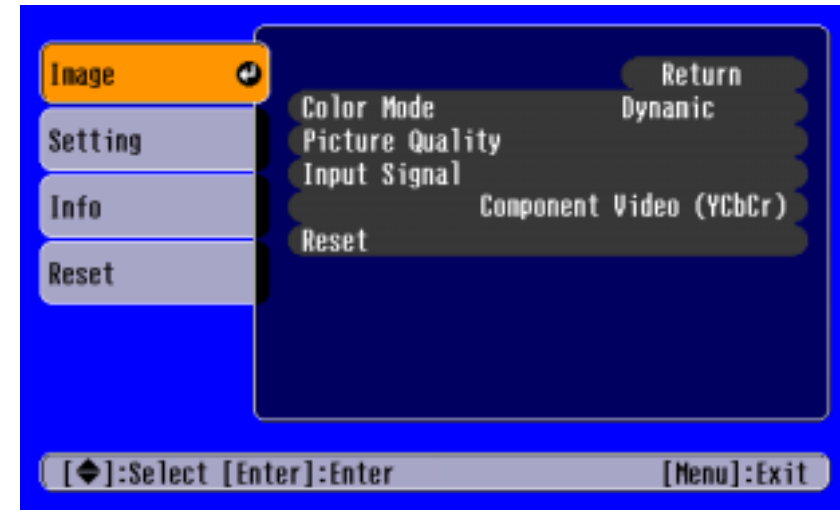

Video images

“Input Signal” only appears on menu screens when component video images are being projected.

Sub menu	Function	
Color Mode	<p>Corrects the vividness of the image color. The settings can be saved separately for each type of source (computer or video).</p> <p>Select from 5 different quality settings depending on the type of scene.</p> <ul style="list-style-type: none"> ▶ Dynamic: Images are modulated and made crisper to emphasize brightness. ▶ Presentation: Brightness is emphasized. For presentations in bright rooms. ▶ Theatre: Best for watching movies in their natural tones. ▶ Living Room: Brightness is emphasized. Ideal for playing video games in bright rooms. ▶ sRGB†: Conforms to the sRGB color standard. If the connected source has an sRGB mode, set both the projector and connected source to sRGB. 	
Picture Quality	Brightness	Adjusts the brightness of the image.
	Contrast†	Adjusts the contrast of the image.
	Sharpness	Adjusts the sharpness of the image.
	Tracking† (Computer images only)	Adjusts the image when vertical stripes appear in the image.

Sub menu	Function
Picture Quality (Computer images only)	<p>Sync. †</p> <p>Adjusts the image when flickering, fuzziness or interference occur in the image. Flickering and fuzziness may also occur when the brightness, contrast, sharpness or keystone correction settings are adjusted. Best results can be obtained by adjusting the tracking before the sync.</p> <hr/> <p>Color Temperature †</p> <p>Adjusts bright colors from a reddish tinge to a bluish tinge. Lower color temperature settings produce redder colors and softer color tones. Higher color temperature settings produce bluer colors and sharper color tones. Press the [←] button and make a setting from the color adjustment menu which is displayed.</p> <hr/> <p>Saturation (Video images only)</p> <p>Adjusts the color depth</p> <hr/> <p>Tint (Video images only)</p> <p>(Adjustment is only possible when Component Video † or NTSC signals are being input)</p> <p>Adjusts the tint of the image.</p>
Auto Setup (Computer images only)	<p>ON: When the input source is switched to a computer signal, the projector automatically adjusts the image to its optimal state.</p> <p>OFF: Auto Setup is disabled.</p>
Input Signal (Computer/component video images only)	<p>Select the type of image signal connected to the Computer/Component Video port.</p> <p>Computer: computer images</p> <p>Component Video (YCbCr): DVD images</p> <p>Component Video (YPbPr): HDTV images</p>
Reset	<p>Resets all the adjustment values within the “Image” menu (except for “Input Signal”) to their default settings. Press the [←] button and select “Yes” on the confirmation screen which is displayed.</p> <p>Select “All Reset” to restore all menu settings, such as image and sound, to their default settings. See “Reset menu” on page 42.</p>

Setting menu



Sub menu		Function
Screen	Keystone	<p>Corrects vertical keystone distortion in the image.</p> <p>The projected image changes when keystone correction is carried out.</p> <p>If the images become uneven in appearance after keystone correction has been carried out, decrease the sharpness setting.</p>
	Position	<p>Moves the image display position vertically and horizontally.</p> <p>Press the [←] button and adjust the display area on the Position adjustment screen which is displayed.</p>
	Projection	<p>Front Image is displayed, as is. No vertical/horizontal reversal performed.</p> <p>Front/Ceiling The image is displayed vertically reversed.</p> <p>Rear The image is displayed horizontally reversed.</p> <p>Rear/Ceiling The image is displayed vertically and horizontally reversed.</p>

Sub menu		Function
Display	Message	When set to “off,” messages such as “No signal,” and the name of the selected input source or color mode will no longer be displayed. Warning messages such as “Replace the lamp” will continue to be displayed.
	Background Color	Sets the background color to black or blue.
	Startup Screen	Sets whether or not the EPSON logo will be displayed during projector startup.
Video Signal		Selects the format of the video signal being input. (Changes in signal format will only be noticeable when the input source is Video/S-Video.)
Volume		Adjusts the volume setting
Sleep Mode		<p>Sets the energy saving option for when no signal is being input.</p> <ul style="list-style-type: none"> • When a Sleep Mode interval has been set, the projector will enter Sleep Mode when no operation has been carried out for the set time (5, 10 and 30 minutes). Projection will shut down and the projector enters a standby state after cooling down. (The power indicator lights orange). • Projection starts again when the [Power] button is pressed on the projector's control panel or the remote control.
Language		<p>Selects the language in which on-screen messages are displayed.</p> <ul style="list-style-type: none"> • Press the [←] button and select the desired language from the list which is displayed.
Reset		<p>Resets all the adjustment values within the “Setting” menu (except for “Language”) to their default settings.</p> <ul style="list-style-type: none"> • Press the [←] button and select “Yes” on the confirmation screen which is displayed.

Info menu

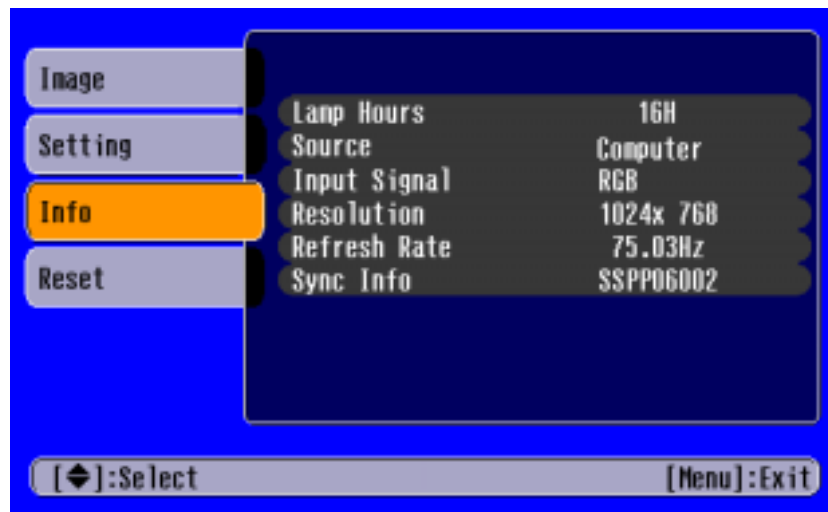

Computer images

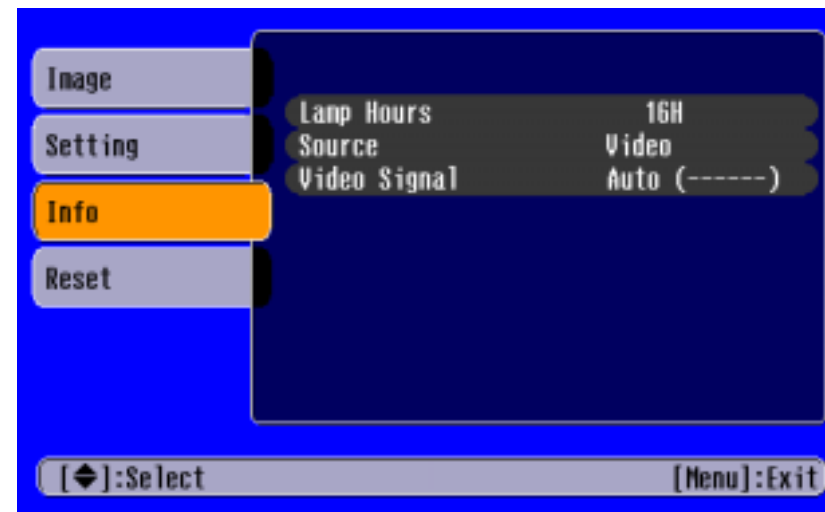

Video images

Sub menu	Function
Lamp Hours	Displays the cumulative lamp operating time. When the accumulated usage time of the lamp reaches about 1900 hours, a warning will be displayed in red.
Source	Displays the input source being projected.
Input Signal (Computer images only)	Displays the input signal settings.
Video Signal (Video images only)	Displays the Video signal format.
Resolution (Computer images only)	Displays the input resolution. (Does not appear when the input source is composite video or S-Video.)
Refresh Rate† (Computer images only)	Displays the refresh rate (Does not appear when the input source is composite video or S-Video.)
Sync Info (Computer images only)	Displays picture signal information. In the event that you are having problems with your projector and need to contact EPSON, please quote the information displayed on this screen.

Reset menu

Sub menu	Function
Lamp-Hours Reset	Resets the lamp operating time. When this command is selected, the cumulative lamp operating time is reset to the default value.
All Reset	Resets all items in the configuration menus to their default settings. <ul style="list-style-type: none"> • Press the [←] button and select “Yes” on the confirmation screen which is displayed. • Select “Reset” in an individual menu to reset only the settings for the items in that sub menu. • “Input Signal,” “Language” and “Lamp Hours” settings will not be reset.

Troubleshooting

When You Suspect a Problem

First, check the indicators on the projector. There are two indicators on the projector unit which notify you of projector conditions.

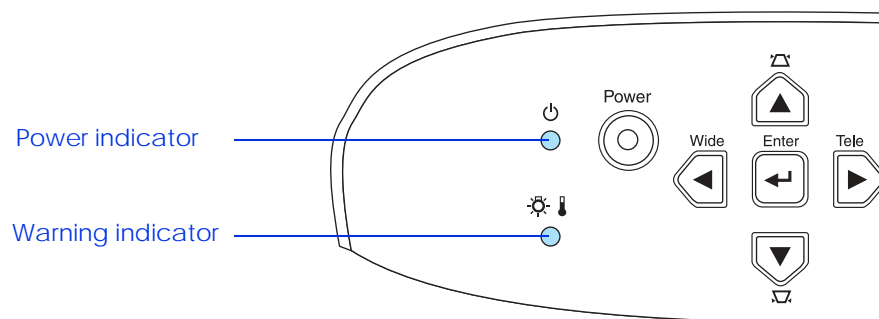





Power indicator

- lit ☀ flashing
- If the indicator is not lit, the power supply is not on.

Condition	Cause/Remedy	
Orange ●	Standby state The power cable should only be disconnected when the projector is in this state. Press the [Power] button to start projection.	P.22
Orange ☀	Cool-down in progress <ul style="list-style-type: none"> • Please wait. The cool-down period lasts about 20 seconds. • You cannot operate the [Power] button during the cool-down period. Press the power button again after cool-down has finished. 	P.22
Green ●	Projection in progress	P.22
Green ☀	Warming-up Please wait. Warming up takes about 35 seconds (the EPSON logo appears after approximately 6 seconds). When warming up is complete, the indicator changes to steady green.	P.22

Warning indicator

- lit  flashing
- Lit under normal operating conditions.

Condition	Cause/Remedy	
Red 	High internal temperature (overheating) The lamp turns off automatically and projection stops. Wait for about 5 minutes without operating the projector. After about 5 minutes have passed, unplug the power cable and check the following: <ul style="list-style-type: none"> • Make sure the air filter and ventilation outlet are clear and that the projector is not positioned against a wall. • If the air filter is dirty, it should be cleaned. When the power cable is plugged back in, the projector will return to its previous state. Press the [Power] button on the projector or on the remote control to turn it back on.	P.12 P.54
Red  (0.5 second interval)	Lamp problem <ul style="list-style-type: none"> • Disconnect the power cable from the electrical outlet. Remove the lamp and check that it is not broken. If the lamp is not broken, re-install it. Reconnect the power cable and press the [Power] button on the projector or the remote control to turn it back on. • If the lamp is broken, please contact your dealer or see Where to Get Help to contact EPSON. (You will not be able to use the projector until the lamp is replaced). • Check that the lamp and lamp cover are securely installed. If the lamp or lamp cover are not securely installed, the lamp will not switch on. 	P.54
Red  (1 second interval)	Internal problem Stop using the projector, disconnect the power cable from the electrical outlet and contact your dealer or see Where to Get Help to contact EPSON.	
Orange 	High-speed cooling in progress (This is not abnormal, but, if the temperature rises too high again, projection will stop automatically.) Set up the projector in a place which is well ventilated and ensure the air filter and ventilation outlet are clear. Clean the air filter.	P.12 P.54

-  • If problems with projection do occur, but the indicators do not show any abnormal conditions, please refer to the section “When the indicators provide no help” on the next page.
- If a condition occurs which is not listed in this table, please consult your dealer or see [Where to Get Help](#) to contact EPSON.
- If you follow the above steps and are still unable to correct the problem, please cease using the projector, unplug the projector from the electrical outlet and request repairs from your dealer or see [Where to Get Help](#) to contact EPSON.

When the indicators provide no help

- No images appear (Nothing is displayed) [page 45](#)
- No images appear (Messages are displayed 1) [page 46](#)
- No images appear (Messages are displayed 2) [page 46](#)
- Image is out of focus (unclear) [page 47](#)
- Vertical stripes appear in the image [page 48](#)

- Image is distorted / Image contains interference [page 48](#)
- Only part of the image is displayed (large/small) [page 49](#)
- Image colors are poor, tinted green or tinted red/purple [page 50](#)
- Image is dark [page 51](#)
- No sound can be heard [page 51](#)
- The remote control does not work [page 52](#)
- The power does not turn off (after the [Power] button is pressed) [page 52](#)

No images appear (Nothing is displayed)

	• Was the power turned off and then straight back on again?	After the power has been switched off and the projector is in cool-down mode, the [Power] button will not work.
	• Has a Sleep Mode interval (5, 10 or 30 minutes) been set?	When a Sleep Mode interval has been set, the lamp cuts out after no operations have been carried out for the set time (5, 10 or 30 minutes). The power indicator lights orange at this time. ([Menu] button → “Setting” → “Sleep Mode”) See “Setting menu” on page 39 .
	• Has the image brightness been adjusted correctly? ([Menu] button → “Image” → “Picture Quality” → “Brightness”)	See “Image menu” on page 36 .
	• Is the projected image completely black?	Some images being displayed, including some screen savers, may be completely black.
	• Is A/V Mute activated?	See “A/V Mute” on page 30 .
	• Have you pressed the [Power] button?	See “Turning on the Projector” on page 22 .
	• Try resetting all of the current settings.	See “Reset menu” on page 42 .
	• Is an image signal being input?	Check if a picture signal is being input. Set the “Message” option to “ON” in the “Setting” → “Display” → “Message” configuration menu, in order to view the picture signal information. See “Setting menu” on page 39 .

No images appear (Messages are displayed 1)

	<ul style="list-style-type: none"> • Check the mode which corresponds to the frequency of the image signals being output from the computer. 	<p>Refer to the documentation provided with your computer for details on changing the resolution and frequency of the image signals being output from the computer. See “Supported Display Resolutions” on page 64.</p>
“Not supported”		

No images appear (Messages are displayed 2)

	<ul style="list-style-type: none"> • Has external video output been selected on the computer? 	<p>When using a notebook or a PC with a built-in monitor, select external video output on the computer. See “Notebook connection” on page 14.</p>
“No signal”	<ul style="list-style-type: none"> • Is the input source properly selected? 	<p>Press the [Source] button on the Control panel until the correct input source is selected. For the remote control, press the [Computer] button or the [S-Video/Video] button. See “Selecting the Input Source” on page 28.</p>
	<ul style="list-style-type: none"> • Are the cables connected properly? 	<p>See “Connecting to a Computer” on page 14, “Connecting to Video Equipment” P.20.</p>
	<ul style="list-style-type: none"> • Is the power for the connected computer or video source switched on? 	<p>See “Turning on the Projector” on page 22.</p>

Image is out of focus (unclear)

- The image is fuzzy
- Part of the image is out of focus
- The whole image is out of focus

<ul style="list-style-type: none"> • Have the “Sync.†,” “Tracking†” and “Position” settings been adjusted correctly? 	<p>If the configuration menu “Image” → “Auto Setup” setting has been set to “OFF,” press the [Auto] button on the remote control to adjust these settings. If the images have not been correctly adjusted after pressing the [Auto] button and using the auto setup function, adjust the settings manually in their respective menus. ([Menu] button → “Image” → “Picture Quality” → “Tracking,” “Image” → “Picture Quality” → “Sync.,” “Setting” → “Screen” → “Position”) See “Image menu” on page 36, “Setting menu” P.39.</p>
<ul style="list-style-type: none"> • Are the image signal format settings correct? 	<ul style="list-style-type: none"> • When a computer or Component Video† device is connected, select the appropriate setting for the input source you are using, in the “Image” → “Input Signal” configuration menu. • When a Composite Video† or S-Video† device is connected, select the appropriate setting for the video system you are using in the “Setting” → “Video Signal” configuration menu.
<ul style="list-style-type: none"> • Is the projector positioned at right angles to the screen? 	<p>See “Installation method” on page 12.</p>
<ul style="list-style-type: none"> • Is the projector at the correct distance from the screen? 	<p>The optimum range for projection is 2.9-36.4 feet (87-1109 cm). Set the projector within this range. See “Installation method” on page 12.</p>
<ul style="list-style-type: none"> • Are the front feet set so that the image angle is too big for the screen? 	<p>If the image angle is too big the image will be out of focus vertically. See “Adjusting the projection angle” on page 26.</p>
<ul style="list-style-type: none"> • Is the lens dirty? 	<p>See “Cleaning the lens” on page 54.</p>
<ul style="list-style-type: none"> • Has condensation formed on the lens? 	<p>If the projector is suddenly taken from a cold environment to a warm environment, condensation may form on the surface of the lens, and this may cause the images to appear fuzzy. Set the projector up in the room in which it is to be used approximately one hour before use. If condensation forms on the lens, turn off the power and wait for the condensation to disappear.</p>
<ul style="list-style-type: none"> • Has the focus been correctly adjusted? 	<p>See “Adjusting the Display” on page 25.</p>
<ul style="list-style-type: none"> • Is the lens cover still in place? 	<p>See “Turning on the Projector” on page 22.</p>

Vertical stripes appear in the image

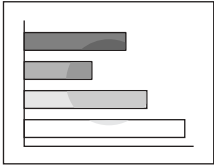
	<ul style="list-style-type: none"> • Has the “Tracking†” setting been adjusted? 	<p>Set the tracking value until the vertical stripes disappear. ([Menu] button → “Image” → “Picture Quality” → “Tracking”) See “Image menu” on page 36.</p>
---	--	---

Image is distorted / Image contains interference

	<ul style="list-style-type: none"> • Have the “Sync.†”, “Tracking†” and “Position” settings been adjusted correctly? 	<p>If the configuration menu “Image” → “Auto Setup” setting has been set to “OFF”, press the [Auto] button on the remote control to adjust these settings. If the images have not been correctly adjusted after pressing the [Auto] button and using the automatic setup function, adjust the settings manually in their respective menus. ([Menu] button → “Image” → “Picture Quality” → “Sync.”) See “Image menu” on page 36.</p>
	<ul style="list-style-type: none"> • Are the image signal format settings correct? 	<ul style="list-style-type: none"> • When a computer or Component Video† device is connected, select the appropriate setting for the input source you are using, in the “Image” → “Input Signal” configuration menu. • When a Composite Video† or S-Video† device is connected, select the appropriate setting for the video system you are using in the “Setting” → “Video Signal” configuration menu.
	<ul style="list-style-type: none"> • Has the correct resolution been selected? 	<p>Set the computer so that the signals that are output are compatible with this projector. Refer to your computer’s documentation for further details. See “Supported Display Resolutions” on page 64.</p>
	<ul style="list-style-type: none"> • Is an extension cable being used? 	<p>If using an extension cable, electrical interference may affect the signals. Confirm that you are using a shielded cable.</p>
	<ul style="list-style-type: none"> • Are the cables connected correctly? 	<p>See “Connecting to a Computer” on page 14, “Connecting to Video Equipment” P.20.</p>

Only part of the image is displayed (large/small)

	<ul style="list-style-type: none"> • Change the resolution for the notebook computer or computer with an LCD screen. 	<p>Change the resolution so that the image is displayed in the whole of the projection area, or set the image signal to external output only. See “Selecting the Input Source” on page 28.</p>
	<ul style="list-style-type: none"> • Is the aspect ratio set correctly? 	<p>Press the [Aspect] button to set the aspect ratio to 4:3. See “Projecting in widescreen (changing aspect ratio)” on page 31.</p>
	<ul style="list-style-type: none"> • Has the computer been set for dual display? 	<p>If dual display has been activated in the Display Properties of the connected computer's Control Panel, the projector will only display about half of the image on the computer screen. To display the whole of the image on the computer screen, turn off the dual display setting. Refer to the video driver manual for the computer's monitor for further details.</p>
	<ul style="list-style-type: none"> • Has the correct resolution been selected? 	<p>Set the computer so that the signals that are output are compatible with this projector. Please refer to your computer's documentation for further details. See “Supported Display Resolutions” on page 64.</p>
	<ul style="list-style-type: none"> • Has the position been adjusted correctly? 	<p>Use the “Setting” → “Screen” → “Position” configuration menu to correctly adjust the display position. See “Setting menu” on page 39.</p>
	<ul style="list-style-type: none"> • Is the E-Zoom function being used to enlarge the image? 	<p>Press the [Esc] button on the remote control to cancel E-Zoom. See “E-Zoom” on page 31.</p>

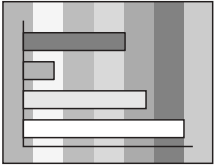
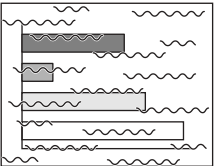
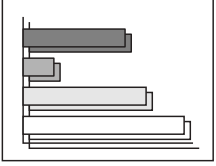
Image colors are poor, tinted green or tinted red/purple

<ul style="list-style-type: none"> • Are the image signal format settings correct? 	<p>If a component video device is connected and “Computer” is set as the “Image” → “Input Signal” configuration menu setting, the projected images will appear greenish. If a computer is connected and either “Component Video (YPbPr†)” or “Component Video (YCbCr†)” is set as the “Image” → “Input Signal” configuration menu setting, the projected images will appear red/purplish. Please select the appropriate setting for the equipment you are using. ([Menu] button → “Image” → “Input Signal”) See “Image menu” on page 36.</p>
<ul style="list-style-type: none"> • Does the lamp need replacement? 	<p>When the lamp is due for replacement, colors will weaken and the image will become dark. Replace the lamp when this is the case. See “Lamp replacement period” on page 56.</p>
<ul style="list-style-type: none"> • Has the image contrast been adjusted correctly? ([Menu] button → “Image” → “Picture Quality” → “Contrast”) 	<p>See “Image menu” on page 36.</p>
<ul style="list-style-type: none"> • Has the color been adjusted correctly? ([Menu] button → “Image” → “Picture Quality” → “Color Temperature”) 	<p>See “Image menu” on page 36.</p>
<ul style="list-style-type: none"> • Has the saturation and tint been adjusted correctly? ([Menu] button → “Image” → “Picture Quality” → “Saturation,” “Tint”) 	<p>See “Image menu” on page 36.</p>
<ul style="list-style-type: none"> • Has the image brightness been adjusted correctly? ([Menu] button → “Image” → “Picture Quality” → “Brightness”) 	<p>See “Image menu” on page 36.</p>
<ul style="list-style-type: none"> • Are the cables connected correctly? 	<p>See “Connecting to a Computer” on page 14, “Connecting to Video Equipment” P.20.</p>
<ul style="list-style-type: none"> • When connecting to a computer 	<p>Colors may not exactly match those displayed on the computer screen or LCD screen, but this is normal and is not the sign of a problem.</p>

Image is dark

	<ul style="list-style-type: none"> Does the lamp need replacement? 	When the lamp is due for replacement, colors will weaken and the image will become dark. Replace the lamp when this is the case. See "Lamp replacement period" on page 56.
	<ul style="list-style-type: none"> Has the image brightness been adjusted correctly? ([Menu] button → "Image" → "Picture Quality" → "Brightness") 	See "Image menu" on page 36.
	<ul style="list-style-type: none"> Has the image contrast been adjusted correctly? ([Menu] button → "Image" → "Picture Quality" → "Contrast") 	See "Image menu" on page 36.

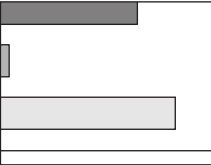
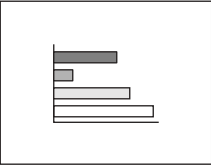
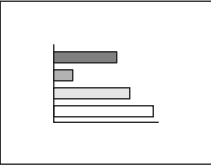
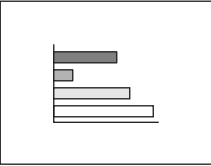
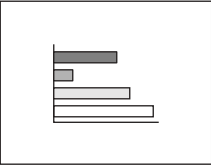
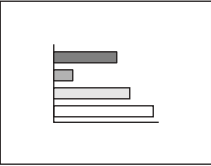
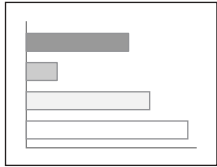
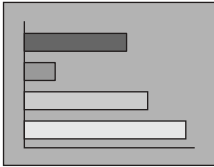
No sound can be heard

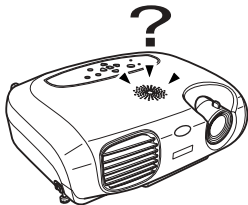
	<ul style="list-style-type: none"> Is A/V Mute activated? 	The projector may be in A/V Mute mode. Press the [A/V Mute] button on the remote control to cancel A/V Mute. See "A/V Mute" on page 30.
	<ul style="list-style-type: none"> Is the volume turned down to the minimum setting? ([Menu] button → "Setting" → "Volume") 	See "Setting menu" on page 39.
	<ul style="list-style-type: none"> Is the audio source connected correctly? 	See "Playing sound from a computer" on page 15, "Playing sound from video equipment" P.21.

The remote control does not work

	<ul style="list-style-type: none"> • Is direct sunlight or strong light from fluorescent lamps shining onto the remote control infrared receiver? 	See “Using the Remote Control” on page 11.
	<ul style="list-style-type: none"> • Is the remote control too far from the projector? 	The operating distance for the remote control is approximately 20 feet (6 m). See “Operating range” on page 11.
	<ul style="list-style-type: none"> • When in use, is the remote control infrared transmitter facing the remote control infrared receiver on the projector? 	The operating angle for the remote control is approximately $\pm 30\frac{1}{2}^\circ$ horizontally and approximately $\pm 15\frac{1}{2}^\circ$ vertically. See “Operating range” on page 11.
	<ul style="list-style-type: none"> • Has the battery insulating tape been removed? 	See “Before using the Remote Control” on page 11.
	<ul style="list-style-type: none"> • Is the battery dead? 	See “Changing the battery (Remote Control, Presentation Remote Control)” on page 56.
	<ul style="list-style-type: none"> • Is the battery inserted correctly? 	
<ul style="list-style-type: none"> • Is the battery installed? 		

The power does not turn off (after the [Power] button is pressed)

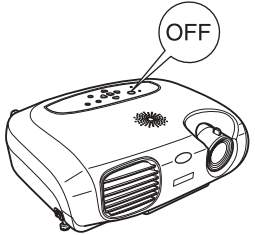
	<ul style="list-style-type: none"> • The power indicator remains orange. 	This projector is designed so that the Power indicator remains lit even after the power has been turned off. The Power indicator will switch off when the power cable is disconnected from the electrical outlet.
	<ul style="list-style-type: none"> • The cooling fan does not stop. 	After the [Power] button has been pressed, the cool-down period begins. After this, the Power indicator changes to a steady orange, and you can then disconnect the power cable from the electrical outlet. Cool-down lasts for about 20 seconds.

Where to Get Help

EPSON provides technical assistance through electronic support services 24 hours a day, as listed in the following table.

Service	Access
World Wide Web	From the Internet, you can reach EPSON's product support page at http://support.epson.com . After selecting your product, you can access troubleshooting information, download product documentation, and receive technical advice through FAQs and e-mail.
Presenters Online	Access tips, templates, and training for developing successful presentations at http://www.presentersonline.com

Telephone Support Services

To use the EPSON PrivateLine Support service, call (800) 637-7661 and enter the PIN on the included EPSON PrivateLine Support card. This is the fastest way of speaking to a live representative, and it's free. This service is available 6 AM to 6 PM, Pacific Time, Monday through Friday, for the duration of your warranty period.

You may also speak with a projector support specialist by dialing one of these numbers:

- U.S.: (562) 276-4394, 6 AM to 6 PM, Pacific Time, Monday through Friday
- Canada: (905) 709-3839, 6 AM to 6 PM, Pacific Time, Monday through Friday

Toll or long distance charges may apply.

Before you call, please have the following information ready:

- Product name (EPSON PowerLite S1)
- Product serial number (located on the bottom of the projector)
- Computer or video configuration
- Description of the problem

You can purchase screens, carrying cases, or other accessories from EPSON at (800) 873-7766 or by visiting the EPSON Store at www.epsonstore.com (U.S. sales only). In Canada, please call (800) 463-7766 for dealer referral.

Appendix

Projector Care

Be sure to read the [Important Safety Instructions](#) before proceeding.

Cleaning

You should clean the projector if it becomes dirty or if the projected image starts to deteriorate.

Cleaning the projector case

Clean the projector case by wiping it gently with a soft cloth.

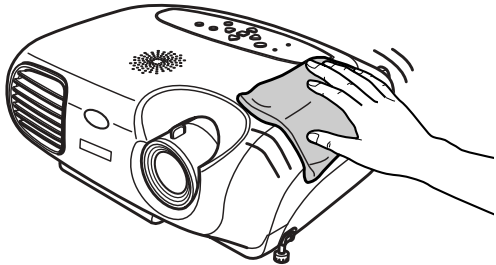

If the projector is particularly dirty, moisten the cloth with water containing a small amount of (ph) neutral detergent, and then firmly wring the cloth dry before using it to wipe the projector case. After you have done this, wipe the projector again with a soft, dry cloth.

! *Do not use volatile substances such as wax, alcohol or thinner to clean the projector case. These can cause the case to warp and make the surface coating peel off.*

Cleaning the lens

Use a commercially-available air blower, or lens cleaning paper to gently wipe the lens.

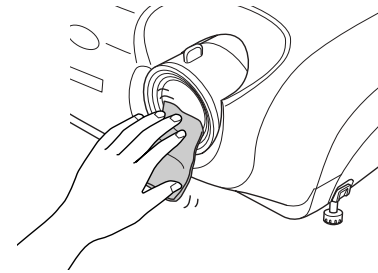

! *As the lens can be easily damaged, do not rub the lens with harsh materials or subject the lens to shocks.*

Cleaning the air filter

If the air filter becomes clogged with dust, it can cause overheating and damage the projector. Keeping the projector horizontal, use a vacuum cleaner to clean away the dust from the air filter.

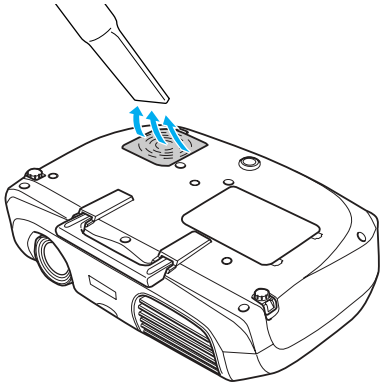

- *If the air filter is difficult to clean or if it is broken, it should be replaced. See [Replacing the air filter](#) for instructions. See [Optional Accessories](#) for information on purchasing additional air filters.*
 - *Spare lamps are provided with new air filters. When replacing the lamp, please replace the air filter at the same time.*
-

Replacing consumables

Changing the battery (Remote Control, Presentation Remote Control)

Replacement battery: 1 × CR2025 lithium battery

! *Keep batteries away from children to avoid the risk of accidents. If a child swallows the battery, contact your doctor immediately.*

1 Remove the battery holder.

While pressing the catch of the battery holder inwards, pull the battery holder out.

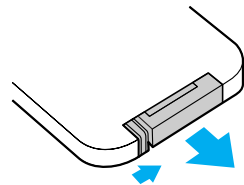

2 Remove the old battery and insert the new one.

Check the position of the (+) mark inside the battery holder to ensure that the battery is inserted the correct way.

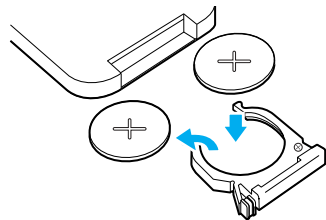

3 Replace the battery holder.

Press the battery holder in until it clicks.

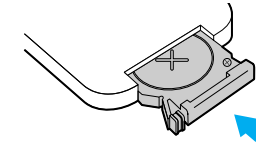

! *Please dispose of used batteries in accordance with local waste disposal regulations.*

Lamp replacement period

- It is time to change the lamp when the “Replace Lamp” message appears in the bottom left hand corner of the screen at the commencement of projection and remains for 30 seconds.
- It is also time to change the lamp when the Warning indicator flashes red at 0.5 second intervals.

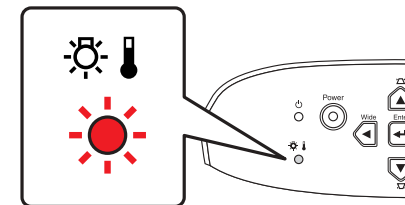

- !** *The replacement message will appear after about 1900 hours of use. Lamp life will vary depending on the mode selected, environmental conditions, and usage.*
- When this message is displayed, please replace the lamp as quickly as possible.*
- The lamp may explode if you continue to use it beyond the lamp replacement period.*
- Some lamps may stop operating before the replacement message is displayed. It is recommended that you have a replacement lamp ready in case this happens.*
- Replacement lamps can be purchased at your nearest dealer.*

Replacing the lamp



- Wait until the lamp has cooled down sufficiently before opening the lamp cover. It takes one hour after the projector's cool-down period has finished for the lamp to be cool enough.
- When the lamp is broken, replace it with a new lamp, or contact your dealer for further advice. If replacing the lamp yourself, be careful to avoid pieces of broken glass.

- 1 Turn off the projector and wait for the cool-down period to end. (Approximately 20 seconds)
- 2 Unplug the power cable and remove it, then wait for the lamp to cool down. (Approximately 1 hour)

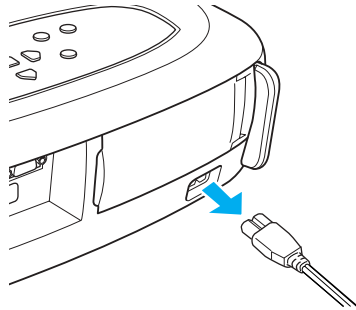

- 3 Open the lamp cover.

Push in the tabs on the lamp cover and push it up to remove it.

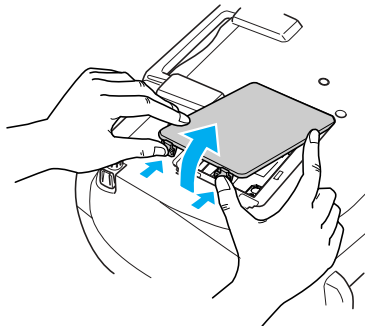

- 4 Loosen the screws holding the lamp in place.

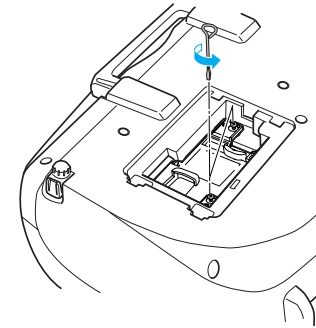

- 5 Remove the old lamp.

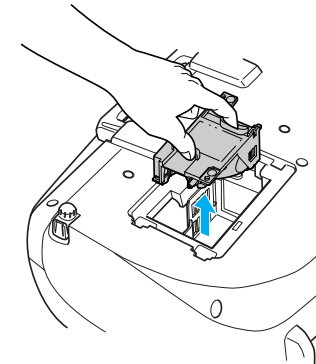

- 6 Install the new lamp.

Press the lamp until it clicks into place, then tighten the two screws.

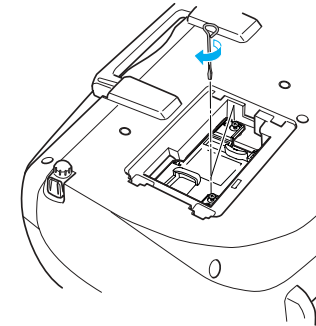

7 Replace the lamp cover.

First insert the tabs, and then press down on the opposite side until it clicks into place.

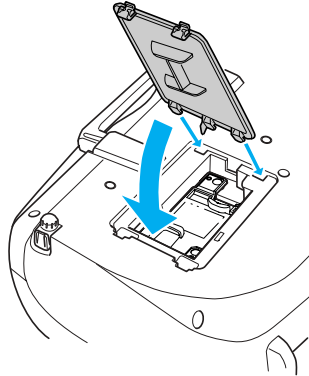

- **Install the lamp securely. If the lamp cover is removed, the lamp turns off automatically as a safety precaution. The lamp will not turn on if the lamp or the lamp cover is not installed correctly.**
- **After replacing the lamp, be sure to reset the lamp operating time.**
- **New air filters are included with replacement lamps. The air filter should also be replaced when the lamp is replaced. See [“Lamp replacement period”](#) on page 56.**
- **Dispose of used lamps properly in accordance with your local regulations.**

Resetting the lamp operating time

The projector has a built-in counter which keeps track of the lamp operating time and causes the replacement warning message to be displayed when the cumulative operating time reaches a certain point. Therefore, the counter needs to be reset from the configuration menu, after the lamp has been replaced with a new one.



Please do not reset the lamp operating time except when the lamp has been changed. Otherwise, the lamp operating time will not be displayed correctly.

1 Turn on the power and press the [Menu] button.

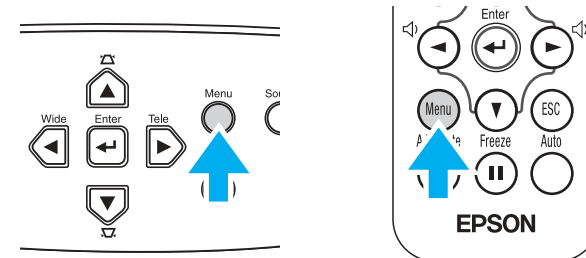

2 Select “Lamp Hours Reset” from the “Reset” menu, using the [▲][▼][←] buttons.

- 3 Use the [◀][▶] buttons to select “Yes,” then press the [↵] button.

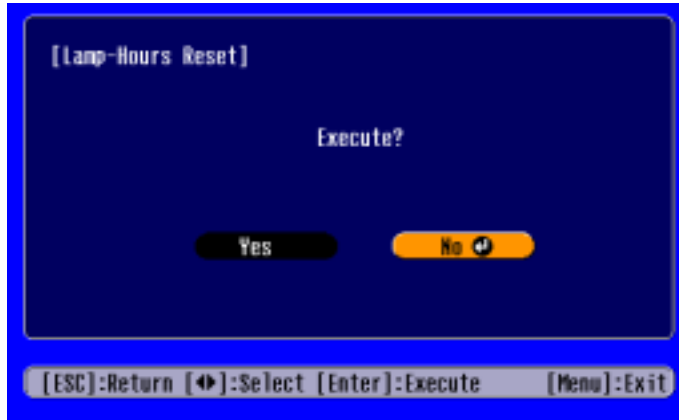

The lamp operating time will be reset.

Replacing the air filter

Replacing the air filter can also be performed when the projector is mounted to a ceiling.

- 1 Turn off the projector power, wait for the cool-down period to end, then disconnect the power cable.
Cool-down takes about 20 seconds.
- 2 Push in the tab on the air filter cover and lift up the air filter cover to remove it.

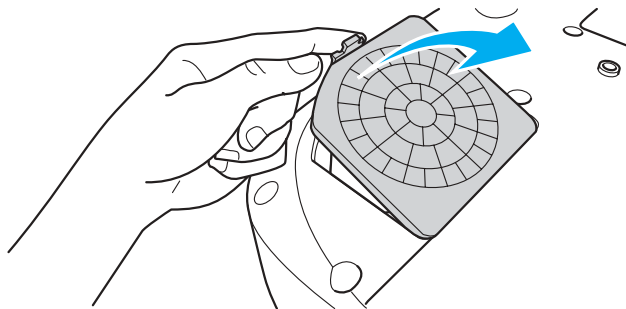

- 3 Replace the air filter with a new one.

Take out the old air filter and install the new one. Please ensure there are no gaps between the air filter and the plastic grill.

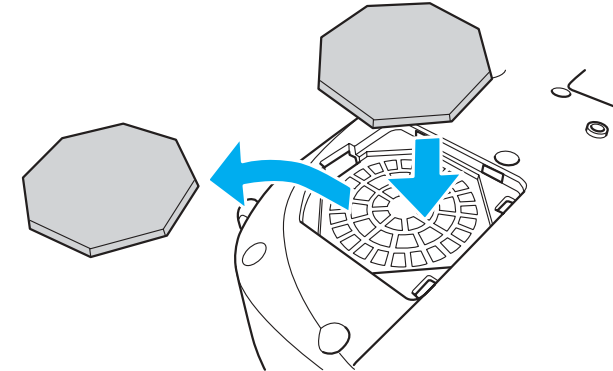

- 4 Replace the air filter cover.

First insert the tabs, and then press down on the opposite side until it clicks into place.

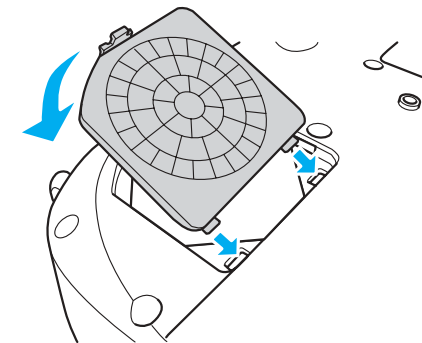

Dispose of used air filters properly in accordance with your local regulations.

Optional Accessories

You can purchase screens, carrying cases, or other accessories from EPSON at (800) 873-7766 or by visiting the EPSON Store at www.epsonstore.com (U.S. sales only). In Canada, please call (800) 463-7766 for dealer referral. This list of optional accessories is current as of November 2003. Details of accessories are subject to change without notice.

Part number	Part name
V13H010L25	Replacement lamp
V13H134A03	Air filter set
V12H007T11	Remote control
V12H007T09	Presentation remote control kit (connects to a PC or Mac)
ELPSC06	50" Portable screen (4:3 aspect ratio)
ELPSC07	60" Portable pop-up screen (4:3 aspect ratio)
ELPSC08	80" Portable pop-up screen (4:3 aspect ratio)
ELPAP01	Mac adapter set (used to convert a Macintosh D-sub 15-pin plug into a mini D-sub 15-pin plug)
ELPMB42	Ceiling mount
ELPMBFCP	False ceiling plate
ELPSV01	S-Video cable
ELPKC19	Component video cable (9.8 feet/3 m) for mini D-Sub 15-pin/RCA×3
ELPMBAPL	Suspension adapter
ELPDA01	Distribution amplifier
ELPKS35-S	Samsonite wheeled softcase
ELPKS43	Samsonite soft shoulder case for projector and laptop
ELPKS49	ATA molded hardshell case
ELPDC02	High resolution document imager
V12H064020	High resolution document camera
ELPSL01	Kensington security lock

Glossary

Complex terms used in this book, or terms not explained in the body of the text, will be briefly explained here. For further explanation, please consult commercially available reference texts.

<i>5BNC</i>	A type of connector used to input analog video signals.
<i>Aspect ratio</i>	The ratio between an image's length and its height. Images which have an aspect ratio of 16:9 are called Widescreen. The aspect ratio for standard images is 4:3.
<i>Color Temperature</i>	The temperature of an object which is emitting light. When the color temperature is high, colors tend to take on a bluish tinge; when the color temperature is low, colors tend to take on a reddish tinge.
<i>Component Video</i>	A type of video signal which has the video brightness and color signal information separated, in order to provide better image quality. In high-definition TV (HDTV), it refers to images which consist of three independent signals: Y (luminance signal), and Pb and Pr (color difference signals).
<i>Composite Video</i>	The standard home video signal (NTSC, PAL, SECAM) which has the video brightness and color signal information mixed together. Composite video consists of the carrier signal Y (luminance signal) and the chroma (color) signal, combined within the color bar signal.
<i>Contrast</i>	The relative brightness of the light and dark areas of an image, which can be increased or decreased in order to make text and graphics stand out, or appear softer.

<i>Cool-down</i>	The process used to cool down a projector lamp that is hot from use. Cool-down happens automatically when the [Power] button is pressed on the projector or on the remote control to turn the projector off. Do not unplug the projector power cable while it is cooling down. If cool-down is interrupted, heat from the lamp gets trapped inside the projector, potentially shortening the life of the lamp and causing projector failure.
<i>Dolby digital</i>	An audio format developed by Dolby® Laboratories. Normal stereo is a 2-channel format which uses two speakers, whereas Dolby Digital is a 6-channel (5.1-channel) system which adds a center speaker, two rear speakers and a sub-woofer.
<i>HDTV</i>	An abbreviation for High-Definition Television, it refers to high definition systems which satisfy the following conditions: <ul style="list-style-type: none"> • Vertical resolution of 750p or 1125i or greater (p=Progressive scanning †, i=Interlaced scanning †) • Screen aspect ratio of 16:9 • Dolby digital † I audio reception and playback (or output)
<i>Interlaced scanning</i>	Each screen is divided into fine horizontal lines which are displayed in sequence starting from left to right and then from top to bottom. In this method of image scanning, even numbered lines and odd numbered lines are displayed alternately.
<i>Progressive scanning</i>	A method of image scanning whereby the image data from a single image is scanned sequentially from top to bottom to create a single image.

Refresh Rate	The number of refresh operations per second The light-emitting element of a display maintains the same luminosity and color for an extremely short time. For this reason, the image must be scanned many times per second in order to refresh the light-emitting element. The refresh rate is expressed in hertz (Hz).
Resized display	This function is used to project computer images that have a resolution more than or less than the projector's panel resolution, so that they fill the whole of the projection area.
SDTV	An abbreviation for Standard Definition Television. It refers to standard television systems which do not satisfy the conditions for High-Definition Television.
Security lock	A device consisting of a projector case with a hole in it that a commercially-available theft-prevention cable can be passed through in order to secure the device to a table or pillar. This projector is compatible with the MicroSaver® Security System manufactured by Kensington®.
Squeeze mode	The method of compressing 16:9 Widescreen images and recording them on video software as 4:3 images. <i>When projecting with Squeeze mode on, the images will return to their original 16:9 format.</i>
sRGB	An international standard for color intervals that was formulated so that colors which are reproduced by video equipment can be handled easily by computer operating systems (OS) and the Internet.
SVGA	A type of video signal with a resolution of 800 (horizontal) × 600 (vertical) dots which is used by IBM PC/AT-compatible computers.

S-Video	A type of video signal which has the video brightness and color signal information separated, in order to provide better image quality. It refers to images which consist of two independent signals: Y (luminance signal), and C (color signal).
Sync. (Synchronization)	The process of matching the phases (the relative position of crests and troughs) of computer and projector signals. If signals are not synchronized, problems such as flickering, blurriness and horizontal interference can occur.
Tracking	The process of matching the computer and projector frequencies (the number of crests in the signals). If tracking is not carried out correctly, wide vertical stripes will appear in the projected images.
VGA	A type of video signal with a resolution of 640 (horizontal) × 480 (vertical) dots which is used by IBM PC/AT-compatible computers.
XGA	A type of video signal with a resolution of 1,024 (horizontal) × 768 (vertical) dots which is used by IBM PC/AT-compatible computers.
YCbCr	The carrier signal contained in the color bar signal used in modern (NTSC) TV transmissions. The name comes from the Y (luminance) signal and the CbCr (chroma [color]) signals.
YPbPr	The carrier signal contained in the color bar signal used in high-definition TV (HDTV) transmissions. The name comes from the Y (luminance) signal and the PbPr (color difference) signals.

Cable Format

Serial connection

- ▶ Connector type: D-Sub 9-pin (male)
- ▶ Projector input port type: RS-232C

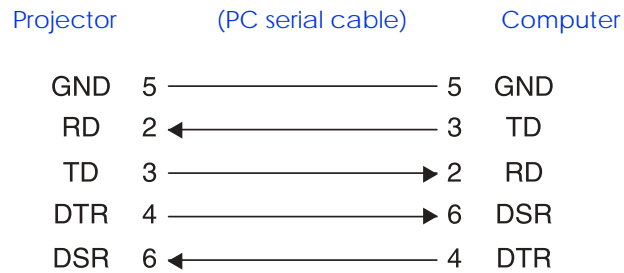
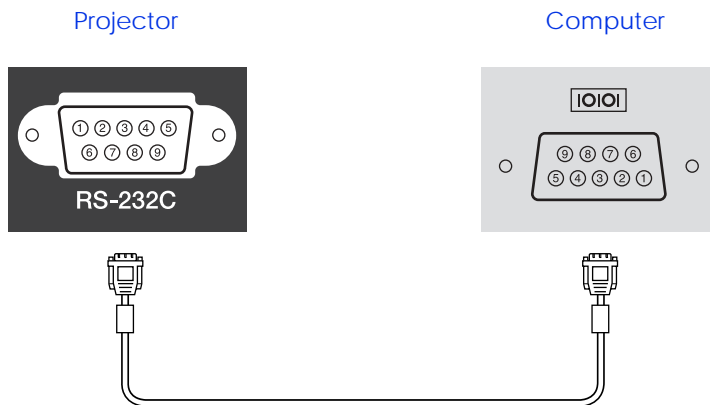

Signal name	Function
GND	Signal line grounding
TD	Transmitting data
RD	Receiving data
DSR	Data set ready
DTR	Data terminal ready

Supported Display Resolutions

Computer

Signal	Refresh Rate † (Hz)	Resolution (dots)	Resolutions for Resized display † (dots)
VGA †	60	640 × 480	800 × 600
VGAEGA		640 × 350	800 × 438
VESA	72 / 75 / 85, iMac*	640 × 480	800 × 600
SVGA †	56 / 60 / 72 / 75 / 85, iMac*	800 × 600	800 × 600
XGA †	43i / 60 / 70 / 75 / 85, iMac*	1024 × 768	800 × 600
MAC13"		640 × 480	800 × 600
MAC16"		832 × 624	800 × 600
MAC19"		1024 × 768	800 × 600
MAC21"		1152 × 870	794 × 600
SDTV † (525i)	60	640 × 480	800 × 600
SDTV (525p)	60	640 × 480	800 × 600
HDTV † (750p)	60	1280 × 720	800 × 450
HDTV (1125i)	60	1920 × 1080	800 × 450

* Connection is not possible if the equipment does not have a VGA output port.

Component Video

Signal	Refresh Rate † (Hz)	Resolutions (dots)	
		Aspect ratio 4:3	Aspect ratio 16:9
SDTV(525i)(D1)	60	800 × 600	800 × 450
SDTV(625i)	50	800 × 600	800 × 450
SDTV(525p)(D2)	60	800 × 600	800 × 450
HDTV(750p) 16:9 (D4)	60	800 × 600	800 × 450
HDTV(1125i) 16:9 (D3)	60	800 × 600	800 × 450

Composite Video/S-Video

Signal	Refresh Rate † (Hz)	Resolutions (dots)	
		Aspect ratio 4:3	Aspect ratio 16:9
TV(NTSC)		800 × 600	800 × 450
TV(PAL, SECAM)		800 × 600	800 × 450

It may be possible to project signals which are not listed in the above table. However, not all functions may be supported with such signals.

Specifications

Product name	EPSON PowerLite S1 LCD Projector		
Dimensions	14.6 (W) × 4.2 (H) × 10.4 (D) inches (370 × 106 × 265 mm) (not including projector's feet)		
Panel Size	0.5 inches		
Display method	Polysilicon TFT active matrix		
Resolution	SVGA† 480,000 (800 (W) × 600 (H) dots) × 3		
Focus adjustment	Manual		
Zoom adjustment	Digital (Approx. 1:1.2)		
Lamp (light source)	UHE Lamp 130W		
Maximum audio output	1W monaural		
Speaker	1		
Power supply	100 - 120 V model: 100-120 VAC 2.7A 50/60 Hz 200 - 240 V model: 200-240 VAC 1.3A 50/60 Hz		
Operating temperature	+5°C to +35°C (41°-95°F) (No condensation)		
Storage temperature	-10°C to +60°C (14°-140°F) (No condensation)		
Weight	Approximately 7 lbs (3.2 kg)		
Connectors	Monitor Out port	1	Mini D-Sub 15-pin (female) black
	Computer/Component Video port	1	Mini D-Sub 15-pin (female) blue
	S-Video port	1	Mini-DIN 4-pin
	Video port	1	RCA pin jack
	Audio port	1	RCA pin jack × 2 (L,R)
	Control (RS-232C) port	1	D-Sub 9-pin (male)

Safety

USA

UL1950 3rd Edition

Canada

CSA C22.2 No.950-95 (cUL)

European Community

The Low Voltage Directive (73/23/EEC)

IEC60950 2nd Edition, +Amd.1, +Amd.2, +Amd.3, +Amd.4

EMC

USA

FCC 47CFR Part15B Class B (DoC)

Canada

ICES-003 Class B

European Community

The EMC Directive (89/336/EEC)

EN55022, 1998 Class B

EN55024, 1998

IEC61000-4-2, IEC61000-4-3, IEC61000-4-4,

IEC61000-4-5,

IEC61000-4-6, IEC61000-4-8, IEC61000-4-11,
IEC61000-3-2, IEC61000-3-3

Australia/New Zealand

AS/NZS 3548:1995, A1:1997, A2:1997, Class B

CISPR Pub.22:1993, A1:1995, A2:1996, Class B



Pixelworks™ DNX™ ICs are used in this projector.

Important Safety Instructions

Please read the following important information about your projector.



- ***Never look into the projector lens when the lamp is switched on as the bright light can damage your eyes. Never let children look into the lens when it is on.***
- ***Never open any covers on the projector except the lamp cover. Dangerous electrical voltages inside the projector can cause severe injury. Except as specifically directed in the User's Guide supplied, do not attempt to service this product yourself. Refer all servicing to qualified service personnel.***
- ***Keep the plastic bags for the projector, accessories and optional parts out of the reach of children. Children covering their heads with bags may result in death by suffocation. Be particularly careful around small children.***
- ***When you replace the lamp, never touch the new bulb with your bare hands. The invisible residue left by the oil on your hands may be shorten the bulb life. Use a cloth or gloves to handle the new bulb.***

Follow these safety instructions when setting up and using the projector:

- Do not place the projector on an unstable cart, stand, or table.
- Do not use the projector near water or sources of heat.
- Use attachments only as recommended.
- Use the type of power source indicated on the projector. If you are not sure of the power available, consult your dealer or local electricity company.
- Place the projector near a wall outlet where the plug can be easily unplugged.
- If the projector has a three-prong plug, insert the projector's three-pin grounding-type plug into a properly grounded outlet. If you have a two-prong outlet, contact an electrician to replace it.
- Do not handle the plug with wet hands.
- Take the following precautions when handling the plug. Failure to comply with these precautions could result in sparks or fire.
- Do not insert the plug into an outlet with dust present.
- Insert the plug firmly into the outlet.
- Do not overload wall outlets, extension cables or integral convenience receptacles. This can cause fire or electric shock.
- Do not place the projector where the cable can be stepped on. It may result in fraying or damage to the plug.
- Unplug the projector from the wall outlet before cleaning. Use a damp cloth for cleaning. Do not use liquid or aerosol cleaners.
- Do not block the slots and opening in the projector case. They provide ventilation and prevent the projector from overheating. Do not place the projector on a sofa, rug or other soft surface, or in a closed-in cabinet unless proper ventilation is provided.
- Never push objects of any kind through cabinet slots. Never spill liquid of any kind into the projector.
- Unplug the projector when it will not be used for extended periods.
- Do not place the projector and remote control on top of heat producing equipment or in a heated place, such as a car.
- Unplug the projector from the wall outlet and refer servicing to qualified service personnel under the following conditions:
 - When the power cable or plug is damaged or frayed
 - If liquid has been spilled into the projector, or it has been exposed to rain or water
 - If it does not operate normally when you follow the operating instructions, or if it exhibits a distinct change in performance, indicating a need for service
 - If it has been dropped or the housing has been damaged
- The internal projector components consist of many glass parts such as the lens and projection lamp.

- ▶ The lamp is fragile, and can easily break. If the lamp breaks, handle the projector with extreme care to avoid injury from broken glass, and contact your dealer or see [Where to Get Help](#) for repairs.
Particular care should be taken when the projector is installed to a ceiling, as small pieces of glass may fall down when the lamp cover is removed. Be very careful not to allow such pieces of glass to get into the eyes or mouth.
- ▶ Material or paper may get stuck against the air filter underneath the projector while it is in use. Remove anything from underneath the projector that might get stuck against the air filter in this way.
- ▶ Never try to remove the lamp immediately after use.
- ▶ Doing so will result in serious burns. Before removing the lamp, turn off the power supply and wait the time specified in the *User's Guide* to allow the lamp to cool completely.
- ▶ A mercury lamp with high internal pressure is used as the projector's light source. Mercury lamps may make a loud noise when they break. Handle the lamp with extreme care while observing the following.
- ▶ If the following points are not observed, injury or poisoning may result.
- ▶ Do not damage the lamp or subject it to any impacts.
- ▶ Do not use the lamp after the lamp replacement period has elapsed. Once the lamp replacement period has elapsed, the possibility of the lamp breaking becomes greater. When the lamp replacement message appears, replace the lamp with a new one as soon as possible.
- ▶ The gases inside mercury lamps contain mercury vapor. If the lamp breaks, immediately ventilate the room to prevent the gases that are released when the lamp breaks from being inhaled or coming into contact with the eyes or mouth.
- ▶ Do not bring your face close to the projector while it is in use, in order to prevent the gases that are released when the lamp breaks from being inhaled or coming into contact with the eyes or mouth.
- ▶ If the lamp breaks and needs to be replaced with a new lamp, contact the place of purchase or see [Where to Get Help](#) for information on replacement. If the lamp breaks, pieces of broken glass may get scattered around inside the projector.
- ▶ Particular care should be taken when the projector is installed to a ceiling, as small pieces of glass may fall down when the lamp cover is removed. If cleaning the projector or replacing the lamp yourself, be very careful not to allow such pieces of glass to get into the eyes or mouth. If the lamp breaks and gas from the lamp or fragments of broken glass are inhaled or get into the eyes or mouth, or if any other ill effects are noticed, immediately seek medical advice.
- ▶ If there is an electrical storm, do not touch the power plug, otherwise you may receive an electric shock.
- ▶ Clean the inside of the projector periodically.
- ▶ If the inside of the projector has not been cleaned for a long time, dust may build up and cause fire or electric shocks. Contact your dealer or Authorized EPSON Service Center to clean inside the projector at least once a year. A charge will be levied for this service.
- ▶ If using a remote control that takes button-type batteries, keep these button-type batteries out of the reach of children. Batteries are choking hazards and can be very dangerous if swallowed.
- ▶ If the batteries are swallowed, seek medical assistance immediately.

DECLARATION of CONFORMITY

According to 47CFR, Part 2 and 15

Class B Personal Computers and Peripherals; and/or
CPU Boards and Power Supplies used with Class B
Personal Computers

We: EPSON AMERICA, INC.
Located at: 3840 Kilroy Airport Way
MS: 3-13
Long Beach, CA 90806
Tel: 562-290-5254

Declare under sole responsibility that the product identified herein, complies with 47CFR Part 2 and 15 of the FCC rules as a Class B digital device. Each product marketed, is identical to the representative unit tested and found to be compliant with the standards. Records maintained continue to reflect the equipment being produced can be expected to be within the variation accepted, due to quantity production and testing on a statistical basis as required by 47CFR 2.909. Operation is subject to the following two conditions: (1) this device may not cause harmful interference, and (2) this device must accept any interference received, including interference that may cause undesired operation.

Trade Name: EPSON
Type of Product: Projector
Model: EMP-S1

FCC Compliance Statement

For United States Users

This equipment has been tested and found to comply with the limits for a Class B digital device, pursuant to Part 15 of the FCC Rules. These limits are designed to provide reasonable protection against harmful interference in a residential installation. This equipment generates, uses, and can radiate radio frequency energy and, if not installed and used in accordance with the instructions, may cause harmful interference to radio or television reception. However, there is no guarantee that interference will not occur in a particular installation. If this equipment does cause interference to radio and television reception, which can be determined by turning the equipment off and on, the user is encouraged to try to correct the interference by one or more of the following measures.

- Reorient or relocate the receiving antenna.
- Increase the separation between the equipment and receiver.
- Connect the equipment into an outlet on a circuit different from that to which the receiver is connected.
- Consult the dealer or an experienced radio/TV technician for help.

WARNING

The connection of a non-shielded equipment interface cable to this equipment will invalidate the FCC Certification or Declaration of this device and may cause interference levels which exceed the limits established by the FCC for this equipment. It is the responsibility of the user to obtain and use a shielded equipment interface cable with this device. If this equipment has more than one interface connector, do not leave cables connected to unused interfaces. Changes or modifications not expressly approved by the manufacturer could void the user's authority to operate the equipment.

Warranty

Epson America, Inc. Limited Warranty

Basic Two-Year Warranty and 90-Day Lamp Warranty

What Is Covered: Epson America, Inc. (“EPSON”) warrants to the first end user customer of the EPSON product enclosed with this limited warranty statement that the product, if purchased and used in the United States or Canada, conforms to the manufacturer’s specifications and will be free from defects in workmanship and materials for a period of two (2) years from the date of original purchase (except that the warranty period is 90 days for projector lamps).

What EPSON Will Do To Correct Problems: If you elect carry-in warranty service, please bring the product securely packaged in its original container or an equivalent, along with proof of the date of original purchase, to your EPSON Dealer or EPSON Customer Care Center. EPSON will, at its option, repair or replace on an exchange basis the defective unit, without charge for parts or labor. When warranty service involves the exchange of the product or of a part, the item replaced becomes EPSON property. The exchanged product or part may be new or previously repaired to the EPSON standard of quality. Exchange or replacement products or parts assume the remaining warranty period of the product covered by this limited warranty. However, each replacement lamp carries the limited 90-day warranty stated above.

What This Warranty Does Not Cover: This warranty covers only normal consumer use in the United States and Canada. For lamps, 24-hour-per-day use causes unusual strain and is not considered normal use. This warranty does not cover consumables (e.g., fuses), other than lamps. EPSON is not responsible for warranty service should the EPSON label or logo or the rating label or serial number be removed or should the product fail to be properly maintained or fail to function properly as a result of misuse, abuse, improper installation, neglect, improper shipping, damage caused by disasters such as fire, flood, and lightning, improper electrical current, software problems, interaction with non-EPSON products, or service other than by an EPSON Authorized Servicer. Postage, insurance, or shipping costs incurred in

presenting your EPSON product for carry-in warranty service are your responsibility. If a claimed defect cannot be identified or reproduced in service, you will be held responsible for costs incurred.

THE WARRANTY AND REMEDY PROVIDED ABOVE ARE EXCLUSIVE AND IN LIEU OF ALL OTHER EXPRESS OR IMPLIED WARRANTIES INCLUDING, BUT NOT LIMITED TO, THE IMPLIED WARRANTIES OF MERCHANTABILITY OR FITNESS FOR A PARTICULAR PURPOSE. SOME LAWS DO NOT ALLOW THE EXCLUSION OF IMPLIED WARRANTIES. IF THESE LAWS APPLY, THEN ALL EXPRESS AND IMPLIED WARRANTIES ARE LIMITED TO THE WARRANTY PERIOD IDENTIFIED ABOVE. UNLESS STATED HEREIN, ANY STATEMENTS OR REPRESENTATIONS MADE BY ANY OTHER PERSON OR FIRM ARE VOID. EXCEPT AS PROVIDED IN THIS WRITTEN WARRANTY, NEITHER EPSON AMERICA, INC. NOR ITS AFFILIATES SHALL BE LIABLE FOR ANY LOSS, INCONVENIENCE, OR DAMAGE, INCLUDING DIRECT, SPECIAL, INCIDENTAL OR CONSEQUENTIAL DAMAGES, RESULTING FROM THE USE OR INABILITY TO USE THE EPSON PRODUCT, WHETHER RESULTING FROM BREACH OF WARRANTY OR ANY OTHER LEGAL THEORY. IF THE REMEDY ABOVE FAILS, EPSON’S ENTIRE LIABILITY SHALL BE LIMITED TO A REFUND OF THE PRICE PAID FOR THE EPSON PRODUCTS COVERED BY THIS LIMITED WARRANTY.

In Canada, warranties include both warranties and conditions.

Some jurisdictions do not allow limitations on how long an implied warranty lasts and some jurisdictions do not allow the exclusion or limitation of incidental or consequential damages, so the above limitations and exclusions may not apply to you.

This warranty gives you specific legal rights, and you may also have other rights, which vary from jurisdiction to jurisdiction.

To locate the Authorized EPSON Servicer nearest you, call the EPSON ConnectionSM at (800) 637-7661 + PIN or (562) 276-4394 in the U.S. and (905) 709-3839 in Canada or write to: Epson America, Inc., P.O. Box 93012, Long Beach, CA 90809-3012.

Index

- | | | | |
|-------------------------------------|--------|-------------------------------------|--------|
| 13w3 port | 15 | Connecting to a Computer | 14 |
| 5BNC port | 15 | Connecting to Video Equipment | 20 |
| A | | | |
| A/V Mute | 30 | Contrast | 37 |
| Accessories | 53, 60 | Control (RS-232C) port | 8 |
| Air filter | 9 | Control panel | 6, 7 |
| Air intake vent | 9 | Cool-down | 24, 43 |
| All Reset | 42 | D | |
| Aspect ratio | 10, 31 | Display | 40 |
| Audio port | 8 | E | |
| Auto Setup | 38 | EPSON | |
| AV cable | 20 | accessories | 53, 60 |
| B | | | |
| Background Color | 40 | PrivateLine Support | 53 |
| Battery holder | 56 | technical support | 53 |
| Brightness | 37 | E-Zoom | 31 |
| C | | | |
| Cable Format | 63 | F | |
| Ceiling | 13, 39 | Focus | 25 |
| Ceiling mount holes | 9 | Focus ring | 6, 25 |
| Changing the battery | 56 | Foot button | 6 |
| Cleaning the air filter | 55 | Freeze | 30 |
| Cleaning the lens | 54 | Front foot | 6 |
| Cleaning the projector case | 54 | G | |
| Color Mode | 37 | Glossary | 61 |
| Color Temperature | 38 | H | |
| Component Video | 21 | Handle | 6, 9 |
| Composite Video | 20 | HDTV | 61 |
| Computer cable | 14 | Help | 53 |
| Computer/Component Video port | 8 | | |
| Configuration Menus | 32 | | |

I

Image menu	32, 36
Indicators	7, 43, 45
Info menu	41
Input Signal	38, 41
Installation	12

J

Joystick	19
----------------	----

K

Keystone	27, 39
----------------	--------

L

Lamp cover	9
Lamp Hours	41
Lamp replacement period	56
Lamp-Hours Reset	42
Language	40
Lens cover	6

M

Message display	40
Mini D-Sub 15 pin	14
Monitor Out port	8
Mouse pointer	16

O

Operating range	
presentation remote control	20
remote control	11
Operating temperature	65
Optional Accessories	60
Overheating	44

P

Part Names and Functions	6
Picture Quality	37
Port	8
Position	39
Power cable	22
Power indicator	7
Power inlet	8
Presentation remote control	16
Presenters Online	53
PrivateLine Support	53
Projecting in widescreen	31
Projection	39
Projection angle	26
Projection distance	12

R

Remote Control	10
Remote control holder	8
Remote control infrared receiver	6, 8
Remote control infrared transmitter	
presentation remote control	19
remote control	10
Replacing the air filter	59
Replacing the lamp	57
Reset menu	42
Resized display	62
RGB	21

S

Saturation	38
Screen	39
Security lock	8
Setting menu	39
Sharpness	37
Signal ID	41
Sleep Mode	40
Source	41

Speaker	6, 15
Specifications	65
sRGB	29, 37
Startup Screen	40
Storage temperature	65
Sub Menu	34
Supported Display	64
S-Video	20, 28
S-Video port	8
Sync Info	41
Sync.	29, 38

T

Target scope	31
Technical support	53
Tint	38
Top Menu	33
Tracking	37
Translucent screen	13
Turning off the Projector	24
Turning on the Projector	22

V

Ventilation outlet	6
Video	41
Video port	8
Video Signal	
displaying	41
selecting	40
Volume	40

W

Warning indicator	7
Warranty	69
When You Suspect a Problem	43
Workstation	15