



brother®



EMBROIDERY MACHINE

PR-620

OPERATION MANUAL

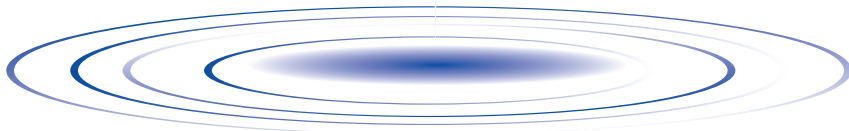

Important Safety Instructions

When using this machine, basic safety precautions should always be taken, including the following:

Read all instructions before using.

DANGER - To reduce the risk of electric shock:

1. The machine should never be left unattended while plugged in. Always unplug the machine from the electrical outlet immediately after using and before cleaning.

WARNING - To reduce the risk of burns, fire, electric shock, or injury to persons:

1. Do not allow this machine to be used as a toy. Close attention is necessary when the machine is used by or near children.
2. Use this machine only for its intended use as described in this manual. Use only accessories recommended by the manufacturer as contained in this manual.
3. Never operate this machine if it has a damaged cord or plug, if it is not working properly, if it has been dropped or damaged, or dropped into water. Return the machine to the nearest authorized retailer or service center for examination, repair, and electrical or mechanical adjustment.
4. Never operate the machine with any air openings blocked. Keep ventilation openings of the machine free from the accumulation of lint, dust, and loose cloth.
5. Never drop or insert any object into any opening.
6. Do not use outdoors.
7. Do not operate where aerosol (spray) products are being used or where oxygen is being administered.
8. To disconnect, set the main power switch to the "O" position, which represents off, and then remove the plug from the outlet.
9. Do not unplug by pulling on the cord. To unplug, grasp the plug, not the cord.
10. Keep fingers away from all moving parts. Special care is required around the machine needle.
11. Always use the proper needle plate. The wrong plate can cause the needle to break.
12. Do not use bent needles.
13. Set the main power switch to the "O" position when making any adjustments in the needle area, such as changing the needle.
14. Always unplug the machine from the electrical outlet when lubricating it or when making any other user servicing adjustments mentioned in the manual.
15. This sewing machine is not intended for use by young children or infirm persons without supervision.
16. Young children should be supervised to ensure that they do not play with this machine.
17. Keep fingers out of all sewing machine openings, such as near the carriage, otherwise injuries may result.
18. If the LED light unit (light-emitting diode) is damaged, it must be replaced by authorized dealer.

SAVE THESE INSTRUCTIONS
This machine is intended for household use.

FOR USERS IN THE UK, EIRE, MALTA AND CYPRUS ONLY

If this machine is fitted with a three-pin non-rewireable BS plug, then please read the following.

IMPORTANT

If the available socket outlet is not suitable for the plug supplied with this equipment, it should be cut off and an appropriate three-pin plug fitted. With alternative plugs, an approved fuse must be fitted in the plug.

NOTE

The plug served from the main lead must be destroyed as a plug with bared flexible cords is hazardous if engaged in a live socket outlet. In the event that the plug fuse must be replaced, use a fuse approved by ASTA to BS 1362, i.e. carrying the  mark, rating as marked on plug. Always replace the fuse cover, never use plugs with the fuse cover omitted.

WARNING

DO NOT CONNECT EITHER WIRE TO THE EARTH TERMINAL WHICH IS MARKED WITH THE LETTER 'E', BY THE EARTH SYMBOL  OR COLOURED GREEN OR GREEN AND YELLOW.

The wires in this main lead are coloured in accordance with the following code:

Blue	Neutral
Brown	Live

As the colours of the wiring in the main lead of this appliance may not correspond with the coloured markings identifying the terminals in your plug, proceed as follows.

The wire that is coloured blue must be connected to the terminal that is marked with the letter 'N' or coloured black or blue.

The wire that is coloured brown must be connected to the terminal that is marked with the letter 'L' or coloured red or brown.

Federal Communications Commission (FCC) Declaration of Conformity (For USA Only)

Responsible Party: Brother International Corporation
100 Somerset Corporate Boulevard
Bridgewater, NJ 08807-0911 USA
TEL : (908) 704-1700

declares that the product

Product Name: Brother Sewing Machine
Model Number: PR-620

complies with Part 15 of the FCC Rules. Operation is subject to the following two conditions: (1) this device may not cause harmful interference, and (2) this device must accept any interference received, including interference that may cause undesired operation.

This equipment has been tested and found to comply with the limits for a Class B digital device, pursuant to Part 15 of the FCC Rules. These limits are designed to provide reasonable protection against harmful interference in a residential installation. This equipment generates, uses, and can radiate radio frequency energy and, if not installed and used in accordance with the instructions, may cause harmful interference to radio communications. However, there is no guarantee that interference will not occur in a particular installation. If this equipment does cause harmful interference to radio or television reception, which can be determined by turning the equipment off and on, the user is encouraged to try to correct the interference by one or more of the following measures:

- Reorient or relocate the receiving antenna
- Increase the separation between the equipment and receiver.
- Connect the equipment into an outlet on a circuit different from that to which the receiver is connected.
- Consult the retailer or an experienced radio/TV technician for help.
- The enclosed interface cable should be used in order to ensure compliance with the limits for a Class B digital device.
- Changes or modifications not expressly approved by Brother Industries, Ltd. could void the user's authority to operate the equipment.

THANK YOU FOR CHOOSING OUR MACHINE

Your machine is one of the most advanced computerized household embroidery machines. To fully enjoy all the features available, we suggest that you study the manual before using the machine.

PLEASE READ BEFORE USING THIS MACHINE

For safe operation

1. Be sure to keep your eye on the needle while sewing. Do not touch the handwheel, thread take-up lever, needle, or other moving parts.
2. Remember to turn off the power switch and unplug the cord when:
 - Operation is completed
 - Replacing or removing the needle or any other parts
 - A power failure occurs during use
 - Maintaining the machine
 - Leaving the machine unattended
3. Plug the machine directly into the wall. Do not use extension cords.

For a longer service life

1. When storing this machine, avoid direct sunlight and high humidity locations. Do not use or store the machine near a space heater, iron, halogen lamp, or other hot objects.
2. Use only neutral soaps or detergents to clean the machine. Benzene, thinner, and scouring powders can damage the machine, and should never be used.
3. Do not drop or hit the machine.
4. Always consult the manual when replacing or installing any assemblies, needle, or other parts to assure correct installation.

For repair or adjustment

In the event a malfunction occurs or adjustment is required, first follow the troubleshooting table at the back of this Operation Manual to inspect and adjust the machine yourself. If the problem persists, consult your local authorized Brother dealer.

For additional product information and updates, visit our web site at www.brother.com

License Agreement

The enclosed machine includes data, software and/or documentation (collectively "CONTENT") that are proprietary products of Brother Industries, Ltd. ("BROTHER"). BY USING THE CONTENT, THE CUSTOMER ACCEPTS THE TERMS AND CONDITIONS OF THIS AGREEMENT. BROTHER retains ownership of all rights to CONTENT and to the copies of the CONTENT included in this package. The CONTENT are licensed (not sold) to you ("CUSTOMER") under the terms and conditions of this Agreement.

CUSTOMER is licensed to:

- Use the CONTENT in combination with an embroidery machine to create embroidery.
- Use the CONTENT in combination with an embroidery machine that CUSTOMER owns or uses, provided that the CONTENT is not used on more than one embroidery machine at a time.

Except as otherwise provided herein, CUSTOMER may not:

- Allow more than one copy of the CONTENT to be available for use at any one time.
- Reproduce, modify, publish, distribute, sell, rent, sublicense or otherwise make available to others CONTENT.
- Distribute, rent, sublicense, lease, sell, transfer or assign the media card or CONTENT.
- Decompile, disassemble or otherwise reverse engineer the CONTENT or assist others to do the same.
- Alter, translate, modify or adapt the CONTENT or any part thereof for business, commercial or industrial purposes.
- Sell or otherwise distribute the EMBROIDERY created by use of the CONTENT, WHICH ORIGINALLY BEARS CERTAIN COPYRIGHT NOTICE UNDER THE NAME OF ANY THIRD PARTIES OTHER THAN BROTHER (e.g. "©DISNEY").

BROTHER retains all rights not expressly granted to CUSTOMER herein.

Nothing in this agreement constitutes a waiver of the rights of BROTHER under any law. This agreement shall be governed by the laws of Japan.

Please direct all inquiries concerning this Agreement in writing by regular mail, to Brother Industries, Ltd., 1-1-1 Kawagishi, Mizuho-ku, Nagoya 467-8562, Japan, Attention: P&H company Sales and Marketing Dept.

Warning Labels

The following warning labels are on the machine.
Be sure to observe the precautions described in the labels.

1

	▲ CAUTION	▲ ACHTUNG	▲ ATTENTION	▲ ATENCION	▲ PAS OP	▲ ATTENZIONE
	Carriage may cause injury. Do not put hands in carriage traveling path.	Um Verletzungen mit dem Stickarm zu vermeiden, nicht die Hände in die Nähe des Stickarms halten.	Le chariot peut provoquer des blessures. Ne pas mettre les mains dans le chemin du chariot.	El carro puede provocar lesiones. No poner las manos por donde pasa el carro.	De borduurarm kan verwondingen veroorzaken. Houdt uw handen buiten bereik van de borduurarm.	Il carrello potrebbe ferirvi. Non appoggiate la mano nel percorso del carrello.

	▲ ATENÇÃO	▲ ПРЕДУПРЕЖДЕНИЕ	▲ 注意	▲ 危険
	O carro de transporte pode causar ferimentos. Não coloque as mãos sobre o trilho do carro de transporte.	Движущаяся каретка может быть причиной травмы. Не кладите руки на пути движения каретки.	刺しゅう機のキャリッジや刺しゅう枠が動いているときに、手や物を近づけないでください。 ケガの原因になります。	在绣花机的导轨或绣花框移动时，为避免造成伤害，请不要将手或物品靠近。

2

Label locations

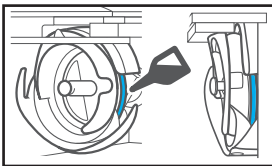

Please put a drop of oil onto the hook once a day before use.

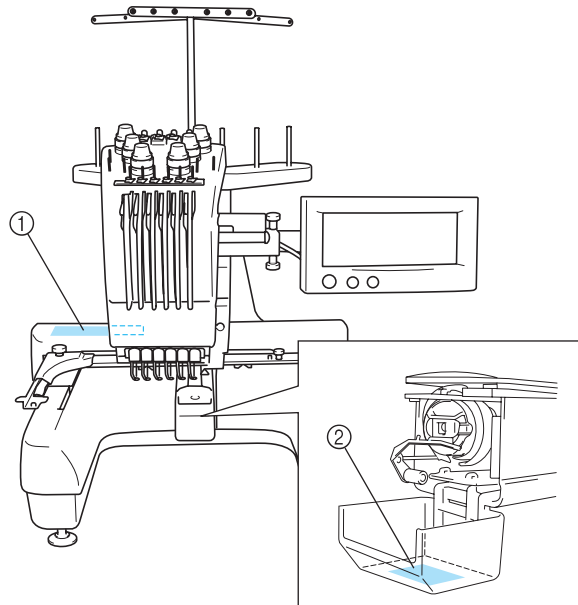

Precautions

Concerning optional embroidery cards

- Do not disassemble or alter the embroidery cards.
- Do not forcefully bend, drop, scratch or place heavy objects on top of the embroidery cards.
- Do not allow the embroidery cards to become wet, such as with water, solvents, drinks or any other liquids.
- Do not use or store the embroidery cards in a location exposed to strong static electricity or electrical interference.
- Do not use or store embroidery cards in locations exposed to vibrations or impacts, direct sunlight, extreme dust (or lint), high temperatures, high humidity, severe temperature fluctuations, or strong magnetic forces (such as from speakers).
- While embroidery data is being recalled from the embroidery card, do not allow the machine to be exposed to vibrations or impacts, and do not attempt to remove the embroidery card from the machine.
- Store embroidery cards in their protective cases.
- If an embroidery card other than our original embroidery cards are used, the embroidery machine may not operate correctly. Be sure to use only recommended embroidery cards.
- Some licensed or copyright embroidery cards cannot be used with this embroidery machine.
- Embroidery cards sold overseas cannot be used with this embroidery machine.
- Only insert or remove embroidery cards while  appears in the display or while the embroidery machine is turned off (see page 112).

Concerning USB media

- Do not disassemble or alter the USB media.
- Do not allow the USB media to become wet, such as with water, solvents, drinks or any other liquids.
- Do not use or store the USB media in a location exposed to strong static electricity or electrical interference.
- Do not use or store USB media in locations exposed to vibrations or impacts, direct sunlight, extreme dust (or lint), high temperatures, high humidity, severe temperature fluctuations, or strong magnetic forces (such as from speakers).
- While embroidery data is being recalled from the USB media, do not allow the machine to be exposed to vibrations or impacts, and do not attempt to remove the USB media from the machine.
- Some USB media may not be usable with this machine. Please visit our web site for more details.
- Only insert or remove USB media while  appears in the display, or when prompted to change media by a message on the display (see page 137).
- For additional information, refer to the instruction manual included with the USB media that you have purchased.

Machine Structure and Features

Six-needle machine embroidery

Your machine has six needles, each threaded with a different color of thread. It can sew embroidery patterns that contain several colors by automatically selecting the appropriate needle for each color. The mechanism that moves the needles up and down is called the needle bar, and the needle bars are in the needle bar case. The needle bars are named from right to left: needle bar 1, needle bar 2, needle bar 3, needle bar 4, needle bar 5, and needle bar 6.

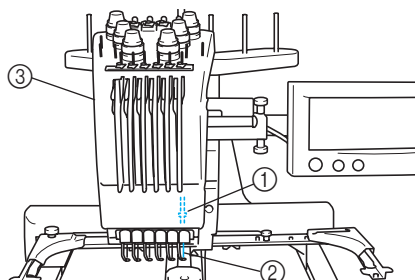

- ① Needle bar 1
- ② Needle 1
- ③ Needle bar case

The machine automatically assigns a thread color to each needle. If a needle is already threaded by a color that will be used on the next pattern the machine will assign the color to that needle, reducing the number of thread spool changes. This also means that the machine does not always assign colors according to the needle number, it assigns colors based on the currently threaded colors.



Memo

- Sewing is not necessarily performed in the order of the needle bar numbers.

The thread colors assigned to the needle bars are listed on the screen. Thread the needle bars as indicated.

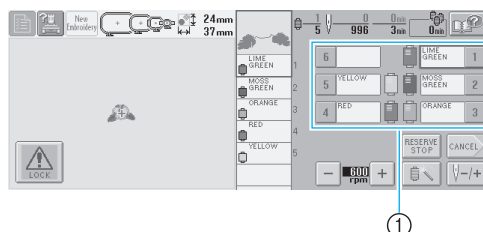

- ① The threads threaded on the needle bars are indicated as shown here.

The spool pins, thread tension knobs, thread take-up levers and thread paths, mentioned when threading the upper thread, are different according to their corresponding needle bar number.

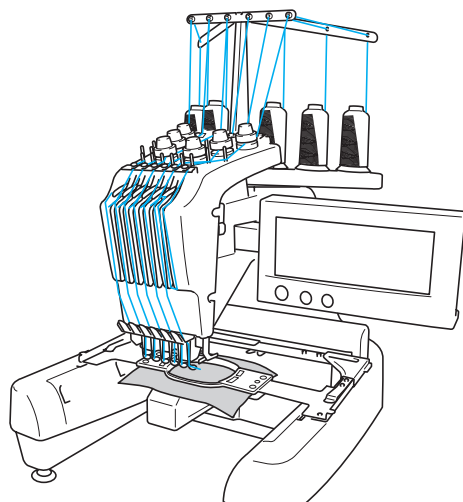

Not all six needles can be used to sew at the same time. Only one needle is moved to the embroidering position at a time. According to the sewing order, the needle bar case is moved to the left and right so that the needle bar and needle thread with the required color can be moved to the embroidering position.

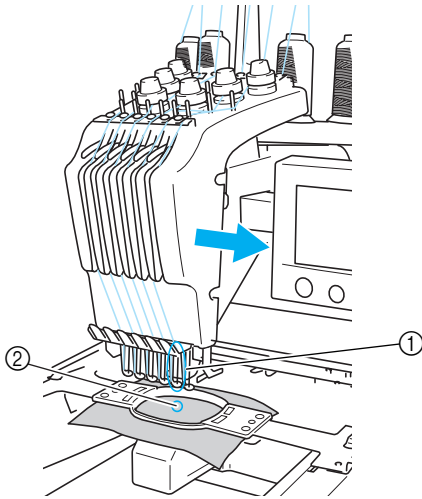

- ① Needle at the embroidering position
The needle is positioned over the hole in the needle plate ②.

When starting the machine, the presser foot is automatically lowered, and the embroidery is sewn while performing pulling thread from the materials at the thread trimming and while changing thread colors (moving the needle to be sewn within the embroidering). When sewing is finished, the machine stops. If the pattern uses seven or more thread colors, the machine will stop when it is necessary for the thread spools to be changed, and the corresponding instructions appear on the LCD.

Differences with single-needle machines

- **Can sew embroidery patterns using six or less colors without the need to replace the thread spools**

With single-needle machines, the thread spool must be changed and the machine must be threaded each time a different thread color is used. With this machine, it is not necessary to change the thread spool or rethread the machine with embroidery patterns containing six or less colors. If total colors are less than 6 colors, and if total color change is more than 7 times, machine will come back to the needle that the machine is already used and sew the same color again automatically.
- **Automatic sewing reduces sewing time**

Except to change the thread spools with patterns containing seven or more colors, once the machine is started, it continues to operate automatically, from lowering the presser foot to performing the specified operations at the starting and end positions in addition to changing the thread colors. Since the machine can change threads and finish stitching, sewing time is reduced.
- **Automatically pulls and holds the thread tails to the under side of fabric at the beginning and end of stitching**

Since the machine automatically pulls the upper thread under the fabric at the beginning of a color, and pulls the upper thread from the fabric at the time of thread trimming, you don't need to deal with the upper thread tail at all.
- **Automatically moves the embroidery frame to the embroidering position**

With single-needle machine, in most cases, the embroidery pattern is centered in the frame and the fabric must be correctly positioned within the embroidery frame with the center of the desired embroidering position aligned with the center of the embroidery frame. However, with this machine, the embroidery frame is moved to determine the embroidering position, making it easier to sew the pattern at any place in the frame. In addition, the embroidering position can be freely determined after the fabric is hooped and the embroidery frame is attached to the machine, regardless of how the fabric is positioned in the embroidery frame.

Other features

■ Easy-to-read and easy-to-use LCD

Equipped with a large color LCD, the colors of an embroidery pattern can be previewed in a nearly realistic image. In addition, since the LCD is a touch panel, the keys that are displayed on the screen can be touched to easily perform operations.

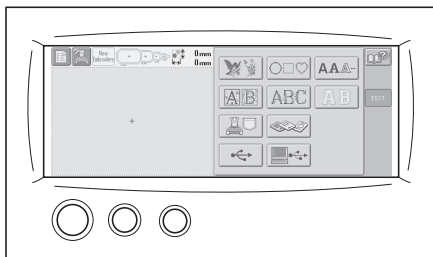

■ Safety mechanism

The machine is equipped with a locking mechanism that helps prevent injuries from accidental operation. The machine can only be started after the machine is unlocked. The color of the start/stop button changes to inform you of whether or not the machine is locked.

Lit in red

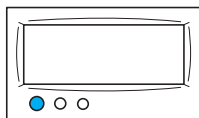

The machine is locked.

Flashing in green

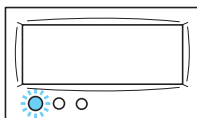

The machine can be started.

■ Wide selection of built-in thread color information

The thread color information for manufacturers' threads is available, making it easy to choose the appropriate thread color.

1770 MA POLY	1369 MA RAYON	1176 SULKY	9091 R.A
1951 MA POLY	1137 MA RAYON	1024 SULKY	5694 R.A
1637 MA POLY	1037 MA RAYON	1037 SULKY	5678 R.A
1980 MA POLY	1068 MA RAYON	1187 SULKY	5860 R.A

■ Expanded thread color display feature enables colors to be displayed in almost the true color

The colors and thread color numbers are stored in the machine's memory. From this thread color library, you can select colors to create your own color thread table. If the pattern colors are changed using this table, the pattern can be displayed with only the thread colors that you have. In addition, the embroidery pattern can be displayed as it would appear after it is embroidered.

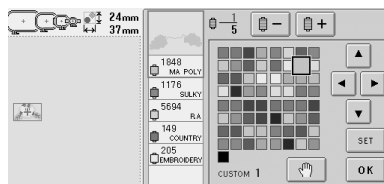

■ Automatic needle-threading mechanism

Using the automatic needle-threading mechanism, the needle can easily be threaded.

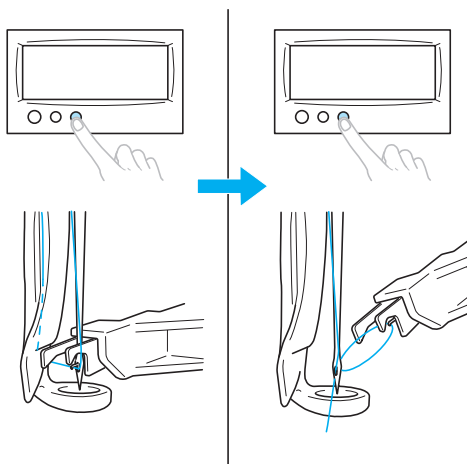

■ **USB Type “B” (function) port connector available as standard equipment**

If a computer is connected to the machine through the included USB cable, embroidery patterns can be recalled from the computer.

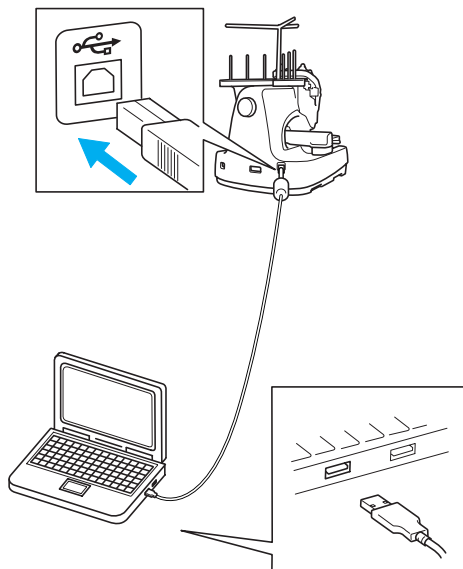

Available features

Designs with a maximum size of 200 mm (H) × 300 mm (W) (7-7/8 inches (H) × 11-3/4 inches (W)) can be embroidered. If the optional cap frame is used, embroidery can be sewn on caps.

■ **Various built-in patterns**

In addition to the many lettering patterns, embroidery patterns and frame patterns built into the machine, if an optional embroidery card is used, many more embroidery patterns are available.



■ **Embroidery pattern editing**

Lettering and embroidery patterns can be combined or a text arrangement can be specified to arrange the patterns.

The machine can also be set to repeatedly sew the same pattern.

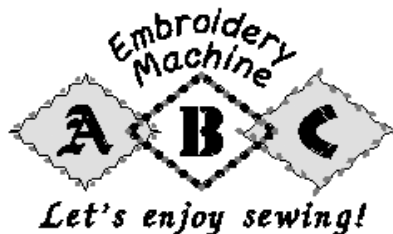

Manual Structure

This manual is constructed as described below.

Read before use

Chapter 1: Getting Ready

The setup of the embroidery machine and the various preparations required before starting to sew are described in this chapter.

Chapter 2: Embroidering Tutorial

This chapter describes the basic embroidering operations in order—from turning on the machine and sewing a pattern to finishing sewing. Follow the steps of the tutorial to embroider a pattern and master the operation of this embroidery machine.

Chapter 3: Other Basic Procedures

This chapter provides explanations on operations other than those described in chapter 2, such as when sewing a pattern with seven or more colors, and other necessary operations, for example, to change the needle.

Read when additional information is required

Chapter 4: Embroidering Settings

This chapter contains descriptions on the various embroidering settings, which make editing patterns simple.

Chapter 5: Selecting/Editing/Saving Patterns

This chapter provides details on selecting, editing and saving embroidery patterns.

Chapter 6: Basic Settings and Help Feature

This chapter contains descriptions on the use of the settings key, the machine operations key and the help key. Details on changing the basic embroidery machine settings and viewing operations on the LCD will be provided.

Chapter 7: Appendix

This chapter provides descriptions of techniques for various embroidering operations, pointers for creating beautiful embroidery, and details on maintenance procedures and corrective measures that should be taken when a problem occurs.

Searching for information

■ Searching the manual

By title

Check the descriptions at the left for the contents of each chapter, and then check the table of contents.

For basic operations, refer to the list of titles on the first page of chapter 2. Find the appropriate page by using the thumbtabs on the right edge of the pages.

By keyword

Search the index at the end of this manual. Look for the desired keyword, and then refer to the page that is indicated.

By screen

Descriptions of the keys and other information that appear in the main LCD screens are provided in the tables on pages 49 to 57. For details, refer to the page that is indicated.

By condition

Various possible conditions and the corresponding operations are described on page 58. For details, refer to the page that is indicated.

■ Searching the machine

This machine is equipped with a help feature.

Learning how to perform an operation

Touch the machine operations guide key, and then check for the desired information. For details on using the machine operations guide key, refer to page 151.

Learning how to use a screen feature

Touch the help key, and then check for the desired information. For details on using the help key, refer to page 153.

Contents

Important Safety Instructions	i
License Agreement	v
Warning Labels	vi
Precautions	vii
Concerning optional embroidery cards	vii
Concerning USB media	vii
Machine Structure and Features	viii
Six-needle machine embroidering	viii
Differences with single-needle machines	ix
Other features	x
Available features.....	xi
Manual Structure	xii
Read before use	xii
Read when additional information is required	xii
Searching for information	xii
Contents	xiii
GETTING READY	1
Names of Machine Parts and Their Functions	2
Front view	2
Right-side/rear view	3
Operation panel	3
Included Accessories	4
Accessories	4
Optional Accessories	5
Setting Up the Machine	6
Setup and transporting precautions	6
Setup location	7
Setting up the machine.....	8
Adjusting the operation panel position	9
Preparing the thread guide assembly	10
Positioning the spool stand.....	11
Attaching the embroidery frame holder	11
EMBROIDERING TUTORIAL	13
Operating Precautions	14
Power supply precautions	14
Needle precautions	15
Checking the needle	15
Bobbin precautions.....	15
Upper thread recommendations.....	16
Fabric recommendations.....	16
Display recommendations.....	16
Basic Procedures	17
Installing the Bobbin	18
Removing the bobbin case	18
Installing the bobbin	19
Installing the bobbin case.....	19
Turning ON the Machine	20
Understanding the screens	21
Screen overview.....	22
Selecting an Embroidery Pattern	23
Selecting an embroidery pattern.....	24
Editing the Embroidery Pattern	25
Continuing to the embroidering settings screen	25
Specifying Embroidering Setting	26

Previewing the Image	27
Checking a preview image	27
Hooping the Fabric in the Embroidery Frame	28
Hooping the fabric in the embroidery frame.....	28
Attaching the Embroidery Frame to the Machine	30
Attaching the embroidery frame	30
Checking the Embroidery Area	32
Continuing to the embroidering screen	32
Upper Threading	33
Checking the needle bars and thread colors	33
Upper threading.....	35
Threading the needle	39
Sewing the Embroidery	42
Starting embroidering.....	42
Stopping embroidering.....	44
Checking the Thread Tension	45
Removing the Embroidery Frame and Fabric	46
Removing the embroidery frame	46
Removing the fabric	46
Turning OFF the Machine	47
Screen Quick Reference Guide	49
Key displays	49
Common screen controls	49
Understanding the pattern type selection screen	50
Understanding the pattern list screen	51
Understanding the pattern editing screen	52
Understanding the embroidering settings screen	54
Understanding the embroidering screen.....	56
When You Have a Question, This May Help You	58
TECHNICAL TERMS:	58
PATTERNS:	59
EMBROIDERING:	59

OTHER BASIC PROCEDURES **61**

Resume the Operation Being Performed Before the Machine Was Turned OFF	62
Changing the Needle	63
Replacing the needle.....	63
Correctly Using the Embroidery Frames	65
Embroidery frame types and applications	65
Attaching Iron-On Stabilizer (Backing) to Fabric	66
Hooping the Fabric	67
Hooping the fabric in the extra-large and large embroidery frames	67
Using the embroidery sheet.....	68
Large/small pieces of fabric	69
Embroidery Frame Position and Movement	70
Changing the Embroidering Position	72
Adjusting the angle	73
Embroidering a Pattern Containing Seven or More Colors	75
Checking if thread spool changes are necessary	75
Changing the Thread Spools with Designs of Seven or More Colors	77
Change thread spools message.....	77
Easily changing the thread spools.....	78
If the Thread Breaks or the Bobbin Thread Runs Out While Embroidering	79
If the upper thread breaks.....	79
If the bobbin thread breaks or runs out.....	80
Embroidering From the Beginning or Middle of the Pattern	81
Resume Embroidering After Turning OFF the Machine	83
Adjusting the Thread Tension	85
Adjusting the tension of the bobbin thread	85
Adjusting the tension of the upper thread	86

EMBROIDERING SETTINGS

87

Automatic Lock Stitch Setting	88
Starting/Ending Position Settings	89
Repeatedly sewing a pattern along a diagonal	90
Maximum Sewing Speed Setting	91
Setting the Machine to Stop at Color Changes	92
Stopping the machine at the next color change	92
Specifying pause locations before embroidering	92
Temporary Needle Bar Setting	94
Reserved Needle Bar Settings	96

SELECTING/EDITING/SAVING PATTERNS

99

Embroidery Data Precautions	100
Selecting an Embroidery Pattern	102
General pattern selection	102
Embroidery patterns	104
Renaissance Alphabet Patterns	105
Floral alphabet patterns	106
Appliqué alphabet	107
Frame patterns	108
Alphabet patterns	109
Embroidery patterns stored in the machine	111
Embroidery cards (optional)	112
Computer (USB)	114
USB media (Commercially Available)	117
Editing the Embroidery Pattern (Pattern Editing Screen)	119
Combining patterns	119
Selecting the pattern to be edited	120
Moving a pattern	120
Flipping a pattern horizontally	121
Flipping a pattern vertically	121
Changing the size of a pattern	121
Rotating a pattern	122
Changing the text arrangement of a character	123
Changing the character spacing	124
Changing the thread density (only for some character and frame patterns)	125
Specifying multi-color text	126
Changing the colors of the pattern	127
Deleting a pattern	128
Editing the Embroidery Pattern (Embroidering Settings Screen)	129
Rotating the entire pattern	129
Creating a repeating pattern	130
Changing the colors of the pattern	131
Editing a Combined Pattern	132
Saving Embroidery Patterns	136
Machine's Memory	136
If the Embroidery Pattern Cannot Be Saved	136
USB Media (Commercially Available)	137

BASIC SETTINGS AND HELP FEATURE

139

Using the Settings Key	140
Understanding the settings screen	140
Adjusting the brightness of the LCD	142
Turning the buzzer on or off	142
Changing the language	143
Changing the units of measurements	143
Changing the display guides	143
Changing the thread color information	145
Display expanded thread color	146
Custom thread table settings	147

Specifying jumpstitch trimming / "DST" jump codes for trimming	149
Deleting short stitches	150
Specifying the remaining length of thread	150
Using the Machine Operations Guide Key	151
Using the Help Key.....	153
APPENDIX	155
 Appliqué Sewing.....	156
Sewing appliqué patterns	156
Using a frame pattern to create appliqués (1)	157
Using a frame pattern to create appliqués (2)	158
 Helpful Tips for the Operation of the Machine	160
Checking the thread tension of built-in patterns	160
Sewing a pattern aligned with a mark on the fabric	161
Color thread table	163
Colors of Tajima (.dst) embroidery data	163
 Creating Beautiful Embroidery	164
Threads	164
Stabilizers (Backing)	165
Hooping Techniques	166
Fabric/stabilizer compatibility chart	167
OPTIONAL ACCESSORIES	
 Attaching an optional embroidery frame for industrial embroidery machines	168
 Using the Optional Cap Frame	169
Cap frame and its accessories	169
Types of caps	170
Fabric precautions.....	171
Preparing to use the cap frame	171
Attaching the standard cap frame to the mounting jig and putting a cap into the frame	176
Attaching the advanced cap frame to the mounting jig and putting a cap into the frame	180
Installing the embroidery frame holder	185
Additional digitizing information.....	186
 Using the Optional Bobbin Winder	188
Precautions	188
Optional bobbin winder and its accessories	188
Setting up the optional bobbin winder	189
Connecting the AC adapter	189
Winding the bobbin	190
 Maintenance.....	193
Cleaning the LCD.....	193
Cleaning the machine surface	193
Cleaning the hook.....	193
Cleaning around the needle plate.....	194
Cleaning the bobbin case.....	195
Oiling the machine	196
 Troubleshooting	198
On-screen troubleshooting.....	198
Troubleshooting	199
Error messages	207
If the LCD cannot be read	213
If the machine does not respond when a key is pressed.....	213
 Specifications	215
Embroidery machine specifications	215
 Index	216

1

GETTING READY

After unpacking the machine, first refer to “Included Accessories” on page 4, and check that all listed accessories are included. After checking that all accessories are included, the embroidery machine can be set up.

The setup of the machine and the various preparations required before starting to sew are described in this chapter.

Names of Machine Parts and Their Functions	2
Front view / 2	
Right-side/rear view / 3	
Operation panel / 3	
Included Accessories	4
Accessories / 4	
Optional Accessories	5
Setting Up the Machine.....	6
Setup and transporting precautions / 6	Setup location / 7
Setting up the machine / 8	Adjusting the operation panel position / 9
Preparing the thread guide assembly / 10	Positioning the spool stand / 11
Attaching the embroidery frame holder / 11	

Names of Machine Parts and Their Functions

The names of the various parts of the sewing machine and their functions are described below. Before using the sewing machine, carefully read these descriptions to learn the names of the machine parts.

Front view

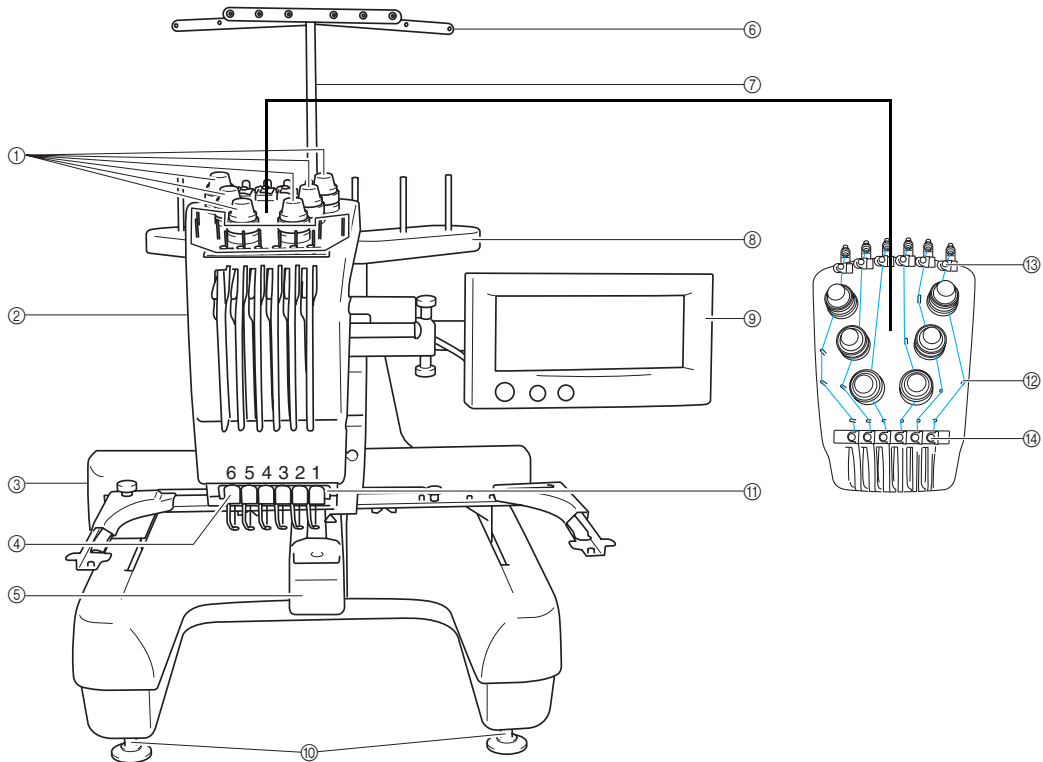

① Thread tension knobs

Adjusts the tension of the thread.

② Needle bar case

The case moves to the left and right to move the needle to the embroidering position.

③ Carriage

Attach the embroidery frame to the carriage. When the machine is turned on or when the machine does embroidery, the carriage moves forward, backward, left and right.

④ Lower thread guide

⑤ Hook cover/Hook

Open the hook cover, and then insert the bobbin case into the hook.

⑥ Thread guide

⑦ Thread guide assembly support

⑧ Spool stand

Put 6 thread spools to embroider.

⑨ Operation panel

⑩ Feet

Use the feet to adjust the height of the legs.

⑪ Sewing light

⑫ Thread guide pins

⑬ Upper thread guide

⑭ Middle thread guide

Right-side/rear view

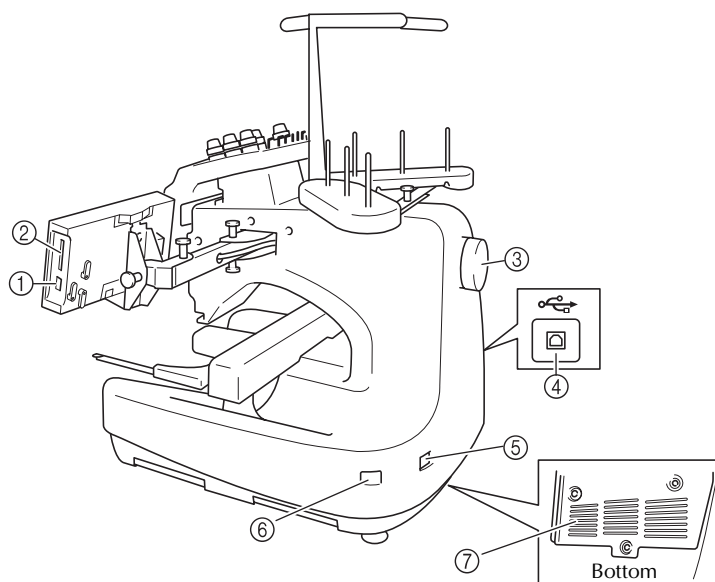

- ① **USB Type "A" (host) port connector**
When using USB media, plug the USB media into the USB Type "A" (host) port connector.
- ② **Embroidery card slot**
Insert the embroidery cards (sold separately) into the embroidery card slot.
- ③ **Handwheel**
Rotate the handwheel to move the needle up and down. Be sure to rotate the handwheel counterclockwise.
- ④ **USB Type "B" (function) port connector**
When sending patterns from a computer to the machine, plug the USB cable from the computer into the USB Type "B" (function) port connector.
- ⑤ **Power supply plug**
Insert the plug on the power supply cord into the power supply plug.
- ⑥ **Main power switch**
Use the main power switch to turn the machine ON (I) and OFF (O).
- ⑦ **Ventilation slots**

Operation panel

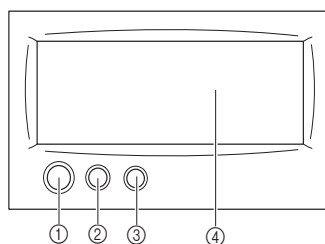











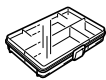













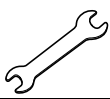





- ① **Start/stop button**
Press the start/stop button to start or stop machine. The lighting status and color of the button changes depending on the operation condition of the machine.
Lit in red : When the machine cannot start sewing
Flashing in green: When the machine can start sewing
Lit in green : While the machine is sewing
Off : When the machine is turned off
- ② **Thread trimming button**
Press the thread trimming button to trim both the upper and the bobbin threads.
- ③ **Automatic needle-threading button**
Press the automatic needle threading button to thread the needle.
- ④ **LCD (touch panel)**
Touch the keys that appear on the touch panel to select and edit patterns and confirm various information.

Included Accessories

After opening the box, check that the following accessories are included. If any item is missing or damaged, contact your retailer.

Accessories

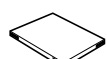
The accessories listed below are included with this machine. Make sure to use the accessories supplied with this machine.

1. 	2. 	3. 
4. 	5. 	6. 
7. 	8. 	9. 
10. 	11. 	12. 
13. 	14. 	15. 
16. 	17. 	18. 
19. 	20. 	21. 
22. 	23. 	24. 
25. 	26. 	27. 
28. 	29. 	30. 
31. 	32. 	

No.	Part Name	Model Name	Parts Code
1	Accessory case		XC6482-051
2	Needle set (2 pcs.)	PRHA1BR11	XC6469-001
3	Prewound bobbin (6 pcs.)		XC6368-051
4	Spool net (6 pcs.)		S34455-000
5	Seam ripper		X54243-051
6	Scissors		XC1807-121
7	Tweezers		XC6542-051
8	Touch pen		XA9940-051
9	Needle changing tool (Threader)		XC4957-051
10	Needle plate spacer		XC6499-151
11	Phillips screwdriver		XC6543-051
12	Standard screwdriver		X55468-051
13	Allen screwdriver		XC5159-051
14	Offset screwdriver		XC6545-051
15	Disc-shaped screwdriver		XC1074-051
16	Wrench 13 x 10		XC6159-051
17	Oiler		XZ0206-051
18	Clean brush		X59476-051
19	Weight		XC5974-151
20	USB cable		XD1563-051
21	Embroidery frame (extra large) 200 mm (H) x 300 mm (W) (7-7/8 inches (H) x 11-3/4 inches (W))	PRH300	XC6284-052
22	Embroidery frame (large) 130 mm (H) x 180 mm (W) (5-1/8 inches (H) x 7-1/8 inches (W))	PRH180	XC6285-052
23	Embroidery frame (medium) 100 mm (H) x 100 mm (W) (4 inches (H) x 4 inches (W))	PRH100	XC6286-052
24	Embroidery frame (small) 40 mm (H) x 60 mm (W) (1-1/2 inches (H) x 2-3/8 inches (W))	PRH60	XC6287-052
25	Embroidery sheet (extra large) 200 mm (H) x 300 mm (W) (7-7/8 inches (H) x 11-3/4 inches (W))		XC5704-051
26	Embroidery sheet (large) 130 mm (H) x 180 mm (W) (5-1/8 inches (H) x 7-1/8 inches (W))		XC5721-051
27	Embroidery sheet (medium) 100 mm (H) x 100 mm (W) (4 inches (H) x 4 inches (W))		XC5759-051
28	Embroidery sheet (small) 40 mm (H) x 60 mm (W) (1-1/2 inches (H) x 2-3/8 inches (W))		XC5761-051
29	Operation manual		XD1133-051
30	Quick reference guide		XD0754-051
31	Spool mat (6pcs.)		XC7134-051
32	Spool cap (6pcs.)		130012-054

Optional Accessories

The following are available as optional accessories.

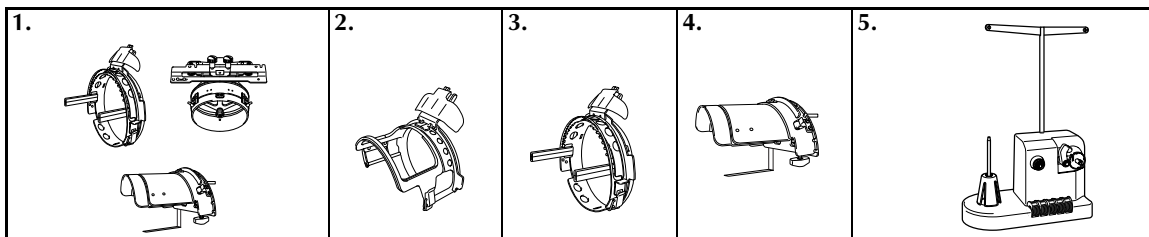

1. Advanced cap frame set

Model Name: PRCF2
Parts Code: XC7609-052

2. Standard cap frame

Model Name: PRCFH1
Parts Code: XC6958-052

3. Advanced cap frame

Model name: PRCFH2
Parts Code: XC7610-052

4. Hooping jig

Model name: PRCFJ2
Parts Code: XC7611-052

5. Bobbin winder set

Model Name: PRBW1
Parts Code: XC6290-052
XC6290-061(for Australia)
(See instructions on page 188.)

(See instructions on page 169.)

6. Embroidery card



Note

- The parts code may be differ depending on the area where the machine was purchased.
- Embroidery cards sold overseas are not compatible with this embroidery machine.

No.	Part Name	Model Name	Parts Code
1	Alphabet	SA298	X58317-003
2	Flower	SA299	X58321-003
10	Monogram Emblem	SA307	X59567-003
11	Frame	SA311	XA0257-001 *
12	Transportation	SA312	XA0275-001 *
13	Sports Emblem	SA313	XA0517-003
14	Large Floral	SA314	XA1223-003
16	Dogs & Cats	SA316	XA1406-003
19	Marine	SA319	XA2452-001 *
20	Petite Designs	SA320	XA2869-003
25	Horse	SA325	XA3791-003
27	Birds	SA327	XA4289-003
28	Christmas	SA328	XA4502-003
29	Lace	SA329	XA4664-003
30	Wildlife Animals	SA330	XA4771-003
31	Large Flower II	SA331	XA5037-003
32	Musical Instrument	SA332	XA5386-001 *
33	Trees	SA333	XA5567-003
35	Cats & Dogs II	SA335	XA5629-003
36	Fruits & Vegetables	SA336	XA5659-003
37	Appliqué Alphabet	SA337	XA5753-003
38	Angel	SA338	XA5781-001 *
39	Doll Face	SA339	XA5978-001 *
40	Sports 3	SA340	XA6111-001 *
41	Renaissance Alphabet	SA341	XA6586-003
42	Farm	SA342	XA6733-003
43	Victorian	SA343	XA6769-003
44	Lace2	SA344	XA6849-003

No.	Part Name	Model Name	Parts Code
45	Fancy Work	SA345	XA7770-003
47	Butterfly	SA347	XA8206-003
49	Folk Art	SA349	XA8348-001 *
50	Fairy & Floral	SA350	XA8414-003
51	Paper Dolls	SA351	XA8563-001 *
52	Bear Collections	SA352	XA8511-003
53	Scene	SA353	XA8936-003
54	Tea Time	SA354	XA9129-001 *
55	Gardening	SA355	XA9348-003
56	Asian	SA356	XC0025-003
57	Large Christmas	SA357	XC0057-001 *
58	New Quilt Traditions	SA358	XC0861-003
60	Summer Fun	SA360	XC1168-001 *
61	Blouse Embellishment	SA361	XC1304-003
62	Zodiac Signs	SA362	XC1502-001 *
63	Bunny	SA363	XC1646-001 *
64	Grand Mom	SA364	XC2176-003
65	Red Work	SA365	XC4220-003
66	Pop Mix	SA366	XC4819-003
67	Home Dec	SA367	XC7048-003
68	Cross Stitch Collection 1	SA368	XC7097-003
69	Sport Shirt Motifs	SA369	XC7274-003
70	Cross Stitch Collection 2	SA370	XC7550-003
71	Heir loom	SA371	XC9094-003
72	Cross Stitch Collection 3	SA372	XC9082-003
73	Japanese Style	SA373	XC0130-003
74	Scrapbooking	SA374	XD1091-003
75	Lace Collection	SA375	XD1193-003

* Discontinued



Memo

- Contact your nearest authorized dealer to order additional parts and optional accessories by using the correct part number.

Setting Up the Machine

The procedures for setting up the machine are described below. If the machine is not set up correctly, it may shake or produce loud noises and the embroidery will not be sewn correctly. An optional sewing stand is also available.

Setup and transporting precautions

! CAUTION

- The temperature of the operating environment should be between 5 °C (40 °F) and 40 °C (104 °F) . If the machine is operated in an environment that is either too cold or too hot, the machine may malfunction.
- Do not use the machine in a location where it will be exposed to direct sunlight, otherwise the machine may malfunction.
- Set up the machine with four feet completely in contact with the desk or table, so that the machine is level.
- Do not put anything under the embroidery machine that could block the ventilation slots at the bottom toward the back and do not allow lint or dust to accumulate in the ventilation slots, otherwise the machine's motor may overheat, resulting in a fire or in damage to the machine.
- The machine weight is approximately 37 kg (81 lbs.). The transporting or setting up of the embroidery machine should be performed by two people.
- When transporting the machine, be sure to lift it from the bottom at the indicated positions by two people. Lifting the machine from any other area may damage the machine or result in the machine falling, which could cause injuries.

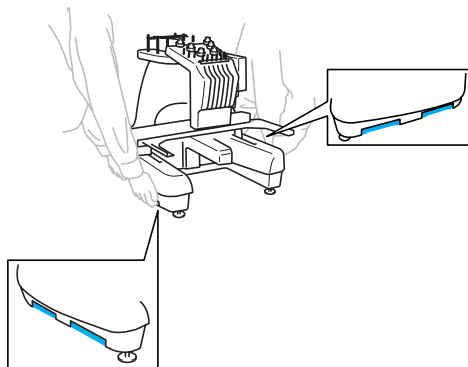

- When lightning occurs, turn off the machine and unplug the power supply cord. Lightning may cause the machine to malfunction.
- Do not plug in the power supply cord until setup of the machine is completed, otherwise injuries may result if the start/stop button is accidentally pressed and the machine starts sewing.
- When lubricating the machine, wear protective eyeglasses and gloves to prevent the oil or grease from getting into your eyes or on your skin. Do not put the oil or grease into your mouth. Keep the oil and grease out of the reach of children.

Setup location

Setup the machine in a location that meets the following requirements.

- Position machine more than 50 mm (2 inches) from the wall
- Allow sufficient space around the machine
- Place no objects within the moving range of the embroidery frame
- Set-up machine near an electrical outlet
- Use a level and stable surface, such as a desk
- Use a surface that can support the weight of the machine (about 37 kg (81 lbs.))
- Allow open space around the ventilation slots at the bottom toward the back

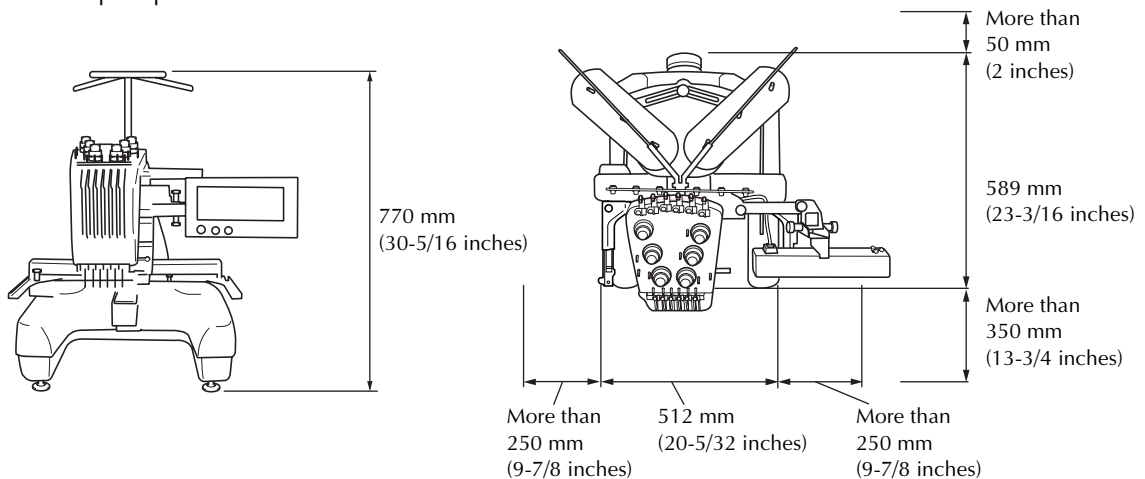

CAUTION

- In order to prevent malfunctions or damage, do not set up the machine in a location exposed to the following conditions.

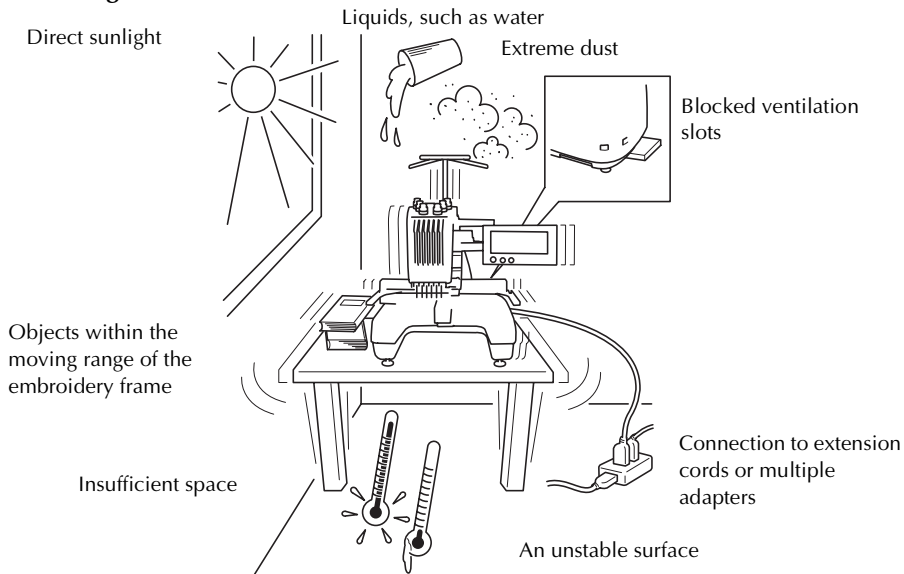

Extremely high or extremely low temperatures (The operating environment should be between 5 °C (40 °F) and 40 °C (104°F))



Note

- For your safety: Since the machine weighs approximately 37 kg (81 lb.), do not set it up on an unstable table or desk.

Setting up the machine

When setting up the machine, adjust the legs so that the machine is steady.

- 1 Make sure that all packing tape affixed to the machine is peeled off and that all packing material is removed.
- 2 Set up the machine while making sure that there is sufficient space around it.

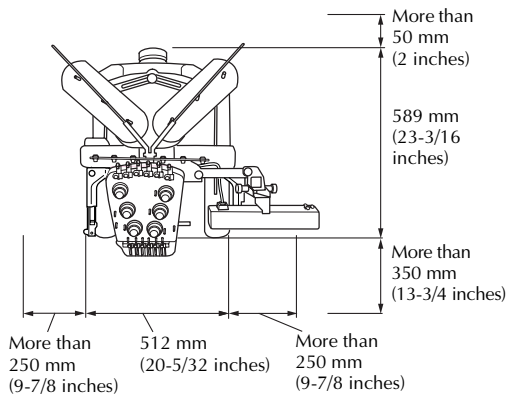

- 3 Adjust the legs so that the machine is steady. Use the included wrench to loosen the lock nut on the leg that you wish to adjust.

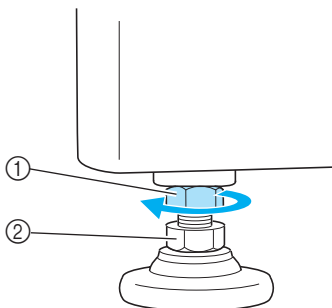

- 1 Lock nut
- 2 Adjustable foot nut

► The foot can be turned.

- 4 Use the included wrench to turn the adjustable foot nut on the foot. Turning the nut in direction 1 lengthens the leg; turning the nut in direction 2 shortens the leg.

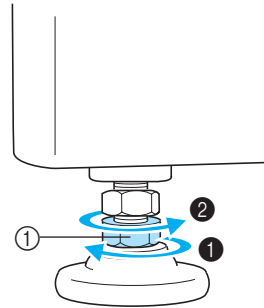

- 1 Adjustable foot nut
 - Adjust all four legs so that they securely contact the desk or table.

- 5 After adjusting the legs to the desired length, use the included wrench to tighten the nuts.

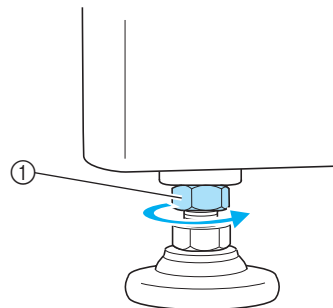

- 1 Lock nut

- 6 Press down on each corner of the embroidery machine to check that it is stable. If it is still unstable, perform steps 3 through 5 again to adjust the legs.

Adjusting the operation panel position

Adjust the orientation and angle of the operation panel so it can easily be operated.

- 1 Loosen 2 thumb screws to bring the operation panel forward.

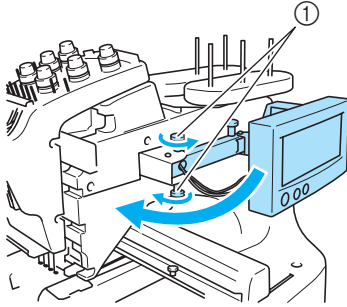

① Thumb screws

- 2 Adjust the operation panel to an easy-to-operate position, and then tighten the thumb screws.

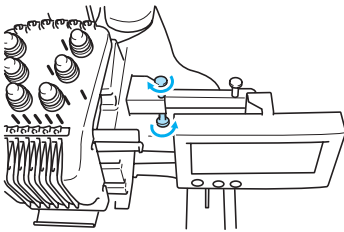

- 3 Adjust the orientation of the operation panel. Loosen the thumb screw, adjust the operation panel to an easy-to-view orientation, and then tighten the thumb screw.

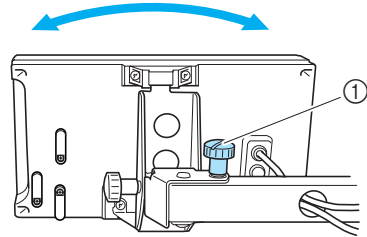

① Thumb screw

- 4 Adjust the angle of the operation panel. Loosen the 2 thumb screws behind the operation panel, adjust the operation panel to an easy-to-view angle, and then tighten the thumb screws.

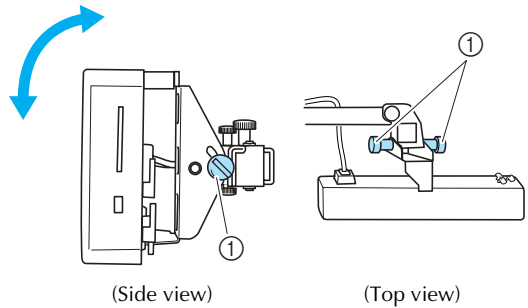

① Thumb screws

Note

- Using the disc-shaped screwdriver included, loosen and firmly tighten the five thumb screws.

Preparing the thread guide assembly

Raise the thread guide assembly. Locate the included Phillips screwdriver.

- 1** Using the Phillips screwdriver, loosen the screws on the left side of the thread guide assembly support so that the thread guide assembly can be raised.

Remove screw ①, and then turn screw ② three or four times to loosen it.

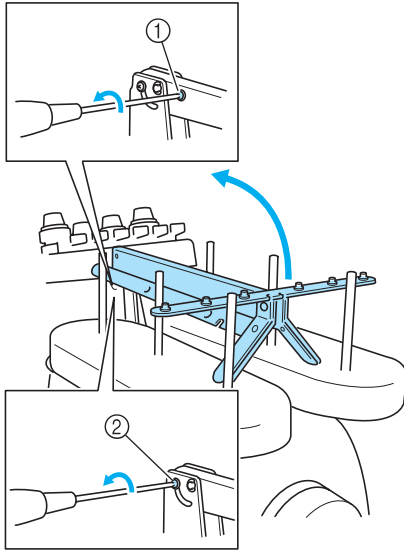

- ① Remove the screw.
② Turn the screw three or four times to loosen it.

- 2** Raise thread guide into position and tighten screw ② on the left. Insert screw ① into right side of the thread guide assembly support and tighten.

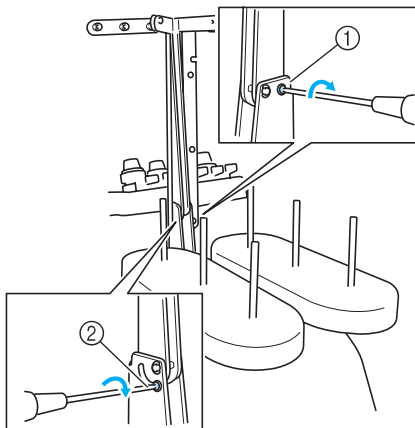

- ① Insert screw and tighten.
② Tighten screw.

- 3** Using the Phillips screwdriver, loosen the screws on the left and right sides of the thread guide assembly and lift up the thread guide so that it is level.

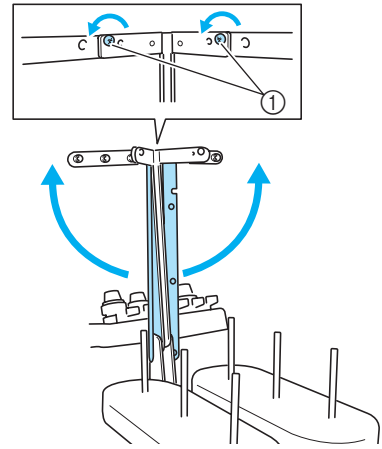

- ① Loosen Screws

- 4** Tighten the screws on the left and right sides of the thread guide assembly.

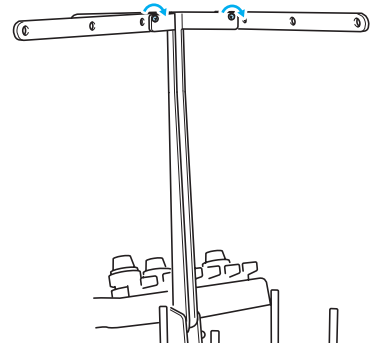

Note

- If the screws are not loosened enough, it may not be easy to move the thread guide assembly support and the thread guide. Do not apply extreme force when moving the thread guide assembly support and the thread guide. Be sure that the screws are loosened well enough before moving these parts.
- Be sure to tighten each screw well enough that the thread guide assembly support and the thread guide are secured.

Positioning the spool stand

Secure the spool stand in the embroidering position.

- 1 Loosen the thumb screw, and then open up the spool stand to the left and right.

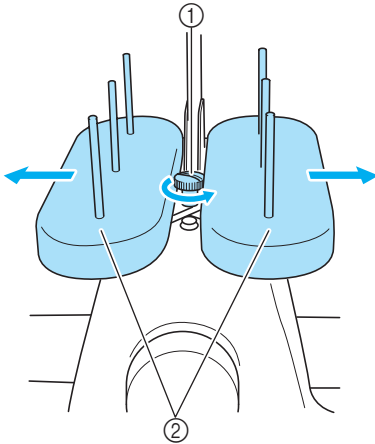

- ① Thumb screw
- ② Spool stand

- 2 After the spool stand is fully opened up, tighten the thumb screw.

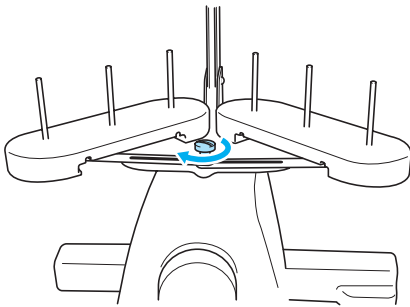

- Secure the spool stand in the opened position.

Attaching the embroidery frame holder

Attach the embroidery frame holder to the carriage.

- 1 Remove the two thumb screws of the embroidery frame holder.

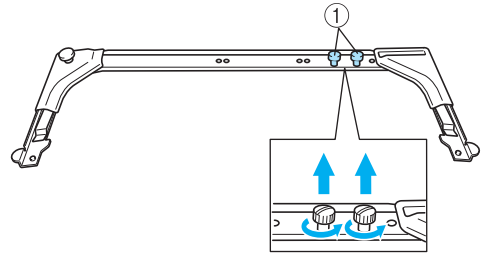

- ① Thumb screws

- 2 Align the holes in the embroidery frame holder with the pins on the frame-mounting plate of the carriage.

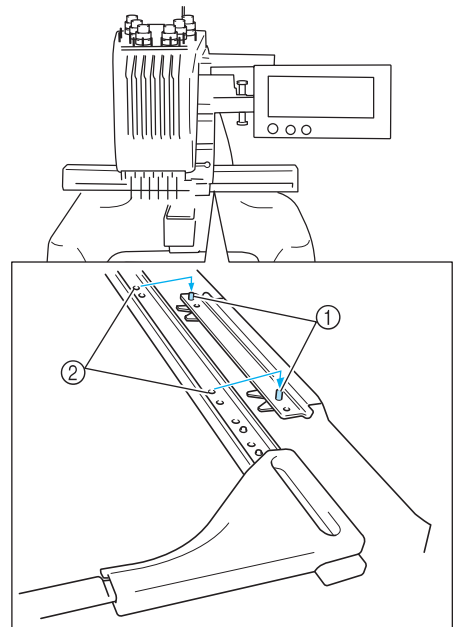

- ① Pins on the frame-mounting plate
- ② Holes in the embroidery frame holder

- 3** Secure the embroidery frame holder with the two thumb screws.

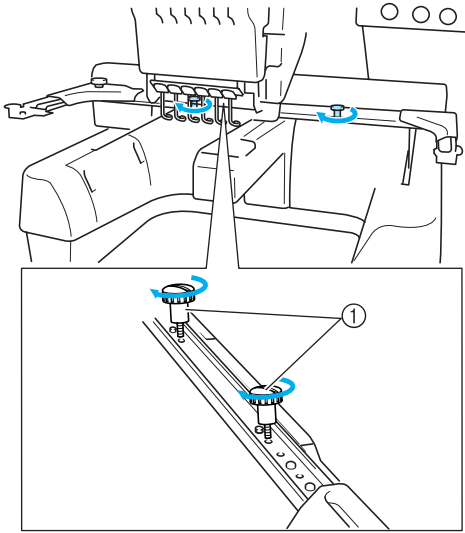

- ① Use the thumb screws removed in step ①.

**Note**

- Using the disc-shaped screwdriver included, firmly tighten the thumb screws.

This completes the preparation of the machine.

2**EMBROIDERING TUTORIAL**

This chapter describes the basic embroidering operations in order—from turning on the machine and sewing a pattern to finishing sewing. Follow the steps of the tutorial to embroider a pattern and master the operation of this embroidery machine.

Operating Precautions	14
Basic Procedures	17
Screen Quick Reference Guide	49
When You Have a Question, This May Help You	58

Installing the Bobbin	1
Turning ON the Machine	2
Selecting an Embroidery Pattern	3
Editing the Embroidery Pattern	4
Specifying Embroidering Setting	5
Previewing the Image	6
Hooping the Fabric in the Embroidery Frame	7
Attaching the Embroidery Frame to the Machine	8
Checking the Embroidery Area	9
Upper Threading	10
Sewing the Embroidery	11
Checking the Thread Tension	12
Removing the Embroidery Frame and Fabric	13
Turning OFF the Machine	14

Operating Precautions

The necessary points to ensure the correct operation of this machine are described below.

Power supply precautions

Be sure to observe the following precautions concerning the power supply.

WARNING

- Use only regular household electricity for the power source. Using other power sources may result in fire, electric shock, or damage to the machine.
- If any of the following occur, turn off the embroidery machine and unplug the power supply cord, otherwise a fire, an electric shock or damage to the machine may result.
 - When you are away from the machine.
 - After using the machine.
 - If a power outage occurs while the machine is being operated.
 - If the machine is not operating properly, for example, when there is a loose or cut connection.
 - During electrical storms.

CAUTION

- Do not plug this machine in with extension cords or multi-plug adapters with many other appliances plugged into them, otherwise a fire or an electric shock may result.
- Do not plug in or unplug the power supply cord with wet hands, otherwise an electric shock may result.
- When unplugging the power supply cord, be sure to first turn off the machine, and then grasp the plug when unplugging the cord. Pulling on the cord may damage it or result in a fire or an electric shock.
- Do not allow the power cord to be cut, damaged, modified, forcefully bent, pulled, twisted, or bundled. In addition, do not place heavy objects on the cord or expose it to heat, otherwise damage to the cord, fire or an electric shock may result. If the power supply cord or its plug is damaged, stop using the machine, and then take the machine to your nearest authorized retailer for repairs before continuing use.
- If the machine is not to be used for a long period of time, unplug the power supply cord, otherwise a fire may result.

Needle precautions

Be sure to observe the following precautions concerning the correct choice of needle for your machine.

CAUTION

- Your machine is designed to use household embroidery needles. The factory recommended needle is “HAX 130 EBBR” (Organ). Schmetz needles 130/705 H-E may be used as a substitute. Use of any other needles may break the needle or thread or damage the needle-threading mechanism or result in injuries.
- Never use bent needles. Bent needles can easily break, possibly resulting in injuries.

Checking the needle

Sewing with a bent needle is extremely dangerous since the needle may break while the machine is being operated.

Place the flat side of the needle on a flat surface and check that the distance between the needle and the flat surface is even. If the needle is bent or the tip of the needle is broken, replace the needle with a new one. (Refer to “Changing the Needle” on page 63.)

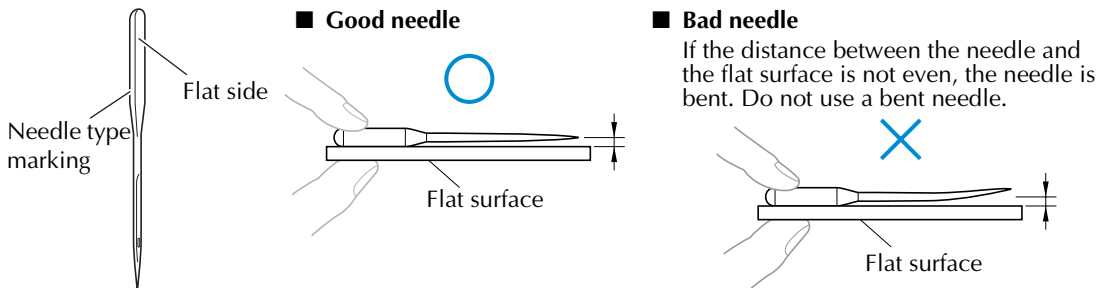

Bobbin precautions

Be sure to observe the following precautions concerning the bobbin.

CAUTION

- Only use prewound bobbin (COATS “L” type/TRU-SEW POLYESTER “Filaments”) or bobbins designed specifically for this machine. Use of any other bobbin may result in injuries or damage to the machine.

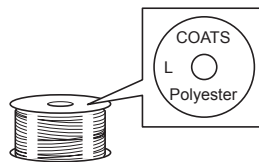

- Use a bobbin thread that has been correctly wound, otherwise the needle may break or the thread tension will be incorrect.

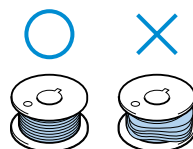

- When winding a bobbin, only use optional bobbin winder (refer to page 188) and metal bobbins (Parts Code: 100376-053).
- When winding the bobbin, be sure to use cotton or spun polyester bobbin thread (between 74 dtex/2 and 100 dtex/2).

Upper thread recommendations

Be sure to observe the following recommendations concerning the upper thread.



Note

- It is recommended that rayon or polyester embroidery thread be used (120 den x 2 / 135 dtex x 2 / 40 weight (in Americas and Europe) / #50 (in Japan)).

Fabric recommendations

Be sure to observe the following recommendations concerning the fabric.



Note

- Your machine can embroider fabric that is up to 1 mm (3/8 inch) thick. If thicker fabric is sewn, the needle may bend or break.
- When embroidering overlapping stitches, it is difficult for the needle to penetrate the fabric, possibly resulting in the needle bending or breaking.



Note

- Attach stabilizers to thin or stretch fabrics. (Refer to “Attaching Iron-On Stabilizer (Backing) to Fabric” on page 66 for information)
- When embroidering large pieces of fabric, make sure that the fabric is not caught in the carriage.

Display recommendations

Be sure to observe the following recommendations concerning the use of the display.



Note

- Only touch the display with your finger or included touch pen. Do not use a mechanical pencil, screwdriver or any other hard or sharp object. In addition, do not apply extreme pressure to the display screen, otherwise damage to the display screen may result.
- All or part of the display screen may sometimes become darker or lighter due to temperature changes. This is not a sign of a malfunction. If the display is difficult to read, adjust its brightness. (Refer to “If the LCD cannot be read” on page 213.)
- The display may be dark immediately after the embroidery machine is turned on. This is a normal characteristic of the backlight and is not a sign of a malfunction. After approximately 10 minutes, the display should reach its normal level of brightness.
- If you are not directly facing the display, the colors may be distorted or the display may be difficult to read. This is a normal characteristic of the display and is not a malfunction. Be sure to sit in front of the display while using it.

Basic Procedures

Basic embroidering procedures are described below.

Check the overall procedure below, before operating the embroidery machine.

Procedure	Operation	Tutorial Reference Page	Operating Procedure Reference Page
1	Install the bobbin.	p. 18	p.15
2	Turn on the machine.	p. 20	p.14, 16
3	Select an embroidery pattern.	p. 23	
4	Edit the embroidery pattern.	p. 25	
5	Specify the embroidering settings.	p. 26	
6	Check the previewed image.	p. 27	
7	Hoop the fabric in the embroidery frame.	p. 28	p. 16
8	Attach the embroidery frame to the machine.	p. 30	
9	Check the embroidery area.	p. 32	
10	Thread the upper threads.	p. 33	p.16
11	Unlock the machine, then press the start/stop button to start embroidering. (Once embroidering is completed, the machine automatically stops.)	p. 42	
12	Check the thread tension.	p. 45	
13	Remove the embroidery frame, and then remove the fabric from the frame.	p. 46	
14	Turn off the machine.	p. 47	

(Example) Embroidery pattern



The operations to embroider the pattern shown at the left are described on the following pages.

Although embroidering can continue without the pattern being edited or embroidering settings being specified, refer to page 119 for details on editing the patterns, and refer to page 87 for details on specifying embroidering settings.

Descriptions of the keys and other information that appear in the main LCD screens are provided in the tables on pages 49 to 57. Use these tables for quick reference.

The various operating precautions that must be observed during the basic procedures are provided on pages 14 to 16. These precautions must be strictly observed in order for the machine to function properly. Make sure to read these precautions.

1. Installing the Bobbin

When the machine is purchased, only the bobbin case is installed in the hook. Insert a bobbin wound with bobbin thread for embroidering. For precautions concerning the bobbin, refer to page 15.



Note

- The machine cannot indicate how much bobbin thread is remaining. Before starting to embroider make sure that there is enough bobbin thread for the pattern.
- Make sure to clean the bobbin case every time the bobbin is changed. For details on cleaning the bobbin case, refer to “Cleaning the bobbin case” on page 195.

Removing the bobbin case

1

Open the hook cover.

Pull the hook cover toward you.

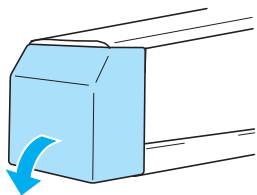

2

Pull the thread picker toward you.

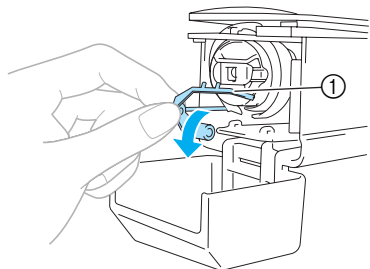

① Thread Picker

To gain access to the bobbin case easily, pull the thread picker toward front.



Note

- Thread picker is a device that is used to hold the thread when beginning to sew or when trimming the thread.



CAUTION

- The thread picker can only be moved within a certain range. Do not pull it with extreme force.

3

Grab the bobbin case latch, and remove the bobbin case.

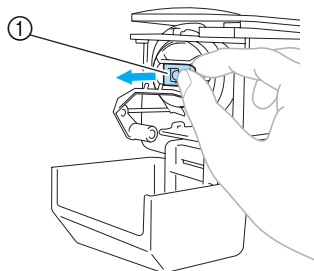

① Latch

■ Oiling the machine

After removing the bobbin case, apply oil to the machine. The race should be oiled. For details on oiling the machine, refer to “Oiling the machine” on page 196.



Note

- Put a drop of oil onto the hook once a day before use.

Installing the bobbin

- 1 Insert the bobbin into the bobbin case.

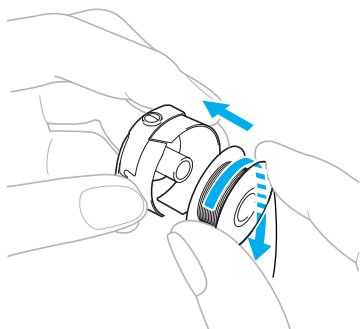

Note

- Check that the thread winds off the bobbin clockwise as shown in the illustration. If the bobbin is installed with the thread winding off in the opposite direction, the embroidery will not be sewn correctly.

- 2 Pass the thread through the thread slit and under the tension-adjusting spring.

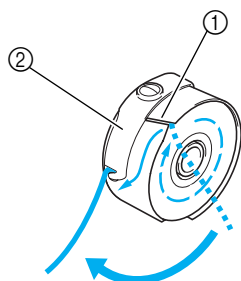

- 1 Thread slit
- 2 Tension-adjusting spring

- 3 Pull the thread through the opening in the tension-adjusting spring.

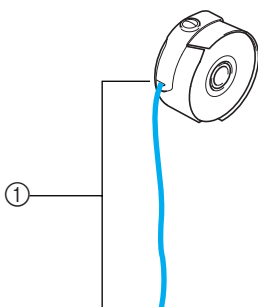

- 1 Pull out about 50 mm (2 inches) of thread.

Installing the bobbin case

- 1 Insert the bobbin case into the hook. Insert the bobbin case while aligning the tab on the bobbin case with the notch in the hook, as shown in the illustration.

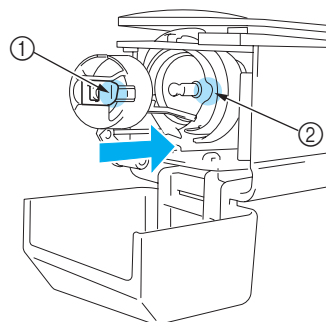

- 1 Tab
 - 2 Notch
- Fully insert the bobbin case until it snaps into place.

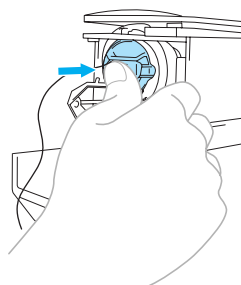

- 2 Close the hook cover.

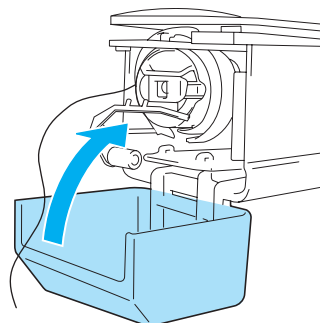

Memo

- This embroidery machine is not equipped with a bobbin-winder. Use pre-wound (L type) bobbins.
- The optional bobbin winder (stand-alone type) and optional metal bobbins can also be used. (Refer to page 5, 188.)

2

1

2

3

4

5

6

7

8

9

10

11

12

13

14

2. Turning ON the Machine

Connect the power supply cord, and then turn on the embroidery machine. For precautions concerning the power supply, refer to page 14.

- 1** Plug the power supply cord into the machine.

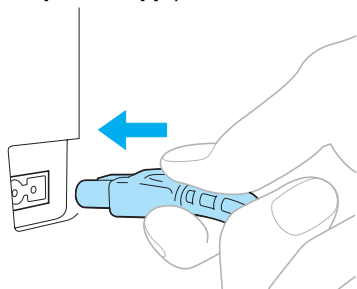

- 2** Insert the plug of the power supply cord into a household electrical outlet.

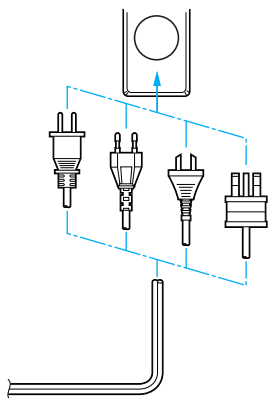

- 3** Switch on the main power switch on the back of the machine to "I".

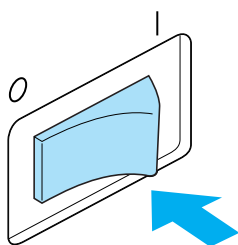

- ▶ The buzzer beeps once and the LCD screen comes on.

- 4** When the screen shown below appears after the initial screen, touch **OK**.



- ▶ The pattern type selection screen appears, and the start/stop button lights up in red.

- 5** The carriage moves to its initial position.
- If the number 1 needle bar is not already at the embroidering position, the needle bar case moves and the number 1 needle bar moves to the embroidering position.

CAUTION

- Make sure to keep your hands and other items away from the carriage, in order to prevent any injuries.

Note

- (For U.S.A. only)
This appliance has a polarized plug (one blade wider than the other). To reduce the risk of electrical shock, this plug is intended to fit into a polarized outlet in only one direction. If the plug does not fit fully in the outlet, reverse the plug. If it still does not fit, contact a qualified electrician to install the proper outlet. Do not modify the plug in any way.

Memo





- If the machine is turned off in the middle of embroidering, the machine will automatically save the design position when turned on again. At that time, you will be asked if you wish to continue embroidering or begin a new operation. (Refer to "Resume Embroidering After Turning OFF the Machine" on page 83.)

Understanding the screens

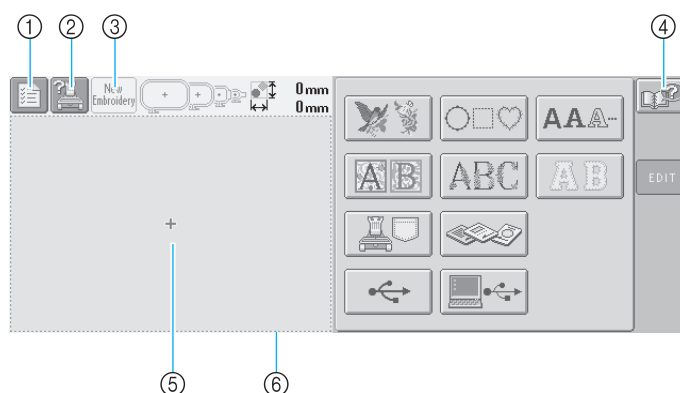
When the machine is turned on and **OK** is touched, the pattern type selection screen appears. The operations described below will be entered using the operation panel. For precautions concerning the use of the touch panel, refer to page 16.

The screen that appears the next time that the embroidery machine is turned on differs depending on how the machine was previously turned off. (Refer to page 62.)



No.	Display	Key Name	Function	Reference Page
①		Settings key	Touch this key to change the embroidery machine settings.	p. 140
②		Machine operations guide key	Touch this key to check a machine operation.	p.151
③		New embroidery key	Cancels all operations previously performed and returns to the initial pattern group selection screen.	
④		Help key	When a problem occurs, for example, there is an operating procedure that you do not know, touch this key to view solutions.	p. 153
⑤		Pattern display area	This area displays the selected pattern. The line ⑥ shows the embroidering area for the extra-large embroidery frame. The embroidery frame indications, the grid lines and other display settings can be specified from the machine settings screen.	p. 143

*The keys in the table above appear and can be used in most of the screens described later in this manual. The settings key cannot be used in the embroidering settings screen.

Screen overview

The basic operation flow is shown below.

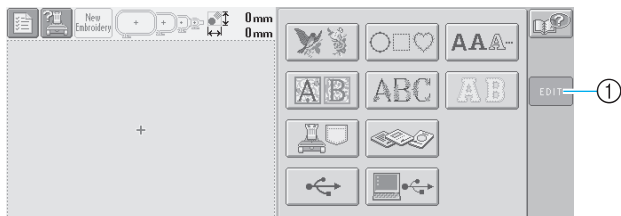

In the **pattern type selection screen**, select a pattern type. (Refer to page 23, 50)

- ① Touch this key to continue to the **pattern editing screen**. This key is not available unless a pattern type is selected.

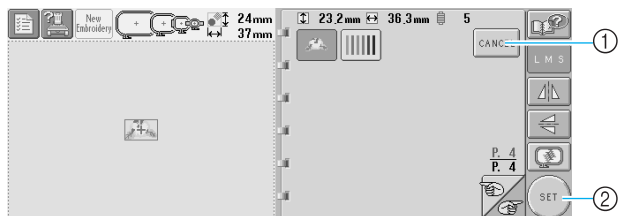

In the **pattern list screen**, select the pattern. (Refer to page 23, 51)

- ① Touch this key to return to the **pattern type selection screen**.
- ② Touch this key to continue to the **pattern editing screen**.

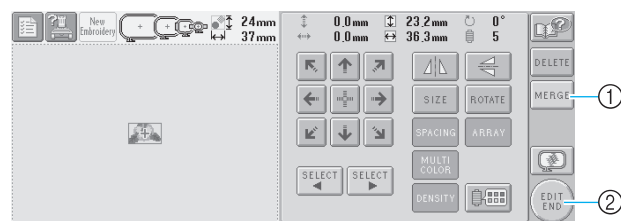

In the **pattern editing screen**, edit the pattern. (Refer to page 25, 52)

- ① Touch this key to return to the **pattern type selection screen** and add another pattern.
- ② Touch this key to continue to the **embroidering settings screen**.

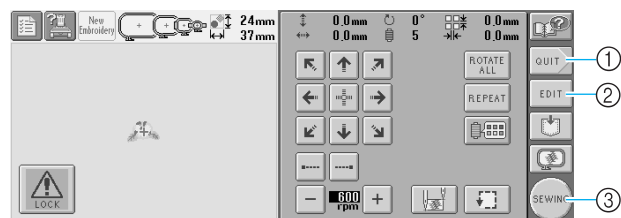

In the **embroidering settings screen**, if it is a combined pattern, edit the entire pattern, specify the embroidering settings and check the embroidery area. (Refer to page 26, 54)

- ① Touch this key to quit the current operation and return to the **pattern type selection screen**.
- ② Touch this key to return to the **pattern editing screen**.
- ③ Touch this key to continue to the **embroidering screen**.

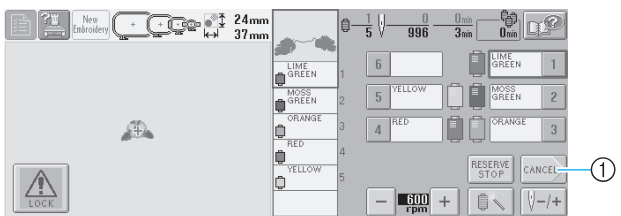

In the **embroidering screen**, check the thread colors assigned to the needle bars, and then install

the upper threads. Touch the unlock key  so that the start/stop button starts flashing in green and the embroidery machine is ready to begin sewing. After the embroidery is sewn, the **embroidering settings screen** appears. (Refer to page 33, 56)

- ① Touch this key to return to the **embroidering settings screen**.

3. Selecting an Embroidery Pattern

As an example, we will select the pattern shown at the right, on the last page of the embroidery patterns.



In the pattern type selection screen, select a pattern category (type).

Pattern type selection screen (For details on the keys and other information on the screen, refer to page 50.)

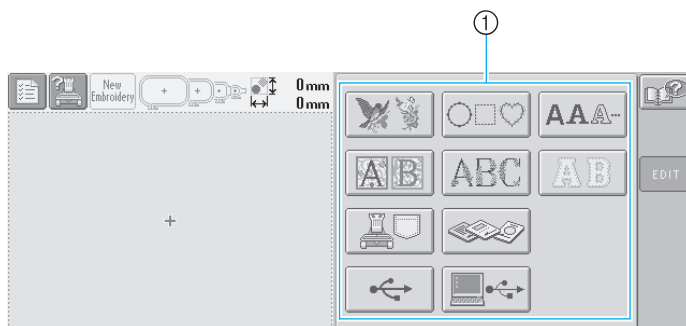

① Pattern type keys

In the pattern list screen, search for the desired pattern, and then touch the key for the pattern.

Pattern list screen (For details on the keys and other information on the screen, refer to page 51.)

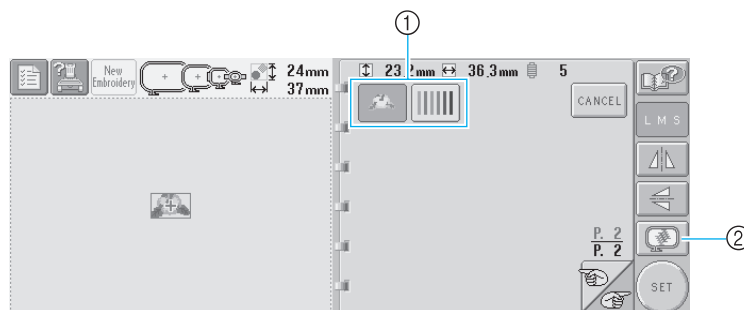

① Pattern keys

② Displays a preview image.

■ Checking a preview image from the pattern selection screen

Touch  to preview the image prior to selecting.

Touch  to return to the pattern selection screen.

Selecting an embroidery pattern

We will select a floral on the second page.

- 1** Touch  to select the embroidery patterns category.

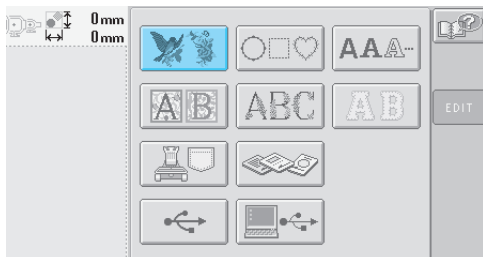

► The list of embroidery patterns appears.

- 2** Touch  and  until the desired page is displayed.

For this example, display the last page.

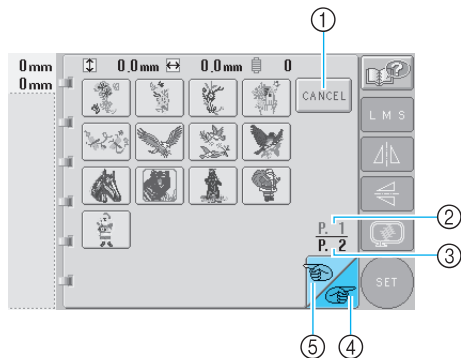

- To select a pattern group other than the embroidery patterns, touch
 - 1 Cancel key
 The pattern type selection screen appears.
- When there is more than one page, the following appear:
 - 2 Current page number
 - 3 Total number of pages
 - 4 Next page key
 Touch this key to display the next page. If the next page key is touched while the last page is displayed, the first page is displayed.
 - 5 Previous page key
 Touch this key to display the previous page. If the previous page key is touched while the first page is displayed, the last page is displayed.

- 3** Touch the desired pattern.

For this example, touch .

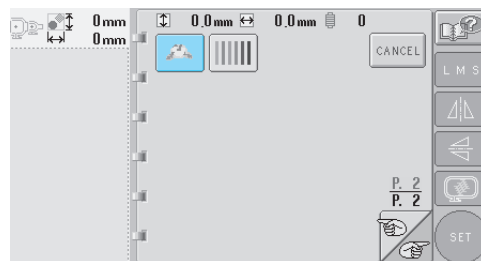

► The selected pattern appears in the pattern display area.

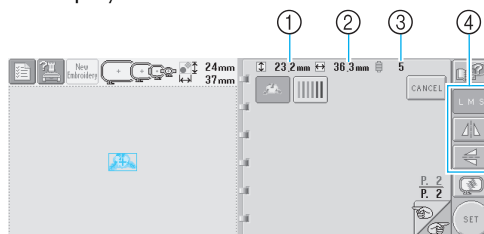

- After a pattern is selected, the following appear:
 - 1 Vertical length of the pattern
 - 2 Horizontal width of the pattern
 - 3 Number of thread color changes and the keys indicated by 4, which can be used to change the pattern size or mirror image the pattern. The functions that can be used differ depending on the type of pattern that is selected. (Refer to “Changing the size of the pattern” on page 103.)
- If the wrong pattern was selected or you wish to select a different pattern, touch the desired pattern.

- 4** Touch  to display the selected design in preview enlarged image.

- 5** Touch  to display the next screen.

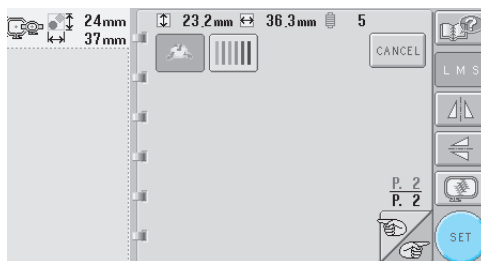

This confirms the pattern selection.

► The pattern editing screen appears.

4. Editing the Embroidery Pattern

When **SET** in the pattern list screen is touched, the pattern editing screen appears. From this screen, the pattern can be edited.

Pattern editing screen (For details on the keys and other information on the screen, refer to page 52.)

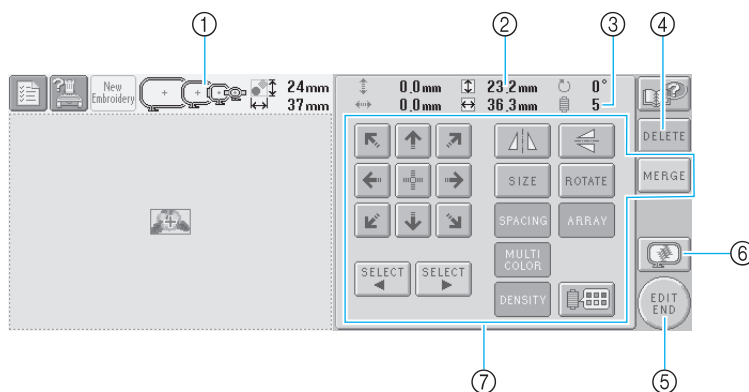

- ① Highlights the sizes of embroidery frames that can be used to sew the currently selected embroidery pattern
- ② Shows the size of the currently selected embroidery pattern
The top value shows the height and the bottom value shows the width.
- ③ Shows the number of thread color changes for the currently selected embroidery pattern

- ④ Touch this key to delete the pattern, for example, if the wrong pattern was selected. No pattern is selected and the pattern type selection screen appears.
- ⑤ Continues to the next screen
- ⑥ Displays a preview image
- ⑦ Touch to edit the pattern.

In this example, we will not edit the pattern. Without performing any editing operations, continue to the next screen.

Continuing to the embroidering settings screen

1 Press **EDIT END**.

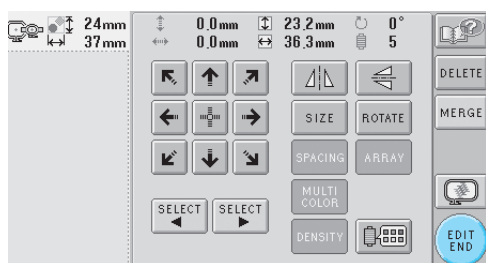

- ▶ The embroidering settings screen is displayed.

Memo

- If an operation in the pattern editing screen is interrupted and the machine is turned off, the operation can be continued after the machine is turned on again. When the machine is turned on again, you will be asked if you wish to continue the previous operation or begin a new one. (Refer to “Resume the Operation Being Performed Before the Machine Was Turned OFF” on page 62.)

5. Specifying Embroidering Setting

When  in the pattern editing screen is touched, the embroidering settings screen appears. From this screen, the entire pattern can be edited and embroidering settings can be specified. In addition, the embroidering position can be checked and a pattern can be saved for later use.

Embroidering settings screen (For details on the keys and other information on the screen, refer to page 54.)

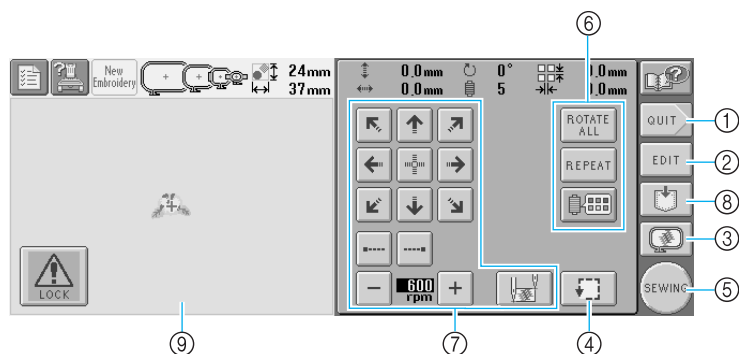

- ① Restarts from the beginning
- ② Returns to the pattern editing screen
- ③ Displays a preview image
- ④ Touch to check the embroidering area.
- ⑤ Continues to the next screen
- ⑥ Touch to edit the pattern.

- ⑦ Touch these keys to specify how the pattern will be embroidered.
- ⑧ Touch to store the pattern.
- ⑨ In the embroidering settings screen, the embroidery frame guide in the pattern display area indicates the size of the installed embroidery frame.

In this example, we will not specify any of the embroidering settings. Continue with the next operation.

Memo

- If the embroidery frame is not positioned correctly when continuing to the embroidering settings screen, the embroidery frame is moved to the correct position at the same time that the embroidering settings screen is displayed. (Refer to "Embroidery Frame Position and Movement" on page 70.)

Memo

- If an operation in the embroidering settings screen is interrupted and the machine is turned off, the operation can be continued after the machine is turned on again. When the machine is turned on again, you will be asked if you wish to continue the previous operation or begin a new one. (Refer to "Resume the Operation Being Performed Before the Machine Was Turned OFF" on page 62.)

6. Previewing the Image

You can view an image of the completed pattern within the embroidery frame.

Checking a preview image

Display the preview image to check that the embroidery will be sewn as desired.

1 Touch .

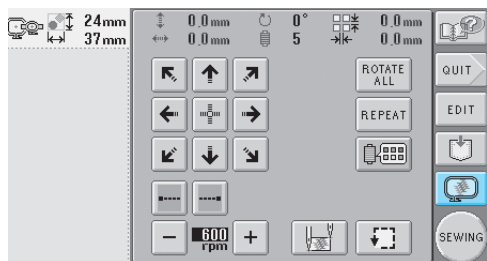

► The preview image is displayed.



- ① Touch these keys to display the pattern in the various sizes of embroidery frames. The embroidery frames that appear in white on gray keys can be selected.
- ② Touch this key to display an enlarged view of the pattern.

2 Touch  to return to the previous screen.

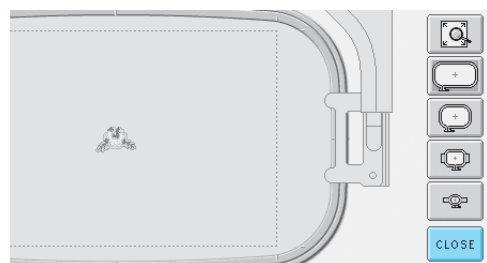

Memo

- The preview image can also be displayed from the pattern editing screen.

2

1

2

3

4

5

6

7

8

9

10

11

12

13

14

7. Hooping the Fabric in the Embroidery Frame

After selecting the pattern to be embroidered, check which embroidery frames can be used to sew the pattern. Select the appropriate frame, and hoop the fabric and stabilizer in the embroidery frame. (Refer to “Attaching Iron-On Stabilizer (Backing) to Fabric” on page 66.) For precautions concerning the fabric, refer to page 16.





Note

- If the fabric is not taut, the pattern may be misaligned or the fabric may pucker. Follow the procedure described below to firmly stretch the fabric in the embroidery frame so that the fabric is not loose. In addition, be sure to work on a level surface when putting the fabric in the embroidery frame.

Hooping the fabric in the embroidery frame

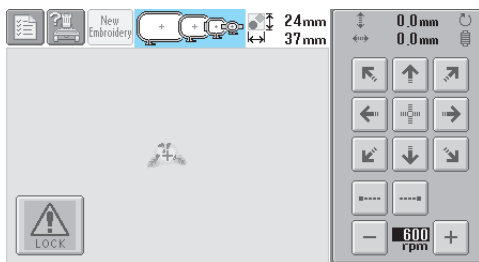



- 1 **Select an embroidery frame.**
From the sizes of embroidery frames indicated in the screen, select the embroidery frame that you wish to use.



Embroidery frames that can be used appear darker () embroidery frames that cannot be used appear lighter ()

Embroidery frame types

There are four sizes of embroidery frames. For details on the uses for each frame, refer to “Correctly Using the Embroidery Frames” on page 65.

Icon	Name	Embroidering area
	Extra-large embroidery frame	200 mm (H) × 300 mm (W) (7-7/8 inches (H) × 11-3/4 inches (W))
	Large embroidery frame	130 mm (H) × 180 mm (W) (5-1/8 inches (H) × 7-1/8 inches (W))
	Medium embroidery frame	100 mm (H) × 100 mm (W) (4 inches (H) × 4 inches (W))
	Small embroidery frame	40 mm (H) × 60 mm (W) (1-1/2 inches (H) × 2-3/8 inches (W))



CAUTION

- If embroidery frames other than the four included frames are used the embroidery frame may hit the presser foot and damage the machine, or cause injury to the user.



Note

- The embroidery frame indicators show all embroidery frame sizes in which the embroidery pattern can be sewn. Be sure to use an embroidery frame of the most suitable size. If the embroidery frame that is too large is used, the pattern may be misaligned or the fabric may pucker. (Refer to “Correctly Using the Embroidery Frames” on page 65.)

■ Hooping fabric in the small embroidery frame

The procedure for hooping fabric in the small embroidery frame is described below. The same procedure is used to hoop the fabric in the medium embroidery frame. For details on hooping fabric in the large embroidery frame and the extra-large embroidery frame, refer to “Hooping the Fabric” on page 67.

2 Loosen the screw on the outer frame.

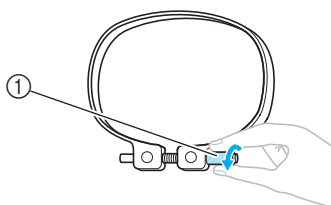

① Screw

3 Place the fabric with the right side up on top of the outer frame.

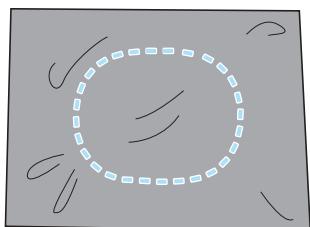

- The outer frame does not have a front or back side. Either side can be used as the front.

4 Press the inner frame into the outer frame.

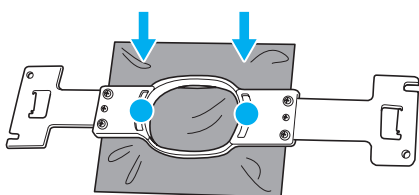

- Be sure that there are no wrinkles in the fabric after it is stretched in the embroidery frame.

5 Lightly tighten the screw, and then pull the edges of the fabric.

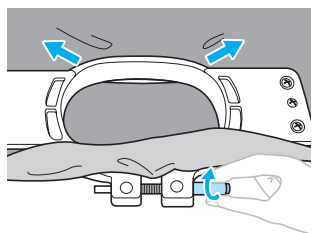

6 Securely tighten the screw, and then check that the fabric is taut.

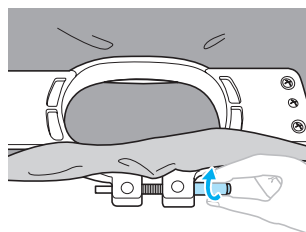

- After stretching the fabric, lightly tapping it should produce a drum-like sound.
- Firmly clamp together the inner and outer frames so that the bottom of the inner frame is lower than the bottom of the outer frame.

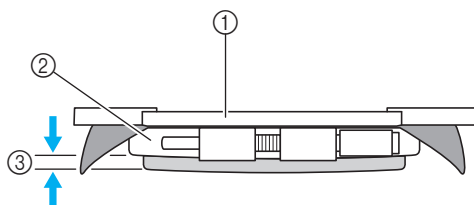

① Inner frame
② Outer frame
③ Bottom of inner frame

- Using the included disc-shaped screwdriver, firmly tighten the screw.

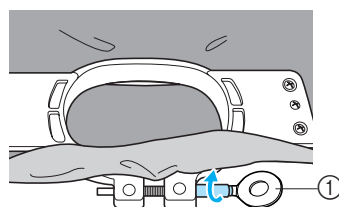

① Disc-shaped screwdriver

The amount that the fabric is stretched and the use of stabilizer material differ depending on the type of fabric being embroidered. Try various methods to achieve the best embroidering results. (Refer to “Hooping Techniques” on page 166.)

Memo

- This embroidery machine can also be used with the optional cap frames. (Refer to “Using the Optional Cap Frame” on page 169.)

8. Attaching the Embroidery Frame to the Machine

After hooping the fabric in the embroidery frame, attach the frame to the embroidery machine.

⚠ CAUTION

- If the embroidery frame is not correctly attached it may hit the presser foot and damage the machine, or cause injury to the user.
- When attaching the embroidery frame, make sure that the start/stop button is lit in red. If the start/stop button is flashing in green, the embroidery machine may start sewing. If the embroidery machine accidentally starts operating, injuries may result.
- When attaching the embroidery frame, make sure that the embroidery frame does not hit any other part of the embroidery machine.



Note

- Before attaching the embroidery frame, check that there is enough thread in the bobbin.

Attaching the embroidery frame

Adjust the width of the embroidery frame holder to the size of the embroidery frame, and then attach the embroidery frame to the machine. As an example, the procedure for attaching the small embroidery frame is described below.

Embroidery frame

Holes

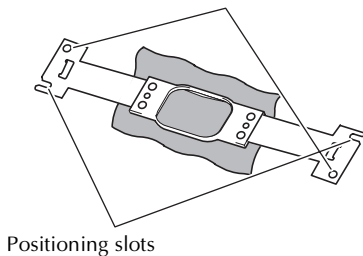

Positioning slots

Left arm of embroidery frame holder

Move the arm of the embroidery frame holder to the left or right to adjust it to the size of the embroidery frame.

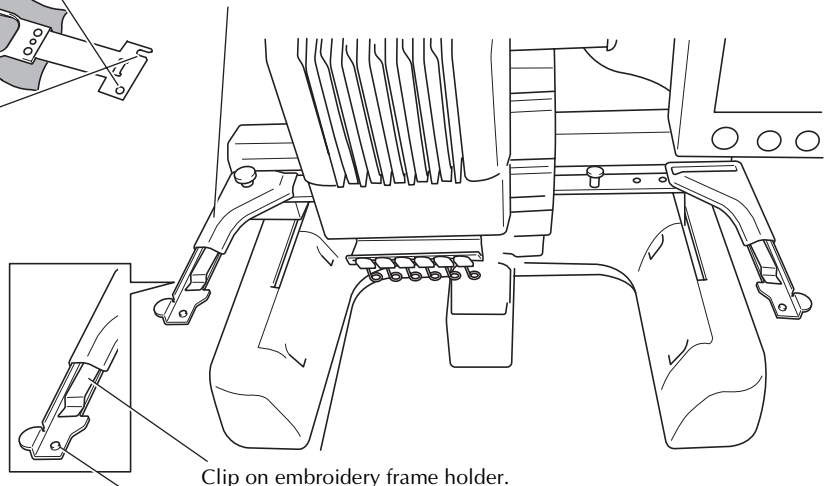

Positioning Pin

Clip on embroidery frame holder.

Insert the embroidery frame into the clips on the embroidery frame holder.

- 1 Loosen the two thumb screws on the embroidery frame holder.**
If the screw is too tight, please use the included disc-shaped screwdriver.

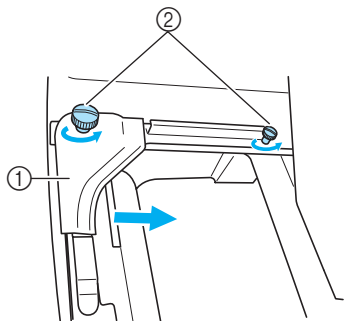

- ① Left arm
② Thumb screws

- ▶ The left arm of the embroidery frame holder can be moved.
- Only loosen the thumb screws a maximum of 2 turns counter clockwise. Do not remove the screw.

- 2 Move the left arm to align the screw on the right side with the mark for the embroidery frame to be installed, and then tighten the thumb screws.**

For this example, align with mark ⑤.

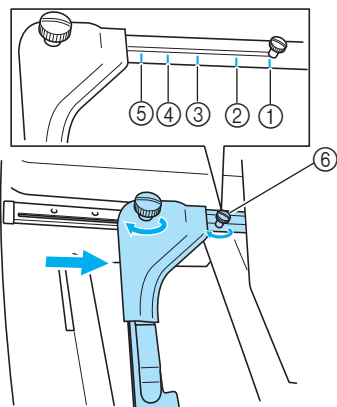

- ① Mark for extra-large embroidery frame
② Mark for large embroidery frame
③ Mark for medium embroidery frame
④ Mark for embroidery frame for industrial embroidery machines (When using embroidery frames for industrial embroidery machines, THE MACHINE DOES NOT RECOGNIZE THE SEWING AREA OF THE FRAME. Be sure to use the trial sewing function to check that the pattern fits within the sewing area. If an embroidery frame for an industrial embroidery machine is installed, the right arm of the embroidery frame holder must also move. For details, refer to page 168.)
⑤ Mark for small embroidery frame
⑥ Align the screw with the mark.



Note

- Please firmly tighten the two thumb screws with included disc-shaped screwdriver. The machine will recognize the wrong frame size, if the two screws are not tightened.

- ▶ The embroidery frame holder is ready for the embroidery frame to be attached.

- 3 Hold the embroidery frame level, and then simultaneously align both the left and right mounts with the embroidery frame holder clips.**

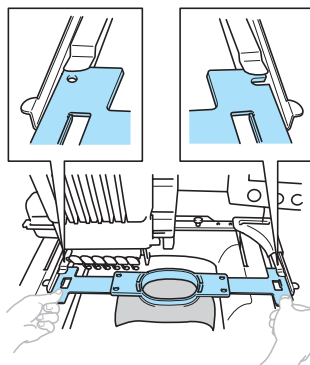

- The inner frame should be on top.



Note

- Incorrect frame positioning.

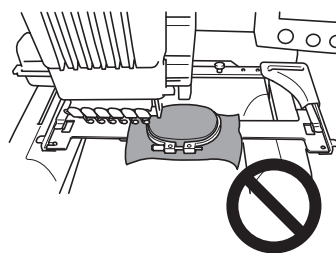

- 4 Insert the embroidery frame until it snaps into place.**

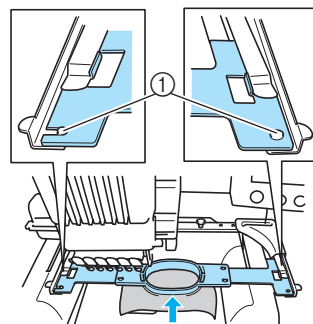

- ① Make sure that the pins on the left and right arms of the embroidery frame holder fit into the positioning slot and hole on the embroidery frame.

9. Checking the Embroidery Area

Check the embroidery area to make sure that the embroidery will be sewn in the desired location and will not be misaligned and that the embroidery frame will not hit the presser foot.

If the embroidery frame is not correctly positioned, it moves to the correct position, and then the embroidering position is indicated.

1 Touch .

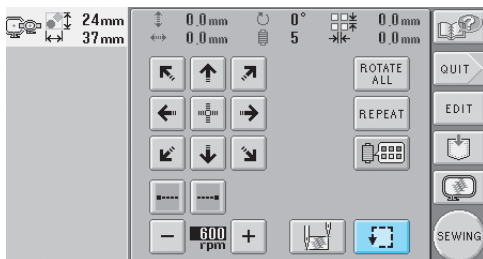

- ▶ The presser foot is lowered and the embroidery frame moves to show the embroidery area.

2 The corners of the octagon showing the embroidery area for the pattern are indicated by changing direction.

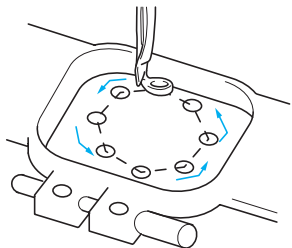

Carefully watch the movement of the embroidery frame and check that the embroidery is sewn in the desired location and that the embroidery frame does not hit the presser foot.

■ Stop checking the embroidery frame area.

The embroidery frame can be temporarily stopped at a desired position or the checking of the embroidering area can be stopped.

3 When the embroidery frame moves to the desired position, touch again.

- ▶ The embroidery frame stops moving, and the next screen appears.

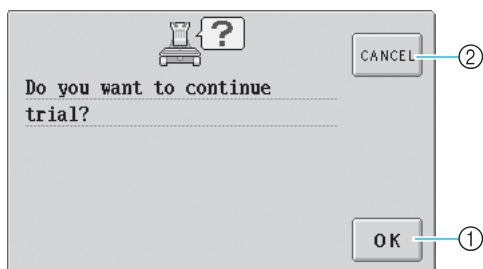

- ① Touch to continue moving the frame.
- ② Touch to stop checking the embroidering area.

4 To continue moving the embroidery frame, touch . To stop checking the embroidering area, touch .

Continuing to the embroidering screen

After finishing the necessary operations in the embroidering settings screen, continue to the embroidering screen.

1 Touch .

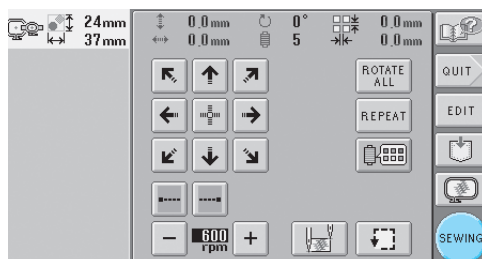

- ▶ The embroidering screen appears.

10. Upper Threading

Check the embroidering screen for information on which needle bars should be threaded with which thread colors, and then thread the upper threads.

Checking the needle bars and thread colors

In the embroidering settings screen, touch **SEWING** to display the embroidering screen and the message instructing that the needle bars be threaded (that the thread spools from the previous time be changed). Check the thread colors in this screen.

Embroidering screen (For details on the keys and other information on the screen, refer to page 56.)

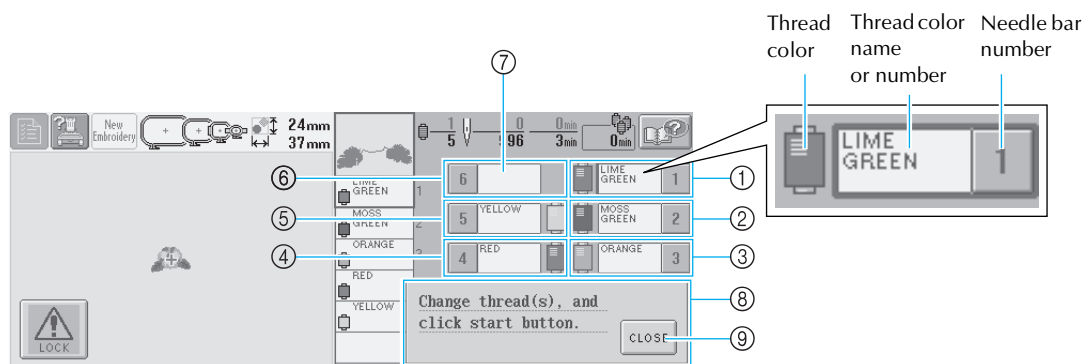

- ① Thread information for the first needle bar
- ② Thread information for the second needle bar
- ③ Thread information for the third needle bar
- ④ Thread information for the fourth needle bar
- ⑤ Thread information for the fifth needle bar
- ⑥ Thread information for the sixth needle bar
- ⑦ If no thread color name is displayed, that needle bar has not been used.
If a thread color had been assigned to the needle bar on a previously sewn design, the needle bar will show the previously assigned color.
- ⑧ Change thread spools message (Refer to page 77.)
This message appears when it is necessary for the

thread spools to be changed. If **CLOSE** ⑨ is not touched to close the message, embroidering cannot continue.

Thread with the color name that appears beside each needle bar number is threaded on that needle bar.

For the screen shown

- 1: Lime green
- 2: Moss green
- 3: Orange
- 4: Red
- 5: Yellow

If there is no name beside the needle bar number, that needle bar is not used. For this example, needle bar 6 is not used.

1 Touch

- ▶ The screen indicating that the spools be changed is closed.
- In addition to checking the thread colors, information such as the number of stitches and the sewing time can be checked and various embroidering settings can be specified in the embroidering screen.

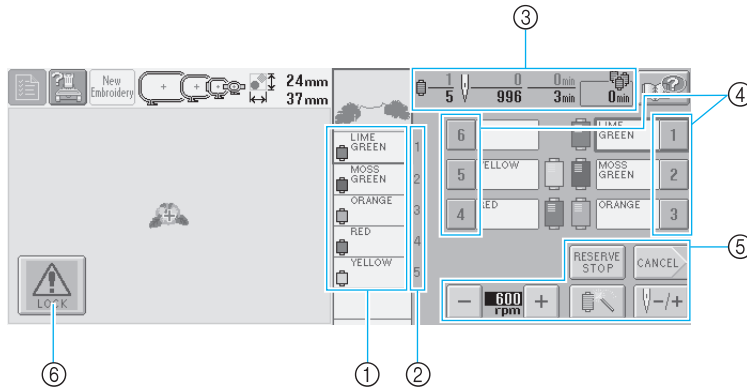





- ① Shows the embroidering order for the thread colors.
- ② Indicates the needle bar number where the thread color at the left is assigned.
- ③ Shows the number of thread color changes, the number of stitches, the embroidering time and the length of time until the spools will need to be changed.
- ④ Touch a key to move the selected needle bar to the sewing position. Use when threading the needle with the automatic needle-threading mechanism.
- ⑤ Use these keys to specify various embroidering settings or to return to the embroidering settings screen.
- ⑥ To start the machine, touch this key to unlock the machine, and then press the start/stop button.

CAUTION

- When  (unlock key) in the embroidering screen is touched, the start/stop button begins flashing in green and the embroidery machine can start sewing. If the upper threading is being performed or the needle is being threaded, be careful that the embroidery machine is not accidentally started, otherwise injuries may result.

Upper threading

Use embroidery thread to thread the needle bars in order, starting with needle bar 1.

Press  → OPERATIONS →  →  (To page 3) →  in order to view a video of the operation on the LCD (see page 151).

CAUTION

- When threading the upper thread, carefully follow the instructions. If the upper threading is not performing correctly, the thread may break or become tangled, causing the needle to bend or break.



Note

- It is recommended that rayon or polyester embroidery thread be used (120 den/2, 135 dtex/2, 40 weight (in Americas and Europe), #50 (in Japan)).



Memo

- The path that the embroidery machine should be threaded is indicated by a line on the machine. Be sure to thread the machine as indicated.

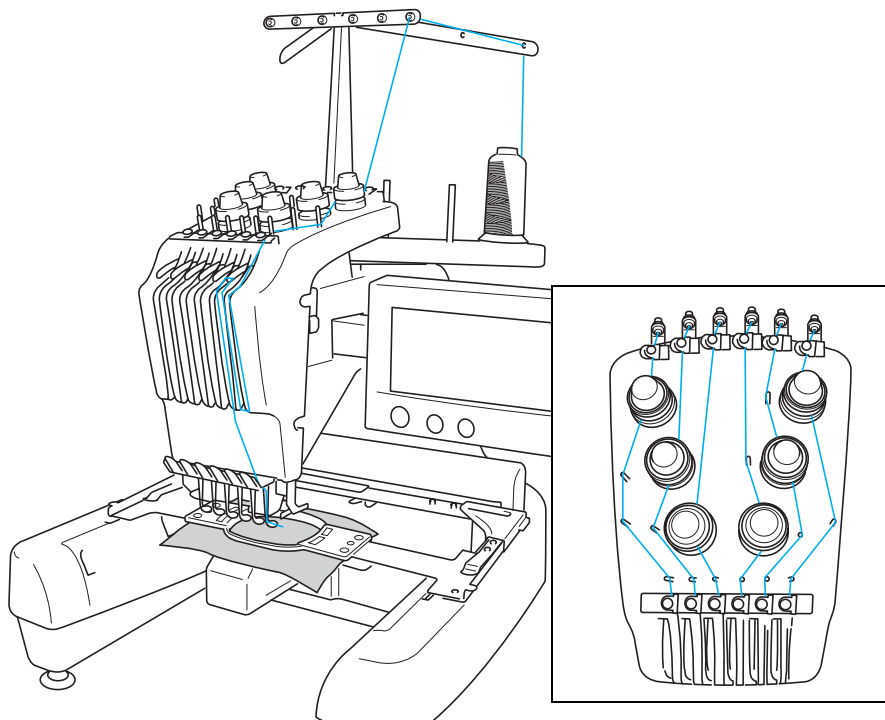

The numbers indicate the thread path for each of the numbered needle bars. Be very careful to correctly thread the needle bars.

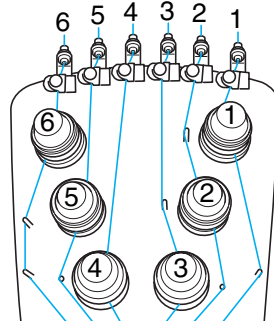
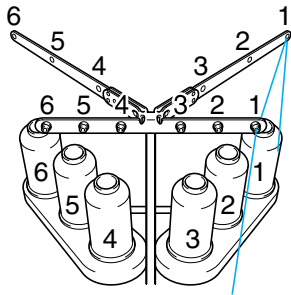

- 1** Place on spool pin 1 the spool of thread with the color (lime green) specified for needle bar 1.

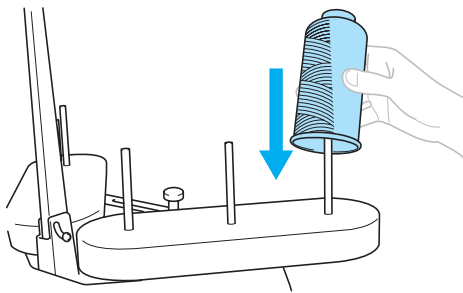

- Make sure that the spool stand is opened in the shape of a V.
- When using small spools of thread, be sure to place the enclosed spool mat on the spool pin before placing the spool on the pin.
- Use spool cap on all spools of thread shorter than the height of the spool pin.

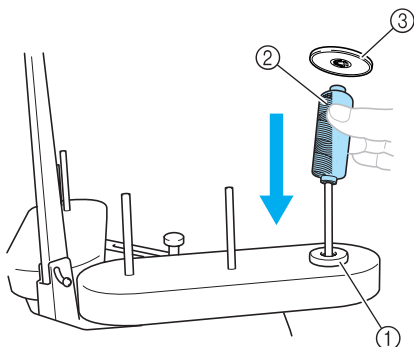

- ① Spool mat
- ② Small spool
- ③ Spool cap

- 2** Pass the thread through the number 1 hole in the thread guide just above the spool, and then pass the thread through the number 1 hole in the thread guide toward the front of the machine.

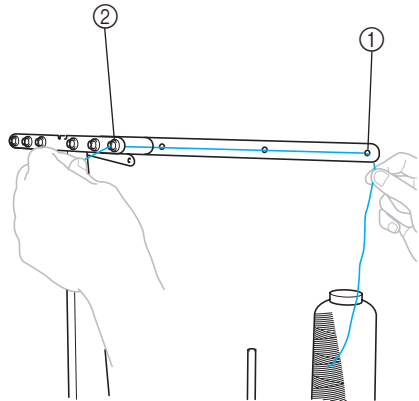

- ① Number 1 hole in the thread guide above the spool
- ② Number 1 hole in the thread guide toward the front of the machine

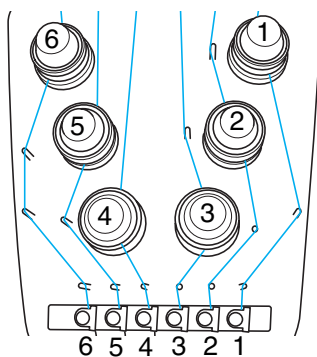

- 3** Pass the thread through the hole in the number 1 upper thread guide. Pass the thread toward you from the inside of the thread guide.

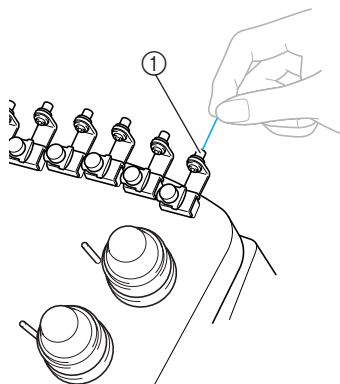

① Hole in upper thread guide

- 4** Pass the thread through the number 1 upper thread guide. Hold the thread with both hands, and then pass it under the guide from the right.

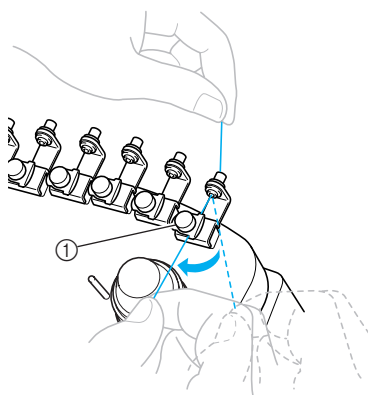

① Upper thread guide

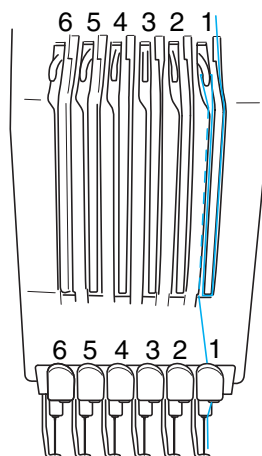

- 5** Wind the thread clockwise once around the number 1 thread tension disc.

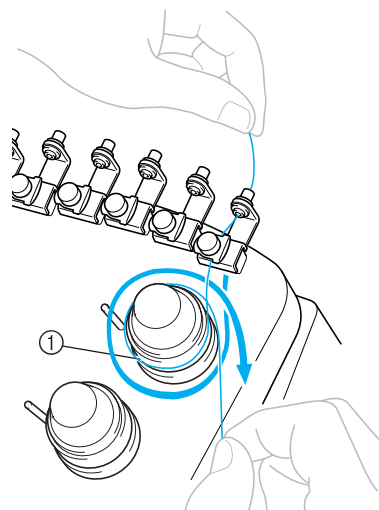

- ① Thread tension disc
- Make sure that the thread is securely caught in the thread tension disc and passed correct thread guide pins. (See left illustration at top of page.)

Note

- All thread tension disks are threaded in clockwise direction.

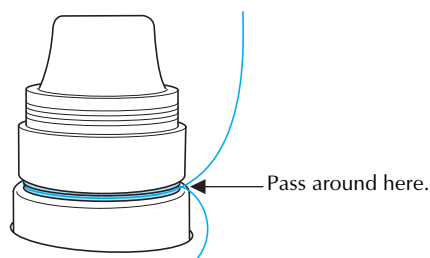

- 6** Pass the thread along the thread path indicated on the machine, and then pass it under the number 1 middle thread guide plate.

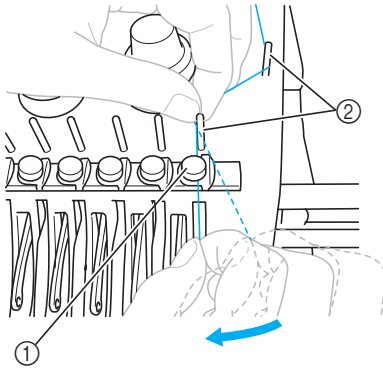

- ① Middle thread guide
- ② Thread guide pin
- The path from the upper thread guide around the thread tension disc and to the middle thread guide (steps 5 through 6) differ depending on the spool number. Passing the thread from the left to the right through the thread guide pins is designed to prevent the thread from becoming tangled. Thread each needle bar as shown in the illustration.

- 7** Pass the thread along the number 1 slot to pass it through the number 1 take-up lever hole from right to left.

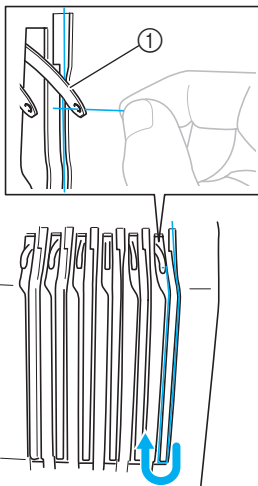

- ① Thread take-up lever

- 8** Pass the thread down through the slot to the lower thread guide, and then through the hole in the number 1 lower thread guide.

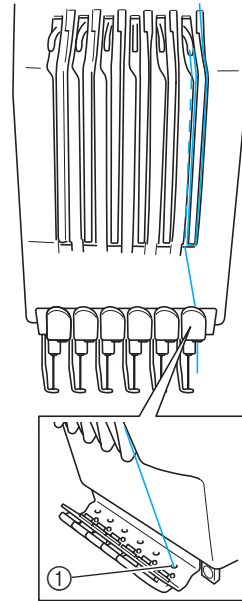

- ① Hole in lower thread guide



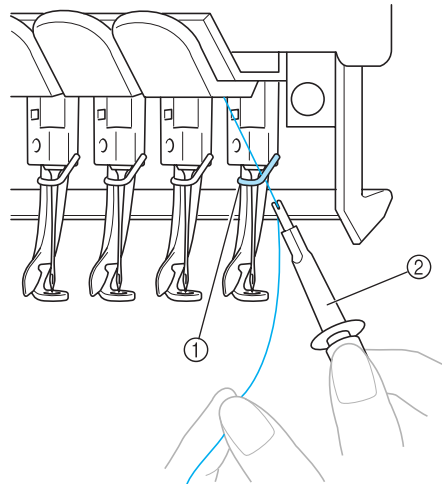

- 9** Use the included threader to pass the thread into the number 1 needle bar thread guide.



- ① Needle bar thread guide
- ② Needle changing tool (Threader)

Threading the needle

Use the automatic needle-threading mechanism to thread the needle.

Press  → OPERATIONS →  →  (to page 2) →  in order to view a video of the operation on the LCD (see page 151).

1 Press the automatic needle-threading button.

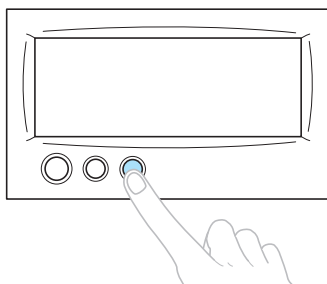

- ▶ The hook on the automatic needle-threading mechanism passes through the eye of the needle.

CAUTION

- If the needle is not fully inserted, the hook of the automatic needle-threading mechanism will not pass through the eye of the needle during automatic needle threading, and the hook may bend or the needle cannot be threaded.
- If the hook of the automatic needle-threading mechanism is bent or damaged, contact your authorized retailer.
- While the hook of the automatic needle-threading mechanism is passed through the eye of the needle, do not rotate the handwheel, otherwise the automatic needle-threading mechanism may be damaged.

Note

- To avoid damage, the automatic needle-threading mechanism may return to the back position when you turn the handwheel.
- The automatic needle-threading mechanism can thread one needle at the sewing position. When this mechanism is used, be sure that the needle bar that you want to thread is positioned as the sewing position, otherwise the automatic needle-threading mechanism cannot be used at the particular needle. If the needle bar is not at the sewing position, move it there. (Refer to page 40.)

- ### 2 Pull out about 15 cm (6 inches) of thread. Allow thread to relax and eliminate any stress on the thread. Then, as shown in the illustration, pass the thread under the fork of the automatic needle-threading mechanism from the right, and then catch the thread with the hook that passes through the eye of the needle.

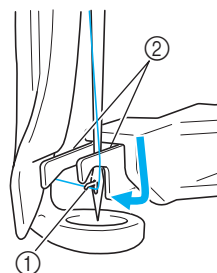

- ① Hook
- ② Fork

Note

- When catching the thread with the hook, be careful that the thread does not become loose.

- 3** Pass the thread under the guide on the presser foot.

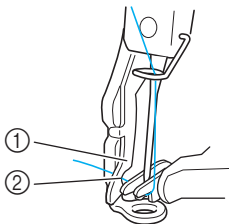

- ① Guide on presser foot
 ② Notch in guide on presser foot
- Make sure that the thread securely passes through the notch in the guide on the presser foot.

- 4** Securely pass the thread through the groove in the thread cutter, and then lightly pull the thread to cut it.

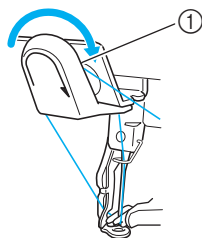

- ① Groove in thread cutter



Note

- If the thread is not correctly passed through the groove in the thread cutter, the message "Wiper error." appears and the needle cannot be threaded. Be sure to securely pass the thread through the groove.
- If enough thread is not pulled out, the thread cannot be pulled through the thread cutter.

- 5** Press the automatic needle-threading button.

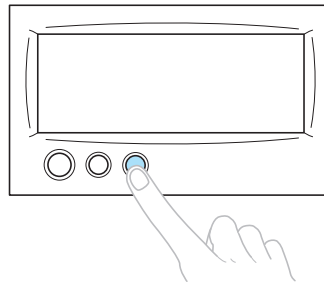

- The threader moves back away from the needle. The thread is pulled through the needle eye.
- The wiper comes out and catches the thread between the needle and the threader.
- The threader goes back to the original home position.

This completes the upper threading for needle bar 1.

Thread the remaining needle bars in the same way. However, if the needle bar to be threaded is not moved to the embroidery position, the needle cannot be threaded with the automatic needle-threading mechanism. For the remaining needle bars, perform the following operation to move the needle bar to the embroidery position before trying to thread the needle.

■ Moving the needle bar to be threaded to the sewing position

- 1** Touch the key for the needle bar that you wish to thread.

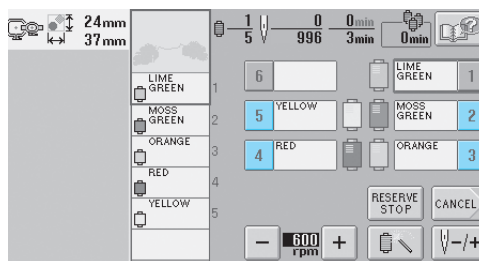

- ▶ The selected needle bar moves to the embroidery position.



Note

- If the thread is not taut, it may come out of the thread tension disc. After upper threading is finished, check again to make sure that the thread is correctly passed into the thread tension disc. (Refer to step 5 on page 37.)



Memo

- When changing one of the upper thread colors, it is easy to re-thread by cutting the thread currently being used between the spool and the thread guide above the spool. Place the new spool on the spool pin and tie the end of the new thread to the end of the previous thread. Then pull the thread through to the needle. (Refer to page 78.)

■ Using the spool net

When using metallic thread or any other strong thread, place the included spool net over the spool before sewing.

If the spool net is too long, fold it once to match the size of the spool before placing it over the spool.

It may be necessary to adjust thread tension when using the spool net.

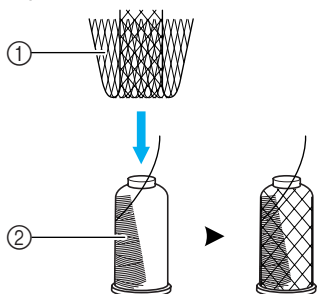

- ① Spool net
- ② Thread

11. Sewing the Embroidery

Now, the embroidery machine is ready to begin sewing.

When the machine starts sewing, the presser foot is automatically lowered, the necessary thread trimming operations at the end of stitching are performed, the threads are changed as necessary while the embroidery is sewn, and the machine stops when the end of the stitching is reached.

CAUTION

- For safety reasons, the embroidery machine must not be left unattended while it is sewing.
- While the machine is in operation, pay special attention to the needle location. In addition, keep your hands away from all moving parts such as the needle, needle bar case, thread take-up lever and carriage, otherwise injuries may result.

Locking mechanism

For safety reasons, this embroidery machine is equipped with a locking function.

Normally, the embroidery machine is locked (it cannot start sewing). Unless the machine is unlocked, it cannot start sewing. If the embroidery machine is not started within 10 seconds after unlocking it, it automatically returns to being locked.

The start/stop button shows whether or not the embroidery machine is locked. If the start/stop button lights up in red, the machine is locked. If the start/stop button flashes in green, the machine is unlocked.

Starting embroidering



Note

- Make sure that there are no objects within the moving area of the embroidery frame. If the embroidery frame hits another object, the pattern may become misaligned.

- 1 Touch  to unlock the embroidery machine.

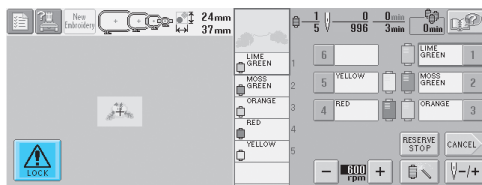

- ▶ The start/stop button begins flashing in green and the embroidery machine can be started.
- If the start/stop button is not pressed within 10 seconds after unlocking the embroidery machine, the machine becomes locked again.

2

Press the start/stop button.

Press the start/stop button while it is flashing in green. If the start/stop button returns to being lit in red, perform this procedure again from step 1.

1

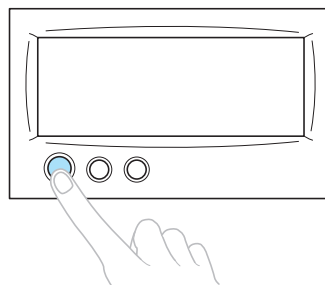

- ▶ The start/stop button lights up in green and begins sewing the first color.



Note

- The light goes off when sewing starts.

▶ The following screen appears.

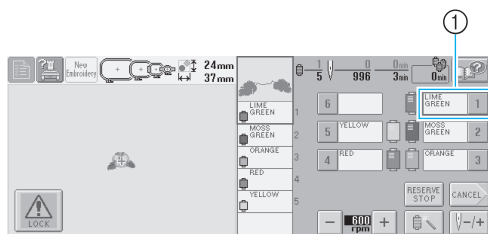

① A red frame around the thread information box indicates which needle bar is currently being used for sewing.

- While the embroidery machine is sewing, the point being sewn is indicated by the green crosshairs in the pattern display area. In addition, the number of stitches and the time count up.

3 After sewing of the first color is finished, the machine automatically stops and trims the thread. The needle bar case moves to the 2nd color position and sewing of the second color begins.

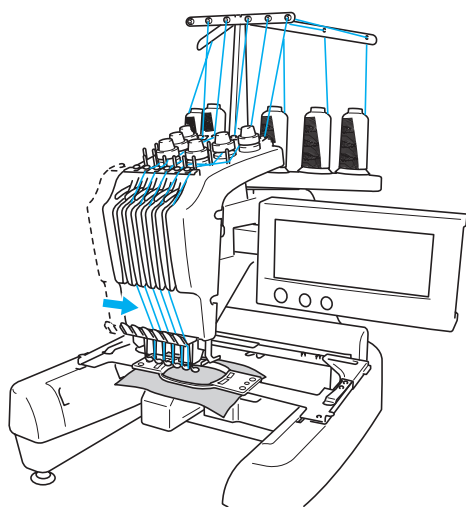

▶ The thread color display in the screen continues to the second color, and the thread information for the second needle bar is surrounded by the red frame.

4 This continues until the last color is sewn, and the embroidery machine automatically stops.

▶ The embroidering settings screen reappears.
 ▶ The start/stop button lights up in red.
 • No thread trimming operations at the beginning of stitching and at the end of stitching are necessary.

■ Continuing embroidering

To sew the same pattern again, touch **SEWING**.

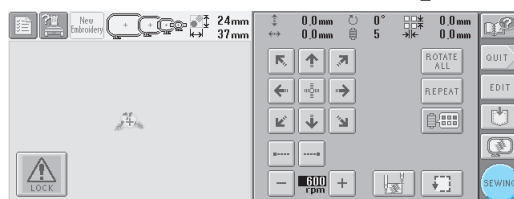

▶ The embroidering screen appears so the same pattern can be sewn again.

To select a new pattern, touch **QUIT** or **New Embroidery**.

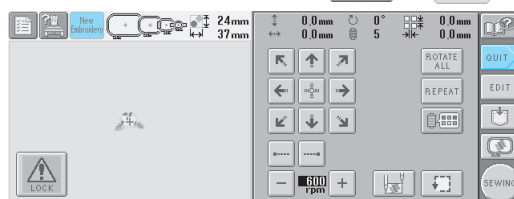

▶ The pattern type selection screen appears.

Note

- Automatic Lock stitching can be set so that it is sewn at the beginning of the embroidery, when starting to sew after change thread colors, and when trimming the thread. (Refer to "Automatic Lock Stitch Setting" on page 88.)
- The sewing speed can be changed, even while the pattern is being sewn. (Refer to "Maximum Sewing Speed Setting" on page 91.)

Stopping embroidering

The machine can be stopped during sewing.

■ Temporarily pausing

1 Press the start/stop button.

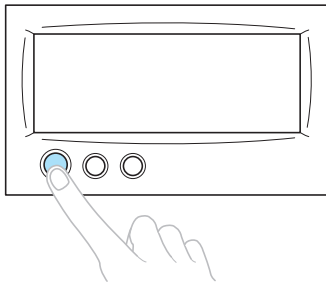

- ▶ The machine stops and the start/stop button lights up in red.
- The thread is not trimmed.
- To continue sewing, after checking that the upper thread is taut, touch the unlock key, and then press the start/stop button.



Memo

- If the Reserve Stop key is touched while embroidery is being sewn, the machine stops before sewing for the next color begins. (Refer to “Stopping the machine at the next color change” on page 92.)
- Before starting to sew, the machine can be set to stop at any thread color change. (Refer to “Specifying pause locations before embroidering” on page 92.)

■ Resume sewing after the machine was turned off

1 Press the start/stop button.

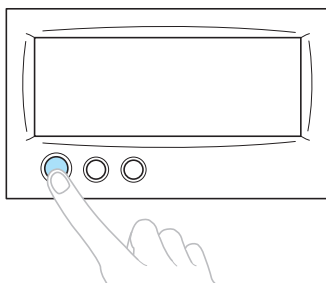

- ▶ The embroidery machine stops and the start/stop button lights up in red.
- The thread is not trimmed.

2 Press the thread trimming button.

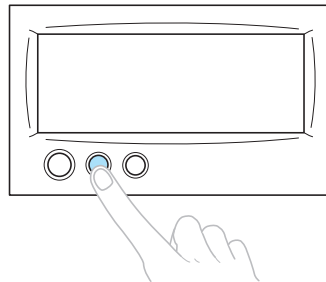

- ▶ The bobbin and upper threads are trimmed.
- Before turning off the embroidery machine, be sure to trim the threads.

3 Set the main power switch to “O”.

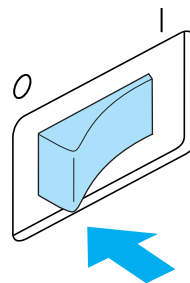

- ▶ The embroidery machine is turned off and the display and the start/stop button indicator go off.
- Sewing can resume after the embroidery machine is turned on again. Back up several stitches to overlap the stitching. For details, refer to “Resume Embroidering After Turning OFF the Machine” on page 83.



Memo

- The machine can be stopped at any time, even while it is embroidering; however, if the machine is stopped when the thread color is changed, it is not necessary to go back through the stitching when embroidering is continued. The machine can be set to stop when the thread color is changed. (For details, refer to “Specifying pause locations before embroidering” on page 92.)

■ If the thread breaks while sewing

If a problem occurs while sewing, such as if the thread breaks, the machine stops automatically. Re-thread the broken thread, back up several stitches, and then continue sewing. For details, refer to “If the Thread Breaks or the Bobbin Thread Runs Out While Embroidering” on page 79.

12. Checking the Thread Tension

Check the embroidery to see if it was sewn with the correct thread tension. If the thread tension is not adjusted correctly, the stitching may be uneven or there may be puckering in the fabric.

■ Correct thread tension

From the wrong side of the fabric, the bobbin thread should be about one third of the stitch width.

(Right side)



(Wrong side)



If the embroidery appears as shown below, the thread tension is incorrect. Correct the thread tension.

(Right side)



(Wrong side)



The tension of the upper thread is too tight, resulting in the lower thread being visible from the right side of the fabric.

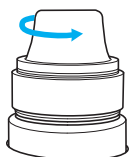

Loosen the tension dial by turning the dial counterclockwise.

(Right side)



(Wrong side)



The tension of the upper thread is too loose, resulting in a loose upper thread, loose thread locks or loops appearing on the right side of the fabric.



Tighten the tension dial by turning the dial clockwise.

For details on adjusting the thread tension, refer to “Adjusting the Thread Tension” on page 85.

Note

- In this tutorial, the thread tension was checked after embroidering was finished. However, normally, embroidering should be temporarily paused and the thread tension should be checked after the first 100 stitches of each color sewn with each needle bar.
- The resulting embroidery may not appear as expected, due to the type or thickness of the fabric being sewn or to the type of stabilizer material used. Be sure to sew a trial embroidery before sewing on your project.

Memo

- In the built-in embroidery patterns, one pattern is used for checking the thread tension. For details, refer to “Checking the thread tension of built-in patterns” on page 160.

2

1

2

3

4

5

6

7

8

9

10

11

12

13

14

13. Removing the Embroidery Frame and Fabric

After sewing is finished, remove the embroidery frame, and then remove the fabric from the frame.

Removing the embroidery frame

! CAUTION

- When removing the embroidery frame, make sure that the start/stop button is lit in red. If the start/stop button is flashing in green, the machine may start sewing. If the machine accidentally starts operating, injuries may result.
- When removing the embroidery frame, be careful that the embroidery frame does not hit any other part of the machine.
- Do not lift up the embroidery frame holder with extreme force, otherwise it may be damaged.

- 1 With both hands, grab the left and right sides of the arms of the embroidery frame holder, and then slightly lift up the frame. The pins on the arms of the embroidery frame holder should come out of the holes in the sides of embroidery frame.

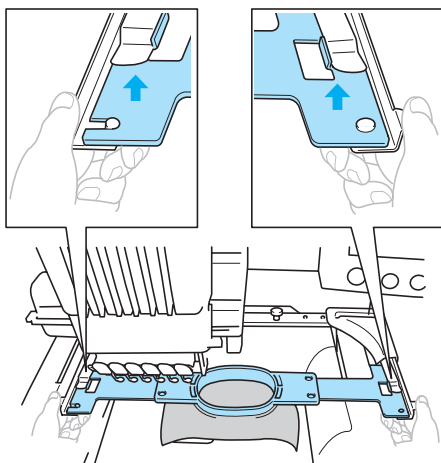

- 2 Pull off the embroidery frame toward you.

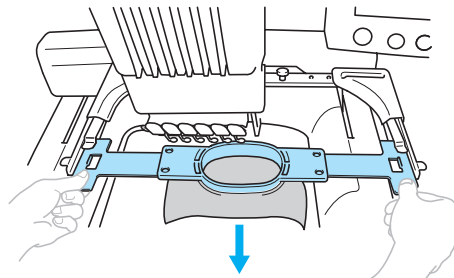

Removing the fabric

- 1 Loosen the outer frame screw.

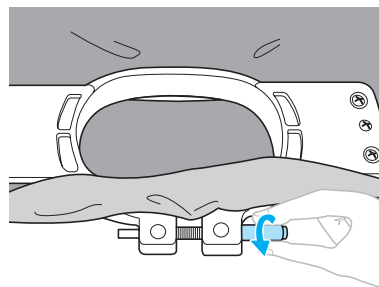

- ▶ If the screw was tightened using a disc-shaped screwdriver, use the included disc-shaped screwdriver to loosen it.

- 2 Remove the outer frame, and then remove the fabric.

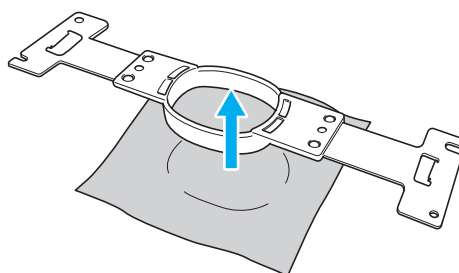

14. Turning OFF the Machine

After all embroidery is finished, turn off the machine.

- 1 Set the main power switch to “O”.

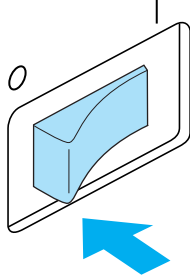

- ▶ The embroidery machine is turned off and the display and the start/stop button indicator goes off.

- 2 Unplug the power supply cord from the electrical outlet.

Grasp the plug when unplugging the power supply cord.

- 3 If necessary, unplug the power supply cord from the machine.

Store the power supply cord in a safe place.

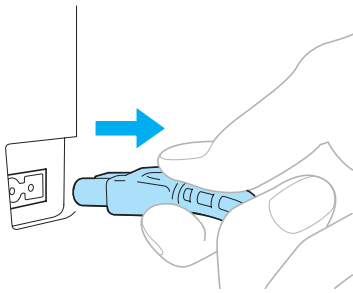

Note

- If a power outage occurs while the embroidery machine is being operated, turn off the embroidery machine and unplug the power supply cord. When restarting the embroidery machine, follow the necessary procedure to correctly operate the machine. (Refer to “Turning ON the Machine” on page 20)



Memo

- If the embroidery machine is turned off while the pattern type selection screen or the pattern list screen is displayed with no pattern selected, the pattern type selection screen appears when the machine is turned on again.

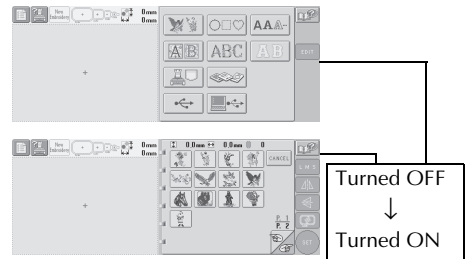

If **SET** is not touched to confirm the selection of the pattern in the pattern list screen, the selection will be erased if the machine is turned off.

After the opening screen



2

1

2

3

4

5

6

7

8

9

10

11

12

13

14

- If the embroidery machine is turned off while the pattern editing screen is displayed, the way that the pattern appears before the machine was turned off is stored in the machine's memory. When the embroidery machine is turned on again, the pattern editing screen as it appeared before the machine was turned off can be displayed again. (Refer to page 62.)

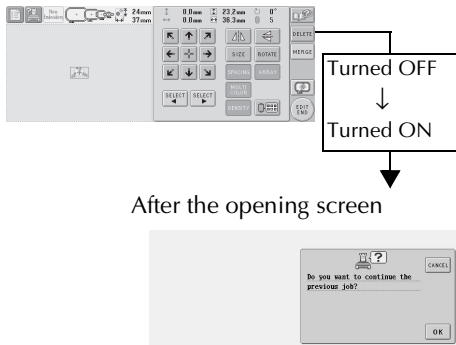

- If the embroidery machine is turned off while the embroidery settings screen is displayed, the embroidery settings screen for the pattern before the machine was turned off is stored in the machine's memory. When the embroidery machine is turned on again, the embroidery settings screen as it appeared before the machine was turned off can be displayed again. (Refer to page 62.)

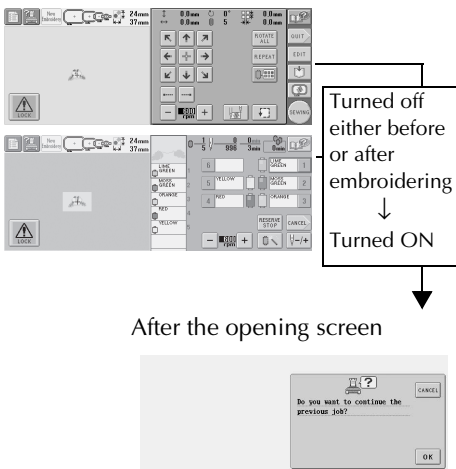

- If the machine is turned off while it is sewing, embroidering can continue when the machine is turned on again. (Refer to “Resume Embroidering After Turning OFF the Machine” on page 83.)

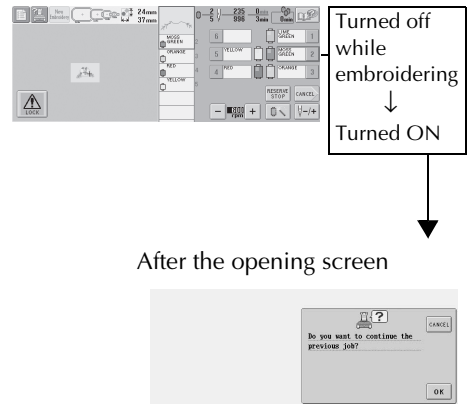

Screen Quick Reference Guide

Descriptions of the keys and other information that appear in the screens are provided in the tables below.

Key displays

The appearances of the keys have the following meanings.



(Normal color display) : This key is not selected, but can be selected.



(Dark-colored display) : This key is selected.



(Gray display) : This key cannot be selected.

Common screen controls

The keys described below, except for the settings key, appear in all screens and can always be used. However, the settings key cannot be used in the embroidering screen.

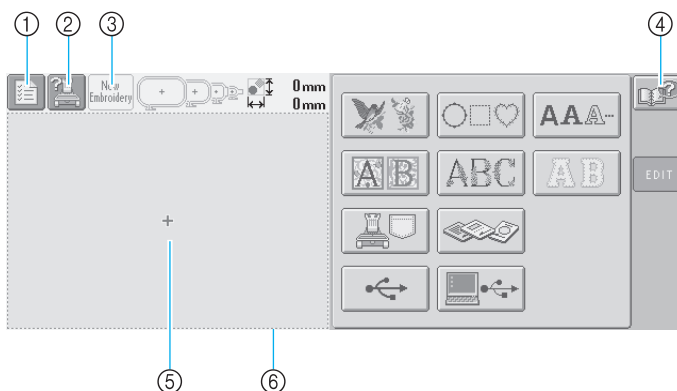

No.	Display	Key Name	Function	Reference Page
①		Settings key	Touch this key to change the embroidery machine settings.	p. 140
②		Machine operations guide key	Touch this key to check a machine operation.	p.151
③		New embroidery key	Cancels all operations previously performed and returns to the initial pattern group selection screen.	
④		Help key	When a problem occurs, for example, there is an operating procedure that you do not know, touch this key to view solutions.	p. 153
⑤		Pattern display area	This area displays the selected pattern. The line ⑥ shows the embroidering area for the extra-large embroidery frame. The embroidery frame indications, the grid lines and other display settings can be specified from the machine settings screen.	p. 143

Understanding the pattern type selection screen

In this screen, select a pattern category (type).

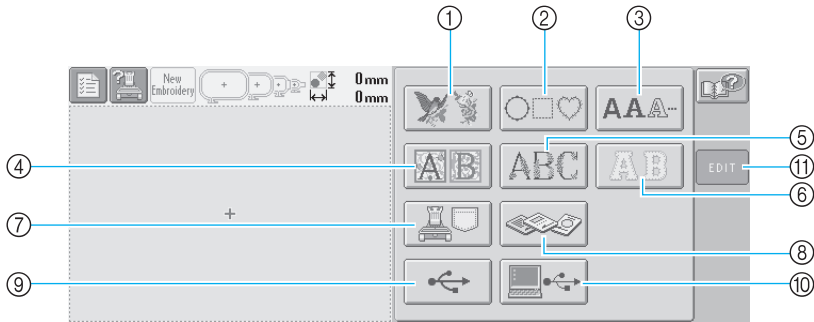

No.	Display	Key Name	Description	Reference Page
①		Embroidery pattern key	The embroidery pattern for a design can be selected.	p. 104
②		Frame patterns key	12 stitch types can be combined with 10 frame shapes, such as a circle and a square.	p. 108
③		Alphabet key	Uppercase letters, lowercase letters, numbers, symbols and accented characters from 13 fonts can be selected in small, medium and large sizes.	p. 109
④		Renaissance alphabet key	Renaissance-style characters designed in a 50 mm x 50 mm square.	p. 105
⑤		Floral alphabet key	Our original alphabet patterns designed with flowers decorating large uppercase letters (130 mm (H) x 80 mm (W)).	p. 106
⑥		Appliqué alphabet key	Alphabet appliqué patterns, which are available in small, medium and large sizes.	p. 107
⑦		Embroidery patterns stored in the machine key	Recalls patterns stored in the machine's memory.	p. 111
⑧		Embroidery cards key	Recalls patterns from embroidery cards.	p. 112
⑨		USB media key	Recalls patterns from USB media.	p. 117
⑩		Computer (USB) key	By using the included USB cable to connect a computer to the embroidery machine, patterns can be recalled from the computer.	p. 114
⑪		Edit key	This key is not available unless a pattern is selected. Touch this key to quit trying to add another pattern from the pattern type selection screen. Return to the pattern editing screen.	p. 119

Understanding the pattern list screen

In this screen, select the pattern.

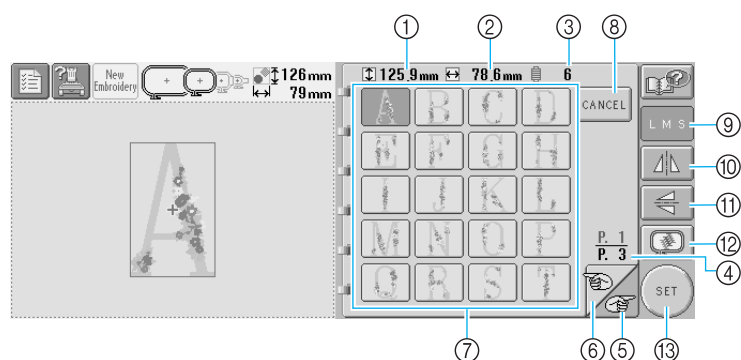

No.	Display	Key Name	Description	Reference Page
①		Size (vertical)	Shows the vertical length of the currently selected embroidery pattern.	
②		Size (horizontal)	Shows the horizontal width of the currently selected embroidery pattern.	
③		Number of thread color changes	Shows the number of thread color changes for the currently selected embroidery pattern.	
④		Page	Shows the number of the currently displayed page and the total number of pages.	
⑤		Next page key	Touch this key to display the next page. If the next page key is touched while the last page is displayed, the first page will be displayed.	p. 102
⑥		Previous page key	Touch this key to display the previous page. If the previous page key is touched while the first page is displayed, the last page will be displayed.	p. 102
⑦		Pattern keys	An image of the pattern appears on the key. Touch the image to select the pattern.	p. 102
⑧		Cancel key	Touch to leave the currently selected pattern category and choose a different category. Returns to the pattern type selection screen.	p. 102
⑨		Size key	Allows the size of the currently selected embroidery pattern to be changed.	p. 103
⑩		Horizontal mirror image key	Allows the currently selected embroidery pattern to be flipped horizontally.	p. 103
⑪		Vertical mirror image key	Allows the currently selected embroidery pattern to be flipped vertically.	p. 103
⑫		Preview key	Displays an image of the pattern that is to be embroidered so it can be previewed.	p.27
⑬		Set key	Touch after selecting the pattern. The selection of the pattern is confirmed and the pattern editing screen appears.	p. 102

*Some patterns cannot be edited with ⑨, ⑩ or ⑪.

Understanding the pattern editing screen

In this screen, the pattern can be edited.

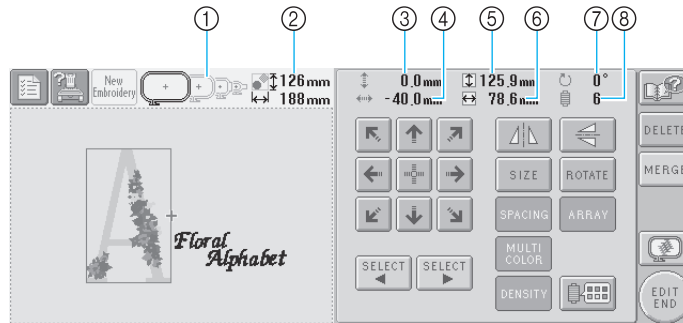

No.	Display	Key Name	Description	Reference Page
①		Embroidery frame indicators	Shows the sizes of embroidery frames that can be used to sew the embroidery pattern currently displayed in the pattern display area.	p. 28
②		Pattern size	Shows the size of the embroidery pattern currently displayed in the pattern display area. The top value shows the height and the bottom value shows the width. If the embroidery pattern consists of multiple patterns that have been combined, the size of the entire pattern, including all patterns, is shown.	
③		Distance from center (vertical)	Shows the vertical distance that the pattern being edited is moved.	p.120
④		Distance from center (horizontal)	Shows the horizontal distance that the pattern being edited is moved.	p.120
⑤		Size (vertical)	Shows the vertical length of the pattern that is being edited.	
⑥		Size (horizontal)	Shows the horizontal width of the pattern that is being edited.	
⑦		Rotation angle	Shows the rotation angle that the pattern being edited is rotated.	p.122
⑧		Number of thread color changes	Shows the total number of thread color changes for the pattern that is being edited.	

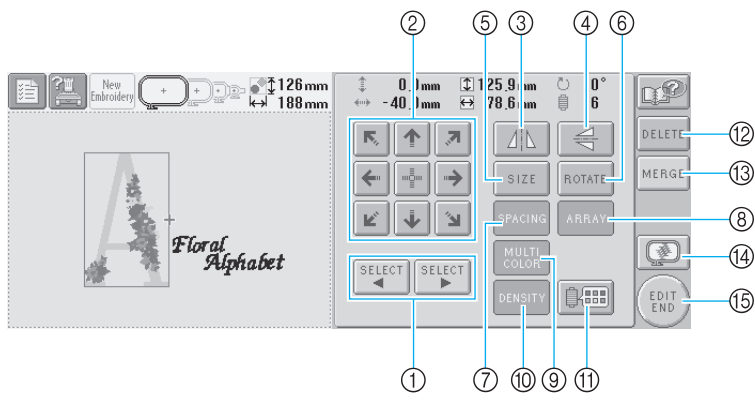

No.	Display	Key Name	Description	Reference Page
①		Pattern selection keys	Selects the pattern that is being edited when the embroidery pattern consists of multiple patterns that have been combined.	p.120
②		Positioning keys	Moves the sewing position of the pattern that is being edited in the direction of the arrow (If is touched, the sewing position is moved to the center of the embroidering area.)	p.120
③		Horizontal mirror image key	Flips the pattern being edited horizontally.	p.121
④		Vertical mirror image key	Flips the pattern being edited vertically.	p.121
⑤		Size key	Changes the size of the pattern that is being edited.	p.121
⑥		Rotate key	Rotates the pattern that is being edited.	p.122
⑦		Spacing key	Changes the spacing between the characters in the alphabet pattern that is being edited.	p.124
⑧		Array key	Changes the orientation of the characters in the alphabet pattern that is being edited.	p.123
⑨		Multi Color key	Enables the thread color of each character in an alphabet pattern to be changed; can only be used when an alphabet is selected.	p.126
⑩		Density key	Changes the density of the pattern that is being edited; can only be used if an alphabet or frame pattern is selected.	p.125
⑪		Change thread color key	Changes the color of the pattern.	p.127
⑫		Delete key	Deletes the pattern. If touched, the pattern being edited is deleted.	p.128
⑬		Merge key	Adds a pattern. If touched, the pattern group selection screen appears.	p.119
⑭		Preview key	Displays an image of the pattern so that it can be previewed.	p.27
⑮		Edit End key	Finish editing and continues to the embroidering settings screen.	p.25

Understanding the embroidering settings screen

From this screen, the entire pattern can be edited and embroidering settings can be specified. In addition, the embroidering position can be checked and a pattern can be saved for later use.

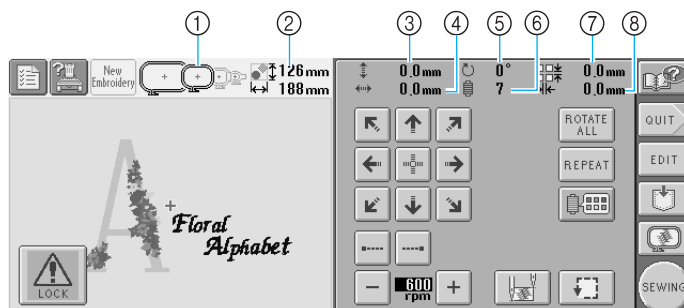

No.	Display	Key Name	Description	Reference Page
①		Embroidery frame indicators	Shows the sizes of embroidery frames that can be used to sew the embroidery pattern currently displayed in the pattern display area.	p.28
②		Pattern size	Shows the size of the embroidery pattern currently displayed in the pattern display area. The top value shows the height and the bottom value shows the width. If the embroidery pattern consists of multiple patterns that have been combined, the size of the entire pattern, including all patterns, is shown.	
③		Distance from center (vertical)	Shows the vertical distance that the pattern being edited is moved.	p. 72
④		Distance from center (horizontal)	Shows the horizontal distance that the pattern being edited is moved.	p.72
⑤		Rotation angle	Shows the rotation angle that the pattern being edited is rotated.	p.73, 129
⑥		Number of thread color changes	Shows the total number of thread color changes for the pattern that is being edited.	
⑦		Repeat spacing (vertical)	Shows the vertical distance between patterns when repeat sewing is selected.	p.130
⑧		Repeat spacing (horizontal)	Shows the horizontal distance between patterns when repeat sewing is selected.	p. 130

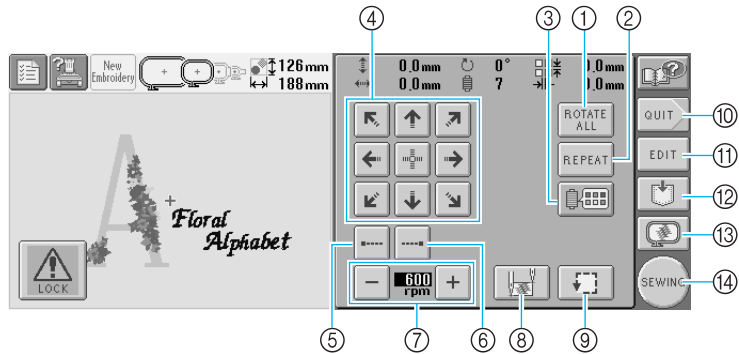

	No.	Display	Key Name	Description	Reference Page
Editing functions	①		Rotate All key	Rotates the entire embroidery pattern when it consists of multiple patterns that have been combined.	p. 73, 129
	②		Repeat key	Repeatedly sews the pattern.	p.130
	③		Change thread color key	Changes the color of the pattern.	p.127, 131
Embroidering settings	④		Positioning keys	Moves the sewing position of the whole pattern in the direction of the arrow (If is touched, the sewing position is moved to the center of the embroidering area.)	p.72
	⑤		Lock stitching (beginning) key	Specifies that automatic lock stitch is sewn at the beginning of the pattern and at the beginning of sewing after thread trimming.	p.88
	⑥		Lock stitching (end) key	Specifies that automatic lock stitch is sewn when the thread is trimmed.	p.88
	⑦		Maximum sewing speed key	Specifies the maximum sewing speed.	p.91
	⑧		Starting/ending position key	Specifies the needle position at the beginning of sewing and at the end.	p.89
	⑨		Trial sewing key	Moves the embroidery frame so that the embroidering position can be checked.	p.32
	⑩		Quit key	Cancels all operations previously performed and returns to the initial pattern type selection screen.	
	⑪		Edit key	Touch to return to the pattern editing screen.	
	⑫		Store key	Stores the pattern.	p.136
	⑬		Preview key	Displays an image of the pattern that is to be embroidered so it can be previewed.	p.27
	⑭		Sewing key	Finish all operations in the embroidering settings screen and continues to the embroidering screen.	p.32

* The functions and operations for the change thread color key ③ and the preview key ⑬ are the same in both the pattern editing screen and the embroidering settings screen.

Understanding the embroidering screen

From this screen, the total number of thread colors and the sewing time can be checked, the needle bar settings can be specified, and the stitching forward or backward can be done.

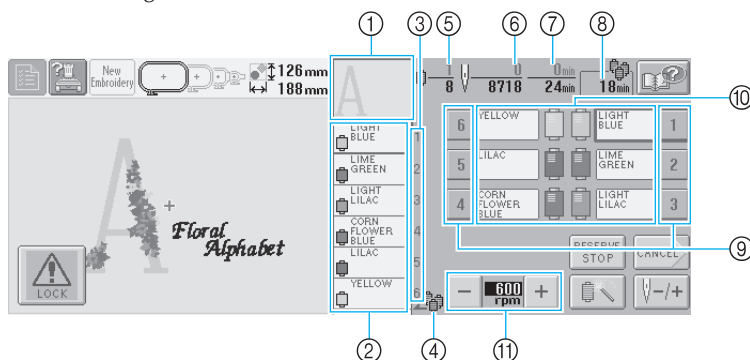

No.	Display	Key Name	Description	Reference Page
①		Region display	Shows the part of the pattern that will be sewn with the thread color shown first in the thread color sequence display.	
②		Thread color sequence display	Shows the order for the thread color changes. During embroidering, this display scrolls so that the color of the thread currently being sewn appears at the top.	
③		Needle bar number	Indicates the needle bar number where the thread color at the left is assigned.	
④		Spool change indicator	This indicator shows when the thread spools will need to be changed. The thread spools will need to be changed at the point between the two thread colors where the indicator is displayed.	p. 76
⑤		Sewing order	The bottom value shows the total number of thread color changes in the pattern and the top value shows the thread color that is currently being sewn.	
⑥		Stitch count	The bottom value shows the total number of stitches in the pattern and the top value shows how many stitches have already been sewn.	
⑦		Sewing time	The bottom value shows the total amount of time required to sew the pattern and the top value shows how much time has already passed sewing.	
⑧		Time until the spools must be replaced	If the pattern contains seven or more colors, the amount of time until the spools change is shown.	p. 75
⑨		Needle bar key	Touch a key to move the needle bar position to the selected needle bar number. Use when threading the needle with the automatic needle-threading mechanism.	p. 34
⑩		Thread color set up display	Shows the color and the thread color name (number) for the thread on the needle bar indicated on the key. Thread the machine as indicated here.	p.33
⑪		Maximum sewing speed key	Specifies the maximum sewing speed.	p.91

*The functions and operations for the maximum sewing speed keys ⑪ are the same in both the pattern editing screen and the embroidering settings screen.



Memo

- The thread color numbers in the thread color sequence display and the thread color set up display can be changed, for example, to the color name or the thread color number for other brands. (Refer to “Changing the thread color information” on page 145.)

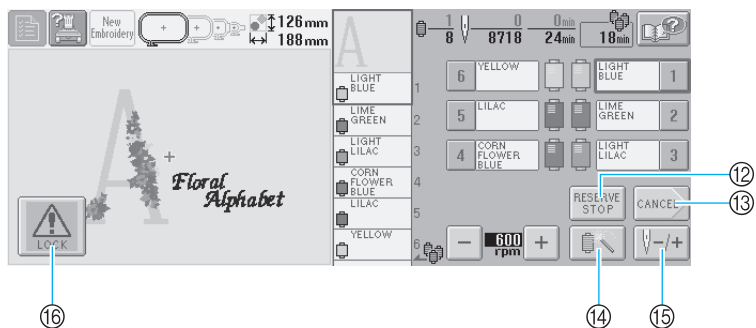

No.	Display	Key Name	Description	Reference Page
12		Reserve Stop key	While sewing embroidery, touch this key for the machine to stop as the next color begins.	p. 92
13		Cancel key	Touch this key to quit sewing and return to the embroidering settings screen.	
14		Temporary needle bar settings key	Enables the needle bar settings to manually be specified	p. 94
15		Forward/Backward stitch key	Moves the needle forward or backward through the stitching. Use this key in the following situations: <ul style="list-style-type: none"> ● If the thread breaks or runs out while embroidering ● To restart sewing from the beginning ● To continue sewing after the machine was turned off 	p.79
16		Unlock key	Unlocks the machine so it can start sewing within 10 seconds. When this key is touched, the start/stop button flashes in green.	p.42

When You Have a Question, This May Help You

TECHNICAL TERMS:

■ USB Type “A” (host) and USB Type “B” (function)

This is one of the communication methods between PC (Personal Computer) and peripherals. You can connect USB media via USB Type “A” (host) port connector and also you can connect your machine to your PC via USB Type “B” (function) port connector with included USB cable. (Refer to page 114.)

■ DST

This is the extension of Tajima data file (*.dst) that is one of the data formats of embroidery patterns. Tajima data doesn't have any color information, so the machine assigns colors automatically when you load it. (Refer to page 163.)

■ Needle number

The needles are numbered from right to left. The far right needle is number 1 needle. (Refer to page viii.)

■ Needle at the “embroidery position”

This is the needle that is placed above the needle hole in the needle plate. The needle bar case is moved to position that particular needle with the next thread color to the “embroidery position”. Also when using the needle threader, the needle that is going to be threaded should be moved to the “embroidery position”. (Refer to page 40.)

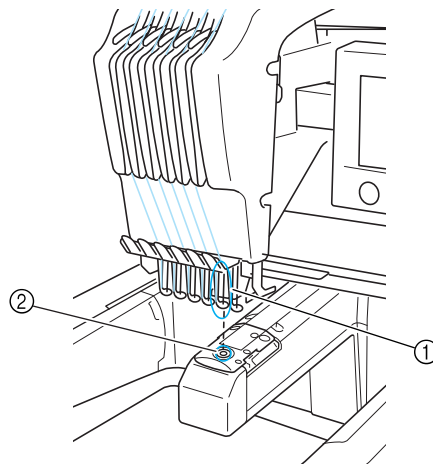

- ① Needle
- ② Needle hole in the needle plate

■ Wiper

This is the mechanism for pulling the thread. The wiper pulls the thread when the needle threader is used.

The wiper also pulls the thread from the material when the machine trims the thread. This makes trimming threads after embroidering unnecessary. (Refer to page 40.)

PATTERNS:

Following patterns can be used to embroider by the machine.

- Embroidery data with *.pes, *.phc or *.dst format. USB media transfer the data to the machine. Also via USB cable, the data can be transferred from the PC to the machine.
- Optional embroidery cards
- Embroidery patterns created by digitizing software program
- The patterns saved on USB media by the machine

EMBROIDERING:

■ Customize the embroidery colors

- Use the "Change thread color" function by selecting the key on either the "pattern editing" or the "embroidery setting" screen. More details please see the page 127.
- Use the "Temporary needle bar setting" function by selecting the key on the "embroidering" screen. More details please see the page 94.

■ Resume an unfinished pattern from the last time the machine was switched off.

- The machine remembers the pattern and the position even after turning off the power. And the machine can resume the embroidery when the machine turns on again. (Refer to page 62.)

■ Getting false thread breakage error

- Check that the position of the upper thread is under the upper thread guide plates. (Refer to page 36.)
- Check that the position of the upper thread is around the thread tension disk. (Refer to page 37.)

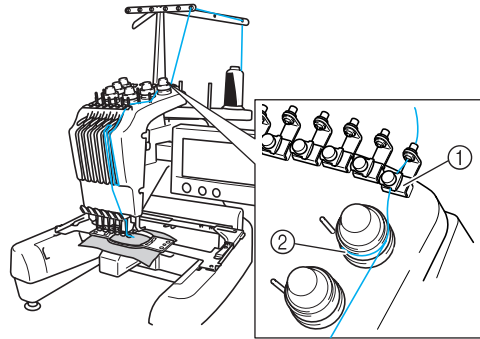

- ① Upper thread guide plates
- ② Thread tension disk

■ Thread tension changed suddenly

- Thread is caught on a rough edge of the spool of upper thread.
- Upper thread is caught under the spool of thread.
- The thread dust or lint is gathered under the bobbin's tension spring.

■ The frame came out from the carriage

Make sure that the positioning pins are placed into the frame's positioning slot and hole. (Refer to page 31.)

It is a good idea to turn off the machine once to originate the carriage before you re-sew the pattern.

■ Cancel the current design and start again

Select the "New Embroidery" key on the upper left of the screen. The pattern and all information will be deleted. (Refer to page 49.)

3**OTHER BASIC PROCEDURES**

This chapter provides explanations on operations other than those described in chapter 2, such as sewing a pattern with seven or more colors, changing the needles and changing thread spools.

Resume the Operation Being Performed Before the Machine Was Turned OFF.....	62
Changing the Needle.....	63
Replacing the needle / 63	
Correctly Using the Embroidery Frames.....	65
Embroidery frame types and applications / 65	
Attaching Iron-On Stabilizer (Backing) to Fabric	66
Hooping the Fabric	67
Hooping the fabric in the extra-large and large embroidery frames / 67	
Using the embroidery sheet / 68	Large/small pieces of fabric / 69
Embroidery Frame Position and Movement.....	70
Changing the Embroidering Position	72
Adjusting the angle / 73	
Embroidering a Pattern Containing Seven or More Colors	75
Checking if thread spool changes are necessary / 75	
Changing the Thread Spools with Designs of Seven or More Colors	77
Change thread spools message / 77	Easily changing the thread spools / 78
If the Thread Breaks or the Bobbin Thread Runs Out While Embroidering	79
If the upper thread breaks / 79	If the bobbin thread breaks or runs out / 80
Embroidering From the Beginning or Middle of the Pattern	81
Resume Embroidering After Turning OFF the Machine	83
Adjusting the Thread Tension.....	85
Adjusting the tension of the bobbin thread / 85	
Adjusting the tension of the upper thread / 86	

Resume the Operation Being Performed Before the Machine Was Turned OFF

The screen that appears after the machine is turned on and **OK** is touched differs depending on how the machine was previously turned off. If the machine was turned off while an operation was being performed, you can choose to continue the operation being performed before the machine was turned off.

1 Turn on the embroidery machine.

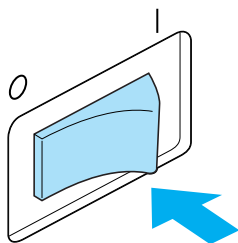

2 When the screen shown below appears after the initial screen, touch **OK**.



- ▶ A message appears, asking if you wish to continue the previous operation or begin a new one.
 - If the machine was turned off while an operation was not being performed, the pattern type selection screen appears.

■ To continue the operation being performed before the machine was turned off

3 Touch **OK**.

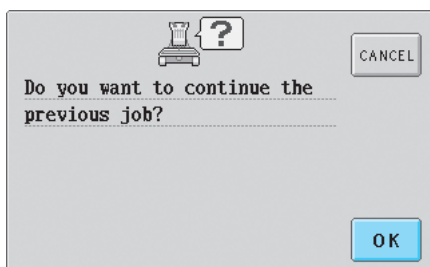

- ▶ Depending on the screen that was displayed before the machine was turned off, the pattern editing screen, the embroidering settings screen or the embroidering screen appears.

■ To select a pattern and start a new operation

3 Touch **CANCEL**.

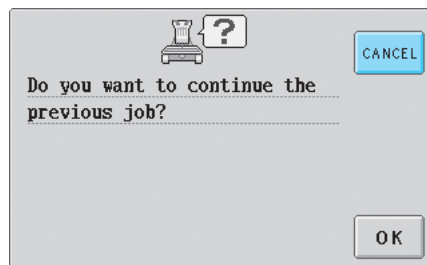

- ▶ The pattern type selection screen appears.

Memo

- If **SET** is not touched to confirm the selection of the pattern in the pattern list screen, the operation cannot be continued.
- The screen that appears when an operation is continued differs depending on the screen that was displayed when the machine was turned off.
 - If the operation in the pattern editing screen is finished:**
That pattern editing screen appears.
 - If the machine was turned off after a pattern is selected and while the pattern type selection screen or the pattern list screen is displayed:**
The pattern editing screen for the selected pattern appears.
 - If the machine was turned off while the embroidering settings screen is displayed:**
The embroidering settings screen for that pattern appears.
 - If the machine was turned off while embroidering:**
The embroidering screen appears with the needle positioned at the stitch being sewn when the machine was turned off.

Changing the Needle

If the needle is bent or the tip of the needle is broken, replace the needle with a new one. Use the included allen screw driver to replace the needle with one that is designed specifically for this machine and that passes the test described in “Checking the needle” (on page 15).

Replacing the needle

- 1 Turn off the embroidery machine.

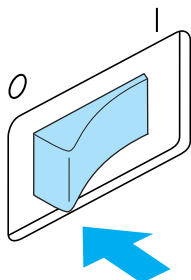

CAUTION

- Be sure to turn off the embroidery machine before replacing the needle, otherwise injuries may result if the machine starts sewing.

- 2 Loosen the needle set screw and remove the needle.

Hold the needle with your left hand, and then hold the allen screw driver in your right hand and turn the needle set screw counterclockwise.

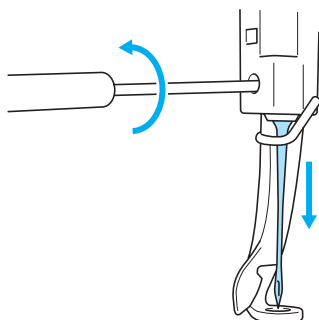

Note

- Be sure to use the included allen screw driver to replace the needle, otherwise too much force may be applied to the needle, causing it to break.

- Do not apply extreme force when loosening or tightening the needle set screw, otherwise the machine may be damaged.

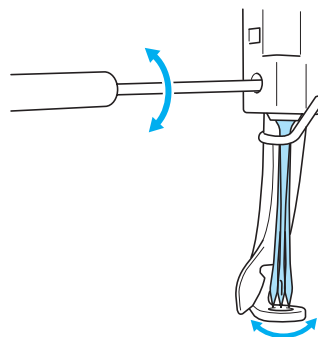

- 3 With the flat side of the needle toward the back of the machine, insert the needle all the way up until it touches the needle bar stopper. Pass the needle through the hole in the presser foot, and then use the needle changing tool to lift up the needle.

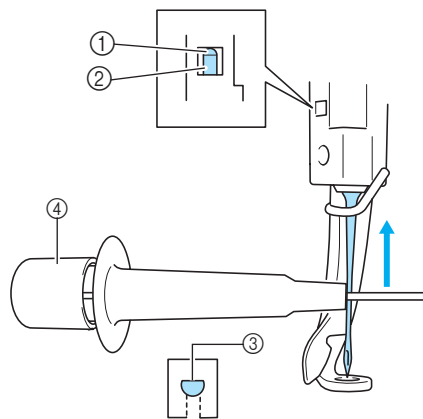

- ① Needle bar stopper
- ② Needle
- ③ Flat side of needle
- ④ Needle changing tool

As shown in the illustration, press ① to extend the needle-mounting clamp ②. Attach the clamp to the needle, and then release the pressed area to clamp the needle. To unclamp the needle, press ① again.

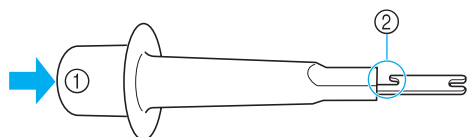

4 While holding the needle in place with your left hand, tighten the needle set screw.

Use the allen screw driver to turn the needle set screw clockwise.

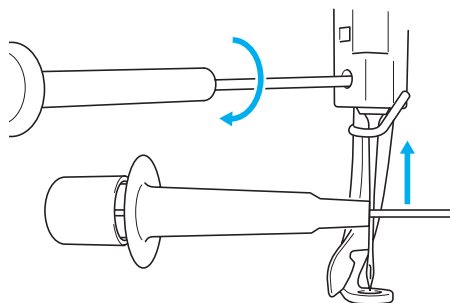

! CAUTION

- Be sure to insert the needle all the way up until it touches the needle bar stopper and securely tighten the needle set screw with the allen screw driver, otherwise the needle may break or the machine may be damaged.
- If the needle is not fully inserted, the hook of the automatic needle-threading mechanism will not pass through the eye of the needle during automatic needle threading, and the hook may bend or the needle cannot be threaded.
- If the hook of the automatic needle-threading mechanism is bent or damaged, contact your authorized retailer.





Correctly Using the Embroidery Frames

The various types of embroidery frames and their uses are described below. In addition to the included embroidery frames, the optional cap frame can be used with this embroidery machine.

CAUTION

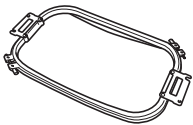
- Only use embroidery frames of the sizes indicated in the screen, otherwise the embroidery frame may hit the presser foot, which may result in injuries.

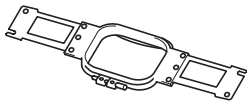
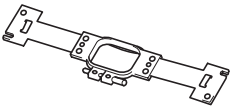
Embroidery frame types and applications

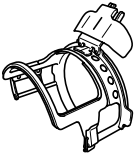
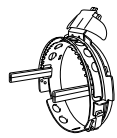
Extra-large embroidery frame	Large embroidery frame	Medium embroidery frame	Small embroidery frame
			
Embroidering area: 200 mm (H) × 300 mm (W) (7-7/8 inches (H) × 11-3/4 inches (W))	Embroidering area: 130 mm (H) × 180 mm (W) (5-1/8 inches (H) × 7-1/8 inches (W))	Embroidering area: 100 mm (H) × 100 mm (W) (4 inches (H) × 4 inches (W))	Embroidering area: 40 mm (H) × 60 mm (W) (1-1/2 inches (H) × 2-3/8 inches (W))
Use when embroidering connecting characters or patterns, combined patterns or large embroidery patterns.	Use when embroidering patterns with a size less than 130 mm (H) × 180 mm (W) (5-1/8 inches (H) × 7-1/8 inches (W))	Use when embroidering standard-sized patterns.	Use when embroidering small-sized patterns, such as nametags.
(Refer to “Hooping the Fabric” on page 67.)		(Refer to “Hooping the Fabric in the Embroidery Frame” on page 28.)	
Cap frame (optional)		 Note <ul style="list-style-type: none"> ● The embroidery frame indicators show all embroidery frame sizes in which the embroidery pattern can be sewn. Be sure to use an embroidery frame of the most suitable size. If the embroidery frame that is too large is used, the pattern may be misaligned or the fabric may pucker. 	
<Standard type>	<Advanced type>		
			
Embroidering area: 50 mm (H) × 130 mm (W) (2 inches (H) × 5-1/8 inches (W))			
Use when embroidering caps. Baseball (golf) caps, tulip hats and bucket hats can be embroidered with this frame. This frame cannot be used with hats having a front area of 50 mm (2 inches) or less, such as sun visors and children’s hats. In addition, it cannot be used with hats that have a brim longer than 80 mm (3-1/8 inches). (For details on attaching this frame, refer to “Using the Optional Cap Frame” on page 169.)			

Attaching Iron-On Stabilizer (Backing) to Fabric

In order to prevent shrinkage of the stitching or misaligned patterns, we recommend that iron-on stabilizer (backing) be used for embroidering.

CAUTION

- When embroidering on thin or stretch fabrics, fabrics with a coarse weave or fabrics that easily allow the stitching to shrink, be sure to use iron-on stabilizer (backing) for embroidering. If iron-on stabilizer (backing) is not used while embroidering, the needle may bend or break or the pattern may become misaligned.

- 1 Using a steam iron, affix the iron-on stabilizer (backing) to the back of the fabric.

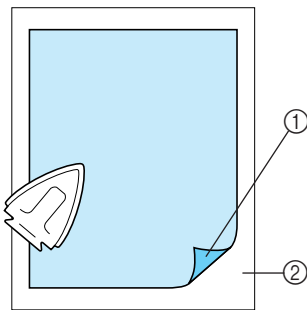

- ① Adhesive side of iron-on stabilizer (backing)
② Fabric (wrong side)

- When embroidering fabric that should not be ironed or when embroidering an area that is difficult to iron, hoop a layer of the iron-on stabilizer (backing) under the fabric in the embroidery frame without ironing it.

Note

- Use a piece of iron-on stabilizer (backing) that is larger than the embroidery frame. When framing the fabric in the embroidery frame, be sure that the stabilizer (backing) is clamped on all edges in order to prevent wrinkles in the fabric.

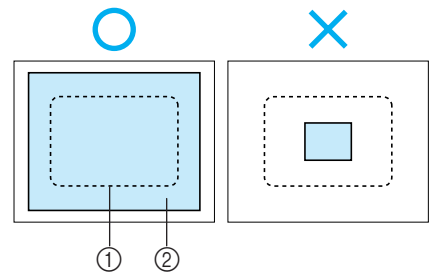

- ① Area of embroidery frame
② Iron-on stabilizer (backing)

Memo

- When embroidering thin fabrics, such as organza or lawn, use a water-soluble stabilizer (backing). Water-soluble stabilizers dissolve when washed, allowing you to create beautiful embroidery that is not stiff.
- When embroidering fabric with a nap, such as towels or corduroy, hoop a layer of iron-on stabilizer (backing) under the fabric in the embroidery frame without ironing it.
- For other uses of stabilizer (backing), refer to “Stabilizers (Backing)” on page 165.

Hooping the Fabric

Hooping the fabric in the extra-large and large embroidery frames

1 Loosen the screw on the outer frame.

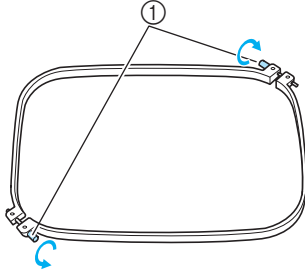

① Screw

2 Place the fabric with right side up on top of the outer frame.

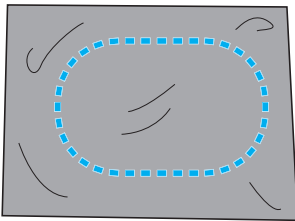

- The outer frame does not have a front or back side. Either side can be used as the front.

3 Press the inner frame into the outer frame.

First insert the inner frame at the corner with the screw **A**, next insert the nearby one corner **B**, and then insert the opposite corner **C**. Then insert the opposite corner of non screw corner **D**.

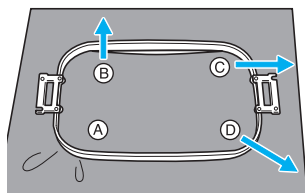

First, align the inner and outer frames at the corner with the screw **A**. Then, while lightly pulling the fabric in the direction indicated by arrow **B** so that the fabric is taut, insert the inner frame at corner **B**. In the same way, lightly pull the fabric in the direction indicated by arrow **C** and insert corner **C**, and then

lightly pull the fabric in the direction indicated by arrow **D** and insert corner **D**.

- Be sure that there are no wrinkles in the fabric after it is stretched in the embroidery frame.

4 While stretching the fabric even more, securely tighten the screw so that the fabric is taut.

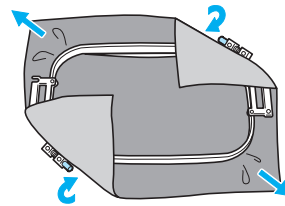

- After stretching the fabric, lightly tapping it should produce a drum-like sound.
- Firmly clamp together the inner and outer frames so that their tops are even.

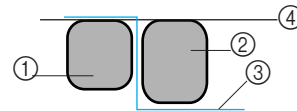

- ① Outer frame
- ② Inner frame
- ③ Right side of fabric
- ④ Top of inner & outer frames are even

- Using the included disc-shaped screwdriver, firmly tighten the screw.

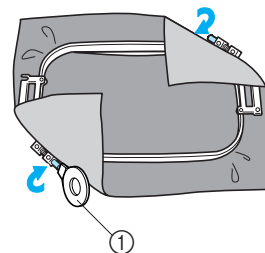

① Disc-shaped screwdriver

Memo

- To correctly frame the fabric in the embroidery frame, we recommend using a flat surface.

Using the embroidery sheet

In order to hoop the fabric so that the pattern will be sewn in the correct position, use the guidelines on the embroidery sheet to accurately stretch the fabric in the frame.

- 1 With a fabric marker, mark the area of the fabric you want to embroider.

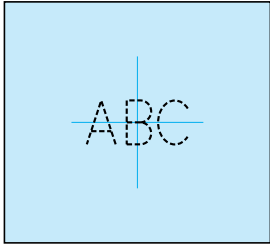

- 2 Place the embroidery sheet on the inner frame. Align the guidelines on the embroidery sheet with the marks that you drew on the fabric.

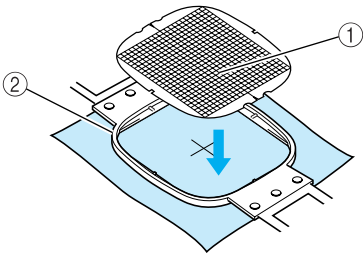

- ① Guidelines
- ② Inner frame

- 3 Gently stretch the fabric, so that there are no folds or wrinkles.

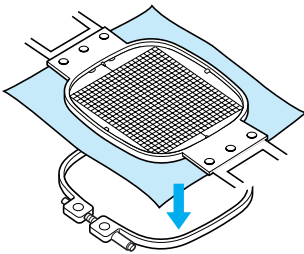

- 4 Press the inner frame into the outer frame. Remove the embroidery sheet.

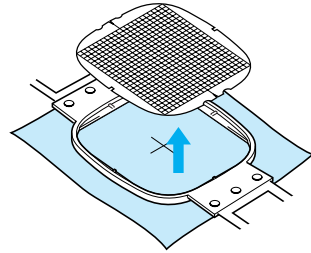

Large/small pieces of fabric

This section provides information on embroidering fabric that is either much larger or much smaller than the embroidery frame.

■ Embroidering large pieces of fabric or heavy clothing

When embroidering large pieces of fabric or heavy pieces of clothing, use a clothespin or binder clip to fasten the excess fabric to the embroidery frame so that it does not hang down from the frame. Embroidering with excess fabric hanging down from the embroidery frame may prevent the frame from moving properly and may result in a misaligned pattern.

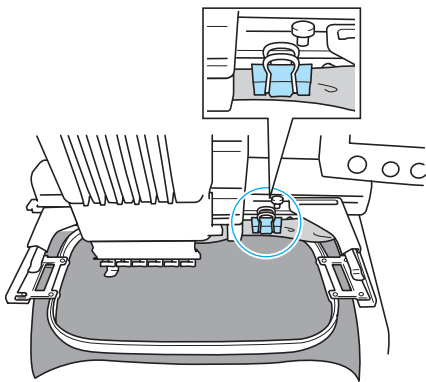

- Use a clothespin or binder clip to fasten the excess fabric to the embroidery frame.

■ Embroidering small pieces of fabric

When embroidering pieces of fabric that are smaller than the embroidery frame, use spray fabric adhesive to attach the fabric to stabilizer (backing) hooped in the embroidery frame. With fabrics where you do not wish to use spray adhesive, baste the fabric to the stabilizer (backing).

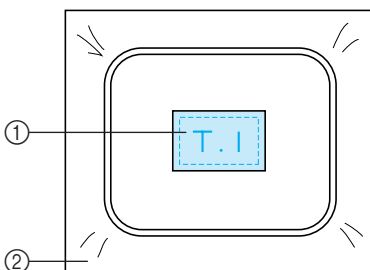

- ① Fabric
- ② Stabilizer (backing)

■ Embroidering the corner of fabric

When embroidering the corner of a piece of fabric, use spray fabric adhesive to attach the corner of the fabric to stabilizer (backing), and then hoop the stabilizer (backing) in the embroidery frame. With fabrics where you do not wish to use spray adhesive, baste the fabric to the stabilizer (backing).

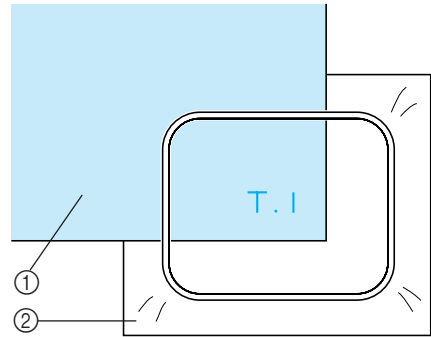

- ① Fabric
- ② Stabilizer (backing)

■ Embroidering narrow pieces of fabric, such as ribbon

When embroidering narrow pieces of fabric, use spray fabric adhesive to attach the fabric to stabilizer (backing), and then hoop the stabilizer (backing) in the embroidery frame. With fabrics where you do not wish to use spray adhesive, clamp both ends of the fabric, together with the stabilizer (backing), in the embroidery frame.

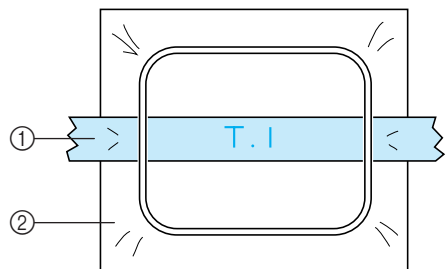

- ① Ribbon
- ② Stabilizer (backing)

Embroidery Frame Position and Movement

The following provides information concerning the embroidery frame when operating the embroidery machine.

■ Embroidery frames that cannot be used for embroidering

As explained on page 28, the embroidery frame indicators at the top of the screen show the embroidery frames that can be used to sew the currently selected pattern.

Embroidery frames with an embroidering area smaller than the pattern cannot be used. In addition, the embroidery frame cannot be used if the embroidery is smaller than the embroidering area but is positioned so that it extends out of the embroidering area of the frame.

Embroidery frames with an embroidering area smaller than the pattern

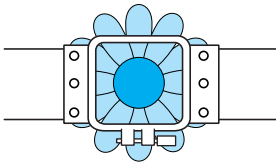

Patterns that extend out of the embroidering area of the frame

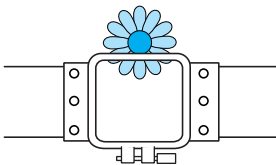

In either of these cases, a message appears on the embroidery machine, warning that the embroidery frame must be changed.

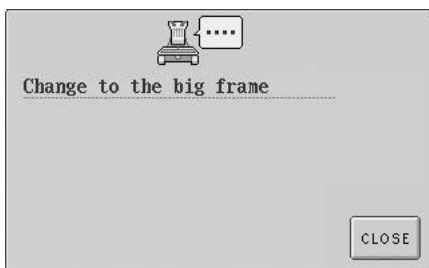

The embroidery machine detects which embroidery frame is installed according to the position of the left arm of the embroidery frame holder. Therefore, the embroidery frame size is determined by the position of the left arm, even if the detected embroidery frame is not actually installed. In addition, if the embroidery frame holder is not installed, the embroidery machine determines that the cap frame (sold separately) is installed.

A message indicating that the embroidery frame be replaced may appear even if no embroidery frame is installed.

■ Moving to the correct position

If the center of the embroidery frame is at the needle drop point in the embroidering area, the embroidery frame is correctly positioned, in other words, at the starting position before embroidering.

If the embroidery frame is changed, the next frame that is installed will not be correctly positioned.

For example, if the extra-large embroidery frame is replaced with the small frame, the following will occur.

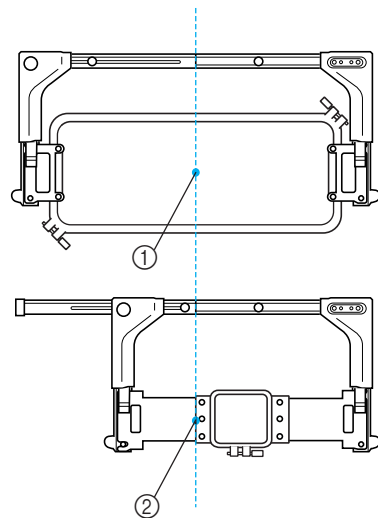

- ① Center of embroidery frame at the correct position
- ② Needle position when the embroidery frame is replaced

In order to correct the misalignment of this embroidery frame, the embroidery frame automatically moves to the correct position when any of the following are performed.

- **The embroidery machine is turned on.**
The embroidery frame will move.
- **The embroidering settings screen is displayed.**
The embroidery frame will not move if it is correctly positioned.

If the pattern extends out of the embroidering area for the frame, a message appears, indicating that the embroidery frame should be replaced. Either replace the embroidery frame or return to the pattern editing screen and move the embroidering position.

- **The embroidery frame is replaced while the embroidering settings screen or embroidering screen is displayed, and then the key for checking the embroidering area, for moving the embroidery frame, or for starting embroidering is touched.**









The embroidery frame will move.

Since the embroidery frame is moved to the correct position and paused, touch the desired key again.

If the pattern extends out of the embroidering area for the frame after the frame is moved, a message appears, indicating that the embroidery frame should be replaced. Either replace the embroidery frame or return to the pattern editing screen and adjust the pattern size or embroidering position.

Changing the Embroidering Position

When the embroidery machine is purchased, it was adjusted so that the beginning of the stitching was from the center of the pattern. Therefore, move the frame and adjust the embroidering position so that the center of the pattern aligns with the needle drop point at the sewing position. In addition, the angle of the entire pattern can be adjusted if the fabric cannot be hooped evenly within the embroidery frame and the pattern is positioned at an angle on the fabric.

- 1 Touch , , , , , , , and  in the embroidering settings screen.

Move the embroidery frame so that the needle drop point is at the center of the area where you wish to embroider.

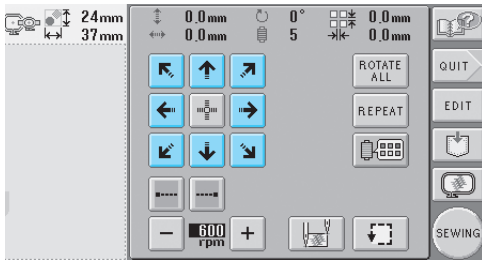

- ▶ The embroidery frame moves in the opposite direction of the arrow.
- ▶ The pattern in the pattern display area moves in the same direction of the arrow.

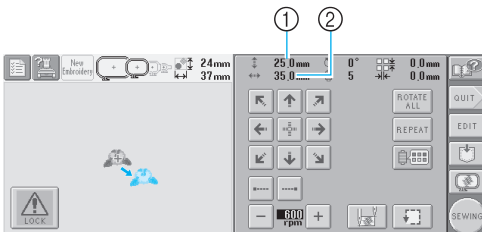

- ① Shows the vertical distance moved
- ② Shows the horizontal distance moved

- Touch  to move the embroidery frame back to its original position (where the center of the embroidery frame is aligned with the needle drop point at the sewing position).

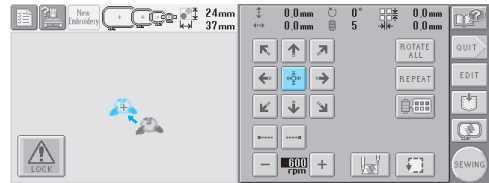

■ Finding the sewing position

By locking the needle bar (securing the needle and presser foot in the down position), the needle drop point can easily be seen.

- 1 As shown in the illustration, insert the allen screwdriver into the square hole in the needle clamp to slowly lower the needle bar down till needle bar stops then clicks into the lock position.



Note

- Make sure that the needle is not lowered beyond the positioning click into the fabric.

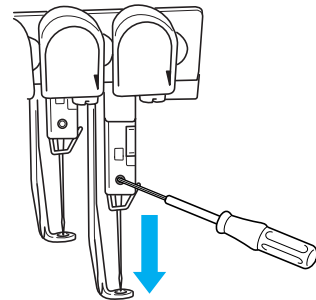

- ▶ The needle and presser foot are locked in the down position.

- 2** Touch the arrow keys in the embroidery settings screen to move the embroidery frame so that the needle drop point is at the center of the area where you wish to embroider.

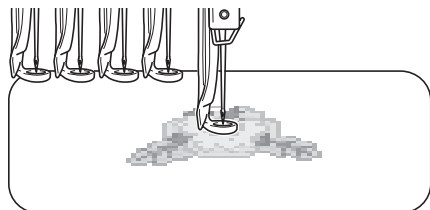

- When specifying the starting of stitching, align the needle drop point with the point specified as the starting of stitching. (For details on specifying the starting/ending of stitching, refer to page 89.)

■ Unlocking the needle bar

- 1** Display the embroidering screen, and then touch the key for any needle bar other than the one that is locked.

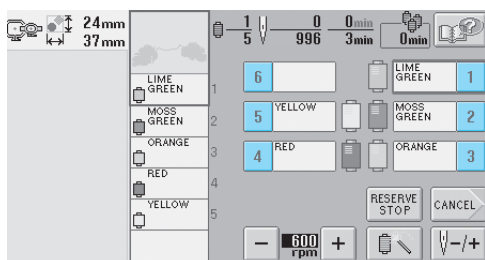

- The needle bar is unlocked.

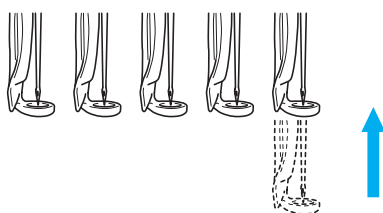

Adjusting the angle

Depending on the type of fabric being embroidered, it may not be possible to stretch the fabric in the embroidery frame at the desired angle. In this case, adjust the angle of the pattern so that it is correctly positioned on the fabric.

- 1** Touch **ROTATE ALL**.

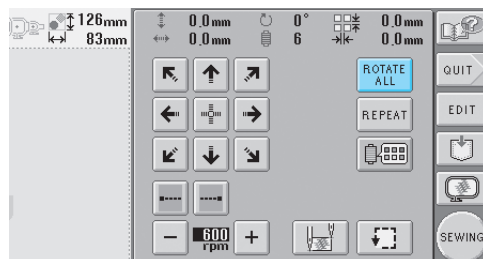

The screen shown below appears.

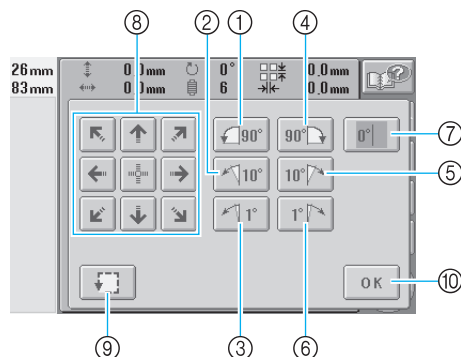

Example: Original angle

- ① Rotates 90 degrees to the left
- ② Rotates 10 degrees to the left
- ③ Rotates 1 degree to the left
- ④ Rotates 90 degrees to the right
- ⑤ Rotates 10 degrees to the right
- ⑥ Rotates 1 degree to the right
- ⑦ Touch this key to return the pattern to its original angle.
- ⑧ Moves the pattern in the direction of the arrow on the key.
- ⑨ Enables the embroidering area to be checked
- ⑩ Touch this key to close this screen.



2 Touch the keys to adjust the pattern to the desired angle.

Each touch of a key rotates the pattern.

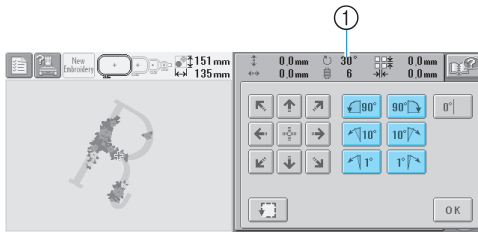

- ① Shows the angle of the pattern after a key is touched to change it
- To return the pattern to its original angle (0 degrees), touch **0°** so that it changes to **0°**.

3 If necessary, touch the arrow keys to adjust the position of the pattern.

For more details, refer to page 72.

4 If necessary, touch **↕** to check the embroidering area.

For more details, refer to page 32.

5 After making the desired changes, touch **OK**.

The embroidering settings screen appears again.



Memo

- If **EDIT** is touched to return to the pattern editing screen after the entire pattern is rotated, the pattern appears as it did before the rotation angle was specified, but the setting is not cancelled. When the embroidering settings screen is displayed again, the pattern appears with the rotation angle applied. However, if an error occurs, for example, if the pattern is enlarged in the pattern editing screen so that it extends out of the embroidering area when it is rotated, the following error message appears.

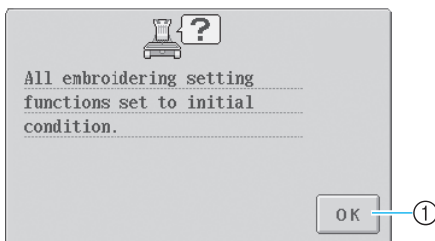

- ① Touch **OK** to return to the pattern editing screen so that the pattern can be re-edited.



Memo

- With this operation, fine adjustments can be made to the angle; also, this operation is particularly useful when embroidering items, such as bags and tubular items, that have limitations to being hooped in the embroidery frame.

Example: When embroidering a pillowcase Rotate the pattern 90 degrees to the left before embroidering.

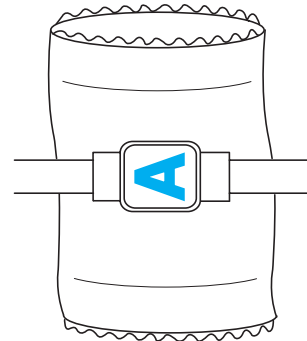

Example: When embroidering a T-shirt Rotate the pattern 180 degrees. Pass the machine bed through from the waist of the T-shirt, not from the neck, and attach the embroidery frame to the machine. Prevent the neck to be stretched when the embroidery frame is moved.

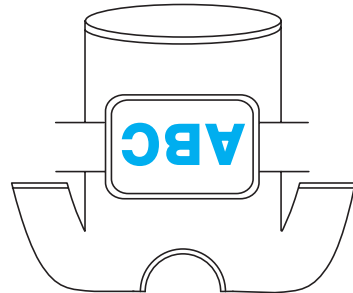

Embroidering a Pattern Containing Seven or More Colors

When embroidering a pattern that uses seven or more thread colors, it is necessary to change the thread spools. When changing the thread spools, instruction to change the thread spools will appear with the machine automatically stopping.

■ Assignment of thread colors to needle bars

Thread colors are automatically assigned by the machine to needle bars 1 to 6, starting with the thread colors that are sewn first. (However, if a new pattern has thread colors that are the same as the previously sewn pattern, the thread colors will be assigned to the same needle bar as before, regardless of the sewing order.)

For example, for a pattern with six thread colors and ten thread color changes, the thread colors are assigned as shown below.

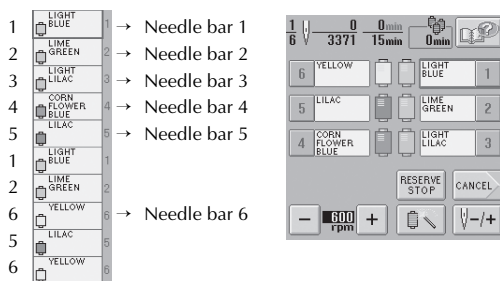

For a pattern with seven or more thread colors, the thread spool information is updated when the seventh thread color is needed.

Afterward, the machine adjusts the assignment of thread colors to reduce the number of times that the thread spools will have to be changed.

For example, for a pattern with ten thread colors and thirteen thread color changes, the thread colors are assigned as shown below.

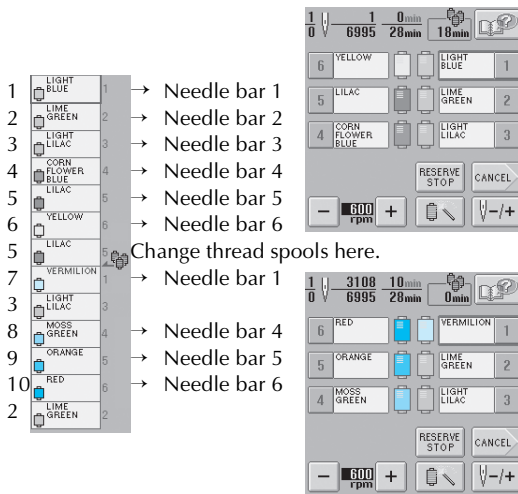

Since the thread colors on needle bars 2 and 3 will be used again after the thread spools are changed, they will not be replaced. However, different colors are assigned to the other needle bars.

Checking if thread spool changes are necessary

When selecting a pattern, the number of thread changes can be viewed, however, which thread colors are used in the pattern cannot be checked on this screen. Whether or not and when thread spools will need to be changed can be checked with the following indicators.

■ Time until the spools must be changed

This indicator shows the amount of time until the next spool change. When the embroidering screen is displayed, if a length of time appears here, at least one spool change will be required.

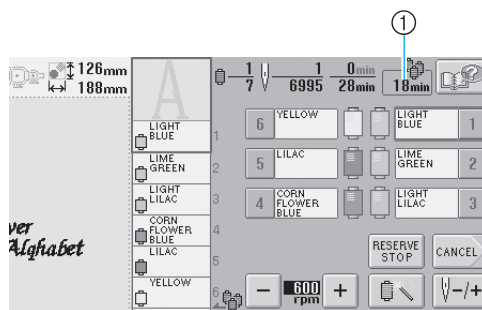

① Time until the spools must be changed

■ Spool change indicator ()

The spool change indicator in the stitch navigating screen indicates the number of times that the thread spools will need to be changed and the amount of time between changes.

1 Touch in the embroidering screen.

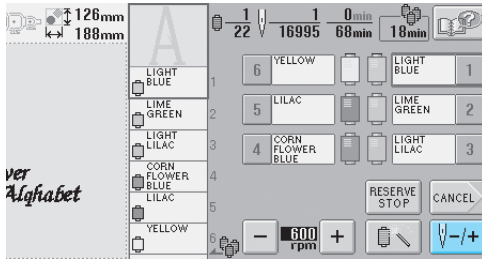

► The stitch navigating screen appears.

2 Touch .

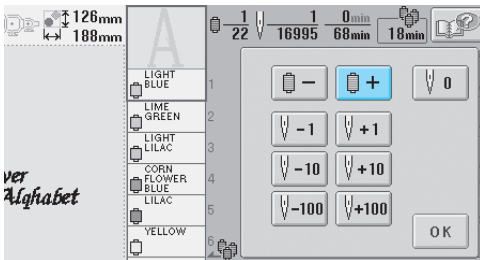

► Each time this key is touched, the next color in the thread color sequence display is selected. After reaching the last color in the thread color sequence display, the scrolling stops.

3 Check the position of .

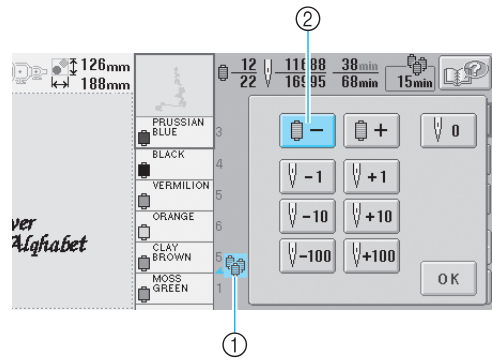

①  indicates when the thread spools will need to be changed. The thread spools will need to be changed the number of times that this indicator is displayed and between the two thread colors at the point where it is displayed.

② Touch  to scroll up through thread color sequence display. Each time this key is touched, the previous color in the thread color sequence display is selected. After reaching the first color in the thread color sequence display, the scrolling stops.

4 After checking the desired information, touch

 or  to return to the first color.

And then touch .

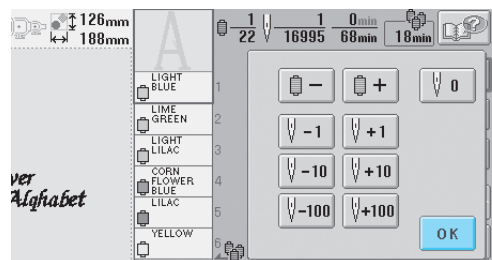

► The embroidering screen appears again.

Changing the Thread Spools with Designs of Seven or More Colors

This section contains details on understanding the change thread spools message and on easily changing the thread spools.

Change thread spools message

When it is necessary to replace the thread spool while embroidering a pattern that contains seven or more colors, the machine automatically stops sewing and the message shown below appears. This message also appears when it is necessary to change the thread spools before beginning to embroider a new pattern. Change the thread spools according to their new assignments.

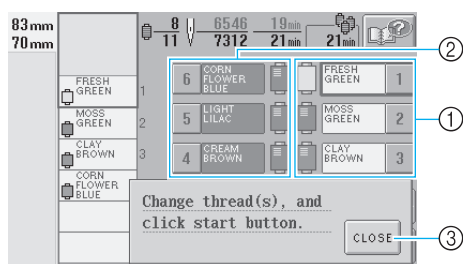

- ① The needle bars where the thread spools must be changed appear in color.
- ② The needle bars where it is not necessary to change the thread spools appear in gray.
- ③ Touch this key to close the message indicating that the thread spool be changed.



Note

- When the embroidering screen is displayed, the current thread color assignment is stored. If the same thread color is used the next time that the thread spools must be changed, the needle bar will be assigned the same thread color as before.



Memo

- To use a different thread color than the one that was specified, use temporary needle bar setting key, and then change the thread color setting. (For details, refer to “Temporary Needle Bar Setting” on page 94.)
- To minimize changing the thread spools, frequently used thread colors can be specifically assigned to certain needle bars. (For details, refer to “Reserved Needle Bar Settings” on page 96.)

Easily changing the thread spools

When replacing the thread spools, it is necessary to re-thread the upper thread. However, the thread spools can easily be changed when replacing a thread spool whose thread is correctly threaded through the machine.

- 1 Cut the thread between the thread spool and the thread guide.

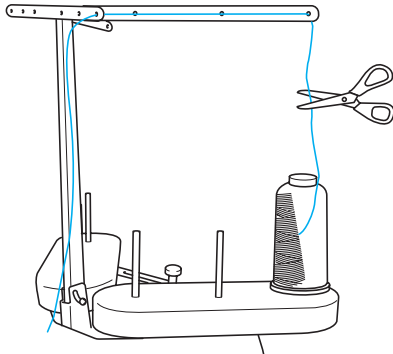

- 2 Change the thread spool.

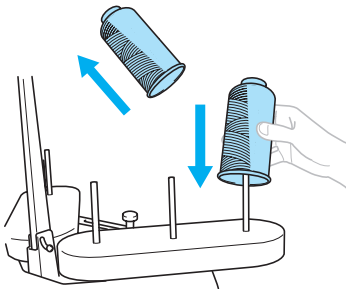

- 3 Tie the end of the thread on the new spool with the end of the thread remaining from the previous color.

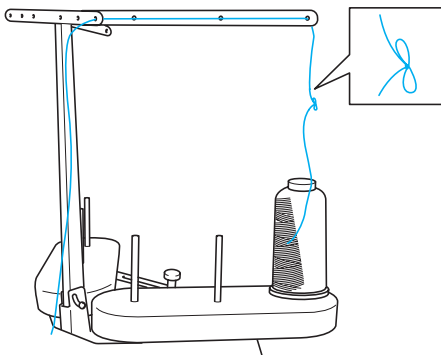

- 4 Pull out the old thread just after the needle bar thread guide.

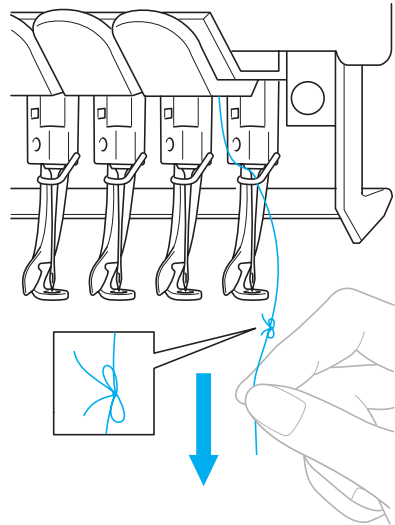

Continue pulling the thread until the knot is above the needle. Cut the knot.

- 5 Use the automatic needle-threading mechanism to thread the needle with the new thread. (Refer to page 39)

► This completes the changing of the thread spool.

Note

- When pulling out the thread, do not pull the knot through the eye of the needle. If the knot is pulled through the eye of the needle, the needle may be damaged.

If the Thread Breaks or the Bobbin Thread Runs Out While Embroidering

If the thread breaks or the bobbin thread runs out while embroidering, the machine will automatically stop. Since some stitches may be sewn with only one thread, go back through the stitching to a point where stitches have already been sewn before continuing embroidering.



Note

- Be careful when going back or forward through the stitching since the embroidery frame moves at the same time.



If the upper thread breaks

1 Re-thread the upper thread. (Refer to page 35.)

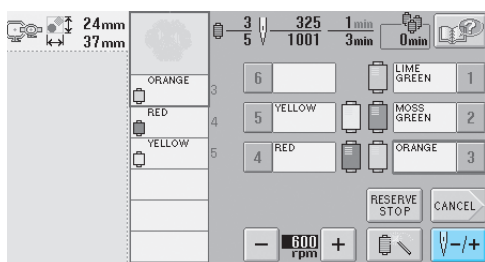
2 Touch .



► The stitch navigating screen appears.

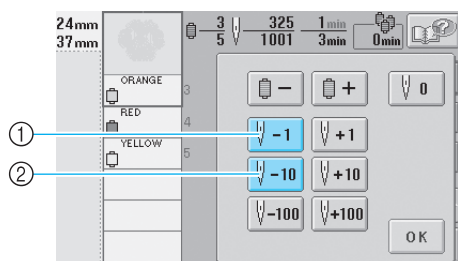

3 Touch  and  to go back through the stitching to a point where stitches have already been sewn.



- ① Each touch of this key moves one stitch back through the stitching.
- ② Each touch of this key moves ten stitches back through the stitching.

The embroidery frame moves. Go back to the point where stitches have already been sewn.



If the needle bar is moved back too far through the stitching, touch  or  to go forward through the stitching.

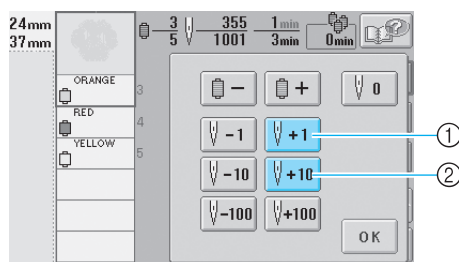

- ① Each touch of this key moves one stitch forward through the stitching.
- ② Each touch of this key moves ten stitches forward through the stitching.

4 Touch .

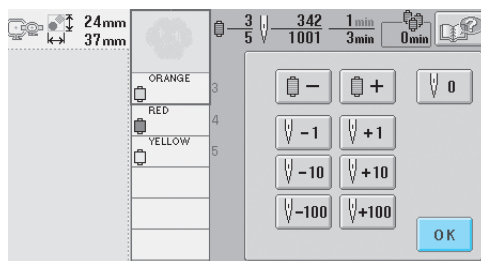

► The embroidering screen appears again.

5 Touch , and then press the start/stop button to continue embroidering.

If the bobbin thread breaks or runs out

- 1** Touch , and then press the thread trimming button.

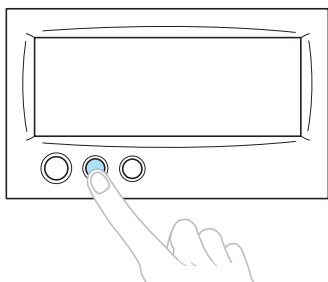

- ▶ The upper thread is trimmed.
- If the bobbin thread breaks or runs out, also trim the upper thread.

- 2** Remove the stitches sewn only with the upper thread. Pull the trim end of the upper thread.

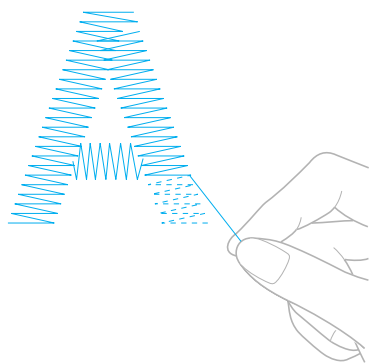

- If the stitches cannot be cleanly removed, trim the thread with scissors.

- If the bobbin thread ran out, replace the bobbin at this point in the procedure.

- 3** Replace the bobbin with a bobbin wound with bobbin thread. (Refer to page 18.)

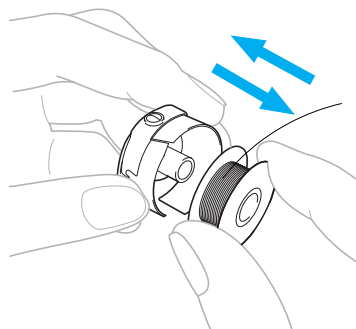

- If the hook cover can be opened, replace the bobbin without removing the embroidery frame from the machine.
- If the machine bed is hidden, for example, with a bag-shaped piece of fabric, or if the hook cover cannot be opened, temporarily remove the embroidery frame. (Refer to page 46.) After replacing the bobbin, re-attach the embroidery frame. (Refer to page 30.)

Note

If the embroidery frame is removed before embroidering of the pattern is finished, be careful of the following, otherwise the pattern may become misaligned.

- Do not apply extreme pressure to the framed fabric and cause it to become loose.
- When removing and re-attaching the embroidery frame, do not allow the frame to hit the carriage or the presser foot. If the carriage is hit and moves, turn the machine off, then on again. The correct frame position at the time that the machine was stopped is stored in the machine's memory, and the embroidery frame is returned to the correct position.
- When the embroidery frame is re-attached, make sure that the pins on the left and right arms of the embroidery frame holder securely fit into the holes in the handles on the embroidery frame.

- 4** Go back through the stitching in the same way as that described in step **e** of "If the upper thread breaks" on page 79, and then continue embroidering.

Embroidering From the Beginning or Middle of the Pattern

If you wish to restart embroidering from the beginning, for example, if trial embroidery was sewn and an incorrect thread tension was used or if the wrong thread color was used, restart the embroidering using the forward/backward stitch key. In addition, you can go forward or back through the stitching by thread color or by stitch to start stitching at any position of the pattern.

Note

- Be careful when going back or forward through the stitching since the embroidery frame moves at the same time.

1 Press the start/stop button to stop the machine.

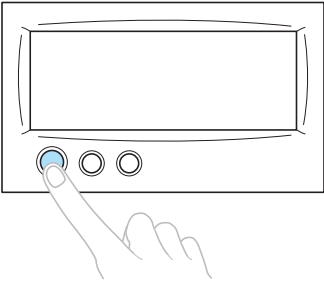

- If necessary, change the fabric framed in the embroidery frame or trim and remove the sewn stitches.

2 Touch **V-/+**.

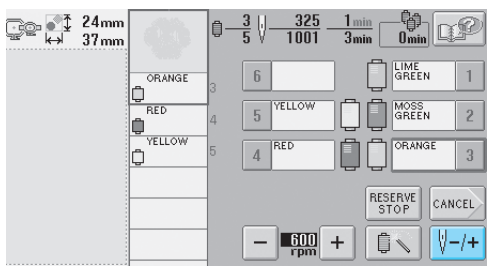

- ▶ The stitch navigating screen appears.

■ To start sewing from the beginning

3 Touch **V 0**.

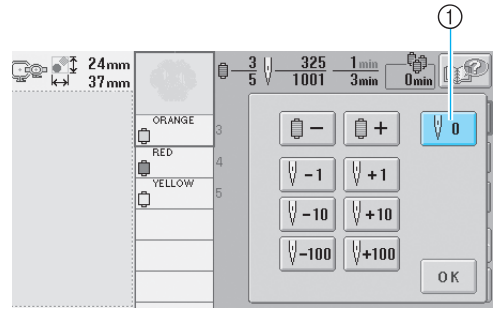

- ① Touch this key to return to the beginning of the first color.
- ▶ The embroidery frame moves to the starting position.

3

- To select the stitch from where embroidering is to begin

- ③ Touch and to select a color in the thread color sequence, and then touch , , , , , and to select the stitch.

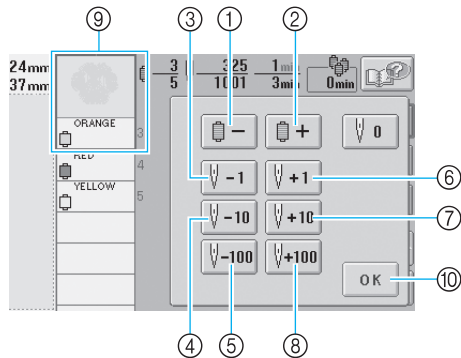

- ① Touch this key once to return to the beginning of the stitching for the color being sewn. Afterward, each touch of this key returns to the beginning of sewing for the previous thread color.
 - ② Each touch of this key advances to the beginning of sewing the next thread color.
 - ③ Each touch of this key moves one stitch back through the stitching.
 - ④ Each touch of this key moves ten stitches back through the stitching.
 - ⑤ Each touch of this key moves one hundred stitches back through the stitching.
 - ⑥ Each touch of this key moves one stitch forward through the stitching.
 - ⑦ Each touch of this key moves ten stitches forward through the stitching.
 - ⑧ Each touch of this key moves one hundred stitches forward through the stitching.
 - ⑨ The thread color at the top of the thread color sequence display is the color of the area currently selected.
 - ⑩ Touch this key to close this screen.
- ▶ The needle bar case moves and the current needle bar moves to the sewing position, and then the embroidery frame moves and current needle position is indicated.

- ④ After selecting the stitch from where embroidering is to begin, touch .

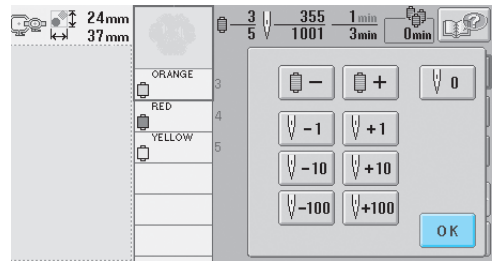

- ▶ The embroidering screen appears again.

- ⑤ Touch , and then press the start/stop button to begin embroidering.

- ▶ Embroidering begins from the specified point.

Resume Embroidering After Turning OFF the Machine

In either of the following cases, the remaining stitches of the embroidery are stored in the machine's memory.

- If the machine's power switch is pressed to turn off after stopping embroidering.
Cut the thread before the machine's main power switch is turned off, otherwise the thread may be pulled or may catch when the carriage returns to its initial position after the machine is turned on again.
- If the machine was accidentally turned off, for example, due to a power outage, while it was embroidering.
The remainder of the embroidery can be sewn when the machine is turned on again; however, some of the stitches that were already sewn may be sewn again.



Note

- Be careful when going back or forward through the stitching since the embroidery frame moves at the same time.

- 1 Set the main power switch to "I" to turn on the machine.

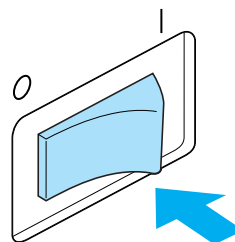

- 2 When the screen shown below appears after the initial screen, touch **OK**.



- ▶ A message appears, asking if you wish to continue embroidering or start a new operation.

3 Touch **OK**.

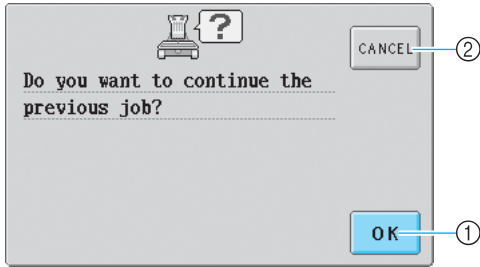

- ① Touch to continue embroidering.
- ② Touch to cancel embroidering and display the pattern type selection screen to select a new pattern.

▶ The embroidering screen displayed before the machine was turned off appears.

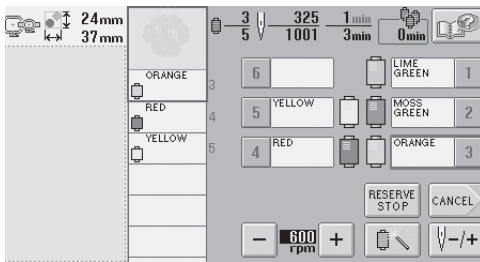

4 Touch **V -/+**.

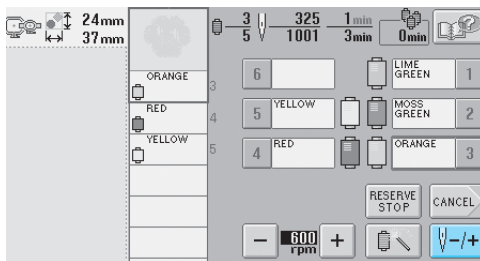

▶ The stitch navigating screen appears.

5 Touch **V -1** two or three times to go back two or three stitches.

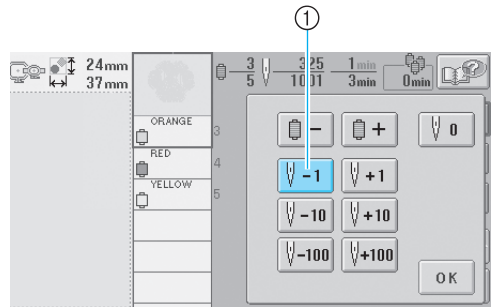

- ① Each touch of this key moves one stitch back through the stitching.
 - Check that the needle drop point is positioned where stitches have already been sewn.

6 Touch **OK**.

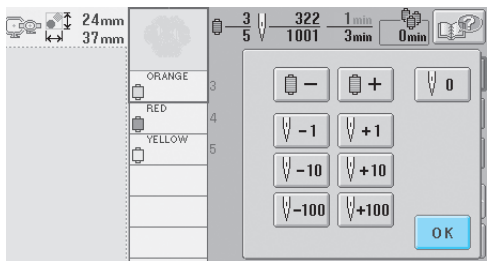

▶ The embroidering screen appears again.

7 Touch **LOCK**, and then press the start/stop button to continue embroidering.

Memo

- The machine can be stopped at any time, even while it is embroidering; however, if the machine is stopped when the thread color is changed, it is not necessary to go back through the stitching when embroidering is continued. The machine can also be set to stop when the thread color is changed. (For details, refer to “Setting the Machine to Stop at Color Changes” on page 92.)

Adjusting the Thread Tension

The following procedure describes how to adjust the thread tension if the correct thread tension as described on page 45 was not used. After adjusting the tension of the bobbin thread, adjust the tension of the upper thread for each needle bar.



Note

- Be sure to check the tension of the bobbin thread each time that the bobbin is changed. Depending on the bobbin thread type and whether a prewound bobbin is used, the tension of the bobbin thread may differ. For example, when replacing an empty prewound bobbin with one of the same type, be sure to check the tension of the bobbin thread and adjust the tension if necessary.
- Be sure to adjust the tension of the bobbin thread before adjusting the tension of the upper thread.

Adjusting the tension of the bobbin thread

- 1 Tie the included weight to the end of the thread extending from the bobbin case.

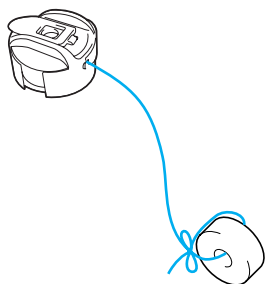

Note

- Different weights are used to adjust prewound bobbins and metal bobbins.
Pre-wound bobbins: Only weight (L)
Metal bobbins: Weight (L) and weight (S)
* Weight (S) is included with the optional bobbin winder.

- 2 As shown in the illustration, hold the bobbin case against a smooth vertical surface.

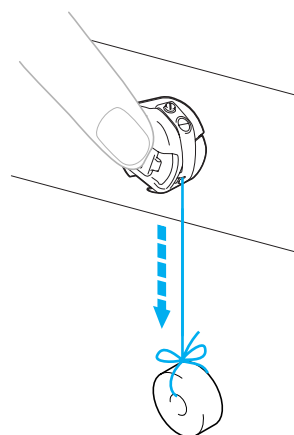

- If the thread with the weight attached is slowly pulled out, the thread tension is correct.

- 3 Use the included standard screwdriver to turn the tension-adjusting screw and adjust the thread tension.

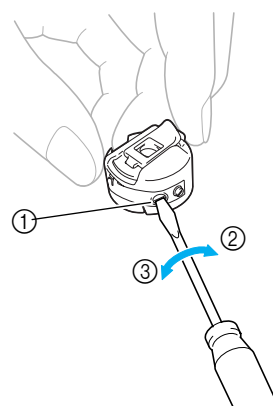

- ① Tension-adjusting screw
- ② Tighter
- ③ Looser

- 4** After making the adjustments, try embroidering with all needle bars to check the thread tension.



Memo

- In the built-in embroidery patterns, one pattern is used for checking the thread tension. By sewing this pattern, the thread tension can easily be checked. For details, refer to page 160.

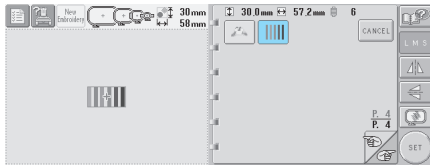

Adjusting the tension of the upper thread

- 1** Turn the thread tension knobs.

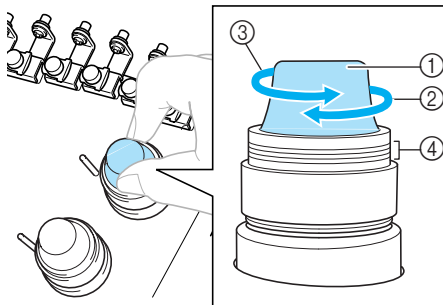

- ① Thread tension knobs
- ② Tighter
- ③ Looser
- ④ Mark

Upper thread is too tight

The tension of the upper thread is too tight, resulting in the bobbin thread being visible from the right side of the fabric.

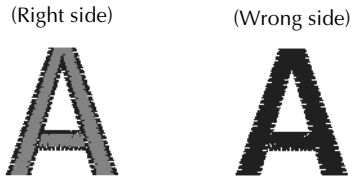

Turn the knob in the direction of the arrow to decrease the tension of the upper thread.

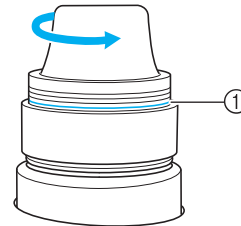

- ① If the red line is visible, the thread tension cannot be decreased any further. Increase the tension of the bobbin thread. For details, refer to page 85.

Note

- If you decrease the thread tension further than the red line, the tension knob may be dis-assembled.

Upper thread is too loose

The tension of the upper thread is too loose, resulting in a loose upper thread, loose thread locks or loops appearing on the right side of the fabric.

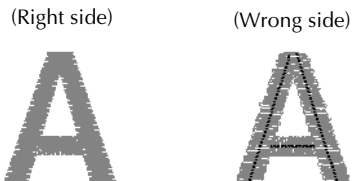

Turn the knob in the direction of the arrow to increase the tension of the bobbin thread.

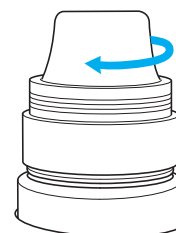

4

EMBROIDERING SETTINGS

This chapter contains descriptions on the various embroidering settings, which make operation easier.

Automatic Lock Stitch Setting	88
Starting/Ending Position Settings	89
Repeatedly sewing a pattern along a diagonal / 90	
Maximum Sewing Speed Setting	91
Setting the Machine to Stop at Color Changes	92
Stopping the machine at the next color change / 92	
Specifying pause locations before embroidering / 92	
Temporary Needle Bar Setting	94
Reserved Needle Bar Settings	96

Automatic Lock Stitch Setting

The machine can be set to automatically sew lock stitches, for example at the beginning of the pattern, before sewing each thread color change, and before trimming the thread.

When the embroidery machine is purchased, this function is set ON.

- **Specifying that lock stitches be sewn at the beginning of the pattern, at the beginning of sewing each thread color change and at the beginning of sewing after the thread trim.**

- 1 Touch so that it changes to . Touch (or) to select the desired setting.

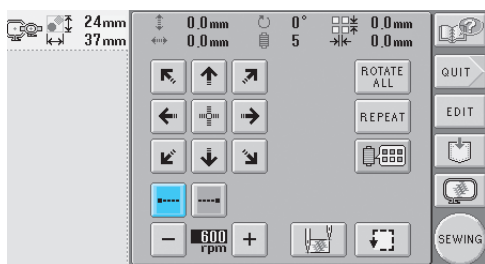

- Each touch of the key turns the setting either on or off.

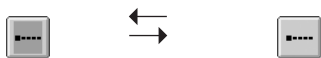

Automatic lock stitch setting turned on

Automatic lock stitch setting turned off

Memo

- If the first stitch length is less than 0.8 mm, the lock stitch won't be inserted.
- If Thread Trimming is set OFF in setting screen, the lock stitch won't be inserted. (See page 149.)

- **Specifying that lock stitches be sewn before the thread is trimmed.**

- 1 Touch so that it changes to . Touch (or) to select the desired setting.

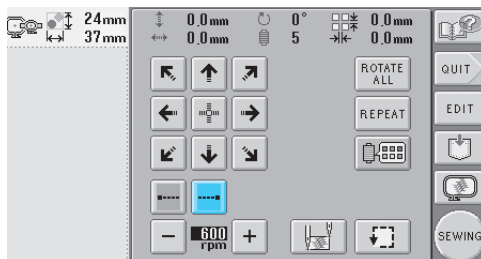

- Each touch of the key turns the setting either on or off.



Automatic lock stitch setting turned on

Automatic lock stitch setting turned off

Memo

- The automatic lock stitch setting stays the same until the key is touched to turn it off. The setting specified before the machine is turned off remains selected the next time that the machine is turned on.
- If Thread Trimming is set OFF in setting screen, the lock stitch won't be inserted. (See page 149.)

Starting/Ending Position Settings

The machine can set the start point and the ending point separately from the 9 points of the pattern. Those are upper-left corner, upper-center, upper-right corner, center-left, center-center, center-right, lower-left corner, lower-center and lower-right corner.

These settings can be used to repeatedly sew a pattern along a diagonal.

The starting/ending position settings are specified from the embroidering settings screen. When the embroidery machine is purchased, both the starting position and the ending positions are set to the center of the pattern.

1 Touch .

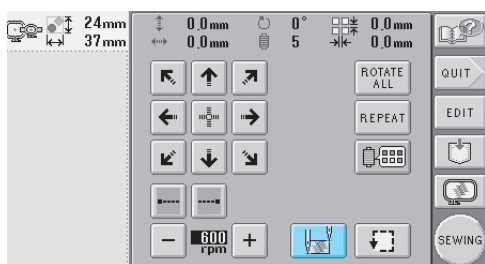

- ▶ The starting/ending position settings screen appears.

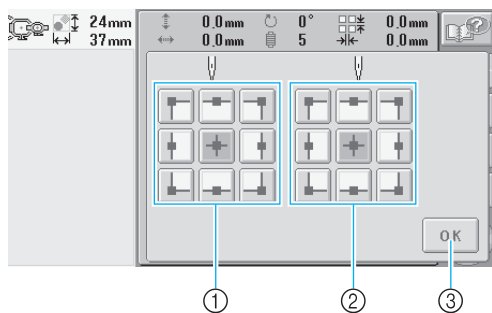

- ① Specifies the starting position
- ② Specifies the ending position
- ③ Touch a key to select the setting.
The highlighted key shows the currently selected setting.

Example

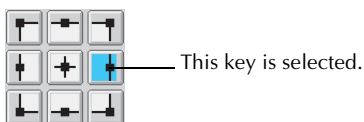

- ③ Touch this key to close this screen.

■ Specifying the starting position

2 Touch the key for the desired starting position setting.

- ▶ When a starting position is selected, the ending position is automatically set to the same position.
- ▶ The embroidery frame moves to the starting position.

■ Specifying the ending position

3 Touch the key for the desired ending position setting.

4 After selecting the desired settings, touch

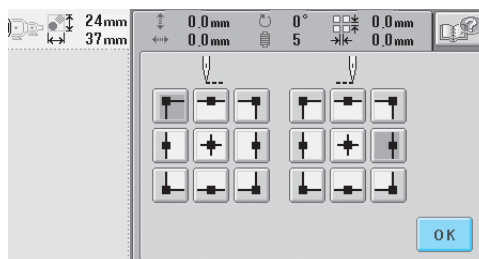

- ▶ The embroidering settings screen appears again.



Memo

- The starting/ending position settings do not change until the key for a new setting is touched. The settings specified before the machine is turned off remain selected the next time that the machine is turned on.

Repeatedly sewing a pattern along a diagonal



Example



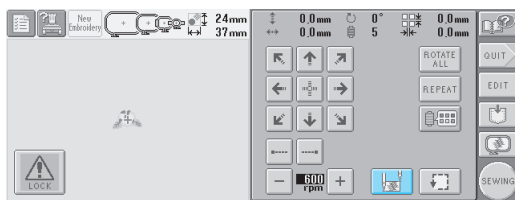

- 1 Specify the upper-left corner as the starting position and the lower-right corner as the ending position.

Touch  in the embroidering settings screen to display the starting/ending position settings screen.



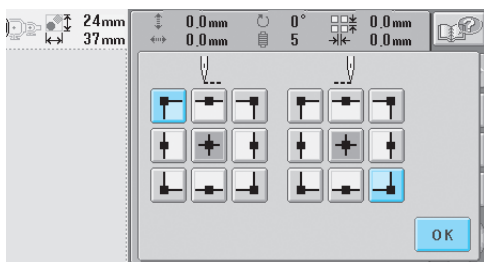

For the starting position, touch  so that it changes to .

For the ending position, touch  so that it changes to .



Touch  to close the starting/ending position settings screen.

- 2 Sew the first embroidery pattern.

Touch  to display the embroidering screen, and then touch  and press the start/stop button.

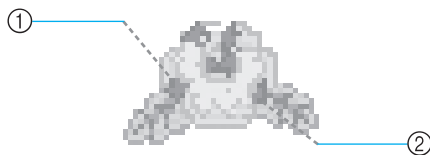

- 1 Starting position
- 2 Ending position

- 3 After embroidering is finished, the machine stops at the lower-left corner of the pattern.

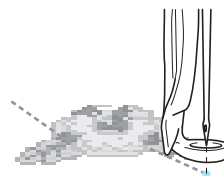

- 4 Repeat steps 2 and 3 three times.

Memo

- If the starting position and ending position settings are changed, instead of sewing the patterns in a fixed direction, various pattern designs are possible.



Maximum Sewing Speed Setting

The maximum sewing speed can be set to one of five levels at every 100 rpm between 600 and 1000 rpm. If the cap frame is used, the maximum sewing speed can be set to one of five levels at every 50 rpm between 400 and 600 rpm.

Maximum sewing speed

Embroidery frame		Cap frame	
1	1000	1	600
2	900	2	550
3	800	3	500
4	700	4	450
5	600	5	400

The maximum sewing speed setting is specified from the embroidering settings screen or the embroidering screen.

When the embroidery machine is purchased, the maximum sewing speed is set to 600 rpm (Cap frame for 400 rpm).

- 1 To increase the sewing speed, touch **+**. To decrease the sewing speed, touch **-**.

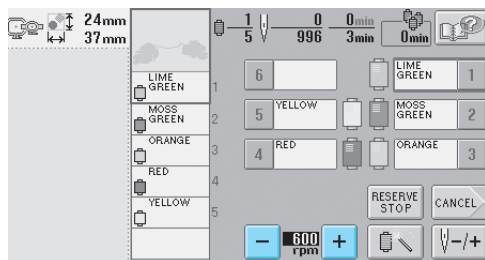
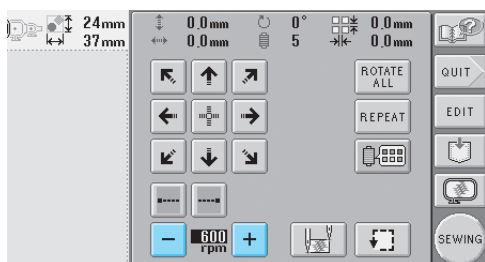

- The value between **-** and **+** changes.

Memo

- Decrease the sewing speed when embroidering on thin, thick or heavy fabrics. In addition, the machine embroiders more quietly at a slower sewing speed.
- The sewing speed can be changed while embroidery is being sewn.
- The maximum sewing speed setting does not change until a new setting is selected. The setting specified before the machine is turned off remains selected the next time that the machine is turned on.
- Decrease the sewing speed to 600 rpm, when using a weak thread like a metallic thread.



Setting the Machine to Stop at Color Changes

The machine can be stopped at any time; however, if the machine is stopped while it is embroidering, it is better to go back a few stitches before continuing sewing to overlap the stitching. If the machine stops at a color change, it is not necessary to go back through the stitching before continuing embroidering.

Stopping the machine at the next color change

The machine can be set to stop before sewing the next color.

- 1 While sewing the color before the point where you wish to stop the machine, touch

 so that it changes to .

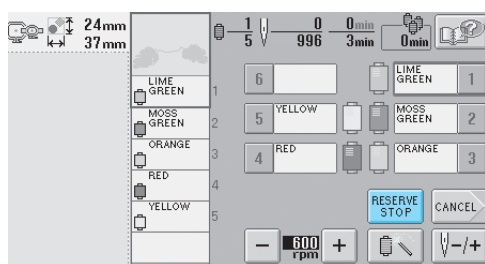

- 2 After finishing sewing the area for the current color, the next needle bar moves into position and the machine stops before sewing the next color.

►  changes back to .

- If the machine is temporarily turned off, you will be asked if you wish to continue sewing or select a new pattern when the machine is turned on again.

Touch  to continue embroidering.

(Refer to “Resume Embroidering After Turning OFF the Machine” on page 83.)



Specifying pause locations before embroidering

Pause locations can be specified in the change thread color screen, displayed by touching .

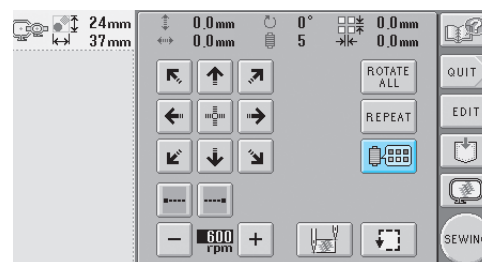
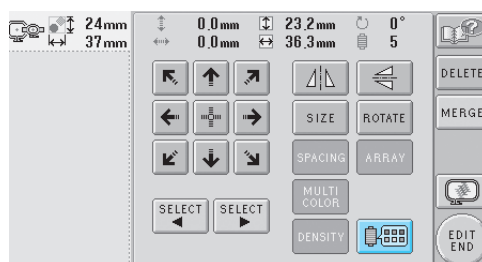

- 1 Touch  in the pattern editing screen or the embroidering settings screen.



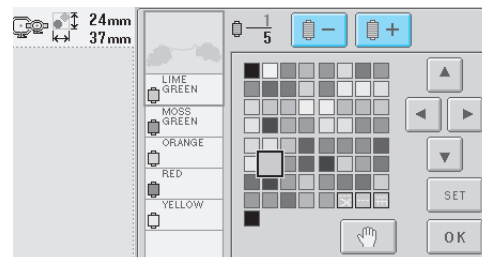

- The change thread color screen appears.

- 2 Touch  and  so that the color at the top of the thread color sequence display is the color where you wish to stop the machine before sewing it.

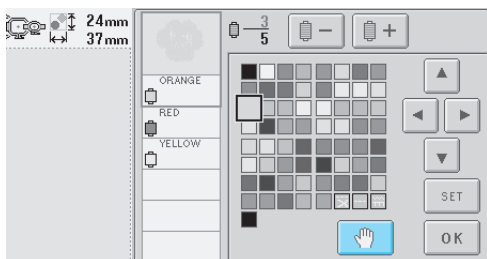

3 Touch  so that it changes to .



► The  mark appears to indicate where the machine will stop.

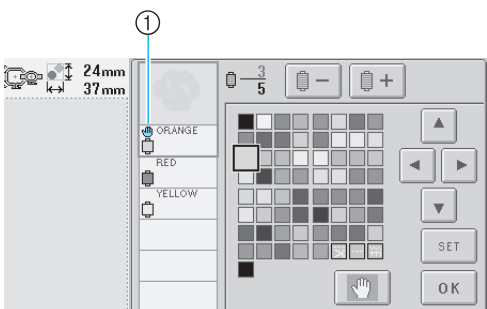



①  mark

4 Repeat steps **2** and **3** for each pause that you wish to specify.

- Any number of pauses can be specified.

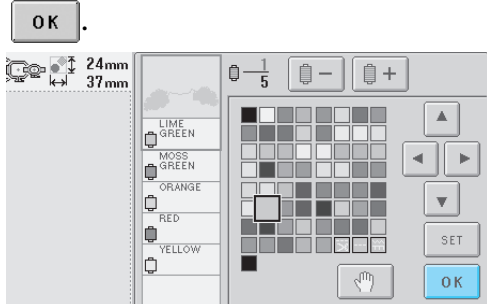
5 After specifying the desired settings, touch



► The screen that was displayed before  was touched appears.

- If the machine is temporarily turned off when it is stopped at the specified location after embroidering, you will be asked if you wish to continue sewing or select a new pattern when the machine is turned on again.

Touch  to continue embroidering. (Refer to “Resume Embroidering After Turning OFF the Machine” on page 83.)

Memo

- If the machine is temporarily turned off, the settings to stop the machine at color changes specified before the machine was turned off are not cancelled. However, the settings are cancelled if a new pattern is selected.
- If a pattern with the settings to stop the machine at color changes is saved, the settings to stop the machine at color changes are also saved.

Temporary Needle Bar Setting

After embroidering begins, the machine can be stopped at a color change and a different needle bar can be specified for the next color to be sewn.

By substituting upper thread already threaded on a different needle bar, the time for sewing can be saved. For example, similar color thread can be substituted for temporary use.

- 1** While sewing the color before the one that you wish to change, touch **RESERVE STOP** so that it changes to **RESERVE STOP**.

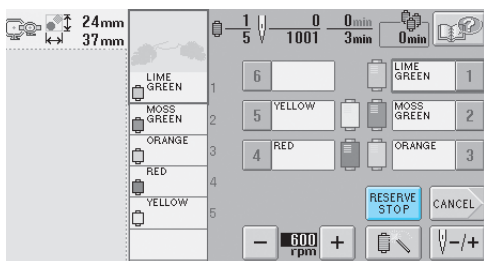

- ▶ After the color currently being sewn is finished, the threads are trimmed and the machine stops.
- The start/stop button can be pressed at the color change to stop the machine, but, in that case, stop the machine after the threads are trimmed.

- 2** Touch .

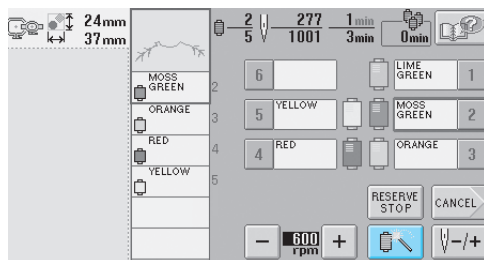

- ▶ The temporary needle bar setting screen appears.

- 3** Touch the key for the needle bar threaded with the thread that you wish to embroider with.

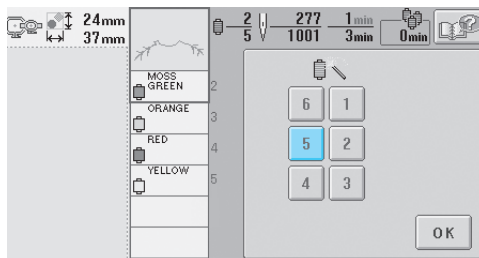

- 4** Touch **OK**.

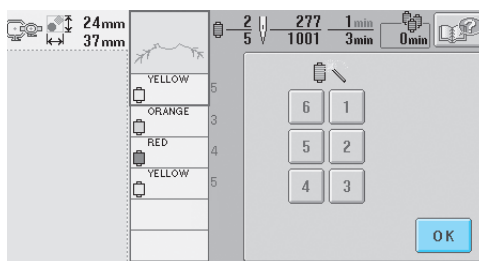

- ▶ The embroidering screen appears again.

- 5** Touch , and then press the start/stop button to begin embroidering.

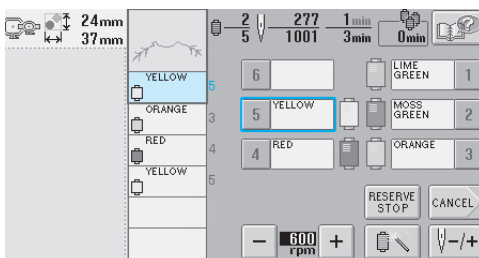

- ▶ Embroidering continues with the specified needle bar.



Memo



- The thread color (needle bar) change specified as described above only applies until the next color change. If the pattern contains another area with the same color or when the same pattern is sewn the next time, the area is sewn with the original color.
 - The thread color (needle bar) can be changed with this procedure even when the machine has been stopped with a specified pause or at the time of spool change.
 - If the start/stop button was pressed to stop the machine while an area was being sewn, a temporary needle bar setting cannot be applied. The thread color (needle bar) cannot be changed in the middle of an area that is being sewn.
-

Reserved Needle Bar Settings

Normally, the machine automatically assigns thread colors to the needle bars; however, a specific thread color can be manually assigned to a certain needle bar. If a needle bar is specified, that needle bar is removed from the machine's automatic assignments and the specified color remains assigned to it.

By specifically assigning often used thread colors to certain needle bars, the trouble of changing the thread spools can be reduced.

Once a manual needle bar setting is specified, it remains applied until the setting is cancelled. The manual needle bar settings can be specified in the third page of the settings screen.

- 1** Touch , and then touch  and  to display the third page of the settings screen.

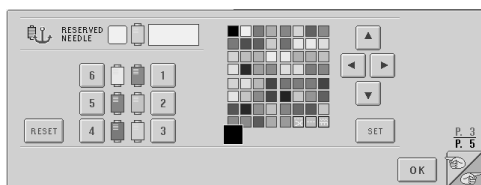



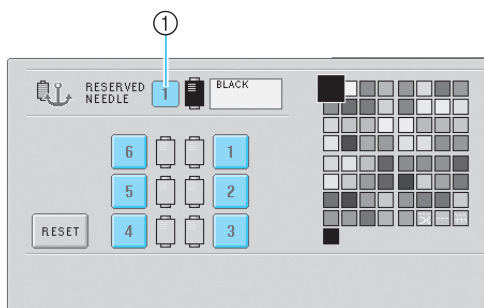

- 2** Touch **1**, **2**, **3**, **4**, **5** or **6** for the number of the needle bar that you wish to specify.



- ① Indicates the number of the selected needle bar

- 3** Select the color to be assigned to the needle bar.

Touch , ,  and  until the color that you wish to select from the thread table appears enlarged.

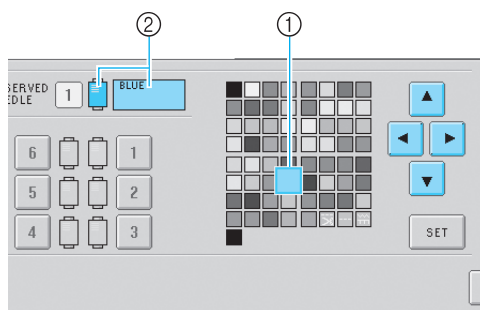

- ① The color that appears enlarged is the color that is selected.
 ② Displays the color that is selected and its name
 ► Highlighting a color square moves in the direction of the arrow on the key that is touched.

- 4** Touch **SET**.

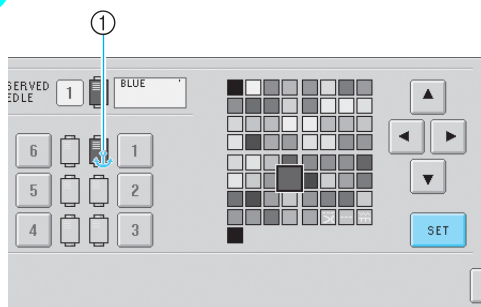

- The color selected in step **3** is specified.
 ① The selected color of thread and the anchor appear on the spool.

■ Cancelling the setting

To change the setting, first cancel it, and then select the new setting.

- 1 Touch **1**, **2**, **3**, **4**, **5** or **6** for the number of the needle bar whose setting you wish to cancel.

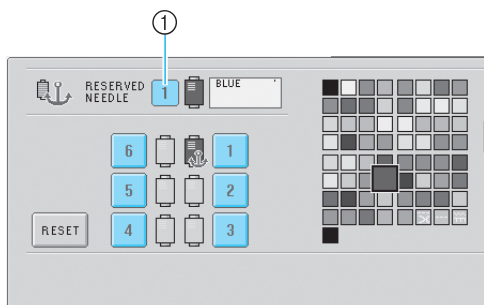

- 1 Indicates the number of the selected needle bar

- 2 Touch **RESET**.

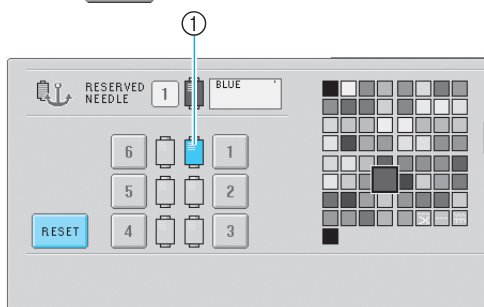

- 1 The anchor disappears from the thread spool.
▶ This cancels the manual needle bar setting.

SELECTING/EDITING/SAVING PATTERNS

This chapter provides details on selecting, editing and saving embroidery patterns.

Embroidery Data Precautions	100
Selecting an Embroidery Pattern	102
General pattern selection / 102	Embroidery patterns / 104
Renaissance Alphabet Patterns / 105	Floral alphabet patterns / 106
Appliqué alphabet / 107	Frame patterns / 108
Alphabet patterns / 109	Embroidery patterns stored in the machine / 111
Embroidery cards (optional) / 112	Computer (USB) / 114
USB media (Commercially Available) / 117	
Editing the Embroidery Pattern (Pattern Editing Screen)	119
Combining patterns / 119	Selecting the pattern to be edited / 120
Moving a pattern / 120	Flipping a pattern horizontally / 121
Flipping a pattern vertically / 121	Changing the size of a pattern / 121
Rotating a pattern / 122	Changing the text arrangement of a character / 123
Changing the character spacing / 124	
Changing the thread density (only for some character and frame patterns) / 125	
Specifying multi-color text / 126	Changing the colors of the pattern / 127
Deleting a pattern / 128	
Editing the Embroidery Pattern (Embroidering Settings Screen)	129
Rotating the entire pattern / 129	Creating a repeating pattern / 130
Changing the colors of the pattern / 131	
Editing a Combined Pattern	132
Saving Embroidery Patterns	136
Machine's Memory / 136	
If the Embroidery Pattern Cannot Be Saved / 136	
USB Media (Commercially Available) / 137	

Embroidery Data Precautions

Observe the following precautions when using embroidery data other than that created and saved in this machine.

CAUTION

- **While using embroidery data other than our original patterns, the thread or needle may break when sewing with a stitch density that is too fine or when sewing three or more overlapping stitches. In that case, use one of our original data design systems to edit the embroidery data.**

■ Types of embroidery data that can be used

- Only .pes, .phc and .dst embroidery data files can be used with this machine. Using pattern data other than those saved using our data design systems or sewing machines may cause the embroidery machine to malfunction.

■ Types of USB Devices/Media that can be Used (through USB Type “A” (host) connector)

Stitch data can be saved to or recalled from USB media. Use media that meets the following specifications.

- USB Floppy disk drive
- USB Flash drive (USB Flash memory).
- USB CD-ROM, CD-R, CD-RW drives (recalling only)



Memo

- Stitch/embroidery data cannot be saved using a USB CD-ROM, CD-R or CD-RW drive.
- USB devices/media can be used only through USB Type “A” (host) connector. USB Type “B” (function) connector is only for a computer connection.

You can also use the following types of media with the USB Memory Card Reader/Writer.

- Secure Digital (SD) Card
- CompactFlash
- Memory Stick
- Smart Media
- Multi Media Card (MMC)
- XD-Picture Card



Note

- Some USB media may not be usable with this machine. Please visit our website for more details.
- USB hubs cannot be used through USB Type “A” (host) connector. The machine will not recognize the above USB devices or USB memory cards through a USB hub.
- The access lamp will begin blinking after inserting USB Devices/Media, and it will take about 5 to 6 seconds to recognize the Devices/Media. (Time will differ depending on the USB Device/Media).
- Only insert or remove USB media while  appears in the display, or when prompted to change media by a message on the display (see page 117).
- For additional information, refer to the instruction manual included with the USB media that you have purchased.



Memo

- When a file folder is necessary to create, use a computer.
- Letters and numerals can be used in the file names. In addition, if the file name contains no more than eight characters, the entire file name will appear on the screen.
If the file name is more than eight characters long, only the first six characters followed by “~” and a number appear as the file name.

■ Computers and Operating Systems with the Following Specifications can be Used

- Compatible models:
IBM PC with a USB port as standard equipment
IBM PC-compatible computer equipped with a USB port as standard equipment
- Compatible operating systems:
Microsoft Windows Me/2000/XP
(Windows 98 requires a driver. Download the driver from our Web site (www.brother.com)).

■ Precautions on using the computer to create data

- If the name of embroidery data file/folder cannot be identified, for example, because the name contains special characters or symbols, the file/folder is not displayed. If this occurs, change the name of the file/folder. It is recommended to use the upper and lower case letters, the numbers 0 through 9, the dash "-", and the underline "_". Do not use comma ",", or period "." in the file name.

- If embroidery data larger than 200 mm (H) × 300 mm (W) (approx. 7-7/8 inches (H) × 11-3/4 inches (W)) is selected, a message is shown at the right asking if you wish to rotate the pattern 90 degrees.

Even after being rotated 90 degrees, embroidery data larger than 200 mm (H) × 300 mm (W) (approx. 7-7/8 inches (H) × 11-3/4 inches (W)) cannot be used. (All designs must be within the 200mm(H) × 300mm(W) (approx. 7-7/8 inches (H) × 11-3/4 inches (W)) design field size.)

For more details, refer to page 113.

- .pes files saved with the number of stitches or the number of colors exceeding the specified limits cannot be displayed. Use one of our original data design systems to edit the embroidery pattern so that it meets the specifications (maximum number of stitches: 500,000 stitches; maximum number of color changes: 500; maximum number of combined patterns: 100).
- Do not create folders in USB media or Removable disk. If embroidery data is stored in a folder, that embroidery data cannot be displayed by the embroidery machine.
- Even if the embroidery unit is not attached, the machine will manage embroidery data.

■ Tajima (.dst) embroidery data

- .dst data is displayed in the pattern list screen by their file names. (The actual image cannot be displayed.) Only the first eight characters of the file name can be displayed.
- Since Tajima (.dst) data does not contain specific thread color information, it is displayed with our default thread color sequence. Check the preview and change the thread colors as desired. For more details, refer to page 163.



■ Trademarks

- Secure Digital (SD) Card is a registered trademark or a trademark of SD Card Association.
 - CompactFlash is a registered trademark or a trademark of Sandisk Corporation.
 - Memory Stick is a registered trademark or a trademark of Sony Corporation.
 - Smart Media is a registered trademark or a trademark of Toshiba Corporation.
 - Multi Media Card (MMC) is a registered trademark or a trademark of Infineon Technologies AG.
 - xD-Picture Card is a registered trademark or a trademark of Fuji Photo Film Co. Ltd.
 - IBM is a registered trademark or a trademark of International Business Machines Corporation.
 - Microsoft and Windows are registered trademarks or trademarks of Microsoft Corporation.
- Each company whose software title is mentioned in this manual has a Software License Agreement specific to its proprietary programs.
All other brands and product names mentioned in this manual are registered trademarks of their respective companies. However, the explanations for markings such as ® and ™ are not clearly described within the text.

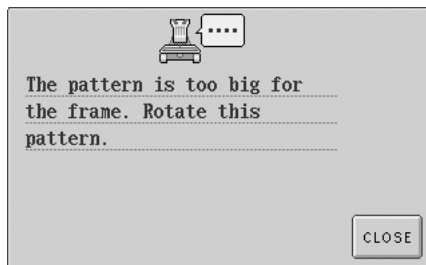

Selecting an Embroidery Pattern

Various embroidery patterns are built into this machine. Other than the built-in patterns, various other patterns can be selected from embroidery cards (sold separately) and from the computer.



Memo

- Please refer to page 5 for a list of compatible cards.

General pattern selection

The procedure for selecting a pattern differs depending on the type of pattern; however, the general procedure for selecting a pattern is described below.

- In the pattern type selection screen, touch the key for the desired category.**

Pattern type selection screen

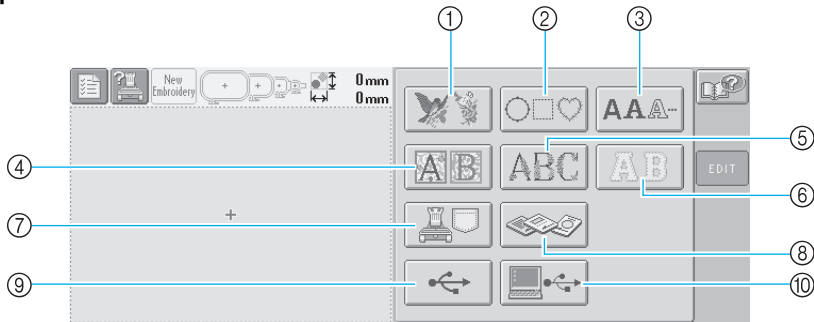

- | | |
|---------------------------------|---|
| ① Embroidery patterns | ⑥ Appliqué alphabet patterns |
| ② Frame patterns | ⑦ Embroidery patterns stored in the machine |
| ③ Alphabet patterns | ⑧ Embroidery cards |
| ④ Renaissance alphabet patterns | ⑨ USB media |
| ⑤ Floral alphabet patterns | ⑩ Computer (USB) |

- In the pattern list screen, which appears next, touch the desired pattern to select it.**

Pattern list screen

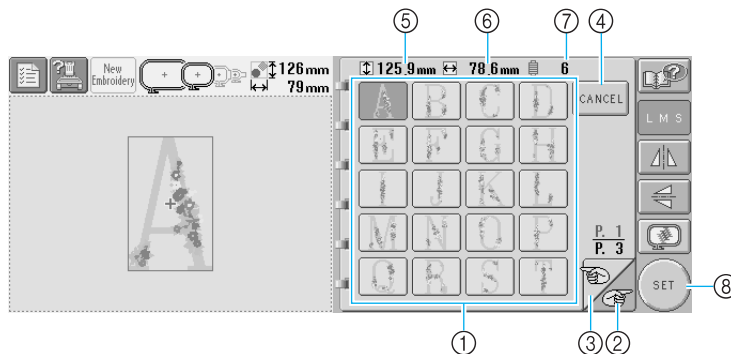

- ① Pattern keys
- Touch a pattern to display the following information of the pattern.
 - ⑤ Vertical length of the pattern
 - ⑥ Horizontal width of the pattern
 - ⑦ Number of thread color changes
- If there is more than one page, touch ② and ③ until the desired page is displayed.

- To change the category, touch CANCEL ④ to return to the pattern type selection screen.
- After selecting the pattern, touch SET ⑧. The selection of the pattern is confirmed and the pattern editing screen appears.

3 When a pattern is selected, the following keys at the right side of the screen allow you to edit the pattern.

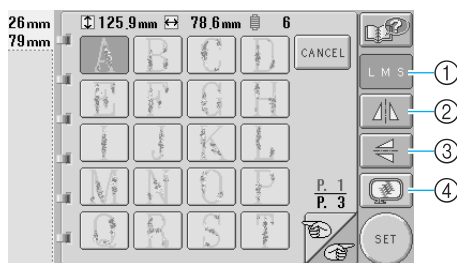

① Changing the size of the pattern

- Each touch of the key changes the setting as shown below.

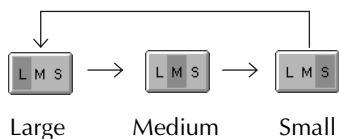

- If the key appears as , the size of the pattern cannot be changed.

② Flipping the pattern horizontally

- Each touch of the key turns the setting either on or off.

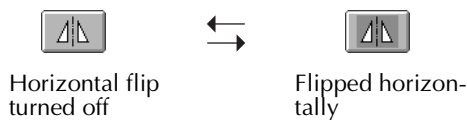

- If the key appears as , the pattern cannot be flipped horizontally.

③ Flipping the pattern vertically

- Each touch of the key turns the setting either on or off.

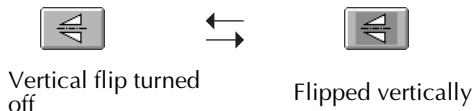

- If the key appears as , the pattern cannot be flipped vertically.

④ Checking the preview image

- Touch this key to check that the embroidery will be sewn as desired. (For details, refer to page 27.)

Embroidery patterns

1 Touch .

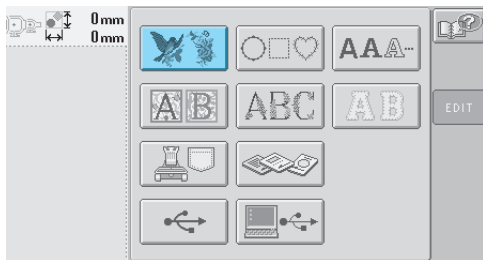

► The list of embroidery patterns appears.

2 **Select an embroidery pattern.**
Touch the desired pattern.

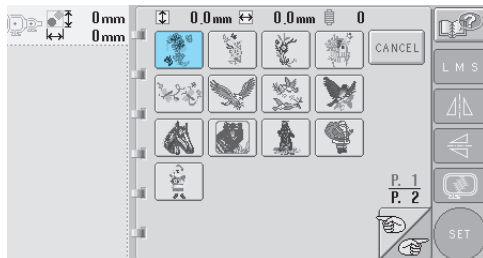

► The selected pattern appears in the pattern display area.

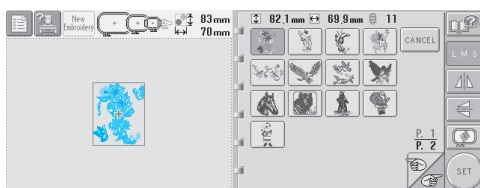

- If the wrong pattern was selected or you wish to select a different pattern, touch the desired pattern.

3 If necessary, edit the pattern.

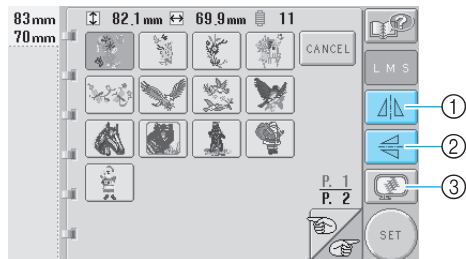

- ① The pattern can be flipped horizontally.
- ② The pattern can be flipped vertically.
- ③ Checks the preview image.

4 Touch .

This confirms the pattern selection.

► The pattern editing screen appears.

Renaissance Alphabet Patterns

1 Touch .

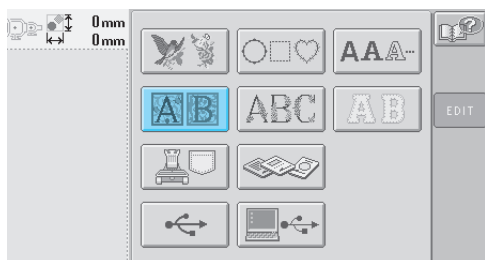

- ▶ The list of renaissance alphabet patterns appears.

2 **Select an embroidery pattern.**
Touch the desired pattern.

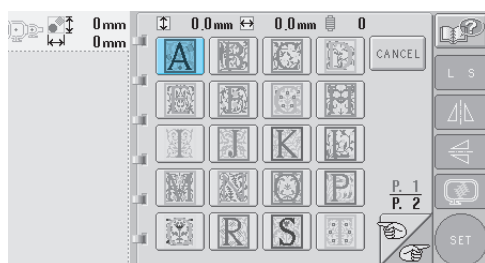

- ▶ The selected pattern appears in the pattern display area.

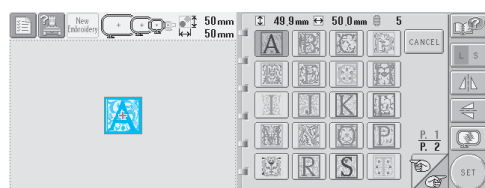

- If the wrong pattern was selected or you wish to select a different pattern, touch the desired pattern.

3 If necessary, edit the pattern.

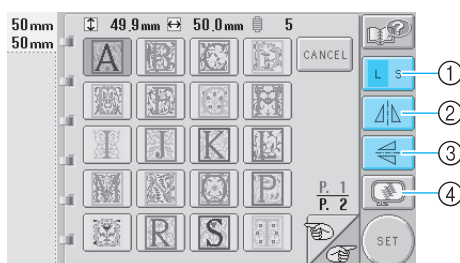

- ① Touch this key to change the size.
- ② The pattern can be flipped horizontally.
- ③ The pattern can be flipped vertically.
- ④ Checks the preview image.

4 Touch .

- This confirms the pattern selection.
- ▶ The pattern editing screen appears.

Floral alphabet patterns

1 Touch .

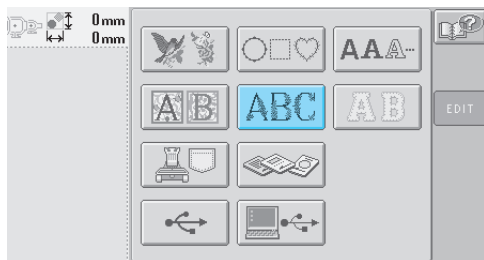

► The list of floral alphabet patterns appears.

2 Select an embroidery pattern.
Touch the desired pattern.

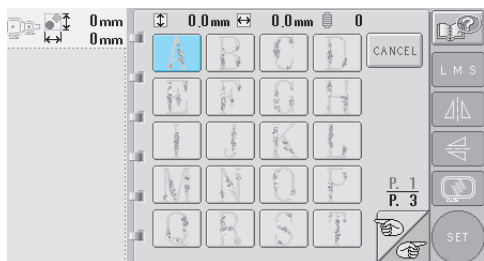

► The selected pattern appears in the pattern display area.

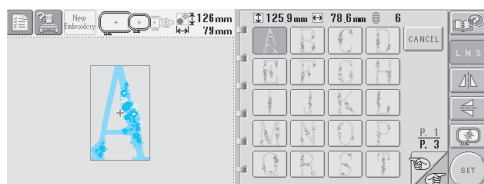

- If the wrong pattern was selected or you wish to select a different pattern, touch the desired pattern.

3 If necessary, edit the pattern.

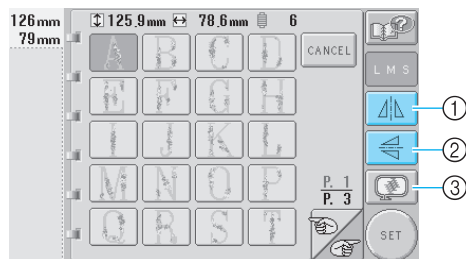

- ① The pattern can be flipped horizontally.
- ② The pattern can be flipped vertically.
- ③ Checks the preview image.

4 Touch .

This confirms the pattern selection.

► The pattern editing screen appears.

Appliqué alphabet

1 Touch .

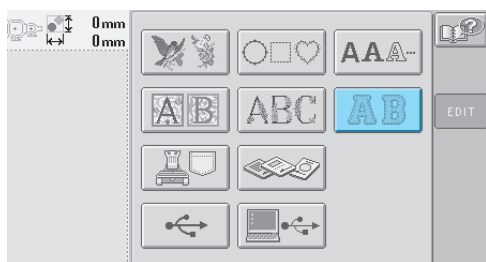

▶ The size selection screen appears.

2 Select the text size.
Touch the key for the desired text size.

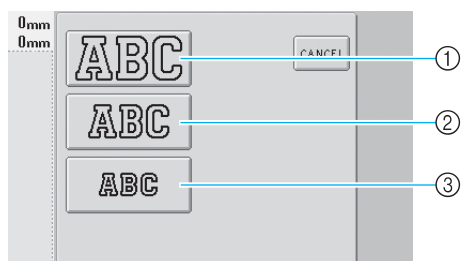

• The character will have the following vertical length when the corresponding size is selected.

- ① Large: 122mm (4-13/16 inches)
- ② Medium: 68mm (2-11/16 inches)
- ③ Small: 49mm (1-15/16 inches)

▶ The list of appliqué alphabet patterns appears.

3 Select an embroidery pattern.
Touch the desired pattern.

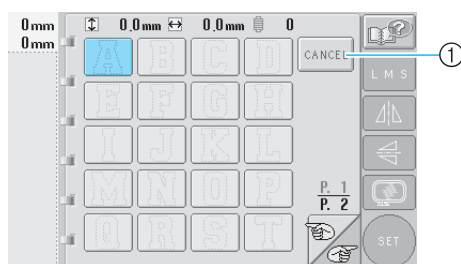

① Touch this button to change the character size.

▶ The selected pattern appears in the pattern display area.

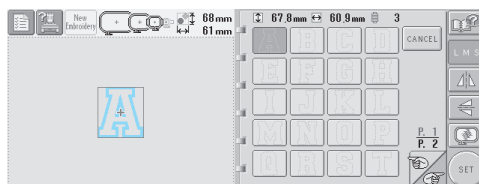

• If the wrong pattern was selected or you wish to select a different pattern, touch the desired pattern.

4 If necessary, edit the pattern.

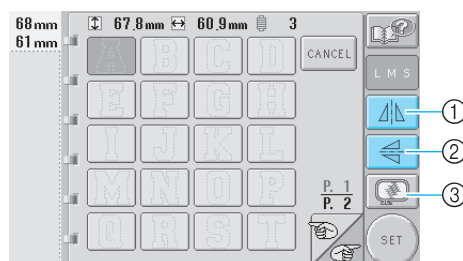

- ① The pattern can be flipped horizontally.
- ② The pattern can be flipped vertically.
- ③ Checks the preview image.

5 Touch .

This confirms the pattern selection.

▶ The pattern editing screen appears.

Memo

- For details on sewing appliqués, refer to “Sewing appliqué patterns” on page 156.

Frame patterns

1 Touch .

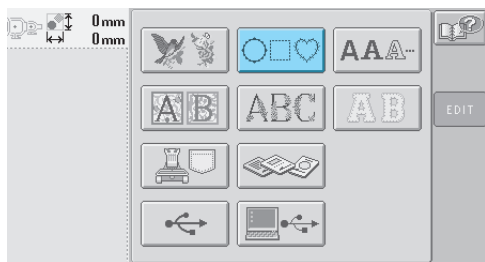

▶ The list of frame patterns appears.

2 In the upper half of the screen, select the desired shape for the frame.
Touch the desired frame shape.

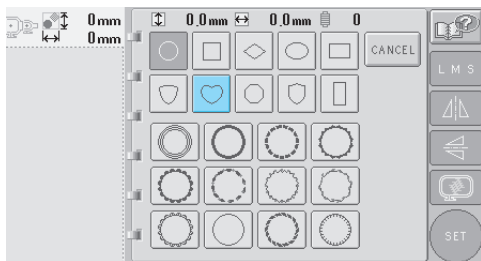

▶ The available frame patterns appear in the lower half of the screen.

3 Select a frame pattern.
Touch the desired pattern.

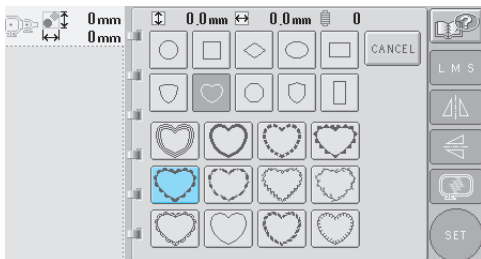

▶ The selected pattern appears in the pattern display area.

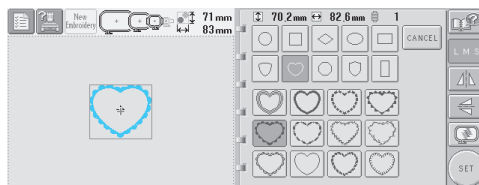

• If the wrong pattern was selected or you wish to select a different pattern, touch the desired pattern.

4 If necessary, edit the pattern.

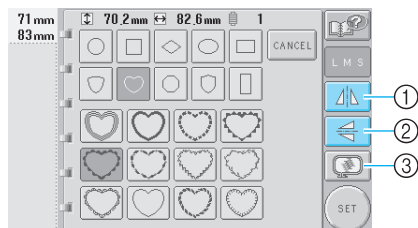

- ① The pattern can be flipped horizontally.
- ② The pattern can be flipped vertically.
- ③ Checks the preview image.

5 Touch .

This confirms the pattern selection.

▶ The pattern editing screen appears.

Alphabet patterns

There are 13 built-in character fonts.

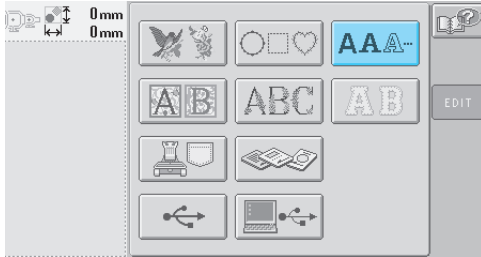

1 Touch **AAA...**.

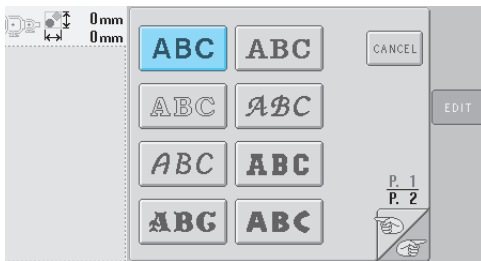

► The font selection screen appears.

2 Select a character font.
Touch the desired character font.



• Touch  or  for additional selections.

► The text input screen appears.

3 If the key for the character that you wish to select is not displayed, touch the tab for the desired set of characters.

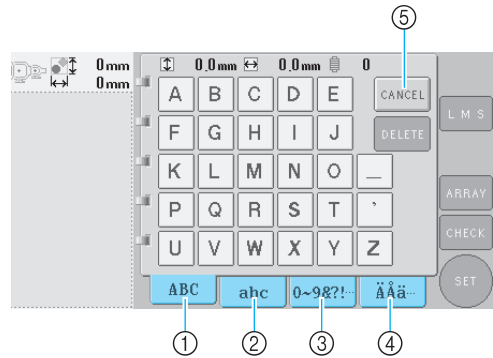

- ① Uppercase letters
- ② Lowercase letters
- ③ Numbers/symbols
- ④ Accented characters
- ⑤ Touch this key to change the character font.

► The text input screen for the characters shown on the tab appears.

• To change the character font, touch  to return to the font selection screen.

4 Select a character.
Touch the desired character.

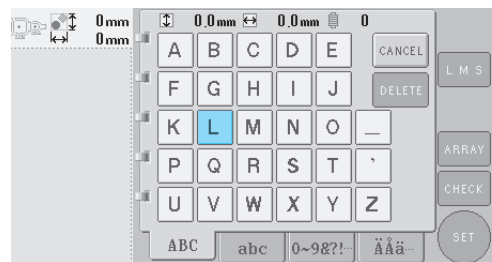

► The selected character appears in the pattern display area.



① If the wrong character was selected or you wish to select a different character, touch  to delete the last character selected, and then touch the key for the new character.

5 With one character entered, if necessary, change the size of the character.



① Touch this key to change the size.

■ Changing the size

After selecting the first character, touch **L M S** until the character is the desired size.

- The next characters that are selected will have the new character size.
- The character size of all entered characters cannot be changed after the characters are combined. (The size of the entire pattern can be changed from the pattern editing screen.)



Note

- Size of the two small fonts **ABCDE** and **abcde** cannot be changed.

6 To enter multiple characters, repeat steps 3 and 4 until all desired characters are entered.

- ▶ The selected characters appear in the pattern display area.



- ① If the wrong character was selected or you wish to select a different character, touch **DELETE** to delete the last character selected, and then touch the key for the desired character. Each touch of **DELETE** deletes the last character of the text.

- If the text is small and difficult to read on the screen, touch **CHECK** to check the text.



- ① Touch this key to display the text preview screen.



- After checking the text, touch **CLOSE** to return to the text input screen.

7 If necessary, change the text arrangement.



- ① Touch this key to change the text arrangement.

■ Changing the text arrangement

Touch **ARRAY** to display the screen shown below.
 Touch the key for the desired text arrangement.
 After selecting the desired text arrangement,
 touch **OK** to return to the text input screen.

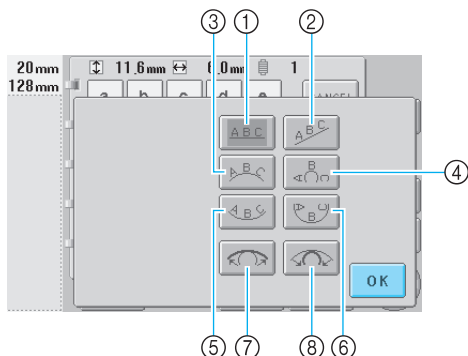

- ① Arranges the text on a straight line
 - ② Arranges the text on a slanted line
 - ③ Arranges the text on the outside of a wide curve
 - ④ Arranges the text on the outside of a sharp curve
 - ⑤ Arranges the text on the inside of a wide curve
 - ⑥ Arranges the text on the inside of a sharp curve
 - ⑦ If text is arranged on a curve, each touch of this key decreases the bend of the curve (makes it flatter).
 - ⑧ If text is arranged on a curve, each touch of this key increases the bend of the curve (makes it more curved).
- If the text is arranged using one of the text arrangements on this screen, even more characters can be entered.

8 After entering all of the text as desired, touch



This confirms the pattern selection.

- ▶ The pattern editing screen appears.



Memo

- The color of the text is set to black. To change the color, refer to “Specifying multi-color text” on page 126 and “Changing the colors of the pattern” on page 127.

Embroidery patterns stored in the machine

Embroidery patterns stored in the machine can be recalled. For details on storing a pattern, refer to “Saving Embroidery Patterns” on page 136.

1 Touch .

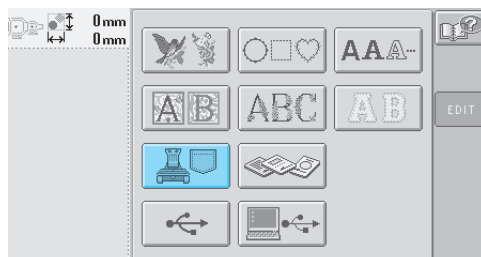

- ▶ The list of patterns appears.

2 Select an embroidery pattern. Touch the desired pattern.

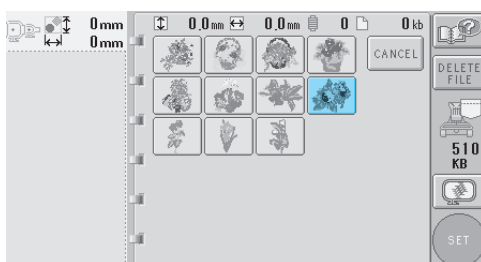

- ▶ The selected pattern appears in the pattern display area.

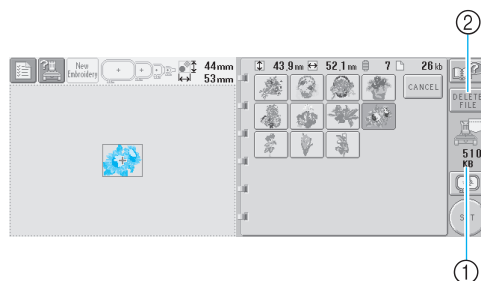

- ① Shows the amount of free space in the machine's memory.
- ② Touch this key to delete the selected pattern from the memory.
 - If the wrong pattern was selected or you wish to select a different pattern, touch the key for the desired pattern.

■ Deleting embroidery data

From this screen, the embroidery data stored in the machine's memory can be organized by deleting unnecessary data. After selecting the pattern that you wish to delete, touch  to display the screen shown below.

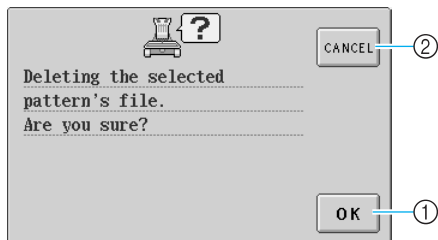

- ① Permanently deletes the data from the memory, then returns to the data with no pattern selected.
- ② Does not delete the data, then returns to the screen before  was touched.

3 Touch .

This confirms the pattern selection.

- ▶ The pattern editing screen appears.

Embroidery cards (optional)

1 Insert the embroidery card into the machine's embroidery card slot.

With the side of the embroidery card marked with an arrow facing toward you, fully insert the card into the embroidery card slot on the right side of the operation panel.

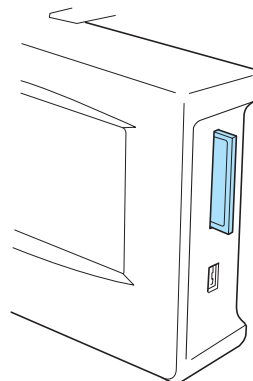

Note

- Only insert or remove embroidery cards while  appears in the display or while the embroidery machine is turned off.
- Make sure that the embroidery card is inserted with the side marked with the arrow facing toward you, do not insert the card with extreme force, and do not insert any object other than embroidery cards into the slot, otherwise the machine may be damaged.
- If an embroidery card other than our original embroidery cards are used, the embroidery machine may not operate correctly. Be sure to use only recommended embroidery cards.
- Some licensed or copyright cards may not be compatible with this embroidery machine.
- Please refer to page 5 for a list of compatible cards.

2 Touch .

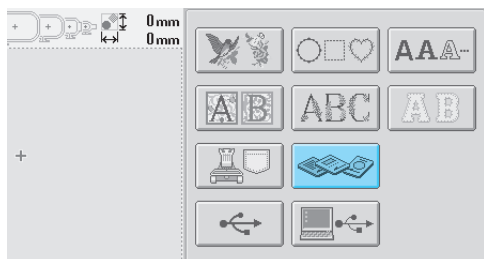



- ▶ The list of patterns on the embroidery card appears.

3 Select the pattern as described on page 104 to 111.

■ With patterns larger than 200 mm(H) × 300 mm(W) (7-7/8 inches (H) × 11-3/4 inches (W))

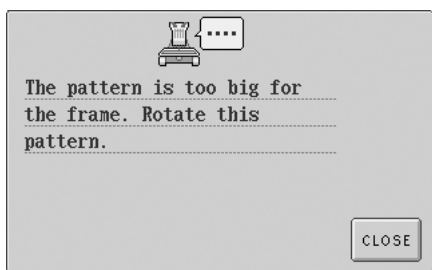
When a pattern larger than 200 mm(H) × 300 mm(W) (7-7/8 inches (H) × 11-3/4 inches (W)) is selected, the following message appears.



Touch  to rotate the pattern 90 degrees before opening it.

If the data is larger than 200 mm(H) × 300 mm(W) (7-7/8 inches (H) × 11-3/4 inches (W)) even after it is rotated 90 degrees, the following message appears.

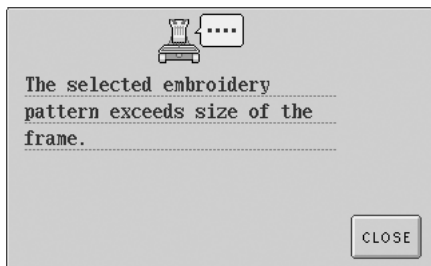

Touch  to return to the pattern list screen.

Memo

- Perform the same operation when a pattern larger than 200 mm(H) × 300 mm(W) (7-7/8 inches (H) × 11-3/4 inches (W)) is selected, whether from the computer or USB media.

Computer (USB)

Using the included USB cable, the embroidery machine can be connected to your computer, and the embroidery patterns saved on the computer can be temporarily recalled and used from the machine.



Note

Check that the computer to be connected meets the following operating conditions.

- Compatible models:
 - IBM-PC with a USB port as standard equipment
 - IBM-PC-compatible computer equipped with a USB port as standard equipment
 - Compatible operating systems:
 - Microsoft Windows Me/2000/XP
- * Windows 98 SE requires a driver. Download the driver from our Web site (www.brother.com).

■ Connecting

- 1 Plug the USB cable connector into the corresponding connectors on the computer and the USB Type “B” (function) port connector on the embroidery machine.

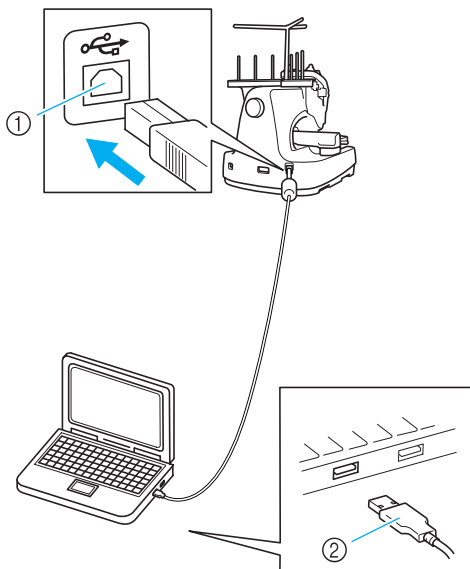

- ① USB Type “B” (function) connector
 - ② USB cable connector
- The USB cable can be plugged into the USB connectors on the computer and embroidery machine whether or not they are turned on.



Note

- The connectors on the USB cable can only be inserted into a connector in one direction. If it is difficult to insert the connector, do not insert it with force and check the orientation of the connector.
- For details on the position of the USB port on the computer (or USB hub), refer to the instruction manual for the corresponding equipment.
- Connection through a USB hub may not be possible, depending on the operating environment. If a connection is not possible, connect the cable to the USB port of the computer.

- 2 After the “Removable Disk” folder appears in the “My Computer” folder on the computer, the connection is completed.

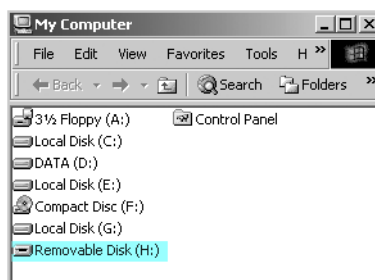

■ Recalling

- 1 Move/copy the pattern data that you wish to recall into the “Removable Disk” folder.

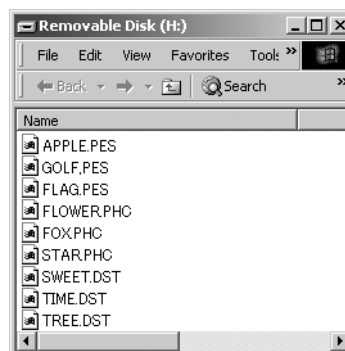

- ▶ Pattern data in the “Removable Disk” folder is written to the machine.



Note

- While data is being written, do not disconnect the USB cable.
- Do not create folders within the "Removable Disk" folder. Even if folders have been created, they will not appear in the machine's screen.
- While the machine is sewing, do not write data to or delete data from "Removable Disk".

2 Touch .

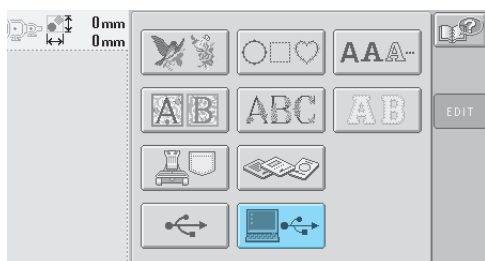

- ▶ The list of patterns is displayed.

3 Select an embroidery pattern.

Touch the desired pattern.

- If you decide not to recall the pattern, press

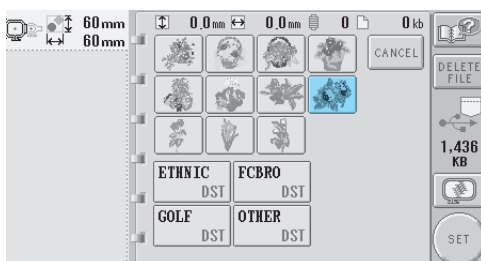

- ▶ The selected pattern appears in the pattern display area.

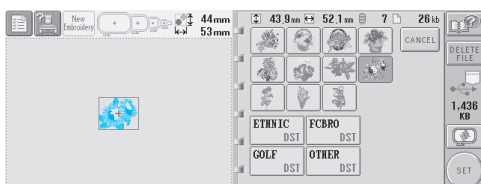

- If the wrong pattern was selected or you wish to select a different pattern, touch the desired pattern.



Memo

- For details on large-size embroidery patterns, refer to PE-DESIGN instruction Manual.
- To add a pattern from the computer, repeat step 1.
- ▶ The following screen appears while data is written to the embroidery machine, and the key for that pattern appears when writing is finished.

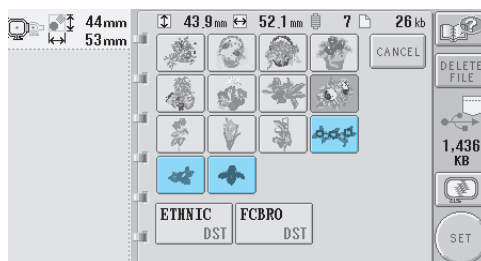
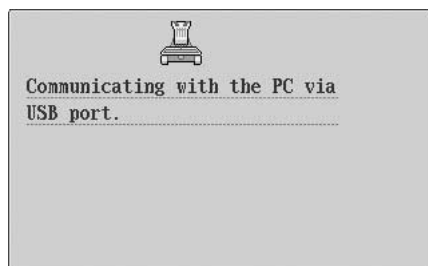

4 Touch .

This confirms the pattern selection.

- ▶ The pattern editing screen appears.



Note

- The pattern recalled from the computer is only temporarily written to the machine. It is erased from the machine when the machine is turned off. If you wish to keep the pattern, store it in the machine. (Refer to "Machine's Memory" on page 136.)

■ If the desired pattern cannot be recalled

When recalling pattern data from the computer, the data is not taken directly from the computer. Instead, the pattern data is temporarily written to the machine, and that written pattern data is recalled. The amount of data written to the machine is limited, and pattern data cannot be recalled if that data amount is exceeded.

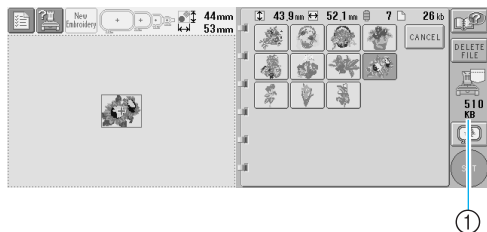

- ① Shows the amount of available space in the USB area of the machine. If pattern data with this size is added, it can be recalled (temporarily written).

To recall a pattern larger than the amount of space available, delete any currently written patterns, and then place the pattern that you wish to recall into the folder.

1 Remove all unnecessary patterns from the “Removable Disk” folder on the computer.

Select the pattern data, and then move it to a different folder, the Recycle Bin, or right-click it and click “Delete”.

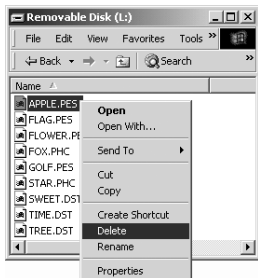

2 Place the pattern that you wish to recall into the “Removable Disk” folder.

- ▶ After writing the data to the embroidery machine, the key for that pattern appears in the screen.

3 If the desired pattern can still not be written, repeat steps 1 and 2.

■ Disconnecting the USB cable

Before disconnecting the USB cable, click the “Unplug or Eject Hardware” icon in the taskbar of Windows® Me/2000 or the “Safely Remove Hardware” icon in the taskbar of Windows® XP. Then, when the removable disk has been removed safely, disconnect the USB cable from the computer and the machine.



With Windows 98SE, check that the Access lamp is not flashing before disconnecting the USB cable from the computer and the machine.

Note

- Be sure to perform the operation described above before disconnecting the USB cable from the computer and embroidery machine, otherwise the computer may malfunction, the data may not be written correctly, or the data or data writing area on the embroidery machine may be damaged.

USB media (Commercially Available)

You can recall a specific embroidery pattern from either directly USB media or a folder in the USB media. If the embroidery pattern is under the folder, move down layers of folders following a path to it. For details on storing a pattern, refer to “Saving Embroidery Patterns” on page 136.



Note

- USB media and reader/writer units can be purchased at electronic/computer retailers.
- Some USB media may not be usable with this machine. Please visit our web site for more details.

1 Insert the USB media into the machine’s USB Type “A” (host) port.

Depending on the type of USB media being used, either directly plug the USB device into the machine’s USB port on the right side of the operation panel or plug the USB Card Reader/Writer into the machine’s USB Type “A” (host) port.

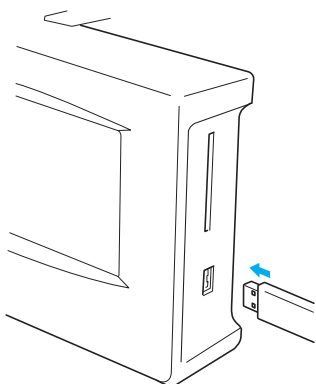

When connecting the USB Card Reader/Writer to the machine’s USB Type “A” (host) port, be sure to secure the cable with the three hooks on the back panel. If the cable is not secured, the embroidery frame may catch on the cable while the frame is moving, causing the pattern to become misaligned.

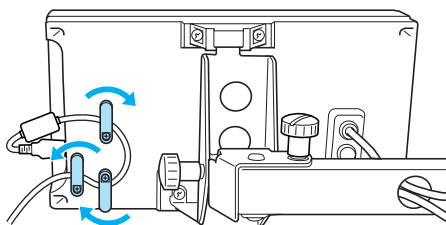

Note

- Only insert or remove USB media while  appears in the display or while the embroidery machine is turned off.
- Do not insert anything other than USB media into the USB media port connector. Otherwise, the USB media drive may be damaged.

2

Touch .

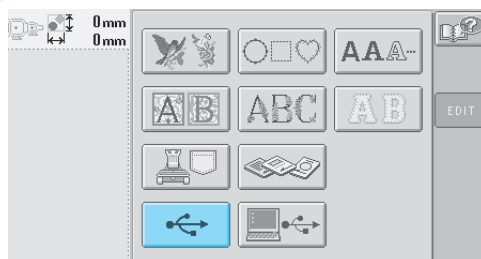

- ▶ A list of patterns and folders at the topmost level are displayed.
- The pattern list is usually displayed within a few seconds; however, if there are many patterns, it may take some time for them to be displayed. While the patterns are being read, do not remove the USB media. Instead, wait until the patterns are displayed.
- After recalling data from USB media, if other data is recalled from the same USB media without removing the card, the list of patterns in the folder containing the previously selected pattern is displayed.

3

To select a pattern in a lower-level folder, select the folder.

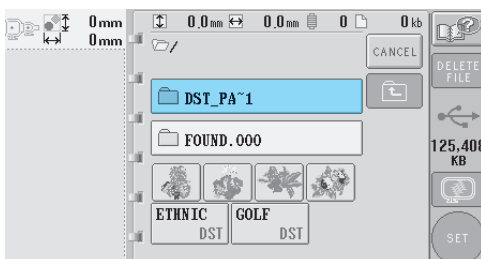

5

- ▶ The list of folders and patterns in the selected folder are displayed in order.

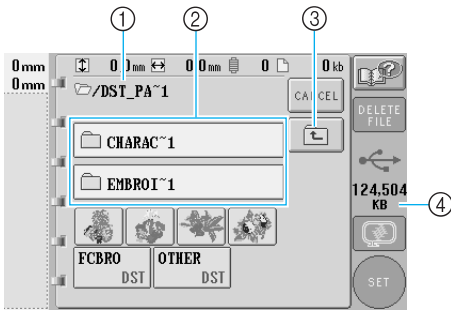

- ① Shows the name of the current folder
- ② Shows the folder in the current folder
If the folder name is more than nine characters long, the name changes to the first six characters followed by "~" and a number.
- ③ Touch this key to move up one folder level.
- ④ Shows the amount of available space in the USB media

- 4 Select an embroidery pattern.**
Touch the key for the desired pattern.
 - Press to return to the original screen.

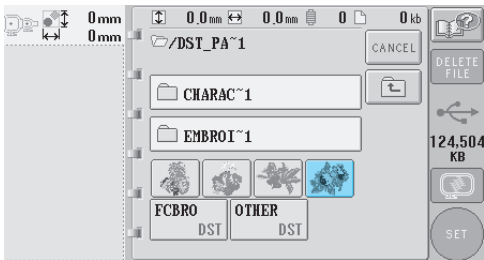

- ▶ The selected pattern appears in the pattern display area.

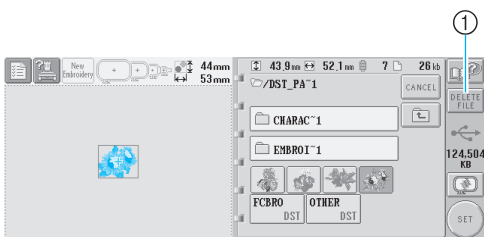

- ① Touch this key to delete the selected pattern.
 - ▶ If the wrong pattern was selected or you wish to select a different pattern, touch the key for the desired pattern.

■ Deleting embroidery data

From this screen, the embroidery data stored on the USB media can be organized by deleting unnecessary data.
After selecting the pattern that you wish to delete, touch to display the screen shown below.

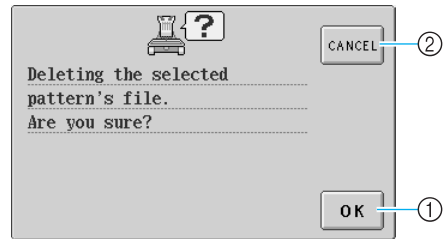

- ① Deletes the data, then returns to the data with no pattern selected
- ② Does not delete the data, then returns to the data before was touched

Note

- To delete the USB media pattern data, delete it from the machine. This will delete design data completely.

5 Touch .

This confirms the pattern selection.
▶ The pattern editing screen appears.

Note

- Do not unplug the USB media or eject the floppy disk or CD while a stitch pattern is being read or deleted, otherwise the USB media may be damaged or data may be lost. In addition, do not unplug the USB media or eject the floppy disk or CD while the contents of the USB media, floppy disk or CD are displayed.

Editing the Embroidery Pattern (Pattern Editing Screen)

The patterns can be edited from the pattern editing screen and the embroidering settings screen. Individual patterns can be edited with the pattern editing screen, and the entire pattern can be edited with the embroidering settings screen. The results of editing the pattern can be seen in the pattern display area.

Combining patterns

Various patterns, such as embroidery patterns, frame patterns, built-in alphabet patterns and patterns on embroidery cards, can easily be combined.

1 Touch **MERGE**.

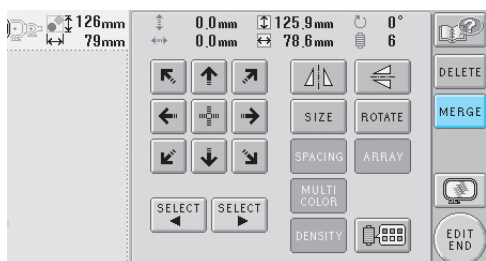

- ▶ The pattern type selection screen appears again.

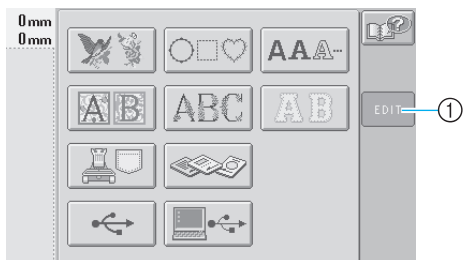

- ① Touch this key to quit trying to combine patterns. The pattern editing screen appears.

- 2 **Select an embroidery pattern.**
Select the pattern to be added as described on page 102 to 118.

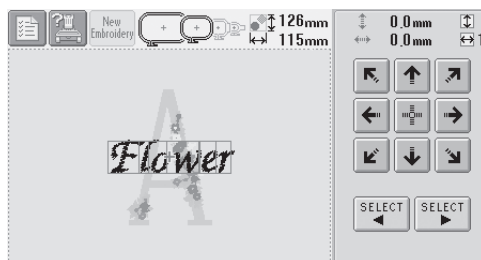

- When another pattern is selected, it is normally added at the center of the pattern display area.

- 3 Repeat steps 1 and 2 until all patterns to be combined are selected.

Note

- Up to 100 patterns can be combined. More than 100 cannot be selected for combining. In addition, combining cannot continue if there is no more free space in the machine's memory or if the maximum number of colors allowed (500 colors) is exceeded.

Memo

- The position of individual patterns and other editing operations can be performed from the pattern editing screen. The editing operations can be performed in the same way from the pattern editing screen whether it is displayed as each pattern is selected or after all patterns that you wish to combine have been selected.

Selecting the pattern to be edited

If multiple patterns are selected, you can choose which pattern will be edited.

- 1 Touch **SELECT** or **SELECT**.

The pattern that will be edited is the pattern enclosed by the red frame.

Continue touching **SELECT** and **SELECT** until the red frame is around the pattern that you wish to edit.

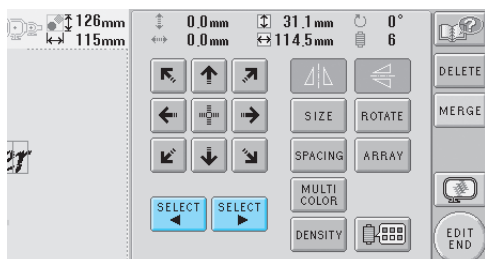

- ▶ The patterns are selected in the order or the opposite order that they were added to the pattern.

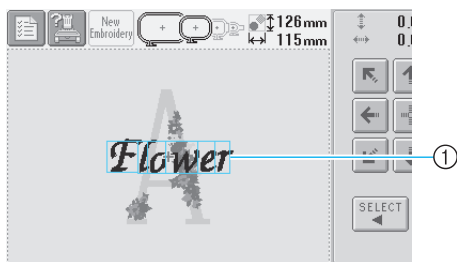

- ① Red frame indicating the pattern to be edited

Memo

- If multiple patterns appear in the pattern editing screen, the basic editing procedure is to 1. select the pattern to be edited, and then 2. edit that pattern.

Moving a pattern

Determine where in the embroidery frame the pattern will be embroidered. If multiple patterns are combined, move each pattern to lay out the design.

- 1 Touch the key for the direction where you wish to move the pattern.

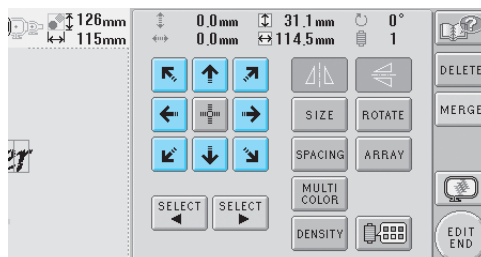

- ▶ The pattern moves in the direction of the arrow on the key.

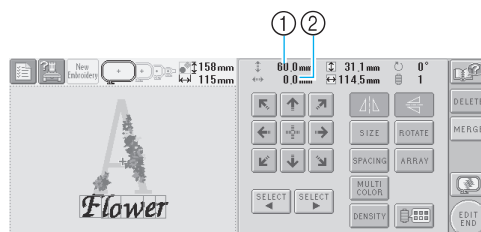

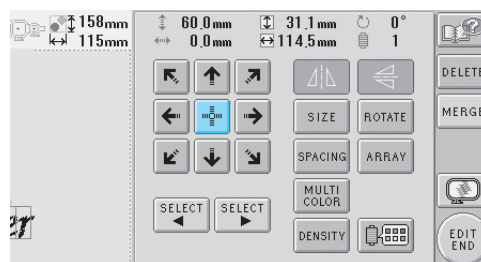

- ① Shows the vertical distance moved
- ② Shows the horizontal distance moved
- To return the pattern to its position before it was moved (center of the embroidery frame), touch .



Memo

- The pattern can also be moved by touching the arrow keys in the screens that appear when any of the other editing keys are touched.
- The arrow keys in the embroidering settings screen are used to move the frame to select the embroidering position.

Flipping a pattern horizontally

- 1 Touch  so that it changes to .

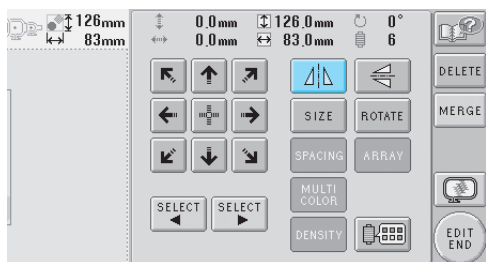

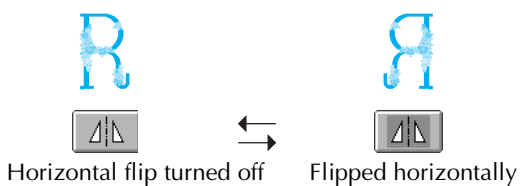

► The pattern is flipped horizontally.

- Each touch of the key turns the setting either on or off.



Flipping a pattern vertically

- 1 Touch  so that it changes to .

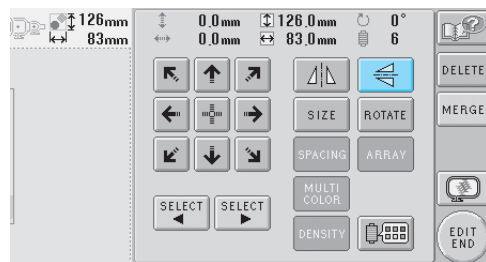

► The pattern is flipped vertically.

- Each touch of the key turns the setting either on or off.

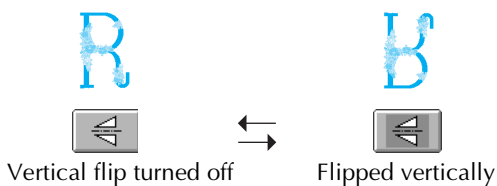

Changing the size of a pattern

The size of the pattern can be increased or decreased to between 90% and 120% of its original size.

- 1 Touch .

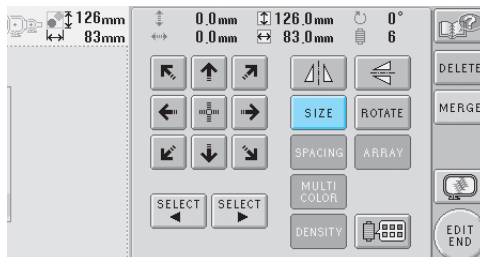

► The screen shown below appears.

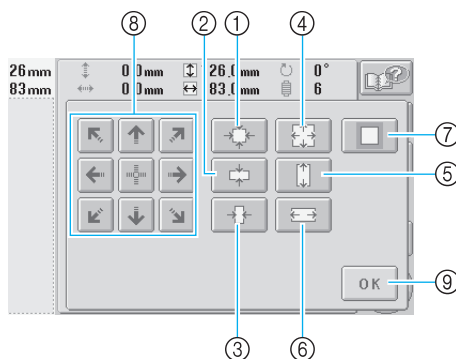

Example: Original size



- ① Reduces without changing the height-to-width proportion.
- ② Reduces only in the vertical direction.
- ③ Reduces only in the horizontal direction.
- ④ Enlarges without changing the height-to-width proportion.
- ⑤ Enlarges only in the vertical direction.
- ⑥ Enlarges only in the horizontal direction.
- ⑦ Touch this key to return the pattern to its original size.
- ⑧ Moves the pattern in the direction of the arrow on the key.
- ⑨ Touch this key to close this screen.

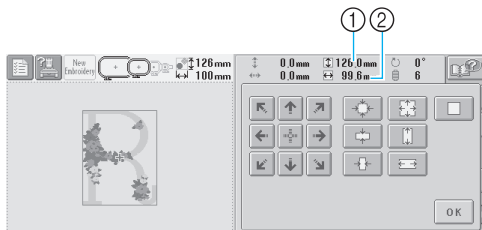

- 2 Touch the keys to adjust the pattern to the desired size.**
Each touch of a key slightly enlarges or reduces the pattern.



The size of the pattern is displayed after a key is touched to change it.

- ① Vertical length
- ② Horizontal width
- The size that the pattern can be enlarged depending on the pattern or character.
- Depending on the pattern or character, if it is rotated 90 degrees it may be enlarged even more.
- If the pattern is rotated, the vertical and horizontal directions may be reversed.
- To return the pattern to its original size, touch  so that it changes to .

- 3 If necessary, touch the arrow keys to adjust the position of the pattern.**
For more details, refer to page 120.

- 4 After making the desired changes, touch .**

► The pattern editing screen appears again.

CAUTION

● After changing the size of the pattern, check the icons for the embroidery frames that can be used and use only the indicated frames. If a frame other than those indicated are used, the presser foot may hit the embroidery frame and cause injuries.

Rotating a pattern

The pattern can be rotated between 1 and 359 degrees either clockwise or counterclockwise.

- 1 Touch .**

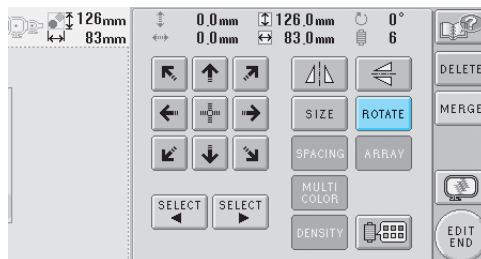

► The screen shown below appears.

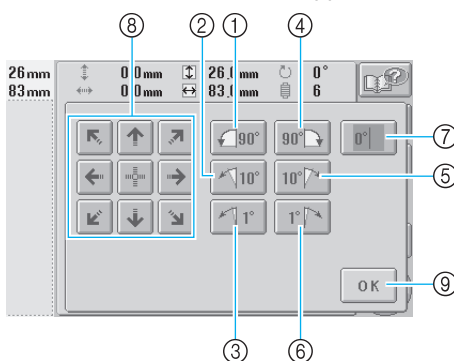

Example: Original angle

- ① Rotates 90 degrees to the left
- ② Rotates 10 degrees to the left
- ③ Rotates 1 degree to the left
- ④ Rotates 90 degrees to the right
- ⑤ Rotates 10 degrees to the right
- ⑥ Rotates 1 degree to the right
- ⑦ Touch this key to return the pattern to its original angle.
- ⑧ Moves the pattern in the direction of the arrow on the key.
- ⑨ Touch this key to close this screen.



- 2** Touch the keys to adjust the pattern to the desired angle.
Each touch of a key rotates the pattern.

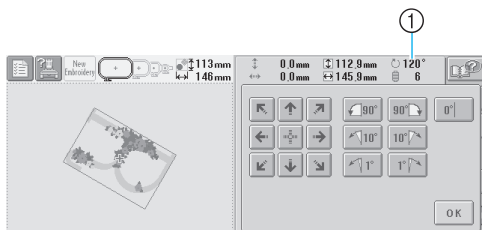

- ① Shows the angle of the pattern after a key is touched to change it.
- To return the pattern to its original angle (0 degrees), touch **0°** so that it changes to **0°**.

- 3** If necessary, touch the arrow keys to adjust the position of the pattern.

For more details, refer to page 120.

- 4** After making the desired changes, touch **OK**.



- The pattern editing screen appears again.

CAUTION

- After changing the angle of the pattern, check the icons for the embroidery frames that can be used and use only the indicated frames. If a frame other than those indicated are used, the presser foot may hit the embroidery frame and cause injuries.



Memo

- If **ROTATE ALL** in the embroidering settings screen is used, the entire combined pattern can be rotated. (For details, refer to "Rotating the entire pattern" on page 129.)
- If the pattern is too large or the pattern is too close to the edge of the embroidery field, all of the rotating options may not apply.

Changing the text arrangement of a character

Characters can be arranged on a horizontal line, on a slant or on an arc.

- 1** Touch **ARRAY**.

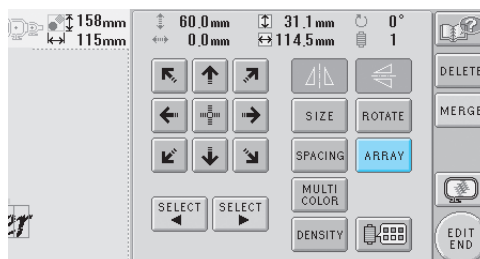

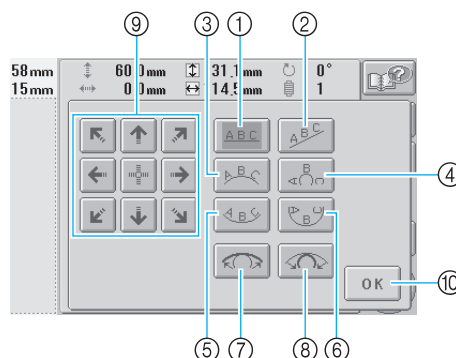

- The screen shown below appears.



- 1 Arranges the text on a straight line
- 2 Arranges the text on a slanted line
- 3 Arranges the text on the outside of a wide curve
- 4 Arranges the text on the outside of a sharp curve
- 5 Arranges the text on the inside of a wide curve
- 6 Arranges the text on the inside of a sharp curve
- 7 If touched after selecting a text arrangement on a curve, each touch of this key decreases the bend of the curve (makes it flatter).
- 8 If touched after selecting a text arrangement on a curve, each touch of this key increases the bend of the curve (makes it more curved).
- 9 Moves the pattern in the direction of the arrow on the key
- 10 Touch this key to close this screen.

- 2** Touch the key of the desired text arrangement.

- 3** After selecting the desired text arrangement, the bend of the curve can be adjusted. If necessary, touch  and  to adjust the bend of the curve.

- 4 If necessary, touch the arrow keys to adjust the position of the pattern.

For more details, refer to page 120.

- 5 After making the desired changes, touch



- ▶ The pattern editing screen appears again.



Memo

- The text arrangement specified when the character was selected on page 123 can be changed at this point.

Changing the character spacing

The spacing between the characters can be made wider or narrower.

- 1 Touch **SPACING**.

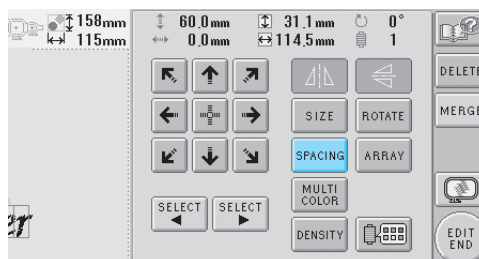

- ▶ The screen shown below appears.

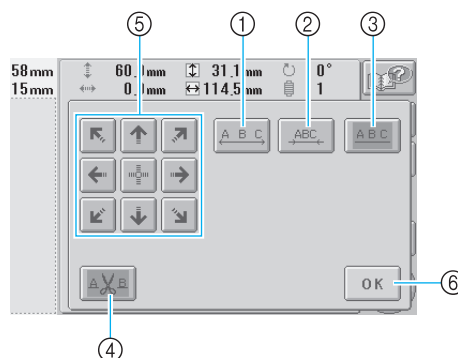

- ① Increases the space between characters
- ② Decreases the space between characters
- ③ Selects the standard character spacing (original character spacing)
- ④ Specifies that the thread be trimmed between characters
- ⑤ Moves the pattern in the direction of the arrow on the key
- ⑥ Touch this key to close this screen.

- 2 Touch the keys to adjust the characters to the desired spacing.

Each touch of a key slightly enlarges or reduces the character spacing.



- To return the characters to their original spacing, touch **A B C** so that it changes to



■ Trimming the threads between characters

If the machine is set to trim the threads between the characters, the jumpstitches between the characters are reduced and any other necessary procedures after embroidering are reduced. However, the embroidering time will increase if the threads are trimmed between each of the characters.

3 If necessary, specify that the threads be trimmed between characters.

Touch  so that it changes to .

- Each touch of the key turns the setting either on or off.



Threads are not trimmed.

Threads are trimmed.

4 If necessary, touch the arrow keys to adjust the position of the pattern.

For more details, refer to page 120.

5 After making the desired changes, touch

.

- ▶ The pattern editing screen appears again.

Changing the thread density

(only for some character and frame patterns)

The thread density for some character and frame patterns can be changed.

A setting between 80% and 120% in 5% increments can be specified.

1 Touch .

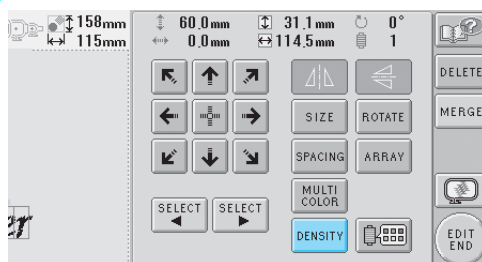

- ▶ The screen shown below appears.

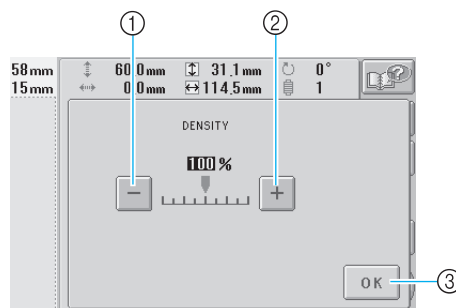

- ① Selects a less thread density
- ② Selects a more thread density
- ③ Touch this key to close this screen.

■ Selects a less thread density



■ Selects a more thread density



2 Touch the keys to select the desired thread density.

Each touch of a key slightly increases or decreases the thread density.

- To return to the original thread density (standard), select “100%”.

3 After making the desired changes, touch

OK.

- ▶ The pattern editing screen appears again.

Specifying multi-color text

The alphabet pattern characters selected on page 109 are set to black. The color of the characters can be changed using the change thread color key; however, to change the color of individual characters, touch the Multi Color key to turn it on, and then specify the color for each character.

1 Touch **MULTI COLOR** so that it changes to **MULTI COLOR**.

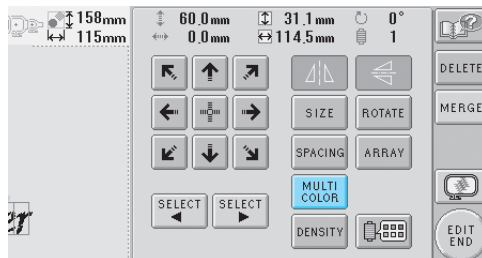

- Each touch of the key turns the setting either on or off.

MULTI COLOR



MULTI COLOR

Multi-color text turned off

Multi-color text turned on

- For details on changing the thread color, refer to “Changing the colors of the pattern” on page 127.

Changing the colors of the pattern

The colors of the pattern can be changed and previewed on the screen.

By changing the colors of the pattern, the same pattern can be viewed in various ways.

If your thread colors are registered in a color thread table and if you used the table for changing color, the thread spools can be assigned with the thread colors that you have. And the pattern displayed in the screen will appear with colors that are almost the same as the actual thread colors.

With this operation, the colors of all patterns will be changed, not just those of the pattern being edited.

1 Touch .

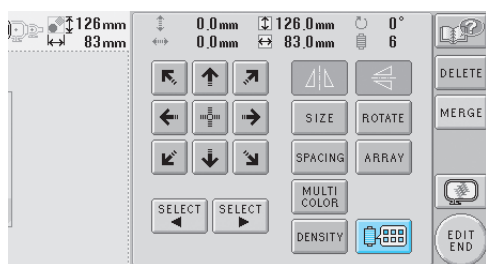

► The change thread color screen appears.

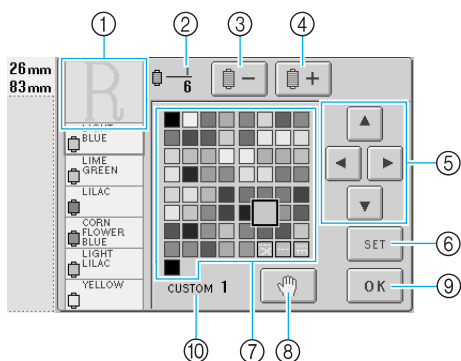

- ① The part of the pattern in the color at the top of the thread color sequence display is the part whose color is being changed.
- ② Shows the number of thread color changes. The top value shows the position in the sewing order for the color at the top of the thread color sequence display and the bottom value shows the total number of thread color changes.
- ③ Selects the previous color in the thread color sequence display
- ④ Selects the next color in the thread color sequence display
- ⑤ Use these keys to select a color from the color thread table.
- ⑥ Applies the color change

- ⑦ Color thread table
Select a color from this table.
- ⑧ Specifies pause locations (Refer to “Specifying pause locations before embroidering” on page 92.)
- ⑨ Touch this key to close this screen.
- ⑩ Name of the table

2 Touch and until the color to be changed appears at the top of the thread color sequence display.

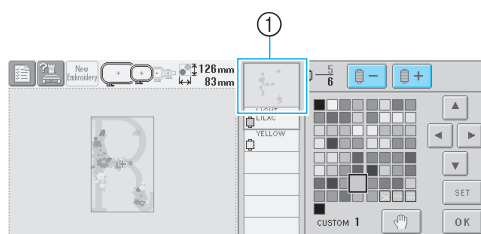

- ① The thread color for the part of the pattern displayed at the top will be changed.

3 Touch , , and to select the new color from the color palette.

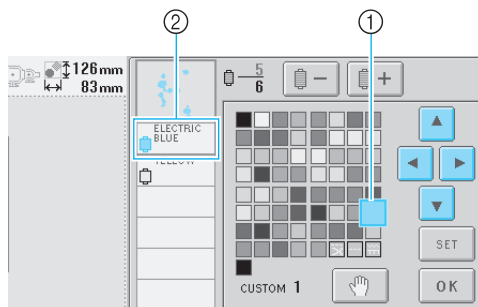

- ① The color that appears enlarged is the color that is selected.
 - ② Displays the name of the selected thread color
- In the pattern display area, the color of the selected part of the pattern is changed.

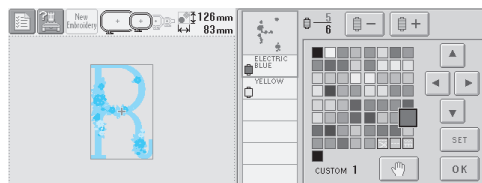

4 Touch **SET**.

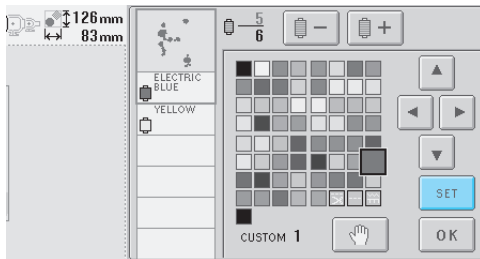

► The color change is confirmed.

- Make sure to touch **SET** to specify the new color, otherwise the thread color is not changed.
- If the wrong thread color is specified or if you wish to change the thread color again, select a different thread color, and then touch **SET**.

5 Repeat steps 2 through 4 until the colors of all parts that you wish to change are changed.

6 After making the desired changes, touch



► The pattern editing screen appears again.



Memo

- Touch  to specify pause locations. For details, refer to “Specifying pause locations before embroidering” on page 92.
- The color thread table can be changed to a custom thread that you create to reflect the thread colors that you have. (Refer to “Custom thread table settings” on page 147.)

Deleting a pattern

1 Touch **DELETE**.

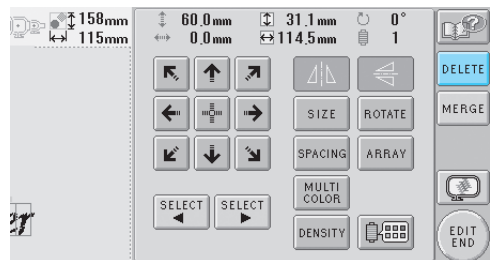

► The screen shown below appears.

2 Touch **OK**.

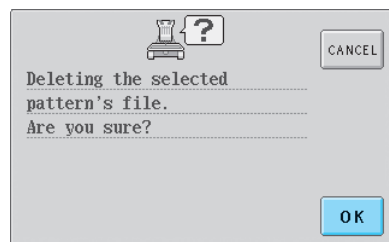

► The pattern is deleted.

- To quit deleting the pattern, touch **CANCEL**.

Editing the Embroidery Pattern (Embroidering Settings Screen)

In the embroidering settings screen, a single pattern can be edited if patterns were not combined or an entire combined pattern can be edited as a single pattern.

In addition, the arrow keys can be used to move the pattern in the pattern editing screen or move the embroidery frame in the embroidering settings screen. Touching these keys moves the embroidery frame.

Rotating the entire pattern

The entire pattern can be rotated.

- 1 Touch **ROTATE ALL**.

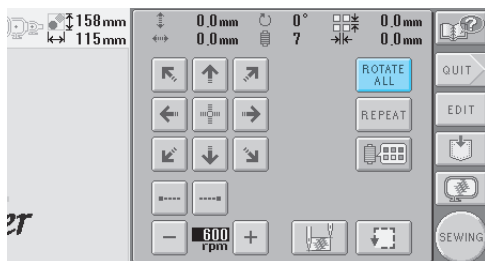

► The screen shown below appears.

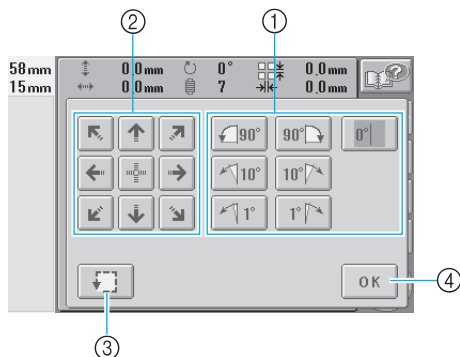

- 1 Enables the entire pattern to be rotated.
- 2 Enables the embroidery frame to be moved.
- 3 Enables the embroidering area to be checked.
- 4 Touch this key to close this screen.

- 2 Touch the keys to adjust the pattern to the desired angle.

For more details, refer to page 122.

- 3 If necessary, touch the arrow keys to adjust the position of the embroidery frame.

For more details, refer to page 72.

- 4 If necessary, touch  to check the embroidering area.

For more details, refer to page 32.

- 5 After making the desired changes, touch



► The embroidering settings screen appears again.

Memo

- If **EDIT** is touched to return to the pattern editing screen after the entire pattern is rotated, the pattern appears as it did before the rotation angle was specified, but the setting is not cancelled. When the embroidering settings screen is displayed again, the pattern appears with the rotation angle applied. However, if an error occurs, for example, if the pattern is enlarged in the pattern editing screen so that it extends out of the embroidering area when it is rotated, the following error message appears.

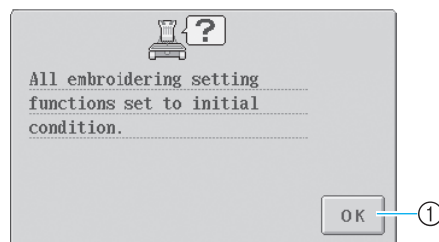

- 1 Touch **OK** to return to the pattern editing screen so that the pattern can be re-edited.

Creating a repeating pattern

The entire pattern can be copied and repeated the specified number of times. The pattern can be repeated a maximum of 20 times in both the vertical and the horizontal directions within the embroidering area.

1 Touch **REPEAT**.

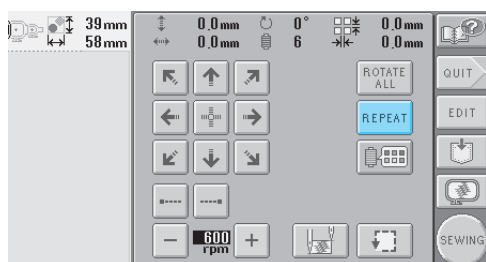

► The screen shown below appears.

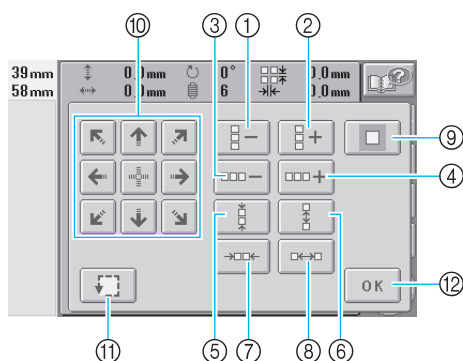

- ① Each touch of this key reduces the number of rows by one.
 - ② Each touch of this key increases the number of rows by one.
 - ③ Each touch of this key reduces the number of columns by one.
 - ④ Each touch of this key increases the number of columns by one.
 - ⑤ Decreases the spacing between patterns in a row.
 - ⑥ Increases the spacing between patterns in a row.
 - ⑦ Decreases the spacing between patterns in a column.
 - ⑧ Increases the spacing between patterns in a column.
- Each touch of these keys increases or decreases the spacing between patterns by 5 mm (3/16 inches).

- ⑨ Resets the repeating settings. The pattern returns to the arrangement before repeating was specified.
- ⑩ Moves the embroidery frame in the direction of the arrow on the key.
- ⑪ Enables the embroidering area to be checked.
- ⑫ Touch this key to close this screen.

- ### 2 Touch **⏏+**, **⏏+**, **⏏-** or **⏏-** to specify the number of times that the pattern is copied. Each touch of a key increases or decreases the rows or columns by one.

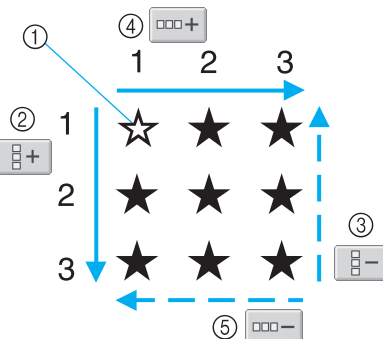

- ① Original pattern
- ② Increases by one row
- ③ Decreases by one row
- ④ Increases by one column
- ⑤ Decreases by one column

- ### 3 Touch **⏏←**, **⏏←**, **⏏→** or **⏏→** to specify the pattern spacing. Each touch of a key increases or decreases the spacing between patterns in the corresponding direction by 5 mm (3/16 inches).

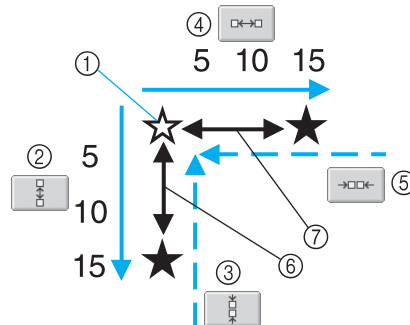

- ① Original pattern
- ② Increases the spacing between rows by 5 mm (3/16 inches)
- ③ Decreases the spacing between rows by 5 mm (3/16 inches)
- ④ Increases the spacing between columns by 5 mm (3/16 inches)
- ⑤ Decreases the spacing between columns by 5 mm (3/16 inches)
- ⑥ Spacing between rows
- ⑦ Spacing between columns

The size of the pattern is displayed after a key is touched to change it.

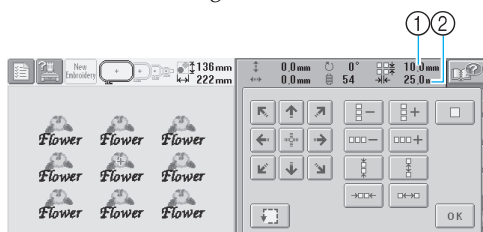

- ① Repeat spacing (vertical)
- ② Repeat spacing (horizontal)
- To quit repeating the pattern and return it to its original arrangement, touch so that it changes to .

4 If necessary, touch the arrow keys to adjust the position of the embroidery frame.
For more details, refer to page 72.

5 If necessary, touch to check the embroidering area.
For more details, refer to page 32.

6 After specifying the desired repeat settings, touch .

▶ The embroidering settings screen appears again.



Memo

- If is touched to return to the pattern editing screen after specifying repeat settings, the pattern appears as it did before the repeat settings were specified, but the settings are not cancelled. When the embroidering settings screen is displayed again, the pattern appears with the repeat settings applied. However, if an error occurs, for example, if the pattern is enlarged in the pattern editing screen so that it extends out of the embroidering area when it is repeated, the following error message appears.

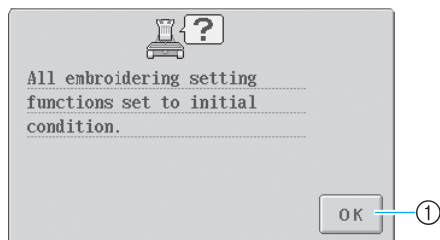

- ① Touch to return to the pattern editing screen so that the pattern can be re-edited.

Changing the colors of the pattern

The colors of the pattern can be changed and previewed in the screen. The function and operation for this key is the same as that for the change thread color key in the pattern editing screen.

1 Touch .

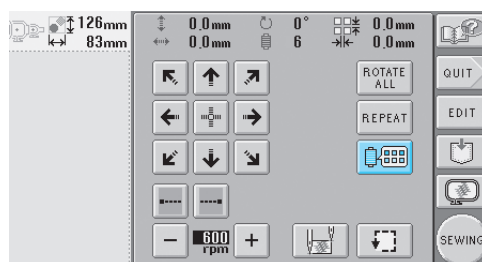

▶ The change thread color screen appears.

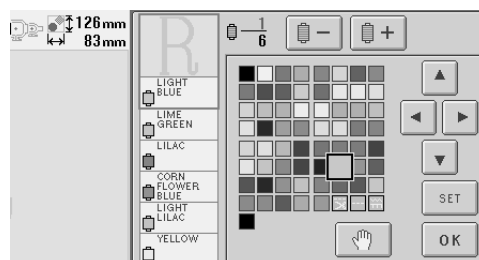

2 For details on changing the colors, refer to page 127.



Memo

- Even if is touched to return to the pattern editing screen after colors are changed, the settings are not cancelled.

5

Editing a Combined Pattern

Example)



In this section, we will combine text with floral alphabet pattern, which we will then edit.

1 Touch **ABC**.

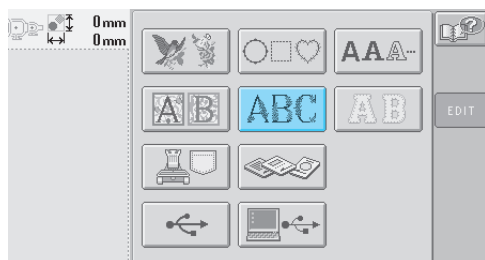

2 Select .

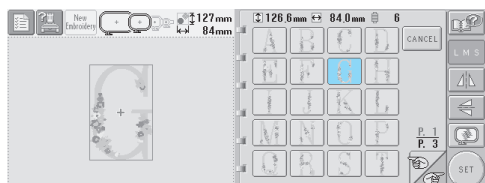

► This pattern will be positioned at the center of the embroidery area.

3 To select the pattern, touch **SET**.

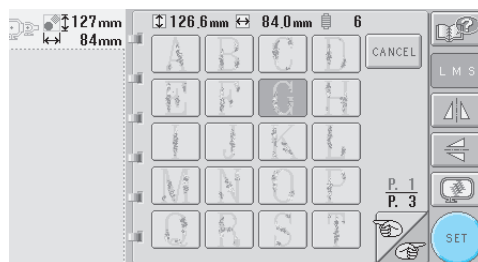

► The pattern editing screen appears.

4 Touch **MERGE**.

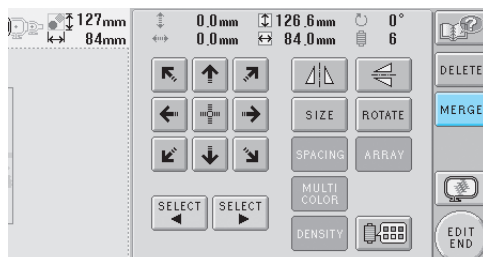

► The pattern type selection screen appears again.

5 Touch **AAA-**.

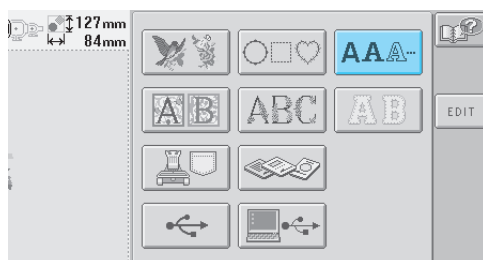

6 Touch **ABC**.

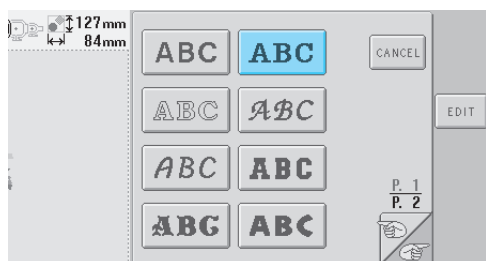

7 Type "ood".
Touch the tab for lowercase letters to display the lowercase letters input screen, and then touch "o", "o", then "d".

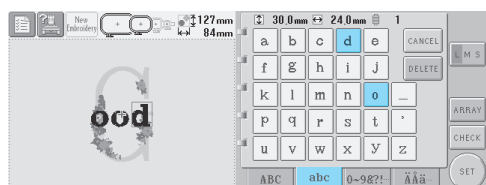

- ▶ The selected letters appear at the center of the embroidery area.
- To change the size of the pattern, select "o", and then touch **L M S** to select the desired size.
- To change the text arrangement, touch **ARRAY**, and then select the desired text arrangement.

8 After selecting the characters, touch **SET**.

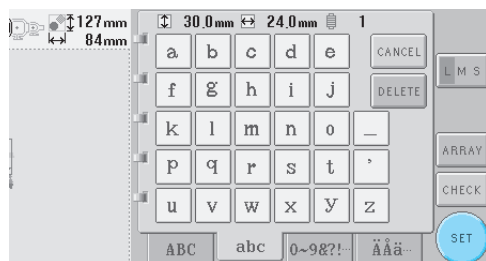

- ▶ The pattern editing screen appears.

9 Touch **→** and adjust the position of the letters.

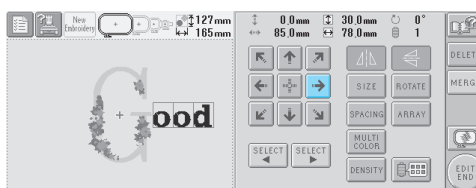

10 Touch **MERGE**.

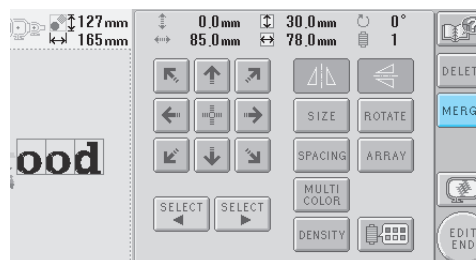

- ▶ The pattern type selection screen appears again.

11 As before, touch **AAA**.

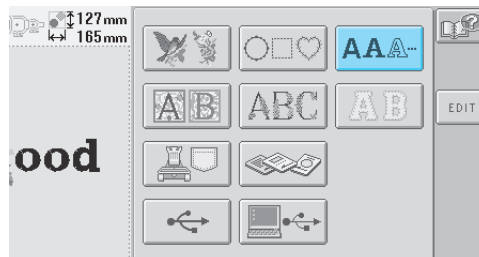

5

- 12** Touch **ABC** to select the same font, and then type "Luck".
After touching "L", touch the tab for lowercase letters to display the lowercase letters input screen, and then touch "u", "c", then "k".

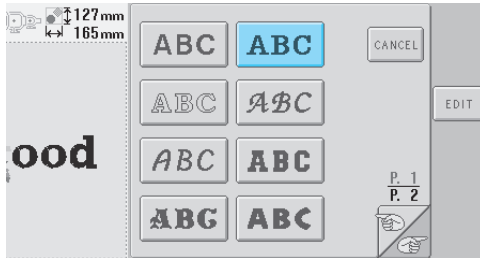

- ▶ The selected letters appear at the center of the embroidery area.



- 13** After selecting the characters, touch **SET**.

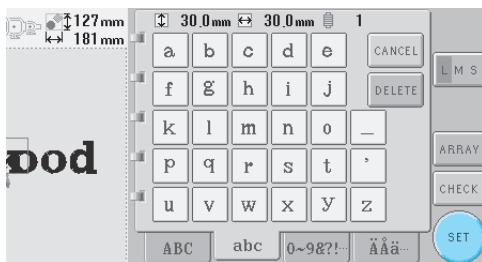

- ▶ The pattern editing screen appears.

- 14** Touch **↓**, **↙**, **→** and adjust the position of the letters so that they are well balanced.

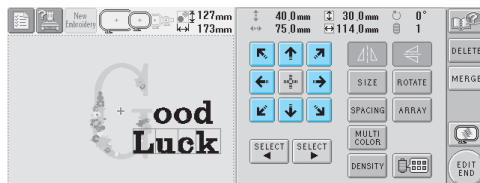

- 15** Check the balance of the entire pattern, and, if you wish to edit the pattern, touch **SELECT** and **SELECT** to select the pattern to be edited.

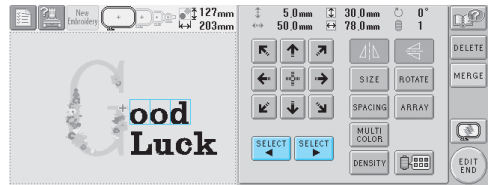

Example: To reduce size.



- 16** Touch **SELECT** and **SELECT** to move the red frame around.

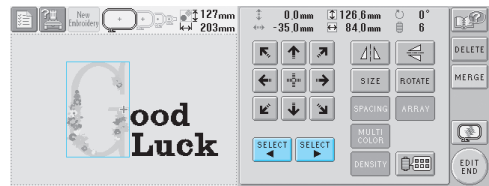

17 Touch **SIZE**.

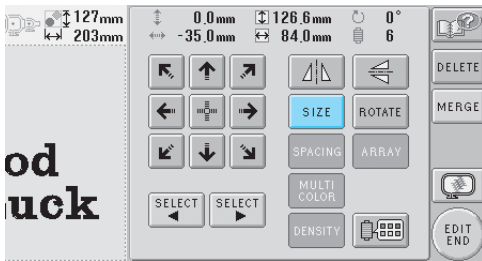

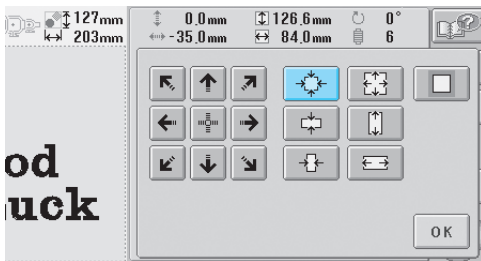

18 Touch  to reduce the pattern proportionately.



19 After reducing the pattern, touch **OK** to return to the pattern editing screen.



- To adjust other parts of the pattern, touch **SELECT** and **SELECT** again, and then adjust the pattern as desired.
- If it is difficult to view the text and the pattern, touch , and then touch  to preview it. Touch **CLOSE** to return to the previous screen.



20 After finishing all editing, touch **EDIT END**.

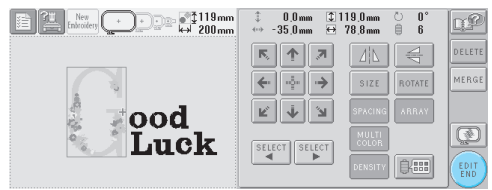

► The embroidering settings screen appears.



- To return to the pattern editing screen and continue editing the pattern, touch **EDIT**.

Saving Embroidery Patterns

Machine's Memory

You can save embroidery patterns that you have customized and will use often, for example, your name or other pattern combinations, patterns that have been rotated or resized, or patterns that have had their embroidering position changed.



Note

- Do not turn off the machine while the "Saving" screen is displayed, otherwise you may lose the pattern that you are saving.



Memo

- It takes a few seconds to save a pattern in the machine's memory.
- See page 111 for information on retrieving a saved pattern.

- With the pattern that you want to save displayed in the sewing screen, press .

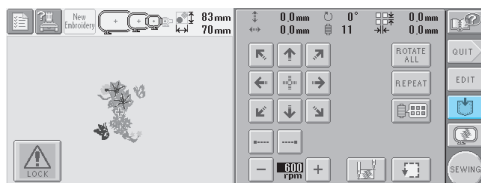

- Press .

- Press to return to the previous screen without saving the pattern.

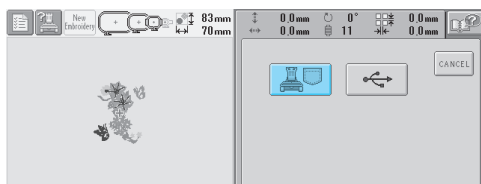

- The "Saving" screen appears. When the pattern is saved, the previous screen appears automatically.

If the Embroidery Pattern Cannot Be Saved

If the following screen appears, the embroidery pattern cannot be saved because either the machine's memory is full or the pattern being saved is larger than the amount of space available in the memory. To be able to save the embroidery pattern in the machine's memory, a previously saved pattern must be deleted.

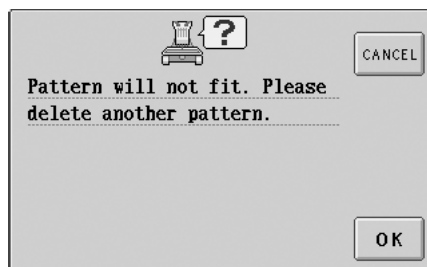

- To quit saving, touch .

■ Deleting saved data

- Touch .

► The list of patterns appears.

- Select the pattern to be deleted. Touch the pattern.

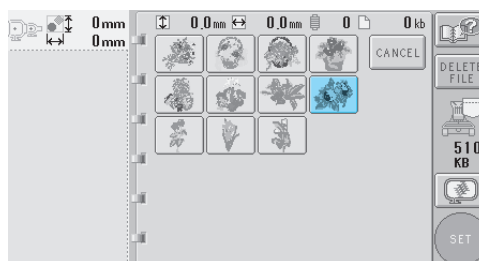

- The selected pattern appears in the pattern display area.

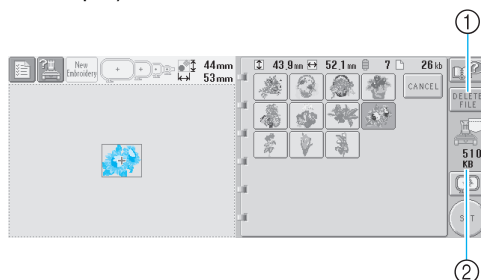

- Touch this key to delete the selected pattern.
- Shows the amount of free space in the machine's memory.

- If the wrong pattern was selected or you wish to select a different pattern, touch the desired pattern.

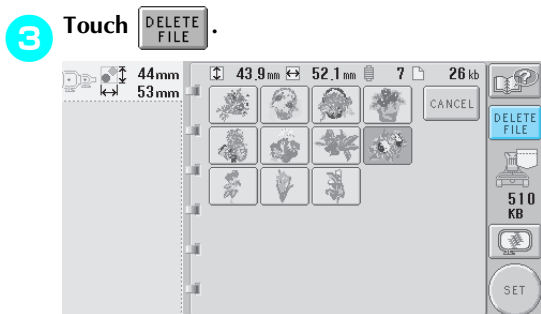

▶ The screen shown below appears.

4 To delete the data, press **OK**.

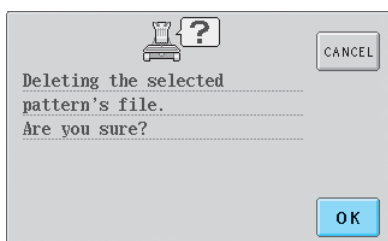

▶ The pattern is deleted, and if there is enough space, the previous screen appears automatically.

- To quit deleting, press **CANCEL**.

5 If there is not enough space, delete another pattern.

- ▶ If the embroidery data was saved successfully, the previous screen automatically appears.
- Saving the data takes approximately 10 seconds.



Note

- Do not turn off the machine while the "Saving" message is displayed, otherwise the pattern data being saved may be lost.

■ Recalling stored patterns

Refer to the appropriate page of "Selecting an Embroidery Pattern" according to the media being used. (For patterns saved on the machine, refer to page 111. For patterns saved on USB media, refer to page 117.

USB Media (Commercially Available)

When sending embroidery patterns from the machine to USB media, plug the USB media into the machine's USB Type "A" (host) port. Depending on the type of USB media being used, either directly plug the USB device into the machine's USB Type "A" (host) port or plug the USB Card Reader/Writer into the machine's USB port.



Memo

- Some USB media may not be usable with this machine. Please visit our web site for more details.

1 Press  when the pattern you want to save is in the sewing screen.

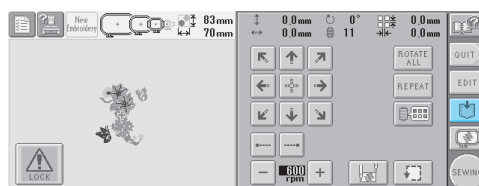

2 Insert the USB media into the USB port connector on the machine.

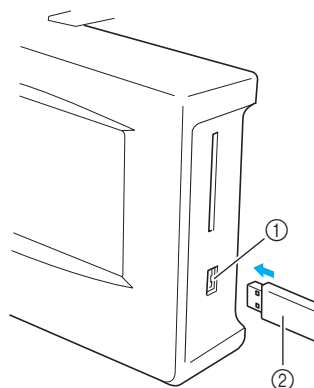

- ① USB Type "A" (host) port connector for media
- ② USB media

When connecting the USB Card Reader/Writer to the machine's USB Type "A" (host) port, be sure to secure the cable with the three hooks on the back panel. If the cable is not secured, the embroidery frame may catch on the cable while the frame is moving, causing the pattern to become misaligned.

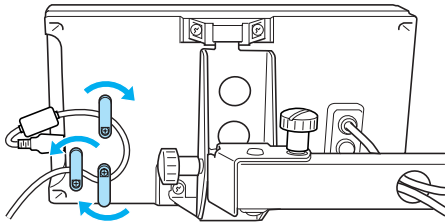

Memo

- Do not insert anything other than USB media into the USB media port connector. Otherwise, the USB media drive may be damaged.

3 Press .

- Press  to return to the original screen without saving.

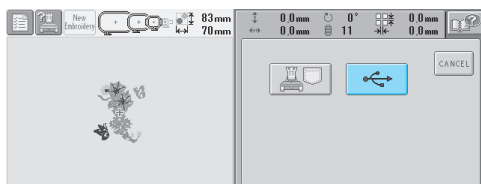

- ▶ The "Saving" screen is displayed. When the pattern is saved, the display returns to the original screen automatically.

Note

- Do not unplug the USB media or eject the floppy disk while the "Saving" screen is displayed, otherwise the USB media may be damaged or data may be lost.

6**BASIC SETTINGS AND HELP FEATURE**



This chapter contains descriptions on the use of the settings key, the machine operations key and the help key, introduced on page 21. Details on changing the basic embroidery machine settings and viewing operations on the LCD will be provided.

Using the Settings Key	140
Understanding the settings screen / 140	Adjusting the brightness of the LCD / 142
Turning the buzzer on or off / 142	Changing the language / 143
Changing the units of measurements / 143	Changing the display guides / 143
Changing the thread color information / 145	
Display expanded thread color / 146	Custom thread table settings / 147
Specifying jumpstitch trimming / "DST" jump codes for trimming / 149	
Deleting short stitches / 150	Specifying the remaining length of thread / 150
Using the Machine Operations Guide Key	151
Using the Help Key	153

Using the Settings Key

Touch  (settings key) to change many of the basic embroidery machine settings.

Understanding the settings screen

There are five pages in the settings screen. Touch  and  in the lower-right corner of the screen until the desired page is displayed. The  key appears on all pages.

■ Page 1

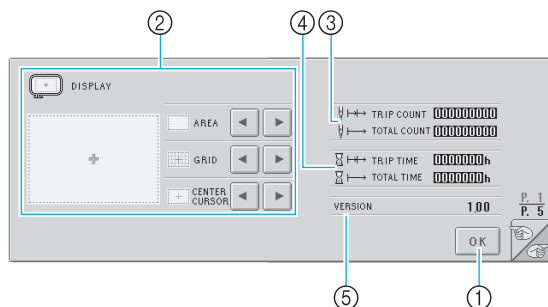

- ① Touch to quit specifying settings. The settings are confirmed and the screen that was displayed before the settings key was touched appears again.
- ② The guides (embroidery frame size, centerpoint marker, grid and cursor) for the pattern display area can be specified.
- ③ The TOTAL COUNT counter shows the total number of stitches, and the TRIP COUNT counter shows the number of stitches that have been sewn since the machine's last maintenance.
- ④ The TOTAL TIME counter shows the total amount of time that the machine has been used, and the TRIP TIME counter shows the amount of time that the machine has been used since its last maintenance.

Use counters ③ and ④ as a standard for performing periodic maintenance and for receiving maintenance for the machine.

- ⑤ VERSION
Shows the version of the software installed on this embroidery machine



Note

- Check with your local authorized Brother dealer or at www.brother.com for details on available updates.

■ Page 2

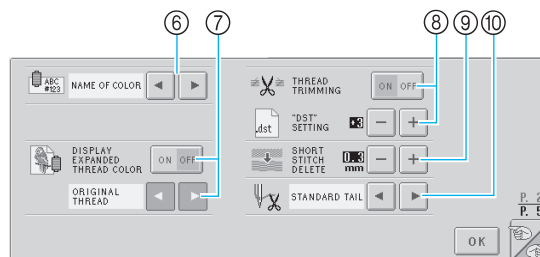

- ⑥ CHANGING THE THREAD COLOR DISPLAY
The color information in the thread color sequence display and the needle bar thread information can be switched to the color name, the thread color number or the sewing time, refer to page 145.
- ⑦ DISPLAY EXPANDED THREAD COLOR
The thread colors displayed in the thread color sequence display and in the needle bar thread information can be displayed as a color from the machine's built-in color thread table, as a thread color from another manufacturer, or as a color that is created with PE-Design ver. 5.0 as an original color chart.
If "ON" is selected, choose from the following three threads, refer to page 146.
Original Thread
Custom Thread 1
Custom Thread 2
- ⑧ THREAD TRIMMING/"DST" SETTING
Specifies whether or not jumpstitches are cut. In addition, when using Tajima embroidery data (.dst), you can specify whether or not the thread is cut according to the specified number of jump codes. (Refer to page 149.)
- ⑨ SHORT STITCH DELETE
Specifies the pitch length of short stitches that are to be deleted, refer to page 150.
- ⑩ THREAD TAIL
Specifies the length of upper thread that remains threaded through the needle after the thread is trimmed (length of thread passed through the eye of the needle), refer to page 150.

■ Page 3

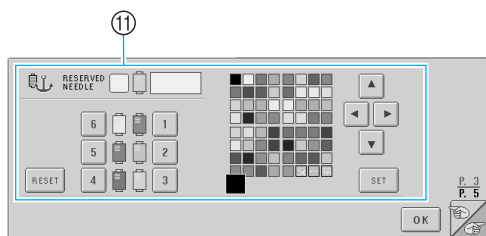

⑪ RESERVED NEEDLE

A certain thread color can be set to a specific needle bar. The specified color remains assigned to the needle bar specified here until the setting is cancelled. For details on specifying these settings, refer to “Reserved Needle Bar Settings” on page 96.

■ Page 4

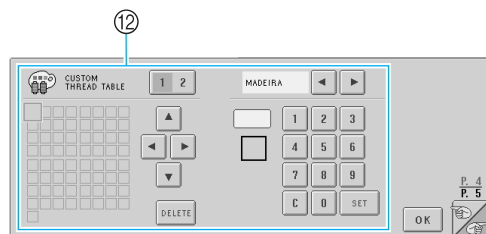

⑫ CUSTOM THREAD TABLE

Create a Custom Thread Table from this page. For details on create a Custom thread table, refer to “Custom thread table settings” on page 147.

■ Page 5

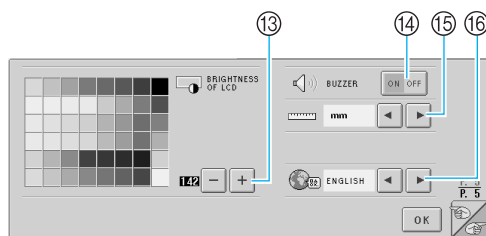

⑬ BRIGHTNESS OF LCD

Enables the density or brightness of the screen to be adjusted.

⑭ BUZZER

Turns the buzzer on or off.

⑮ UNIT

Enables the units of measurements that appear in the screens to be changed.

⑯ LANGUAGES

Enables the display language to be changed. The keys and messages appear in the selected language.

Details of each of the settings are described in the following sections. After specifying the desired settings, touch **OK** to return to the screen that was displayed before the settings screen was displayed.

Adjusting the brightness of the LCD

The brightness of the LCD can be specified from the fifth page of the settings screen.

- 1** Touch **+** and **-** to adjust the brightness of the screen so that the contents of the screens can be clearly viewed.

To make the screen lighter, touch **-**.

To make the screen darker, touch **+**.

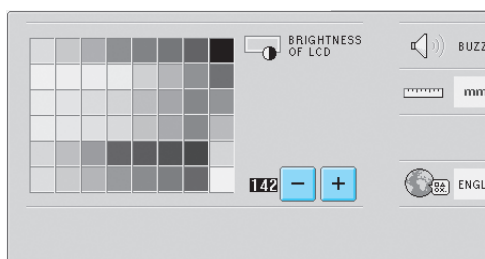

- The number beside **-** indicates the brightness. Move it to the desired setting. When the embroidery machine is purchased, "142" was selected.



Note

- All or part of the display may sometimes become darker or lighter due to temperature changes. This is not a sign of a malfunction. If the display is difficult to read, adjust its brightness. (Refer to "If the LCD cannot be read" on page 213.)
- The display may be dark immediately after the embroidery machine is turned on. This is a normal characteristic of the backlight and is not a sign of a malfunction. After approximately 10 minutes, the display should reach its normal level of brightness.
- If you are not directly facing the display, the colors may be distorted or the display may be difficult to read. This is a normal characteristic of the display and is not a malfunction. Be sure to sit in front of the display while using it. (Refer to "Adjusting the operation panel position" on page 9.)

Turning the buzzer on or off

If "ON" is selected, the buzzer sounds to indicate that a key in the operation panel was pressed or a key on the screen was touched. If an error occurs, the buzzer sounds to notify you of the error.

ON: The buzzer sounds.

OFF: The buzzer does not sound.

When the embroidery machine is purchased, "ON" is selected.

The buzzer setting can be specified from the fifth page of the settings screen.

- 1** Touch **ON OFF** (or **ON OFF**) and select the desired setting.

The key appears as **ON OFF** when "ON" is selected, and it appears as **ON OFF** when "OFF" is selected.



- Each touch of the key turns the setting either on or off.

Changing the language

The display language can be set to any of the following: ENGLISH, GERMAN, FRENCH, ITALIAN, DUTCH, SPANISH, PORTUGUESE, JAPANESE or THAI. When the embroidery machine is purchased, "ENGLISH" is selected. The language setting can be specified from the fifth page of the settings screen.

- 1 Touch  and  to select the desired language.

The desired language is displayed.



Changing the units of measurements

The units of measurements can be set to millimeters or inches. When the embroidery machine is purchased, "mm" is selected. The measurement units setting can be specified from the fifth page of the settings screen.

- 1 Touch  and  to select the desired measurement units.

The desired units are displayed.

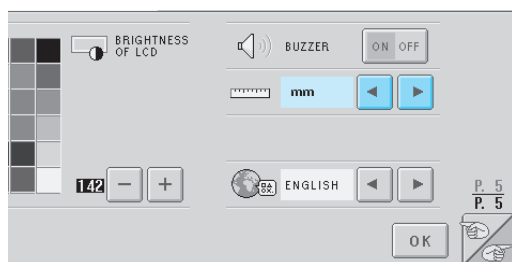

Changing the display guides

Various settings can be specified for the guides in the pattern display area. The embroidery frame size can be selected, and the centerpoint marker, grid and cursor can be displayed or hidden. The guide settings can be specified from the first page of the settings screen.

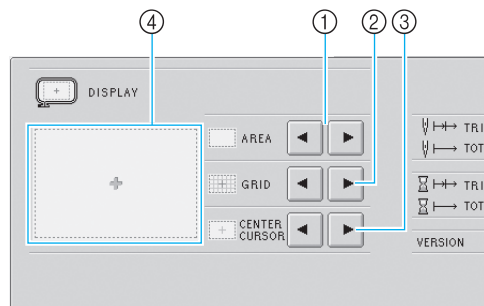

- 1 AREA
Specifies the size of the embroidery frame displayed as a guide in the pattern type selection screen, pattern list screen and pattern editing screen. The guide that appears indicates the size of the embroidery frame that is actually installed.
- 2 GRID
Displays or hides the centerpoint marker of the design (red) and the grid.
- 3 CENTER CURSOR
Displays or hides the needle cursor (green) and specifies the type of cursor.
- 4 How the guides will appear with the specified settings can be previewed here.

■ Size of the embroidery frame

When the embroidery machine is purchased, the extra-large embroidery frame is selected.

- 1 Touch  and  to select the desired embroidery frame size.

The embroidering area for the desired embroidery frame is displayed.

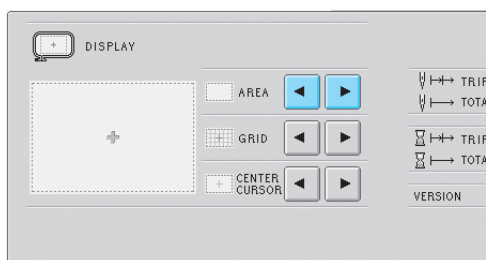

Embroidering area of the extra-large embroidery frame

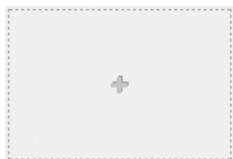

Embroidering area of the large embroidery frame



Embroidering area of the medium embroidery frame

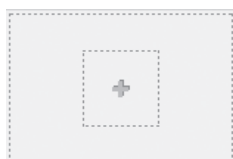

Embroidering area of the small embroidery frame



Embroidery area of the optional cap frame.



Memo

- If the optional cap frame is attached, the embroidering area for the cap frame is displayed, regardless of the setting selected here.

Centerpoint marker and grid

The centerpoint is indicated with a red plus sign (+).

The spacing between the lines of the grid represent 10 mm (3/8 inches).

When the embroidery machine is purchased, only the centerpoint marker is displayed.

- 1 Touch and to select whether or not to display the centerpoint marker and the grid.

The centerpoint marker and grid are displayed as specified.

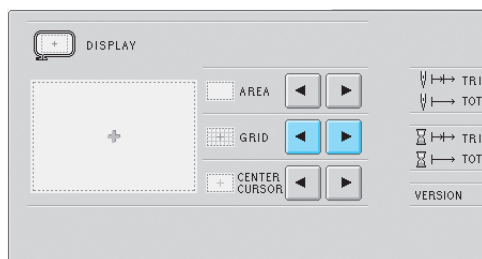

Only display centerpoint marker

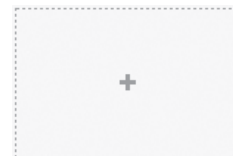

Only display grid

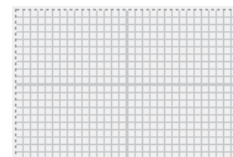

Display both centerpoint marker and grid

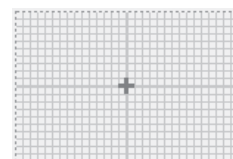

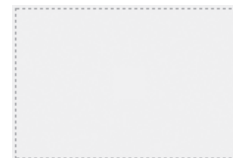

Display neither centerpoint marker nor grid



Center Cursor

The cursor indicates the current needle drop point in the embroidering screen. The center cursor appears in green.

When the embroidery machine is purchased, "Display as plus sign (+)" is selected.

- 1 Touch  and  to select whether to display the cursor as a plus sign (+) or as a large crossbar and whether to display or hide the cursor.

The center cursor is displayed as specified.

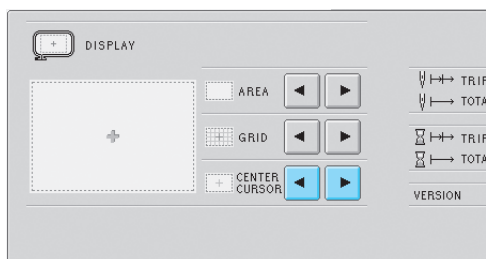

Displayed as a plus sign (+)

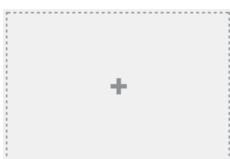

Displayed as a large crossbar



Cursor hidden

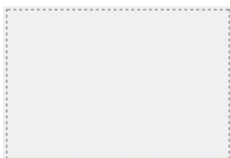

Changing the thread color information

One of eight thread color information categories can be selected for the thread colors information category in the color information for the thread color sequence display and the needle bar thread information.

- Thread color number (Embroidery)
- Thread color number (Country)
- Thread color number (Madeira Poly)
- Thread color number (Sulky)
- Thread color number (Robison-Anton)
- Time

Thread color name (Name of Color)
When the embroidery machine is purchased, the thread color name (Name of color) is selected. The thread color display setting can be specified from the second page of the settings screen.

- 1 Touch  and  to select the desired thread color display.

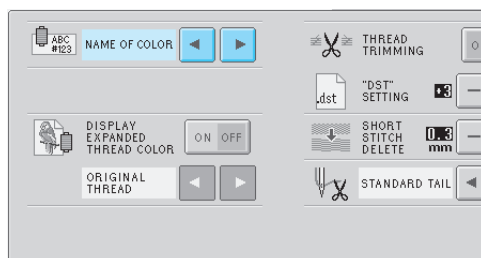

The thread colors will be displayed as specified.

Sample displays

Thread color name
(Name of Color)



Thread color number
(Embroidery)

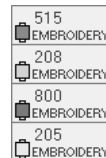

Thread color number (Country)



Thread color number (Madeira Poly)

1770	MA POLY
1951	MA POLY
1637	MA POLY
1980	MA POLY

Thread color number (Madeira Rayon)

1369	MA RAYON
1137	MA RAYON
1037	MA RAYON
1068	MA RAYON

Thread color number (Sulky)

1176	SULKY
1024	SULKY
1037	SULKY
1187	SULKY

Thread color number (Robison-Anton)

9091	R.A
5694	R.A
5678	R.A
5860	R.A

Time

0 MIN	46 SEC
1 MIN	48 SEC
0 MIN	56 SEC
1 MIN	8 SEC



Memo

- The thread colors in the thread color sequence display and in the patterns in the pattern display area are displayed in the original thread color (i.e. the thread colors that have been built-in the machine). The thread color numbers are displayed with the number (or the nearest number) for the brand specified here.

Display expanded thread color

The thread colors displayed in the thread color sequence display and in the needle bar thread information can be displayed as original colors or another manufacturer's thread colors.

ON: If the pattern is created by the PE-Design's "User Thread Chart", the machine will display the color and number specified by the "User Thread Chart". Also, the machine's "Custom Thread Table" will be available. (See below)

OFF: The thread colors are displayed by original thread color.

If "OFF" is selected, the thread colors are displayed as specified in the procedure described in "Changing the thread color information" on page 145.

If "ON" is selected, one of the following three color thread can be displayed in the change thread color screen.

Original Thread

If the thread color has been specified by the "User thread chart" in PE-Design, that color will be displayed. If no thread color has been specified, the machine's built-in color is displayed.

Custom Thread 1

Custom Thread 1, specified with this machine, is displayed.

Custom Thread 2

Custom Thread 2, specified with this machine, is displayed.

For details on the color thread and the color displays, refer to page 163.

When the embroidery machine is purchased, "OFF" is selected.

The thread color setting can be specified from the second page of the settings screen.

- 1 Touch **ON OFF** (or **ON OFF**) and select the desired setting.

The key appears as **ON OFF** when “ON” is selected, and it appears as **ON OFF** when “OFF” is selected.



- Each touch of the key turns the setting either on or off.

- 2 Touch **◀** and **▶** to select the thread.

The desired thread is displayed.



- If “ON” is selected, but a custom thread table is not created, a color thread table with no colors specified is displayed.

Custom thread table settings

The color thread table displayed, for example, when changing the colors of a pattern, can be set to an original color thread table, created by combining the thread color numbers for the thread colors that you like and for the brands that you have. Two CUSTOM THREAD tables can be created.

■ Creating a custom thread

On the fourth page of the settings screen, colors and numbers can be specified for each box in the table.

- 1 Touch **1 2** (or **1 2**) to select the desired thread.

Touch **1 2** to select CUSTOM THREAD 1 or touch **1 2** to select CUSTOM THREAD 2.

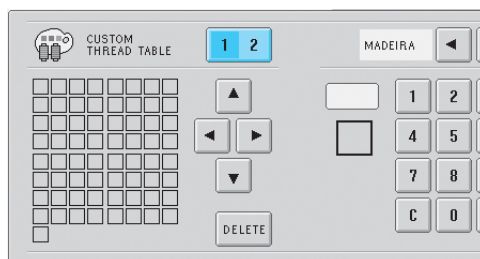

- 2 Select a box in the table.

Touch **▲**, **◀**, **▶** and **▼** until the box that you wish to select appears enlarged.

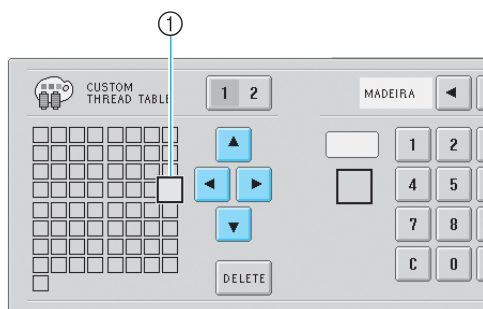

- ① The box that appears enlarged is the box that is selected.
- ▶ Highlighting a color square moves in the direction of the arrow on the key that is touched.

3 Select the thread color number type.

Touch and until the desired thread color number type (brand name) appears.



4 Type in the thread color number.

Touch , , , , , , , , and to type in the desired thread color number.



If the wrong number is entered, touch .



▶ The entered number is erased.

5 Touch .



▶ The entered color and number are specified for the box selected in step [2](#).



To delete the setting, touch .

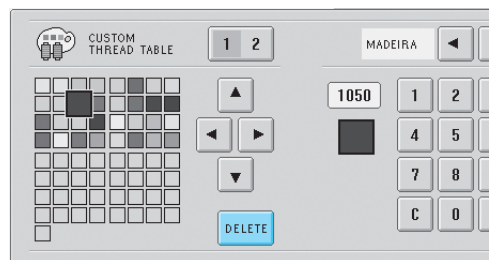

▶ That color is removed from the thread table and the box becomes empty.

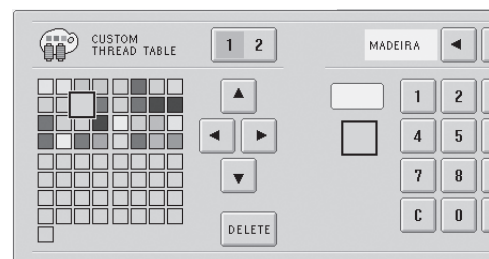

6 Repeat steps 2 through 5 to specify colors for the other boxes.

- To change the color specified in a box, delete the previous color, and then specify a new one.

■ **Changing the color thread table**

Set “DISPLAY EXPANDED THREAD COLOR” to “ON”, and then select the color thread. Refer to page 146.



Specifying jumpstitch trimming / “DST” jump codes for trimming



You can specify whether or not jumpstitches are cut. In addition, when using Tajima embroidery data (.dst), you can specify whether or not the thread is cut according to the specified number of jump codes.

ON: The machine cuts the upper and bobbin thread before the jumpstitch. When Tajima embroidery data (.dst) is used, the machine converts the “jump” code to a trim code, based on the number specified on the next line.

OFF: The machine does not cut either a jumpstitch or the “jump” code in Tajima embroidery data (.dst). When the machine is purchased, “ON” is selected and the number of jumps is set to “3”.

The “DST” thread trim settings can be specified from the second page of the settings screen.

1 Touch  (or ) and select the desired setting.

The key appears as  when “ON” is selected, and it appears as  when “OFF” is selected.

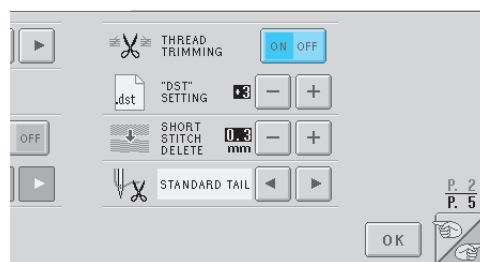

- Each touch of the key turns the setting either on or off.

 **Note**

- This setting is not applied to the trimming of threads between characters in alphabet patterns. (Refer to “Trimming the threads between characters” on page 125.)

 **Memo**

- The number of jump codes cannot be specified for data other than Tajima embroidery data (.dst).

■ When using Tajima embroidery data (.dst)

- 2 If “ON” is selected, touch **+** and **-** to select the number of feed codes.

The desired setting is displayed.

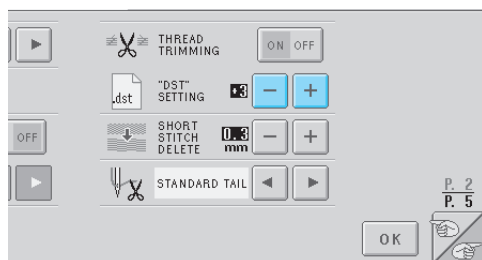

- A value between 1 and 8 can be specified. For example, if 3 is specified, sequential 3 jump codes will be converted to the trim code. But sequential 2 jump code will not be converted to the trim code, it will be sewed as the feed (jump) stitch.



Note

- You need to set the jump number same as the number that was used when the particular Tajima data was created. If the jump number is not matched, either unexpected trim or no trimming at trim expected point will happen.

Deleting short stitches

If embroidery data other than our original patterns is used, the pitch may be too small, which may result in the thread or the needle breaking. In order to prevent this, the machine can be set to delete stitches with a fine pitch. Stitches with a pitch less than that specified here can be deleted.

When the embroidery machine is purchased, “0” was selected (delete stitches with a pitch of 0). The setting to delete short stitches can be specified from the second page of the settings screen.

- 1 Touch **+** and **-** to select the pitch size.
The desired size is displayed.

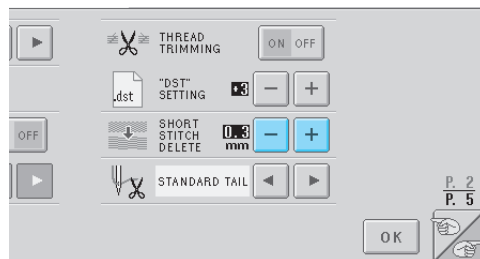

- A value between 0 and 1 millimeters if the units of measurements is set to “mm” (or a value between 0 and 0.04 inch if the units of measurements is set to “inch”) can be specified.

Specifying the remaining length of thread

This setting specifies whether the length of upper thread that remains threaded through the needle after the thread is trimmed (length of thread passed through the eye of the needle) has a standard tail or long tail.

When the embroidery machine is purchased, “standard tail” is selected.

The setting for the remaining length of thread can be specified from the second page of the settings screen.

- 1 Touch **◀** and **▶** to select the setting.
The desired length is displayed.



- If the machine misses stitches with a standard length of thread after it is trimmed, select “Long tail”.
- When using metallic thread, select “Long tail”.

Using the Machine Operations Guide Key

This machine contains information based on the contents of the Operation Manual, such as basic machine operations. Touch  (machine operations guide key), and then select from the four topics that appear to display the available information.

■ Contents of Categories
Names of Machine Principal Parts and Their Functions

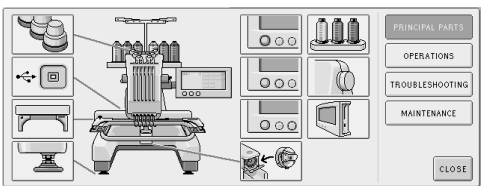

Operations

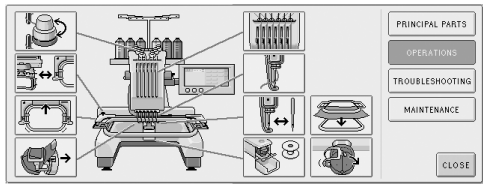

Troubleshooting

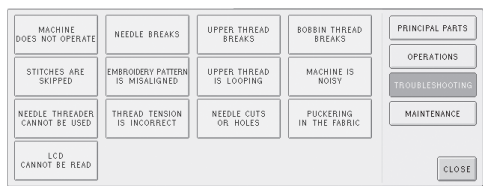

Maintenance

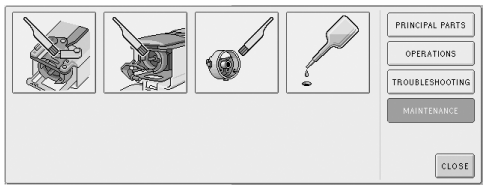

Example: To learn how to thread the upper thread

1 Touch .

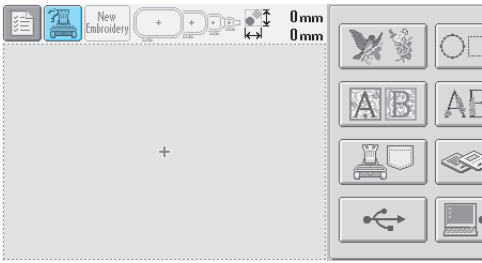

▶ The sewing machine help screen appears.

2 Touch **OPERATIONS**.

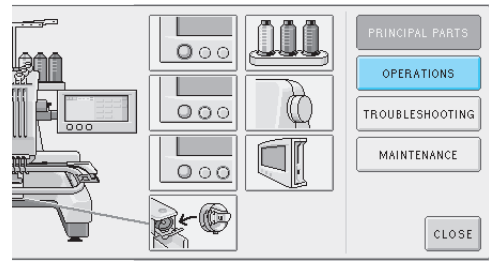

▶ The list of basic operations appears.

3 Touch .

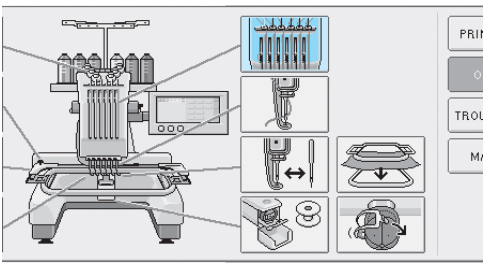

▶ The procedure for threading the upper thread appears.

6

4 Touch  to display the next page.

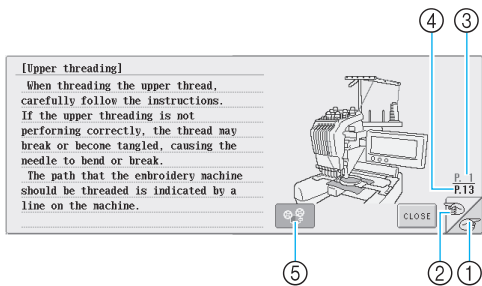



- ① Next page key
Touch this key to display the next page.
- ② Previous page key
Touch this key to display the previous page.
- ③ Current page number
- ④ Total number of pages
- ⑤ Movie key



Appears only if the procedure for

- Threading the upper thread
- Threading the needle
- Replacing the embroidery frame holder
- Attaching the cap frame.

A movie showing the procedure can be viewed.

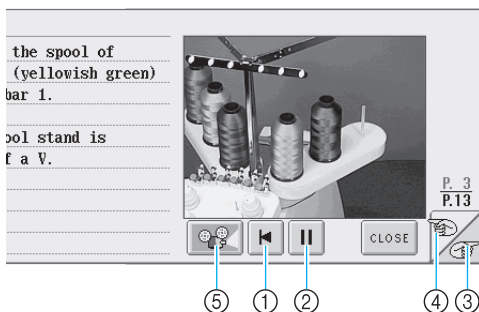
When  changes to , touch the key. While a movie is being shown, the key changes to .



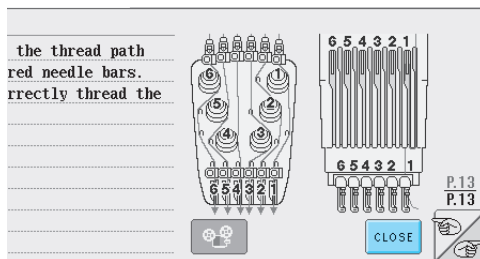

- ① Touch this key to display the movie from the beginning of the current page.
- ② Touch this key to pause the movie. While the movie is paused, the key changes to . Touch  to continue showing the movie.
- ③ Touch this key to skip to the next page of the movie.
- ④ Touch this key to skip to the previous page of the movie.
- ⑤ Touch this key to stop the movie and return to the illustration.

5 After checking the procedure, touch .

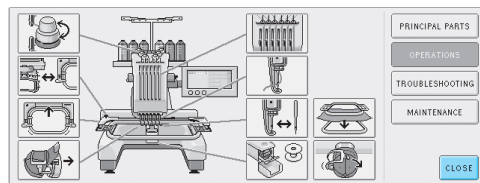

6 Touch .



- ▶ The screen that was displayed before was touched appears. 

Using the Help Key

If help is needed, touch  (help key) to check an operation or to check the function of a key.

■ Example: Viewing help on the function keys in the pattern type selection screen

- 1 Touch  in the pattern type selection screen.

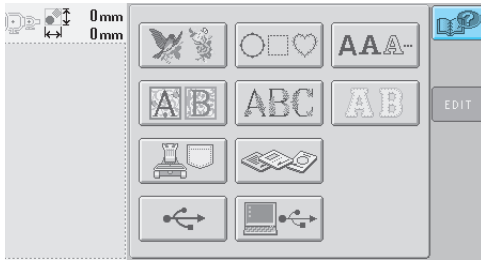

► The help screen appears.

- 2 Touch  and  until the key whose help information you wish to view appears.

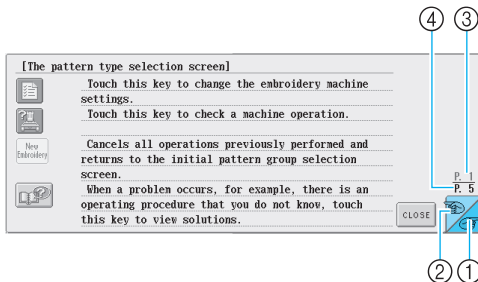

- ① Next page key
Touch this key to display the next page. If the next page key is touched while the last page is displayed, the first page is displayed.
- ② Previous page key
Touch this key to display the previous page. If the previous page key is touched while the first page is displayed, the last page is displayed.
- ③ Current page number
- ④ Total number of pages

- 3 After checking the desired key information, touch .

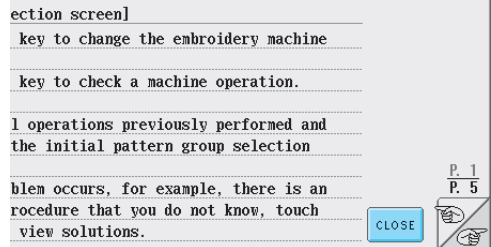

► The screen that was displayed before was touched appears.



APPENDIX

This chapter provides descriptions of techniques for sewing applications, pointers for creating beautiful embroidery, and details on maintenance procedures and corrective measures that should be taken when a problem occurs.



Appliqué Sewing	156
Sewing appliqué patterns / 156	Using a frame pattern to create appliqués (1) / 157
Using a frame pattern to create appliqués (2) / 158	
Helpful Tips for the Operation of the Machine	160
Checking the thread tension of built-in patterns / 160	
Sewing a pattern aligned with a mark on the fabric / 161	
Color thread table / 163	Colors of Tajima (.dst) embroidery data / 163
Creating Beautiful Embroidery	164
Threads / 164	Stabilizers (Backing) / 165
Hooping Techniques / 166	Fabric/stabilizer compatibility chart / 167
OPTIONAL ACCESSORIES	
Attaching an optional embroidery frame for industrial embroidery machines	168
Using the Optional Cap Frame	169
Cap frame and its accessories / 169	Types of caps / 170
Fabric precautions / 171	Preparing to use the cap frame / 171
Attaching the standard cap frame to the mounting jig and putting a cap into the frame / 176	
Attaching the advanced cap frame to the mounting jig and putting a cap into the frame / 180	
Installing the embroidery frame holder / 185	Additional digitizing information / 186
Using the Optional Bobbin Winder	188
Precautions / 188	Optional bobbin winder and its accessories / 188
Setting up the optional bobbin winder / 189	Connecting the AC adapter / 189
Winding the bobbin / 190	
Maintenance	193
Cleaning the LCD / 193	Cleaning the machine surface / 193
Cleaning the hook / 193	Cleaning around the needle plate / 194
Cleaning the bobbin case / 195	Oiling the machine / 196
Troubleshooting	198
On-screen troubleshooting / 198	Troubleshooting / 199
Error messages / 207	If the LCD cannot be read / 213
If the machine does not respond when a key is pressed / 213	
Specifications	215
Embroidery machine specifications / 215	
Index	216

Appliqué Sewing

This section describes the procedure for sewing appliqué.

Sewing appliqué patterns

Some of the built-in embroidery patterns can be used for sewing appliqué. Follow the procedures described below to sew appliqué using the patterns with “Appliqué Material”, “Appliqué Position” or “Appliqué” in the region display at the top of the thread color sequence display.

*Depending on the thread color display setting, the display may appear as  or  or

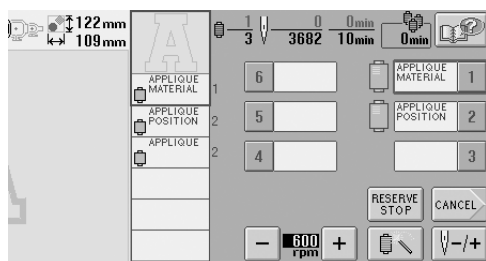

■ Procedure for sewing appliqué

- 1 Place stabilizer on the back of the appliqué fabric.
- 2 Frame the fabric for the appliqué (from step 1) in the embroidery frame, and then sew an “Appliqué Material” pattern. The line that indicates where the appliqué will be cut out is sewn, and then the machine stops.

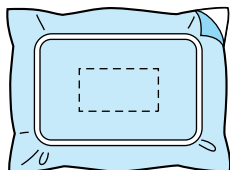

- 3 Remove the appliqué fabric from the embroidery frame, and then carefully cut along the sewn cutline.

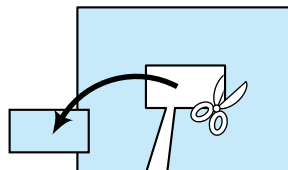

- If the appliqué is cut out along the inside of the sewn cutline, the appliqué may not be correctly attached to the fabric. Therefore, carefully cut out the appliqué along the sewn cutline. If this step is not performed carefully, the appliqué will not be cleanly finished. In addition, carefully remove any excess threads.

- 4 Frame the base fabric in the embroidery frame, and then sew an “Appliqué Position” pattern. The appliqué position is sewn, and then the machine stops.

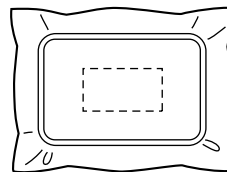

- 5** Lightly apply fabric glue or spray adhesive to the back of the appliqué piece that was cut out, and then attach the appliqué piece to the base fabric at the position sewn using the “Appliqué Position” pattern in step 4.

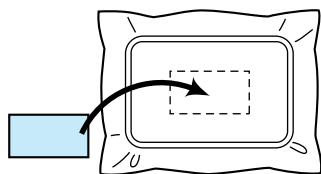

- If an iron-on stabilizer is used to attach the appliqué piece to the base fabric, iron the pieces together without removing the base fabric from the embroidery frame.

- 6** After attaching the appliqué piece, sew an “Appliqué” pattern. The appliqué is finished.

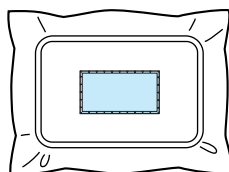

- Depending on the pattern, an “Appliqué” pattern may not be available. In this case, sew the appliqué using thread in the color of a part of the embroidery.

- 7** Finish sewing the embroidery.

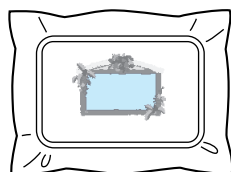

Using a frame pattern to create appliqués (1)

Appliqués can be created by sewing two frame patterns of the same size and shape—one sewn with straight stitches and the other sewn with satin stitches.

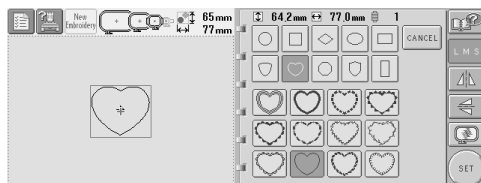

- 1** Select a frame pattern sewn with straight stitches to embroider onto the fabric for the appliqué. Carefully cut outside of the stitching.

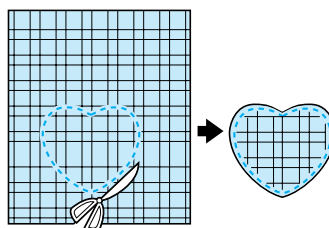

- 2** Embroider the same pattern on the base fabric.

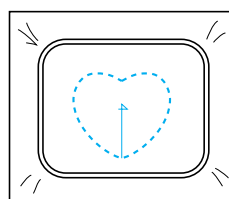

- 3** Lightly apply fabric glue or spray adhesive to the back of the appliqué piece that was cut out in step **1**, and then attach the appliqué piece to the base fabric.

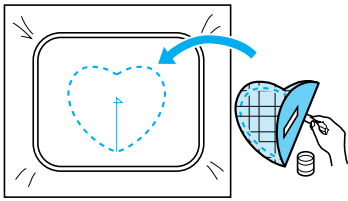

- 4** Select the satin-stitched frame pattern with the same shape to embroider the appliqué attached in step **3**.

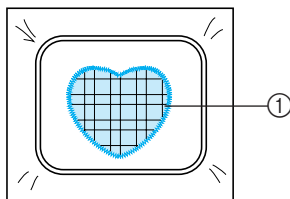
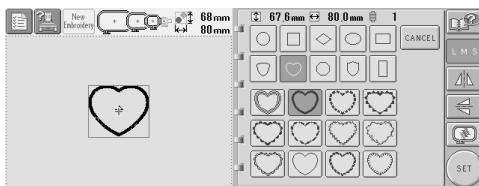

① Appliqué



Note

- If the size or sewing position of the straight-stitched frame pattern is changed, be sure to change the size or sewing position of the satin-stitched frame pattern in the same way.

Using a frame pattern to create appliqués (2)

There is another way of sewing appliqués. With this method, there is no need to change the fabric in the embroidery frame. The appliqué can be created by sewing two frame patterns of the same size and shape—one sewn with straight stitches and the other sewn with satin stitches.

- 1** Select a frame pattern sewn with straight stitches to embroider onto the base fabric.

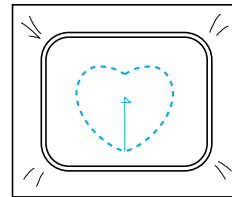
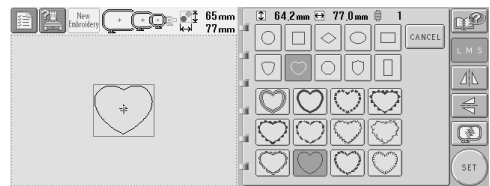

- 2** Place the appliqué fabric over the embroidery sewn in step **1**. Make sure that the area surrounded by the stitching is not larger than the area of the appliqué fabric.

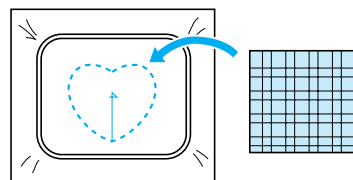

- 3 Embroider over the appliqué fabric using the same frame pattern.**

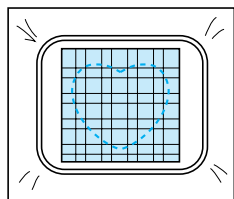

- Be sure to stop the machine before the cross at the center is sewn.

- 4 Remove the embroidery frame from the machine, and then cut off the excess appliqué fabric along the outside of the stitching.**

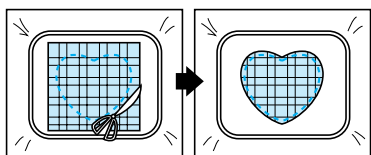

Note

- Leave the fabric in the embroidery frame when cutting off the excess appliqué fabric. In addition, do not apply extreme pressure to the framed fabric, otherwise the fabric could become loose.

- 5 Select the satin-stitched frame pattern with the same shape.**

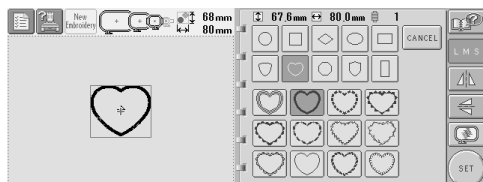

Note

- If the size or sewing position of the straight-stitched frame pattern is changed, be sure to change the size or sewing position of the satin-stitched frame pattern in the same way.

- 6 Attach the embroidery frame removed in step 4, and then finish embroidering the appliqué.**

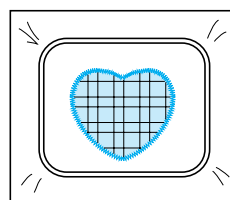

Helpful Tips for the Operation of the Machine

This section provides descriptions to operations useful in the operation of this machine.

Checking the thread tension of built-in patterns

One pattern on the last page of the embroidery patterns can be used to check the thread tension. We will sew this pattern to check the thread tension.



1 Touch  .

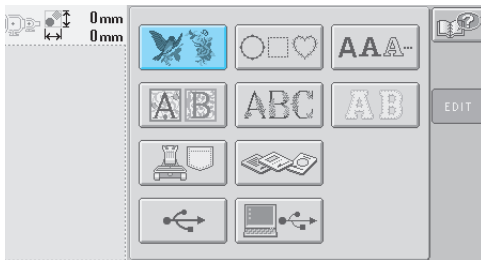

2 Touch  1 times, and then touch .

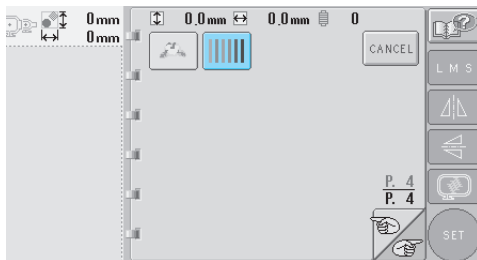

3 Touch .

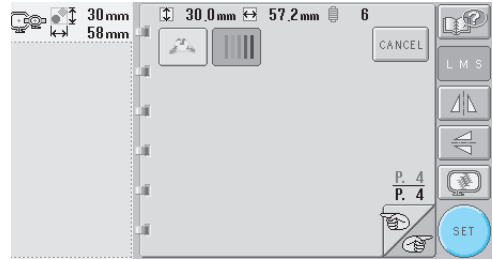

4 Touch .

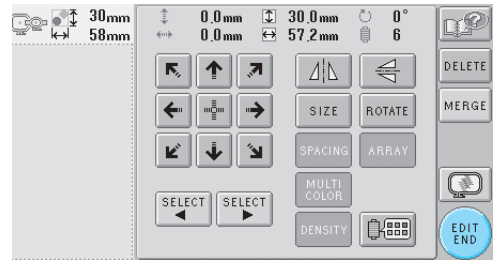

5 Touch .

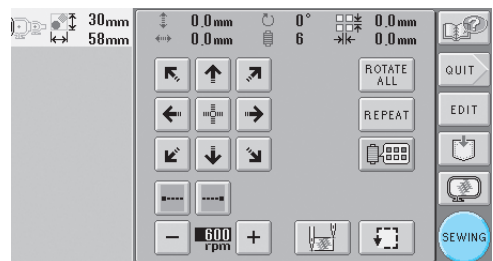

- 6** Touch  (unlock key), and then press the start/stop key to begin embroidering.

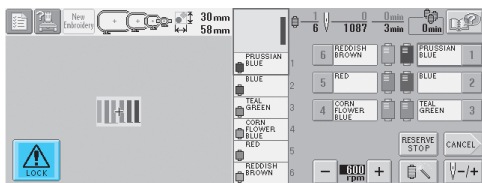

- 7** Correct thread tension. From the wrong side of the fabric, the bobbin thread should be about one third of the stitch width.

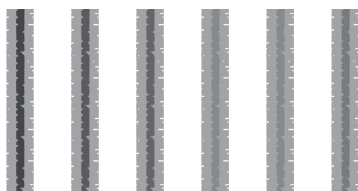

Note

- If adjustment is necessary, refer to instructions on page 45 or 85/86.

Sewing a pattern aligned with a mark on the fabric

By specifying the beginning of stitching and the end of stitching, the exact position of the pattern can be checked.

For example, when sewing text along a line in the fabric pattern, the beginning of the stitching can be set in the lower-left corner so that the position can be checked, and then the beginning of stitching can be reset. Next, the beginning of stitching can be set in the lower-right corner to check the position. The straight line connecting the first point and the second point is the baseline for the text. If the baseline that the text follows leaves the fabric pattern, the embroidering position can be adjusted.

- 1** Touch  in the embroidering settings screen.

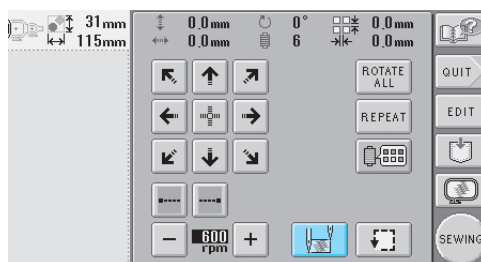

- 2** Set the beginning of stitching in the lower-left corner.

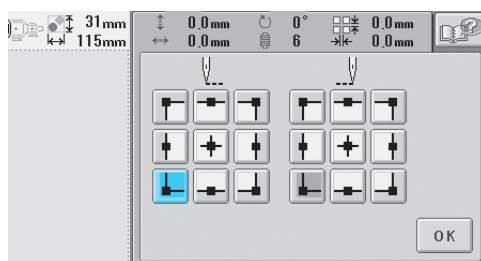

- ▶ The frame moves so that the needle drop point aligns with the beginning of stitching.

7

- 3** With a fabric marker, mark this point on the fabric.

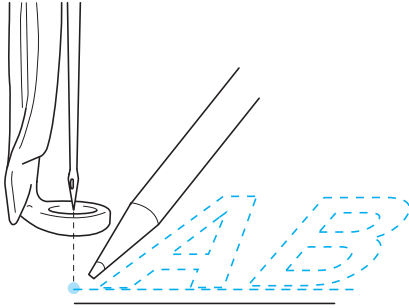

- 4** Set the beginning of stitching in the lower-right corner.

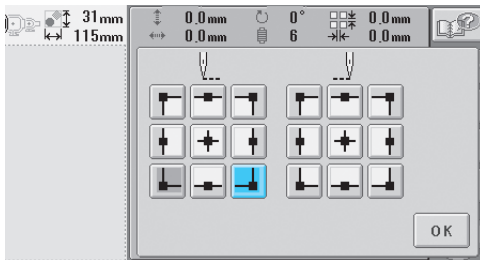

- The frame moves so that the needle drop point aligns with the beginning of stitching.

- 5** With a fabric marker, mark this point on the fabric.

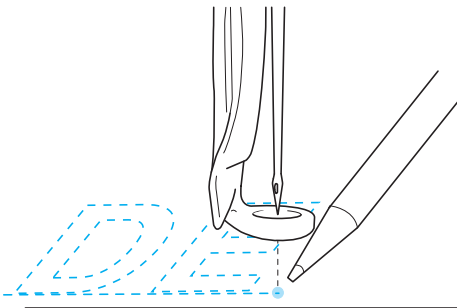

- 6** Remove the embroidery frame from the machine, and then connect these two points to check the embroidering position.

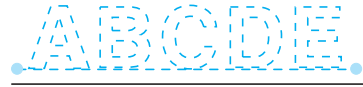

- If the baseline is misaligned or intersects another line, reframe the fabric in the embroidery frame or adjust the position of the pattern.

Color thread table

Additional explanations of the machine's built-in color thread table and the custom thread table are provided below.

Normally, the thread colors in the thread color sequence display and in the pattern display area are displayed in the colors of the machine's built-in color thread table. The thread color numbers with these thread colors are displayed with the thread color number (or the nearest number) for the brand specified on the second page of the settings screen. Therefore, the finished embroidery colors may have a slightly different tinge.

However, since the custom thread table specified on the fourth page of the settings screen are created by specifying thread colors by the thread color numbers and color names from individual brands in the machine's built-in color library, the thread table is displayed with those original thread colors.

If "CUSTOM THREAD TABLE" is selected and "DISPLAY EXPANDED THREAD COLOR" is set to "ON", pattern colors changed using Custom Thread can be previewed with colors nearest to the actual embroidered thread colors.

Create color thread tables from the colors of threads that you have and use them to display the patterns in your own thread colors.

Normal thread color display

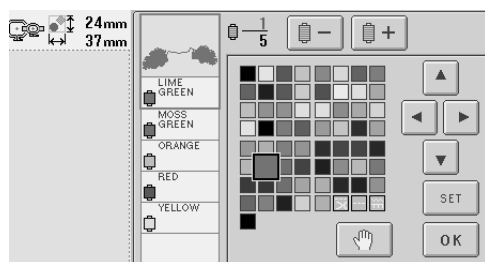

Thread color display using a custom thread

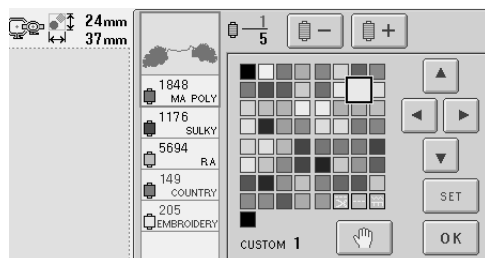

Colors of Tajima (.dst) embroidery data

Tajima data (.dst) does not contain pattern color information. The data is created by combining only shapes.

For example, the following embroidery data appears as shown below in the Tajima format (.dst)

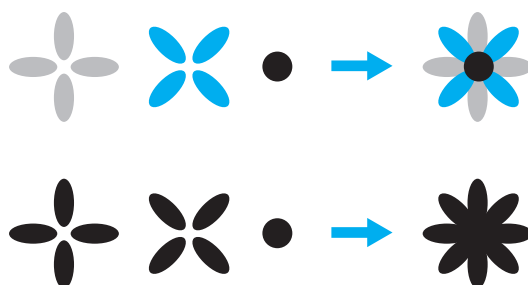

In order for the parts of the pattern to be differentiated when Tajima data is used with this machine, the pattern is displayed with colors automatically applied in the default thread color sequence. Since the thread colors are applied according to the sewing order of the parts, regardless of the design of the pattern, colors may be applied that seem unusual for the design, for example, an orange-colored fruit may be displayed in blue. When using Tajima data, be sure to preview the sewn image on the screen and change the colors from the change thread color screen.

Creating Beautiful Embroidery

The various precautions concerning the thread, embroidery frames and stabilizers (backings) that must be observed in order to create beautiful embroidery are described below.

Threads

Embroidery thread can be costly, therefore caring for it should be a priority. No matter how well a thread is manufactured, it must be appropriately stored if it is to sew properly. This is especially true when one considers the time that lapses between delivery to the thread user and the moment the thread is actually used on the embroidery machine. It is important that embroidery threads be stored in an environment that is free of damaging agents such as excessive heat, light or moisture.

Embroidery threads are best stored in an area that is as clean and dust-free as possible. It is also important that the storage area be free of smoke, fumes and gases. Certain gases may cause the thread to yellow. These fumes originate from such appliances as gas heaters or from gas or diesel engines.

Direct sunlight is also extremely destructive for embroidery threads. Boxes of thread should not be left open and exposed to direct sunlight. If possible, skylights and windows should be diffused. The best type of lighting for embroidery thread is tungsten-filament or fluorescent tubes. It is important to remember that prolonged exposure to these harmful sources may also cause the colors of cardboard boxes and other objects to fade.

Temperature and humidity also pose a threat to embroidery threads. The ideal conditions are between 59 °F and 77 °F (or 15 °C and 25 °C). Humidity should be between 40% and 60%. These conditions should be kept as constant as possible in order to prevent mildew from forming. Excessive temperatures can also cause lubrication problems that ultimately result in thread breaks. Damp conditions can affect paper bobbins as the cardboard will swell and the thread can become oversized. It is also important to realize that even if the overall storage conditions are good, there may be “spot problems” where a thread is exposed to a heat source or bright lights. Ensuring that thread does not become damaged requires that stock be frequently rotated and that threads are not left in the same place for an extremely long time.

Choice of thread is a major factor in improving production time. The thread run ability, strength, consistency and weight all affect output. These qualities determine how well the machine will sew and the number of thread breaks during sewing.

Thread breaks have an important influence on production. Each thread break reduces output by at least 0.07% a day (7.5 hours), assuming that it takes 20 seconds to rethread a needle. For every reduction of 14 thread breaks per a day, output can be improved by more than 1.0 %.

Stabilizers (Backing)

Backing and topping serve to stabilize and support the product being embroidered so the stitches can be sewn with the least amount of interference or instability. They serve as stabilizers for your embroidery work. Without the proper type of stabilizer, the fabric may move too much within the embroidery frame causing poor alignment of the embroidery. At times, topping will be required in order to manage fabrics with a pile-like surface, such as towels, corduroy and pique knit. There are many types of backing and toppings with various weights for the various fabrics that you may be sewing.

There are four types of stabilizers (backing) that can be used in embroidery: cut-away, tear-away, water soluble and self-adhesive. In these four types, various weights, sizes and textures are available. When selecting the stabilizer type for a particular fabric, consider the design size in addition to the stitch count and stitch type used in the design.

Finally, make sure that the stabilizer is not stretched. Some backings may not stretch vertically or horizontally but may stretch diagonally. **DO NOT USE THESE TYPES.** This type of backing will stretch during sewing and may cause the design to shift.

1. Polyester mesh cut-away stabilizer works extremely well with light-colored fabrics since it prevents a shadow from showing through on the front after you have trimmed away the excess. This type of backing is ideal whenever you need stability with a light and soft touch in your finished product, for example, with baby garments.
2. Cut-away stabilizer is excellent for medium- to heavyweight knits, however it can also be used on woven material. It will hold a large number of stitches and with two or three layers can hold a tremendous amount of stitches. This type of backing is also available in black for those who want the inside of their garments to look as good as the outside. Black stabilizer is very useful on similarly colored garments of lightweight fabrics. The black backing is less likely to show through as compared to white backing.

3. Self-adhesive (peel-and-stick) backing is used on those difficult-to-hoop fabrics. This backing is applied (with sticky side up) to the underside of the frame, enabling your fabric to “stick on” the exposed surface in the sewing areas. When the embroidery is finished, the fabric can be removed, the excess backing can be disposed of and the process repeated.
4. Tear-away stabilizer can be used on mediumweight woven fabrics and sturdy fabrics such as canvas, poplin and denim. This stabilizer will hold many stitches especially when used in two or more layers. This type of stabilizer is made of a non-woven material that enables it to easily be torn away from the edges of your embroidery design when it is completed. This stabilizer is also available in black.
5. Water-soluble stabilizer is useful when you need to keep the nap or pile, for example, on towels, from interfering with the placement of stitches. Fabrics such as terry cloth, corduroy, velvet and faux fur are examples of materials that have a nap or pile that can actually penetrate embroidery stitches as your machine sews. The result is an unfinished and often sloppy appearance when fibers of the fabric poke out between the finished stitches of an embroidery design. In these situations, water-soluble stabilizer is used as a topping to hold the fibers of the fabric flat so the stitches can be placed on top neatly and accurately. Water-soluble stabilizer is also used as a backing when stitching lace or other motifs where the desired result is only the stitching. This is accomplished with water-soluble stabilizer, which can easily be pulled off of the fabric after embroidering is completed and any remnants can be easily be dissolved with water. Water-soluble stabilizer is also used as a backing on towels, where you often need some stabilization, but any remnants of a formal backing must not be visible in the finished product.

Hooping Techniques

“Use the right tool for the right job” is a statement many of us have heard throughout the years. This statement holds true even in the embroidery industry. The wrong size or type of embroidery frame may result in poor design alignment during sewing or damage the product altogether. You can take a perfectly created design and ruin the final results by simply not using the correct frame size, type or technique designed for its application.

■ Frame Basics

Tubular frames: This type of frame allows tubular fabric or pre-assembled garments to be placed around the hook assembly. It allows embroidering of the front of a garment without stitching through the back of it.

Cap frames: These are specialized embroidery frames (hoops) designed to hold caps for embroidering. They are available in a variety of styles for various machines, with two basic styles: one that allows sewing a flattened cap (for use on a flat machine) or one that allows sewing the cap in its natural curved shape (for use on a tubular machine).

Hooping fabric: The framed fabric and backing should be perfectly flat and free of wrinkles or bubbles. If there are bubbles or wrinkles that must be removed, be sure that you pull on the fabric and backing together. Pull no more than is necessary to make the fabric flat and smooth. Overstretching the fabric during this process may cause puckers around the finished design when the frame is removed. Gaps may also be generated between design parts.

Inner/outer frame positioning: There should be a slight ridge (3 mm (1/8 inch)) of fabric and backing below the outer frame on the back side. Tighten the screw only if the inner frame feels loose. Avoid overtightening the screw as this will cause puckers in the fabric and may “strip” the screw.

Fabric/stabilizer compatibility chart

Fabric/ Garment	No. of Backing Pieces	No. of Topping Pieces	Comments
Terry cloth	1 tear-away	1 water-soluble	Increase density and/or satin stitch width. Fine details and small lettering tend to get caught in the terry loops.
Satin jacket	Heavy lining: None Light or no lining: 1 tear-away	None	If garment slips in frame, causing alignment problems, wrap inner frame with masking tape or fabric bias tape. This provides a rough surface to grip garment and also helps minimize frame burn.
Cotton sheeting	1 tear-away	None	High-density or highly detailed designs may require more backing. If so, use two pieces of lightweight backing instead of one piece of heavy backing.
Denim	1 tear-away	None	Reduce speed if needle begins to heat up and the thread breaks.
Headwear	Optional	Optional	Change needles more often than usual because the buckram backing dulls needles faster. A lightweight tear-away backing helps reduce thread breaks and regulates thread tension. Use a topping on corduroy or foam cap fronts.
Dress shirt (woven)	1 tear-away	None	High-density or highly detailed designs may require more backing. If so, use two pieces of lightweight backing instead of one piece of heavy backing.
Golf shirt	1 cut-away	Optional	Use topping for designs containing small lettering or a lot of detail, and also for pique knits.
Canton fleece	1 tear-away	Optional	Use a topping if the garment has a textured surface, such as a basketweave or pronounced twill.
Canvas	1 tear-away	None	Frame tightly
Corduroy	1 tear-away	1 water-soluble	A higher stitch density or more understitches, as well as a topping, may be necessary to prevent stitches from sinking into the fabric.
Lingerie or silk	1 or 2 lightweight tear-away	Optional	Reduce sewing speed. The thread tension should be low. Use topping for designs with high detail or small lettering. For very fine fabrics, use a thinner thread. Avoid extremely narrow satin stitching on letters or details; instead increase satin stitch width or use a bean stitch. Gently remove (don't pull) backing and topping from garment.
Sweater knit	1 cut-away or adhesive tear- away	1 water-soluble	Use tightly woven organza or curtain fabric in a matching color as a backing for bulky or "holey" knits.
Sweatshirt	1 cut-away or adhesive tear- away	Optional	Highly detailed designs may require two layers of lightweight cut-away stabilizer. Use a topping on extra-thick fabrics or with fine-detail designs.
T-shirt	1 light-weight cut- away or adhesive tear-away	Optional	Use a topping on designs with fine detail or small lettering. Tensions should be light. Avoid stitch-heavy designs.

OPTIONAL ACCESSORIES

Attaching an optional embroidery frame for industrial embroidery machines

Prepare the embroidery frame holder in order to attach the embroidery frame for industrial embroidery machines.

When the embroidery frame for industrial embroidery machines is attached, both the left and right arms of the embroidery frame holder moves.

1 Remove the embroidery frame. (Refer to page 46.)

2 Loosen the two thumb screws on the embroidery frame holder.

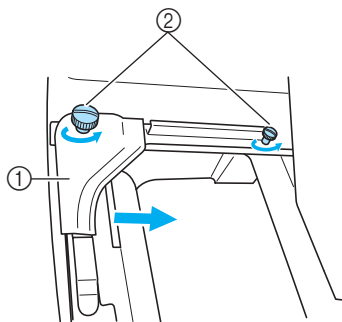

① Left arm

② Thumb screws

► The left arm of the embroidery frame holder can be moved.

- Only loosen the thumb screws a maximum of 2 turns counterclockwise. Do not remove the screw.

3 Move the left arm to align the screw on the right side with the mark for the embroidery frame for industrial embroidery machines, and then tighten the thumb screws.

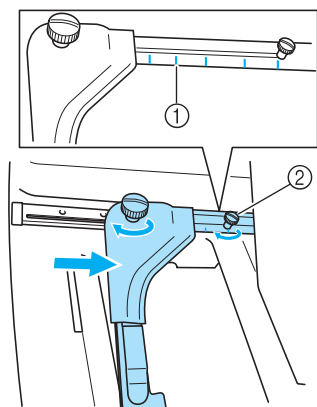

① Mark for embroidery frame for industrial embroidery machines

② Align the screw with the mark.

4 Using a Phillips screwdriver, loosen the two screws, and then remove them.

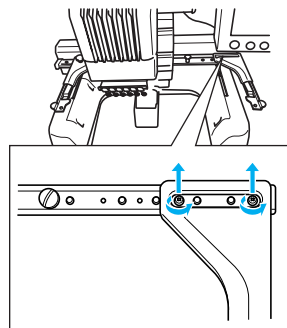

5 Remove the right arm, align the pins on the embroidery frame holder with the holes in the arm, as shown in the illustration, and then insert the screws removed in step 4 and tighten them.

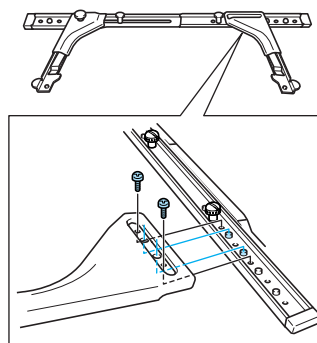

- The embroidery frame holder is ready for the embroidery frame to be attached. Attach the embroidery frame for industrial embroidery machines in the same way that enclosed embroidery frames are attached. (Refer to page 30.)

Note



- When using embroidery frames for industrial embroidery machines, THE MACHINE DOES NOT RECOGNIZE THE SEWING AREA OF THE FRAME. Be sure to use the trial sewing function to check that the pattern fits within the sewing area.

Using the Optional Cap Frame

By using the optional cap frame, patterns can be embroidered onto caps and hats. The procedures for using the cap frame are described below.

Cap frame and its accessories

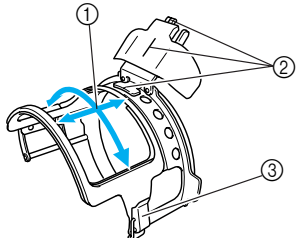
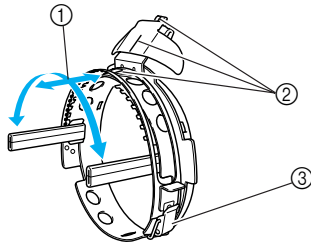
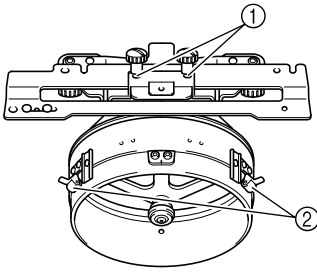
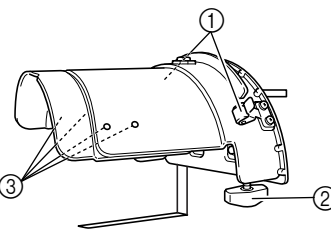
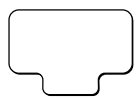
The cap frame driver and the mounting jig are required in order to use the cap frame.

<p>Cap frame</p> <p>① Embroidering area: 50 mm (H) × 130 mm (W) (2 inches (H) × 5-1/8 inches (W))</p> <p>② The mark indicates the center of the embroidering area.</p> <p>③ Snap lock</p> <p><Standard type></p>  <p><Advanced type></p> 	<p>Cap frame driver and 4 thumb screws</p> <p>In order to attach the cap frame to the carriage, remove the embroidery frame holder, and then attach this cap frame driver to the carriage of the machine.</p> <p>① Insert the thumb screws into these holes and tighten the screws to secure the movable section. Use these holes when storing this cap frame driver.</p> <p>② Holding Spring The cap frame is secured by the two holding Spring.</p>	
	<p>Mounting jig</p> <p>Use when framing a cap in the cap frame.</p> <p>① Holders The cap frame is secured by the two holders.</p> <p>② Mounting bracket Tighten thumb screw to secure to mounting surface.</p> <p>③ Screws Adjust the size of the mounting jig according to the type of cap being embroidered.</p>	
<p>Pad</p> 	<p>Allen screwdriver (large)</p> 	<p>Allen screwdriver (medium)</p> 
<p>* Use when adjusting the ring of the cap frame driver and the height of the L-shaped bracket. (Refer to page 173.)</p>		



Memo

- Before installing the cap frame, be sure to adjust the ring of the cap frame driver and the height of the L-shaped bracket. (If the same machine is being used, this adjustment is only required the first time that it is used. In addition, this adjustment is not necessary if the enclosed cap frame is installed.)
- After the ring of the cap frame driver and the height of the L-shaped bracket have been adjusted, they must be adjusted again if a different machine is being used. The height may differ depending on the machine that is used. For details, contact your sales representative.



Note

- If the cap embroidery frame is attached, the embroidery frame indicators, showing which embroidery frames can be used, appear as shown below.



Types of caps

With the machine, we recommend that the following types of caps be embroidered.

Standard(Pro Style)

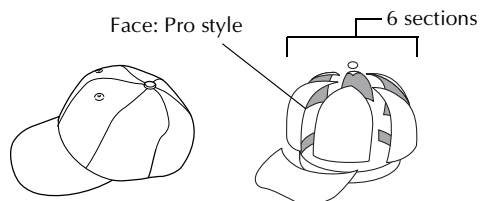

Otto International, Inc. cap model number (Example)	OTTO27-007	
Mesh backing on the back of front panels (soft or hard)	Constructed firm front	Unconstructed soft crown
Ease of framing (hooping)	Easy (Recommended)	Fairly easy
Backing	1 to 2 ply	2 to 3 ply

Low Profile (Low fitting)

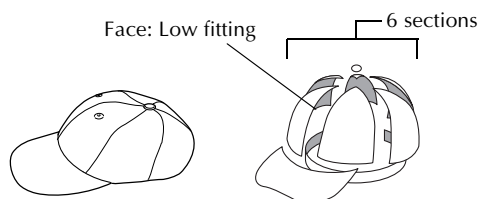

Otto International, Inc. cap model number (Example)	OTTO23-225	OTTO18-203
Mesh backing on the back of front panels (soft or hard)	Constructed firm front	Unconstructed soft crown
Ease of framing (hooping)	Very difficult (because the cap material very hard.)	Fairly easy
Backing	1 to 2 ply	2 to 3 ply

Golf Style

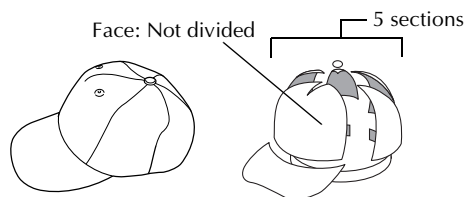

Otto International, Inc. cap model number (Example)	OTTO23-225	
Mesh backing on the back of front panels (soft or hard)	Constructed firm front	
Ease of framing (hooping)	Fairly easy	
Backing	1 to 2 ply	

Memo

- Check if this area ① is covered with mesh.

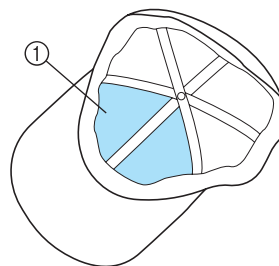

Note

- There is no centerline that can be used as a guide for placing the cap in the cap frame. Before framing the cap, use a charcoal pen to mark the centerline.

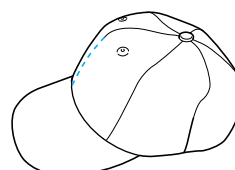

■ Cap fabric not recommended for embroidering

- Caps with a front panel that is less than 50 mm (2 inches) high (such as a sun visor)
- Children's caps
- Caps with a brim that is longer than 80 mm (3-1/16 inches)

Fabric precautions

■ Cap fabric recommended for embroidering

- 35% Cotton / 65% Polyester
- 100% Cotton
- 80% Wool / 20% Nylon
- 15% Wool / 85% Acrylic

■ Cap fabric not recommended for embroidering

If caps of the following types of fabric are used, they will be very difficult to frame, easily wrinkled, or easily shrink.

- Polyester Foam
- Stretch material
- Melton Wool
- 100% Nylon
- Suede

Preparing to use the cap frame

■ Installing the cap frame driver

Press  →  →  →  →

 in order to view a video of the operation on the LCD (see page 151).

Remove the embroidery frame holder from the carriage on the machine, and then install the cap frame driver. Before removing the embroidery frame holder, remove the embroidery frame. (Refer to "Removing the embroidery frame" on page 46.)

1 Loosen and then remove the two thumb screws and the embroidery frame holder.

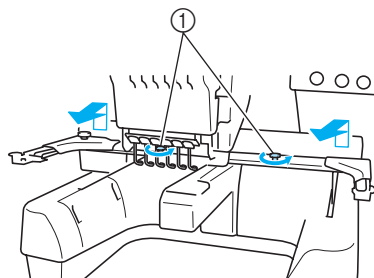

- ① Thumb screws
- The removed thumb screws remain attached to the embroidery frame holder.

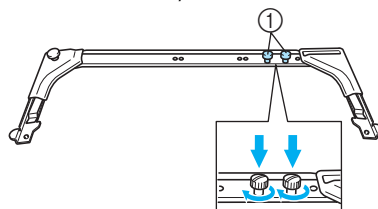

- ① Put the two thumb screws back in the embroidery frame holder.

2 Remove the two upper thumb screws of the cap frame driver and set aside. Loosen the two lower thumb screws (4 turns).

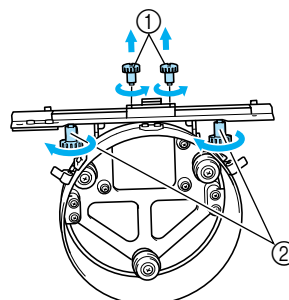

- ① Upper thumb screws
- ② Lower thumb screws

- 3** Pass the machine bed through the ring of the cap frame driver.

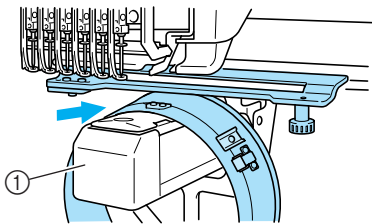

① Machine bed



Note

- Be careful that the cap frame driver does not hit any nearby parts, such as the presser foot.

Attach the cap frame driver to the carriage as described below in steps **4** through **6**.

- 4** Insert the two thumb screws at the bottom of the cap frame driver into the v-cuts in the carriage, and then place the mounting plate of the cap frame driver on top of the frame-mounting plate of the carriage.

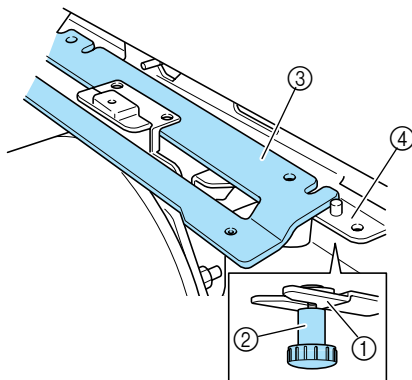

① Notch in the carriage
② Thumb screw of the cap frame driver
③ Mounting plate of the cap frame driver
④ Frame-mounting plate of the carriage

- 5** Insert the pins on the frame-mounting plate of the carriage into the holes in the mounting plate of the cap frame driver.

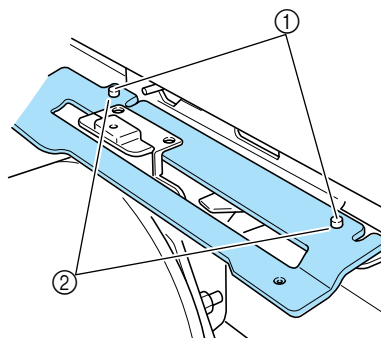

① Pins on the frame-mounting plate of the carriage
② Holes in the mounting plate of the cap frame driver

- 6** Insert and tighten the two upper thumb screws in outer holes of mounting plate of cap frame driver.

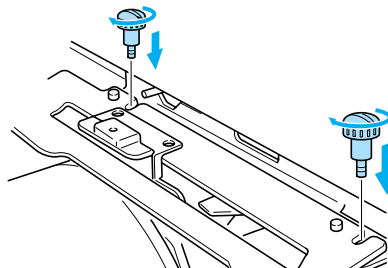

- 7** While pushing in the cap frame driver toward the machine so that it is fully inserted, tighten the two lower thumb screws to secure the cap frame driver.

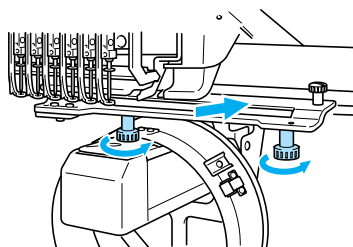

- This completes the installation of the cap frame driver.

■ Adjusting the cap frame driver

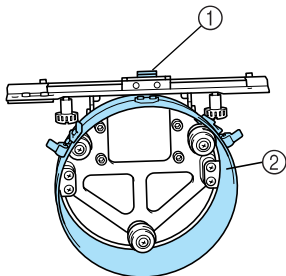

- ① L-shaped bracket
- ② Ring



Memo

- If the same machine is being used, the adjustment to the cap frame driver is only required the first time that the machine is used.

- 1 Turn on the machine. After the carriage moves to its initial position, turn off the machine.



Note

- Be sure to adjust the cap frame driver with the carriage at its initial position.

- 2 Using the Allen screwdriver (medium), loosen the two hexagonal screws. Loosen the screws only by about one turn.

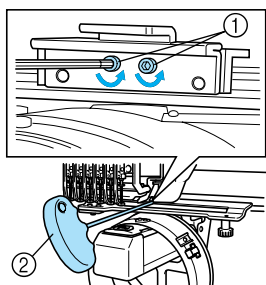

- ① Hexagonal screws
- ② Allen screwdriver (medium)



Note

- Do not loosen them too far.

- 3 Lower the L-shaped bracket to make it touch the machine bed and then tighten the two hexagonal screws using the Allen screwdriver (medium). Firmly tighten the screws.

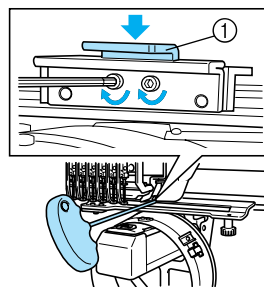

- ① L-shaped bracket

- 4 Using the Allen screwdriver (large), loosen the four hexagonal screws on the inside of the ring. Loosen the screws only by about one turn.

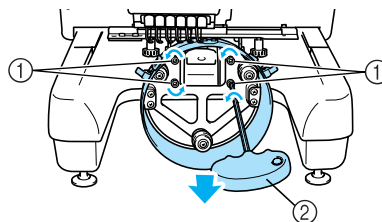

- ① Hexagonal screws
- ② Allen screwdriver (large)

- ▶ When the screws are loosened, the ring can be lowered.



Note

- Do not loosen them too far.

- 5** Insert the pad between the machine bed and the ring of the cap frame driver.

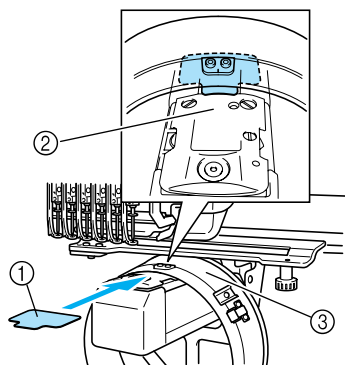

- ① Pad
- ② Machine bed
- ③ Ring of the cap frame driver

- 6** Lightly press down the ring, and then use the Allen screwdriver (large) to tighten the four hexagonal screws on the inside of the ring. Firmly tighten the screws.

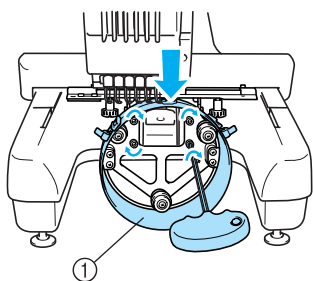

- ① Ring

! CAUTION

- Make sure that each hexagonal screw is firmly tightened. If any screw remains loosen, injuries may result.

- 7** Remove the pad inserted in step 5.

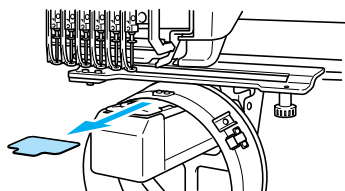

■ Installing the needle plate spacer

Attach the needle plate spacer to the needle plate.

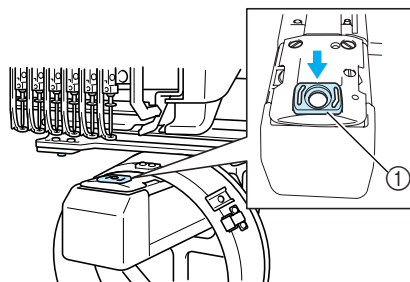

- ① Needle plate spacer

■ Preparing the mounting jig

Lower the stopper, and then attach the mounting jig to a stable surface, such as a desk.

- 1** Use a Phillips screwdriver to loosen the two screws, and then lower the stopper in the direction of the arrow.

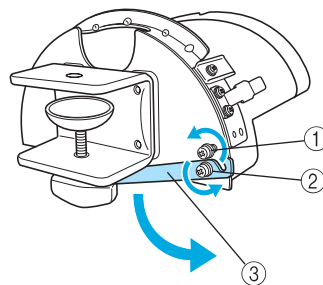

- ① Loosen the screw so that the stopper can be hooked onto the screw and clamped with it.
- ② Loosen until the stopper moves.
- ③ Stopper

- 2 Tighten the two screws.**
- Make sure that the stopper is firmly secured.

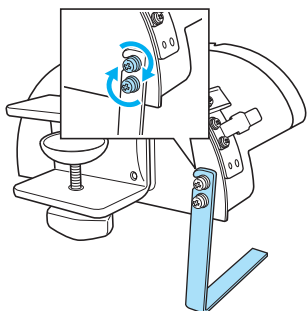

Attach the mounting jig to a stable mounting surface, such as a desk.

- 3 Loosen the thumb screw for the mounting jig to open the mounting bracket so that it is wider than the thickness of the mounting plate.**

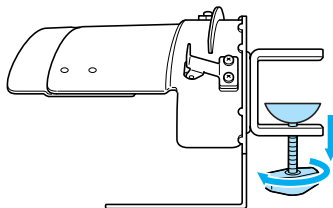

- The mounting bracket can be mounted onto a plate with a thickness from 9 mm (3/8 inch) to 38 mm (1-1/2 inches).

- 4 Securely clamp the mounting bracket onto the mounting surface by tightening the thumb screw.**

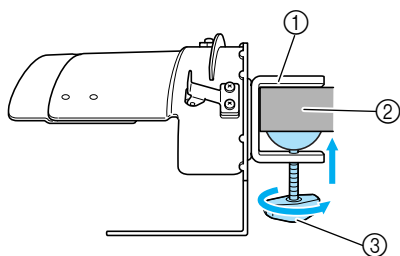

- ① Mounting bracket
- ② Mounting surface
- ③ Tighten thumb screw

- 5 Check that there is no looseness.**
- If there is looseness, mount the mounting jig onto the mounting surface again.

Note

- Be sure that the mounting bracket is securely clamped onto the mounting surface and that the thumb screw is firmly tightened.
- Do not attach the mounting jig to an unstable surface (flexible, bent or warped).
- Be careful that the mounting jig does not fall when it is removed.

- 6 Adjust the size of the mounting jig according to the type of cap being embroidered.**

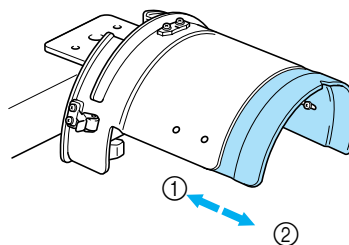

- ① Low Profile (Low fitting)
- ② Standard (Pro style)

Note

- Either the standard type cap frame or the advanced type cap frame can be used in the standard position. Only the advanced cap frame can be used in the low profile position.

■ For the standard type

Using a Phillips screwdriver, turn the four screws (two on the left and two on the right) at the inside of the mounting jig one turn to loosen them.

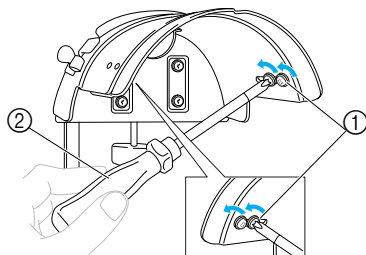

- ① Screws
- ② Phillips screwdriver



Note

- Do not remove any of the four screws (two on the left and two on the right); otherwise, they may be lost. Only turn the screws to slightly loosen them.

Pull the mounting jig toward you, and then use the Phillips screwdriver to tighten the four screws (two on the left and two on the right).

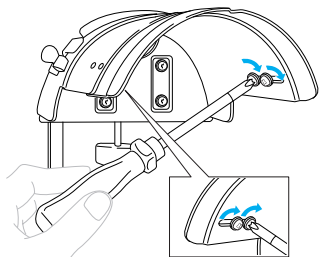

- ▶ This completes the preparation of the mounting jig.

Attaching the standard cap frame to the mounting jig and putting a cap into the frame

Press  → OPERATIONS →  →  →

 in order to view a video of the operation on the LCD (see page 151).

Put the cap into the standard cap frame attached to the mounting jig, and then remove the standard cap frame from the mounting jig with the cap clamped. Next, attach the standard cap frame to the cap frame driver on the machine.

1 Attach the standard cap frame to the mounting jig.

Align the notch in the standard cap frame with the guiding plate on the mounting jig, and then snap the frame into place.

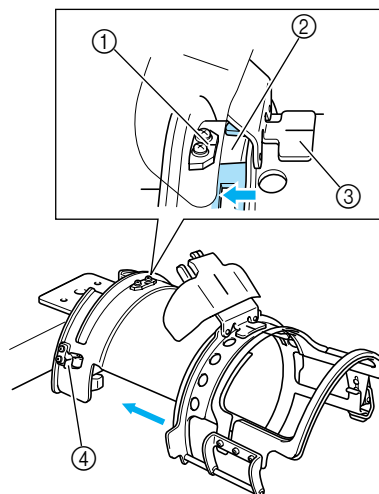

- ① Guiding Plate on mounting jig
- ② Notch on standard cap frame
- ③ Sweat guard holder
- ④ Holder

- ▶ The standard cap frame is secured with the two holders (clips) one on right side and one on left side.



Note

- Make sure that the mounting jig is set to the standard position.

- 2** Release the snap lock on the standard cap frame down and then disengage the latch. Open the clamping frame. Also, open brim presser.

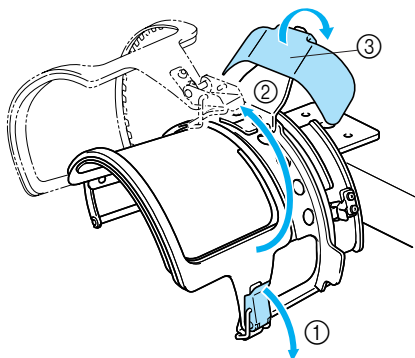

- ① Snap lock released
- ② Clamping frame opened
- ③ Brim presser

- 3** **Placing a sheet of stabilizer.** Placing a sheet of about 100 mm (4 inches) x 250 mm (10 inches) of stabilizer on top of the lower frame, place a cap in the frame.

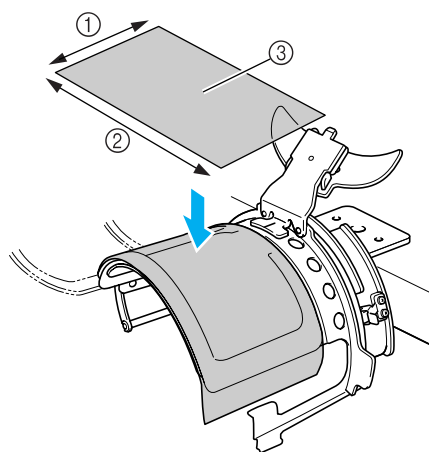

- ① 100 mm (4 inches)
- ② 250 mm (10 inches)
- ③ Stabilizer

- 4** **Lift up (flip) the sweat guard on the inside of the cap, and then place the cap in the standard cap frame.**

Using both hands, hold both sides of the cap, and then align the edge of the lower frame with the base of the brim.

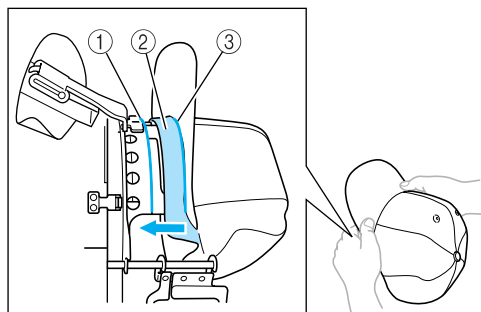

- ① Edge of the lower frame
- ② Sweat guard
- ③ Base of the brim

At the same time, align the centerline of the cap with the centerline of the sweat guard holder on the standard cap frame, and then slide the sweat guard under the sweat guard holder.

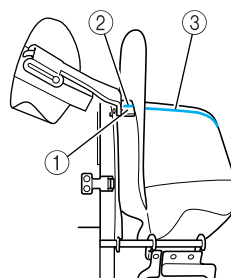

- ① Sweat guard holder
- ② Centerline of sweat guard holder
- ③ Centerline of cap

- 5** **After arranging the brim, firmly push in the cap as far as possible.**

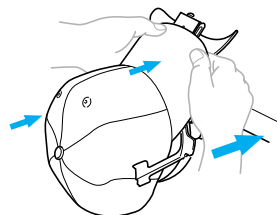

7

- 6** Close the clamping frame, and then hook the catch of the snap lock to temporarily secure it.

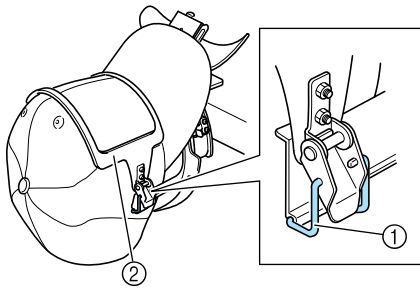

- ① Catch of the snap lock
② Clamping frame

Check for the following conditions.

- ① The centerline of the cap is parallel with the short side of the clamping frame.
- ② The line on the left side of the cap cannot be seen within the clamping frame.
- ③ The teeth on the inside of the clamping frame cleanly grab the base of the brim.
- ④ The centerline of the brim holder and the center line of the cap must make a single straight line.

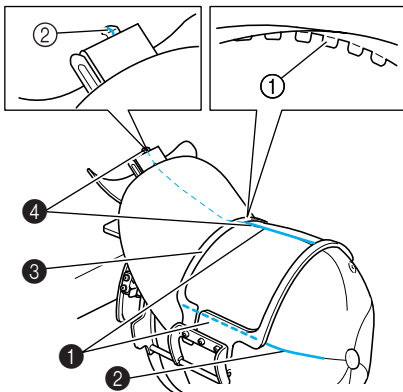

- ① Teeth on the inside of the clamping frame
② Centerline of brim holder

Memo

- According to the shape of the cap, loosen the screw ④ and adjust the position of the clamping frame ③ so that the teeth on the inside of the clamping frame ① align with the base of cap brim ②.

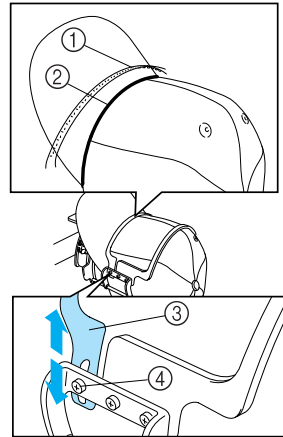

Memo

- If the cap fabric is thick and the clamping frame cannot be closed, or if the fabric is thin and the cap is too loose within the frame, adjust the clamping frame.

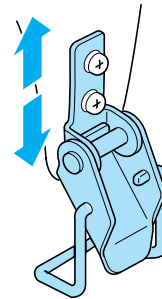

- 7** While pulling the cap down with one hand, pull the lever of the snap lock to securely close it.

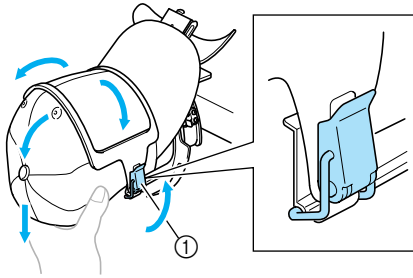

① Lever of the snap lock



Note

- Make sure that there are no wrinkles within the clamping frame. Otherwise miss alignment will occurred.

- 8** While again pulling on the fabric around the cap frame to stretch it, adjust the embroidering position.

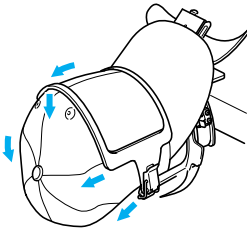

- 9** Pull the brim holder up as far as possible. Next, turn the brim holder over the cap brim, and then lower the brim holder. Finally, arrange the brim so that it maintains a slightly rounded shape.

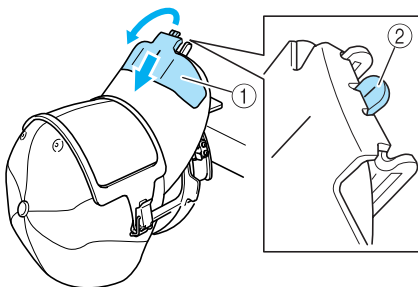

- ① Brim holder
② Centerline of brim presser
- Make sure the notch comes out.

- 10** As shown in the illustration, use both hands to press in on the sides of the brim to reshape it so that the sides do not fold out.

If the pattern is embroidered with the sides of the brim folded out, the brim will hit the machine and cause the pattern to become misaligned.

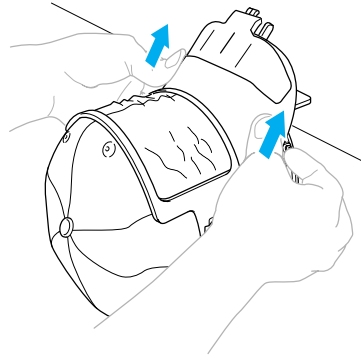

- 11** Stretch the fabric in the embroidering area so that it is taut.

While pressing in on the sides of the brim, the fabric within the cap frame may be pressed, causing slack in the fabric. Pull the fabric along the left, right and center seams in the direction of the arrows, and stretch the fabric so that the embroidering area is taut.

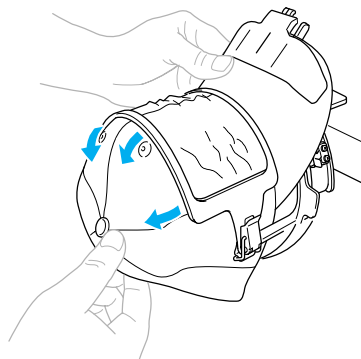

- This completes the positioning of the cap in the standard cap frame.

12 Remove the standard cap frame from the mounting jig.

Press both right and left holders on the mounting jig with both thumbs, and then pull off the embroidery frame, as shown in the illustration.

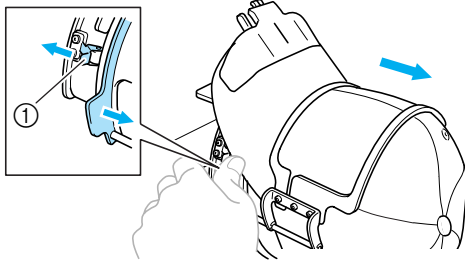

① Holder

Attaching the advanced cap frame to the mounting jig and putting a cap into the frame

Put the cap into the advanced cap frame attached to the mounting jig, and then remove the advanced cap frame from the mounting jig with the cap clamped. Next, attach the advanced cap frame to the cap frame driver on the machine.

1 Attach the advanced cap frame to the mounting jig.

Align the side of the mounting jig with the brace on the cap frame, and then push the cap frame into place.

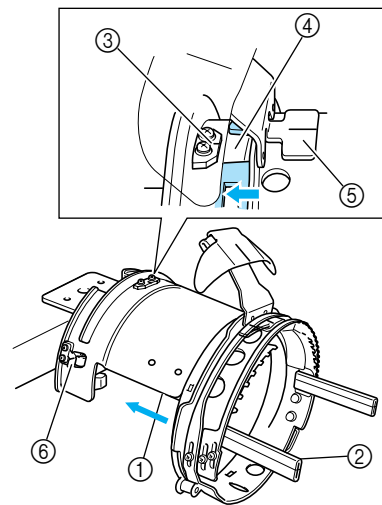

① Side of mounting jig

② Brace on cap frame

- Align the notch in the advanced cap frame with the guiding plate on the mounting jig, and then snap the frame into place.

③ Guiding Plate on mounting jig

④ Notch on advanced cap frame

⑤ Sweat guard holder

⑥ Holder

► The advanced cap frame is secured with the two holders (clips) one on right side and one on left side.

- 2** Release the snap lock on the advanced cap frame down and then disengage the latch. Open the clamping frame. Also, open brim presser.

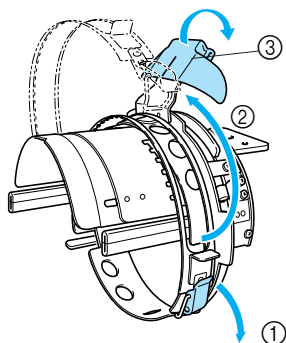

- ① Snap lock released
- ② Clamping frame opened
- ③ Brim presser

- 3** Secure the stabilizer with the pins on the cap frame.

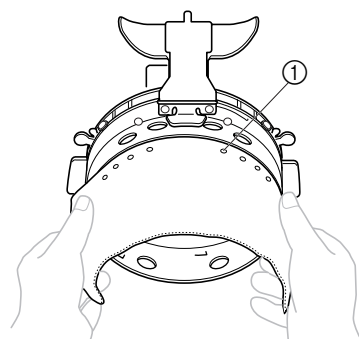

- ① Pins
- Make sure that the pins go through the stabilizer to firmly secure it.

- 4** Lift up (flip) the sweat guard on the inside of the cap, and then place the cap in the advanced cap frame.

Using both hands, hold both sides of the cap, and then align the edge of the lower frame with the base of the brim.

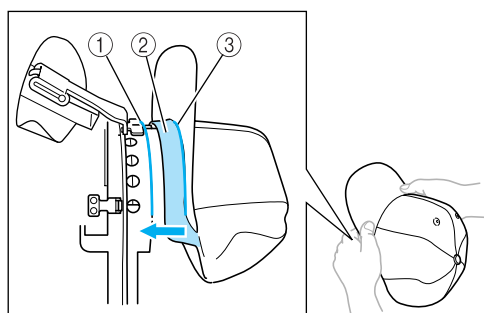

- ① Edge of the lower frame
- ② Sweat guard
- ③ Base of the brim

At the same time, align the centerline of the cap with the centerline of the sweat guard holder on the advanced cap frame, and then slide the sweat guard under the sweat guard holder.

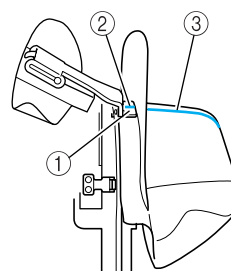

- ① Sweat guard holder
- ② Centerline of sweat guard holder
- ③ Centerline of cap

- 5** Align the centerline of the cap with the notch in the mounting jig.

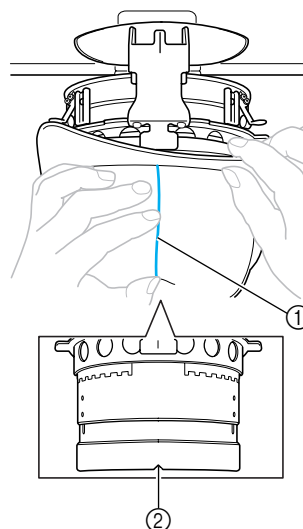

- ① Centerline of cap
- ② Notch in mounting jig

- 6** Place the sweat guard of the cap inside the notch in the cap frame.

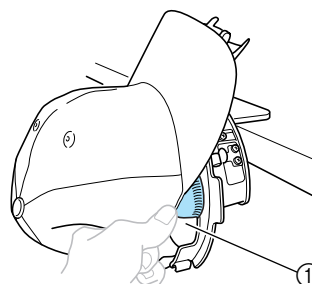

- ① Notch in cap frame

7

- 7** Close the clamping frame so that the brim of the cap passes between the inside clamping frame and the outside clamping frame.

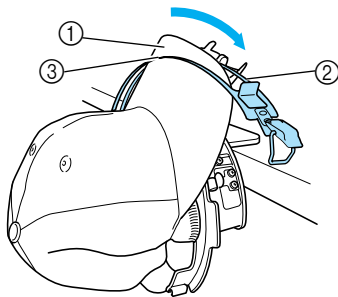

- ① Brim
- ② Inside clamping frame
- ③ Outside clamping frame

- 8** Neatly align the teeth of the clamping frame with the base of the brim.

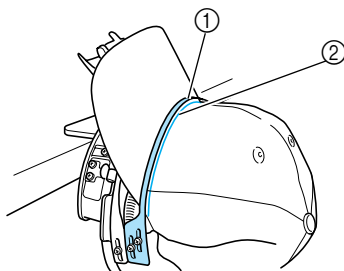

- ① Teeth of clamping frame
- ② Base of brim

Note

- Loosen the two screws for the outside clamping frame, and then adjust the position of the outside clamping frame so that it conforms to the shape of the cap and so that the teeth of the clamping frame perfectly align with the base of the brim.

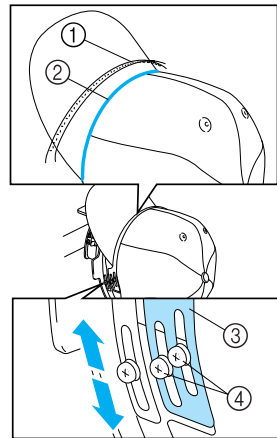

- ① Teeth of clamping frame
- ② Base of brim
- ③ Outside clamping frame
- ④ Screws for the outside clamping frame

- 9** Adjust the other side in the same way.

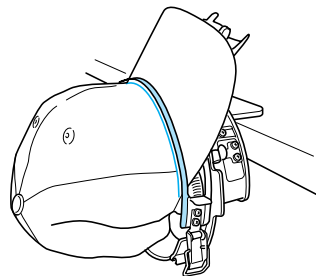

- 10** Close the lever of the snap lock.

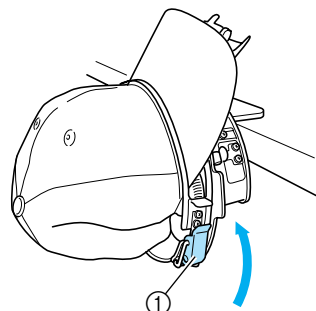

- ① Lever of the snap lock



Note

- If the cap fabric is thick and the clamping frame cannot be closed, or if the fabric is thin and the cap is too loose within the frame, loosen the screw for the inside clamping frame, and then adjust the inside clamping frame.

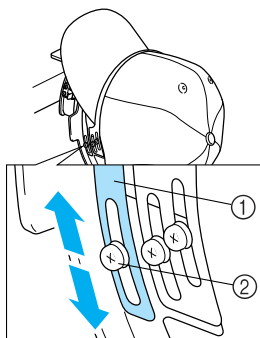

- ① Inside clamping frame
- ② Screw for the inside clamping frame

- 11** Pull the ends of the cap out from the center to remove any slack.

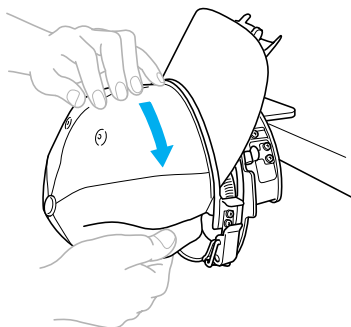

- 12** Use the clips to secure the cap.

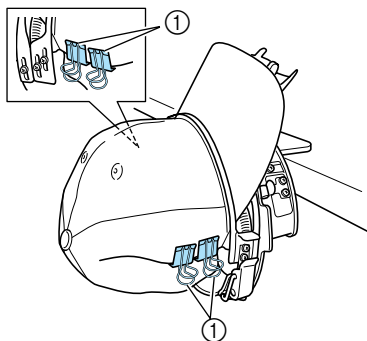

- ① Clips
- Repeat steps 11 and 12 on the other side to remove any slack and secure the cap with the clips.

- 13** Pull the brim holder up as far as possible. Next, turn the brim holder over the cap brim, and then lower the brim holder. Finally, arrange the brim so that it maintains a slightly rounded shape.

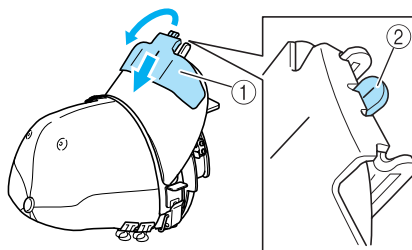

- ① Brim holder
- ② Centerline of brim presser
- Make sure the notch comes out.

- 14** Adjust the brim so that it maintains a rounded shape.

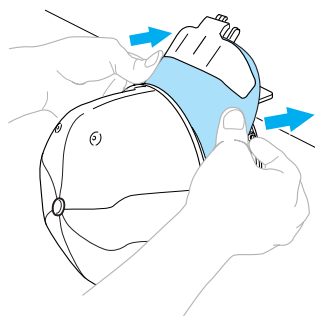

- ▶ This completes the positioning of the cap in the advanced cap frame.

- 15** Remove the advanced cap frame from the mounting jig. Press both right and left holders on the mounting jig with both thumbs, and then pull off the embroidery frame, as shown in the illustration.

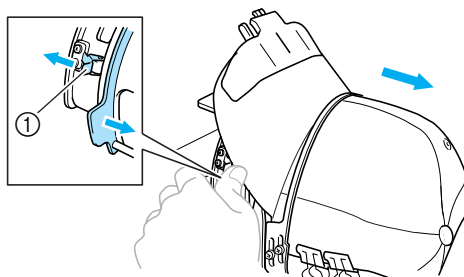

- ① Holder

■ Attaching the cap frame to the embroidery machine

The cap frame driver is required in order to attach the cap frame to the embroidery machine. Before attaching the cap frame to the machine, attach the cap frame driver to the carriage. (Refer to "Installing the cap frame driver" on page 171.)

1 Attach the cap frame to the cap frame driver.

As shown in the illustration, turn the embroidering position to the side when inserting the cap frame so the brim of the cap does not hit the embroidery machine.

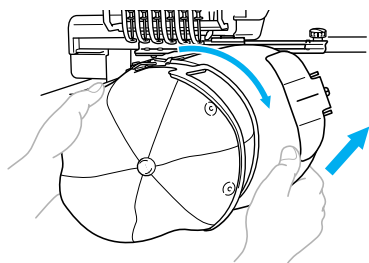

- Be careful that the cap frame does not hit any nearby parts, such as the presser foot.

After turning the cap frame so that the embroidering surface faces upward, align the ring of the cap frame driver with the ring of the cap frame. While sliding the cap frame to the left and right, align the notch in the cap frame with the guiding plate on the cap frame driver, and then snap the frame into place.

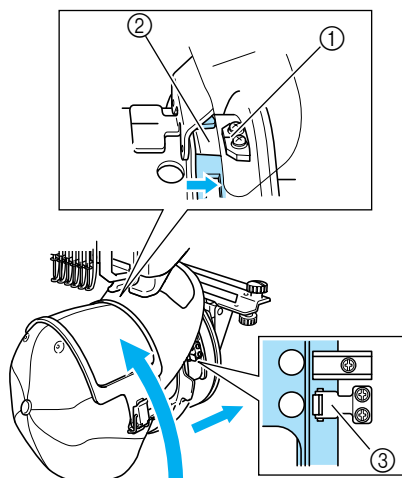

- ① Guiding Plate on cap frame driver
- ② Notch on cap frame
- ③ Holder

- The cap frame is secured with the two holders one on the right and one on the left. This completes the installation of the cap frame, and the cap is ready to be embroidered.

■ Removing the cap frame

After embroidering is finished, remove the cap frame, and then remove the cap.

1 Remove the cap frame from the cap frame driver.

Press both of the two holders at the base of the cap frame with both thumbs, and then pull off the embroidery frame, as shown in the illustration.

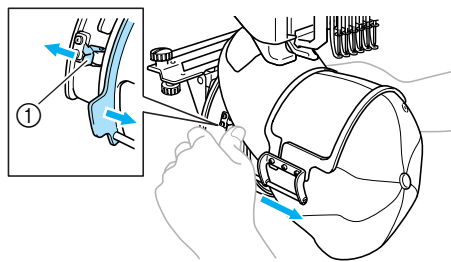

- ① Holder

As shown in the illustration, turn the embroidering position to the side when removing the cap frame so the brim of the cap does not hit the embroidery machine.

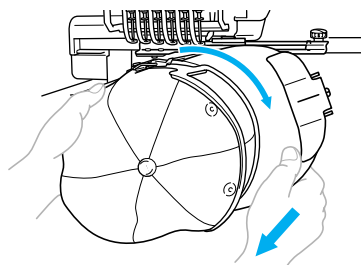

- Be careful that the cap frame does not hit any nearby parts, such as the presser foot.

■ For the standard cap frame

2 Release the snap lock on the cap frame, and then remove the cap.

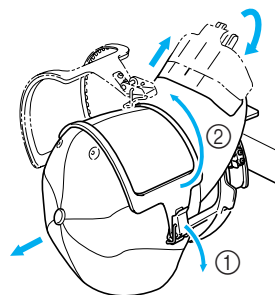

■ For the advanced cap frame

- ② After removing the brim holder, unlock the snap lock of the cap frame, remove the clips, and then remove the cap.

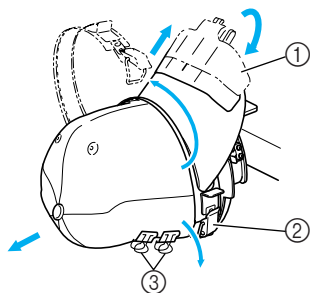

- ① Brim holder
- ② Snap lock
- ③ Clips

Installing the embroidery frame holder

After embroidering using the cap embroidery frame is finished, remove the needle plate spacer and cap frame driver, and then re-attach the embroidery frame holder.

- ① Remove the needle plate spacer.

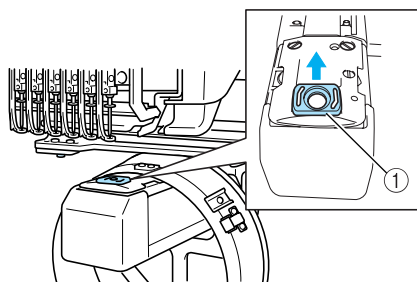

- ① Needle plate spacer

- ② Loosen the two lower thumb screws.

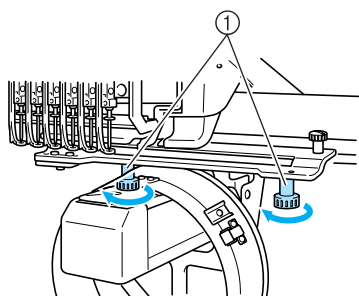

- ① Thumb screws

- ③ Remove the two upper thumb screws

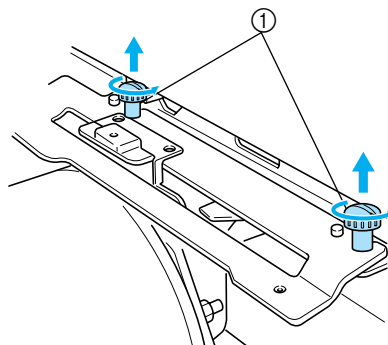

- ① Thumb screws

- ④ Remove the cap frame driver.

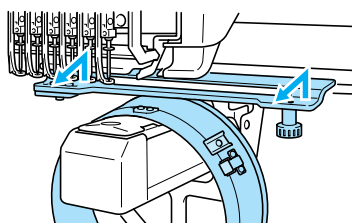

Note

- Be careful that the cap frame driver does not hit any nearby parts, such as the presser foot.

- ⑤ With the hole on the sweat guard holder aligned with the centerline of the guiding plate, insert the two thumb screws removed in step ③ into the holes at the top, and then tighten the thumb screws.

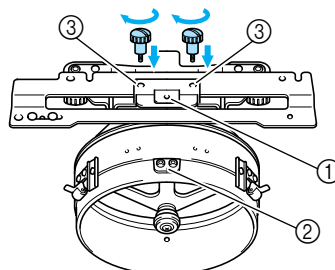

- ① Hole on the sweat guard holder
- ② Centerline of guiding plate
- ③ Holes on the top
- Insert the thumb screws into the holes where the cap frame driver that was originally installed (holes that the thumb screws were removed from in step ② on page 171).
- The movable section of the cap frame driver is secured.

- 6** Align the holes on the embroidery frame holder with the pins in the frame-mounting plate of the carriage.

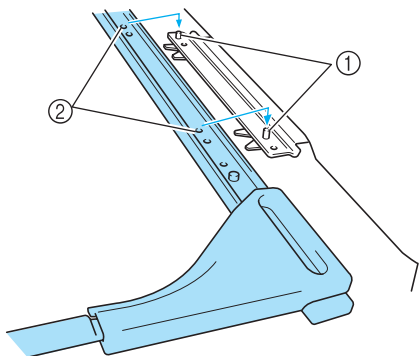

- ① Pins in the frame-mounting plate
② Holes on the embroidery frame holder

- 7** Secure the embroidery frame holder with the two thumb screws.

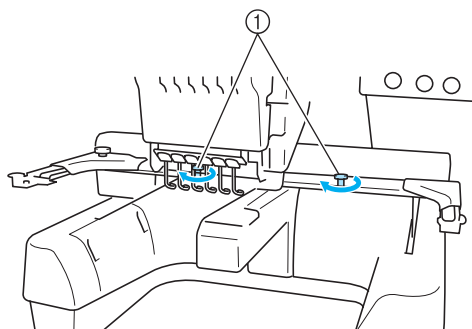

- ① Use the thumb screws included with the machine (thumb screws removed in step ① on page 171).

CAUTION

- Using the disc-shaped screwdriver included, firmly tighten the thumb screws.

Additional digitizing information

When creating a pattern for embroidering with a cap frame, pay attention to following points in order to avoid registration problems (misalignment of gaps in the pattern).

- 1** Sew underlay stitches.

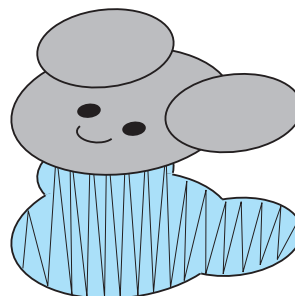

- 2** Start the embroidery pattern from the center, and sew toward the ends.

With the machine, the order in which patterns are selected when they are combined is the order in which they will be sewn. For the following example, select the patterns in the order "E"→"A"→"B"→"R" to make the combined pattern "BEAR".

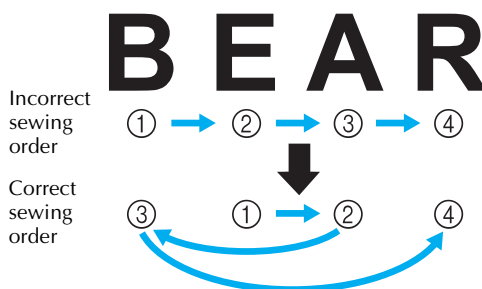

Note

- Do NOT sew from one end to the other, otherwise wrinkling or shrinking may occur.

- 3** When sewing outlines of patterns, make sure that the stitch width of the satin stitching is at least 2 mm, and that the stitching overlaps the fabric by at least 1 mm. Also, make sure that there are no jumps of long stitches in the outlining on each region or letter.

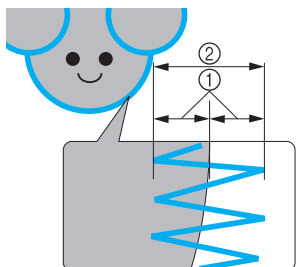

- ① At least 1 mm
② At least 2 mm

CAUTION

- Don't sew more than four overlapping layers.

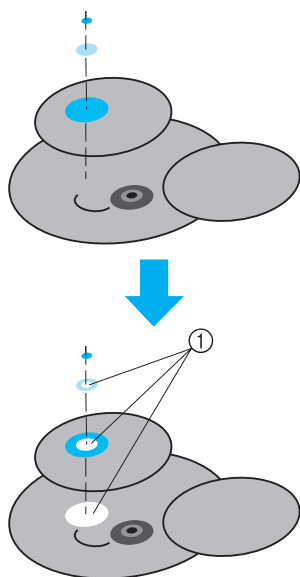

- ① Specify that overlapping areas not be sewn.

Using the Optional Bobbin Winder

When winding the bobbin thread onto a metal bobbin, use the optional bobbin winder. The procedures for using the optional bobbin winder are described below.

Precautions

For precautions concerning the power supply, refer to page 14.

CAUTION

- Be sure to place the bobbin winder on a level, stable surface.
- Only use the bobbins supplied with this bobbin winder.

Optional bobbin winder and its accessories

Check that the following bobbin winder and accessories are enclosed.

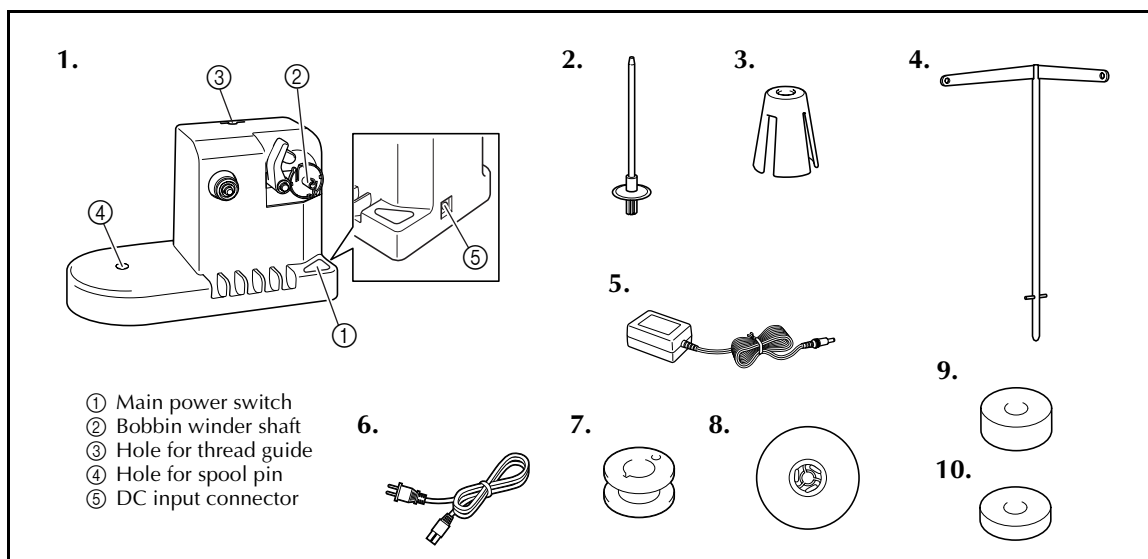

No.	Name	Parts Code	No.	Name	Parts Code
1	Bobbin winder	XC6598-051	6	Power supply cord	X59354-151(UK) LN2284-001 (USA/CANADA) XA0070-151(Europe) XC9548-051 (Australia)
2	Spool pin	XC5949-051	7	Metal bobbins (5)	100376-053
3	Spool cushion	XA0679-050	8	Spool cap	130012-054
4	Thread guide	XC6644-051	9	Weight (L)	XC5974-151
5	AC adapter	XC6643-051 XD0318-051(Europe)	10	Weight (S)	XC6631-051

* The parts code of the bobbin winder set may differ depending on the area where the machine was purchased.

Setting up the optional bobbin winder

Attach the spool pin, spool cushion and thread guide to the bobbin winder.

- 1 Insert the spool pin and the spool cushion.**
Lower the holder, and then insert the spool pin straight into the hole. And insert the spool cushion.

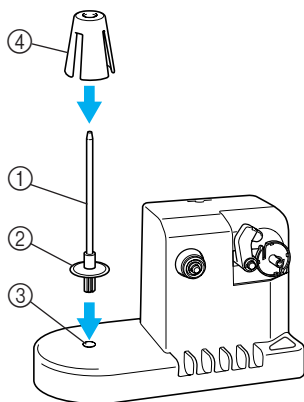

- ① Spool pin
- ② Spool pin holder
- ③ Hole for spool pin
- ④ Spool cushion

- 2 Insert the thread guide.**
Insert the thread guide straight into the hole with the pins on the thread guide aligned with the notches on the sides of the hole.

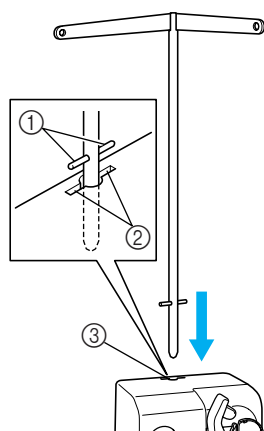

- ① Pins on thread guide
- ② Notches on hole for thread guide
- ③ Hole for thread guide

- Firmly insert the thread guide as far as possible and make sure that it is secure.

Connecting the AC adapter

- 1 Insert the plug of the power supply cord into the AC adapter.**

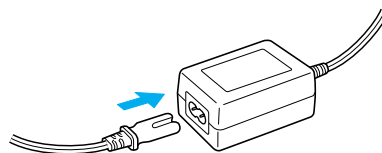

- 2 Plug the cord on the AC adapter into the DC input connector of the bobbin winder, and then insert the plug of the power supply cord into a household electrical outlet.**

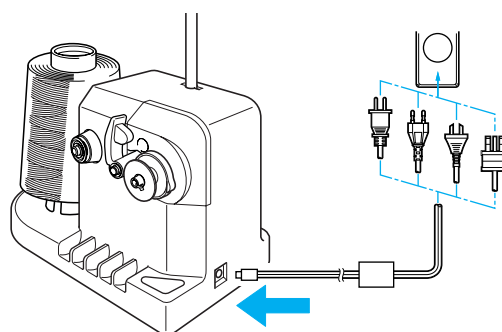

- Be sure to firmly insert the plug on the AC adapter into the DC input connector of the bobbin winder.

! CAUTION

- Be sure to use the included AC adapter. Using any other AC adapter may result in damage.
- Before connecting or disconnecting the AC adapter, be sure that the unit is not operating.
- After using the bobbin winder, disconnect it from the electrical outlet.

Winding the bobbin

Prepare the bobbin and the spool of bobbin thread. Use cotton or spun polyester bobbin thread (from 74 dtex/2 to 100 dtex/2).

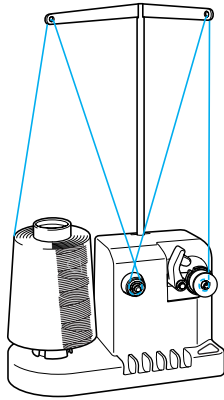

- 1** Align the groove in the bobbin with the spring on the bobbin winder shaft, and set the bobbin on the shaft.

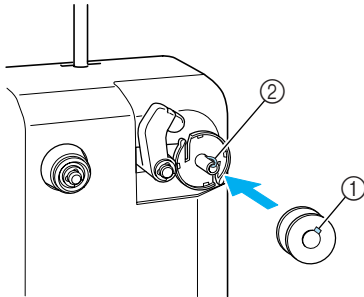

- ① Groove in the bobbin
② Spring on the shaft

- 2** Set the thread spool on the spool pin.

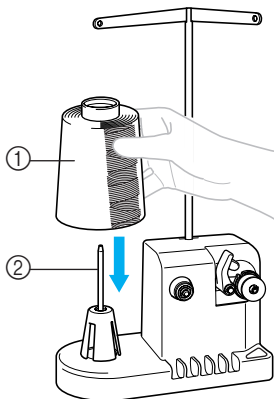

- ① Thread spool
② Spool pin

Note

- When using a small spool, remove the spool cushion and set the spool directly onto the spool pin. Also use the included spool cap to keep the small spool stable.

- 3** Pass the thread through the hole in the left of the thread guide toward the front of the winder.

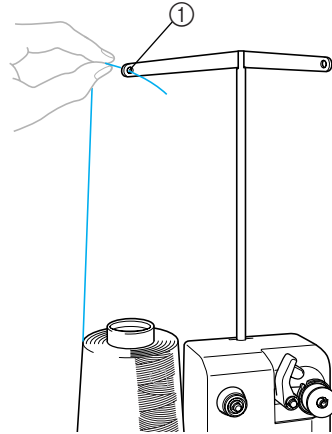

- ① Hole in the thread guide

- 4** Pass the thread around the tension disk as shown in the illustration. Make sure that the thread is correctly fed into the tension disk.

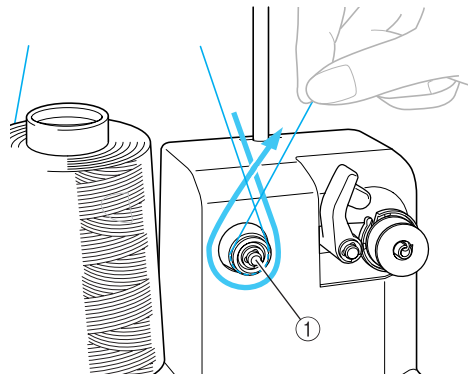

- ① Tension disk

- 5** Pass the thread through the hole in the right of the thread guide toward the back of the machine.

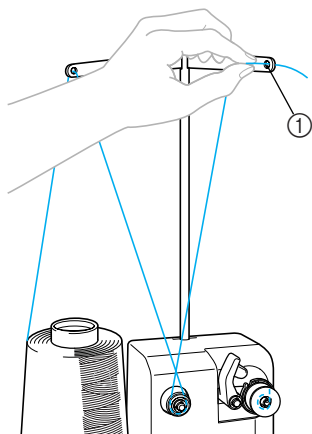

① Hole in the thread guide

- 6** Wind the thread clockwise around the bobbin 4 or 5 times, as shown in the illustration.

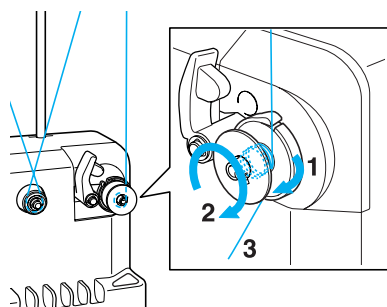

- 7** Pass the end of the thread through the guide slit in the bobbin winder seat, and pull the thread. The cutter will cut the thread.

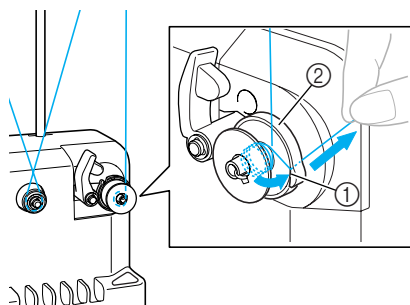

① Guide slit
② Bobbin winder seat

Note

- Be sure to follow the procedure described. If the bobbin is wound without the thread being cut with the cutter, when the bobbin thread runs low, the thread may become tangled around the bobbin and cause the needle to break.

- 8** Slide the bobbin holder, until it clicks into place.

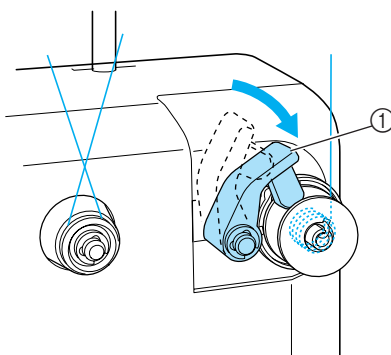

① Bobbin holder

- 9** Press the main power switch to start winding the bobbin.

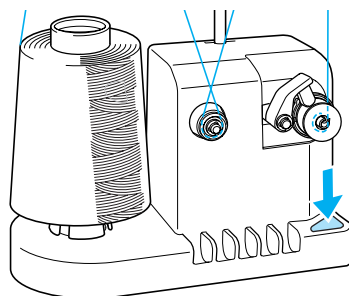

- ▶ Start winding the bobbin.

- 10** The bobbin will stop rotating automatically when it is done winding, and the bobbin holder will return to its original position.

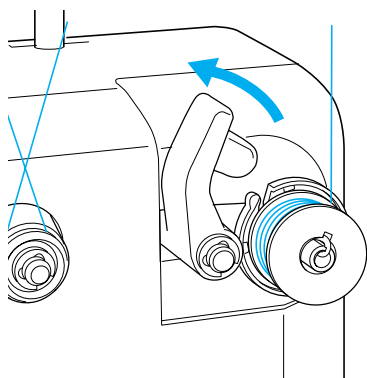

- 11** Remove the bobbin.

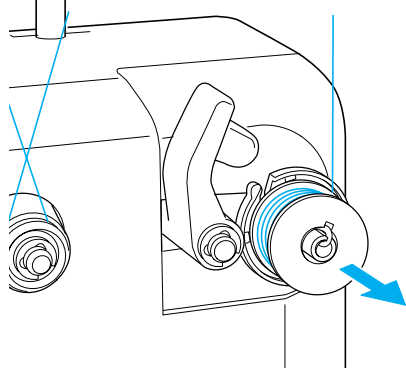

Note

- When removing the bobbin, do not pull on the bobbin winder seat. Doing so could loosen or remove the bobbin winder seat, resulting in damage to the bobbin winder.

- 12** Pull the thread through the guide slit in the bobbin winder seat to cut the thread with the cutter.

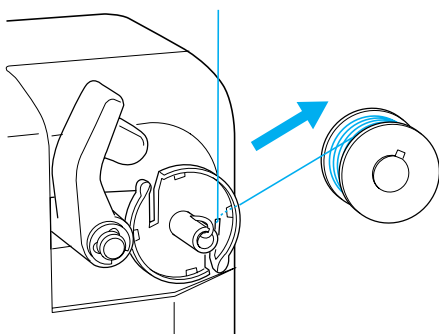

! CAUTION

- Check that the bobbin thread has been wound correctly, otherwise the needle may break or the thread tension will be incorrect.

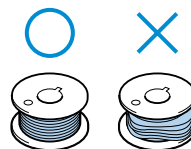

- Be sure to clean the bobbin case each time that the bobbin is changed. Thread wax and dust easily collect around the hole in the tension-adjusting spring on the bobbin case, resulting in an incorrect thread tension. For details, refer to “Cleaning the bobbin case” on page 195.
- Be sure to check the tension of the bobbin thread each time that the bobbin is changed.
- Depending on the bobbin thread type, the tension of the bobbin thread may differ. Be sure to check the tension of the bobbin thread and adjust the tension if necessary.
For a metal bobbin, use both weights, large (L) and small (S).
For detailed instructions on how to adjust the bobbin tension, refer to page 85.

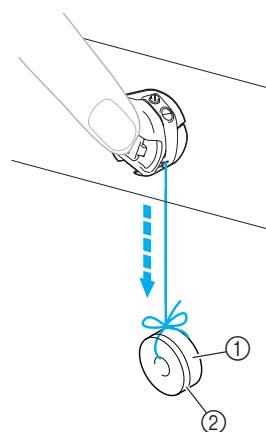

- ① Weight (L) (Parts Code: XC5974-151)
② Weight (S) (Parts Code: XC6631-051)

- **If bobbin winding is stopped before it is finished:**
The bobbin winder stops automatically if the thread does not feed, for example, if it becomes tangled on the spool pin. If this occurs, correctly thread the bobbin winder, and then wind the bobbin correctly.

Maintenance

Simple embroidery machine maintenance operations are described below. Always keep the machine clean, otherwise malfunctions may occur.

Cleaning the LCD

If the surface of the LCD is dirty, lightly wipe it with a soft dry cloth. Do not use organic cleansers or detergents.

Cleaning the machine surface

If the surface of the machine is slightly dirty, wipe it with a soft dry cloth. If the machine is heavily dirty, lightly soak a cloth in neutral detergent, squeeze it out firmly, and then wipe the surface of the machine. After cleaning it once with a wet cloth, wipe it again with a dry cloth.

CAUTION

- Unplug the power supply cord before cleaning the machine, otherwise injuries or an electric shock may occur.



Note

- Do not use chemical products, such as benzene or thinner.

Cleaning the hook

Periodically remove lint and dust for better performance from Hook race area. Use the included cleaning brush.

- 1 Turn off the embroidery machine.

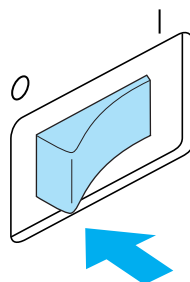

CAUTION

- Unplug the power supply cord before cleaning the machine, otherwise injuries or an electric shock may occur.

- 2 Open the hook cover, and remove the bobbin case. (Refer to page 18.)

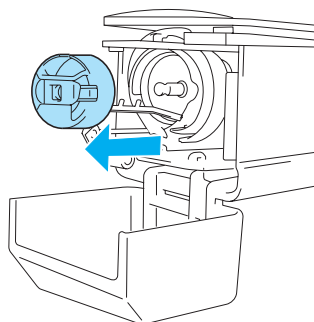

- 3** Use the included cleaning brush to remove any lint and dust from the hook and its surrounding area.

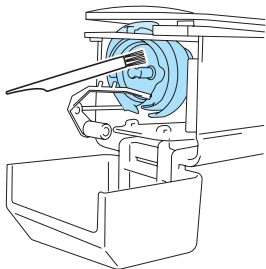

! CAUTION

- If the hook is scratched or damaged, consult your authorized dealer.

- 4** After cleaning is finished, insert the bobbin case into the hook, and then close the hook cover. (Refer to page 19.)

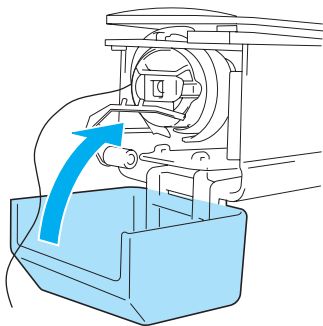

Cleaning around the needle plate

If lint and dust collect around the moving knife, the fixed knife or the thread retaining plate, the thread may not be cut correctly or various parts of the machine may be damaged. Make sure to clean around the needle plate once a month. Use an offset screwdriver and the included cleaning brush.

- 1** Turn off the embroidery machine.

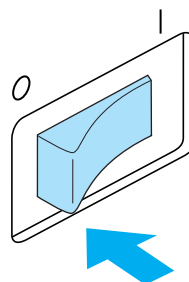

! CAUTION

- Unplug the power supply cord before cleaning the machine, otherwise injuries or an electric shock may occur.

- 2** Remove the needle plate. With an offset screwdriver, loosen the screws, and then remove the needle plate.

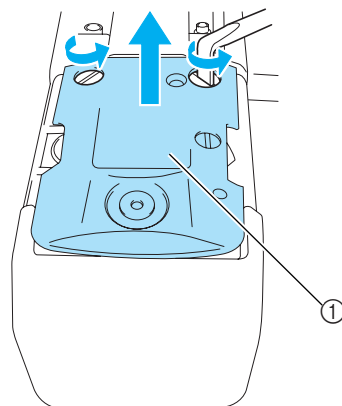

① Needle plate

- 3** Use the included cleaning brush to remove any lint and dust from the moving knife, the fixed knife, the thread retaining plate, and their surrounding areas.

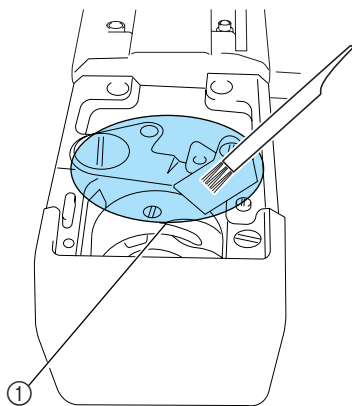

① Remove all lint in this area

- 4** After cleaning is finished, attach the needle plate in the opposite way that it was removed in step e.

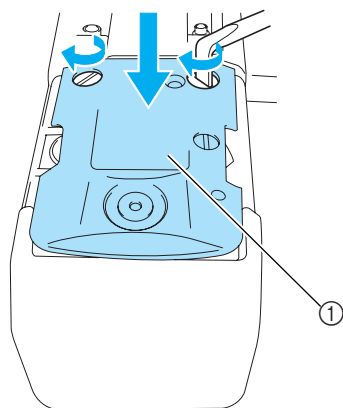

① Needle plate

Cleaning the bobbin case

Thread wax and dust easily collect around the hole in the tension-adjusting spring on the bobbin case, resulting in an incorrect thread tension. Therefore, it should be cleaned each time when the bobbin is changed.

Use a piece of paper with the thickness of a business card.

- 1** Open the hook cover, remove the bobbin case, and then remove the bobbin. (Refer to page 18.)

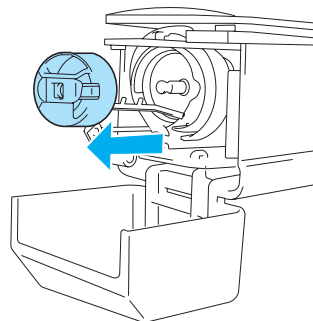

- 2** Slide the paper under the tension-adjusting spring to remove any dust.

Use a corner of the paper to remove any dust from around the hole.

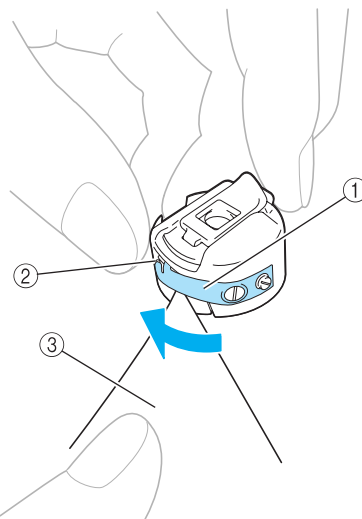

- ① Tension-adjusting spring
 ② Hole
 ③ Paper



Note

- Do not bend the tension-adjusting spring. In addition, do not use anything other than thick paper or paper of the specified thickness to clean the bobbin case.

- 3 Use the enclosed cleaning brush to remove any lint and dust from inside the bobbin case.

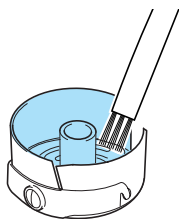

- 4 After cleaning is finished, insert the bobbin into the bobbin case and the bobbin case into the hook, and then close the hook cover. (Refer to page 19.)

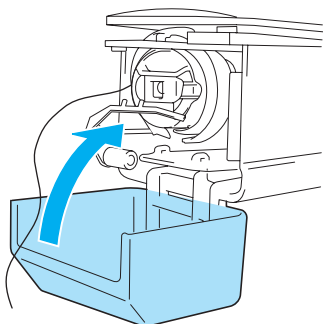

Oiling the machine

In order to extend the life of the embroidery machine's parts and keep the machine operating correctly, be sure to oil the machine before the first time that it is used.

Afterward, put a drop of oil onto the hook once a day before use, and put a drop of oil to the lower needle bar felt washer every 40 to 50 hours of machine use.

■ Oiling the race

- 1 Turn off the embroidery machine.

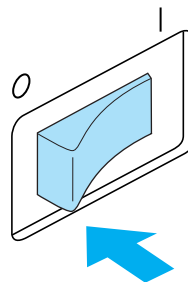

! CAUTION

- Unplug the power supply cord before cleaning the machine, otherwise injuries or an electric shock may occur.

- 2 Open the hook cover, and remove the bobbin case. (Refer to page 19.)

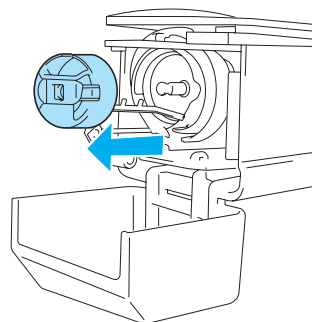

- 3** Rotate the handwheel (about 50 degrees) to move the race of the hook to a position where it can easily be oiled.

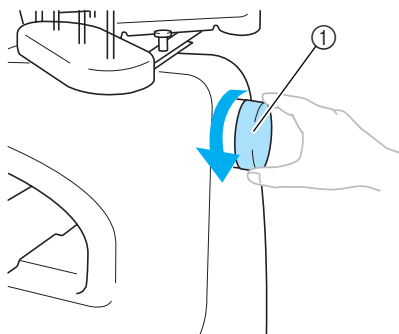

- ① Handwheel
- Be sure to rotate the handwheel counterclockwise.

- 4** Put a drop of oil onto the hook.

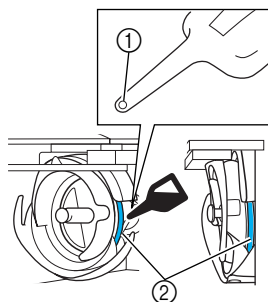

- ① Punch a small hole in oil bottle.
 ② Apply oil here.
- Use a pointed object to punch a small hole in the tip of the enclosed oiler before using it.

- 5** After oiling, insert the bobbin case into the hook, and then close the hook cover. (Refer to page 18.)

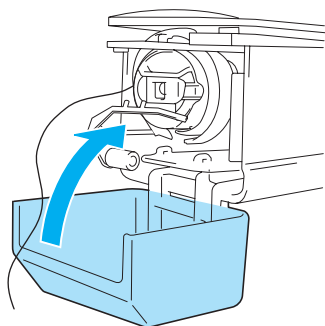

■ Oiling the needle bars

From embroidering screen, select one needle bar at a time. Pull down the selected needle bar and lock into position (refer to page 72). Put one drop of oil on the lower needle bar felt washer.

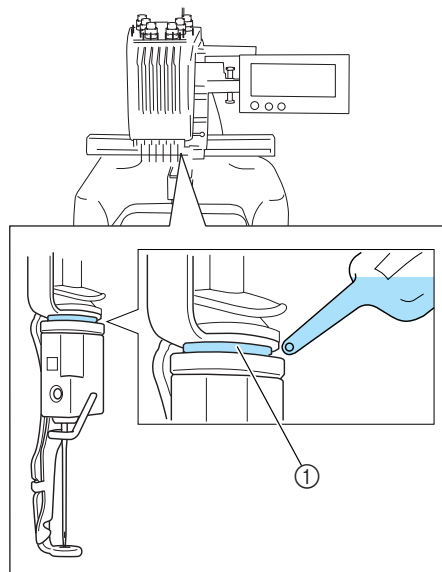

- ① Apply oil here.
- Too much oil may drip onto sewing project.

⚡ Note

- Put a drop of oil onto the hook once a day before use.
- Apply one drop of oil on the lower needle bar felt washer every 40 – 50 hours of sewing time.
- Apply only sewing machine oil. Use of any other type of oil may result in damage to the embroidery machine.
- Do not apply too much oil. Fabric or thread may get contaminated. If too much oil is applied, wipe off any excess with a rag.
- If the thread breaks while sewing or the operating noise of the hook becomes loud, apply oil onto the race hook.

Troubleshooting

On-screen troubleshooting

This embroidery machine is equipped with an easy-to-use troubleshooting feature for problems during sewing. Touch the key that shows the problem, and then check for the causes that are displayed.

1 Touch .

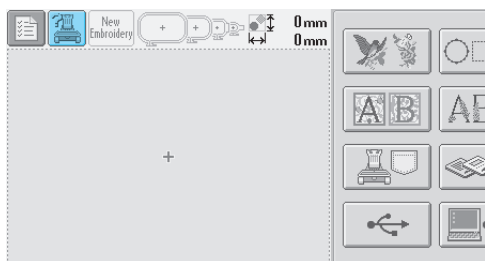

2 Touch **TROUBLESHOOTING**.

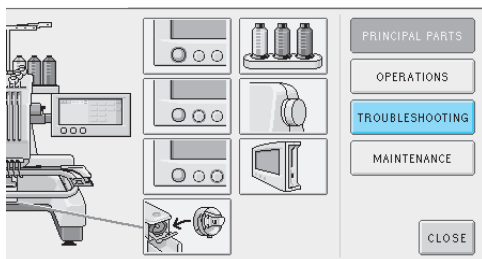

3 Touch the key that contains a description of the problem.

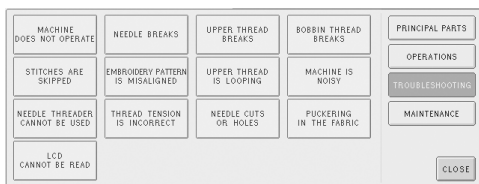

4 Check the items that are displayed.

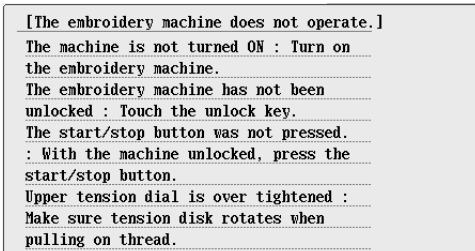

5 After checking the desired information, touch **CLOSE**.

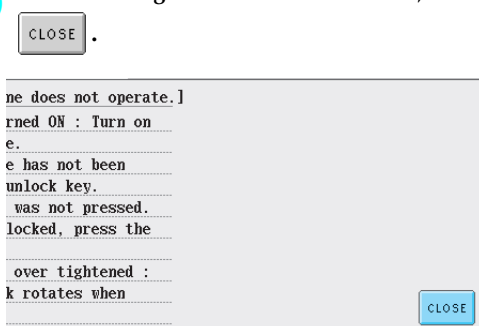

6 Touch **CLOSE**.

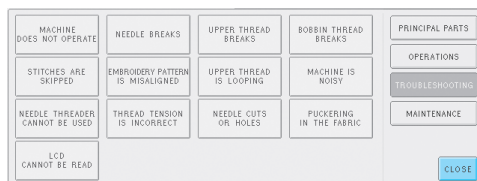

► The screen that was displayed before was touched appears.



Troubleshooting

If the machine does not operate correctly, check for the following points/issues before requesting service.
If the suggested remedy does not correct the problem, contact your authorized dealer.

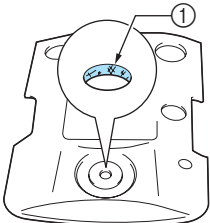
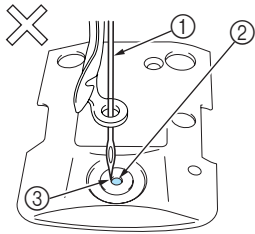
Symptom	Probable Cause	Remedy	Reference Page
The embroidery machine does not operate.	The machine is not turned ON.	Turn on the embroidery machine.	p.20
	The machine has not been unlocked.	Touch the unlock key.	p.42
	The start/stop button was not pressed.	With the machine unlocked, press the start/stop button.	p.42
The needle breaks.	The needle is not installed correctly.	Correctly install the needle.	p.63
	The needle set screw is loose.	Use the Allen screw driver to securely tighten the needle set screw.	p.63
	The needle is bent or blunt.	Replace the needle with a new one.	p.15, 63
	The area around the hole in the needle plate is damaged.  ① Scratches/Burrs	Replace the needle plate. Consult your nearest authorized dealer.	
	The needle hits/touches the needle plate.  ① Needle ② Hole in needle plate ③ Needle hits hole	Replace needle. Consult your nearest authorized dealer.	
The presser foot is set too high and not correctly positioned. The needle hits/touches the presser foot.	Consult your nearest authorized dealer.		

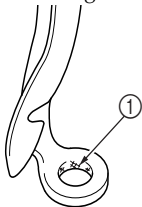
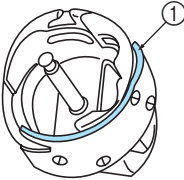
Symptom	Probable Cause	Remedy	Reference Page
The needle breaks.	<p>The area around the embroidery foot hole is damaged.</p>  <p>① Scratches or Burrs</p>	<p>Replace the presser foot. Consult your nearest authorized dealer.</p>	
	<p>Sliding surface on hook race is not smooth. There are scratches or burrs on it.</p>  <p>① Hook race area</p>	<p>Consult your nearest authorized dealer.</p>	
	<p>The hook is not correctly installed.</p>	<p>Consult your nearest authorized dealer.</p>	
	<p>The hook stopper is not correctly installed, the hook is making a complete rotation.</p>	<p>Consult your nearest authorized dealer.</p>	
	<p>The upper thread is not threaded correctly. The upper thread is catching somewhere.</p>	<p>Pull the upper thread by hand from below the presser foot, and check that the thread moves smoothly. If the thread does not move, it is not threaded correctly. Thread the upper thread correctly. Make sure the thread is caught by the needle bar thread guide.</p>	<p>p.35-38</p>
	<p>The upper thread tension is set too high. It does not run.</p>	<p>Decrease the upper thread tension and make sure tension disc rotate when pulling on thread.</p>	<p>p.86</p>
	<p>A bobbin designed specifically for this machine is not used.</p>	<p>Use the correct bobbin.</p>	<p>p.15</p>
	<p>The needle and the hook are not correctly passing each other.</p>	<p>Hook timing may be OFF. Consult your nearest authorized dealer.</p>	
	<p>There is backlash play (forward/backward) in the needle bar case.</p>	<p>Consult your nearest authorized dealer.</p>	
<p>The thread density of the embroidery data is too fine. Three or more overlapping stitches are being sewn.</p>	<p>Using a data design system, correct the thread density and over stitching settings in the embroidery data.</p>	<p>p.100</p>	

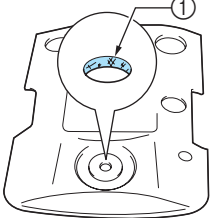
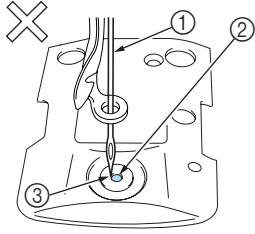
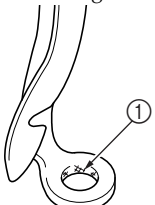
Symptom	Probable Cause	Remedy	Reference Page
The upper thread breaks.	The needle is not correctly installed .	Correctly install the needle.	p.63
	The needle set screw is loose.	Use the Allen screw driver to tighten the needle set screw.	p.63
	The needle is bent or blunt.	Replace the needle with a new one.	p.15, 63
	The area around the hole in the needle plate is damaged.  ① Scratches/Burrs	Replace the needle plate or consult your nearest authorized dealer.	
	The needle is touching the needle plate.  ① Needle ② Needle plate hole ③ Needle touching hole	Consult your nearest authorized dealer.	
	The presser foot is set too high and not correctly positioned. The needle hits/touches the presser foot.	Consult your nearest authorized dealer.	
	The area around the embroidery foot hole is damaged.  ① Scratches/Burrs	Replace the presser foot. Consult your nearest authorized dealer.	
	Using a weak thread like a metallic thread.	Slow down the machine sewing speed.	p.91

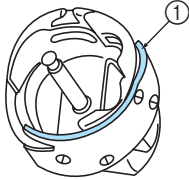
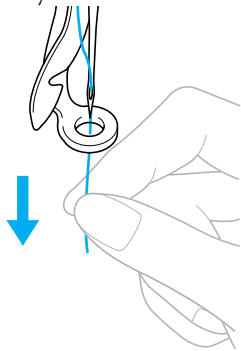
Symptom	Probable Cause	Remedy	Reference Page
The upper thread breaks.	Sliding surface on hook is not smooth. There are burns on it.  ① Hook race area	Consult your nearest authorized dealer.	
	The thread is loose in the hook area.	Remove the loose thread. If the thread is tangled in the hook, clean the hook.	p.193
	The play between the hook and the race is too much.	Consult your nearest authorized dealer.	
	The hook does not rotate smoothly.	Remove lint, and clean and apply oil.	p.193, 196
	The space between the hook stopper and the hook cannot be adjusted.	Consult your nearest authorized dealer.	
	The upper thread is not threaded correctly. 	Pull the upper thread by hand from below the presser foot, and check that the thread moves smoothly. If the thread does not move smoothly, it is not correctly threaded. Un-thread the machine and re-thread the machine. Make sure the thread is correctly positioned in the needle bar thread guide.	p.35-38
	Upper thread is not positioned in upper or middle thread guide.	Make sure thread passes completely under upper and middle thread guide.	p.36-37
	There are knots or tangles in the thread.	Remove any knots or tangles.	
	The upper thread tension is too high.	Decrease the upper thread tension.	p.86
	The lower thread tension is incorrect. The thread does not roll out of the bobbin case smoothly.	Adjust the lower thread tension.	p.85
	The bobbin case is damaged.	Replace the bobbin case with a new one.	p.15
	The bobbin thread is not wound correctly.	Check that the bobbin is wound so that it about 80% full and that the thread is evenly wound. If the bobbin is not correctly wound, replace the bobbin with one that is correctly wound or rewind the bobbin.	p.15
A bobbin designed specifically for this machine is not used.	Use the correct bobbin.	p.15	

Symptom	Probable Cause	Remedy	Reference Page
The upper thread breaks.	The automatic needle-threading mechanism is broken.	Consult your nearest authorized dealer.	
	Adhesive is attached to the needle.	Replace the needle.	p.63
	The fabric is not taut.	Firmly set the fabric in the embroidery frame so that it is taut.	p.28, 67
	The thread quality is poor.	The thread quality is too weak due to age of thread. Replace thread.	
	The embroidery data contains stitches with a pitch of zero.	Delete all stitches with a zero pitch.	p.150
	The embroidery data contains many stitches with an extremely small pitch.	Delete all stitches with a small pitch.	p.150
	The thread density of the embroidery data is too fine. Three or more overlapping stitches are being sewn.	Using a data design system, correct the thread density and overstitching settings in the embroidery data.	p.100
The bobbin thread breaks.	The bobbin thread is not correctly threaded.	Correctly thread the bobbin thread.	p.19
	The bobbin is scratched or does not rotate smoothly.	Replace the bobbin.	p.18
	The bobbin case is damaged.	Replace the bobbin case.	p.18
	The thread is tangled.	Remove the thread jammed and clean the hook.	p.193
	A bobbin designed specifically for this machine is not used.	Use the correct bobbin.	p.15
Stitches are skipped.	The upper thread is not threaded correctly.	Thread the upper thread correctly.	p.35
	The needle is bent or blunt.	Replace the needle with a new one.	p.15, 63
	The needle is not installed correctly.	Correctly install the needle.	p.63
	Dust has accumulated under the needle plate or in the hook.	Clean the hook and the needle plate.	p.193, 194
	The needle and the hook are not correctly passing each other.	Consult your nearest authorized dealer.	
	The thread twist is either too tight or too loose.	Improper twisting results in irregular loop formation. Try using a new spool.	
The embroidery pattern is misaligned.	The thread is tangled.	Use tweezers to remove any tangled thread from the hook.	
	The fabric is not well framed in the embroidery frame (for example, the fabric is not taut).	If the fabric is not taut, the pattern may become misaligned or the stitching may shrink. Be sure to correctly frame the fabric in the embroidery frame.	p.28, 67
	The embroidery frame is too large for the size of the embroidery.	Use an embroidery frame that matches the size of the embroidery.	p.65

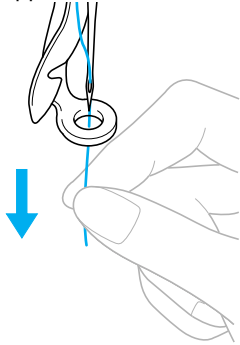
Symptom	Probable Cause	Remedy	Reference Page
The embroidery pattern is misaligned.	Stabilizer (backing) is not used.	Use stabilizer (backing) when embroidering on thin or stretch fabrics, fabrics with a coarse weave or fabrics that easily allow the stitching to shrink. <When using the optional cap frame> Use hard stabilizer when embroidering on a cap made of soft material.	p.66
	The embroidery frame is not correctly attached to the carriage.	Correctly attach the embroidery frame to the carriage. Make sure that the pins on the left and right arms of the embroidery frame holder securely fit into the holes in the handles on the embroidery frame.	p.30
	The carriage or the embroidery frame is hitting objects.	The pattern may become misaligned if the carriage or embroidery frame is hitting objects. Make sure that there are no objects within the operating field of the embroidery frame.	
	The fabric is caught or pinched.	Stop the machine, and then correctly position the fabric.	
	The carriage moved while removing embroidery frame.	The pattern may become misaligned if the presser foot was hit or the carriage was moved while replacing bobbin thread, changing needle, or working near embroidery frame. Be careful when removing and reattaching the embroidery frame while replacing bobbin thread, changing needle, or working near embroidery frame. If the carriage is moved, turn the machine off, then on again. The correct frame position at the time that the machine was stopped is stored in the machine's memory, and the embroidery frame is returned to the correct position.	
	The design was not digitized correctly.	The design may need more pull compensation or underlay to accommodate stretchy or high-napped fabrics.	
There are loops in the upper thread.	The upper thread tension is low. 	After passing the upper thread through the hole in the presser foot, pull the thread by hand to check the thread tension. If it is difficult to determine, compare it with other needle bars where looping does not occur.	p.86

Symptom	Probable Cause	Remedy	Reference Page
There are loops in the upper thread.	The thread tension does not correspond to the amount that the thread tension knob was tightened.	If the thread tension cannot be adjusted, thread wax and dust may have collected in the upper or middle thread guide plates, causing the thread tension guide plates to rise. Clean the thread tension guide plates.	
	The thread quality is poor.	Try sewing with different thread. If the problem no longer occurs after the thread is changed, the thread quality is the problem. Replace the thread with one of good quality.	
The machine is noisy.	Lint may be wound in the hook.	Clean the hook.	p.193
	The upper thread is not threaded correctly.	Check the thread path, and then thread the upper thread again.	p.35
	The hook is damaged.	Replace the hook. Consult your nearest authorized dealer.	
	Not enough oil was applied.	Oil recommended parts.	p.196
The needle threader cannot be used.	The needle is not at the correct position.	Touch the key to move the desired needle bar to be threaded into embroidering position.	p.40
	Recommended needles are not used on this machine.	Replace and use recommended needle.	p.15, 63
	The needle is not installed correctly.	Correctly install the needle.	p.15, 63
	The hook on the automatic needle-threading mechanism is bent.	Consult your nearest authorized dealer.	p.15, 63
The thread tension is incorrect.	The upper thread is not threaded correctly.	Check the thread path, and then thread the upper thread again.	p.35
	The bobbin thread is not correctly threaded.	Correctly thread the bobbin thread.	p.19
	The lower thread tension is incorrect.	Adjust the tension of the bobbin thread.	p.85
The upper thread comes out of the needle when embroidering begins.	If a short length of thread remains after the thread is trimmed, the needle may become unthreaded when embroidering begins again.	Set the remaining length of thread to "LONG TAIL" on the second page of the settings screen.	p.150
The upper thread does not reach the bobbin thread when embroidering begins.	There is no more thread in the bobbin, the thread does not feed from the bobbin, or the thread that is fed from the bobbin is too short.	Correctly thread the lower thread.	p.19





Symptom	Probable Cause	Remedy	Reference Page
Although the thread is not broken, a broken thread error occurs and the machine stops.	If the thread breakage sensor in the thread tension disc of the thread tension knobs cannot detect that the thread is being fed, even if the machine is running, a broken thread error occurs and the machine is stopped. If the thread came out of the thread tension disc, even though the thread is not broken, the machine detects that the thread is not being fed and stops.	Correctly pass the thread through the thread tension disc. If the broken thread error occurs after the machine is rethreaded, the sensor may be damaged. Consult your nearest authorized dealer.	p.37
There are needle cuts or holes in the garment.	The needle is dull.	Replace the needle. Dull needles have a difficult time passing through the garment, causing fabrics to tear.	p.15, 63
	The fabric is too delicate.	The simple penetration of the needle could damage delicate fabrics. Use stabilizer on top of fabric.	p.167
There is puckering in the fabric.	The thread tension is too tight.	Adjust the tension according to the type of fabric and thread being used. Polyester thread will stretch during sewing especially if the tensions are set too high. After the stitching is complete, the thread returns to its original strength, causing puckers in the fabric.	p.86
	The framing tension of the fabric is incorrect.	Tightly frame non-stretchable, woven fabrics. Loose framing will cause the fabric to bunch up under the stitching. Tautly frame soft knits using a stable backing. Overstretching the garment will cause it to look puckered when the frame is removed.	p.166
	The column stitches are too long.	Re-digitize the design with fill stitching or with multiple rows of column stitching.	
	The needle is dull.	Dull needles push fabric down and damage material. Replace the needle.	p.15, 63
	The design density is too heavy.	Too many stitches in an area pull fabric, causing it to pucker. Slightly decrease the design density by 5% to 10%.	
The LCD cannot be read.	The LCD contrast is incorrect.	Adjust the contrast on the LCD.	p.142

CAUTION

- This machine is equipped with a thread detecting mechanism. If the machine is not threaded with the upper thread, the machine will not operate correctly, even if the start/stop button is pressed after unlocking the machine.
- If the machine suddenly stops:
 - Turn off the machine, and unplug the power cord.
 - Restart the machine with the correct operating procedure. Refer to page 20.

Error messages

If the start/stop button is pressed while the machine is not correctly set up or if an incorrect operation is performed, the machine stops and informs you of the error with a buzzer and an error message. If an error message appears, correct the problem according to the instructions in the message.

To close the message, touch  or perform the correct operation, then touch . If the message appears again, consult your nearest authorized dealer.



The pattern extends out of the 200 mm (H) × 300 mm (W) embroidering area.

Move the pattern into the embroidering area.



The installed embroidery frame is too small.

Check which embroidery frames can be used, and then install a larger embroidery frame. (Refer to page 28.)

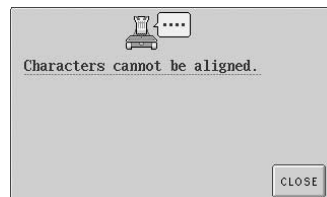

There are too many characters to be arranged on the curve.

Reduce the number of characters.



The upper thread was cut or the thread came out the thread tension disc or a thread guide. The machine is not threaded correctly.

Check that the thread is under the upper and middle thread guides and correctly thread the upper thread. (Refer to page 35.)

The bobbin thread was broken or ran out.

Check that there is thread on the bobbin and that approximately 50 mm (2 inches) of thread has been pulled out, and then re-install the bobbin. (Refer to page 19.)



The machine couldn't delete the data.

The media may be damaged.

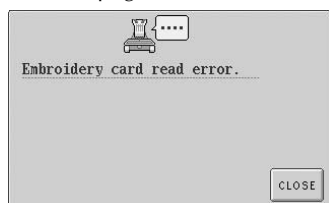

Patterns on the embroidery card cannot be read.

The embroidery card may be damaged.

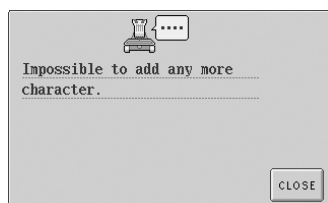

Characters have been combined until they extend out of the embroidery frame.

Decrease the number of characters so that they fit within the embroidery frame.



Six manual needle bar settings were being specified.

No more than five needle bars can be specified.

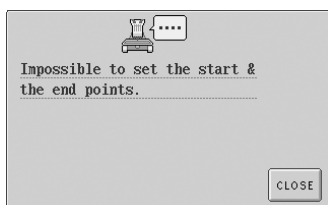

Sewing cannot begin from the specified starting position.

Change the starting position or move the frame and change the embroidering position. (Refer to page 89.)

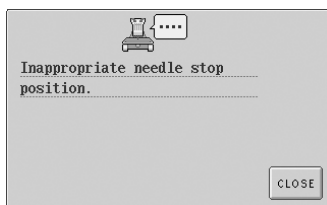

The needle has stopped at an incorrect position.

Turn the handwheel so that the mark on the handwheel is at the top.

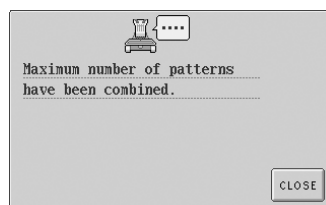

More than 101 patterns are being combined.

Reduce the number of patterns combined. Up to 101 patterns can be combined.

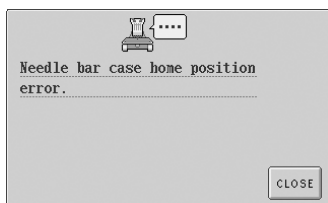

The needle bar case cannot be moved to its initial position.

Touch **CLOSE** to automatically reset the needle bar case.



The needle bar case has stopped at an incorrect position.

Touch **CLOSE** to automatically reset the needle bar case.

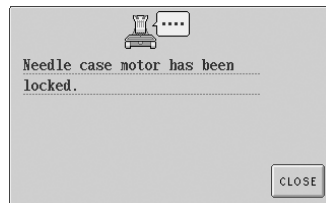

The needle bar case motor is locked.

Touch **CLOSE** to automatically reset the needle bar case.



The automatic needle-threading mechanism did not operate correctly.

The thread is entangled in the automatic needle-threading mechanism, remove the thread, and then touch **CLOSE**.

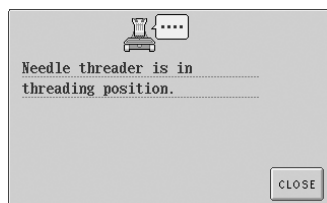

Another operation was performed while the automatic needle-threading mechanism was threading the needle.

Press the automatic needle threading button, and then perform the other operation after the needle is threaded. (Refer to page 39.)

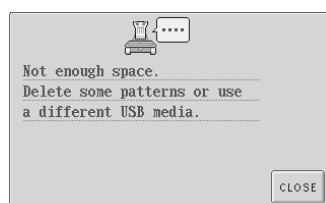

The USB media's memory capacity is exceeded to the limit.

There are too many data either in the machine or USB media.

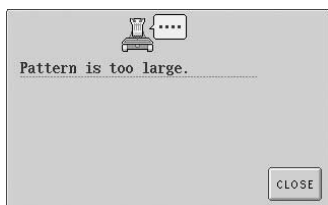

The pattern is too large.

Patterns larger than 200 mm (H) × 300 mm (W) (7-7/8 inches (H) × 11-3/4 inches (W)) cannot be used. Reduce the pattern to a size smaller than that specified.

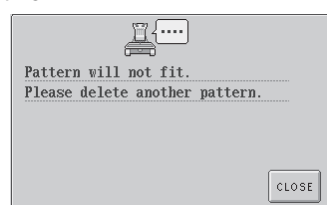

The memory capacity is exceeded to the limit.

Delete another data and try again.

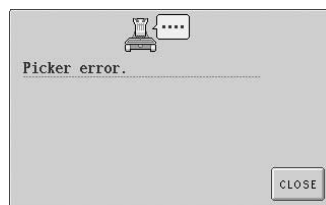

The thread picker did not operate correctly.

The thread is entangled on the thread picker, remove the thread.



Patterns stored in the machine's memory cannot be recalled.
The machine's memory may be damaged. Consult your nearest authorized dealer.



The machine couldn't save the data.
Try to use a different media.

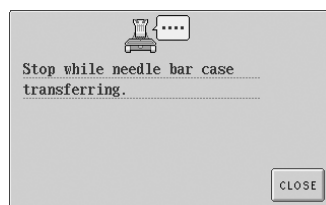

The machine was stopped while the needle bar case was moving.
Touch  to automatically reset the needle bar case.

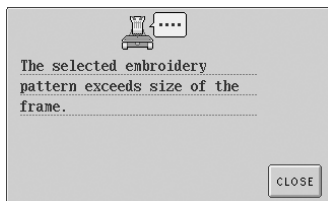

The pattern is larger than the embroidering area of the installed embroidery frame.
Use an embroidery frame with an embroidering area that is larger than the pattern.

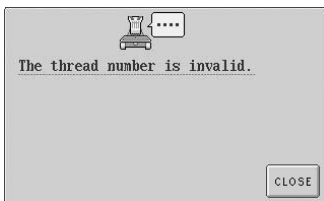

Thread color that was specified is incorrect.
The thread color number that was entered is not in the custom thread table setting. Check the number, and then try entering the number again.

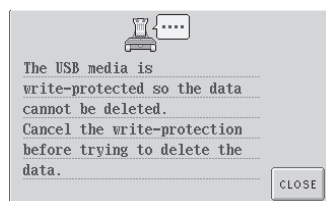

The USB media is write-protected.
Cancel the write protection.

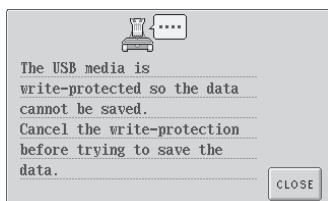

The USB media is write-protected.
Touch , and cancel the write protection.

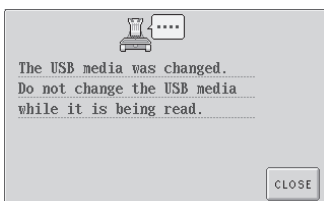

The USB media was attempted to change while it is being read.
Please try again without disconnecting.

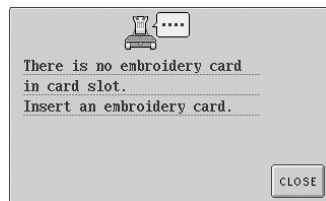

 **was touched while no embroidery card is inserted.**
Insert an embroidery card. (Refer to page 112.)

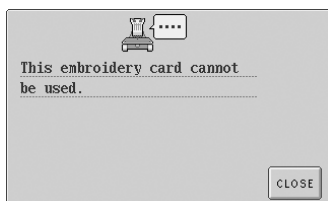

A pattern on an embroidery card not compatible with this machine was being recalled.
Some embroidery cards with copyrighted patterns cannot be used.



Embroidery data with an incompatible version is being used.
Embroidery data that is not complete or has an unknown version cannot be used.

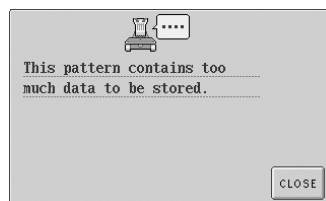

The pattern has too many stitches and cannot be used.
Data with stitches that exceed specifications (500,000 stitches) cannot be displayed. Use data design software to reduce the number of stitches.



More than 501 thread color changes are being specified in the pattern.
Up to 501 thread color changes can be specified in a pattern.

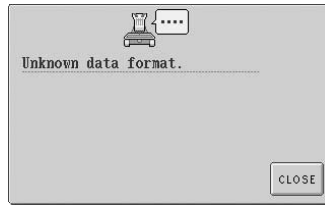

The embroidery data cannot be detected.
The embroidery data may be damaged.



USB media error
Touch , and try again. Or the USB media may be damaged.



USB media is not connected to the machine.
Connect a USB media.

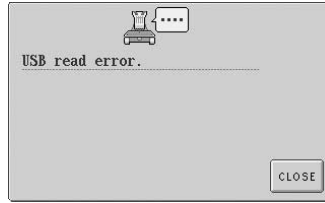

During data transfer, the USB cable was disconnected.
Do not disconnect the USB cable while data is being transferred. (Refer to page 114.)

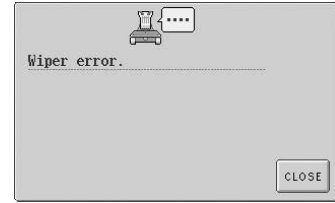

A wiper error occurred.
The thread is entangled on the wiper, remove the thread.

If any of the following messages appear, consult your nearest authorized dealer.

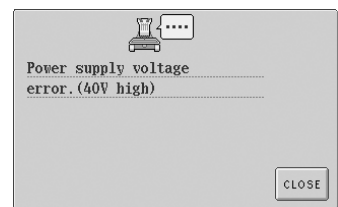
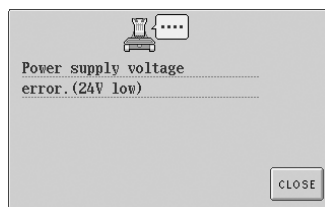
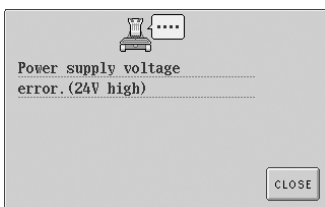
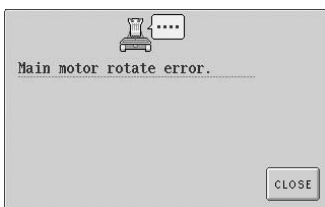
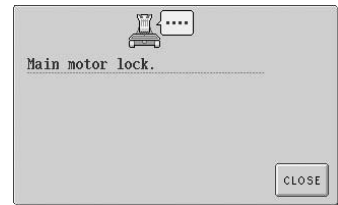
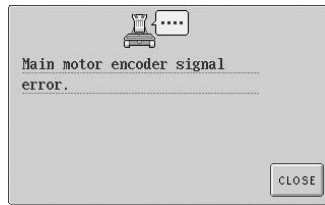
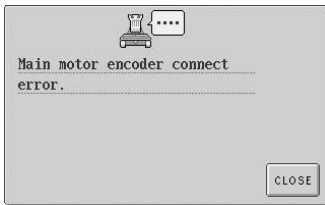
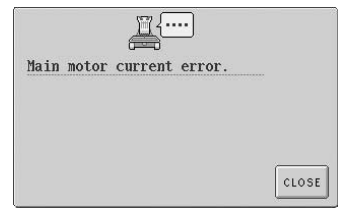
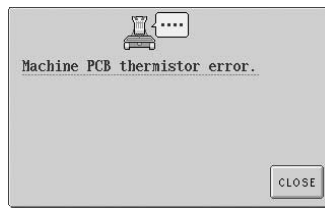
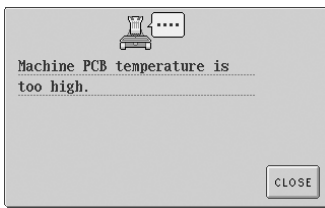
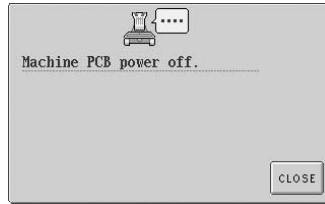
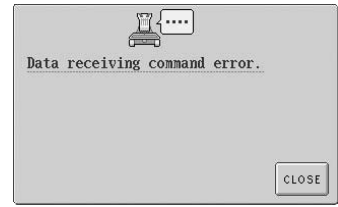
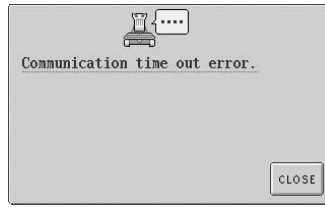
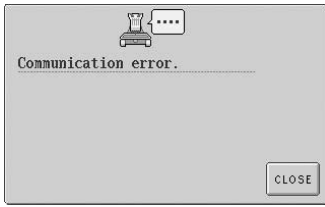

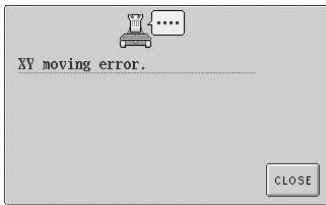
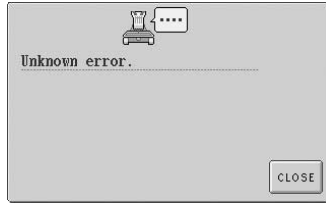
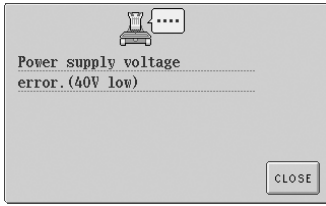

If the LCD cannot be read

If the LCD cannot be read after the machine is turned on, adjust the LCD as described below.

- 1 While touching anywhere inside the touch panel turn the machine off, then on again.

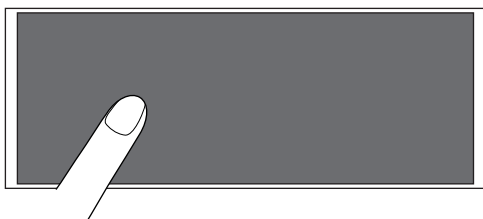

- Continue touching the touch panel until the screen shown below appears.
- The start/stop button does not light up.

- 2 Touch **-** and **+** to adjust the brightness of the screen so that the contents of the screens can be clearly viewed.

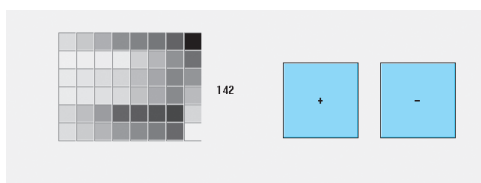

- 3 After making the necessary adjustment, turn the machine off, then on again.

If the machine does not respond when a key is pressed

If nothing happens when a key on the screen is touched (no key can be selected or the keys are misaligned), adjust the touch panel as described below.

- 1 Touch anywhere inside the touch panel, and turn the machine off, then on again.

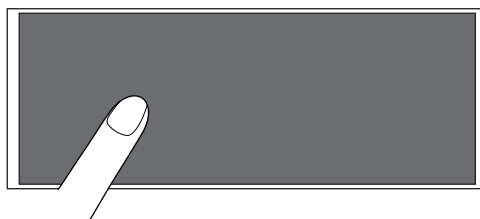

- Continue touching the touch panel until the screen shown below appears.
- The start/stop button does not light up.
- ▶ The screen shown below appears.

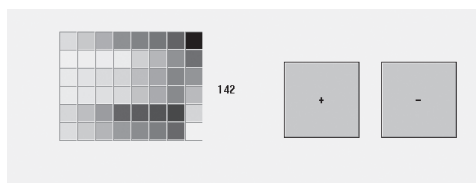

- 2 Press the thread trimming button.

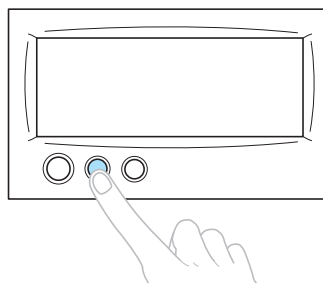

- ▶ The adjustments screen appears.

- 3** Use the included touch pen to touch the center of the crosses on the screen, from 1 to 5.

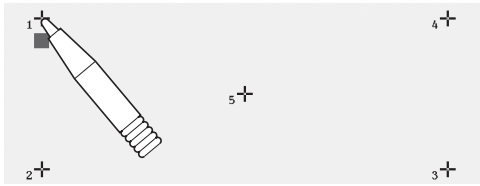

! CAUTION

- Be sure to use the included touch pen to adjust the touch panel. Do not use a mechanical pencil, screwdriver or any other hard or sharp object. Do not apply pressure to the LCD screen display, otherwise damage to the display may result.

- 4** Touch the center of the crosses in order from 1 to 5. After number 5 is touched, a buzzer will sound once to indicate that the adjustments were correctly made.

- If the buzzer sounds twice when cross number 5 is touched, an error occurred during setting. Touch the crosses again, starting from 1 to 5.

- 5** After making the necessary touch panel adjustment, turn the machine off, and on again.



Note

- If the keys still do not respond, even after the touch panel is adjusted, or if the touch panel cannot be adjusted, contact your nearest authorized dealer.

Specifications

Embroidery machine specifications

Item	Specification
Weight	37 kg (81 lbs.).
Machine size	512(W) x 589(D) x 586 (H) mm (20-5/32 (W) x 23-3/16 (D) x 23-1/16(H) inches)
Sewing speed	Maximum / Tubular: 1,000 spm, Cap: 600 spm Speed range / Max.: 1,000 spm, Min.: 400 spm
Hook Type	Vertical rotary hook
Hook size	Normal size (Type L)
Needle	HA130EBBR / #11
Number of needle	6 needles
Thread tension	Manual
Cap sewing	(Option) 130 mm (W) x 50 mm(H) (2 inches (H) x 5-1/8 inches (W))
Tubular sewing	(4 frames available) 300 mm (W) x 200 mm(H) (7-7/8 inches (H) x 11-3/4 inches (W)), 180 mm (W) x 130 mm(H) (5-1/8 inches (H) x 7-1/8 inches (W)), 100 mm (W) x 100 mm(H) (4 inches (H) x 4 inches (W)), 60 mm (W) x 40 mm(H) (1-1/2 inches (H) x 2-3/8 inches (W))
Thread trimming	Upper and lower thread
Thread breakage sensor	Yes / Upper thread and bobbin thread
Automatic needle threader	Yes
Communication with PC	USB port
Data storage	Original card and USB media

Index

Symbols

“DST” TRIM SETTING 140, 149

A

Accessories 4
 Adjusting
 angle 73
 cap frame driver 173
 edited patterns 120
 legs 8
 operation panel 9
 screen brightness 142, 213
 sewing speed 91
 thread tension 85
 touch panel 213
 Alphabet patterns 109
 Appliqué alphabet 107
 Appliqué sewing 156
 Array key 53, 111, 123
 Arrow key 72, 120
 Automatic lock stitch 88
 Automatic needle-threading button 3, 39
 Automatic needle-threading mechanism 39

B

Backing 165
 Basic procedures 17
 Bobbin 15, 18, 19
 Bobbin case 18, 19, 85, 195
 Bobbin winder 188
 Brightness of LCD 141, 142
 Buzzer 141, 142

C

Cancel key 51, 57
 Canton fleece 167
 Canvas 167
 Cap frame 169
 removing 184
 Cap frame driver 171
 adjusting 173
 Carriage 2
 Center cursor 145
 Centerpoint 144
 Change thread color key 53, 55, 92, 127
 Changing
 character spacing 124
 color thread table 149
 colors of the pattern 127, 131
 display guides 143
 embroidery position 72
 language 143
 size 103, 110, 121
 text arrangement of a character 123
 thread color display 145
 thread density 125
 thread spools 77

units of measurements 143

Checking

needle bars and thread colors 33
 preview image 27
 thread spool changes 75
 thread tension 45

Cleaning

around the needle plate 194
 bobbin case 195
 hook 193
 LCD 193
 machine surface 193

Color information 145

Color thread table 163

Combining patterns 119

Common screen 49

Corduroy 167

Cotton sheeting 167

Custom thread table 141, 147

D

Delete file key 112, 118

Delete key 53, 110

Deleting

pattern 128
 previously saved pattern 112, 118
 short stitches 150

Denim 167

Density key 53, 125

Display 16, 49

Display expanded color 140, 146

Display guides 143

Distance from center (horizontal) 52, 54

Distance from center (vertical) 52, 54

Dress shirt (woven) 167

E

Edit end key 53

Edit key 50, 55

Editing 25, 119, 129

 combined pattern 132

Embroidering

 corner of fabric 69

 repeating pattern 130

 small fabric 69

 tape or ribbon 69

Embroidering screen 33, 56

Embroidering settings screen 26, 54, 129

Embroidery

 basic method 42

 repeatedly sewing 90

Embroidery card slot 3

Embroidery cards 112

Embroidery data 100

Embroidery frame

 attaching to the machine 30

 hooping 28

 removing 46

types	65
Embroidery frame holder	
installing	185
removing	171
Embroidery frame indicators	28, 52, 54
Embroidery patterns	104
Embroidery position	72
Embroidery thread	35
Error messages	207
F	
Fabric	16, 69
removing	46
Fabric/stabilizer compatibility chart	167
Features	viii
Feet	2
Floral alphabet patterns	106
Forward/Backward stitch key	57, 79, 81
Frame patterns	108
Front view	2
G	
Golf shirt	167
Golf Style	170
Grid	144
H	
Handwheel	3, 197
Headwear	167
Help key	49, 153
Hook	193
Hook cover/Hook	2
Hooping	28, 67, 166
Horizontal mirror image key	51, 53, 103, 121
I	
Industrial embroidery frame	168
J	
Jump code	149
L	
Language	141, 143
LCD	3, 16, 49, 142, 213
Lingerie	167
Lock stitching key	55, 88
Locking mechanism	42
Locking the needle bar	72
Low Profile (Low fitting)	170
Lower thread guide	2
M	
Machine operations guide key	49, 151
Main power switch	3, 20, 47
Maintenance	151, 193
Manual needle bar settings	96
Maximum sewing speed key	55, 56
Merge key	53
Middle thread guide	2

Mounting jig	174
Moving	
needle	40
Multi color key	53, 126

N

Names of machine parts	2
Needle	15
changing	63
Needle bar case	2
Needle bar key	34, 56
Needle plate	194
New embroidery key	49
Next page key	51
Number of thread color changes	51, 52, 54

O

Oiling	196
Operation panel	2, 3, 9
Optional accessories	5

P

Pattern display area	49
Pattern editing screen	25, 52, 119
Pattern list screen	23, 51
Pattern selection key	53, 120
Pattern size	52, 54
Pattern type selection screen	23, 50
Positioning key	53, 55, 72, 120
Power supply cord	20, 47
Power supply plug	3
Preview key	51, 53, 55
Previewing the Image	27
Previous page key	51
Principal parts	2, 151

Q

Quit key	55
----------------	----

R

Region display	56
Remaining length	150
Renaissance Alphabet Patterns	105
Repeat key	55, 130
Repeat spacing (horizontal)	54, 131
Repeat spacing (vertical)	54, 131
Reserve stop key	57, 92, 94
Reserved needle	96, 141
Retrieving	
from Computer (USB)	114
from Embroidery cards	112
from memory	111
from USB media	117
Right-side/rear view	3
Rotate all key	55, 73, 129
Rotate key	53, 122
Rotation angle	52, 54

S	
Satin jacket	167
Screen	16, 21, 22, 49
Selecting	
edited pattern	120
embroidery pattern	23, 102
Set key	51
Setting up	6
Settings key	49, 140
Sewing	
appliqué	156
pattern aligned with a mark on the fabric	161
Sewing key	55
Sewing light	2
Sewing order	56
Sewing speed	91
Sewing the embroidery	42
Sewing time	56
Short stitch delete	140, 150
Silk	167
Six-needle machine	viii
Size (horizontal)	51, 52
Size (vertical)	51, 52
Size key	51, 53, 103, 121
Spacing key	53, 124
Specifications	215
Spool	36
Spool change indicator	56, 76
Spool stand	2, 11
Stabilizer	66, 165, 167
Standard Tail	140, 150
Standard(Pro Style)	170
Start/stop button	3, 42
Starting/ending position key	55, 89, 90
Stitch count	56
Stopping embroidering	44
Store key	55
Sweater knit	167
Sweatshirt	167
T	
Tajima data	101, 149, 163
Temporary needle bar setting key	57, 94
Tension dial	45, 86
Terry cloth	167
Thread	15, 16, 35, 164
Thread color	131, 146, 163
Thread color display	145
Thread color set up display	56
Thread guide	2, 36
Thread guide assembly support	2
Thread guide pins	2
Thread spools	77
Thread tension	85, 192
Thread tension disc	37
Thread tension knobs	2, 86
Thread trimming button	3, 44
Threading	
needle	39
upper thread	33, 35
Touch panel	3
Trial sewing key	32, 55
Troubleshooting	151, 198
T-shirt	167
U	
Units of measurements	141, 143
Unlock key	42, 57
Upper thread guide	2
Upper threading	33
USB host	3
USB media	117, 137
USB port connector	3
V	
Ventilation slots	3
Version	140
Vertical mirror image key	51, 53, 103, 121



brother®