

# **GA-A55M-DS2**

## **User's Manual**

Rev. 1001

12ME-A55MDS2-1001R

## Declaration of Conformity

We, Manufacturer  
**G.B.T. Technology Trading GmbH**  
**Bültenkoppl 16, 22047 Hamburg, Germany**

(description of the apparatus, system, installation to which it refers)

declares that the product  
**0107100-2-2**  
**GA-A55M-DS2**

(reference to the specification under which conformity is claimed)  
in accordance with the EMC Directive 2004/108/E

EN 55011  
Limits and methods of measurement  
of radio disturbance characteristics of  
high frequency equipment

EN 1000-3-2  
 EN 1000-3-3

Disturbances in supply systems caused  
by household appliances and similar  
electrical equipment "Voltage fluctuations"

EN 55013  
Limits and methods of measurement  
of radio disturbance characteristics of  
broadcast receivers and associated  
equipment

EN 5024

Information Technology  
equipment-Immunity  
characteristics-Limits and methods of  
measurement

EN 55014-1  
Limits and methods of measurement  
of radio disturbance characteristics of  
portable tools and similar electrical  
apparatus

EN 50082-1  
 EN 50082-2

Generic immunity standard Part 1:  
Residual, commercial and light industry  
Generic immunity standard Part 2:  
Industrial environment

EN 55015  
Limits and methods of measurement  
of radio disturbance characteristics of  
fluorescent lamps and luminaires

EN 55014-2  
 EN 50091-2

Immunity requirements for household  
appliances tools and similar apparatus  
EMC requirements for uninterruptible  
power systems (UPS)

EN 55022  
Limits and methods of measurement  
of radio disturbance characteristics of  
information technology equipment

EN 55022  
 part 10  
 part 11

CE  
(EC conformity marking)

CE marking

EN 60085  
Safety requirements for mains operated  
electronic and related apparatus for  
household and similar general use

EN 60950

Safety for information technology equipment  
including electrical business equipment

EN 60335  
Safety of household and similar  
electrical appliances

EN 50091-1

General and Safety requirements for  
uninterruptible power systems (UPS)

Manufacturer/Importer

Signature: *Timmy Huang*

(Stamp)

Date: Aug 26, 2011

Name: Timmy Huang

## DECLARATION OF CONFORMITY

Per FCC Part 2 Section 2.1077(a)



Responsible Party Name: G.B.T. INC. (U.S.A)

Address: 17388 Railroad Street

City of Industry, CA 91748

Phone/Fax No: (818) 854-9336 / (818) 854-9339

hereby declares that the product

Product Name: **Motherboard**

Model Number: **GA-A55M-DS2**

Conforms to the following specifications:

FCC Part 15, Subpart B, Section 15.107(a) and Section 15.109

(a), Class B Digital Device

### Supplementary Information:

This device complies with part 15 of the FCC Rules. Operation is  
subject to the following two conditions: (1) This device may not  
cause harmful and (2) this device must accept any interference received,  
including that may cause undesired operation.

Representative Person's Name: ERIC LU

Signature: *Eric Lu*

Date: Aug 26, 2011

## **Copyright**

© 2011 GIGA-BYTE TECHNOLOGY CO., LTD. All rights reserved.

The trademarks mentioned in this manual are legally registered to their respective owners.

## **Disclaimer**

Information in this manual is protected by copyright laws and is the property of GIGABYTE. Changes to the specifications and features in this manual may be made by GIGABYTE without prior notice. No part of this manual may be reproduced, copied, translated, transmitted, or published in any form or by any means without GIGABYTE's prior written permission.

- In order to assist in the use of this product, carefully read the User's Manual.
- For product-related information, check on our website at: <http://www.gigabyte.com>

## **Identifying Your Motherboard Revision**

The revision number on your motherboard looks like this: "REV: X.X." For example, "REV: 1.0" means the revision of the motherboard is 1.0. Check your motherboard revision before updating motherboard BIOS, drivers, or when looking for technical information.

Example:

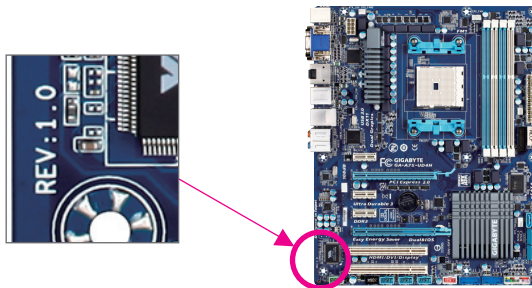

# Table of Contents

GA-A55M-DS2 Motherboard Layout.....	5
GA-A55M-DS2 Motherboard Block Diagram.....	6
Chapter 1 Hardware Installation .....	7
1-1 Installation Precautions .....	7
1-2 Product Specifications .....	8
1-3 Installing the APU .....	10
1-4 Installing the Memory .....	11
1-5 Installing an Expansion Card.....	11
1-6 Setup of the AMD Dual Graphics Configuration .....	12
1-7 Back Panel Connectors .....	13
1-8 Internal Connectors .....	14
Chapter 2 BIOS Setup .....	21
2-1 Startup Screen.....	21
2-2 The Main Menu.....	22
2-3 MB Intelligent Tweaker(M.I.T.) .....	23
2-4 Standard CMOS Features .....	27
2-5 Advanced BIOS Features .....	28
2-6 Integrated Peripherals .....	29
2-7 Power Management Setup .....	31
2-8 PC Health Status .....	33
2-9 Load Fail-Safe Defaults .....	34
2-10 Load Optimized Defaults .....	34
2-11 Set Supervisor/User Password .....	35
2-12 Save & Exit Setup.....	35
2-13 Exit Without Saving.....	36
Chapter 3 Drivers Installation .....	36
Chapter 4 Appendix .....	37
4-1 Configuring SATA Hard Drive(s).....	37
4-2 Regulatory Statements.....	39

# GA-A55M-DS2 Motherboard Layout

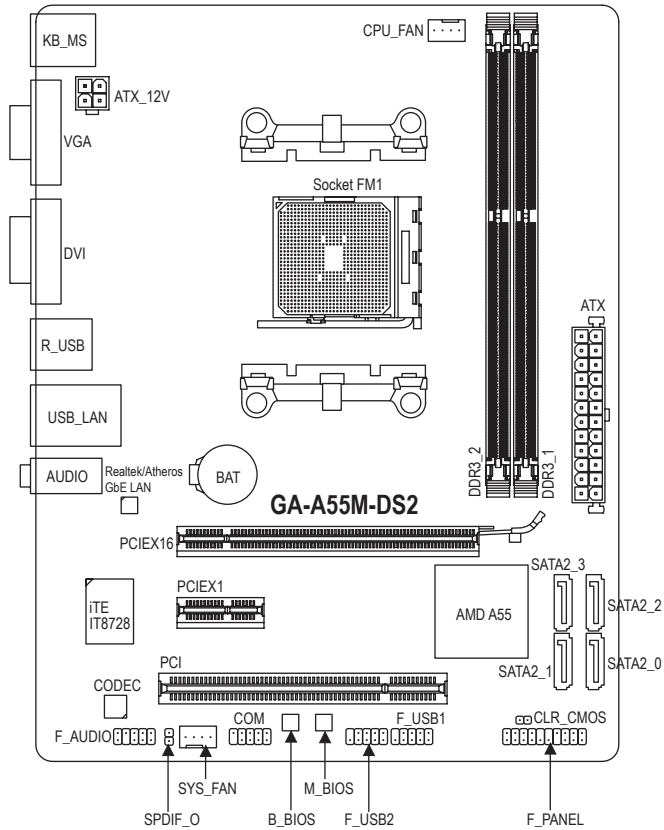

## Box Contents

- GA-A55M-DS2 motherboard
- Two SATA cables
- I/O Shield
- Motherboard driver disk
- User's Manual

\* The box contents above are for reference only and the actual items shall depend on the product package you obtain.

# GA-A55M-DS2 Motherboard Block Diagram

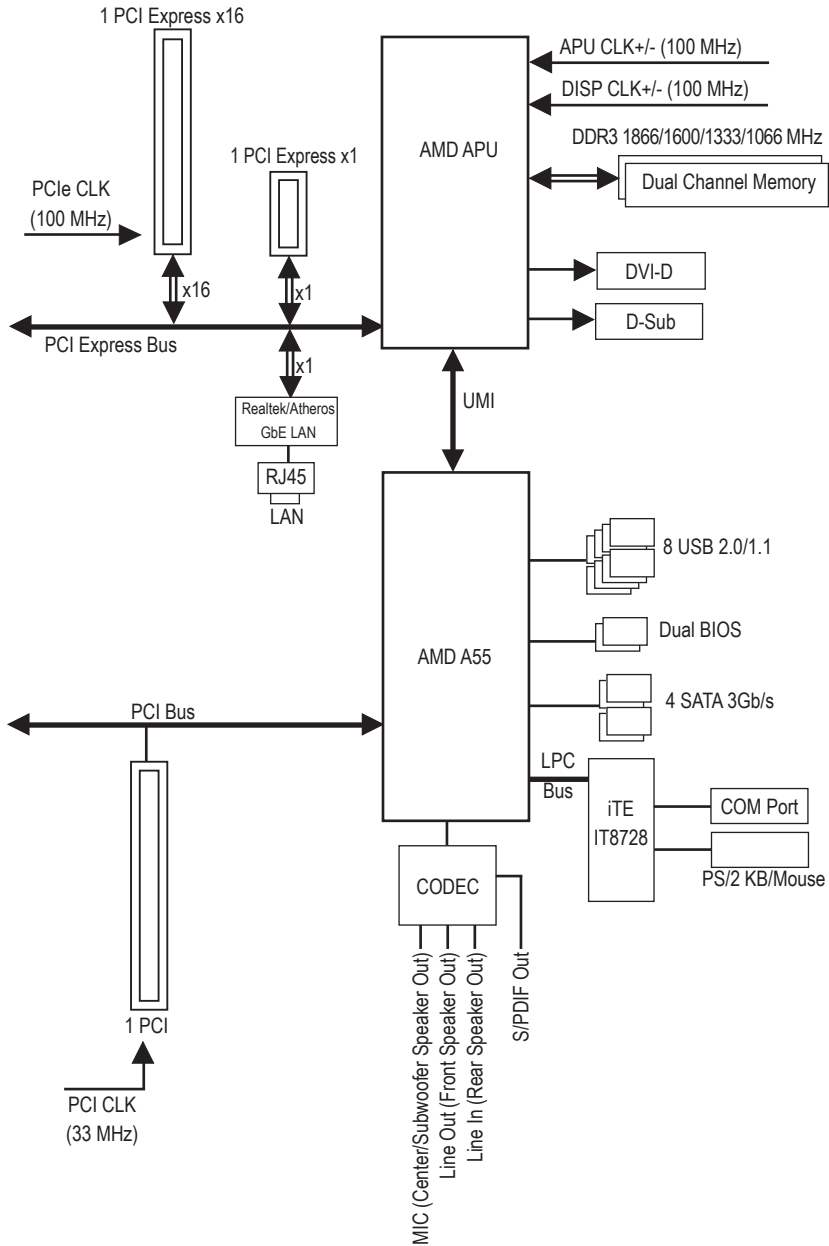











# Chapter 1 Hardware Installation

## 1-1 Installation Precautions

The motherboard contains numerous delicate electronic circuits and components which can become damaged as a result of electrostatic discharge (ESD). Prior to installation, carefully read the user's manual and follow these procedures:



- Prior to installation, do not remove or break motherboard S/N (Serial Number) sticker or warranty sticker provided by your dealer. These stickers are required for warranty validation.
- Always remove the AC power by unplugging the power cord from the power outlet before installing or removing the motherboard or other hardware components.
- When connecting hardware components to the internal connectors on the motherboard, make sure they are connected tightly and securely.
- When handling the motherboard, avoid touching any metal leads or connectors.
- It is best to wear an electrostatic discharge (ESD) wrist strap when handling electronic components such as a motherboard, APU or memory. If you do not have an ESD wrist strap, keep your hands dry and first touch a metal object to eliminate static electricity.
- Prior to installing the motherboard, please have it on top of an antistatic pad or within an electrostatic shielding container.
- Before unplugging the power supply cable from the motherboard, make sure the power supply has been turned off.
- Before turning on the power, make sure the power supply voltage has been set according to the local voltage standard.
- Before using the product, please verify that all cables and power connectors of your hardware components are connected.
- To prevent damage to the motherboard, do not allow screws to come in contact with the motherboard circuit or its components.
- Make sure there are no leftover screws or metal components placed on the motherboard or within the computer casing.
- Do not place the computer system on an uneven surface.
- Do not place the computer system in a high-temperature environment.
- Turning on the computer power during the installation process can lead to damage to system components as well as physical harm to the user.
- If you are uncertain about any installation steps or have a problem related to the use of the product, please consult a certified computer technician.

## 1-2 Product Specifications

 APU	<ul style="list-style-type: none"> <li>◆ FM1 Socket:               <ul style="list-style-type: none"> <li>- AMD A series processors/AMD E2 series processors</li> <li>(Go to GIGABYTE's website for the latest APU support list.)</li> </ul> </li> </ul>
 Chipset	<ul style="list-style-type: none"> <li>◆ AMD A55</li> </ul>
 Memory	<ul style="list-style-type: none"> <li>◆ 2 x 1.5V DDR3 DIMM sockets supporting up to 32 GB of system memory               <ul style="list-style-type: none"> <li>* Due to Windows 32-bit operating system limitation, when more than 4 GB of physical memory is installed, the actual memory size displayed will be less than 4 GB.</li> </ul> </li> <li>◆ Dual channel memory architecture</li> <li>◆ Support for DDR3 1866/1600/1333/1066 MHz memory modules (Go to GIGABYTE's website for the latest supported memory speeds and memory modules.)</li> </ul>
 Onboard Graphics	<ul style="list-style-type: none"> <li>◆ APU:               <ul style="list-style-type: none"> <li>- 1 x D-Sub port</li> <li>- 1 x DVI-D port, supporting a maximum resolution of 1920x1200</li> <li>* The DVI-D port does not support D-Sub connection by adapter.</li> </ul> </li> <li>(All integrated graphics ports do not support Hot plug. If you want to change to another graphics port when the computer is on, be sure to turn off the computer first.)</li> </ul>
 Audio	<ul style="list-style-type: none"> <li>◆ Realtek/VIA HD audio codec</li> <li>◆ High Definition Audio</li> <li>◆ 2/4/5.1/7.1-channel               <ul style="list-style-type: none"> <li>* To configure 7.1-channel audio, you have to use an HD front panel audio module and enable the multi-channel audio feature through the audio driver.</li> </ul> </li> <li>◆ Support for S/PDIF Out</li> </ul>
 LAN	<ul style="list-style-type: none"> <li>◆ 1 x Realtek/Atheros GbE LAN chip (10/100/1000 Mbit)</li> </ul>
 Expansion Slots	<ul style="list-style-type: none"> <li>◆ 1 x PCI Express x16 slot, running at x16</li> <li>◆ 1 x PCI Express x1 slot</li> <li>(All PCI Express slots conform to the PCI Express 2.0 standard.)</li> <li>◆ 1 x PCI slot</li> </ul>
 Multi-Graphics Technology	<ul style="list-style-type: none"> <li>◆ Support for AMD Dual Graphics technology               <ul style="list-style-type: none"> <li>* Only A series APUs support AMD Dual Graphics.</li> </ul> </li> </ul>
 Storage Interface	<ul style="list-style-type: none"> <li>◆ Chipset:               <ul style="list-style-type: none"> <li>- 4 x SATA 3Gb/s connectors supporting up to 4 SATA 3Gb/s devices</li> <li>- Support for RAID 0, RAID 1, RAID 10, and JBOD</li> </ul> </li> </ul>
 USB	<ul style="list-style-type: none"> <li>◆ Chipset:               <ul style="list-style-type: none"> <li>- Up to 8 USB 2.0/1.1 ports (4 ports on the back panel, 4 ports available through the internal USB headers)</li> </ul> </li> </ul>
 Internal Connectors	<ul style="list-style-type: none"> <li>◆ 1 x 24-pin ATX main power connector</li> <li>◆ 1 x 4-pin ATX 12V power connector</li> <li>◆ 4 x SATA 3Gb/s connectors</li> </ul>



	Internal Connectors	<ul style="list-style-type: none"> <li>◆ 1 x APU fan header</li> <li>◆ 1 x system fan header</li> <li>◆ 1 x front panel header</li> <li>◆ 1 x front panel audio header</li> <li>◆ 1 x S/DPDIF Out header</li> <li>◆ 2 x USB 2.0/1.1 headers</li> <li>◆ 1 x serial port header</li> <li>◆ 1 x clearing CMOS jumper</li> </ul>
	Back Panel Connectors	<ul style="list-style-type: none"> <li>◆ 1 x PS/2 keyboard port</li> <li>◆ 1 x PS/2 mouse port</li> <li>◆ 1 x D-Sub port</li> <li>◆ 1 x DVI-D port</li> <li>◆ 4 x USB 2.0/1.1 ports</li> <li>◆ 1 x RJ-45 port</li> <li>◆ 3 x audio jacks (Line In/Line Out/Microphone)</li> </ul>
	I/O Controller	<ul style="list-style-type: none"> <li>◆ iTE IT8728 chip</li> </ul>
	Hardware Monitor	<ul style="list-style-type: none"> <li>◆ System voltage detection</li> <li>◆ APU/System temperature detection</li> <li>◆ APU/System fan speed detection</li> <li>◆ APU overheating warning</li> <li>◆ APU/System fan fail warning</li> <li>◆ APU/System fan speed control <ul style="list-style-type: none"> <li>* Whether the APU/system fan speed control function is supported will depend on the APU/system cooler you install.</li> </ul> </li> </ul>
	BIOS	<ul style="list-style-type: none"> <li>◆ 2 x 32 Mbit flash</li> <li>◆ Use of licensed AWARD BIOS</li> <li>◆ Support for DualBIOS™</li> <li>◆ PnP 1.0a, DMI 2.0, SM BIOS 2.4, ACPI 1.0b</li> </ul>
	Unique Features	<ul style="list-style-type: none"> <li>◆ Support for @BIOS</li> <li>◆ Support for Q-Flash</li> <li>◆ Support for Xpress BIOS Rescue</li> <li>◆ Support for Download Center</li> <li>◆ Support for Xpress Install</li> <li>◆ Support for Xpress Recovery2</li> <li>◆ Support for EasyTune <ul style="list-style-type: none"> <li>* Available functions in EasyTune may differ by motherboard model.</li> </ul> </li> <li>◆ Support for Smart Recovery</li> <li>◆ Support for Auto Green</li> <li>◆ Support for ON/OFF Charge</li> <li>◆ Support for 3TB+ Unlock</li> <li>◆ Support for Q-Share</li> </ul>

 Bundled Software	◆ Norton Internet Security (OEM version)
 Operating System	◆ Support for Microsoft® Windows 7/Vista/XP
 Form Factor	◆ Micro ATX Form Factor; 22.5cm x 17.4cm

\* GIGABYTE reserves the right to make any changes to the product specifications and product-related information without prior notice.

## 1-3 Installing the APU



Read the following guidelines before you begin to install the APU:

- Make sure that the motherboard supports the APU.  
(Go to GIGABYTE's website for the latest APU support list.)
- Always turn off the computer and unplug the power cord from the power outlet before installing the APU to prevent hardware damage.
- Locate the pin one of the APU. The APU cannot be inserted if oriented incorrectly.
- Apply an even and thin layer of thermal grease on the surface of the APU.
- Do not turn on the computer if the APU cooler is not installed, otherwise overheating and damage of the APU may occur.
- Set the APU host frequency in accordance with the APU specifications. It is not recommended that the system bus frequency be set beyond hardware specifications since it does not meet the standard requirements for the peripherals. If you wish to set the frequency beyond the standard specifications, please do so according to your hardware specifications including the APU, graphics card, memory, hard drive, etc.

### Installing the APU

- A. Locate the pin one (denoted by a small triangle) of the APU socket and the APU.

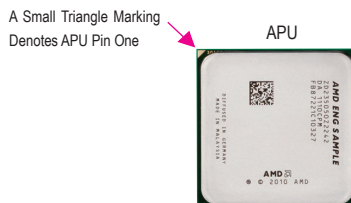
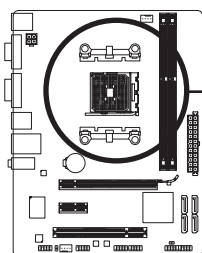

## 1-4 Installing the Memory



Read the following guidelines before you begin to install the memory:

- Make sure that the motherboard supports the memory. It is recommended that memory of the same capacity, brand, speed, and chips be used.  
(Go to GIGABYTE's website for the latest supported memory speeds and memory modules.)
- Always turn off the computer and unplug the power cord from the power outlet before installing the memory to prevent hardware damage.
- Memory modules have a foolproof design. A memory module can be installed in only one direction. If you are unable to insert the memory, switch the direction.

### Dual Channel Memory Configuration

This motherboard provides two DDR3 memory sockets and supports Dual Channel Technology. After the memory is installed, the BIOS will automatically detect the specifications and capacity of the memory. Enabling Dual Channel memory mode will double the original memory bandwidth.

The two DDR3 memory sockets are divided into two channels and each channel has one memory socket as following:

▶▶ Channel 0: DDR3\_2

▶▶ Channel 1: DDR3\_1

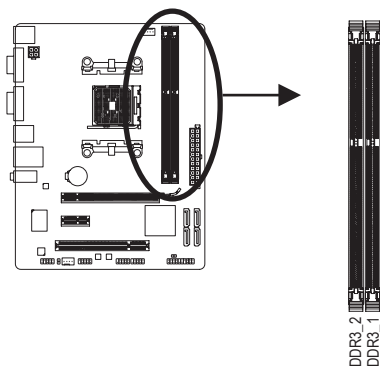

Due to APU limitations, read the following guidelines before installing the memory in Dual Channel mode.

1. Dual Channel mode cannot be enabled if only one DDR3 memory module is installed.
2. When enabling Dual Channel mode with two memory modules, it is recommended that memory of the same capacity, brand, speed, and chips be used for optimum performance.

## 1-5 Installing an Expansion Card



Read the following guidelines before you begin to install an expansion card:

- Make sure the motherboard supports the expansion card. Carefully read the manual that came with your expansion card.
- Always turn off the computer and unplug the power cord from the power outlet before installing an expansion card to prevent hardware damage.

## 1-6 Setup of the AMD Dual Graphics Configuration

Combining the onboard GPU with a discrete graphics card, AMD's Dual Graphics technology can provide significantly advanced display performance for AMD platform. Read the following instructions on configuring a Dual Graphics system.

### A. System Requirements

- AMD A series processor
- Windows 7 operating system
- An AMD Dual Graphics technology-supported motherboard and correct driver
- An AMD Radeon HD 6000 series graphics card that supports AMD Dual Graphics technology (for more details, please visit AMD's official website) and correct driver

### B. Installing the Graphics Cards and Configuring BIOS Setup

Step 1:

Observe the steps in "1-5 Installing an Expansion Card" and install an AMD Dual Graphics technology-supported graphics card on the PCIEX16 slot. Plug the monitor cable into the graphics card and start up your computer.

Step 2:

Enter BIOS Setup to set the following items under the **Advanced BIOS Features** menu:

- Set **UMA Frame Buffer Size** to **512MB** or **1024MB**.
- Set **Init Display First** to **Onboard**.

Save the settings and exit BIOS Setup. Power off your computer.

Step 3:

Remove the monitor cable from the graphics card and plug it into the integrated graphics port on the back panel and restart your computer.

### C. Configuring the Graphics Driver

After installing the graphics card driver in the operating system, go to the **AMD VISION Engine Control Center**. Browse to **Performance AMD CrossFire™** and ensure the **Enable CrossFire™** check box is selected.

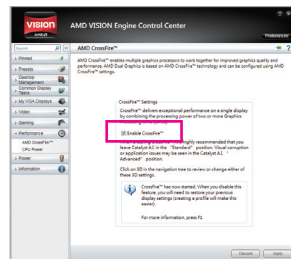

(Note) Make sure the drivers for the Chipset, onboard graphics, and external graphics card are properly installed.

## 1-7 Back Panel Connectors

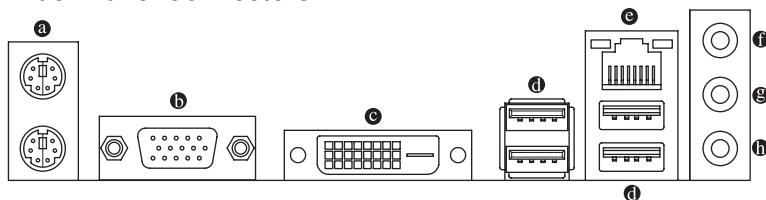

### a PS/2 Keyboard and PS/2 Mouse Port

Use the upper port (green) to connect a PS/2 mouse and the lower port (purple) to connect a PS/2 keyboard.

### b D-Sub Port (Note 1)

The D-Sub port supports a 15-pin D-Sub connector. Connect a monitor that supports D-Sub connection to this port.

### c DVI-D Port (Note 1)(Note 2)

The DVI-D port conforms to the DVI-D specification and supports a maximum resolution of 1920x1200 (the actual resolutions supported depend on the monitor being used). Connect a monitor that supports DVI-D connection to this port.

### d USB 2.0/1.1 Port

The USB port supports the USB 2.0/1.1 specification. Use this port for USB devices such as a USB keyboard/mouse, USB printer, USB flash drive and etc.

### e RJ-45 LAN Port

The Gigabit Ethernet LAN port provides Internet connection at up to 1 Gbps data rate. The following describes the states of the LAN port LEDs.

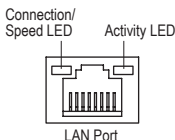

Connection/Speed LED:

State	Description
Orange	1 Gbps data rate
Green	100 Mbps data rate
Off	10 Mbps data rate

Activity LED:

State	Description
Blinking	Data transmission or receiving is occurring
Off	No data transmission or receiving is occurring

### f Line In Jack (Blue)

The default line in jack. Use this audio jack for line in devices such as an optical drive, walkman, etc.

### g Line Out Jack (Green)

The default line out jack. Use this audio jack for a headphone or 2-channel speaker. This jack can be used to connect front speakers in a 4/5.1/7.1-channel audio configuration.

### h Mic In Jack (Pink)

The default Mic in jack. Microphones must be connected to this jack.



To configure 7.1-channel audio, you have to use an HD front panel audio module and enable the multi-channel audio feature through the audio driver.



- When removing the cable connected to a back panel connector, first remove the cable from your device and then remove it from the motherboard.
- When removing the cable, pull it straight out from the connector. Do not rock it side to side to prevent an electrical short inside the cable connector.

(Note 1) All integrated graphics ports do not support Hot plug. If you want to change to another graphics port when the computer is on, be sure to turn off the computer first.

(Note 2) The DVI-D port does not support D-Sub connection by adapter.

## 1-8 Internal Connectors

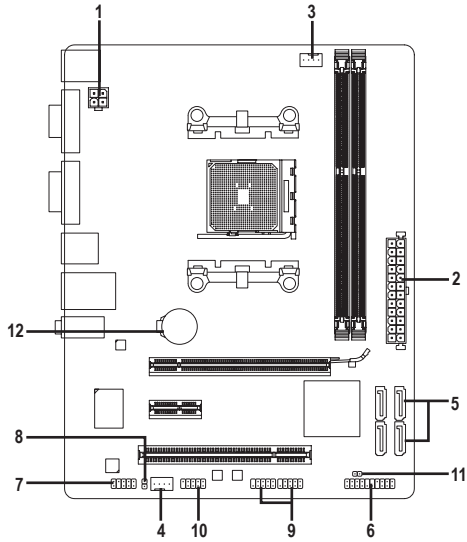

1) ATX_12V	7) F_AUDIO
2) ATX	8) SPDIF_O
3) CPU_FAN	9) F_USB1/F_USB2
4) SYS_FAN	10) COM
5) SATA2_0/1/2/3	11) CLR_CMOS
6) F_PANEL	12) BAT



Read the following guidelines before connecting external devices:

- First make sure your devices are compliant with the connectors you wish to connect.
- Before installing the devices, be sure to turn off the devices and your computer. Unplug the power cord from the power outlet to prevent damage to the devices.
- After installing the device and before turning on the computer, make sure the device cable has been securely attached to the connector on the motherboard.

## 1/2) ATX\_12V/ATX (2x2 12V Power Connector and 2x12 Main Power Connector)

With the use of the power connector, the power supply can supply enough stable power to all the components on the motherboard. Before connecting the power connector, first make sure the power supply is turned off and all devices are properly installed. The power connector possesses a foolproof design. Connect the power supply cable to the power connector in the correct orientation. The 12V power connector mainly supplies power to the APU. If the 12V power connector is not connected, the computer will not start.



To meet expansion requirements, it is recommended that a power supply that can withstand high power consumption be used (500W or greater). If a power supply is used that does not provide the required power, the result can lead to an unstable or unbootable system.

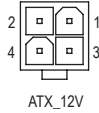
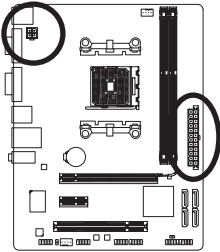

ATX\_12V:

Pin No.	Definition
1	GND
2	GND
3	+12V
4	+12V

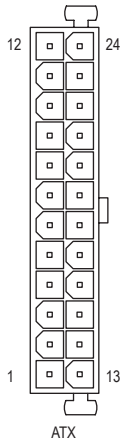

ATX:

Pin No.	Definition	Pin No.	Definition
1	3.3V	13	3.3V
2	3.3V	14	-12V
3	GND	15	GND
4	+5V	16	PS_ON (soft On/Off)
5	GND	17	GND
6	+5V	18	GND
7	GND	19	GND
8	Power Good	20	-5V
9	5VSB (stand by +5V)	21	+5V
10	+12V	22	+5V
11	+12V (Only for 2x12-pin ATX)	23	+5V (Only for 2x12-pin ATX)
12	3.3V (Only for 2x12-pin ATX)	24	GND (Only for 2x12-pin ATX)

### 3/4) CPU\_FAN/SYS\_FAN (Fan Headers)

The motherboard has a 4-pin CPU fan header (CPU\_FAN) and a 4-pin system fan header (SYS\_FAN). Most fan headers possess a foolproof insertion design. When connecting a fan cable, be sure to connect it in the correct orientation (the black connector wire is the ground wire). The motherboard supports APU fan speed control, which requires the use of a APU fan with fan speed control design. For optimum heat dissipation, it is recommended that a system fan be installed inside the chassis.

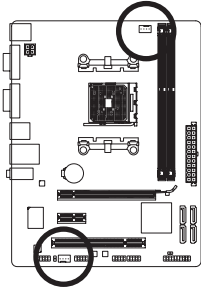

CPU\_FAN



SYS\_FAN

Pin No.	Definition
1	GND
2	+12V
3	Sense
4	Speed Control



- Be sure to connect fan cables to the fan headers to prevent your APU and system from overheating. Overheating may result in damage to the APU or the system may hang.
- These fan headers are not configuration jumper blocks. Do not place a jumper cap on the headers.

### 5) SATA2\_0/1/2/3 (SATA 3Gb/s Connectors)

The SATA connectors conform to SATA 3Gb/s standard and are compatible with SATA 1.5Gb/s standard. Each SATA connector supports a single SATA device. The AMD A55 Chipset supports RAID 0, RAID 1, RAID 10, and JBOD. Refer to Chapter 4, "Configuring SATA Hard Drive(s)," for instructions on configuring a RAID array.

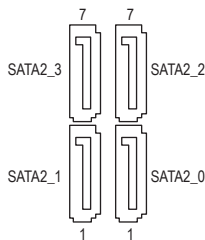
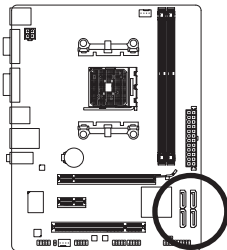

Pin No.	Definition
1	GND
2	TXP
3	TXN
4	GND
5	RXN
6	RXP
7	GND

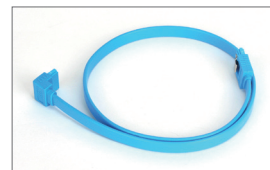

Please connect the L-shaped end of the SATA cable to your SATA hard drive.



- A RAID 0 or RAID 1 configuration requires at least two hard drives. If more than two hard drives are to be used, the total number of hard drives must be an even number.
- A RAID 10 configuration requires four hard drives.



## 6) F\_PANEL (Front Panel Header)

Connect the power switch, reset switch, speaker, and system status indicator on the chassis to this header according to the pin assignments below. Note the positive and negative pins before connecting the cables.

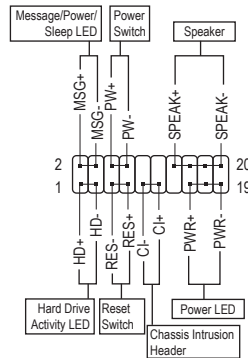
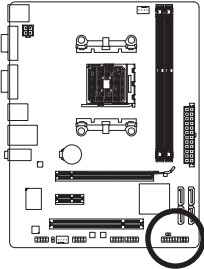

- **MSG/PWR** (Message/Power/Sleep LED):

System Status	LED
S0	On
S3/S4/S5	Off

Connects to the power status indicator on the chassis front panel. The LED is on when the system is operating. The LED is off when the system is in S3/S4 sleep state or powered off (S5).

- **PW** (Power Switch):

Connects to the power switch on the chassis front panel. You may configure the way to turn off your system using the power switch (refer to Chapter 2, "BIOS Setup," "Power Management Setup," for more information).

- **SPEAK** (Speaker):

Connects to the speaker on the chassis front panel. The system reports system startup status by issuing a beep code. One single short beep will be heard if no problem is detected at system startup. If a problem is detected, the BIOS may issue beeps in different patterns to indicate the problem.

- **HD** (Hard Drive Activity LED)

Connects to the hard drive activity LED on the chassis front panel. The LED is on when the hard drive is reading or writing data.

- **RES** (Reset Switch):

Connects to the reset switch on the chassis front panel. Press the reset switch to restart the computer if the computer freezes and fails to perform a normal restart.

- **CI** (Chassis Intrusion Header):

Connects to the chassis intrusion switch/sensor on the chassis that can detect if the chassis cover has been removed. This function requires a chassis with a chassis intrusion switch/sensor.



The front panel design may differ by chassis. A front panel module mainly consists of power switch, reset switch, power LED, hard drive activity LED, speaker and etc. When connecting your chassis front panel module to this header, make sure the wire assignments and the pin assignments are matched correctly.

## 7) F\_AUDIO (Front Panel Audio Header)

The front panel audio header supports Intel High Definition audio (HD) and AC'97 audio. You may connect your chassis front panel audio module to this header. Make sure the wire assignments of the module connector match the pin assignments of the motherboard header. Incorrect connection between the module connector and the motherboard header will make the device unable to work or even damage it.

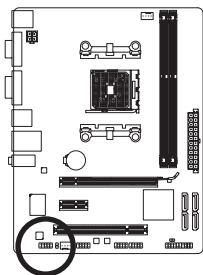

For HD Front Panel Audio:

Pin No.	Definition
1	MIC2_L
2	GND
3	MIC2_R
4	-ACZ_DET
5	LINE2_R
6	GND
7	FAUDIO_JD
8	No Pin
9	LINE2_L
10	GND

For AC'97 Front Panel Audio:

Pin No.	Definition
1	MIC
2	GND
3	MIC Power
4	NC
5	Line Out (R)
6	NC
7	NC
8	No Pin
9	Line Out (L)
10	NC



- The front panel audio header supports HD audio by default.
- Audio signals will be present on both of the front and back panel audio connections simultaneously.
- Some chassis provide a front panel audio module that has separated connectors on each wire instead of a single plug. For information about connecting the front panel audio module that has different wire assignments, please contact the chassis manufacturer.

## 8) SPDIF\_O (S/PDIF Out Header)

This header supports digital S/PDIF Out and connects a S/PDIF digital audio cable (provided by expansion cards) for digital audio output from your motherboard to certain expansion cards like graphics cards and sound cards. For example, some graphics cards may require you to use a S/PDIF digital audio cable for digital audio output from your motherboard to your graphics card if you wish to connect an HDMI display to the graphics card and have digital audio output from the HDMI display at the same time. For information about connecting the S/PDIF digital audio cable, carefully read the manual for your expansion card.

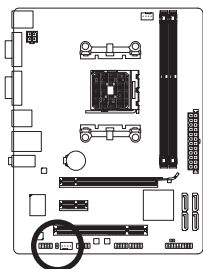

Pin No.	Definition
1	SPDIFO
2	GND

### 9) F\_USB1/F\_USB2 (USB 2.0/1.1 Headers)

The headers conform to USB 2.0/1.1 specification. Each USB header can provide two USB ports via an optional USB bracket. For purchasing the optional USB bracket, please contact the local dealer.

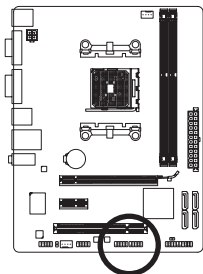

Pin No.	Definition
1	Power (5V)
2	Power (5V)
3	USB DX-
4	USB DY-
5	USB DX+
6	USB DY+
7	GND
8	GND
9	No Pin
10	NC



- Do not plug the IEEE 1394 bracket (2x5-pin) cable into the USB header.
- Prior to installing the USB bracket, be sure to turn off your computer and unplug the power cord from the power outlet to prevent damage to the USB bracket.

### 10) COM (Serial Port Header)

The COM header can provide one serial port via an optional COM port cable. For purchasing the optional COM port cable, please contact the local dealer.

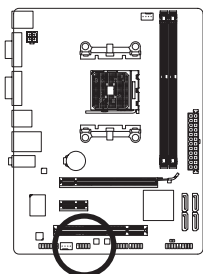

Pin No.	Definition
1	NDCD-
2	NSIN
3	NSOUT
4	NDTR-
5	GND
6	NDSR-
7	NRTS-
8	NCTS-
9	NRI-
10	No Pin

## 11) CLR\_CMOS (Clearing CMOS Jumper)

Use this jumper to clear the CMOS values (e.g. date information and BIOS configurations) and reset the CMOS values to factory defaults. To clear the CMOS values, place a jumper cap on the two pins to temporarily short the two pins or use a metal object like a screwdriver to touch the two pins for a few seconds.

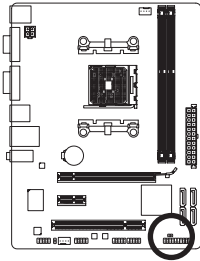

 Open: Normal

 Short: Clear CMOS Values



- Always turn off your computer and unplug the power cord from the power outlet before clearing the CMOS values.
- After clearing the CMOS values and before turning on your computer, be sure to remove the jumper cap from the jumper. Failure to do so may cause damage to the motherboard.
- After system restart, go to BIOS Setup to load factory defaults (select Load Optimized Defaults) or manually configure the BIOS settings (refer to Chapter 2, "BIOS Setup," for BIOS configurations).

## 12) BAT (Battery)

The battery provides power to keep the values (such as BIOS configurations, date, and time information) in the CMOS when the computer is turned off. Replace the battery when the battery voltage drops to a low level, or the CMOS values may not be accurate or may be lost.

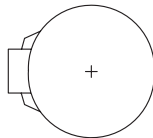
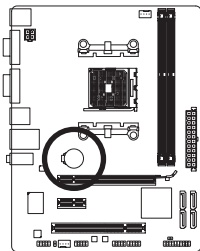

You may clear the CMOS values by removing the battery:

1. Turn off your computer and unplug the power cord.
2. Gently remove the battery from the battery holder and wait for one minute. (Or use a metal object like a screwdriver to touch the positive and negative terminals of the battery holder, making them short for 5 seconds.)
3. Replace the battery.
4. Plug in the power cord and restart your computer.



- Always turn off your computer and unplug the power cord before replacing the battery.
- Replace the battery with an equivalent one. Danger of explosion if the battery is replaced with an incorrect model.
- Contact the place of purchase or local dealer if you are not able to replace the battery by yourself or uncertain about the battery model.
- When installing the battery, note the orientation of the positive side (+) and the negative side (-) of the battery (the positive side should face up).
- Used batteries must be handled in accordance with local environmental regulations.

# Chapter 2 BIOS Setup

To access the BIOS Setup program, press the <Delete> key during the POST when the power is turned on. To see more advanced BIOS Setup menu options, you can press <Ctrl> + <F1> in the main menu of the BIOS Setup program.

To upgrade the BIOS, use either the GIGABYTE Q-Flash or @BIOS utility.

- Q-Flash allows the user to quickly and easily upgrade or back up BIOS without entering the operating system.
- @BIOS is a Windows-based utility that searches and downloads the latest version of BIOS from the Internet and updates the BIOS.



- Because BIOS flashing is potentially risky, if you do not encounter problems using the current version of BIOS, it is recommended that you not flash the BIOS. To flash the BIOS, do it with caution. Inadequate BIOS flashing may result in system malfunction.
- It is recommended that you not alter the default settings (unless you need to) to prevent system instability or other unexpected results. Inadequately altering the settings may result in system's failure to boot. If this occurs, try to clear the CMOS values and reset the board to default values. (Refer to the "Load Optimized Defaults" section in this chapter or introductions of the battery/clearing CMOS jumper in Chapter 1 for how to clear the CMOS values.)

## 2-1 Startup Screen

The following screens may appear when the computer boots.

### A. The LOGO Screen (Default):

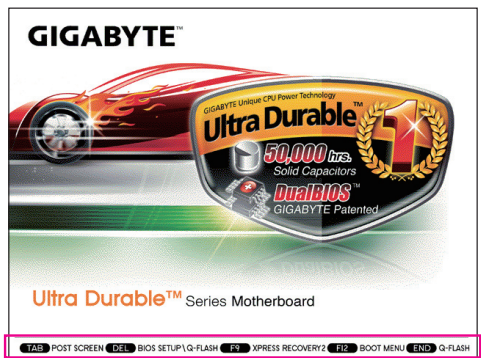

Function Keys

### B. The POST Screen

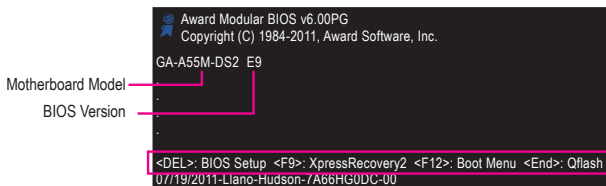

Function Keys

## 2-2 The Main Menu

Once you enter the BIOS Setup program, the Main Menu (as shown below) appears on the screen. Use arrow keys to move among the items and press <Enter> to accept or enter a sub-menu.

(Sample BIOS Version: E9)

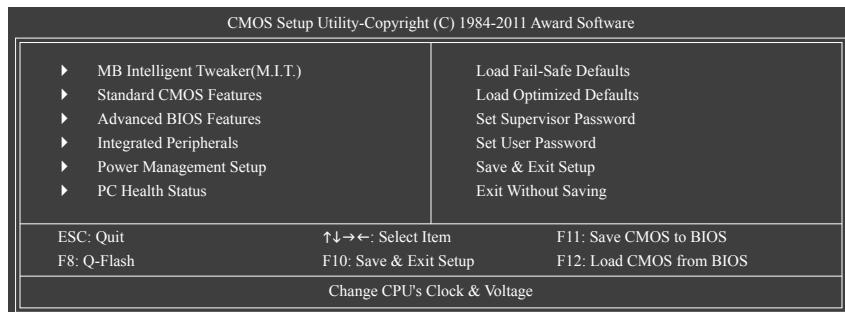

- If you do not find the settings you want in the Main Menu or a submenu, press <Ctrl>+<F1> to access more advanced options.
- When the system is not stable as usual, select the **Load Optimized Defaults** item to set your system to its defaults.
- The BIOS Setup menus described in this chapter are for reference only and may differ by BIOS version.

### ■ The Functions of the <F11> and <F12> keys (For the Main Menu Only)

#### ▶ F11: Save CMOS to BIOS

This function allows you to save the current BIOS settings to a profile. You can create up to 8 profiles (Profile 1-8) and name each profile. First enter the profile name (to erase the default profile name, use the SPACE key) and then press <Enter> to complete.

#### ▶ F12: Load CMOS from BIOS

If your system becomes unstable and you have loaded the BIOS default settings, you can use this function to load the BIOS settings from a profile created before, without the hassles of reconfiguring the BIOS settings. First select the profile you wish to load, then press <Enter> to complete.

## 2-3 MB Intelligent Tweaker(M.I.T.)

CMOS Setup Utility-Copyright (C) 1984-2011 Award Software  
MB Intelligent Tweaker(M.I.T.)

			Item Help
▶ IGX Configuration	[Press Enter]		Menu Level ▶
CPU Clock Ratio	[Auto]	2400Mhz	
Core Performance Boost <sup>(Note)</sup>	[Enabled]		
CPB Ratio <sup>(Note)</sup>	[Auto]	2400Mhz	
CPU Host Clock Control	[Auto]		
x CPU Host Clock		100	
PCIe Spread Spectrum	[Disabled]		
Set Memory Clock	[Auto]		
x Memory Clock		x6.66 1333Mhz	
▶ DRAM Configuration	[Press Enter]		
***** System Voltage Optimized *****			
System Voltage Control	[Auto]		
x DDR3 Voltage Control		Auto	
x FCH Voltage Control		Auto	
x APU VDDP Voltage Control		Auto	
x CPU VCORE NB Control		Auto	
x CPU VCORE Control		Auto	
Normal CPU Vcore		1.3875V	

↑↓→←: Move    Enter: Select    +/-/PU/PD: Value    F10: Save    ESC: Exit    F1: General Help  
F5: Previous Values    F6: Fail-Safe Defaults    F7: Optimized Defaults



- Whether the system will work stably with the overclock/overvoltage settings you made is dependent on your overall system configurations. Incorrectly doing overclock/overvoltage may result in damage to CPU, chipset, or memory and reduce the useful life of these components. This page is for advanced users only and we recommend you not to alter the default settings to prevent system instability or other unexpected results. (Inadequately altering the settings may result in system's failure to boot. If this occurs, clear the CMOS values and reset the board to default values.)
- When the **System Voltage Optimized** item blinks in red, it is recommended that you set the **System Voltage Control** item to **Auto** to optimize the system voltage settings.

### IGX Configuration

CMOS Setup Utility-Copyright (C) 1984-2011 Award Software  
IGX Configuration

			Item Help
UMA Frame Buffer Size	[Auto]		Menu Level ▶▶
VGA Core Clock control	[Auto]		
x VGA Core Clock(MHz)		600	

↑↓→←: Move    Enter: Select    +/-/PU/PD: Value    F10: Save    ESC: Exit    F1: General Help  
F5: Previous Values    F6: Fail-Safe Defaults    F7: Optimized Defaults

#### UMA Frame Buffer Size

Frame buffer size is the total amount of system memory allocated solely for the onboard graphics controller. MS-DOS, for example, will use only this memory for display. Options are: Auto (default), 256MB, 512MB, 1024MB.

#### VGA Core Clock control

Allows you to determine whether to manually set the VGA Core clock. (Default: Auto)

#### VGA Core Clock(MHz)

Allows you to manually set the VGA Core clock. The adjustable range is from 300 MHz to 2000 MHz. This item is configurable only if the **VGA Core Clock control** option is set to **Manual**.

(Note) This item is present only when you install a CPU that supports this feature.

☞ **CPU Clock Ratio**

Allows you to alter the clock ratio for the installed CPU. The adjustable range is dependent on the CPU being installed.

☞ **Core Performance Boost** <sup>(Note)</sup>

Allows you to determine whether to enable the Core Performance Boost (CPB) technology, a CPU performance-boost technology. (Default: Enabled)

☞ **CPB Ratio** <sup>(Note)</sup>

Allows you alter the ratio for the CPB. The adjustable range is dependent on the CPU being installed. (Default: Auto)

☞ **CPU Host Clock Control**

Enables or disables the control of CPU host clock. **Auto** (default) allows the BIOS to automatically adjust the CPU host frequency. **Manual** allows the **CPU Frequency (MHz)** item below to be configurable.

Note: If your system fails to boot after overclocking, please wait for 20 seconds to allow for automated system reboot, or clear the CMOS values to reset the board to default values.

☞ **CPU Host Clock**

Allows you to manually set the CPU host frequency.. This option is configurable only when **CPU Host Clock Control** is set to **Manual**. **Important** It is highly recommended that the CPU frequency be set in accordance with the CPU specifications.

☞ **PCIe Spread Spectrum**

Enables or disables PCIe Spread Spectrum. (Default: Disabled)

☞ **Set Memory Clock**

Determines whether to manually set the memory clock. **Auto** lets BIOS automatically set the memory clock as required. **Manual** allows the memory clock control item below to be configurable. (Default: Auto)

☞ **Memory Clock**

This option is configurable only when **Set Memory Clock** is set to **Manual**.

- ▶▶ X5.33      Sets Memory Clock to X5.33.
- ▶▶ X6.66      Sets Memory Clock to X6.66.
- ▶▶ X8.00      Sets Memory Clock to X8.00.
- ▶▶ X9.33      Sets Memory Clock to X9.33.

(Note) This item is present only when you install a CPU that supports this feature.



## ☞ DRAM Configuration

CMOS Setup Utility-Copyright (C) 1984-2011 Award Software				
DRAM Configuration				
DDR3 Timing Items	[Auto]	SPD	Auto	Item Help
x 1T/2T Command Timing	Auto	--	--	Menu Level ▶
x CAS# latency	Auto	9T	9T	
x RAS to CAS R/W Delay	Auto	9T	9T	
x Row Precharge Time	Auto	9T	9T	
x Minimum RAS Active Time	Auto	24T	24T	
x TwTr Command Delay	Auto	5T	5T	
x Trfc0 for DIMM2	Auto	110ns	110ns	
x Trfc1 for DIMM1	Auto	--	--	
x Write Recovery Time	Auto	10T	6T	
x Precharge Time	Auto	5T	4T	
x Row Cycle Time	Auto	33T	20T	
x RAS to RAS Delay	Auto	4T	4T	
x Four Bank Activate Windows	Auto	--	--	
Bank Interleaving	[Enabled]			

↑↓←→: Move    Enter: Select    +/-/PU/PD: Value    F10: Save    ESC: Exit    F1: General Help  
 F5: Previous Values    F6: Fail-Safe Defaults    F7: Optimized Defaults

### ☞ DDR3 Timing Items

Manual allows all DDR3 Timing items below to be configurable.

Options are: Auto (default), Manual.

### ☞ 1T/2T Command Timing

Options are: Auto (default), 1T, 2T.

### ☞ CAS# latency

Options are: Auto (default), 5T~14T.

### ☞ RAS to CAS R/W Delay

Options are: Auto (default), 5T~14T.

### ☞ Row Precharge Time

Options are: Auto (default), 5T~14T.

### ☞ Minimum RAS Active Time

Options are: Auto (default), 15T~36T.

### ☞ TwTr Command Delay

Options are: Auto (default), 4T~8T.

### ☞ Trfc0 for DIMM2

Options are: Auto (default), 90ns, 110ns, 160ns, 300ns, 350ns.

### ☞ Trfc1 for DIMM2

Options are: Auto (default), 90ns, 110ns, 160ns, 300ns, 350ns.

### ☞ Write Recovery Time

Options are: Auto (default), 5T~8T, 10T, 12T, 14T, 16T.

### ☞ Precharge Time

Options are: Auto (default), 4T~8T.

### ☞ Row Cycle Time

Options are: Auto (default), 20T~54T.

### ☞ RAS to RAS Delay

Options are: Auto (default), 4T~8T.

### ☞ Four Bank Activate Window

Options are: Auto (default), 16T~40T.

☞ **Bank Interleaving**

Enables or disables memory bank interleaving. **Enabled** allows the system to simultaneously access different banks of the memory to increase memory performance and stability. (Default: Enabled)

\*\*\*\*\* **System Voltage Optimized** \*\*\*\*\*

☞ **System Voltage Control**

Determines whether to manually set the system voltages. **Auto** lets the BIOS automatically set the system voltages as required. **Manual** allows all voltage control items below to be configurable. (Default: Auto)

☞ **DDR3 Voltage Control**

Allows you to set memory voltage.

▶▶ Normal                      Supplies the memory voltage as required. (Default)

▶▶ +0.1V ~+0.3V              The adjustable range is from +0.1V to +0.3V.

Note: Increasing memory voltage may result in damage to the memory or reduce the useful life of the memory.

☞ **FCH Voltage Control**

Allows you to set the Chipset voltage.

▶▶ Normal                      Supplies the Chipset voltage as required. (Default)

▶▶ +0.1V ~+0.2V              The adjustable range is from +0.1V to +0.2V.

☞ **APU VDDP Voltage Control**

Allows you to set the APU PCIe PLL voltage.

▶▶ Normal                      Supplies the APU PCIe PLL voltage as required. (Default)

▶▶ +0.1V ~+0.2V              The adjustable range is from +0.1V to +0.2V.

Note: Increasing APU voltage may result in damage to your APU or reduce the useful life of the APU.

☞ **CPU VCORE NB Control**

Allows you to set the CPU NorthBridge VID voltage.

▶▶ Normal                      Supplies the CPU NB VID voltage as required. (Default)

▶▶ -0.600V ~ +0.300V        The adjustable range is from -0.600V to +0.300V.

☞ **CPU VCORE Control**

Allows you to set the CPU voltage.

▶▶ Normal                      Supplies the CPU voltage as required. (Default)

▶▶ -0.600V ~ +0.400V        The adjustable range is from -0.600V to +0.400V.

☞ **Normal CPU Vcore**

Displays the normal operating voltage of your CPU.

## 2-4 Standard CMOS Features

CMOS Setup Utility-Copyright (C) 1984-2011 Award Software Standard CMOS Features		
Date (mm:dd:yy)	Wed, Jul 20 2011	Item Help
Time (hh:mm:ss)	22:31:24	Menu Level ▶
▶ IDE Channel 0 Master	[None]	
▶ IDE Channel 0 Slave	[None]	
▶ IDE Channel 1 Master	[None]	
▶ IDE Channel 1 Slave	[None]	
Halt On	[All, But Keyboard]	
Base Memory	640K	
Extended Memory	941M	
↑↓→←: Move    Enter: Select    +/-/PU/PD: Value    F10: Save    ESC: Exit    F1: General Help F5: Previous Values    F6: Fail-Safe Defaults    F7: Optimized Defaults		

### ☞ **Date (mm:dd:yy)**

Sets the system date.

### ☞ **Time (hh:mm:ss)**

Sets the system time.

### ☞ **IDE Channel 0, 1 Master/Slave**

#### ▶▶ IDE HDD Auto-Detection

Press <Enter> to autodetect the parameters of the SATA device on this channel.

#### ▶▶ IDE Channel 0, 1 Master/Slave

Configure your SATA devices by using one of the two methods below:

- Auto                    Lets the BIOS automatically detect SATA devices during the POST. (Default)
- None                    If no SATA devices are used, set this item to **None** so the system will skip the detection of the device during the POST for faster system startup.

▶▶ Access Mode            Sets the hard drive access mode. Options are: Auto (default), CHS, LBA, Large.

### ☞ **Halt On**

Allows you to determine whether the system will stop for an error during the POST.

Options are: "All Errors," "No Errors," "All, But Keyboard". (Default)

### ☞ **Memory**

These fields are read-only and are determined by the BIOS POST.

## 2-5 Advanced BIOS Features

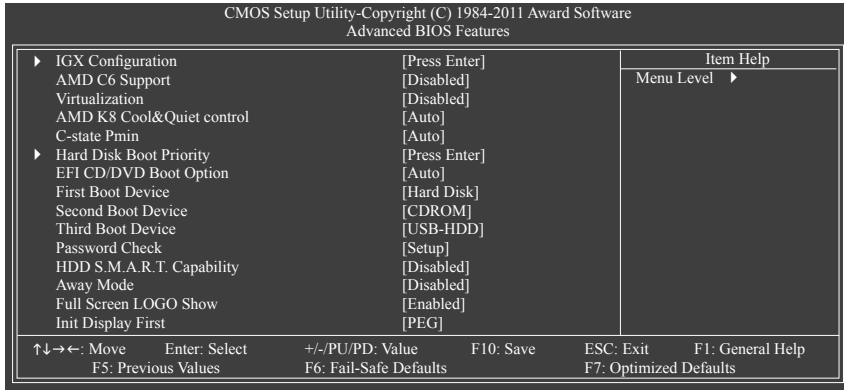

### ⊞ IGX Configuration

The settings in this submenu are synchronous to those under the same items on the **MB Intelligent Tweaker(M.I.T.)** main menu.

### ⊞ AMD C6 Support

Allows you to determine whether to let the CPU enter C6 mode in system halt state. When enabled, the CPU core frequency will be reduced during system halt state to decrease power consumption. The C6 state is a more enhanced power-saving state than C1. (Default: Disabled)

### ⊞ Virtualization

Virtualization allows a platform to run multiple operating systems and applications in independent partitions. With virtualization, one computer system can function as multiple virtual systems. (Default: Disabled)

### ⊞ AMD K8 Cool&Quiet control

- ▶▶ Auto      Lets the AMD Cool'n'Quiet driver dynamically adjust the CPU clock and VID to reduce heat output from your computer and its power consumption. (Default)
- ▶▶ Disabled      Disables this function.

### ⊞ C-state Pmin

Allows you to determine whether to let the CPU enter C1 mode in system halt state. When enabled, the CPU core frequency and voltage will be reduced during system halt state to decrease power consumption. **Auto** lets the BIOS automatically configure this setting. (Default: Auto)

### ⊞ Hard Disk Boot Priority

Specifies the sequence of loading the operating system from the installed hard drives. Use the up or down arrow key to select a hard drive, then press the plus key <+> (or <PageUp>) or the minus key <-> (or <PageDown>) to move it up or down on the list. Press <Esc> to exit this menu when finished.

### ⊞ EFI CD/DVD Boot Option

Set this item to **EFI** if you want to install the operating system to a hard drive larger than 2.2 TB. Make sure the operating system to be installed supports booting from a GPT partition, such as Windows 7 64-bit and Windows Server 2003 64-bit. **Auto** lets the BIOS automatically configure this setting depending on the hard drive you install. (Default: Auto)

### ⊞ First/Second/Third Boot Device

Specifies the boot order from the available devices. Use the up or down arrow key to select a device and press <Enter> to accept. Options are: LS120, Hard Disk, CDROM, ZIP, USB-FDD, USB-ZIP, USB-CDROM, USB-HDD, Legacy LAN, Disabled.

### ☞ Password Check

Specifies whether a password is required every time the system boots, or only when you enter BIOS Setup. After configuring this item, set the password(s) under the **Set Supervisor/User Password** item in the BIOS Main Menu.

- ▶▶ Setup A password is only required for entering the BIOS Setup program. (Default)
- ▶▶ System A password is required for booting the system and for entering the BIOS Setup program.

### ☞ HDD S.M.A.R.T. Capability

Enables or disables the S.M.A.R.T. (Self Monitoring and Reporting Technology) capability of your hard drive. This feature allows your system to report read/write errors of the hard drive and to issue warnings when a third party hardware monitor utility is installed. (Default: Disabled)

### ☞ Away Mode

Enables or disables Away Mode in Windows XP Media Center operating system. Away Mode allows the system to silently perform unattended tasks while in a low-power mode that appears off. (Default: Disabled)

### ☞ Full Screen LOGO Show

Allows you to determine whether to display the GIGABYTE Logo at system startup. **Disabled** displays normal POST message. (Default: Enabled)

### ☞ Init Display First

Specifies the first initiation of the monitor display from the installed PCI graphics card, PCI Express graphics card, or the onboard graphics.

- ▶▶ Onboard Sets the onboard graphics as the first display.
- ▶▶ PCI Slot Sets the PCI graphics card on the PCI slot as the first display.
- ▶▶ PEG Sets the PCI Express graphics card on the PCIEX16 slot as the first display. (Default)

## 2-6 Integrated Peripherals

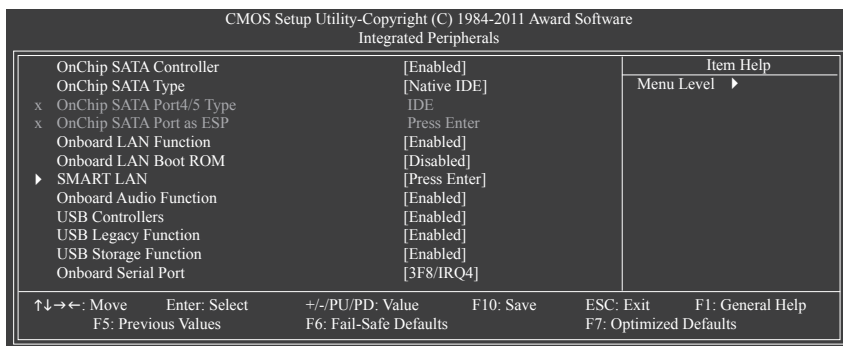

### ☞ OnChip SATA Controller

Enables or disables the integrated SATA controllers. (Default: Enabled)

### ☞ OnChip SATA Type (SATA2\_0~SATA2\_3 connectors)

Configures the operating mode of the SATA2\_0~SATA2\_3 connectors.

- ▶▶ Native IDE Allows the SATA controller to operate in Native IDE mode. (Default)  
Enable Native IDE mode if you wish to install operating systems that support Native mode.

- ▶▶ RAID Enables RAID for the SATA controller.
- ▶▶ AHCI Configures the SATA controllers to AHCI mode. Advanced Host Controller Interface (AHCI) is an interface specification that allows the storage driver to enable advanced Serial ATA features such as Native Command Queuing and hot plug.

☞ **OnChip SATA Port as ESP**

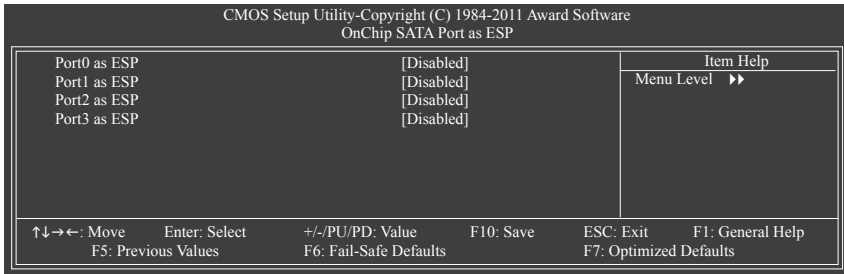

☞ **Port0 as ESP/Port1 as ESP/Port2 as ESP/Port3 as ESP**

This option is configurable only when **OnChip SATA Type** is set to **AHCI**. **Enabled** will speed up the hot plug detection of the connected SATA device. (Default: Disabled)

☞ **Onboard LAN Function**

Enables or disables the onboard LAN function. (Default: Enabled)

If you wish to install a 3rd party add-in network card instead of using the onboard LAN, set this item to **Disabled**.

☞ **Onboard LAN Boot ROM**

Allows you to decide whether to activate the boot ROM integrated with the onboard LAN chip. (Default: Disabled)

☞ **SMART LAN (LAN Cable Diagnostic Function)**

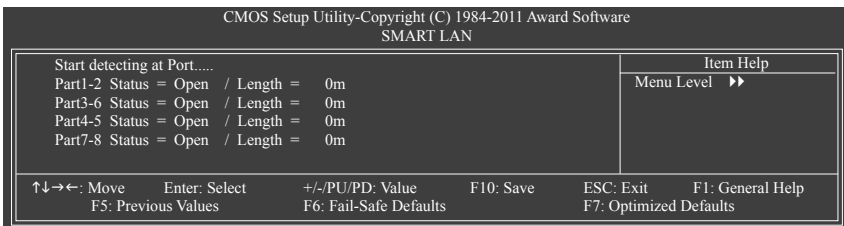

This motherboard incorporates cable diagnostic feature designed to detect the status of the attached LAN cable. This feature will detect cabling issue and report the approximate distance to the fault or short.

### ☞ Onboard Audio Function

Enables or disables the onboard audio function. (Default: Enabled)

If you wish to install a 3rd party add-in audio card instead of using the onboard audio, set this item to **Disabled**.

### ☞ USB Controllers

Enables or disables the integrated USB controllers. (Default: Enabled)

**Disabled** will turn off all of the USB functionalities below.

### ☞ USB Legacy Function

Allows USB keyboard to be used in MS-DOS. (Default: Enabled)

### ☞ USB Storage Function

Determines whether to detect USB storage devices, including USB flash drives and USB hard drives during the POST. (Default: Enabled)

### ☞ Onboard Serial Port

Enables or disables the first serial port and specifies its base I/O address and corresponding interrupt.

Options are: Auto, 3F8/IRQ4 (default), 2F8/IRQ3, 3E8/IRQ4, 2E8/IRQ3, Disabled.

## 2-7 Power Management Setup

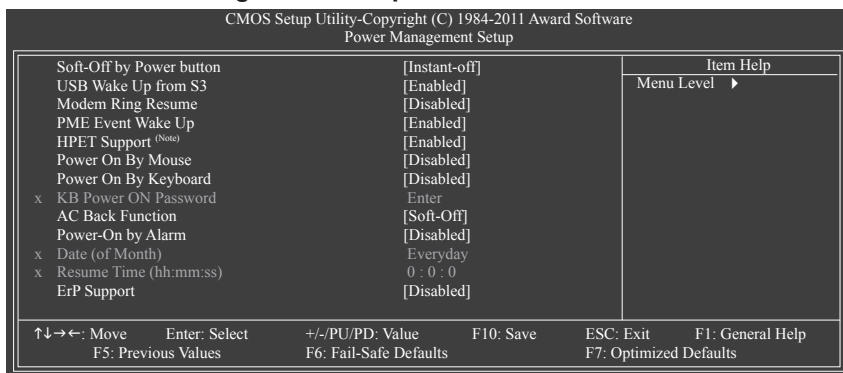

### ☞ Soft-Off by Power button

Configures the way to turn off the computer in MS-DOS mode using the power button.

▶▶ Instant-Off    Press the power button and then the system will be turned off instantly. (Default)

▶▶ Delay 4 Sec.    Press and hold the power button for 4 seconds to turn off the system. If the power button is pressed for less than 4 seconds, the system will enter suspend mode.

### ☞ USB Wake Up from S3

Allows the system to be awakened from ACPI S3 sleep state by a wake-up signal from the installed USB device. (Default: Enabled)

### ☞ Modem Ring Resume

Allows the system to be awakened from an ACPI sleep state by a wake-up signal from a modem that supports wake-up function. (Default: Disabled)

(Note) Supported on Windows 7/Vista operating system only.

### ☞ **PME Event Wake Up**

Allows the system to be awakened from an ACPI sleep state by a wake-up signal from a PCI or PCIe device. Note: To use this function, you need an ATX power supply providing at least 1A on the +5VSB lead. (Default: Enabled)

### ☞ **HPET Support** (Note)

Enables or disables High Precision Event Timer (HPET) for Windows 7/Vista operating system. (Default: Enabled)

### ☞ **Power On By Mouse**

Allows the system to be turned on by a PS/2 mouse wake-up event.

Note: To use this function, you need an ATX power supply providing at least 1A on the +5VSB lead.

- ▶▶ Disabled Disables this function. (Default)
- ▶▶ Double Click Double click on left button on the PS/2 mouse to turn on the system.

### ☞ **Power On By Keyboard**

Allows the system to be turned on by a PS/2 keyboard wake-up event.

Note: you need an ATX power supply providing at least 1A on the +5VSB lead.

- ▶▶ Disabled Disables this function. (Default)
- ▶▶ Password Set a password with 1~5 characters to turn on the system.
- ▶▶ Any KEY Press any key on the keyboard to turn on the system.
- ▶▶ Keyboard 98 Press POWER button on the Windows 98 keyboard to turn on the system.

### ☞ **KB Power ON Password**

Set the password when **Power On by Keyboard** is set to **Password**. Press <Enter> on this item and set a password with up to 5 characters and then press <Enter> to accept. To turn on the system, enter the password and press <Enter>.

Note: To cancel the password, press <Enter> on this item. When prompted for the password, press <Enter> again without entering the password to clear the password settings.

### ☞ **AC Back Function**

Determines the state of the system after the return of power from an AC power loss.

- ▶▶ Soft-Off The system stays off upon the return of the AC power. (Default)
- ▶▶ Full-On The system is turned on upon the return of the AC power.
- ▶▶ Memory The system returns to its last known awake state upon the return of the AC power.

### ☞ **Power-On by Alarm**

Determines whether to power on the system at a desired time. (Default: Disabled)

If enabled, set the date and time as following:

- ▶▶ Date (of Month) Alarm: Turn on the system at a specific time on each day or on a specific day in a month.
- ▶▶ Resume Time (hh: mm: ss): Set the time at which the system will be powered on automatically.

Note: When using this function, avoid inadequate shutdown from the operating system or removal of the AC power, or the settings may not be effective.

### ☞ **ErP Support**

Determines whether to let the system consume less than 1W power in S5 (shutdown) state. (Default: Disabled)

Note: When this item is set to **Enabled**, the following four functions will become unavailable:

PME event wake up, power on by mouse, power on by keyboard, and wake on LAN.

(Note) Supported on Windows 7/Vista operating system only.



## 2-8 PC Health Status

CMOS Setup Utility-Copyright (C) 1984-2011 Award Software		
PC Health Status		
Reset Case Open Status	[Disabled]	Item Help
Case Opened	No	Menu Level ▶
Vcore	1.364V	
DDR15V	1.536V	
+12V	11.950V	
Vcc3	3.048V	
Current System Temperature	38°C	
Current CPU Temperature	36°C	
Current CPU FAN Speed	1962 RPM	
Current SYSTEM FAN Speed	0 RPM	
CPU Warning Temperature	[Disabled]	
CPU FAN Fail Warning	[Disabled]	
SYSTEM FAN Fail Warning	[Disabled]	
CPU Smart FAN Control	[Enabled]	
System Smart FAN Control	[Enabled]	
↑↓→←: Move    Enter: Select    +/-/PU/PD: Value    F10: Save    ESC: Exit    F1: General Help F5: Previous Values    F6: Fail-Safe Defaults    F7: Optimized Defaults		

### Reset Case Open Status

Keeps or clears the record of previous chassis intrusion status. **Enabled** clears the record of previous chassis intrusion status and the **Case Opened** field will show "No" at next boot. (Default: Disabled)

### Case Opened

Displays the detection status of the chassis intrusion detection device attached to the motherboard CI header. If the system chassis cover is removed, this field will show "Yes", otherwise it will show "No". To clear the chassis intrusion status record, set **Reset Case Open Status** to **Enabled**, save the settings to the CMOS, and then restart your system.

### Current Voltage(V) Vcore/DDR15V/+12V/Vcc3

Displays the current system voltages.

### Current System/CPU Temperature

Displays current system/CPU temperature.

### Current CPU/SYSTEM FAN Speed (RPM)

Displays current CPU/system fan speed.

### CPU Warning Temperature

Sets the warning threshold for CPU temperature. When CPU temperature exceeds the threshold, BIOS will emit warning sound. Options are: Disabled (default), 60°C/140°F, 70°C/158°F, 80°C/176°F, 90°C/194°F.

### CPU/SYSTEM FAN Fail Warning

Allows the system to emit warning sound if the CPU/system fan is not connected or fails. Check the fan condition or fan connection when this occurs. (Default: Disabled)

### CPU Smart FAN Control

Enables or disables the CPU fan speed control function. **Enabled** allows the CPU fan to run at different speed according to the CPU temperature. You can adjust the fan speed with EasyTune based on system requirements. If disabled, the CPU fan runs at full speed. (Default: Enabled)

### System Smart FAN Control

Enables or disables the system fan speed control function. **Enabled** allows the system fan to run at different speed according to the system temperature. If disabled, system fan runs at full speed. (Default: Enabled)

## 2-9 Load Fail-Safe Defaults

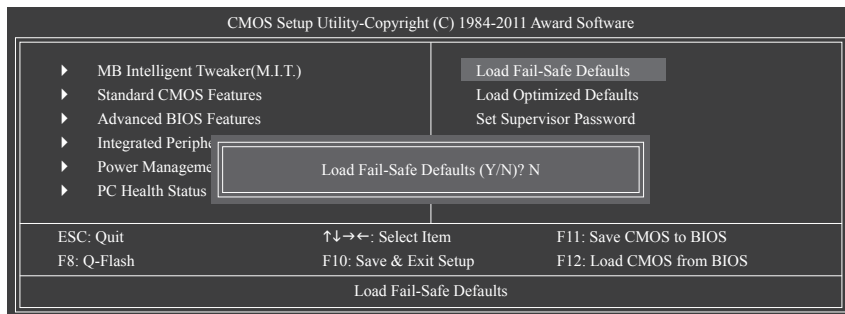

Press <Enter> on this item and then press the <Y> key to load the safest BIOS default settings. In case system instability occurs, you may try to load Fail-Safe defaults, which are the safest and most stable BIOS settings for the motherboard.

## 2-10 Load Optimized Defaults

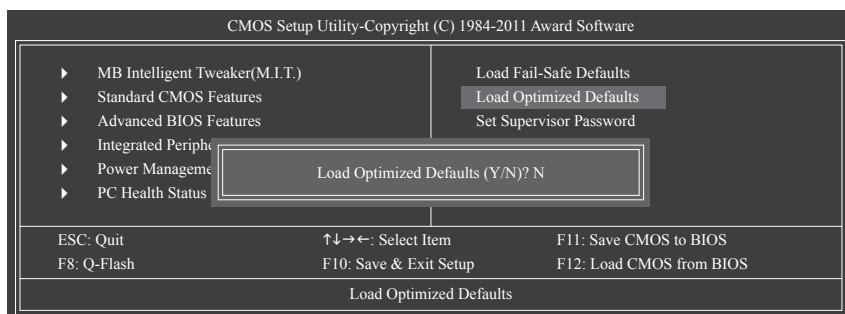

Press <Enter> on this item and then press the <Y> key to load the optimal BIOS default settings. The BIOS default settings help the system to operate in optimum state. Always load the Optimized defaults after updating the BIOS or after clearing the CMOS values.

## 2-11 Set Supervisor/User Password

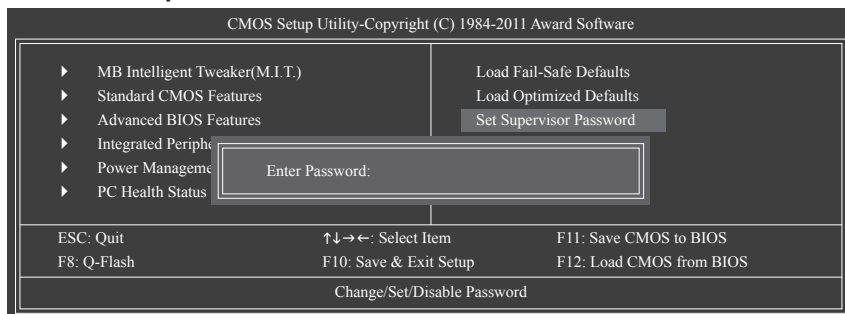

Press <Enter> on this item and type the password with up to 8 characters and then press <Enter>. You will be requested to confirm the password. Type the password again and press <Enter>.

The BIOS Setup program allows you to specify two separate passwords:

### ➤ Supervisor Password

When a system password is set and the **Password Check** item in **Advanced BIOS Features** is set to **Setup**, you must enter the supervisor password for entering BIOS Setup and making BIOS changes.

When the **Password Check** item is set to **System**, you must enter the supervisor password (or user password) at system startup and when entering BIOS Setup.

### ➤ User Password

When the **Password Check** item is set to **System**, you must enter the supervisor password (or user password) at system startup to continue system boot. In BIOS Setup, you must enter the supervisor password if you wish to make changes to BIOS settings. The user password only allows you to view the BIOS settings but not to make changes.

To clear the password, press <Enter> on the password item and when requested for the password, press <Enter> again. The message "PASSWORD DISABLED" will appear, indicating the password has been cancelled.

## 2-12 Save & Exit Setup

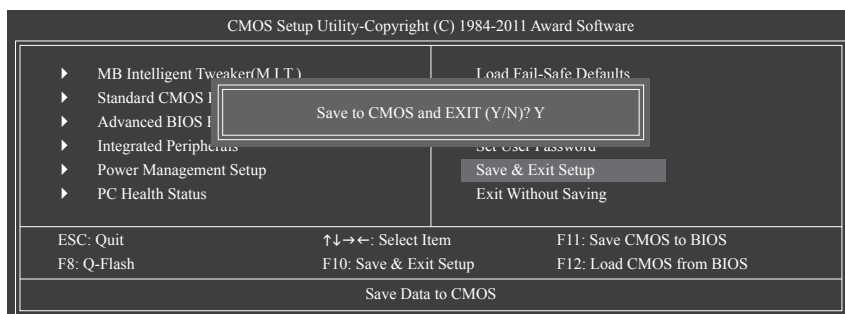

Press <Enter> on this item and press the <Y> key. This saves the changes to the CMOS and exits the BIOS Setup program. Press <N> or <Esc> to return to the BIOS Setup Main Menu.

## 2-13 Exit Without Saving

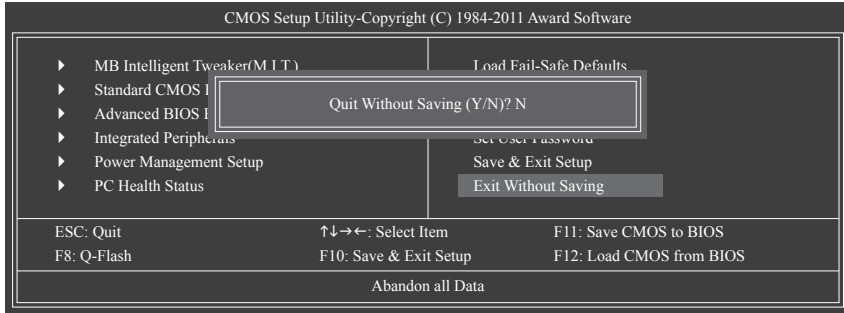

Press <Enter> on this item and press the <Y> key. This exits the BIOS Setup without saving the changes made in BIOS Setup to the CMOS. Press <N> or <Esc> to return to the BIOS Setup Main Menu.

## Chapter 3 Drivers Installation



- Before installing the drivers, first install the operating system.
- After installing the operating system, insert the motherboard driver disk into your optical drive. The driver Autorun screen is automatically displayed which looks like that shown in the screen shot below. (If the driver Autorun screen does not appear automatically, go to My Computer, double-click the optical drive and execute the **Run.exe** program.)

After inserting the driver disk, "Xpress Install" will automatically scan your system and then list all the drivers that are recommended to install. You can click the **Install All** button and "Xpress Install" will install all the recommended drivers. Or click **Install Single Items** to manually select the drivers you wish to install.

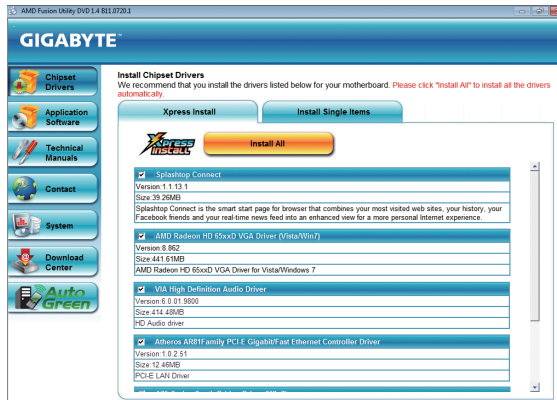

## Chapter 4 Appendix

### 4-1 Configuring SATA Hard Drive(s)

#### Before you begin

Please prepare:

- At least two SATA hard drives (to ensure optimal performance, it is recommended that you use two hard drives with identical model and capacity). If you do not want to create RAID, you may prepare only one hard drive.
- Windows 7/Vista/XP setup disk.
- Motherboard driver disk.
- A USB floppy disk drive (needed during Windows XP installation)
- An empty formatted floppy disk (needed during Windows XP installation)

#### Configuring the Onboard SATA Controller

##### A. Installing SATA hard drive(s) in your computer

Attach one end of the SATA signal cable to the rear of the SATA hard drive and the other end to available SATA port on the motherboard. Then connect the power connector from your power supply to the hard drive.

##### B. Configuring SATA controller mode in BIOS Setup

Make sure to configure the SATA controller mode correctly in system BIOS Setup. For the BIOS Setup menus, refer to Chapter 2, "BIOS Setup," "Integrated Peripherals."

Steps:

1. Turn on your computer and press <Delete> to enter BIOS Setup during the POST (Power-On Self-Test). Make sure **OnChip SATA Controller** is enabled. To enable RAID for the SATA2\_0/1/2/3 connectors, set **OnChip SATA Type** to **RAID**. To enable RAID for the SATA2\_4/SATA2\_5 connectors, set **OnChip SATA Type** to **RAID** and set **OnChip SATA Port4/5 Type** to **As SATA Type**.
2. Save changes and exit BIOS Setup.



The BIOS Setup menus described in this section may differ from the exact settings for your motherboard. The actual BIOS Setup menu options you will see shall depend on the motherboard you have and the BIOS version.

##### C. Configuring RAID set in RAID BIOS

Enter the RAID BIOS setup utility to configure a RAID array. After the POST memory test begins and before the operating system boot begins, look for a message which says "Press <Ctrl-F> to enter RAID Option ROM Utility". Press <Ctrl> + <F> to enter the RAID BIOS setup utility. To create a new array, press <2> to enter the **LD View/LD Define Menu** window. To create an array, press <Ctrl+C> to access the **LD Define Menu**. In the **LD Define Menu**, use the up or down arrow key to move to an item for further configuration. In the following procedure, we'll create RAID 0 as an example.

Steps:

1. Under the **RAID Mode** section, press the <SPACE> key to select **RAID 0**.
2. Set the **Stripe Block** size. **64 KB** is the default.
3. Under the **Drives Assignments** section, press the up or down arrow key to highlight a drive.
4. Press the <SPACE> key or <Y> to change the **Assignment** option to **Y**. This action adds the drive to the disk array. The **Drv** section will show the number of disks assigned.

5. Press <Ctrl>+<Y> keys to save the information. The message in Figure 1 will appear. Press <Ctrl>+<Y> to input the array name. If you do not input the array name, the default array name will be used.

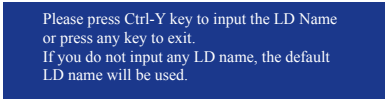

Please press Ctrl-Y key to input the LD Name  
or press any key to exit.  
If you do not input any LD name, the default  
LD name will be used.

Figure 1

6. When the next message appears, press <Ctrl>+<Y> to clear the MBR or press other keys to ignore this option.

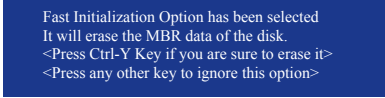

Fast Initialization Option has been selected  
It will erase the MBR data of the disk.  
<Press Ctrl-Y Key if you are sure to erase it>  
<Press any other key to ignore this option>

Figure 2

7. Then, the message in Figure 8 will appear. Press <Ctrl>+<Y> to set the capacity of the RAID array or press other keys to set the array to its maximum capacity.



Press Ctrl-Y to Modify Array Capacity or press any  
other key to use maximum capacity...

Figure 3

8. After the creation is complete, the screen will return to **LD View Menu** where you will see the newly-created array.
9. Press <Esc> to return to **Main Menu** and press <Esc> again if you want to exit the RAID BIOS utility.

## Making a SATA RAID/AHCI Driver Diskette

Before installing Windows XP, connect a USB floppy disk drive to your computer first because you need to install the SATA RAID/AHCI driver from a floppy disk that contains the driver during the OS installation. To copy the RAID/AHCI driver for Windows XP, copy all files in the **\BootDrv\Hxp** folder in the motherboard driver disk to your floppy disk.

## Installing the SATA RAID/AHCI Driver and Operating System

### A. Installing Windows XP

Restart your system to boot from the Windows XP setup disk and press <F6> as soon as you see the message "Press F6 if you need to install a 3rd party SCSI or RAID driver." Insert the floppy disk containing the SATA RAID/AHCI driver. Follow the on-screen instructions to install the driver that suits your operating system. When completed, proceed with the Windows XP installation.

### B. Installing Windows 7/Vista

Restart your system to boot from the Windows 7/Vista setup disk and perform standard OS installation steps. Select **Load Driver**. Insert the motherboard driver disk and then browse to the location of the driver. Then follow the on-screen instructions to load the driver. The locations of the drivers for Windows 7 are as follows:

RAID driver for Windows 32-bit: \BootDrv\Hw7\RAID\W7

RAID driver for Windows 64-bit: \BootDrv\Hw7\RAID\W764A

AHCI driver for Windows 32-bit: \BootDrv\Hw7\AHCI\W7

AHCI driver for Windows 64-bit: \BootDrv\Hw7\AHCI\W764A

(Note: The LH/LH64A folder contains the driver for Windows Vista 32-bit/64-bit)

After loading the driver, continue the OS installation.

## 4-2 Regulatory Statements

### Regulatory Notices

This document must not be copied without our written permission, and the contents there of must not be imparted to a third party nor be used for any unauthorized purpose. Contravention will be prosecuted. We believe that the information contained herein was accurate in all respects at the time of printing. GIGABYTE cannot, however, assume any responsibility for errors or omissions in this text. Also note that the information in this document is subject to change without notice and should not be construed as a commitment by GIGABYTE.

### Our Commitment to Preserving the Environment

In addition to high-efficiency performance, all GIGABYTE motherboards fulfill European Union regulations for RoHS (Restriction of Certain Hazardous Substances in Electrical and Electronic Equipment) and WEEE (Waste Electrical and Electronic Equipment) environmental directives, as well as most major worldwide safety requirements. To prevent releases of harmful substances into the environment and to maximize the use of our natural resources, GIGABYTE provides the following information on how you can responsibly recycle or reuse most of the materials in your "end of life" product.

### Restriction of Hazardous Substances (RoHS) Directive Statement

GIGABYTE products have not intended to add and safe from hazardous substances (Cd, Pb, Hg, Cr+6, PBDE and PBB). The parts and components have been carefully selected to meet RoHS requirement. Moreover, we at GIGABYTE are continuing our efforts to develop products that do not use internationally banned toxic chemicals.

### Waste Electrical & Electronic Equipment (WEEE) Directive Statement

GIGABYTE will fulfill the national laws as interpreted from the 2002/96/EC WEEE (Waste Electrical and Electronic Equipment) directive. The WEEE Directive specifies the treatment, collection, recycling and disposal of electric and electronic devices and their components. Under the Directive, used equipment must be marked, collected separately, and disposed of properly.

### WEEE Symbol Statement



The symbol shown below is on the product or on its packaging, which indicates that this product must not be disposed of with other waste. Instead, the device should be taken to the waste collection centers for activation of the treatment, collection, recycling and disposal procedure.

The separate collection and recycling of your waste equipment at the time of disposal will help to conserve natural resources and ensure that it is recycled in a manner that protects human health and the environment. For more information about where you can drop off your waste equipment for recycling, please contact your local government office, your household waste disposal service or where you purchased the product for details of environmentally safe recycling.

- When your electrical or electronic equipment is no longer useful to you, "take it back" to your local or regional waste collection administration for recycling.
- If you need further assistance in recycling, reusing in your "end of life" product, you may contact us at the Customer Care number listed in your product's user's manual and we will be glad to help you with your effort.

Finally, we suggest that you practice other environmentally friendly actions by understanding and using the energy-saving features of this product (where applicable), recycling the inner and outer packaging (including shipping containers) this product was delivered in, and by disposing of or recycling used batteries properly. With your help, we can reduce the amount of natural resources needed to produce electrical and electronic equipment, minimize the use of landfills for the disposal of "end of life" products, and generally improve our quality of life by ensuring that potentially hazardous substances are not released into the environment and are disposed of properly.













## Contact Us

---

### GIGA-BYTE TECHNOLOGY CO., LTD.

Address: No.6, Bao Chiang Road, Hsin-Tien Dist., New Taipei City 231, Taiwan

TEL: +886-2-8912-4000, FAX: +886-2-8912-4003

Tech. and Non-Tech. Support (Sales/Marketing) : <http://ggts.gigabyte.com.tw>

WEB address (English): <http://www.gigabyte.com>

WEB address (Chinese): <http://www.gigabyte.tw>

---

You may go to the GIGABYTE website, select your language in the language list on the top right corner of the website.

- **GIGABYTE Global Service System**



To submit a technical or non-technical (Sales/Marketing) question, please link to:

<http://ggts.gigabyte.com.tw>

Then select your language to enter the system.