



# User's Manual

**nVidia *nForce 570* | *nForce 550* mainboard  
for AMD Socket AM2 (940-pin) processor**

**TRADEMARK**

All products and company names are trademarks or registered trademarks of their respective holders.

These specifications are subject to change without notice.

Manual Revision 1.0  
August 15, 2006

---

## **DISCLAIMER OF WARRANTIES:**

**THERE ARE NO WARRANTIES WHICH EXTEND BEYOND THE DESCRIPTION ON THE FACE OF THE MANUFACTURER LIMITED WARRANTY. THE MANUFACTURER EXPRESSLY EXCLUDES ALL OTHER WARRANTIES, EXPRESS OR IMPLIED, REGARDING ITS PRODUCTS; INCLUDING ANY IMPLIED WARRANTIES OF MERCHANTABILITY, FITNESS FOR A PARTICULAR PURPOSE OR NONINFRINGEMENT. THIS DISCLAIMER OF WARRANTIES SHALL APPLY TO THE EXTENT ALLOWED UNDER LOCAL LAWS IN THE COUNTRY PURCHASED IN WHICH LOCAL LAWS DO NOT ALLOW OR LIMIT THE EXCLUSION OF THE IMPLIED WARRANTIES.**

## **HANDLING PROCEDURES:**

Static electricity can severely damage your equipment. Handle the mainboard and any other device in your system with extreme care and avoid unnecessary contact with system components on the mainboard. Always work on an antistatic surface to avoid possible damage to the mainboard from static discharge. Always have the power supply unplugged and powered off when inserting and removing devices within the computer chassis. The Manufacturer assumes no responsibility for any damage to the mainboard that results from failure to follow instruction or failure to observe safety precautions.



**CAUTION**



The mainboard is subject to damage by static electricity.  
Always observe the handling procedures.

---

## ***Post Port Frequently Asked Questions***

Below is a list of some basic POST Codes, possible problems and solutions. For more detailed information about POST Codes, refer to Appendix in this manual.

<b>Post Code</b>	<b>Problem</b>	<b>Solution</b>
FFh or CFh	<ol style="list-style-type: none"><li>1. BIOS chip inserted incorrectly</li><li>2. Incorrect BIOS update version</li><li>3. Mainboard problem</li><li>4. Add-on card inserted incorrectly</li></ol>	<ol style="list-style-type: none"><li>1. Reinsert the BIOS chip</li><li>2. Download the correct BIOS version update from the manufacturer's Web site</li><li>3. Replace mainboard</li><li>4. Remove and replace the add-on card</li></ol>
C1h - C5h	<ol style="list-style-type: none"><li>1. Memory module inserted incorrectly</li><li>2. Memory compatibility problem</li><li>3. Memory module damaged</li></ol>	<ol style="list-style-type: none"><li>1. Reinsert memory module</li><li>2. Replace memory with correct type</li><li>3. Replace memory module</li></ol>
2Dh	<ol style="list-style-type: none"><li>1. Error occurred in VGA BIOS</li><li>2. VGA card inserted incorrectly</li></ol>	<ol style="list-style-type: none"><li>1. Replace VGA card</li><li>2. Reinsert the VGA card</li></ol>
26h	Overclock error	Clear CMOS or press the insert key to power on the system
07h - 12h	<ol style="list-style-type: none"><li>1. Initial Keyboard controller error</li><li>2. RTC error</li></ol>	<ol style="list-style-type: none"><li>1. Ensure the Keyboard and mouse are connected correctly</li><li>2. Replace the RTC battery</li></ol>

---

## Table of Contents

	<i>Page</i>
<b>Section 1-- Introduction .....</b>	<b>1</b>
1-1 Package Contents .....	1
1-2 Mainboard Features .....	2
1-3 Mainboard Specification .....	4
1-4 System Block Diagram .....	6
<b>Section 2-- Installation .....</b>	<b>7</b>
2-1 CPU Installation .....	7
2-2 Jumper Settings .....	8
2-3 System Memory Configuration .....	9
2-4 Rear I/O Port .....	10
2-5 Internal Connectors .....	10
<b>Section 3-- BIOS Setup .....</b>	<b>13</b>
3-1 Main Menu .....	13
3-2 Standard CMOS Setup .....	14
3-3 Advanced BIOS Features .....	14
3-4 Power BIOS Features .....	16
<b>Section 4-- Driver &amp; Utility .....</b>	<b>18</b>
<b>Section 5-- Ghost BIOS .....</b>	<b>19</b>
<b>Section 6-- Appendix .....</b>	<b>21</b>
6-1 Post Codes .....	21

# Section 1 -- Introduction

## 1-1 Package Contents

### Contents

- A. Mainboard
- B. User's manual
- C. Floppy drive cable
- D. HDD drive cable
- E. CD (drivers and utilities)
- F. I/O Shield
- G. SATA II data cable

### Optional items

- H. Extra USB2.0 port cable
- I. Thermo Stick cable

If you need the optional item, please contact your dealer for assistance.

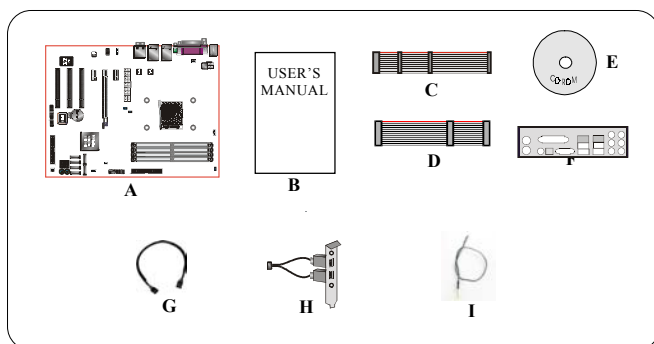

### **If you intend to setup RAID:**

When installing Windows XP/2000 into any RAID drive, the O/S setup will require a floppy disk containing the RAID driver. This step will show you how to prepare this driver floppy.

1. Locate a PC and insert the bundled CD into its CD-ROM drive.
2. A main menu screen will appear (Autorun feature)
3. Select the page "RAID floppy"

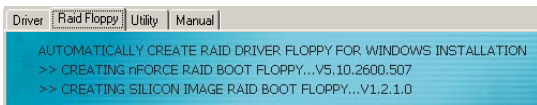

4. Insert a blank floppy into the A:drive
5. Click on the required RAID controller driver to begin copy into the floppy

---

## 1-2 Mainboard Features

### Brief Introduction

#### ● **Socket AM2**

Socket AM2 (940-pin) based motherboards are designed to provide performance enhancements for AMD Athlon AM2 processor-based systems, and it also expected to be the next-generation of platform innovations.

For more information about all the new features Athlon™ AM2 Processor deliver, check out the AMD website at <http://www.amd.com>

#### ● **Chipset**

The board is designed with nVidia nForce 570/550 chipset, featuring performance and stability with the most innovative technology and features.

For more details about the nVidia chipset, please visit the nVidia Web site at <http://www.nVidia.com>.

#### ● **PCI-Express (PCI-E)**

Next generation peripheral interface to succeed to current PCI bus for the next decade. With smaller slot size and 250MB/sec (PCI-E\*1) or 4GB/sec(PCI-E\*16) maximum transfer, PCI-Express overcomes PCI bus bottleneck.

#### ● **DDR2**

DDR2 ushers in the new era of DDR memory technology. DDR2 memory offers faster speed, higher data bandwidth and lower power consumption over DDR.

#### ● **Dual Channel**

Supports dual channel of DDR2 memory to give you twice the memory bandwidth for greater system performance.

#### ● **Hardware Monitoring**

Hardware monitoring enables you to monitor various aspects of the system operation and status. This includes CPU temperature, voltage and fan speed in RPMs.

#### ● **Dual GbE LAN (Optional)**

Onboard two Gigabit-LAN controllers. This twin set of Gigabit-LAN breaks traditional bandwidth barrier, delivering maximum 1000Mbps between internal and external network.

#### ● **GbE LAN (Optional)**

This mainboard is mounted with the new Gigabit Ethernet LAN which allows data transmission at 1,000 megabits per second (Mbps), running at 10 times faster than conventional 10/100BASE-T Ethernet LANs.

#### ● **Serial ATA II**

S-ATA II is the second generation SATA interface with double the transferring speed up to 300MB/sec. It supports NCQ to provide faster reading speed for your storage devices.

#### ● **SATA RAID**

RAID function available on chipset's SATA II ports.

#### ● **USB2.0**

A popular USB standard for plugging in peripherals with up to 480Mbps transfer speed while maintaining backward compatibility with older USB1.1 device.

#### ● **6ch (Optional)**

Mainboard is equipped with 6 channel of audio to support Dolby Digital 5.1 audio for DVD-playback. The onboard audio jacks can be configured for normal 2 channel mode or 6 channel mode.

#### ● **8ch (Optional)**

Delivers 8 channel audio to bring you the latest in audio realism from DVD movies and games. Perfect for your home theatre system.

#### ● **AMD Cool'n'Quiet™ Technology**

AMD's Cool'n'Quiet™ Technology lowers CPU operating voltage when the system is in idle mode. This helps to reduce heat dissipation and in effect lowers the fan speed to noise from your PC.

---

## Special Features

### BIOS Features:

- **Ghost BIOS**  
No more worries if BIOS gets corrupted causing your system unable to boot. The onboard backup BIOS will rescue & recover main BIOS in just a few easy steps.
- **Thunder Probe**  
A hardware diagnostic software to monitor voltage, temperature and speed of a variety of hardware. It also includes an ingenious built in fan control feature called Smart Fan.
- **Thunder Flash**  
A Windows based innovation tool to provide safe and easy BIOS rescue function, BIOS flash function and personal start up screen.
- **Magic Health**  
Reports your system hardware status for every boot-up to help detect faults early. Monitor hardware status including CPU temperature, CPU/Memory/Chipset voltage, fan RPM speed for chassis fan, CPU fan & Power supply fan.
- **EZ-Boot**  
Simply press "ESC" to select your bootable device. No more hassle to search the BIOS menu, change and re-start.
- **PowerBIOS**  
Supporting a full range of overclocking setting via BIOS. Various adjustable feature include CPU/Memory/Chipset voltage tweaking.

### H/W Features:

- **Post Port**  
An onboard LED-display trouble-shooting device, facilitating user to detect boot-up problems.
- **QuickSPDIF**  
On board SPDIF-out connector for quick connection to multi-channel speakers. Not only removes cable cluttering but also delivers loss-free digital audio to let you enjoy DVD movies and games with crystal clear sound.
- **EZ-Button**  
A handy power-on button located onboard to turn on/off the system easily, especially while debugging or testing the system. The LED on PW-ON button shows the power status, the LED on RESET button shows the HDD status.
- **LEDION**  
Onboard LED indicators to show the power status CPU, Chipset and DRAM. You know immediately where to look if the system fails to start.
- **Thermo Stick (Optional)**  
Flexible thermometer to let you measure any temperature by software. Ideal for monitoring VGA card, chipset or even disk drives temperatures.

---

## 1-3 Mainboard Specification

---

### Processor

- Support Socket-AM2 (940 pin) based AMD Athlon-X2/Athlon-64/Sempron processors
- Support 2.0GTs 16X16 wide Hyper Transport bus
- Support VMM (Virtualization-Machine-Monitoring)

### Chipset

- nVidia nForce 570 or nVidia nForce 550

### Main Memory

- Four 240-pin unbuffered non-ECC DDR2 SDRAM DIMM sockets
- Support single-sided or double-sided 1.8v DDR2-533/667/800 DIMMs with dual channel architecture in 256Mb/512Mb/1Gb technologies
- Supports up to 16GB memory size

### Expansion Slots

- Three PCI connectors compliant with PCI v2.3
- Two PCI-E (x1) connectors compliant with PCI Express 1.0a
- One PCI-E (x16) connectors compliant with PCI Express 1.0a

### USB

- Ten USB connectors compliant with USB2.0 from embedded USB controller (4 connectors at rear panel)

### LAN

- Two Gigabit Ethernet from onboard Realtek RTL8111B PCI-E Controller (Supported in the NVIDIA nForce 570 chipset)
- One Gigabit Ethernet from onboard Realtek RTL8111B PCI-E Controller (Supported in the NVIDIA nForce 550 chipset)

### P-ATA IDE

- One IDE interface (up to 2 IDE devices) with UDMA-33/66/100/133 support from embedded IDE controller

### S-ATA RAID

- Six S-ATA II ports with up to 300MB/s bandwidth with RAID 0, 1, 0+1, 5 (Supported in the NVIDIA nForce 570 chipset)
- Four S-ATA II ports with up to 300MB/s bandwidth with RAID 0, 1, 0+1 (Supported in the NVIDIA nForce 550 chipset)

### I/O

- Onboard EPoX EP1308 LPC bus I/O controller
- Legacy peripheral interface for PS/2 keyboard & mouse, FDD, Parallel, Serial, and IrDA (v1.0 compliant)
- Support Hardware Monitoring for fan speed monitoring and CPU temperature sensing
- Intelligent fan speed control for CPU-fan (PWM) and Chassis-fan for quiet operation

### BIOS

- Flash EEPROM with Award Plug&Play BIOS
- Support **EZ Boot** for fast bootable device selection
- Support **Magic Health** for system hardware status report during system boot-up
- Support **Ghost BIOS** for BIOS Recovery

### Audio

- 6 or 8 channel audio from onboard Realtek ALC8xx High Definition audio compliant CODEC
  - Support CD-In
  - Support **Jack detection** for fool-proof audio device installation



- Rear panel audio jacks configuration: depending on model you purchased, please refer to one of the following table:

For 6ch Configuration		
Phone Jack Color	2 channel	6 channel
Light Blue	Line-in	Rear stereo-out
Lime	Line-out	Front stereo-out
Pink	Mic-in	Center&Subwoofer

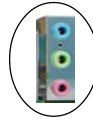

For 8ch Configuration			
Phone Jack Color	2 channel	6 channel	8 channel
Light Blue	Line-in	Line-in	Line-in
Lime	Line-out	Front stereo-out	Front stereo-out
Pink	Mic-in	Mic-in	Mic-in
Gray			Side stereo-out
Black		Rear stereo-out	Rear stereo-out
Orange		Center&Subwoofer	Center&Subwoofer



## Peripheral Interfaces

### At Rear Panel

- PS/2 keyboard and mouse ports
- One Parallel (printer) port
- One S/PDIF-Out Coaxial jack
- One S/PDIF-Out Optical (Optional)
- One Serial port
- Two RJ45 LAN connector from nF570 chipset, or One RJ45 LAN connector from nF550 chipset
- Four USB2.0 ports
- Six Audio jacks from nF570 chipset, or Three Audio jacks from nF550 chipset

### Onboard connector and pin-header

- One floppy drive connector
- One ATA-100/133 IDE
- Six extra USB2.0 ports
- One CD-IN connector
- One IR connector
- Six S-ATA II connectors from nF570 chipset, or Four S-ATA II connectors from nF550 chipset
- Three Fan connectors

## Front Panel Controller

- Supports Reset & Soft-Off switches
- Supports HDD & Power LEDs
- Supports PC speaker
- Supports Front Panel Audio connector

## Special Features

- Support KBPO function – Keyboard power on, turn on the computer from keyboard
- Support Wake-On-LAN by PME
- Onboard Post Port LED display for system debugging
- **PowerBIOS** for excellent overclocking features:
  - Programmable FSB and PCI-E Clock output frequency with 1MHz fine tuning
  - Support BIOS adjustable CPU multiplier, FSB clock, PCI-E x16 clock, DIMM frequency
  - Support BIOS adjustable CPU Core voltage, Chipset voltage and DIMM voltage
- Support **EZ-Button** – A handy power-on button onboard to turn on/off the system easily and the LED on PW-ON button shows the power status, the LED on RESET button shows the HDD status
- Support **LEDION** – onboard LED power indicator for CPU, DDR and chipset

- Support **Thermo Stick** temperature (Optional)
- Support **Ghost BIOS** - Rescue, recover BIOS in an easy step and no more worry of BIOS being corrupted.

**Powerful utilities for Windows**

- Support **Thunder Probe** - A hardware diagnostic software to monitor voltage, temperature and speed of a variety of hardware. It also includes an ingenious built in fan control feature called Smart Fan.
- Support **Thunder Flash** - A Windows based innovation tool to provide safe and easy BIOS rescue function, BIOS flash function and personal start up screen.

**Form Factor**

- 305mm x 245 mm ATX size



Depending on the model you purchased, some components are optional and may not be available.

**1-4 System Block Diagram**

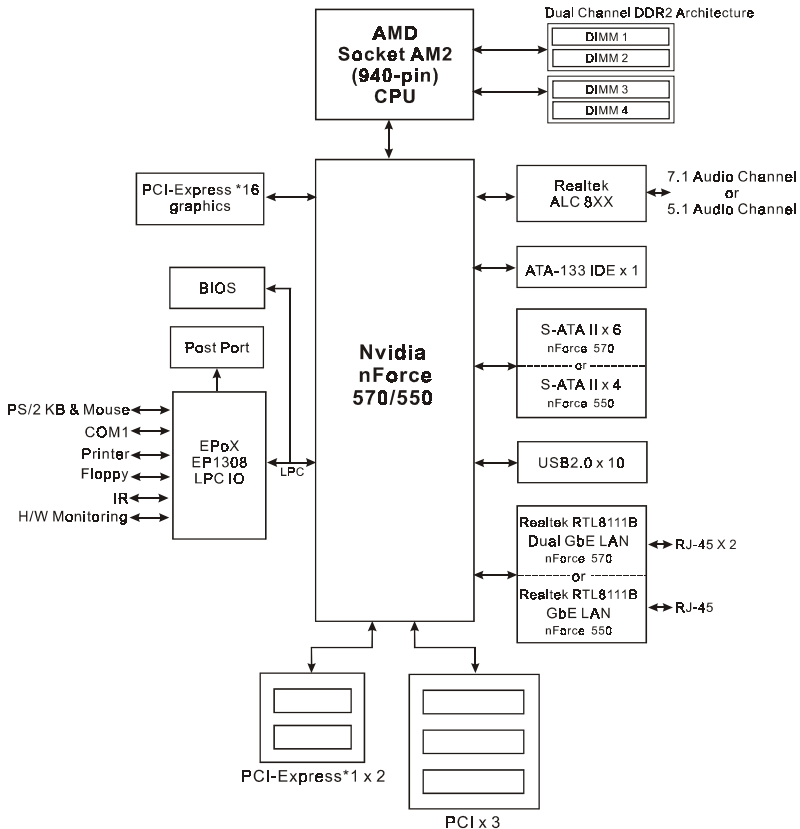

## Section 2 -- Installation



Always have the power supply unplugged and powered off when inserting and removing devices within the computer chassis.

### 2-1 CPU Installation

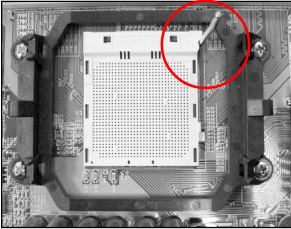

#### Step 1

Open the socket by raising the actuation lever.

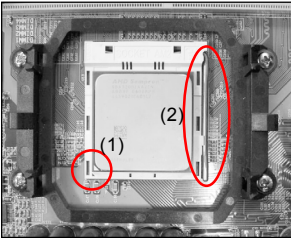

#### Step 2

- (1) Align pin 1 on the CPU with pin 1 on the CPU socket as shown. Insert the CPU and make sure it is fully inserted into the socket.
- (2) Close the socket by lowering and locking the actuation lever.

 The CPU is keyed to prevent incorrect insertion, do not force the CPU into the socket. If it does not go in easily, check for mis-orientation.

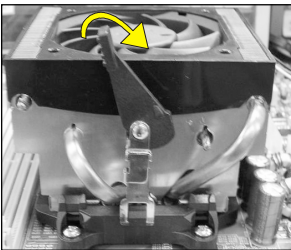

#### Step 3

Insert the heatsink as shown. Press the clips in the direction of the arrows shown to secure the assembly to the CPU socket.



#### Step 4

Plug the CPU fan power into the mainboard's CPU fan connector. The installation is complete.

- 
- Thermal compound and qualified heatsink recommended by AMD are a must to avoid CPU overheating damage.
  - Apply heatsink thermal compound/paste to the CPU.

## 2-2 Jumper Settings

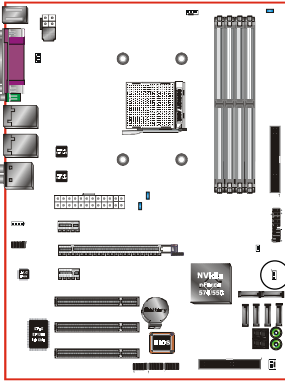

### JCMOS: Clear CMOS data Jumper

If the CMOS data becomes corrupted or you forgot the supervisor or user password, clear the CMOS data to reconfigure the system back to the default values stored in the ROM BIOS.



Settings:

- 1-2: Normal (Default)
- 2-3: Clear CMOS



To CMOS Clear data, please follow the steps below.

1. Turn off the system.
2. Change the jumper from "1-2" to "2-3" position for a few seconds.
3. Replace the jumper back to the "1-2" position.
4. Turn on the system and hold down the <Del> key to enter BIOS setup.

## 2-3 System Memory Configuration

The mainboard accommodates Four 240-pin DDR2 DIMMs.

- Supports up to 16GB of 533/667/800MHz DDR2 SDRAM.
- Supports unbuffered DIMM configurations defined in JEDEC DDR2 DIMM specification.

### Dual Channel interface:

- Dual channel memory access offers increased system performance.
- For dual channel to operate, both channel must be populated with same amount of memory, preferably of the same type.
- The four DIMM sockets are divided into two colors to help you identify the channel pairs <Figure 1>. Each dual channel pair has the same color, e.g. DIMM1 and DIMM2. **To obtain best performance, simply mount DIMM sockets of the same color.**

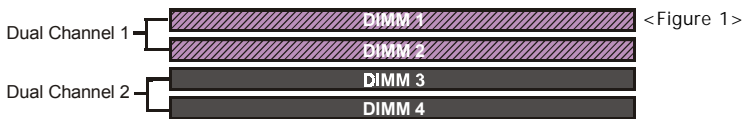

### Memory configurations supported:

	1 DIMM (64-bit)		2 DIMM (64-bit)		2 DIMM (128-bit)		4 DIMM (128-bit)	
DIMM#1	SS/DS		SS/DS	SS/DS			SS/DS	
DIMM#2				SS/DS			SS/DS	
DIMM#3		SS/DS	SS/DS		SS/DS	SS/DS	SS/DS	
DIMM#4					SS/DS	SS/DS	SS/DS	

\* SS: Single-Sided DIMM, DS: Double-Sided DIMM

### Memory Installation :

- ① To install, align the notch on the DIMM module with the connector.
- ② Press straight down as shown in the figure until the white clips close and the module fits tightly into the DIMM socket.

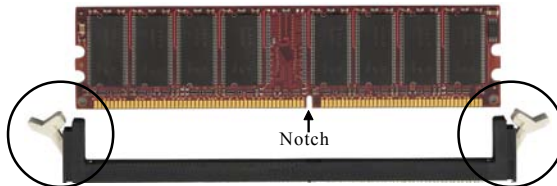

## 2-4 Rear IO Port



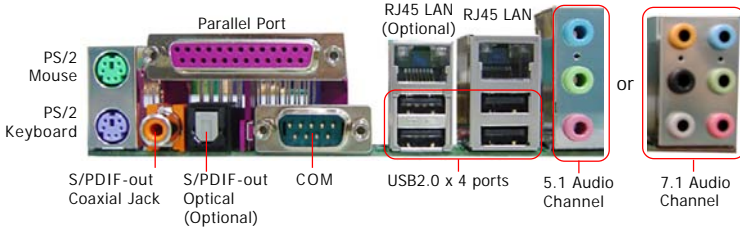

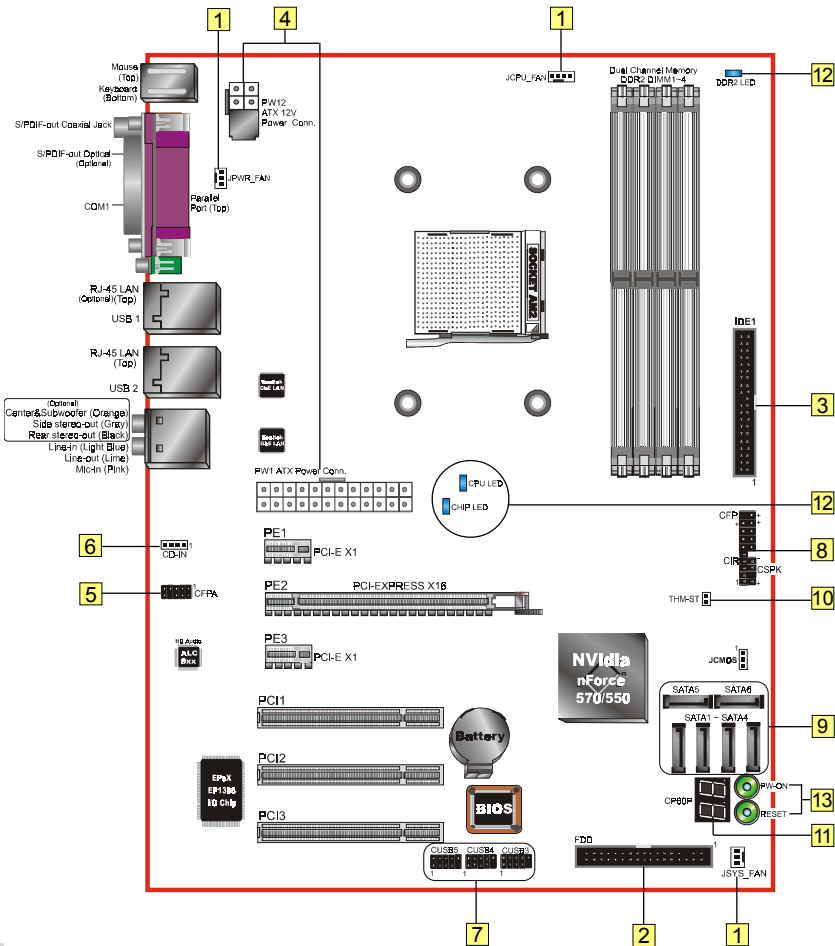

The I/O back panel for this mainboard is shown below. When installing the mainboard into the computer case, use the bundled I/O shield to protect this back panel.

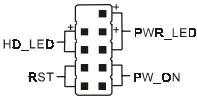

## 2-5 Internal Connectors

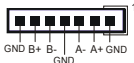

Connectors	Figure	Descriptions
<p><b>1</b> JCPU_FAN JPWR_FAN JSYS_FAN</p>	<p>The figure shows three 3-pin headers. The first header (JCPU_FAN) has pins labeled Control, Sense, and Ground +12V. The second header (JPWR_FAN) has pins labeled Ground and Sense +12V. The third header (JSYS_FAN) has pins labeled Ground and Sense +12V.</p>	<p>CPU / Power / Chassis /IO Fan Power Connectors</p> <p>JCPU_FAN: Connect the CPU fan to this connector.</p> <p>JPWR_FAN: Use this connector if you are installing an additional fan in the unit.</p> <p>JSYS_FAN: The chassis fan will provide adequate airflow throughout the chassis to prevent overheating the CPU.</p>
<p><b>2</b> FDD</p>	<p>A 34-pin connector with pin 1 labeled at the bottom left.</p>	<p>Floppy Drive Connector</p>
<p><b>3</b> IDE1 Primary IDE</p>	<p>A 40-pin connector with pin 1 labeled at the bottom left.</p>	<p>Primary IDE Connector</p> <p>Connects to the IDE device, i.e. HDD and CD-ROM device.</p>
<div style="border: 1px solid black; border-radius: 15px; padding: 10px; background-color: #fce4ec;"> <p> When using two IDE drives on the same connector, one must be set to Master mode and the other to Slave mode. Refer to your disk drive user's manual for details.</p> </div>		
<p><b>4</b> PW1 PW12</p>	<p>The figure shows two power connector pinouts. PW1 is a 24-pin connector with pins: 1 (+12V), 2 (Ground), 3 (+12V), 4 (Ground), 5 (+12V), 6 (Ground), 7 (+12V), 8 (Ground), 9 (+5V), 10 (Ground), 11 (+5V), 12 (Ground), 13 (+5V), 14 (Ground), 15 (PS-ON), 16 (Ground), 17 (-12V), 18 (Ground), 19 (3.3V), 20 (Ground), 21 (3.3V), 22 (Ground), 23 (3.3V), 24 (Ground). PW12 is an 8-pin connector with pins: 1 (+12V), 2 (Ground), 3 (+5V), 4 (Ground), 5 (+5V), 6 (Ground), 7 (PS-ON), 8 (Ground).</p>	<p>PW1: 24-pin ATX Power Connector</p> <p>PW12: 8-pin ATX12V Power Connector</p> <p>The plugs of the power cables are designed to fit in only one orientation.</p>
<div style="border: 1px solid black; border-radius: 15px; padding: 10px; background-color: #fce4ec;"> <p> The PW1 and PW12 Power Connector must be used simultaneously.</p> </div>		
<p><b>5</b> CFFPA</p>	<p>A 9-pin connector with pins: 1 (MIC_in), 2 (GND), 3 (+5V), 4 (Key), 5 (NC), 6 (NC), 7 (NC), 8 (Front Line-out-L), 9 (Front Line-out-R).</p>	<p>CFPA: Front Panel Audio Connector</p> <p>This audio connector connects to the audio jacks located on the front panel. Refer to your case manual to match the pin-out names.</p>
<p><b>6</b> CD-IN</p>	<p>A 3-pin connector with pins: 1 (CD_IN_Left), 2 (CD_Reference), 3 (CD_IN_Right).</p>	<p>CD-IN: CD Audio-in connectors</p> <p>This connector is used to receive audio from a CD-ROM drive, TV tuner or MPEG card.</p>
<p><b>7</b> CUSB3 CUSB4 CUSB5</p>	<p>A 6-pin header with pins: 1 (VCC), 2 (VCC), 3 (DATA0-), 4 (DATA1-), 5 (DATA0+), 6 (DATA1+), 7 (GND), 8 (GND), 9 (Key), 10 (NC).</p>	<p>CUSB3/CUSB4/CUSB5: Six USB2.0 header</p> <p>This mainboard includes 6 additional onboard USB ports. To use these additional USB ports, a USB bracket is required. Please contact your retailer for details.</p>

Connectors	Figure	Descriptions
8 CFP		<p>CFP: Case Front Panel Connector</p> <ul style="list-style-type: none"> <li>• HD_LED This LED indicates hard drive activity.</li> <li>• PWR_LED Connects to the power indicator on the PC case.</li> <li>• RST Connects to the RESET switch on the PC case.</li> <li>• PW_ON Connects to the Power button on the PC case, to turn on the system. To turn off the system, press the power button for 4 seconds.</li> </ul>
CIR		<p>CIR: IR connector For connection to an IrDA receiver unit.</p>
CSPK		<p>CSPK: Speaker Connects to the case's speaker for PC beeps.</p>
9 SATA1 ~ SATA6 or SATA1 ~ SATA4		<p>SATA1 ~ SATA6: Six Serial ATA II Connectors from nF570, or SATA1 ~ SATA4: Four Serial ATA II Connectors from nF550 These connectors enable you to connect Serial ATA HDDs or optical drives type.</p>
10 THM-ST (Optional)		<p>Thermo Stick: Flexible thermometer to let you measure any temperature by software. Ideal for monitoring VGA card, chipset or even disk drives temperatures.</p>
11 CP80P		<p>CP80P: Post Port Debug LED Provides two-digit POST code to show why the system fail to boot. Allows quick and easy optimization. The LED will display the CPU temperature when you run the bundled Thunder Probe software.</p>
12 LEDION		<p>LEDION: Onboard LED indicators to show the power status of CPU, Chipset and DRAM. You know immediately where to look if the system fails to start.</p>
13 EZ-Button		<p>EZ-Button — RESET, PW-ON: These onboard buttons lets you turn on/off the system easily, it is especially handy for debugging or testing the system. The LED on PW-ON button shows the power status, the LED on RESET button shows the HDD status.</p>



## Section 3 -- BIOS Setup

### 3-1 Main Menu

The ROM BIOS contains a built-in Setup program which allows user to modify the basic system configuration and hardware parameters. The modified data is stored in a battery-backed CMOS, so that data will be retained even when the power is turned off. In general, the information saved in the CMOS RAM will stay unchanged unless there is a configuration change in the system, such as hard drive replacement or a device is added.

It is possible for the CMOS battery to fail causing CMOS data loss. If this happens you will need install a new CMOS battery and reconfigure your BIOS settings.



The BIOS setup screen and description are for reference only, and may not exactly match what you see on your screen. The contents of BIOS are subject to change without notice. Please visit our website for BIOS updates.

#### To enter the Setup Program :

Power on the computer and press the <Del> key during the POST (Power On Self Test). The BIOS CMOS SETUP UTILITY opens.

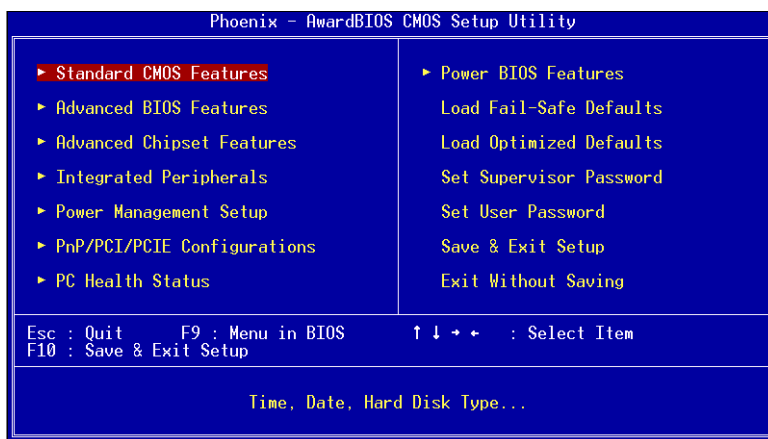

The main menu displays all the major selection items. Select the item you need to reconfigure. The selection is made by moving the cursor, press any direction (arrow key) to the item and pressing the 'Enter' key. An on-line help message is displayed at the bottom of the screen as the cursor is moved to various items which provides a better understanding of each function. When a selection is made, the menu of the selected item will appear so that the user can modify associated configuration parameters.



For more information regarding BIOS settings refer to the complete manual in the bundled CD.

### 3-2 Standard CMOS Setup

Choose "STANDARD CMOS FEATURES" in the CMOS SETUP UTILITY Menu. Standard CMOS Features Setup allows the user to configure system settings such as the current date and time, type of hard disk drive installed, floppy drive type, and display type. Memory size is auto-detected by the BIOS and displayed for your reference. When a field is highlighted (use direction keys to move the cursor and the <Enter> key to select), the entries in the field can be changed by pressing the <PgDn> or the <PgUp> key.

Phoenix - AwardBIOS CMOS Setup Utility Standard CMOS Features		Item Help
Date (mm:dd:yy)	Mon, Jul 4 2005	Menu Level ▶ Change the day, month, year and century
Time (hh:mm:ss)	10 : 21 : 56	
▶ IDE Channel 0 Master	[ None ]	
▶ IDE Channel 0 Slave	[ None ]	
▶ SATA Channel 1	[ None ]	
▶ SATA Channel 2	[ None ]	
▶ SATA Channel 3	[ None ]	
▶ SATA Channel 4	[ None ]	
▶ SATA Channel 5	[ None ]	
▶ SATA Channel 6	[ None ]	
Drive 0	[ 1.44M, 3.5 in. ]	
Halt On	[ All Errors ]	
Base Memory	640K	
Extended Memory	1K	
Total Memory	1024K	
↑↓: Move Enter: Select +/-/PU/PD: Value F10: Save ESC: Exit F1: General Help F5: Previous Values F6: Fail-Safe Defaults F7: Optimized Defaults		

#### Notes:

- If the hard disk Primary Master/Slave and Secondary Master/Slave are set to Auto, the hard disk size and model will be auto-detected.
- The "Halt On:" field is used to determine when the BIOS will halt the system if an error occurs.

### 3-3 Advanced BIOS Features

Selecting the "ADVANCED BIOS FEATURES" option in the CMOS SETUP UTILITY menu allows users to change system related parameters in the displayed menu. This menu shows all of the manufacturer's default values for the board. Pressing the [F1] key displays a help message for the selected item.

Phoenix - AwardBIOS CMOS Setup Utility Advanced BIOS Features		Item Help
▶ Removable Device Priority	[ Press Enter ]	Menu Level ▶ Select Removable Boot Device Priority
▶ Hard Disk Boot Priority	[ Press Enter ]	
▶ CD-ROM Boot Priority	[ Press Enter ]	
Init Display First	[ PCI Slot ]	
First Boot Device	[ Removable ]	
Second Boot Device	[ Hard Disk ]	
Third Boot Device	[ CDROM ]	
Boot Other Device	[ Enabled ]	
Boot Up Floppy Seek	[ Enabled ]	
Boot Up NumLock Status	[ On ]	
Security Option	[ Setup ]	
APIC Mode	[ Enabled ]	
Hard S.M.A.R.T. Capability	[ Disabled ]	
Full Screen L000 Show	[ Enabled ]	
↑↓: Move Enter: Select +/-/PU/PD: Value F10: Save ESC: Exit F1: General Help F5: Previous Values F6: Fail-Safe Defaults F7: Optimized Defaults		

#### ▶ Removable Device Priority

This item allows you to select the hard disk boot priority.

Options: Floppy, LS120, ZIP100, USB-FDD0, USB-FDD1, USB-ZIP0, USB-ZIP1.

#### ▶ Hard Disk Boot Priority

This item allows you to select the hard disk boot priority.

Options: Pri. Master, Pri. Slave, Sec. Master, Sec. Slave, USBHDD0, USBHDD1, USBHDD2, Bootable Add-in cards.

#### ▶ CD-ROM Boot Priority

This item allows you to select the CD-ROM boot priority.

Options: Pri. Master, Pri. Slave, Sec. Master, Sec. Slave, USB-CDROM0, USB-CDROM1.

---

**Init Display First**

This item is used to select whether to initialize the PCI-E or PCI first when the system boots.

Options: PCI Slot, PCIEx.

**First /Second/Third Boot Device**

The BIOS attempts to load the operating system from the devices in the sequence selected in these items.

Options: Floppy, LS120, Hard Disk, CDROM, ZIP100, USB-FDD, USB-ZIP, USB-CDROM, Legacy LAN, Disabled.

**Boot Other Device**

When enabled, the system searches all other possible locations for an operating system if it fails to find one in the devices specified under the first, second, and third boot devices.

Options: Enabled, Disabled.

**Boot Up Floppy Seek**

If this item is enabled, it checks the size of the floppy disk drives at start-up time. You don't need to enable this item unless you have a legacy diskette drive with 360K capacity.

Options: Enabled, Disabled.

**Boot Up NumLock Status**

This controls the state of the NumLock key when the system boots.

On: The keypad acts as a 10-key pad.

Off: The keypad acts like cursor keys.

**Security Option**

This category allows you to limit access to the System and Setup, or just to Setup.

System: The system will not boot and access to Setup will be denied unless the correct password is entered at the prompt.

Setup: The system will boot, but access to Setup will be denied unless the correct password is entered at the prompt.

**APIC Mode**

This item allows you to enable APIC (Advanced Programmable Interrupt Controller) functionality.

Options: Enabled, Disabled.

**HDD S.M.A.R.T. Capability**

The S.M.A.R.T. (Self-Monitoring, Analysis, and Reporting Technology) system is a diagnostics technology that monitors and predicts device performance. S.M.A.R.T. Software resides on both the disk drive and the host computer. If a device failure is predicted, the host software, through the Client WORKS S.M.A.R.T applet, warns the user of the impending condition and advises appropriate action to protect the data.

Options: Enabled, Disabled.

**Full Screen LOGO Show**

This item allows you determine Full Screen LOGO display during POST.

Options: Enabled, Disabled.

### 3-4 POWER BIOS Features

This page lets you adjust various parameters to obtain improved performance for overclocking.

#### Warning:

Overclocking requires expert knowledge and risks permanent damage to system components. We recommend you leave these parameters at their default values for proper operation.

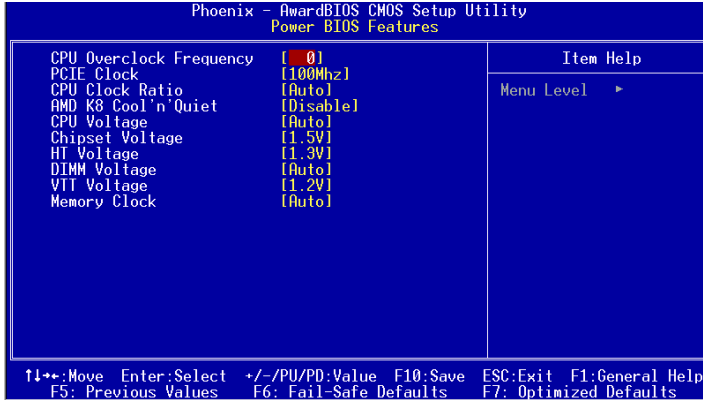

#### CPU Overclock Frequency

Enables you to increment the CPU's clock generator at 1 MHz step. This works together with CPU Clock Ratio (below) to set the CPU operating frequency.

$$\text{CPU Clock Generator} \times \text{CPU Clock Ratio} = \text{CPU Frequency}$$

For example, if you have a processor that is rated at 2.4GHz and the clock generator is 200MHz, then  $200\text{MHz} \times 12 = 2.4\text{GHz}$

Options: 0 to 250 in 1MHz increments.



Overclocking failure will cause no display on the monitor. To overcome this switch off the power supply and switch on again. Restart the system, press and hold **<Insert>** key. This will revert the BIOS to default or initial setting.

#### PCIE Clock

Enables you to subtly tune the PCIE frequency at increments of 1MHz step.

Options: 100 to 145 in 1MHz increments.

#### CPU Clock Ratio

Use this item to select a multiplier to set the CPU frequency. See CPU Overclock Frequency item above for explanation. If your CPU multiplier is locked this option will be unavailable.

#### AMD K8 Cool'n'Quiet

Reduce the noise and heat from your PC when AMD's Cool'n'Quiet™ technology is Auto.

Options: Auto, Disabled.

#### CPU Voltage

This item allows you to adjust the CPU Vcore voltage.

Options: Auto, +0V to +0.7625V in 0.025V increments. We recommend that you leave this at the default value.

#### Chipset Voltage

This item allows you to adjust the Chipset voltage.

Options: +1.5V to +1.7V in 0.1V increments. We recommend that you leave this at the default value.

#### HT Voltage

This item allows you to adjust the voltage of the Hyper Transport Bus.

Options: 1.2V to 1.6V in 0.1V increments. We recommend that you leave this at the default value.

**DIMM Voltage**

This item allows you to adjust the DIMM slot voltage.

Options: Auto, +1.8V to +3.2V in 0.1V increments. We recommend that you leave this at the default value.

**VTT Voltage**

This item allows you to adjust the CPU VTT voltage.

Options: 1.2V to 1.5V in 0.1V increments. We recommend that you leave this at the default value.

**Memory clock**

This item sets the memory clock.

CPU Core Clock Multiplier vs. DRAM Interface Speed

CPU Ratio	CPU Frequency	DDRII 400 (200MHz)		DDRII 533 (266MHz)		DDRII 667 (333MHz)		DDRII 800 (400MHz)	
		DIV	Freq.	DIV	Freq.	DIV	Freq.	DIV	Freq.
4	0.8 GHz	5	160MHz	5	160MHz	5	160MHz	5	160MHz
5	1 GHz	5	200MHz	5	200MHz	5	200MHz	5	200MHz
6	1.2 GHz	6	200MHz	5	240MHz	5	240MHz	5	240MHz
7	1.4 GHz	7	200MHz	6	233MHz	5	280MHz	5	280MHz
8	1.6 GHz	8	200MHz	6	266MHz	5	320MHz	5	320MHz
9	1.8 GHz	9	200MHz	7	257MHz	6	300MHz	5	360MHz
10	2.0 GHz	10	200MHz	8	250MHz	6	333MHz	5	400MHz
11	2.2 GHz	11	200MHz	9	244MHz	7	314MHz	6	366MHz
12	2.4 GHz	12	200MHz	9	266MHz	8	300MHz	6	400MHz
13	2.6 GHz	13	200MHz	10	260MHz	8	325MHz	7	371MHz
14	2.8 GHz	14	200MHz	11	254MHz	9	311MHz	7	400MHz
15	3.0 GHz	15	200MHz	12	250MHz	9	333MHz	8	375MHz
16	3.2 GHz	16	200MHz	12	266MHz	10	320MHz	8	400MHz
17	3.4 GHz	17	200MHz	13	261MHz	11	309MHz	9	377MHz

\* Memory Frequency = CPU Frequency / Division

For example, if you have a processor clock is 2GHz and the memory is DDRII 533 (266MHz), then the actual value of Memory clock is  $2\text{GHz} / 8 = 250\text{MHz}$ .

## Section 4 -- Driver & Utility

Once the operating system has been installed, you need to install the drivers for the mainboard.

English



Insert the bundled CD into the CD-ROM and the main menu screen will appear. The main menu displays links to the supported drivers, utilities and software.

### ► Method 1

This item installs all drivers automatically.

### ► Method 2

This item allows you to install the drivers selectively.

- Step 1 :** Click "**nVIDIA nForce Driver**" to install chipset driver.
- Step 2 :** Click "**REALTEK LAN Driver**" to install LAN driver.
- Step 3 :** Click "**REALTEK High Definition Audio Driver**" to install audio driver.
- Step 4 :** Click "**AMD Cool'n'Quiet Processor Driver**" to install AMD series processor driver.



**Main menu items may vary depending on model you purchased.**

Once the drivers have been successfully installed, you may proceed to install the bundled utility software.

## Section 5 -- Ghost BIOS

Ghost BIOS helps you to recover from a corrupted BIOS situation, which normally would leave your system unable to boot. Ghost BIOS lets you repair the BIOS yourself saving the hassle of returning the mainboard for repair.

### **Preparing for Ghost BIOS:**

1. Install the Thunder Flash utility found in the bundled CD.
2. Create a BIOS Recovery Disk (BRD) with this utility.

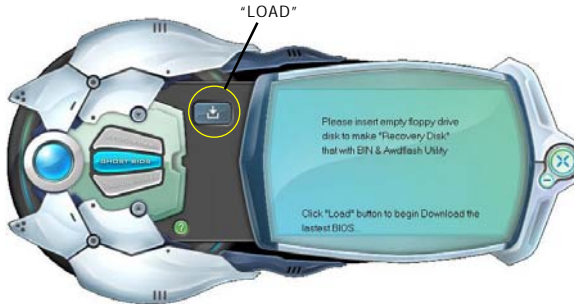

### **Making BIOS Recovery Disk:**

1. Run the Thunder Flash utility.
2. Connect to the internet.
3. Insert a blank floppy disk into floppy drive and click "LOAD".
4. Keep this floppy in a safe place for future use.

### **If BIOS gets corrupted:**

When the BIOS is corrupted or fails, restart the system and this screen will appear. You may chose to recover the BIOS from BRD Floppy created earlier or from bundled driver CD.

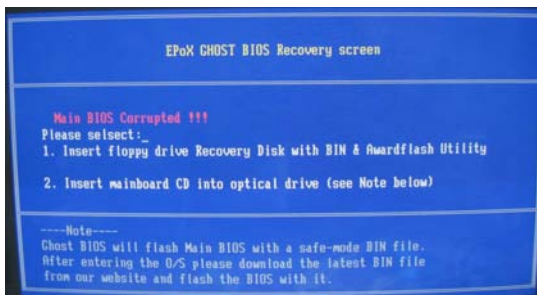

1. If recover from BIOS Recovery Disk floppy, insert the floppy disk created earlier and click "1".
2. If recover from mainboard driver CD, insert driver CD into optical drive and click "2".

 Note that mainboard driver CD consists only of Safe Mode BIOS. Proper BIOS must be updated after you enter the O/S.

## Flow Chart of the Ghost BIOS

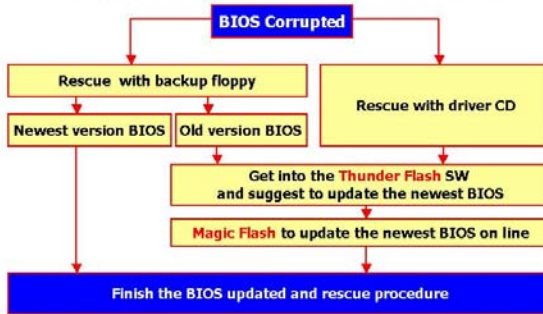

If the screen below is shown, that means your BIOS version is not updated. Refer to Magic Flash steps to update the BIOS.





## Section 6 -- Appendix

### 6-1 Post Codes

POST (hex)	DESCRIPTION
CFh	Test CMOS R/W functionality.
C0h	Early chipset initialization: <ul style="list-style-type: none"><li>- Disable shadow RAM</li><li>- Disable L2 cache (socket 7 or below)</li><li>- Program basic chipset registers</li></ul>
C1h	Detect memory <ul style="list-style-type: none"><li>- Auto-detection of DRAM size, type and ECC.</li><li>- Auto-detection of L2 cache (socket 7 or below)</li></ul>
C3h	Expand compressed BIOS code to DRAM
C5h	Call chipset hook to copy BIOS back to E000 & F000 shadow RAM.
01h	Expand the Xgroup codes locating in physical address 1000:0
02h	Reserved
03h	Initial Superio_Early_Init switch.
04h	Reserved
05h	<ol style="list-style-type: none"><li>1. Blank out screen</li><li>2. Clear CMOS error flag</li></ol>
06h	Reserved
07h	<ol style="list-style-type: none"><li>1. Clear 8042 interface</li><li>2. Initialize 8042 self-test</li></ol>
08h	<ol style="list-style-type: none"><li>1. Test special keyboard controller for Winbond 977 series Super I/O chips.</li><li>2. Enable keyboard interface.</li></ol>
09h	Reserved
0Ah	<ol style="list-style-type: none"><li>1. Disable PS/2 mouse interface (optional).</li><li>2. Auto detect ports for keyboard &amp; mouse followed by a port &amp; interface swap (optional).</li><li>3. Reset keyboard for Winbond 977 series Super I/O chips.</li></ol>
0B-0Dh	Reserved
0Eh	Test F000h segment shadow to see whether it is R/W-able or not. If test fails, keep beeping the speaker.
0Fh	Reserved
10h	Auto detect flash type to load appropriate flash R/W codes into the run time area in F000 for ESCD & DMI support.
11h	Reserved
12h	Use walking 1's algorithm to check out interface in CMOS circuitry. Also set real-time clock power status, and then check for override.
13h	Reserved
14h	Program chipset default values into chipset. Chipset default values are MODBINable by OEM customers.
15h	Reserved
16h	Initial Early_Init_Onboard_Generator switch.
17h	Reserved
18h	Detect CPU information including brand, SMI type (Cyrix or Intel) and CPU level (586 or 686).
19-1Ah	Reserved
1Bh	Initial interrupts vector table. If no special specified, all H/W interrupts are directed to SPURIOUS_INT_HDLR & S/W interrupts to URIOUS_soft_HDLR.
1Ch	Reserved
1Dh	Initial EARLY_PM_INIT switch.
1Eh	Reserved
1Fh	Load keyboard matrix (notebook platform)
20h	Reserved

21h	HPM initialization (notebook platform)
22h	Reserved
23h	<ol style="list-style-type: none"> <li>1. Check validity of RTC value: e.g. a value of 5Ah is an invalid value for RTC minute.</li> <li>2. Load CMOS settings into BIOS stack. If CMOS checksum fails, use default value instead.</li> <li>3. Prepare BIOS resource map for PCI &amp; PnP use. If ESCD is valid, take into consideration of the ESCD's legacy information.</li> <li>4. Onboard clock generator initialization. Disable respective clock resource to empty PCI &amp; DIMM slots.</li> <li>5. Early PCI initialization: <ul style="list-style-type: none"> <li>-Enumerate PCI bus number</li> <li>-Assign memory &amp; I/O resource</li> <li>-Search for a valid VGA device &amp; VGA BIOS, and put it into C000:0.</li> </ul> </li> </ol>
24-26h	Reserved
27h	Initialize INT 09 buffer
28h	Reserved
29h	<ol style="list-style-type: none"> <li>1. Program CPU internal MTRR (P6 &amp; P11) for 0-640K memory address.</li> <li>2. Initialize the APIC for Pentium class CPU.</li> <li>3. Program early chipset according to CMOS setup. Example: onboard IDE controller.</li> <li>4. Measure CPU speed.</li> <li>5. Invoke video BIOS.</li> </ol>
2A-2Ch	Reserved
2Dh	<ol style="list-style-type: none"> <li>1. Initialize multi-language</li> <li>2. Put information on screen display, including Award title, CPU type, CPU speed ....</li> </ol>
2E-32h	Reserved
33h	Reset keyboard except Winbond 977 series Super I/O chips.
34-3Bh	Reserved
3Ch	Test 8254
3Dh	Reserved
3Eh	Test 8259 interrupt mask bits for channel 1.
3Fh	Reserved
40h	Test 8259 interrupt mask bits for channel 2.
41h	Reserved
42h	Reserved
43h	Test 8259 functionality.
44h	Reserved
45-46h	Reserved
47h	Initialize EISA slot
48h	Reserved
49h	<ol style="list-style-type: none"> <li>1. Calculate total memory by testing the last double word of each 64K page.</li> <li>2. Program writes allocation for AMD K5 CPU.</li> </ol>
4A-4Dh	Reserved
4Eh	<ol style="list-style-type: none"> <li>1. Program MTRR of M1 CPU</li> <li>2. Initialize L2 cache for P6 class CPU &amp; program CPU with proper cacheable range.</li> <li>3. Initialize the APIC for P6 class CPU.</li> <li>4. On MP platform, adjust the cacheable range to smaller one in case the cacheable ranges between each CPU are not identical.</li> </ol>
4Fh	Reserved
50h	Initialize USB
51h	Reserved
52h	Test all memory (clear all extended memory to 0)
53-54h	Reserved
55h	Display number of processors (multi-processor platform)
56h	Reserved
57h	<ol style="list-style-type: none"> <li>1. Display PnP logo</li> <li>2. Early ISA PnP initialization</li> </ol>

---

	-Assign CSN to every ISA PnP device.
58h	Reserved
59h	Initialize the combined Trend Anti-Virus code.
5Ah	Reserved
5Bh	(Optional Feature) Show message for entering AWDFLASH.EXE from FDD (optional)
5Ch	Reserved
5Dh	1. Initialize Init_Onboard_Super_IO switch. 2. Initialize Init_Onboard_AUDIO switch.
5E-5Fh	Reserved
60h	Okay to enter Setup utility; i.e. not until this POST stage can users enter the CMOS setup utility.
61-64h	Reserved
65h	Initialize PS/2 Mouse
66h	Reserved
67h	Prepare memory size information for function call: INT 15h ax=E820h
68h	Reserved
69h	Turn on L2 cache
6Ah	Reserved
6Bh	Program chipset registers according to items described in Setup & Auto-configuration table.
6Ch	Reserved
6Dh	1. Assign resources to all ISA PnP devices. 2. Auto assign ports to onboard COM ports if the corresponding item in Setup is set to "AUTO".
6Eh	Reserved
6Fh	1. Initialize floppy controller 2. Set up floppy related fields in 40:hardware.
70-72h	Reserved
73h	(Optional Feature) Enter AWDFLASH.EXE if : -AWDFLASH is found in floppy drive. -ALT+F2 is pressed
74h	Reserved
75h	Detect & install all IDE devices: HDD, LS120, ZIP, CDROM.....
76h	Reserved
77h	Detect serial ports & parallel ports.
78h-79h	Reserved
7Ah	Detect & install co-processor
7B-7Eh	Reserved
7Fh	1. Switch back to text mode if full screen logo is supported. -If errors occur, report errors & wait for keys -If no errors occur or F1 key is pressed to continue: ♦ Clear EPA or customization logo.
80h-81h	Reserved
82h	1. Call chipset power management hook. 2. Recover the text font used by EPA logo (not for full screen logo) 3. If password is set, ask for password.
83h	Save all data in stack back to CMOS
84h	Initialize ISA PnP boot devices
85h	1. USB final Initialization 2. NET PC: Build SYSID structure 3. Switch screen back to text mode 4. Set up ACPI table at top of memory. 5. Invoke ISA adapter ROMs 6. Assign IRQs to PCI devices 7. Initialize APM 8. Clear noise of IRQs.
86-92h	Reserved

---

---

93h	Read HDD boot sector information for Trend Anti-Virus code
94h	<ol style="list-style-type: none"><li>1. Enable L2 cache</li><li>2. Program boot up speed</li><li>3. Chipset final initialization.</li><li>4. Power management final initialization</li><li>5. Clear screen &amp; display summary table</li><li>6. Program K6 write allocation</li><li>7. Program P6 class write combining</li></ol>
95h	<ol style="list-style-type: none"><li>1. Program daylight saving</li><li>2. Update keyboard LED &amp; typematic rate</li></ol>
96h	<ol style="list-style-type: none"><li>1. Build MP table</li><li>2. Build &amp; update ESCD</li><li>3. Set CMOS century to 20h or 19h</li><li>4. Load CMOS time into DOS timer tick</li><li>5. Build MSIRQ routing table.</li></ol>
FFh	Boot attempt (INT 19h)