

# Solid-State Memory Camcorder

*PMW-EX3*

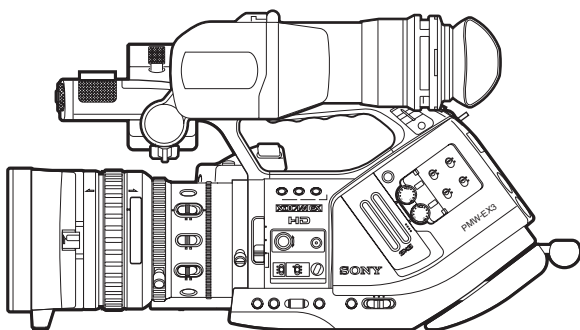

## Operating Instructions

**XDCM EX**

**CINEALTA**

**SXS**

**Exmor™**  
CMOS Sensor



## **WARNING**

**To reduce the risk of fire or electric shock, do not expose this apparatus to rain or moisture.**

**To avoid electrical shock, do not open the cabinet. Refer servicing to qualified personnel only.**

## **WARNING**

When installing the unit, incorporate a readily accessible disconnect device in the fixed wiring, or connect the power plug to an easily accessible socket-outlet near the unit. If a fault should occur during operation of the unit, operate the disconnect device to switch the power supply off, or disconnect the power plug.

Do not install the appliance in a confined space, such as book case or built-in cabinet.

## **IMPORTANT**

The nameplate is located on the bottom.

## **WARNING**

Excessive sound pressure from earphones and headphones can cause hearing loss. In order to use this product safely, avoid prolonged listening at excessive sound pressure levels.

Batteries shall not be exposed to excessive heat such as sunshine, fire or the like.

## **For the customers in the U.S.A.**

This equipment has been tested and found to comply with the limits for a Class A digital device, pursuant to Part 15 of the FCC Rules. These limits are designed to provide reasonable protection against harmful interference when the equipment is operated in a commercial environment. This equipment generates, uses, and can radiate radio frequency energy and, if not installed and used in accordance with the instruction manual, may cause harmful interference to radio communications. Operation of this equipment in a residential area is likely to cause harmful interference in which case the user will be required to correct the interference at his own expense.

You are cautioned that any changes or modifications not expressly approved in this

manual could void your authority to operate this equipment.

All interface cables used to connect peripherals must be shielded in order to comply with the limits for a digital device pursuant to Subpart B of Part 15 of FCC Rules.

## **For the customers in Europe**

This product with the CE marking complies with both the EMC Directive and the Low Voltage Directive issued by the Commission of the European Community.

Compliance with these directives implies conformity to the following European standards:

- EN60065 : Product Safety (AC adaptor)
- EN55103-1 : Electromagnetic Interference (Emission)
- EN55103-2 : Electromagnetic Susceptibility (Immunity)

This product is intended for use in the following Electromagnetic Environments: E1 (residential), E2 (commercial and light industrial), E3 (urban outdoors), E4 (controlled EMC environment, ex. TV studio)

The manufacturer of this product is Sony Corporation, 1-7-1 Konan, Minato-ku, Tokyo, Japan.

The Authorized Representative for EMC and product safety is Sony Deutschland GmbH, Hedelfinger Strasse 61, 70327 Stuttgart, Germany. For any service or guarantee matters please refer to the addresses given in separate service or guarantee documents.

## **For the State of California, USA only**

Perchlorate Material - special handling may apply, See [www.dtsc.ca.gov/hazardouswaste/perchlorate](http://www.dtsc.ca.gov/hazardouswaste/perchlorate)  
Perchlorate Material : Lithium battery contains perchlorate.

## **For the customers in the USA and Canada RECYCLING LITHIUM-ION BATTERIES**

Lithium-Ion batteries are recyclable. You can help preserve our environment by returning your used rechargeable batteries to the collection and recycling location nearest you.

For more information regarding recycling of rechargeable batteries, call toll free 1-800-822-8837, or visit

<http://www.rbrc.org/>

Caution: Do not handle damaged or leaking  
Lithium-Ion batteries.



**For the customers in Taiwan only**



廢電池請回收

# Table of Contents

---

## Overview

<b>Package Configuration .....</b>	<b>10</b>
<b>Features .....</b>	<b>11</b>
<b>Using the CD-ROM .....</b>	<b>14</b>
Reading the CD-ROM Manuals .....	14
System Requirements for Using the Applications .....	14
Software Installation .....	15
<b>Parts Identifications .....</b>	<b>16</b>
Camcorder .....	16
Zoom Lens VCL-614B2X (Supplied) .....	20
IR Remote Commander (Supplied) .....	21
<b>On-Screen Indications .....</b>	<b>23</b>
Indications in Camera Mode .....	23
Direct Menu Operation .....	24

---

## Preparations

<b>Power Supply .....</b>	<b>26</b>
Using a Battery Pack .....	26
Using AC Power (DC IN Power) .....	27
Turning Power On .....	28
Turning Power Off .....	28
<b>Setting the Clock .....</b>	<b>29</b>
<b>Adjusting the Viewfinder .....</b>	<b>30</b>
<b>Adjusting the Lens .....</b>	<b>33</b>
Adjusting the Flange Focal Length .....	33
Replacing the Lens .....	34
Retrieving the Lens File .....	35
<b>Adjusting the Grip .....</b>	<b>36</b>
<b>Using the Cheek Pad .....</b>	<b>37</b>
<b>Using the IR Remote Commander .....</b>	<b>39</b>
<b>Handling SxS Memory Cards .....</b>	<b>40</b>
About SxS Memory Cards .....	40
Inserting/Removing an SxS Memory Card .....	41
Switching Between SxS Memory Cards .....	43
Formatting an SxS Memory Card .....	43

Checking the Remaining Time Available for Recording .....	43
Restoring an SxS Memory Card .....	44
<b>Using the PHU-60K .....</b>	<b>45</b>
Connecting/Removing the PHU Connection Cable .....	45
Formatting the PHU-60K .....	45
Checking the Remaining Time Available for Recording .....	46
Restoring the PHU-60K .....	46

---

## Recording

<b>Basic Operation Procedure .....</b>	<b>47</b>
<b>Selecting the Video Format .....</b>	<b>49</b>
Selectable Formats .....	49
Changing the Format .....	50
<b>Switching the ND Filters .....</b>	<b>50</b>
<b>Adjusting the White Balance .....</b>	<b>51</b>
Selecting the Adjustment Mode .....	51
Executing Auto White Balance .....	52
<b>Adjusting the Black Balance .....</b>	<b>53</b>
<b>Displaying the Markers and Zebra Patterns .....</b>	<b>53</b>
Displaying the Markers .....	53
Displaying the Zebra Patterns .....	54
<b>Setting the Gain .....</b>	<b>55</b>
Recording With Fixed Gain .....	55
Recording in AGC Mode .....	56
<b>Setting the Electronic Shutter .....</b>	<b>56</b>
Shooting in a Fixed Shutter Mode .....	56
Shooting in EX Slow Shutter Mode .....	58
Shooting in Auto Shutter Mode .....	58
<b>Adjusting the Iris .....</b>	<b>58</b>
Recording in Auto Iris Mode .....	58
Adjusting the Iris Manually .....	59
<b>Adjusting the Zoom .....</b>	<b>59</b>
Switching the Zoom Mode .....	59
Operating the Zoom Manually .....	60
Using the Power Zoom .....	60
<b>Adjusting the Focus .....</b>	<b>61</b>
Adjusting in Full MF Mode .....	61
Adjusting in MF Mode .....	62

Adjusting in AF Mode .....	63
Using Macro Mode .....	64
<b>Eliminating Picture Blurring (Steady Shot) .....</b>	<b>64</b>
<b>Reducing Flickers .....</b>	<b>65</b>
<b>Setting the Time Data .....</b>	<b>65</b>
Running Modes of the Timecode .....	65
Setting the Timecode .....	66
Setting the User Bits .....	66
Displaying the Time Data .....	67
<b>Recording Audio Signals .....</b>	<b>67</b>
Using the Built-in Stereo Microphones .....	67
Using External Inputs .....	68
Using an External Microphone .....	68
Adjusting the Audio Recording Levels .....	68
Monitoring the Audio .....	69
<b>Outputting the Color Bars and Reference Tone .....</b>	<b>69</b>
<b>Recording Shot Marks .....</b>	<b>70</b>
<b>Rec Review .....</b>	<b>71</b>
<b>Changing Functions of the Assignable Buttons .....</b>	<b>72</b>
<b>Interval Recording .....</b>	<b>73</b>
Preparatory Settings .....	73
Performing Interval Recording .....	73
<b>Frame Recording .....</b>	<b>74</b>
Preparatory Settings .....	74
Performing Frame Recording .....	75
<b>Slow &amp; Quick Motion Recording .....</b>	<b>76</b>
Preparatory Settings .....	76
Recording in Slow & Quick Motion Mode .....	77
<b>Freeze Mix: Image Alignment .....</b>	<b>77</b>
<b>Shot Transition .....</b>	<b>78</b>
Preparatory Settings .....	79
Recording with a Shot Transition .....	81
<b>Fader Function .....</b>	<b>82</b>
Preparatory Settings .....	82
Starting Recording with a Fade In .....	83
Ending Recording with a Fade Out .....	83
<b>Picture Profiles .....</b>	<b>84</b>
Registering the Customized Settings as a Picture Profile .....	84
Selecting a Picture Profile .....	85
Copying the Settings of a Picture Profile .....	85

Resetting a Picture Profile .....	86
Picture Profile Items .....	87
<b>Deleting Clips .....</b>	<b>91</b>
Deleting the Last Recorded Clip .....	91
Deleting All Clips .....	91
<b>Storing/Retrieving the Setting Data .....</b>	<b>92</b>
Storing the Setup File .....	92
Retrieving the Setup File .....	92
Resetting to the Standard Values .....	92

---

## Playback

<b>Playing Back Clips .....</b>	<b>93</b>
Thumbnail Screen .....	93
Playback .....	94
<b>Clip Operations .....</b>	<b>98</b>
Clip Operation Menus .....	98
Basic Operations of the Clip Operation Menus .....	99
Displaying the Detailed Information of a Clip .....	100
Adding the OK Mark to a Clip .....	100
Copying a Clip .....	101
Deleting a Clip .....	101
Displaying the EXPAND CLIP Screen .....	101
Displaying the SHOT MARK Screen .....	102
Adding/Deleting Shot Marks .....	103
Changing the Index Frame .....	104
Dividing a Clip .....	104

---

## Status Displays

<b>Showing the Status Screens .....</b>	<b>105</b>
<b>CAMERA Status Screen .....</b>	<b>106</b>
<b>AUDIO Status Screen .....</b>	<b>107</b>
In Camera Mode .....	107
In Media Mode .....	107
<b>VIDEO Status Screen .....</b>	<b>108</b>
<b>BUTTON/REMOTE Status Screen .....</b>	<b>108</b>
<b>BATTERY/MEDIA Status Screen .....</b>	<b>109</b>

---

## Menu Configuration and Detailed Settings

<b>Overview of the Setup Menus .....</b>	<b>110</b>
--	------------

Setup Menu Configuration .....	110
Setup Menu Layers .....	110
<b>Basic Menu Operations .....</b>	<b>111</b>
<b>Setup Menu List .....</b>	<b>114</b>
CAMERA SET Menu .....	114
AUDIO SET Menu .....	118
VIDEO SET Menu .....	119
VF SET Menu .....	120
TC/UB SET Menu .....	122
LENS Menu .....	122
OTHERS Menu .....	124

---

## Connecting External Devices

<b>Connecting External Monitors .....</b>	<b>128</b>
<b>Operating Clips With a Computer .....</b>	<b>130</b>
<b>Connecting an External Device (i.LINK Connection) .....</b>	<b>132</b>
Recording the Camcorder Picture on an External Device .....	132
Nonlinear Editing .....	133
Recording External Input Signals .....	133
<b>External Synchronization .....</b>	<b>134</b>
<b>Operating From the RM-B750/B150 .....</b>	<b>136</b>
Operating the Menus of the Camcorder .....	136
Functions Operable From the RM-B750/B150 (Camera Mode) .....	138

---

## Appendixes

<b>Important Notes on Operation .....</b>	<b>140</b>
<b>Formats and Limitations of Outputs .....</b>	<b>141</b>
Video Formats and Output Formats .....	141
Limitations of Outputs .....	142
<b>Lens File Operations .....</b>	<b>143</b>
<b>Backup Battery .....</b>	<b>144</b>
<b>Troubleshooting .....</b>	<b>146</b>
Operating Power .....	146
Recording/Playback .....	146
External Devices .....	147
<b>Error/Warning Indications .....</b>	<b>148</b>
Error Indications .....	148



Warning Indications .....	148
<b>About i.LINK .....</b>	<b>150</b>
<b>MPEG-2 Video Patent Portfolio License .....</b>	<b>151</b>
<b>AVC Patent Portfolio License .....</b>	<b>151</b>
<b>VC-1 Patent Portfolio License .....</b>	<b>152</b>
<b>Specifications .....</b>	<b>152</b>
General .....	152
Camera Block .....	153
Audio Block .....	153
Viewfinder .....	153
Inputs/Outputs .....	153
Supplied Lens (VCL-614B2X) .....	154
Optional Accessories .....	154
<b>Index .....</b>	<b>156</b>

## Overview

# Package Configuration

Make sure you have following items supplied with your camcorder.  
The number in parentheses indicates the number of that item supplied.

### VCL-614B2X exclusive standard zoom lens (1)

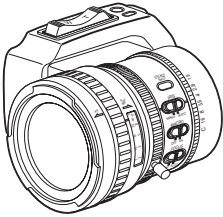

It is attached to the camcorder at the factory.

### Lens hood with lens cap (1)

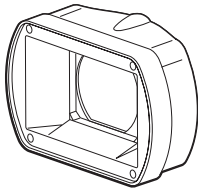

It is attached to the camcorder at the factory.

### Lens adaptor (1)



### Infrared Remote Commander (1)

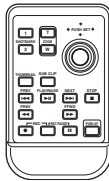

### Eyepiece (1)

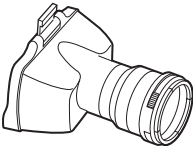

It is attached to the viewfinder at the factory.

### Eyecup (1)



It is attached to the eyepiece at the factory.

### USB cable (1)



### Component video cable (1)

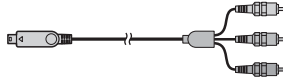

### BP-U30 battery pack (1)

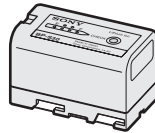

### BC-U1 battery charger (1)

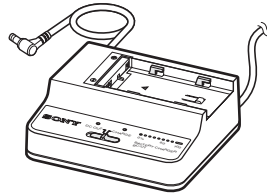

### Shoulder strap (1)

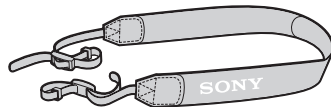

### Cheek pad (1)

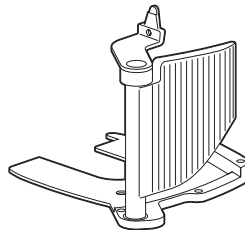

**Lens mount cap (1)****Lens cap for the supplied lens (1)****Fixing screws for the cheek pad (3)****DC cable clamp and fixing screw (1 each)****Lithium battery (CR2032 for backup) (1)**

It is mounted in the camcorder at the factory.

**Lithium battery (CR2025 for the IR Remote Commander) (1)**

It is mounted in the IR Remote Commander at the factory.

**CD-ROM (1)**

XDCAM EX Clip Browsing Software, SxS Device Driver Software, Operating Instructions in PDF format are included.

**Operating Instructions (This manual) (1)****SxS Device Driver Software End-User****License Agreement (1)**

## Features

The PMW-EX3 is a highly compact and high-performance XDCAM EX<sup>1</sup>) camcorder that uses SxS<sup>1</sup>) memory cards, as its recording medium. The imaging devices used in the PMW-EX3 camcorder are three <sup>1</sup>/<sub>2</sub>-inch type CMOS sensors, each with an effective pixel count of 1920 × 1080, which produce images in full HD resolution.

### A New Generation of HD Recording System

**New nonlinear recording media**

Using SxS memory cards, the PMW-EX3 offers nonlinear capabilities such as instant random access and file-based operation.

**HD recording using the “MPEG-2 Long GOP” codec**

The PMW-EX3 records 1920 × 1080 HD images using “MPEG-2 Long GOP” codec compression. This mature “MPEG-2 Long GOP” codec, which is also adopted in the XDCAM<sup>1</sup>) HD and HDV<sup>2</sup>) 1080i series of products, enables you to record stunning-quality HD video and audio with long recording time by efficiently compressing the data.

**Selectable bit rates**

The PMW-EX3 offers a choice of bit rates: either 35 Mbps (HQ mode) or 25 Mbps (SP mode), depending on the desired picture quality and recording time.

**Long recording time**

By utilizing an efficient compression format, the PMW-EX3 records high-quality HD images for long recording time of approx. 100 minutes in HQ mode (35 Mbps VBR) or approx. 140 minutes in SP mode (25 Mbps CBR) on a single 32-GB SxS memory card. Equipped with two SxS memory card slots, the PMW-EX3 makes transition seamless without any frame loss, when recording is done across two cards.

**Multiple-format recording**

The PMW-EX3 camcorder offers a wide array of recording formats for multiple content creation applications. The scanning mode is switchable among 1920 × 1080, 1280 × 720, and 1440 ×

1080 resolutions. Frame rate is also selectable from interlace and progressive (59.94i, 50i, 29.97P, 25P, and native 23.98P). In addition, 59.94P and 50P progressive recording is available in 1280 × 720 mode. SxS memory cards can simultaneously hold multiple files of any of these recording formats, allowing for flexible use of the memory cards.

### High-quality uncompressed audio recording

In addition to HD video recording, the PMW-EX3 can record and play back high-quality, two-channel 16-bit, 48-kHz linear PCM uncompressed audio.

### IT friendly

The file-based recording in MP4 format allows material to be handled with great flexibility in an IT-based environment, easily available for copying, transferring, sharing, and archiving.

### For immediate recording start

In recording on flash memory cards, the XDCAM EX system makes each new recording on an empty area of the card. This is extremely convenient, as the camera operator need not worry about accidentally recording over good takes or search through footage for the correct position to start the next recording.

### Instant-access thumbnail display with “Expand” function

Each time a recording is started and stopped on the XDCAM EX camcorder, the video and audio signals are recorded as one clip. Furthermore, thumbnails are automatically generated for each clip as a visual reference, allowing the operator to cue-up to a desired scene simply by guiding the cursor to a thumbnail. For further convenience, the ‘Expand’ function allows one selected clip in the Thumbnail display to be divided into 12 equal time intervals, each with its own thumbnail identifier. This is useful if you wish to quickly search for a particular scene within a lengthy clip.

## Cutting-edge Camera Technologies

### 1/2-inch type three “Exmor”<sup>1)</sup> CMOS sensors

The PMW-EX3 is equipped with three newly developed 1/2-inch “Exmor” CMOS Sensors, which deliver excellent picture performance with full HD resolution.

### Newly developed lens mount

The PMW-EX3 employs a new lens mount (1/2-inch EX Mount) of superior optical characteristics in a compact size, which permits the supplied standard zoom lens and an optionally available lens specifically designed for the PMW-EX3 to be mounted.

For use of a conventional Sony 1/2-inch Bayonet Mount lenses, a lens adaptor is provided as a supplied accessory.

### VCL-614B2X high-performance zoom lens (supplied)

The PMW-EX3 is equipped with a zoom lens specifically designed for the camcorder, to offer optimum shooting performance. Independent rings for zoom, focus, and iris adjustment give the user a high level of smooth operational control. The lens has versatile functions for easy and precise focus adjustments.

- One-push Auto Focus
- MF Assist
- Optical Image Stabilizer (Steady Shot)

## Creative Recording Modes and Settings

### 23.98P native recording

The PMW-EX3 camcorder, a new member of Sony’s legendary CineAlta<sup>1)</sup> family, though compact offers native 23.98P recording capability.

### Slow & Quick Motion function

The PMW-EX3 offers a Slow & Quick Motion function, commonly known as overcranking and undercranking in film shooting, which enables you to create unique ‘looks’ or special effects of slow- and fast-motion images.

### Slow Shutter function

The PMW-EX3 offers a Slow Shutter function for capturing clear images in low-light environments. This allows the shutter speed to be changed to a maximum of 64-frame accumulation period.

### Selectable gamma curves

The PMW-EX3 provides various types of gamma identical to those of other CineAlta camcorders.

### Interval Recording function

The PMW-EX3 offers an Interval Recording function that intermittently records signals at pre-determined intervals. This is convenient for shooting over long periods of time and also when creating pictures with special effects of extremely quick motion.

### Frame Recording function

Frame Recording is a unique feature of the PMW-EX3 camcorder that is especially useful for clay-animation shooting. With this function, images for pre-determined frame are recorded each time the record button is pressed.

### Shutter-angle settings

In addition to the electric shutter speed controls, the PMW-EX3 also has a “shutter angle” control, which is familiar to cinematographers.

### Picture Profile feature

The Picture Profile feature allows the camera operator to easily call up customized picture-tonal settings to suit particular shooting conditions.

### Shot Transition function

The Shot Transition function allows for smooth automatic scene transitions. The operator can program start and end settings for zoom, focus, and white balance into the A and B buttons, and with a press of the Start button a smooth transition will take place according to the set time.

---

## A variety of functions and designs for high operability

---

- Color viewfinder incorporated with a 3.5-inch color LCD inside: Flipping up the eyepiece, you can also operate the camcorder while directly viewing the LCD.
- Expanded Focus
- Peaking
- Depth-of-field indicator
- Brightness-level display
- Histogram indicator
- Four assignable buttons
- Zoom and recording start/stop operations enabled both on the handle and the grip
- Long operating time with a battery pack
- Wide array of interfaces, including USB and i.LINK<sup>1)</sup>
- ATW (Auto Tracing White Balance)
- Built-in ND filter wheel
- Selectable gain
- High-speed picture search: ×4, ×15
- Freeze Mix function
- IR Remote Commander<sup>1)</sup> supplied
- Input/output connectors for external synchronization

- Operations from the optional Remote Control Units: The camcorder can be operated from the RM-B750/B150 Remote Control Unit.

- 1) Sony, XDCAM, XDCAM EX, SxS, i.LINK, Exmor, CineAlta, and Remote Commander are trademarks of Sony Corporation.
- 2) HDV is a trademark of Sony Corporation and Victor Company of Japan, Limited.

All other trademarks are the property of their respective owners.

---

## XDCAM EX web sites

---

For information on XDCAM EX, visit the following web sites:

### United States

<http://www.sony.com/xdcamex>

### Canada

<http://www.sony.ca/xdcamex>

### Europe, Middle East, Africa, and Russia

<http://www.sonybiz.net/xdcamex>

### Latin America

<http://www.sonypro-latin.com/xdcamex>

### Australia

[www.sony.com.au/xdcamex](http://www.sony.com.au/xdcamex)

### Asia (except Korea, China, and Japan)

<http://pro.sony.com.hk>

### Korea

<http://bp.sony.co.kr/xdcamex>

### China

<http://pro.sony.com.cn/minisite/XDCAMEX>

### Japan

<http://www.sony.co.jp/XDCAMEX>

## Using the CD-ROM

The supplied CD-ROM includes the following files:

### PMW-EX3 Operating Instructions

The Operating Instructions for the PMW-EX3 (Japanese, English, French, German, Italian, Spanish and Chinese) are provided in PDF format.

### SxS Device Driver Software

Driver for using SxS memory cards with a computer having an ExpressCard slot. Information on installation of the software is included in the ReadMe (Japanese, English, French, German, Italian, Spanish, and Chinese) in PDF format.

### XDCAM EX Clip Browsing Software

Application program for operating clips recorded with XDCAM EX-series models on a computer. Information on installation and operations of the software is included in the User's Guide (Japanese, English, French, German, Italian, Spanish, and Chinese) in PDF format.

## Reading the CD-ROM Manuals

### Preparations

The following program must be installed on your computer in order to read the operation manuals contained on the CD-ROM.

Adobe Reader Version 6.0 or higher

#### Memo

If Adobe Reader is not installed, you can download it from the following URL:  
<http://www.adobe.com/>

Adobe and Adobe Reader are trademarks of Adobe Systems Incorporated in the United States and/or other countries.

### To read the documents

Do the following:

- 1 **Insert the CD-ROM in your CD-ROM drive.**

A cover page appears automatically in your browser.

If it does not appear automatically in the browser, double-click on the index.htm file on the CD-ROM.

- 2 **Select and click on the manual that you wish to read.**

This opens the PDF file.

#### Memo

The files may not be displayed properly, depending on the version of Adobe Reader. In such a case, install the latest version you can download from the URL mentioned in "Preparations" above.

#### Note

If you have lost or damaged the CD-ROM, you can purchase a new one to replace it. Contact your Sony service representative.

## System Requirements for Using the Applications

The following operating conditions are recommended for using the software recorded on the CD-ROM:

### SxS Device Driver Software

#### Applicable hardware

Computer conforming to ExpressCard/34 or ExpressCard/54

#### OS

Microsoft Windows XP SP2 or later, Microsoft Windows Vista, or Mac OS X v10.4.9 or later

For support information on the driver, refer to the following URL:

<http://www.sony.net/SxS-Support/>

### XDCAM EX Clip Browsing Software

#### OS

Microsoft Windows XP SP2 or later (32-bit version), Microsoft Windows Vista (32-bit version), or Mac OS X v10.4.10 or later

**CPU**

**Windows:** Intel Pentium III 1GHz equivalent or higher (Intel PentiumD 3GHz equivalent or higher is recommended)

**Macintosh:** Intel Core 2 Duo 2GHz or higher is recommended

**Memory**

**Windows:** 512 MB or more (1 GB or more is recommended)

**Macintosh:** 1 GB or more is recommended

- Microsoft, Windows, and Windows Vista are registered trademarks and/or trademarks of Microsoft Corporation in the United States and/or other countries.
- Intel Core and Pentium are trademarks of Intel Corporation in the United States and/or other countries.
- Macintosh and Mac OS are trademarks of Apple Inc. registered in the U.S States and other countries.

## Software Installation

Do the following to install the software on the CD-ROM on your computer:

### 1 Insert the CD-ROM in your CD-ROM drive.

A cover page appears automatically in your browser.

If it does not appear automatically in the browser, double-click on the index.htm file on the CD-ROM.

### 2 Select and click on the software that you wish to install.

The installer for the software starts up.

Follow the displayed instructions:

*For details, refer to the User's Guide or ReadMe of the software.*

---

## Uninstalling an application program

**Windows computer**

Choose “Start,” “Control Panel” then “Add or Remove Programs” and specify the program to be deleted.

**Macintosh computer**

Drop the folder of the software (default: /Application/XDCAM EX Clip Browser) into Trash.

# Parts Identifications

## Camcorder

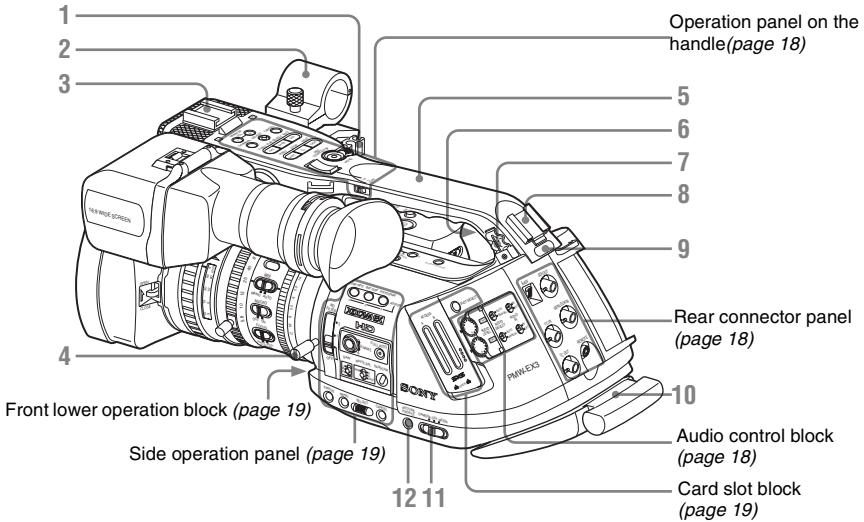

For functions and usage, see the pages shown in parentheses.

1. **Cable clamp for external microphone** (page 68)
2. **External microphone holder** (page 68)
3. **Front accessory shoe**  
Attach an optional accessory, such as a video light.
4. **Lens mount lever** (page 34)
5. **Handle**
6. **Built-in speaker** (page 96)
7. **Cable clamp for optional accessories** (page 68)
8. **Rear accessory shoe**  
Attach an optional accessory, such as the PHU-60K Professional Hard Disk Unit (page 45).
9. **Rear tally lamp** (page 48, page 148)

### 10. Shoulder pad

It can be pulled out as follows:

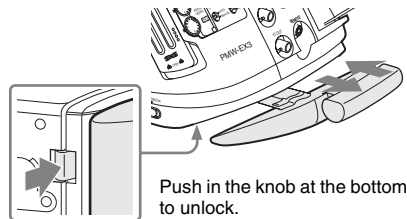

Push in the knob at the bottom to unlock.  
Hold the knob depressed when pulling out or pushing in the pad.

### 11. Power (CAMERA/MEDIA) switch (page 28)

### 12. PICTURE PROFILE button (page 84)



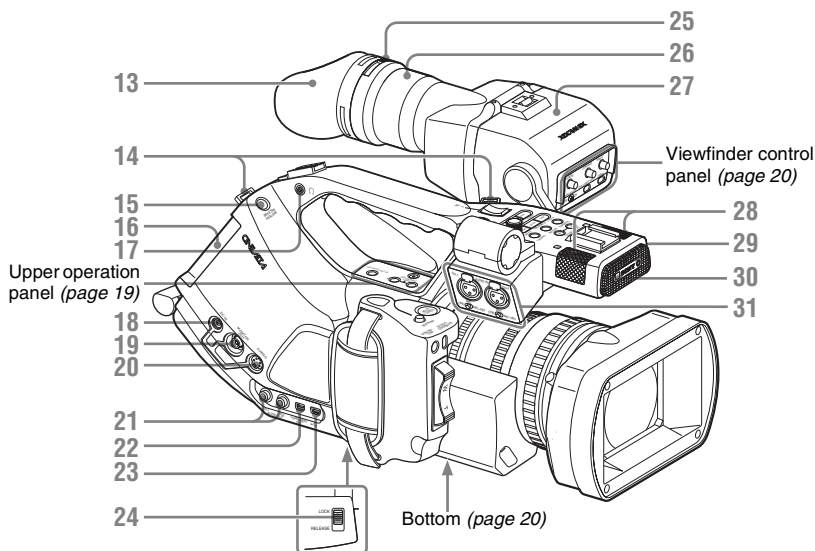

Connectors 18 to 20 have individual caps, and 21 to 23 are behind a shared cover.

### 13. Eyecup

The eyecup can be attached in the reversed direction.

To reattach the eyecup, stretch it a little to attach to the viewfinder and fit the rim of the eyecup into the groove of the viewfinder.

### 14. Hooks for the shoulder strap (left and right)

Attach the supplied shoulder strap as shown below.

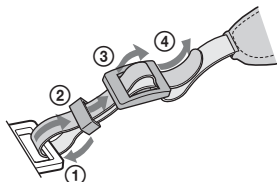

### 15. BATTERY RELEASE button (page 26)

### 16. Battery pack receptacle (page 26)

### 17. Headphone jack (stereo mini jack) (page 69, page 96)

### 18. DC IN (DC power input) connector (page 27)

### 19. MONITOR OUT connector (BNC type) (page 129)

### 20. S VIDEO connector (4-pin) (page 129)

### 21. AUDIO OUT CH-1/CH-2 connectors (RCA phono) (page 129)

### 22. COMPONENT OUT connector (Mini D) (page 129)

### 23. USB connector (Mini B) (page 130)

### 24. Lens mount stopper switch (page 34)

### 25. Eyepiece focusing knob (page 30)

### 26. Eyepiece (page 32)

### 27. Viewfinder (page 30)

### 28. Built-in microphones (page 67)

### 29. REC/TALLY lamp (page 48, page 148)

### 30. IR remote control receptor

### 31. AUDIO IN CH-1/CH-2 connectors (XLR) and input selection switches (page 67)

## Operation panel on the handle

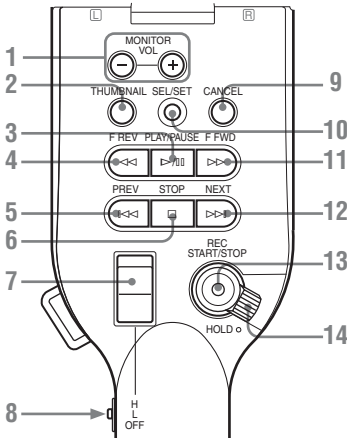

1. **MONITOR VOL** (volume) buttons (*page 69, page 96*)
2. **THUMBNAIL** button (*page 94*)
3. **PLAY/PAUSE** button (*page 94*)
4. **F REV** (fast reverse) button (*page 95*)
5. **PREV** (previous) button (*page 95*)
6. **STOP** button (*page 96*)
7. **On-handle ZOOM** button (*page 60*)
8. **Zoom speed switch** (*page 60*)
9. **CANCEL** button (*page 111*)
10. **SEL/SET** (selection/set) button (Joystick) (*page 111*)

It functions accordingly when you move it up (forward), down (rearward), left, or right, or you push along the axis.

It is called “the joystick” in the subsequent operating instructions.

11. **F FWD** (fast forward) button (*page 95*)
12. **NEXT** button (*page 96*)
13. **REC START/STOP** button (*page 48*)
14. **REC HOLD** lever (*page 48*)

## Rear connector panel

The connectors are located under the respective caps.

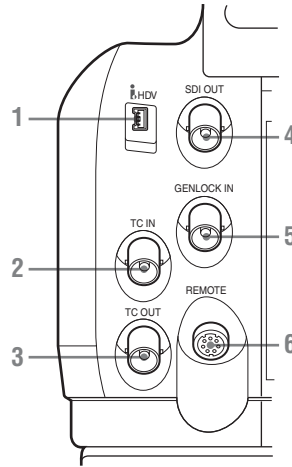

1. **i.LINK (HDV)** connector (4-pin, S400 conforming to IEEE1394) (*page 132*)
2. **TC IN** (timecode input) connector (BNC type) (*page 134*)
3. **TC OUT** (timecode output) connector (BNC type) (*page 135*)
4. **SDI OUT** connector (BNC type) (*page 129*)
5. **GENLOCK IN** connector (BNC type) (*page 134*)
6. **REMOTE** connector (8-pin) (*page 138*)

## Audio control block

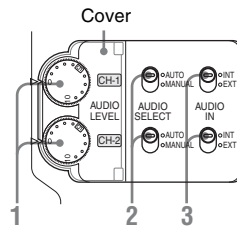

1. **AUDIO LEVEL CH-1/CH-2** controls (*page 67*)
2. **AUDIO SELECT** (audio level control mode selection) switches (*page 67*)

### 3. AUDIO IN (audio input selection) switches (page 67)

#### Front lower operation block

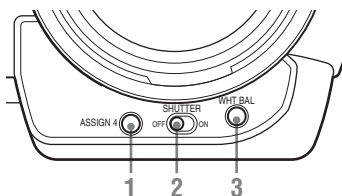

1. ASSIGN 4 (assignable 4) button (page 72)
2. SHUTTER switch (page 56)
3. WHT BAL (automatic white balance adjustment) button (page 51)

#### Side operation panel

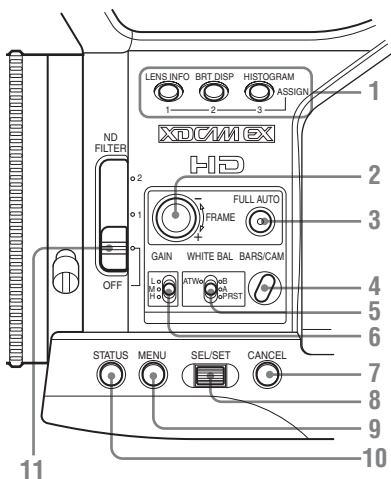

1. ASSIGN (assignable) 1/2/3 buttons (page 72)
2. S&Q (Slow & Quick) Motion dial (page 76)
3. FULL AUTO button and indicator (page 48)
4. BARS/CAM (color bar/camera signal switching) button (page 69)

### 5. WHITE BAL (white balance memory) switch (page 51)

### 6. GAIN switch (page 55)

### 7. CANCEL button (page 111)

### 8. SEL/SET (selection/set) dial (Jog dial) (page 111)

It functions accordingly when you turn it up or down, or you push it horizontally. It is called “the jog dial” in the subsequent operating instructions.

### 9. MENU (menu display ON/OFF) button (page 111)

### 10. STATUS button (page 105)

### 11. ND filter select switch (page 50)

#### Card slot block

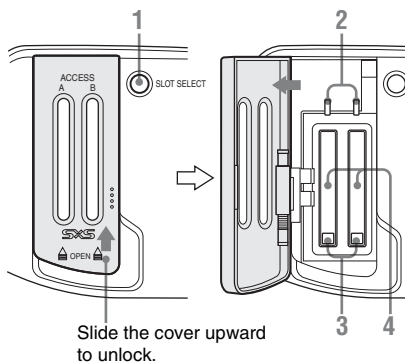

1. SLOT SELECT (SxS memory card select) button (page 43)
2. ACCESS lamps (page 41)
3. EJECT buttons (page 42)
4. SxS memory card slots (page 41)

#### Upper operation panel

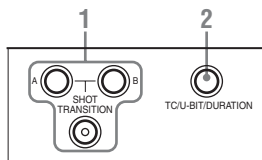

1. **SHOT TRANSITION** operation block (page 78)
2. **TC/U-BIT/DURATION** (time data selection) button (page 67, page 95)

### Viewfinder control panel

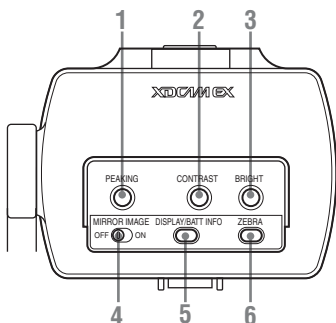

1. **PEAKING** control (page 62)
2. **CONTRAST** control (page 30)
3. **BRIGHT** control (page 30)
4. **MIRROR IMAGE** switch (page 31)
5. **DISPLAY/BATT INFO** button (page 23)
6. **ZEBRA** button (page 54)

### Bottom

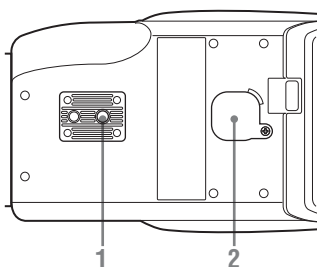

#### 1. Tripod receptacle

##### Note

Check that the size of the hole matches the screw of the tripod. If they do not match, the camcorder cannot be attached to the tripod securely.

#### 2. Backup battery holder (page 144)

### Zoom Lens VCL-614B2X (Supplied)

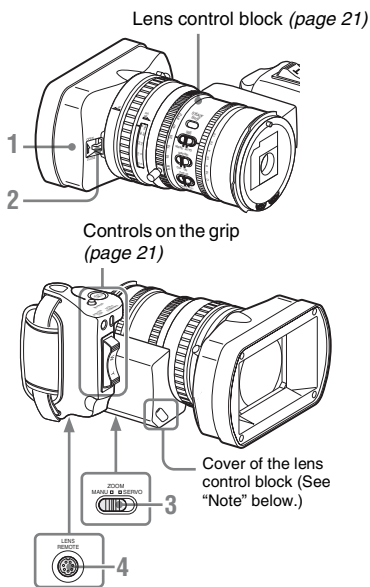

1. **Lens hood**
2. **Lens cap open/close lever** (page 47)
3. **ZOOM** switch (page 59)
4. **LENS REMOTE** connector (page 61)

##### Note

The lens is properly adjusted at the factory. Do not touch the controls of the lens control block.

#### To remove the lens hood

① Loosen the hood fixing screw, ② turn the hood in the direction of the arrow, ③ then pull it out.

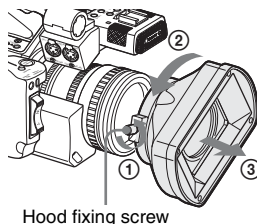

Hood fixing screw

To reattach the hood, align the marks on the hood with those on the camcorder, turn it in the opposite direction from that when you removed it, then tighten the fixing screw.

## Lens control block

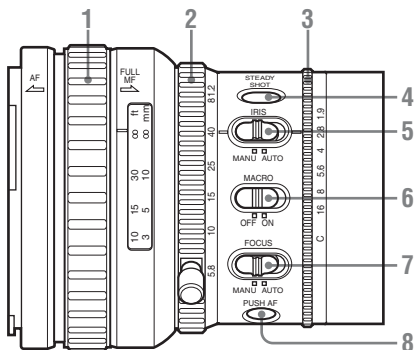

1. Focus ring (page 61)
2. Zoom ring (page 59)
3. Iris ring (page 58)
4. STEADY SHOT button (page 64)
5. IRIS switch (page 58)
6. MACRO switch (page 64)
7. FOCUS switch (page 62)
8. PUSH AF (momentary auto focus) button (page 63)

## Controls on the grip

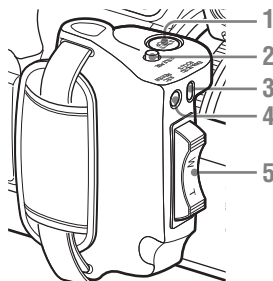

1. REC START/STOP button (page 48)
2. RELEASE (grip release) button (page 36)

3. REC REVIEW button (page 71)
4. EXPANDED FOCUS button (page 62)
5. Servo zoom lever (page 60)

## IR Remote Commander (Supplied)

The buttons without remarks can be used in the same manner as the corresponding buttons on the camcorder.

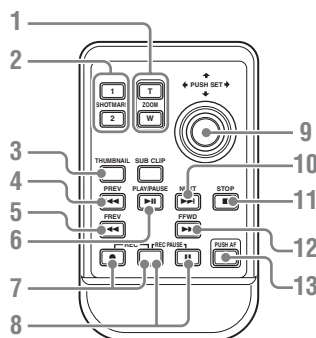

1. ZOOM T/W (telephoto/wide-angle) button
2. SHOTMARK 1 and 2 buttons (page 70, page 103)
3. THUMBNAIL button
4. PREV (previous clip jump) button
5. F REV (fast reverse) button
6. PLAY/PAUSE button
7. REC (record) buttons  
Press the ● button together with the unmarked button (safety button) to start recording.
8. REC PAUSE buttons  
Press the ■ button together with the unmarked button (safety button) to pause recording.
9. PUSH SET button (four-way arrow key)  
It functions the same as the SEL/SET button (joystick) on the camcorder.
10. NEXT button
11. STOP button
12. F FWD (fast forward) button
13. PUSH AF button

**Note**

The SUB CLIP button does not function with this camcorder.

*When you use the remote commander, see "Using the IR Remote Commander" on page 39.*

# On-Screen Indications

## Indications in Camera Mode

When this unit is in Camera mode (mode for recording), pressing the DISPLAY/BATT INFO button displays the statuses and settings of this unit in the viewfinder.

When you press the DISPLAY/BATT INFO button again, these indications are canceled. The recording status indication, such as “●REC,” is always displayed, regardless of operation of the DISPLAY/BATT INFO button.

### Remarks

- [M]: The indication of the items named with this suffix can be independently turned on/off with “Display On/Off” of the VF SET menu (see page 121).
- [A]: The indication of items named with this suffix can be turned on/off using the assignable buttons to which the corresponding on/off functions have been assigned (see page 72).
- [D]: The settings of the items named with this suffix can be changed using the Direct menu on the screen (see page 24).

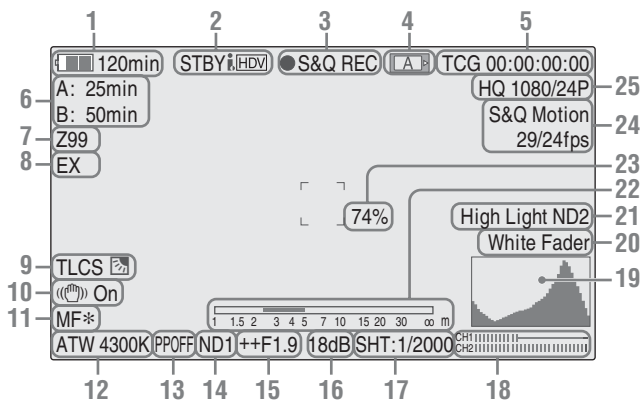

### 1. Battery remaining/DC IN voltage indication [M] (page 26)

#### 2. i.LINK status indication

Only when an external device is connected to the i.LINK connector (page 132), the status (●REC or STBY) of the device is displayed.

### 3. Special recording/operation status indication

●REC	Recording in progress
STBY	Standby for recording
●S&Q REC	Slow & Quick Motion recording in progress



S&Q STBY	Standby for Slow & Quick Motion recording
●INT REC	Interval Recording in progress
INT STBY	Standby for Interval Recording
●FRM REC	Frame Recording in progress
FRM STBY	Standby for Frame Recording

### 4. Media status indication

[A]	Memory card in slot A is active.
[B]	Memory card in slot B is active.

### 5. Time data indication [M] (page 67)

- 6. Media remaining indication M (page 43)
- 7. Zoom position indication M (page 59)
- 8. Lens extender indication  
(available only when a lens extender is used)
- 9. TLCS mode indication M D (page 117)

	Backlight mode
	Standard mode
	Spotlight mode

- 10. Steady Shot indication M (page 64)
- 11. Focus mode indication M (D only in MF mode) (page 61)  
(available only when an auto-focus lens is mounted)
- 12. White balance mode and color temperature indications M D (page 51)
- 13. Picture profile indication M D (page 84)
- 14. ND filter indication M (page 50)
- 15. Iris position indication M D (page 58)
- 16. Gain indication M D (page 55)
- 17. Shutter mode/shutter speed indication M D (page 56)
- 18. Audio level meters M (page 68)
- 19. Histogram indication M A
- 20. Fader indication M (page 82)
- 21. Video level cautioning indication M  
If the video level is too high or too low, a caution is generated showing the appropriate ND filter number.
- 22. Depth-of-Field indication M A  
(available only when a serial lens is mounted)
- 23. Brightness level indication M A
- 24. Special recording mode indication M

Frame Rec	Frame Rec mode
Interval Rec	Interval Rec mode
S&Q Motion xx/xx fps	Slow & Quick Motion mode
EXT-LK	Time code external lock (see page 134)

- 25. Video Format indication M (page 49)

## Direct Menu Operation

The settings of the items named with a suffix D can be changed using the Direct menu on the screen.

Select “All,” “Part,” or “Off” for Direct Menu using “Direct Menu” (page 126) of the OTHERS menu.

When the Direct mode is set to “Part,” the operation is limited depending on the GAIN, SHUTTER, or WHITE BAL switch setting. When the Direct mode is set to “All,” the GAIN, SHUTTER, and WHITE BAL switches are disabled.

### Note

When the indicator of the FULL AUTO button is lit, the Direct Menu operation is disabled for the functions that are forcibly set to the automatic mode in Full Auto mode (page 48).

### To operate the Direct menu

Use the joystick on the handle or the jog dial on the side operation panel.

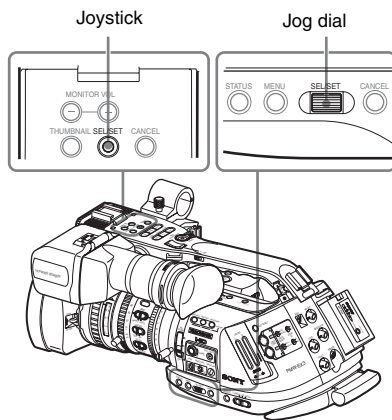

## 1 Press the joystick or the jog dial.

If “Direct Menu” is set to “All” or “Part,” the cursor is displayed on one of the items for which the Direct menu operation is permitted.

**Example:** TLCS mode indication





- 2 **Tilt the joystick or rotate the jog dial to set the cursor to the item to be operated then press the joystick or the jog dial.**

The Direct menu of the selected items appears.

**Example:**

Direct menu for TLCS mode selection

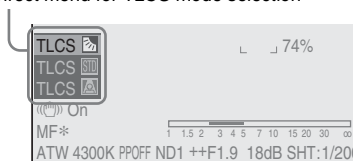

- 3 **Tilt the joystick or rotate the jog dial to select the setting then press the joystick or the jog dial.**

The menu disappears, and the new setting is displayed.

# Power Supply

You can use a battery pack or AC power via an AC adaptor.

If you connect an AC power source, it has a priority even if a battery pack is mounted.

## Using a Battery Pack

Mount a BP-U30 or BP-U60 Lithium-ion battery pack.

One BP-U30 is supplied with this camcorder.

### Notes

- Before use, charge the battery pack with the supplied BC-U1 Battery Charger.
- A warm battery pack immediately after use may not be able to be fully recharged.

## Mounting the battery pack

Fully insert the battery pack then slide it downward to lock.

Battery pack

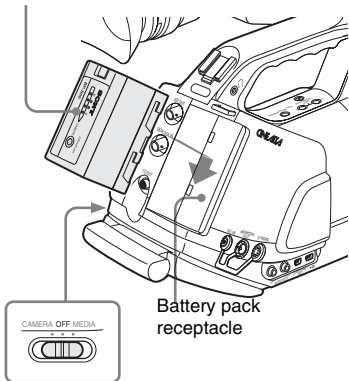

Power switch: OFF

### Note

If a battery pack that cannot be used with this camcorder is mounted, an error message is appears in the viewfinder. Replace the battery pack with the BP-U30 or BP-U60, or connect a power to the DC IN connector after removing the battery pack.

## Removing the battery pack

Hold the BATTERY RELEASE button pressed, slide the battery pack upward to unlock, then pull it out.

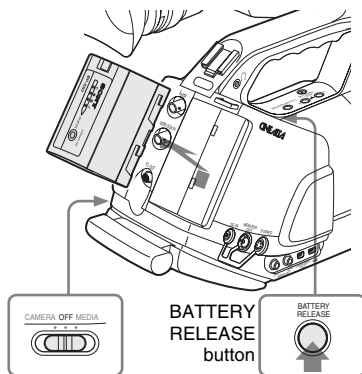

Power switch: OFF

## Checking battery charge remaining

### To check during operation

When recording or playback is in progress on the battery pack, an icon to show the current battery charge level and usage time remaining are displayed in the viewfinder screen.

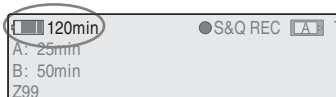

Icon	Remaining
	100% to 91%
	90% to 71%
	70% to 51%
	50% to 31%
	30% to 11%
	10% to 0%

The camcorder indicates the remaining usage time in minutes by calculating the available time

with the battery pack if operation is continued at the current rate of power consumption.

#### Note

The operating time on a battery pack depends on the condition (new or old) of the battery pack and the ambient temperature.

#### To check in power-off status

Information on the mounted battery pack (BATTERY INFO) is displayed in the viewfinder when you hold the DISPLAY/BATT INFO button pressed even if the camcorder is off. The BATTERY INFO display goes off after 5 seconds.

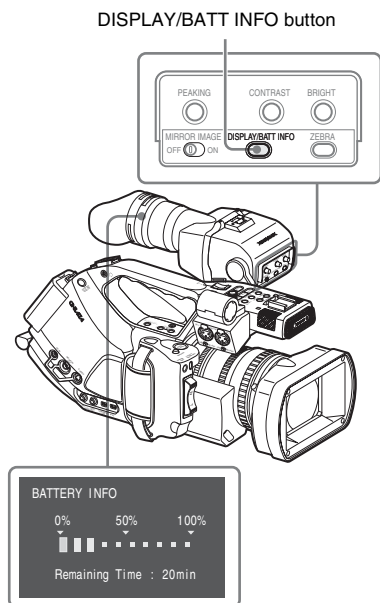

#### If the battery charge remaining becomes low

If the battery charge remaining decreases to a certain level during operation (Low BATT status), a low-battery message, flashing of the tally lamps, and a beep sound will warn you. If the remaining further decreases to a level at which operation cannot be continued (BATT Empty status), a battery-empty message appears. Temporarily set the power switch to OFF and connect a power source via the DC IN connector or replace the battery pack with one that is fully charged.

#### To change the message levels

The Low BATT level is set to 10% of full charge, and the BATT Empty level is set to 3% of full charge at the factory. These settings can be changed with “Battery Alarm” (page 126) of the OTHERS menu.

#### Using AC Power (DC IN Power)

You can connect an AC power source to this camcorder by using the supplied BC-U1 Battery Charger for BP-U30/U60 as an AC adaptor, as shown below:

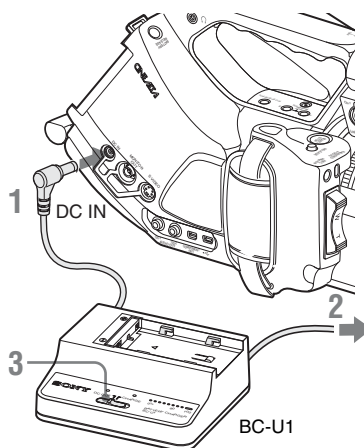

- 1 Connect the DC power output cable of the BC-U1 to the DC IN connector of the camcorder.
- 2 Connect the power cord supplied with the BC-U1 to the AC input connector of the BC-U1 then to an AC power source.
- 3 Set the mode switch of the BC-U1 to the DC OUT position.

For details, refer to the Operating Instructions of the BC-U1.

When recording or playback is in progress on power from the DC IN connector, the input voltage is displayed in the viewfinder.

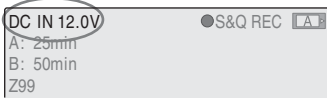

### Note

The battery pack mounted on the camcorder is not charged even if you set the mode switch of the BC-U1 to the CHARGE position. To charge the battery pack, remove it from the camcorder and mount it on the BC-U1.

## Turning Power On

This camcorder has Camera mode for recording and Media mode for playback. The mode is selected when you turn the power on.

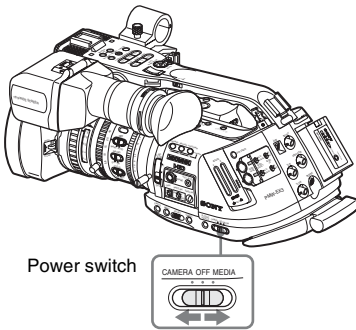

To operate in Camera mode, turn the power on by setting the power switch to the CAMERA position.

To operate in Media mode, turn the power on by setting the power switch to the MEDIA position.

## Turning Power Off

Set the power switch to the OFF position.

### Notes

- This camcorder uses a little standby power even when the power switch is set to OFF. Remove the battery pack if the camcorder will not be used for a prolonged period.
- When removing the battery pack or the DC IN power, be sure to set the switch to OFF in advance.  
Removing the battery pack and the DC IN

power without first setting the power switch to OFF may cause damage to the camcorder or SxS memory cards.

## Setting the Clock

When you turn the camcorder on for the first time after purchasing or replacing the backup battery (page 144), the Initial Setting display appears in the viewfinder.

Set the date and time of the built-in clock, using this display.

```
INITIAL SETTING
Time Zone: UTC +09:00 TOKYO
Date/Time: 2008/01/01 00:00:00 SET
Finish
```

### Time Zone

The value shows the time difference from UTC (Coordinated Universal Time).

Change the setting if needed.

### Setting the time and date

Use the joystick on the handle or the jog dial on the side operation panel for setting.

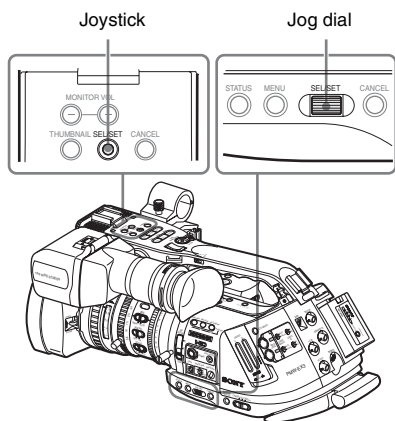

- 1 Tilt the joystick or turn the jog dial to set the cursor to “Date/Time” then press the joystick or dial.**

The cursor moves to the year-setting column.

```
INITIAL SETTING
Time Zone: UTC +09:00 TOKYO
Date/Time: 2008/01/01 00:00:00 SET
Finish
```

- 2 Tilt the joystick or turn the jog dial to set the year then press the joystick or dial.**

The cursor moves to the month-setting column.

- 3 Set the month, day, hour, minute, and second in sequence in the same manner.**

When you press the joystick or the jog dial at “SET,” the cursor moves back to “Date/Time.”

- 4 Move the cursor to “Finish” then press the joystick or dial.**

The Initial Setting display disappears, and the clock setting is completed.

The camcorder enters the operation mode (Camera mode or Media mode) you selected with the power switch.

Once after the Initial Setting display disappears, the time zone and date/time settings can be changed using “Time Zone” (page 124) and “Clock Set” (page 124) of the OTHERS menu.

### Notes

- If the clock setting is cleared because of exhaustion of the backup battery while no operation power was being supplied (no battery pack and no DC IN connection), the Initial Setting display will be displayed when you turn the camcorder on at the next opportunity.
- While the Initial Setting display is shown, no other operation except turning the power off is permitted until you finish the setting for this display.

## Adjusting the Viewfinder

You can adjust the angle and the display conditions of the viewfinder for best viewing in various shooting situations.

These adjustments of the viewfinder have no effect on pictures being recorded.

### Caution

Do not leave the camcorder with the eyepiece of the viewfinder facing the sun. Direct sunlight can enter through the eyepiece, be focused in the viewfinder, and cause fire.

### Adjusting the focus in the viewfinder

The eyepiece focusing (diopter compensation) ring enables adjustment to match the eyesight of operator so that the operator can view the image clearly in the eyepiece.

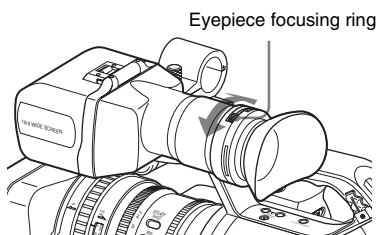

You can also attach a commercially available 52-mm aperture diopter compensation lens.

### Adjusting the contrast and brightness

Use the control knobs on the back panel of the viewfinder.

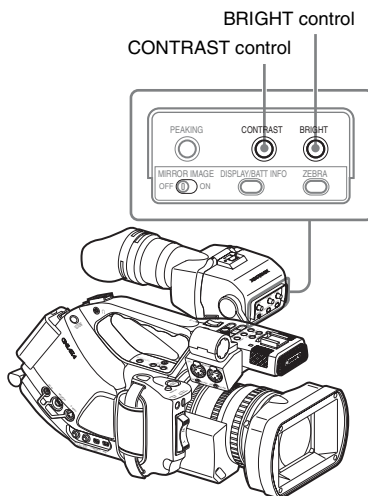

**CONTRAST:** For adjusting the brightness  
**BRIGHT:** For adjusting the brightness  
 When you view the knob from the front, clockwise rotation increases the level and counterclockwise rotation decreases it.

### Adjusting the color

These adjustments can be made using the VF SET menu.

Press the MENU button to set the camcorder to Menu mode. Select  (VF SET menu) then “VF” from the menu, and adjust “Color.”

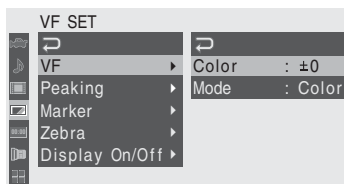

For details on menu operations, see “Basic Menu Operations” on page 111.

### Switching between color and monochrome modes

For the viewfinder display, color or monochrome display can be selected.

Select “VF” from the VF SET menu then select “Mode.”

Select “B&W” if checking the subject and focusing are easier on the monochrome display. If you assign “VF Mode” to one of the assignable buttons (see page 72), you can switch between color and monochrome by pressing the button.

## Adjusting the position (distance from your eye)

Loosening the fixing lever below the handle (rotating it toward the viewfinder) permits you to horizontally pull out the support bar and move the viewfinder forward or rearward with the support bar as the axis.

### 1 Adjust the horizontal position.

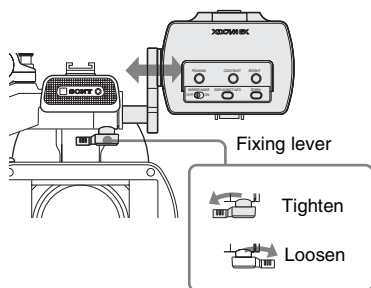

### 2 Move the viewfinder forward or rearward for the best position.

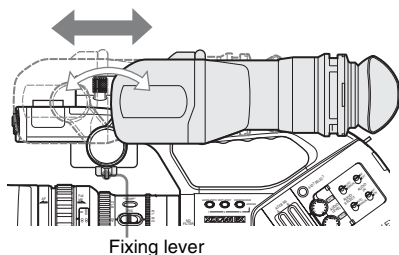

Tighten the fixing lever after the adjustments.

#### Note

When you move the viewfinder forward or rearward, the angle of the viewfinder varies simultaneously.

Adjust the angle for your best position after tightening the fixing lever.

## Adjusting the angle

You can adjust the angle of the viewfinder.

#### Note

If the fixing lever below the handle is loose, the position may vary when you adjust the angle. Be sure to tighten the lever in advance.

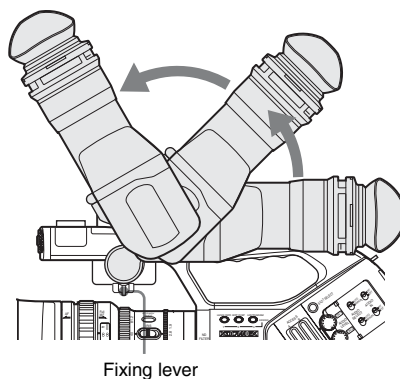

### To reverse the image

The viewfinder can be rotated as much as 180 degrees toward the direction facing the subject. To read the displayed menu and messages in this condition, set the MIRROR IMAGE switch to ON so that the textual information is converted to the readable direction.

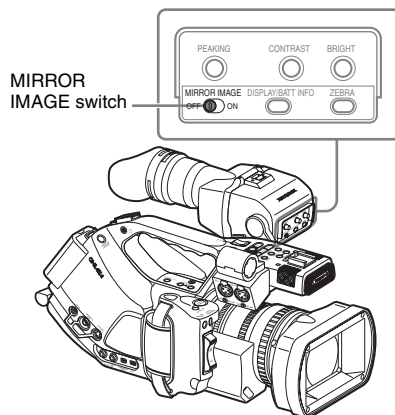

When the camcorder is in Media mode, the picture is also inverted both vertically and horizontally. In Camera mode, the picture is

inverted only vertically, while it is also inverted horizontally for Rec Review (page 71).

### Opening/detaching the eyepiece (to directly view the LCD screen)

You can directly view the LCD screen inside the viewfinder by opening the eyepiece.

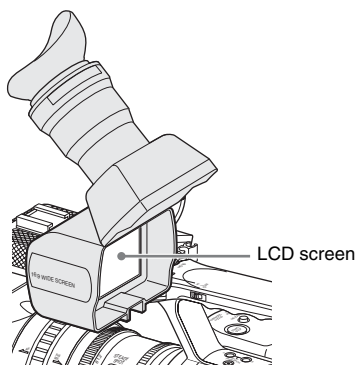

#### To open

Push the clip on the bottom to release and flip up the eyepiece.

It locks at the 120-degree position.

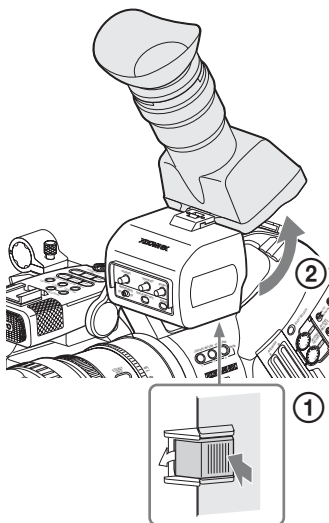

Normally use it in the locked position.

Although you can open it farther from the lock position, once return it to the closed position to lock it at the 120-degree position again.

#### To detach

The eyepiece can also be detached.

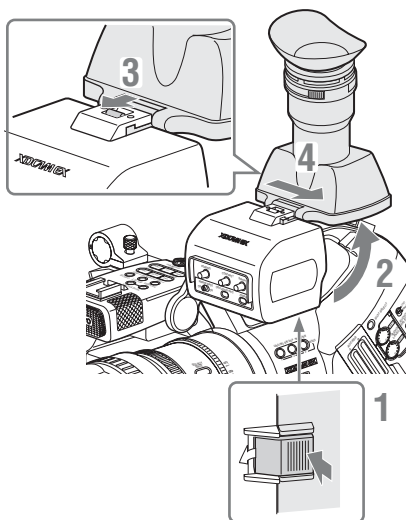

- 1 Push the clip on the bottom to release.
- 2 Flip up the eyepiece.
- 3 Slide the knob on the top to the opposite side of the eyepiece.
- 4 Detach the eyepiece by horizontally sliding it.



# Adjusting the Lens

The supplied VCL-614B2X and the optional XS8X4AS-XB8 (see page 34) specially designed for the PMW-EX3 are called “exclusive lenses” in this manual.

### Caution

Do not leave the camcorder with the lens facing the sun. Direct sunlight can enter through the lens, be focused in the camcorder, and cause fire.

## Adjusting the Flange Focal Length

It is necessary to adjust the flange focal length (the distance from the lens flange to the plane of the image along the optical axis) if the focus does not match properly from telephoto to wide angle during zoom operations. Repeated adjustment is not necessary as long as the same lens is used.

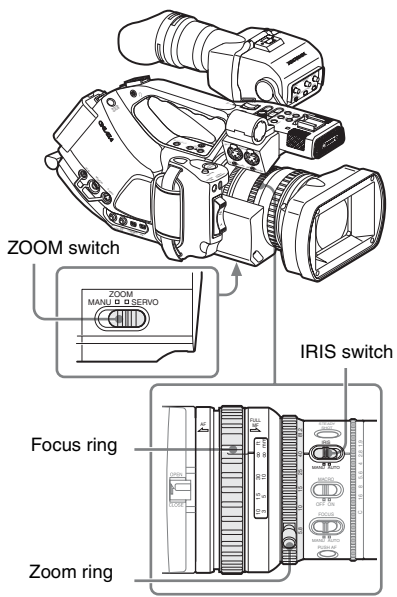



With the supplied or optional exclusive 1/2-inch EX Mount lens, the flange focal length can be adjusted automatically.

### Notes

- If a subject of insufficient contrast is used, or if the camcorder or subject moves during the adjustment, adjustment cannot be made properly. Once the adjustment begins, do not touch the camcorder body or lens until it ends.
- When the Shutter is in SLS mode, be sure to set the SLS setting to OFF before starting the adjustment.

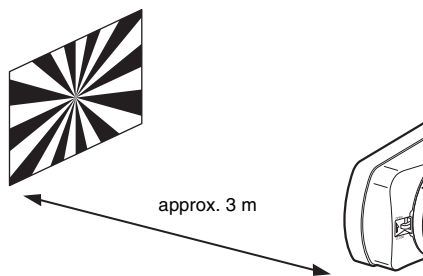
- 1 Start the camcorder in Camera mode by setting the power switch to CAMERA.
- 2 Set the IRIS switch to AUTO.
- 3 Place a high-contrast subject, such as a flange focal length adjustment chart, about 3 m (10 ft.) away from the camcorder, and light it well enough to provide a sufficient video output level.



- 4 Set the ZOOM switch to SERVO (Power Zoom mode).
- 5 Press the MENU button to set the camcorder to Menu mode, and select  (the LENS menu) then “Auto FB ADJ” from the menu.

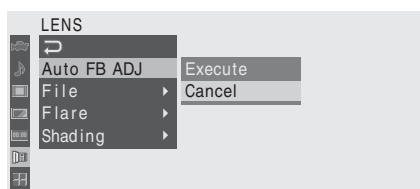

## 6 Move the cursor to “Execute” then press the joystick or the jog dial.

The adjustment begins.

### During adjustment

The in-progress message is displayed.

### When the adjustment finished

The completion message is displayed.

### If the adjustment fails

Check the conditions of the subject and lighting then perform the adjustment again.

For details on menu operations, see “Basic Menu Operations” on page 111.

When a lens other than the exclusive lenses is used, adjust the flange focal length manually.

## Replacing the Lens

In addition to the supplied VCL-614B2X standard zoom lens, a wide zoom lens exclusively for the PMW-EX3 is available as an option.

### Optional exclusive lens

Fujinon XS8X4AS-XB8: 1/2-inch EX Mount lens

Using the supplied lens adaptor, a Sony 1/2-inch Bayonet Mount lens can be mounted.

Note, however, that available functions, menu settings and performance may be restricted with non-exclusive lens.

For non-exclusive but usable lenses, consult your Sony service representative.

### Note

Turn off the camcorder before replacing the lens.

## Removing the supplied lens

To remove the supplied lens, proceed as follows:

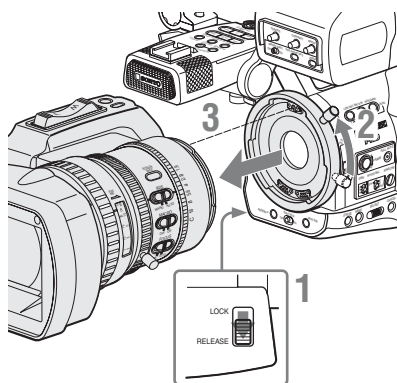

- 1 Set the lens mount stopper switch to the **RELEASE** position.
- 2 While holding the lens, turn the lens mount lever upward until it stops.
- 3 Pull the lens forward to remove.

### Notes

- When another lens is not immediately attached, attach the supplied lens mount cap and secure it by turning the lens mount lever downward.
- When a non-exclusive lens is mounted for the first time, it may take about 20 seconds to start up the camcorder.

## Attaching an exclusive lens

To attach the optional 1/2-inch EX Mount lens, proceed as follows:

The supplied lens once removed can also be mounted in the same manner.

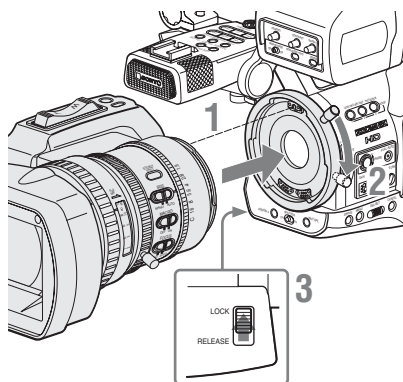

- 1 Align the alignment pin of the lens with the recess at the top of the mount section of the camcorder and set the lens in place.
- 2 Turn the lens mount lever downward.
- 3 Return the lens mount stopper switch to the LOCK position.

### Attaching a Sony 1/2-inch Bayonet Mount lens

Use the lens adaptor supplied with the camcorder.

- 1 Attach the lens adaptor to the camcorder.

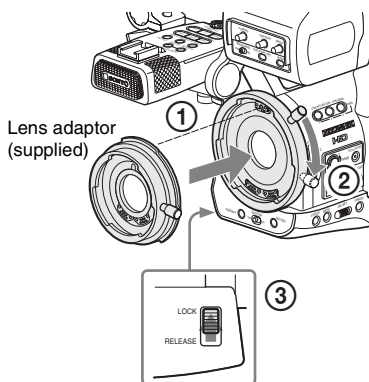

- 1 Align the alignment pin of the lens adaptor with the recess at the top of the

mount section and set the adaptor in place.

- 2 Turn the lens mount lever of the camcorder downward. (Keep the lens mount lever of the lens adaptor in the upper position.)
- 3 Return the lens stopper switch to the LOCK position.

### 2 Attach the lens.

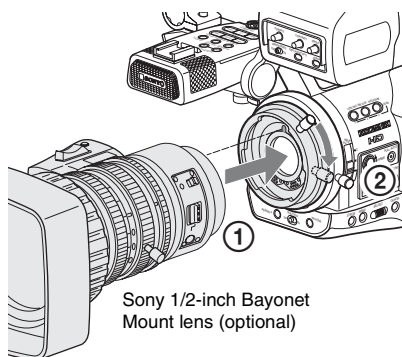

- 1 Align the alignment pin of the lens with the recess of the adaptor and set the lens in place.
- 2 Turn the lens mount lever of the adaptor downward.

To detach the lens, reverse the above procedure.

### Retrieving the Lens File

By your storing the data (such as compensation data) specific to the lenses in files, required adjustments and compensation can be performed merely by retrieving the appropriate file when changing lenses.

### When using an exclusive lens

The optimum compensation data for the two exclusive lenses are stored in the corresponding lens files at the factory to be automatically retrieved (with LENS menu "Auto Recall: On").

## When using a non-exclusive lens

You can use the lens file in which you stored the compensation data for the lens, using the LENS menu.

For the storage method, see “Lens File Operations” on page 143.









### When you mount a serial lens

The corresponding file is automatically retrieved.

### When you mount a non-serial lens

Retrieve the corresponding lens file, using the LENS menu.

- 1 Press the MENU button to set the camcorder to Menu mode and select  (the LENS menu).
- 2 Select “Recall” from “File” then the corresponding lens file from the list.

LENS		
		VCL-614B2X
	Auto FB ADJ	Lens ID : XS8X4AS-XB8
	File ▶	Recall ▶ User_File1
	Flare ▶	Store ▶ User_File2
	Shading ▶	File ID : User_File3
	No Offset	User_File4
	Auto Recall : On	

- 3 When the confirmation message is displayed, select “Execute.”

For details on menu operations, see “Basic Menu Operations” on page 111.

## Adjusting the Grip

The grip rotates approx. 120 degrees to support a variety of shooting styles.

Holding the RELEASE button pressed, slowly rotate the grip.

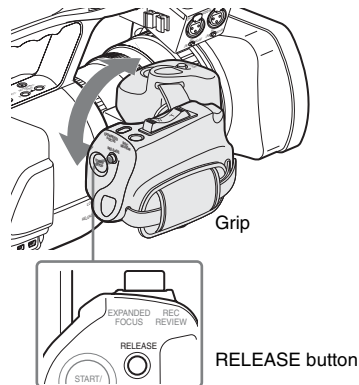

Click positions are provided at each 15 degrees. Release the RELEASE button at the desired click position to lock the grip.

# Using the Cheek Pad

When you operate the camcorder with it on your right shoulder, the cheek pad prevents the control parts on the side panel of the camcorder from directly hitting your face.

## Attaching the cheek pad

To attach the cheek pad, the shoulder pad and the cable clamp for optional accessories must be once detached.

### 1 Remove the shoulder pad.

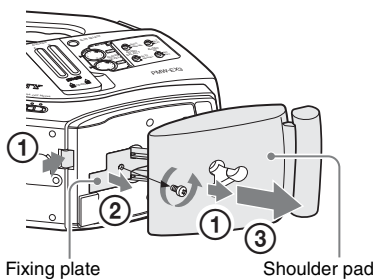

- ① While holding the knob depressed, pull the shoulder pad outward until it stops.
- ② Remove the fixing plate from the bottom of the camcorder after loosening the screw.
- ③ Pull the shoulder pad to remove.

### 2 Remove the cable clamp for optional accessories.

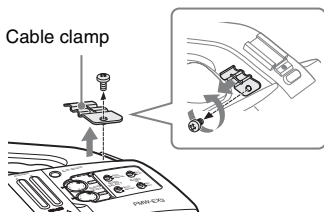

### 3 Insert the cheek pad from the back of the camcorder and secure it with the supplied screws.

Align the holes on the bottom of the mount frame of the cheek pad with those of the camcorder.

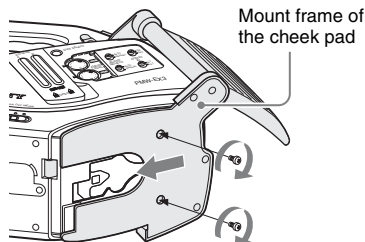

### 4 Return the shoulder pad to its original position.

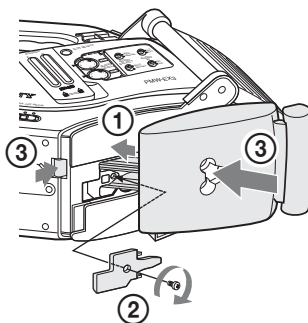

- ① Insert the axis of the shoulder pad in the hole of the camcorder.
- ② Secure the fixing plate to its original position with the screw.
- ③ While holding the knob, push in on the shoulder pad.

### 5 Attach the cable clamp you removed in step 2.

Align the hole of the cable clamp with those on the mount frame of the cheek pad (at the top of the pole) and the camcorder then secure them all together with the supplied screw.

(Keep the original screw removed in step 2 for future use.)

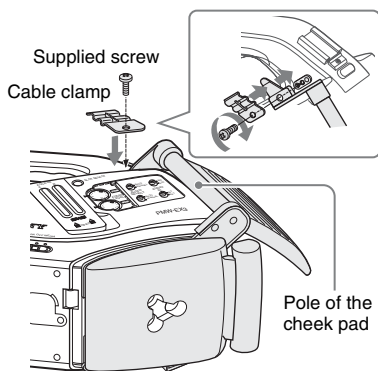

- 6** While holding the pole upward, flip the pad toward the side panel of the camcorder.

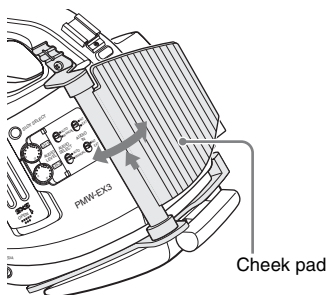

**To attach the DC cable clamp**

The supplied DC cable clamp can be attached to the frame of the cheek pad at one of the accessory screw holes on the opposite side of the pad. The DC power output cable (page 27) of the BC-U1 connected to the DC IN connector can be tied down with the clamp.

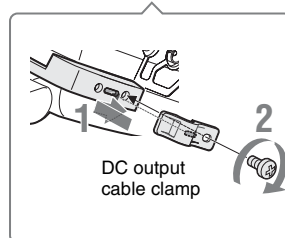
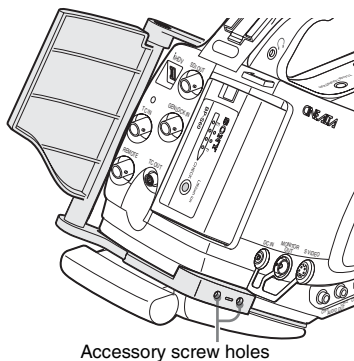

- 1** Insert the cable clamp to the frame so that the rear projection of the cable clamp fits in the slot on the frame. Adjust the position of the clamp by sliding it so that the screw hole of the clamp aligns with that of the frame.
- 2** Secure the clamp, using the supplied screw.

# Using the IR Remote Commander

## Before use

Before you use the supplied IR Remote Commander for the first time, pull out the insulation sheet from the battery holder.

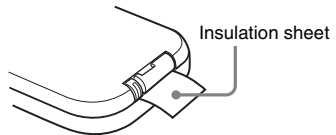

A CR2025 lithium battery is set in the holder at the factory.

## To use the IR Remote Commander

For controlling the camcorder from the IR Remote Commander, activate the remote control function of the camcorder after turning the power on.

Activating/deactivating the remote control function can be achieved using the Setup menu or an assignable button.

### To activate using the menu

Press the MENU button to set the camcorder to Menu mode, select  (the OTHERS menu) and set "IR Remote" to "On."

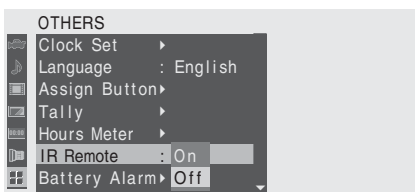

For details on menu operations, see "Basic Menu Operations" on page 111.

### To activate using an assignable button

Assigning "IR Remote" to one of the assignable buttons permits you to activate/deactivate the remote control function by pressing the button.

For the assignable buttons, see "Changing Functions of the Assignable Buttons" on page 72.

## Note

To avoid malfunctions, the remote control function is automatically deactivated when the camcorder is turned off. Activate the function each time when required after you turn the camcorder on.

### Battery lifetime

When the lithium battery's power falls, the IR Remote Commander may not work even if you press the buttons. The average lithium battery's service life is about one year, but this depends on the pattern of use.

If pressing the remote control buttons produces absolutely no effect on the camcorder, replace the battery then check the operation again.

## Replacing the battery in the IR Remote Commander

Use a commercially available CR2025 lithium battery. Do not use any battery other than a CR2025.

- 1 Hold down the lock lever ①, pull out the battery holder ②, and remove the battery.

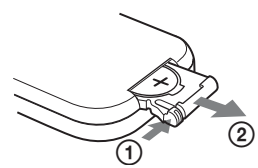

- 2 Place a new battery in the battery holder with the + symbol facing upward ①, then push the battery holder into the IR Remote Commander until it clicks ②.

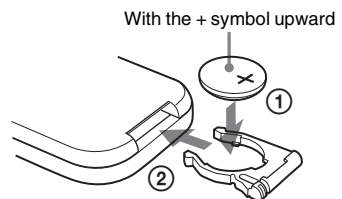

**WARNING**

Battery may explode if mistreated. Do not recharge, disassemble, or dispose of in fire.

**CAUTION**

Danger of explosion if battery is incorrectly replaced. Replace only with the same or equivalent type recommended by the manufacturer. Dispose of used batteries according to the manufacturer's instructions.

## Handling SxS Memory Cards

This camcorder records audio and video on SxS memory cards (optional) inserted in the card slots.

### About SxS Memory Cards

#### Usable SxS memory cards

Use the following Sony-made SxS memory cards (SxS PRO) with this camcorder:

- SBP-8 (8GB)
- SBP-16 (16GB)

Operations are not guaranteed with memory cards other than SxS PRO.

These cards comply with the ExpressCard standard.

- SxS and SxS PRO are trademarks of Sony Corporation.
- The ExpressCard word mark and logo are owned by Personal Computer Memory Card International Association (PCMCIA) and are licensed to Sony Corporation. All other trademarks are the property of their respective owners.

#### Notes on using SxS memory cards

- Recorded data may be damaged or lost in the following situations:
  - If you remove this media or turn off the power while formatting, reading or writing data.
  - If you use this media in locations subject to static electricity or electrical noise.
- Do not use or store this media in the following locations:
  - Where recommended operating conditions are exceeded.
  - Inside a closed car in summer; or in strong sunshine / under direct sunlight / near a heater, etc.
  - Humid or corrosive location
- Verify the correct direction of insertion before use.
- When storing or carrying this media, put this media in the carrying case and lock it firmly.



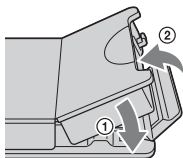

- We recommend that you make a backup copy of important data. Sony accepts no responsibility for any damage or loss of data you recorded.
- Do not apply a label sheet in places other than the label space. When applying the label sheet to this media, do not allow it to protrude from its proper location.

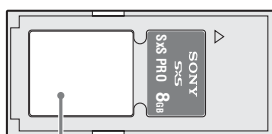

Label space

- SxS memory cards to be used with this camcorder must be formatted using the format function of this camcorder. If a card is formatted using other device, it is regarded as of a different format, requiring repeated format operation on this camcorder. (Formatting or deleting with the function of the camcorder does not completely delete data on this media. When transferring or disposing of this media, use a commercial data deleting software or destroy the actual body at you own responsibility.)
- If the available recording time on a card is short, clip operation may be restricted. In such a case, delete unnecessary files by using a PC.
- Remove or reinsert the case card with the case opened properly.



### For write protection

Setting the write-protect switch of the SxS memory card to “WP” disables you to record, edit or delete data.

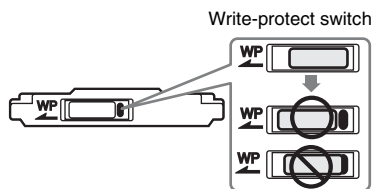

### Note

Do not operate the write-protect switch of an SxS memory card while it is set in the camcorder. Temporarily remove the card from the camcorder before changing the switch setting.

## Inserting/Removing an SxS Memory Card

The card slots are located behind a cover.

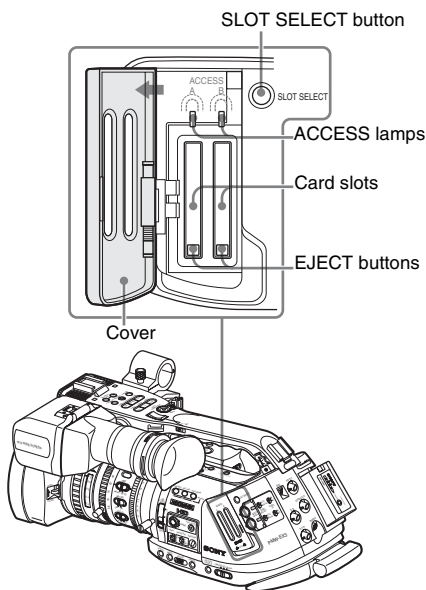

### Inserting an SxS memory card

- 1 Pull up the cover to release the lock then open.

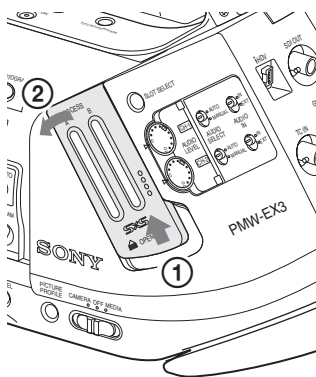

**2** Insert the SxS memory card into the slot.

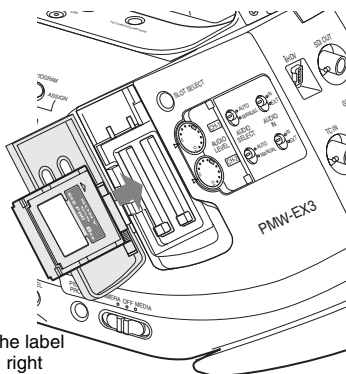

With the label facing right

The ACCESS lamp lights in red then changes to green once the memory card is ready for use.

**3** Close the cover.

**Status indications by the ACCESS lamps**

Card slots A and B are accompanied by the respective ACCESS lamps to indicate their statuses.

Lamp	Slot statuses
Lights in red	Accessing the loaded SxS memory card (writing/reading data)
Lights in green	Standby (ready for recording or playback using the loaded SxS memory card)

Lamp	Slot statuses
Off	<ul style="list-style-type: none"> <li>No SxS memory card is loaded.</li> <li>The loaded card is invalid.</li> <li>An SxS memory card is loaded, but another slot is active.</li> </ul>

**Removing an SxS memory card**

**1** Open the cover, once press the EJECT button to release the lock, then pull the button out.

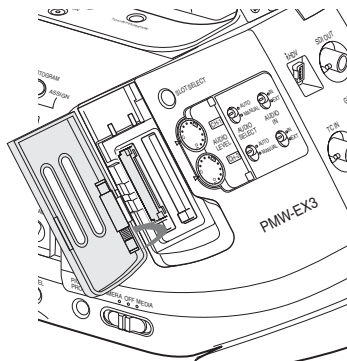

Press and unlock the button.

**2** Press the EJECT button again to remove the card.

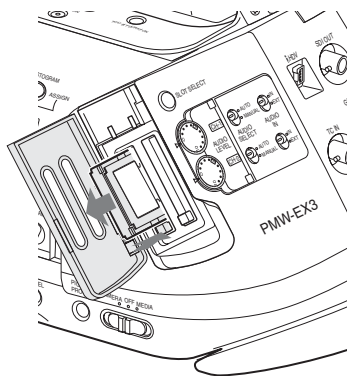

**Notes**

- Data are not guaranteed if the power is turned off or a memory card is removed while the card is being accessed. All data on the card may be

destroyed. Be sure that the ACCESS lamps are lit in green or off when you turn off the power or remove memory cards.

- When you turn the camcorder on by setting the power switch to MEDIA (Media mode), a display to show that an SxS memory card is being confirmed appears in the viewfinder.



The display automatically changes to the thumbnail screen (*page 93*) when a valid memory card is inside, but it remains on the screen if no valid memory card is loaded.

## Switching Between SxS Memory Cards

When SxS memory cards are loaded in both card slots A and B, press the SLOT SELECT button to select the card you wish to use.

If a card becomes full during recording, switching to the other card is automatically executed.

### Note

The SLOT SELECT button is disabled while playback is in progress. Switching is not executed even if you press the button. The button is enabled on the thumbnail screen (*page 93*).

## Formatting an SxS Memory Card

Formatting may be required before using an SxS memory card with this camcorder. For an SxS memory card that is not formatted or that was formatted with another system, a message to confirm if formatting is to be executed is displayed in the viewfinder.

### Note on formatting

Any SxS memory card formatted with a device other than this camcorder cannot be used with the camcorder.

## To execute formatting

**If the message for formatting is displayed, turn the jog dial or tilt the joystick to select “Execute” then press the dial or joystick.**

Formatting begins.

The in-progress message and status bar (%) are displayed, and the ACCESS lamp lights in red. When formatting is completed, the completion message is displayed for three seconds.

### Recording/playback during formatting

You can perform recording or playback using the SxS memory card in the other card slot while formatting is in progress.

### If formatting fails

A write-protected SxS memory card or memory card that cannot be used with this camcorder will not be formatted.

As a warning message is displayed, replace the card with an appropriate SxS memory card, as per the instructions in the message.

## To format by menu operation

When no formatting message is displayed in the viewfinder, you can execute formatting using “Format Media” (*page 127*) of the OTHERS menu in the same manner.

### Notes

- All the data, including recorded pictures and setup files, are erased when a memory card is formatted.
- SxS memory cards to be used with this camcorder must be formatted using the format function of this camcorder. Any card formatted with other device must be formatted again with this camcorder.

## Checking the Remaining Time Available for Recording

In Camera mode, you can check the time remaining for the SxS memory cards loaded in the card slots in the viewfinder.



The available time for recording with the current video format (recording bit rate) is calculated according to the remaining space of each card and displayed in time units of minutes.

The remaining can also be checked in a meter format on the BATTERY/MEDIA status screen (*page 108*).

**Note**

A  icon appears if the memory card is write-protected.

---

## Replacing an SxS memory card

---

- If the available time on two cards in total becomes less than 5 minutes, a message “Media Near Full,” flashing of the tally lamps, and a beep sound will warn you. Replace the cards with those with sufficient space.
- If you continue recording until the total remaining time reaches zero, the message changes to “Media Full,” and recording stops.

**Note**

Approximately 600 clips can be recorded on one SxS memory card at maximum.

If the number of recorded clips reaches the limit, the remaining time indication becomes “0,” and the message “Media Full” is displayed.

---

## Restoring an SxS Memory Card

---

If an error occurs with data in a memory card for some reason, the card must be restored.

If an SxS memory card that needs to be restored is loaded, a message that prompts you to execute a restore operation is displayed in the viewfinder.

---

### To restore a card

---

**Select “Execute” by turning the jog dial or tilting the joystick then push the dial or joystick.**

The restore operation begins.

During restoration, an in-progress message and status bar (%) are displayed, and the ACCESS lamp is lit in red.

When restoration is completed, a completion message is displayed for three seconds.

**If restoration fails**

- A write-protected SxS memory card or one on which an error occurred cannot be restored. For such a card, a warning message is displayed. Release the write protection or replace the card, as per the instructions in the message.
- An SxS memory card on which an error occurred may become usable again through repeated formatting.

- In some cases, only parts of clips cannot be restored. Playback of the restored clips becomes possible again.
- The following operation may restore an SxS memory card for which the message “Could not Restore Some Clips” is repeatedly displayed each time you try the restoration process:

- 1 Copy necessary clips to another SxS memory card, using the copy function (*page 101*) of the camcorder or the XDCAM EX Clip Browsing Software (*page 131*).
- 2 Format the problem SxS memory card, using the format function of this camcorder.
- 3 Return the necessary clips to the SxS memory card by copy operation.

**Recording/playback during restoration**

You can perform recording or playback using the SxS memory card in the other card slot while restoration is in progress.

---

### To update the managerial file

---

If clips cannot be played back, updating the managerial file on the card may improve the situation.

For this operation, use “Update Media” of “Clip” (*page 127*) of the OTHERS menu.

## Using the PHU-60K

You can use an optional PHU-60K Professional Hard Disk Unit with this camcorder. The PHU-60K incorporates a 60GB 1.8-inch hard disk, on which up to 200 minutes of HD video can be recorded in HQ mode.

### Note

High-speed playback (page 95) may not be properly achieved with the PHU-60K.

## Connecting/Removing the PHU Connection Cable

Recording/playback can be made using the PHU-60K in the same manner as with SxS memory cards by mounting the PHU-60K on the accessory shoe of the camcorder and connecting the PHU connection cable to an SxS memory card slot.

For the mounting method, refer to the instructions supplied with the PHU-60K.

### Connecting the PHU connection cable

- 1 Set the power switch of the camcorder to the **CAMERA** position.
- 2 Open the cover of the card slot and plug the PHU connection cable into the slot.

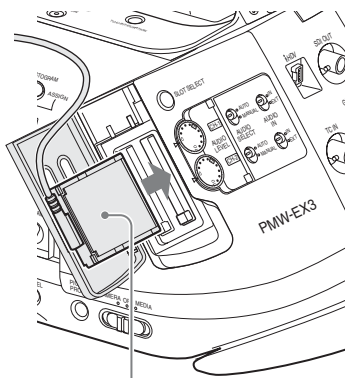

Insert so that the cable extends upward.

- 3 Pass the cable through the cable guide slot above the card slot B and close the cover.

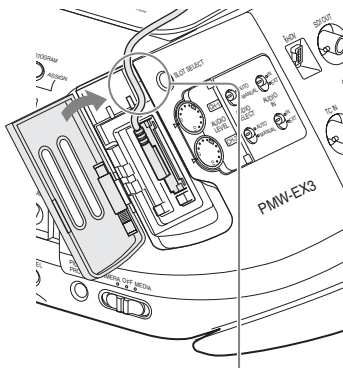

Pass through the cable guide slot.

- 4 Secure the cable at the cable clamp.

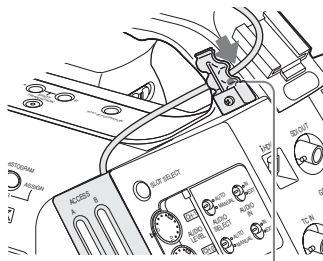

Cable clamp

- 5 Turn on the PHU-60K.

The POWER indicator of the PHU-60K lights in green.

Subsequently, the ACCESS lamp of the camcorder lights in red then changes to green once the unit is ready for use.

### Disconnecting the PHU connection cable

Operate in the same manner as when you remove an SxS memory card from the slot.

## Formatting the PHU-60K

For a PHU-60K that is not formatted or that was formatted with another system, a message to confirm if formatting is to be executed is displayed in the viewfinder.

Any PHU-60K formatted with a device other than this camcorder cannot be used with the camcorder.

## To execute formatting

**If the message for formatting is displayed, turn the jog dial or tilt the joystick to select “Execute” then press the dial or joystick.**

Formatting begins.

An in-progress message and status bar (%) are displayed, and the ACCESS lamp lights in red. When formatting is completed, a completion message is displayed for three seconds.

## To format by menu operation

When no formatting message is displayed in the viewfinder, you can execute formatting using “Format Media” (page 127) of the OTHERS menu in the same manner.

### Notes

- Formatting for the PHU-60K on this camcorder is “Quick Format” with which only the managerial data are erased. To erase the recording data completely, connect the unit to a PC and perform “Full Format.”
- The PHU-60K to be used with this camcorder must be formatted using the format function of this camcorder. Any PHU-60K formatted with another device must be formatted again with this camcorder.

## Checking the Remaining Time Available for Recording

In Camera mode, the remaining capacity (in minutes) of the PHU-60K connected via a card slot is displayed in the viewfinder.

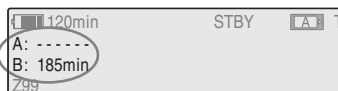

The available time for recording with the current video format (recording bit rate) is calculated according to the remaining space of the hard disk and displayed in time units of minutes.

The remaining capacity can also be checked in a meter format on the BATTERY/MEDIA status screen (page 108).

## Restoring the PHU-60K

If an error occurs with data on the PHU-60K for some reason, the hard disk must be restored.

If a PHU-60K that needs to be restored is connected, a message that prompts you to execute restoration is displayed in the viewfinder.

## To restore the hard disk

**Select “Execute” by turning the jog dial or tilting the joystick then push the dial or joystick.**

The restoration begins.

During restoration, an in-progress message and status bar (%) are displayed, and the ACCESS lamp is lit in red.

When restoration is completed, a completion message is displayed for three seconds.

### If restoration fails

- A PHU-60K on which an error occurred may become usable again through repeated formatting.
- In some cases, only parts of clips cannot be restored. Playback of the restored clips becomes possible again.

# Basic Operation Procedure

The operations described in this section assume that you are using the supplied or optional exclusive lens. The displays and menu settings may differ when a non-exclusive lens is used.

Basic recording with the exclusive lens can be performed with the following procedures:

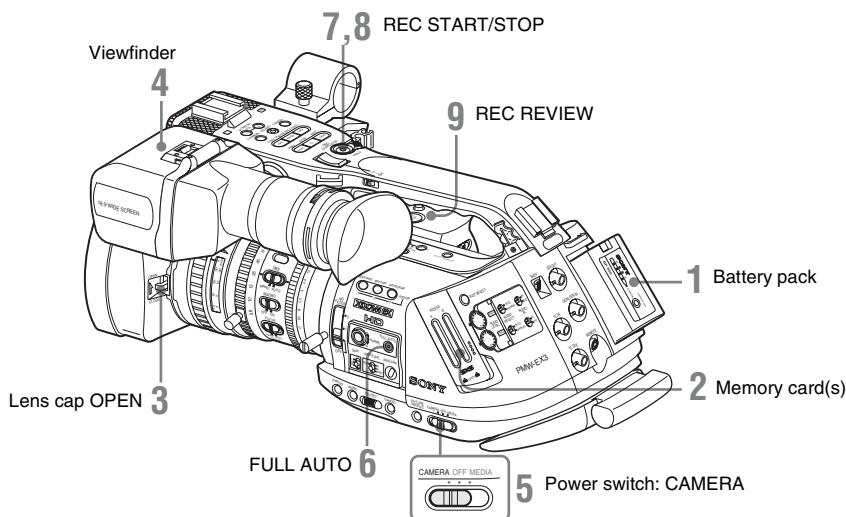

## Preparations

- 1 Mount a fully charged battery pack.**
- 2 Load SxS memory card(s).**  
If you load two cards, recording is continued by automatically switching to the second card when the first card becomes full.
- 3 Pull up on the lens cap open/close lever to open the lens cap built in the lens hood.**
- 4 Adjust the viewfinder for best viewing.**
- 5 Set the power switch to the CAMERA position.**  
The camcorder is turned on and enters Camera mode.

When using the remote commander, activate the remote control mode ([page 39](#)).

### Note

When you hold the camcorder by the grip, support it from underneath with your left hand.

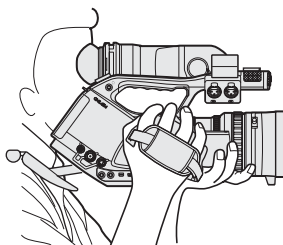

---

## Recording (Full Auto mode)

---

### 6 Press the FULL AUTO button so that the button indicator lights.

Full Auto mode is turned on, activating the TLCS (Total Level Control System) (*page 117*).

Thus Auto Iris, AGC (Auto Gain Control), Auto Shutter, ATW (Auto Tracing White) are set to ON, whereby the brightness and white balance will be automatically adjusted.

When you wish to adjust them manually, turn Full Auto mode off, and see;

“Adjusting the Iris” on *page 58*

“Setting the Gain” on *page 56*

“Setting the Electronic Shutter” on *page 56*

“Adjusting the White Balance” on *page 51*

#### Note

AF (Auto Focus) is not activated by setting the camcorder to Full Auto mode.

For information of automatic focus adjustment, see *page 63*.

### 7 Press the REC START/STOP button.

You can start with either of the REC START/STOP button on the handle or that on the grip of the lens.

(If you are using the IR Remote Commander, press the REC button simultaneously with the unmarked button.)

The front and rear tally lamps light and recording begins.

### 8 To stop recording, press the REC START/STOP button again.

(If you are using the IR Remote Commander, press the REC PAUSE button simultaneously with the unmarked button.)

Recording stops and the camcorder enters STBY (recording standby) mode.

#### Note

Recording cannot be restarted after you stop recording until the ACCESS lamp lights in green.

#### To prevent a switching error

The REC START/STOP button on the handle is incorporated with the REC HOLD lever. If the REC START/STOP button on the handle will not

be used, it is recommended to set the lever to the HOLD position to lock the button.



To unlock the button, return the lever to its original position.

---

## Checking the last recorded clip (Rec Review)

---

### 9 Press the REC REVIEW button.

The Rec Review function (*page 71*) is activated, and the last recorded clip is played back for the specified time in the viewfinder. When playback reaches the end of the clip, the camcorder returns to STBY (recording standby) mode.

#### To delete clips

You can delete the last recorded clip by using the Last Clip DEL function.

See “Deleting the Last Recorded Clip” on *page 91*.

Use the All Clips DEL function when you wish to delete all recorded clips from a memory card.

See “Deleting All Clips” on *page 91*.

To specify a clip to be deleted, operate the camcorder in Media mode.

See “Deleting a Clip” on *page 101*.



**Clip (recording data) and clip name**

When you stop recording, video, audio and subsidiary data from the start to end of the recording are recorded as a single clip on an SxS memory card.

For each clip recorded with this camcorder, a clip name of 8 characters (the first four alphanumeric and the second four numerics) is automatically generated.

**Example:** ABCD0001

The first four alphanumeric can be specified as desired using “Clip” (page 127) of the OTHERS menu before you start recording. (It cannot be changed after recording.)

The second four-digit number is automatically counted up in sequence.

**Notes on Clips**

The XDCAM EX-series products employ the FAT32 File System.

Thus, recorded materials may be segmented in multiple files depending on the file size. But the camcorder can play such materials seamlessly.

A long clip can be recorded crossing over two memory cards in slot A and B.

When you copy clips to a hard disk drive, etc. using a computer, it is recommended to use the XDCAM EX Clip Browsing Software on the supplied CD-ROM.

**Note**

If copying is done using Explorer (Windows) or Finder (MAC), the continuity and relationships of recorded materials may not be maintained.

## Selecting the Video Format

You can select various video formats for recording/playback using “Video Format” (page 127) of the OTHERS menu.

The current format is displayed on the screen when you press the DISPLAY/BATT INFO button.



### Selectable Formats

The selectable formats depend on whether “Country” (page 127) of the OTHERS menu is set to “NTSC Area” or “PAL Area.”

The video formats set on this camcorder cover the recording bit rate (HQ/SP), recording picture size (effective resolution), recording frame rate, and recording scan system (i/P).

The frame rates are indicated with two-digit integers, rounding off the fractional part.

When you select an HQ format, recording is made with the bit rate of 35 Mbps VBR.

When you select an SP format, recording is made with the HDV-compatible bit rate of 25 Mbps CBR.

**With “NTSC Area” selected**

Format	Indication on this camcorder
HQ 1920 × 1080 59.94 interlace	HQ 1080/60i
SP 1440 × 1080 59.94 interlace	SP 1080/60i
HQ 1920 × 1080 29.97 Progressive	HQ 1080/30P
HQ 1920 × 1080 23.98 Progressive	HQ 1080/24P
SP 1440 × 1080 23.98 Progressive	SP 1080/24P
HQ 1280 × 720 59.94 Progressive	HQ 720/60P







Format	Indication on this camcorder
HQ 1280 × 720 29.97 Progressive	HQ 720/30P
HQ 1280 × 720 23.98 Progressive	HQ 720/24P

### With “PAL Area” selected

Format	Indication on this camcorder
HQ 1920 × 1080 50 interlace	HQ 1080/50i
SP 1440 × 1080 50 interlace	SP 1080/50i
HQ 1920 × 1080 25 Progressive	HQ 1080/25P
HQ 1280 × 720 50 Progressive	HQ 720/50P
HQ 1280 × 720 25 Progressive	HQ 720/25P

## Changing the Format

Press the MENU button to set the camcorder to Menu mode, display the OTHERS menu with , and set “Video Format.”

OTHERS		
 GenLock	▶	HQ 1080/60i
 Direct Menu	:	SP 1080/60i
 i.LINK I/O	:	HQ 1080/30P
 Trigger Mode	:	HQ 1080/24P
 Country	:	SP 1080/24P
 Video Format	:	HQ 720/60P
 Clip	▶	HQ 720/30P

For details on menu operations, see “Basic Menu Operations” on page 111.

Signals from the COMPONENT OUT, SDI OUT, MONITOR OUT, and S VIDEO connectors are also output according to the format selected with this menu.

See “Formats and Limitations of Outputs” on page 141.

### Note on recording format in SP 1080/24P mode

When recording in SP 1440 × 1080 mode at 23.98 in Progressive mode (indicated as SP 1080/24P on this camcorder), pictures are recorded at 59.94 in Interlace mode (indicated as SP 1080/60i) by pull-down processing.

## Switching the ND Filters

ND filters are available for keeping the aperture in a proper range.

Set the ND filter switch according to the brightness of the subject.

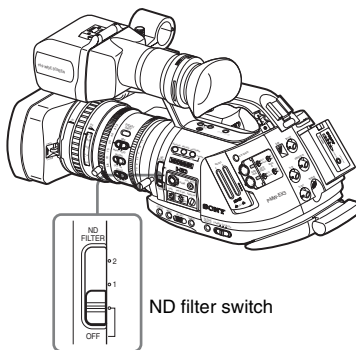

ND filter switch

- 2: 1/64ND
- 1: 1/8ND
- OFF: Clear

The ND filter number is displayed on the screen when you press the DISPLAY/BATT INFO button.

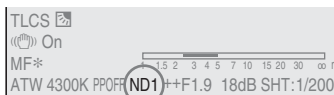

### Note

No indication is obtained if the ND filter switch is set to OFF.

# Adjusting the White Balance

The white balance must be adjusted to suit to the color temperature of the light source. You can select the adjustment mode according to the shooting conditions.

## Preset mode

The color temperature is adjusted to the preset value (factory setting: 3200K) in this mode. Select this mode when there is no time to adjust the white balance or when you wish to fix the white balance to the condition of you set for a Picture Profile.

## Memory A mode, Memory B mode

- The white balance is adjusted to the value stored in memory A or memory B.
- Pressing the WHT BAL button executes auto white balance and stores the adjusted value in memory A or memory B.

## ATW (Auto-Tracing White balance) mode

In this mode, the camcorder automatically adjusts the white balance to the appropriate condition. When the color temperature of the light source changes, the white balance adjustment is automatically executed.

Five steps of adjustment speed can be selected with “ATW Speed” (page 117) of the CAMERA SET menu.

## Selecting the Adjustment Mode

### Using the switch

You can select Preset mode, Memory A mode, or ATW (Memory B) mode with the WHITE BAL switch.

To the B position of the WHITE BAL switch, ATW mode is assigned at the factory. The setting can be changed with “White Switch” (page 117) of the CAMERA SET menu to select Memory B mode.

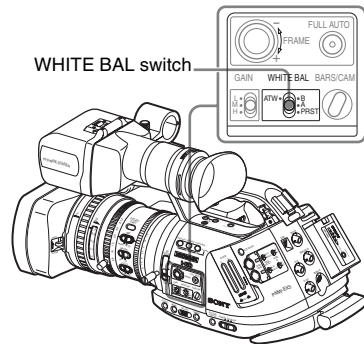

**B:** ATW or Memory B mode

**A:** Memory A mode

**PRST:** Preset mode

- Setting the camcorder to Full Auto mode (page 48) forcibly activates ATW mode.
- Assigning the ATW on/off function to an assignable button permits you to independently activate/deactivate ATW when Full Auto mode is off.

For details on the assignable buttons, see “Changing Functions of the Assignable Buttons” on page 72.

## Using the Direct menu

When you press the DISPLAY/BATT INFO button, the current adjustment mode and color temperature are displayed on the screen.



**ATW:** ATW mode

**W:A:** Memory A mode

**W:B:** Memory B mode

**W:P:** Preset mode

When the Direct menu is in All mode, you can select from among ATW, W:A, W:B, and W:P. When the Direct menu is in Part mode, you can switch between ATW and the mode set with the WHITE BAL switch.

For details on the Direct menu, see “Direct Menu Operation” on page 24.

## Executing Auto White Balance

Execute auto white-balance adjustment according to the color temperature of the light source. The adjustment value can be stored in memory A or B.

### Note

Auto white-balance adjustment cannot be executed in Preset mode.

**1 To store the adjustment value in memory, select Memory A or Memory B mode.**

**2 Select the appropriate ND filter according to the lighting condition.**

**3 Place a white subject under the same lighting condition and zoom in on it so that a white area is obtained on the screen.**

A white object (white cloth, a white wall, etc.) near the subject may be used in place. Be careful not to have any spots of high illumination on the screen.

**4 Adjust the lens iris opening.**

Set it to the proper condition if the manual iris adjustment mode is selected.

**5 Press the WHT BAL button.**

Auto white-balance adjustment begins.

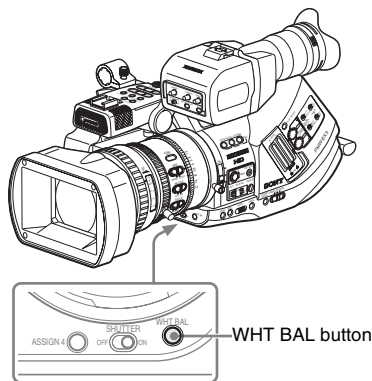

During adjustment, an in-progress message is displayed on the screen. When the adjustment is completed successfully, the message changes to a

completion message, and the obtained color temperature is displayed.

- When you execute the adjustment in a memory mode, the adjusted value is stored in memory (A or B) selected in step 1.
- When you execute the adjustment in ATW mode, adjustment in ATW is resumed.

### If auto white-balance adjustment fails

An error message is displayed on the screen for approximately three seconds.

If the error message is displayed, try auto white-balance adjustment again.

If the error message continues to be displayed after several attempts, consult your Sony service representative.

## Adjusting the Black Balance

With this camcorder, the black balance is automatically adjusted each time the power is turned on. You can readjust it, using the menu, when needed.

Use the CAMERA SET menu for the adjustment. Press the MENU button to set the camcorder to Menu mode, display the CAMERA SET menu with , and select “Auto BLK Balance” from the menu.

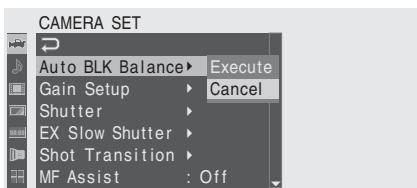

For details on menu operations, see “Basic Menu Operations” on page 111.

Select “Execute” to start the black balance adjustment.

During adjustment, an in-progress message is displayed. When the adjustment is completed successfully, the message changes to a completion message.

## Displaying the Markers and Zebra Patterns

During recording, various markers and zebra patterns can be inserted into the image in the viewfinder.

This does not affect recording signals.

### Displaying the Markers

Use “Marker” of the VF SET menu. Press the MENU button to set the camcorder to Menu mode, display the VF SET menu with , and select “Marker” from the menu.



### Activating the marker indications

- Set “Setting” to “On” then turn the markers on/off independently.  
No marker is displayed when “Setting” is “Off.”
- Assigning the Marker on/off function to one of the assignable buttons permits you to operate “Setting: On/Off” by pressing the button.

For the assignable buttons, see “Changing Functions of the Assignable Buttons” on page 72.

### Displaying the safety-zone marker

Set “Safety Zone” to “On” to insert the safety-zone marker to the screen.

With “Safety Area” you can select the size of the safety-zone marker from among 80%, 90%, 92.5%, and 95% of the picture area.

Example: 95%

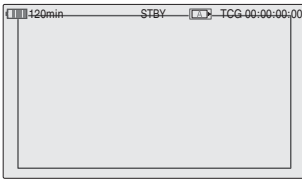

When the aspect marker is on, the safety zone marker shows the effective area within the aspect marker.

## Displaying the center marker

Set “Center Marker” to “On” to insert the center marker into the screen area.

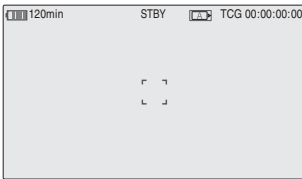

## Displaying the aspect marker

Set “Aspect Marker” to “On” to insert the aspect marker into the screen area.

Select the width of the marker from among 4:3, 13:9, 14:9, and 15:9 with “Aspect Select.”

Example: 4:3

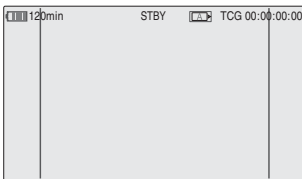

## Displaying the guide frame lines

Set “Guide Frame” to “On” to insert the guide frame lines into the screen area.

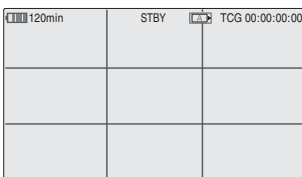

## Displaying the Zebra Patterns

A zebra pattern(s) can be inserted to the picture in the viewfinder to check the appropriate luminance level.

Factory-set zebras

1 (70%)



2 (100%)



## Turning the zebra-pattern indication on/off

Pressing the ZEBRA button turns the zebra pattern-indication on/off.

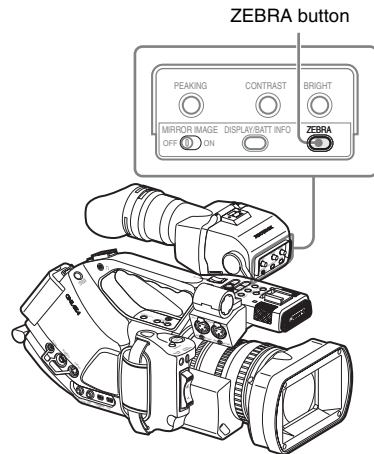

## Changing the zebra pattern

Using “Zebra” of the VF SET menu, you can change the zebra pattern to be displayed. Press the MENU button to set the camcorder to Menu mode, display the VF SET menu with , and select “Zebra” from the menu.

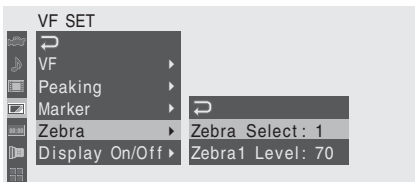

### Zebra Select

Select the zebra pattern(s) to be displayed.

**1 (Zebra1):** To display a zebra pattern in the area of  $\pm 10\%$  centering the video level set with “Zebra1 Level”

**2 (Zebra2):** To display a zebra pattern for the video level over 100%

**Both:** To display both Zebra1 and Zebra2

### Zebra1 Level

Set the center level of Zebra1 in the range of 50 to 107%. The default setting is 70%.

## Setting the Gain

You can set the gain of the video amplifier according to the brightness of the subject. Select the setting mode required by the shooting conditions.

### Fixed gain mode (manual gain adjustment)

Select the gain of the video amplifier, using the switch or a menu operation.

### AGC mode (automatic gain control)

The gain of the video amplifier is automatically adjusted according to the picture brightness.

## Recording With Fixed Gain

### Selecting the gain with the switch

Select the gain, using the GAIN switch.

#### Note

When AGC mode is on, the fixed gain cannot be selected.

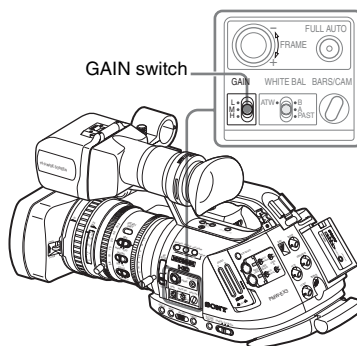

The gain value at each of the switch positions are set at the factory are as follows:

**L:** 0 dB

**M:** 9 dB

**H:** 18 dB

These values can be changed in the range of  $-3$  dB to  $+18$  dB, using the CAMERA SET menu.

## To change

Press the MENU button to set the camcorder to Menu mode, display the CAMERA SET menu with , and select “Gain Setup” from the menu.



For details on menu operations, see “Basic Menu Operations” on page 111.

## Selecting gain using the Direct menu

When you press the DISPLAY/BATT INFO button, the current gain value is displayed on the screen.

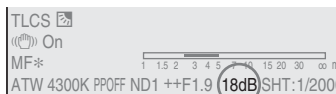

When the Direct menu is in All mode, you can change the gain in steps of 3 dB with the Direct menu by operating the joystick or the jog dial. You can also select AGC mode with the Direct menu.

When the Direct menu is in Part mode, you can switch between AGC and the gain selected with the GAIN switch.

### Note

When the camcorder is in Full Auto mode (page 48), the Direct menu cannot be selected.

For details on the Direct menu, see “Direct Menu Operation” on page 24.

## Recording in AGC Mode

When you set the camcorder to Full Auto mode (page 48), AGC mode is forcibly selected.

When Full Auto mode is off, you can independently turn AGC mode on by setting “AGC” to “On” with “TLCS” (page 117) of the CAMERA SET menu or selecting AGC with the Direct menu.

## Setting the Electronic Shutter

The electronic shutter of the camcorder permits you to change the shutter speed (the accumulation time per recording frame).

The electronic shutter can be adjusted automatically or manually as required.

### Fixed Shutter (manual adjustment) modes

Recording is made with a specified shutter speed (accumulation time).

#### Standard modes (Speed mode/Angle mode)

These modes may be especially effective when you wish to record a quick-moving subject with little blurring.

You can select Speed mode or Angle mode. In Angle mode, you can specify the shutter speed by setting the shutter angle.

#### ECS (Extended Clear Scan) mode

Specify the shutter speed by frequency. This mode may be used to shoot the monitor screen eliminating horizontal bands.

#### SLS (Slow Shutter) mode

For shooting a subject in low-level lighting conditions. Specify the shutter speed in the number of accumulated frames.

### EX Slow Shutter mode

This is an advanced mode of SLS mode. The shutter speed is specified in the number of accumulated frames. Up to 64 frames can be accumulated in this mode, permitting you to obtain low-noise clear pictures in low light levels or a surreal pictures with afterimages.

### Auto Shutter mode

The shutter speed is automatically adjusted according to the picture brightness.

## Shooting in a Fixed Shutter Mode

When you set the SHUTTER switch to ON, the fixed shutter is turned on in the mode and with the



shutter speed you specified with “Shutter” of the CAMERA SET menu.

#### Note

When Auto Shutter mode is ON, the fixed shutter cannot be selected.

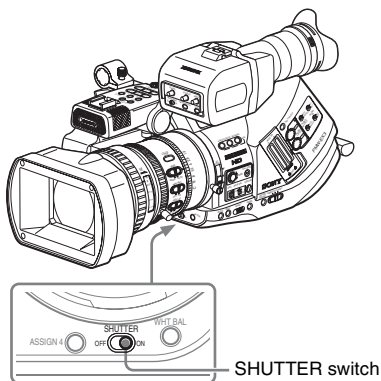

## Setting the fixed shutter with the CAMERA SET menu

The shutter mode and shutter speed can be set with the CAMERA SET menu.

Press the MENU button to set the camcorder to Menu mode, display the CAMERA SET menu with , and select “Shutter.”

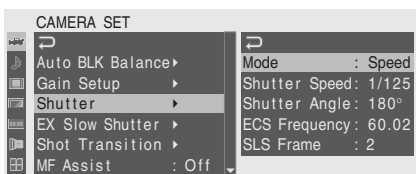

### Speed (standard speed) mode

Set “Mode” to “Speed,” and specify the time ([ 1 / setting value ] sec.) with “Shutter Speed.”

The available setting values vary depending on the current frame rate.

Frame rate	Shutter speed (sec.)
60i, 60P	$1/60$ , $1/100$ , $1/120$ , $1/125$ , $1/250$ , $1/500$
50i, 50P	$1/1000$ , $1/2000$
24P	$1/32$ , $1/48$ , $1/50$ , $1/60$ , $1/96$ , $1/100$ , $1/120$ , $1/125$ , $1/250$ , $1/500$ , $1/1000$ , $1/2000$

Frame rate	Shutter speed (sec.)
25P	$1/33$ , $1/50$ , $1/60$ , $1/100$ , $1/120$ , $1/125$ , $1/250$ , $1/500$ , $1/1000$ , $1/2000$
30P	$1/40$ , $1/50$ , $1/60$ , $1/100$ , $1/120$ , $1/125$ , $1/250$ , $1/500$ , $1/1000$ , $1/2000$

### Angle (standard angle) mode

Set “Mode” to “Angle,” and specify the shutter angle with “Shutter Angle.”

You can select from among 180, 90, 45, 22.5, and 11.25 degrees.

### ECS (Extended Clear Scan) mode

Set “Mode” to “ECS,” and specify the frequency with “ECS Frequency.”

The available setting values vary depending on the current frame rate.

### SLS (Slow Shutter) mode

Set “Mode” to “SLS,” and specify the number of accumulated frames with “SLS Frame.”

You can select in the range of 2 to 8 frames.

#### Note

Slow Shutter cannot be used in SP 1080/24P mode or Slow & Quick Motion mode.

## Setting with the Direct menu

When you press the DISPLAY/BATT INFO button, the current shutter mode and the set value are displayed.

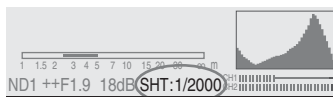

When the Direct menu is in All mode, you can change the shutter mode and speed with the Direct menu by operating the joystick or the jog dial.

#### Notes

- When the Direct menu is in Part mode, you cannot turn the shutter on/off with the Direct menu if the SHUTTER switch is set to ON. If the SHUTTER switch is set to OFF, only switching between Auto Shutter and Shutter OFF.
- The Direct menu cannot be selected when the camcorder is in Full Auto mode (page 48) or when the EX Slow Shutter mode is set to “On.”

For details on the Direct menu, see “Direct Menu Operation” on page 24.

## Shooting in EX Slow Shutter Mode

Select “EX Slow Shutter” from the CAMERA SET menu.

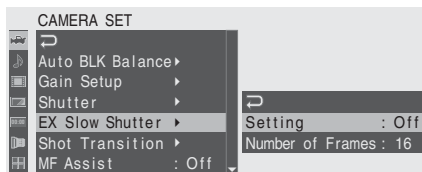

Set “Setting” to “On,” and specify the number of accumulated frames with “Number of Frames.” You can select from among 16, 32, and 64 frames.

### Notes

- EX Slow Shutter cannot be used in SP 1080/24P mode or Slow & Quick Motion mode.
- The SHUTTER switch has no effect on the EX Slow Shutter setting.
- The EX Slow Shutter On/Off setting cannot be changed during recording.
- You cannot set the camcorder to Full Auto mode (page 48) when the EX Slow Shutter mode is set to “On.”

## Shooting in Auto Shutter Mode

When you set the camcorder to Full Auto mode (page 48), Auto Shutter is forcibly selected. When Full Auto mode is off, you can independently turn Auto Shutter mode on by setting “Auto Shutter” to “On” with “TLCS” (page 117) of the CAMERA SET menu.

## Adjusting the Iris

Adjust the iris opening according to the brightness of the subject.

### Auto Iris mode

The iris is automatically adjusted according to the brightness of the subject.

### Manual Iris mode

Adjust the iris opening using the iris ring or with a menu operation.

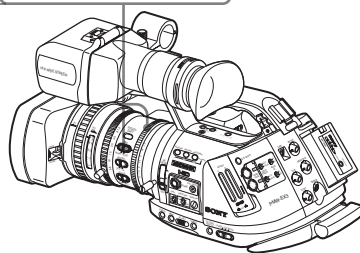
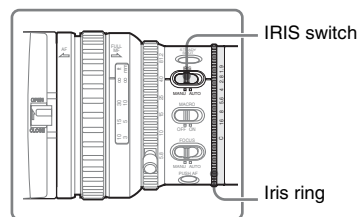

## Recording in Auto Iris Mode

When the camcorder is in Full Auto mode (page 48), Auto Iris mode is forcibly turned on. When Full Auto mode is off, you can turn it on by setting the IRIS switch to AUTO. You can select the target level (to make the picture brighter or darker) of the Auto Iris control. (The gain control in AGC mode and the shutter speed control in Auto Shutter mode are adjusted in synchronization.)

### To adjust the target level with the Setup menu

Set “Level” of “TLCS” (page 117) of the CAMERA SET menu.

## To adjust the target level with the Direct menu

The target level can also be selected using the Direct menu.

When you press the DISPLAY/BATT INFO button, the current setting is displayed on the screen.



You can change the setting with the Direct menu by operating the joystick or the jog dial.

For details on the Direct menu, see “Direct Menu Operation” on page 24.

### Note

Auto Iris motions may be different among lenses. Adjust the “Speed” setting of “TLCS” (page 117) on the CAMERA SET menu if needed.

## Adjusting the Iris Manually

Set the IRIS switch to MANU to adjust the iris manually.

Rotate the iris ring for the desired iris opening.

## Adjusting the Zoom

You can adjust the zoom in Manual mode or Power (Servo) mode on the supplied lens.

### Manual Zoom mode

Rotate the zoom ring to adjust the zoom.

### Power Zoom (Servo) mode

You can adjust the zoom by pressing the power zoom lever or zoom button on the handle. The supplied IR Remote Commander and optional lens remote controller can also be used.

The current zoom position is displayed on the screen in the range of 0 (Wide) to 99 (Tele) when you press the DISPLAY/BATT INFO button.

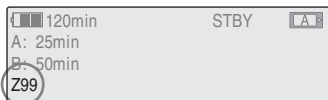

The numerical indication can be changed to that in a bar by changing the “Zoom Position” setting of “Display On/Off” (page 121) of the VF SET menu.

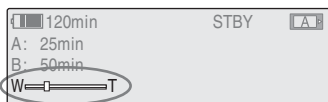

## Switching the Zoom Mode

Switching between Manual mode and Servo mode is performed with the ZOOM switch located on the bottom of the camcorder.

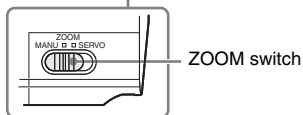
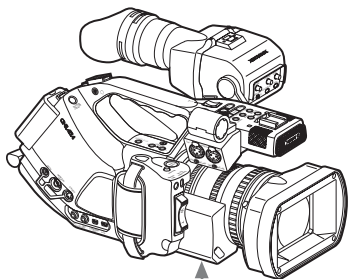

## Operating the Zoom Manually

Setting the ZOOM switch to the MANU position for Manual Zoom mode activates the zoom ring. Rotate the zoom ring to adjust the zoom.

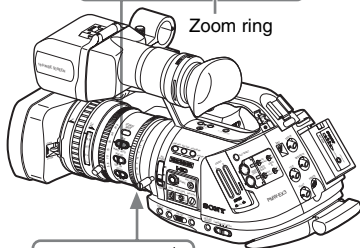
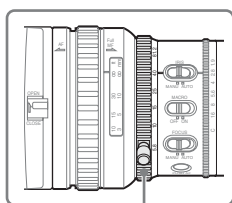

## Using the Power Zoom

Setting the ZOOM switch to the SERVO position for Servo mode activates the power zoom. In Servo mode, the power zoom lever on the grip and the ZOOM button on the handle are activated.

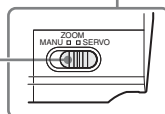
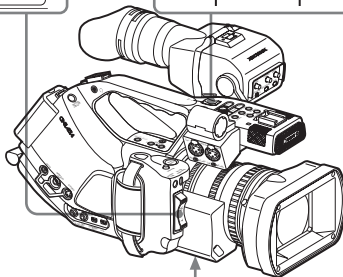
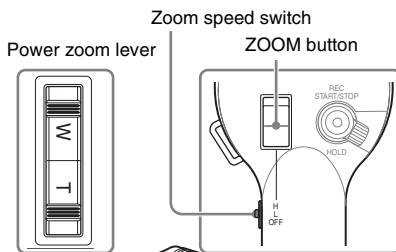

### To adjust with the power zoom lever on the grip

Press the W (wide) side for a wider angle or the T (telephoto) side for a closer angle. Pressing the lever deeper sets zooming faster.

### To adjust with the ZOOM button on the handle

Press the W side for a wider angle or the T side for a closer angle.

Zooming is activated at the speed selected with the speed switch.

The zoom speed assignment can be changed with the CAMERA SET menu.

Speed switch	ZOOM button operation
H	Zoom changes with the speed set by "High" of "Zoom Speed" of CAMERA SET menu. (Default: 70)
L	Zoom changes with the speed set by "Low" of "Zoom Speed" of CAMERA SET menu. (Default: 30)
OFF	Disabled

## When adjusting with the ZOOM button of the IR Remote Commander

The zooming speed depends on the “Remote” setting (default: 50) of “Zoom Speed” of the CAMERA SET menu.

*To use the IR Remote Commander, see “Using the IR Remote Commander” on page 39.*

## When using a lens remote controller

Zooming can also be controlled from an optional lens remote controller connected via the LENS REMOTE connector.

*For operation of the optional lens remote controller, refer to the operation guide of the lens remote controller.*

## Adjusting the Focus

You can select any of three modes for focus adjustments on the supplied lens.

### Full MF (Full Manual Focus) mode

Only adjustment with the focus ring is effective in this mode.

You can adjust the focus from  $\infty$  to the minimum length by rotating the ring. The ring rotates endlessly in the both directions.

### MF (Manual Focus) mode

In this mode, auto focus can be temporarily activated by pushing the PUSH AF button. The MF Assist function can be used for assistance.

### AF (Auto Focus) mode

Auto focus functions continuously in this mode. The focus ring and the PUSH AF button can also be used.

#### Note

The infinity position has some margin to compensate for focus change caused by variation in ambient temperature. When shooting an image at infinity in MF or Full MF mode, adjust the focus while observing the image in the viewfinder.

## Adjusting in Full MF Mode

Pull the focus ring rearward (toward the camcorder body) to set the camcorder to Full MF mode. Focus can only be adjusted with the focus ring manually.

#### Note

The focus instantly moves to the range index position when you pull the focus ring rearward.

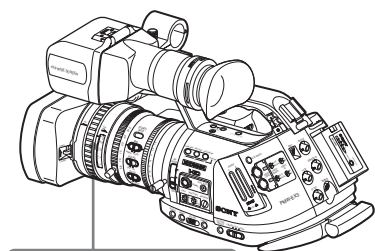

Range index

Focus ring: Rearward

Rotate the focus ring for the best focus while observing the picture in the viewfinder. The rang index of the focus ring is effective in Full MF mode. The distances correspond to the focus ring positions.

## Expanded Focus

When you press the EXPANDED FOCUS button, the center area of the picture is magnified in the viewfinder, making the focus adjustment easier.

Press the EXPANDED FOCUS button again to resume the normal angle for recording.

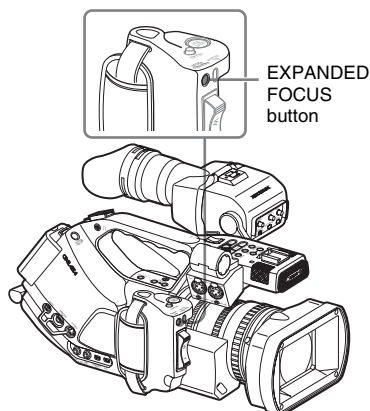

## Peaking

When you turn the PEAKING control from its left-end position, the peaking function is activated. This function emphasizes the contours of the images in the viewfinder, making manual focusing easier.

The emphasis level is increased by turning the control clockwise.

This function does not affect recording signals.

PEAKING control

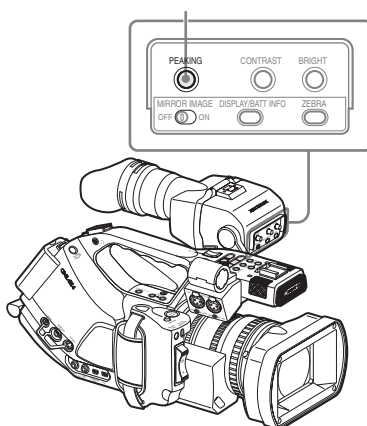

The color of the contours can be set with “Peaking” (page 120) of the VF SET menu. Turning the control back to its left stop position deactivates the peaking function.

## Adjusting in MF Mode

Slide the focus ring forward (toward the lens hood) and set the FOCUS switch to MANU to set the camcorder to MF mode. In this mode, you can activate Auto Focus only when required.

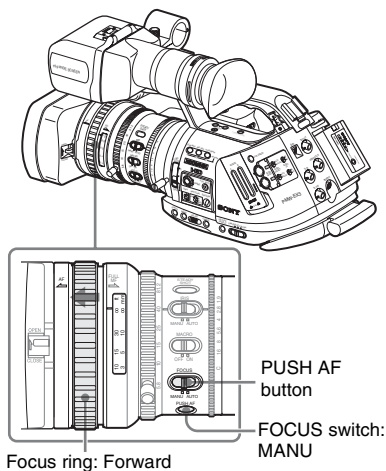

In MF mode, you can activate/deactivate the MF Assist function with the Direct menu by operating the joystick or the jog dial. When the function is active, an asterisk mark is displayed to the right of the mode indication.

**Note**

The Direct menu cannot be selected in a mode other than MF mode.

For details on the Direct menu, see “Direct Menu Operation” on page 24.

### Adjusting the focus with the focus ring

Rotate the focus ring for the best focus while observing the picture in the viewfinder. The range index of the ring is invalid in MF mode.

### One-Push (Momentary) Auto Focusing

Push the PUSH AF button. Auto focusing momentarily activates (One-Push Auto Focusing). One-Push Auto Focusing is terminated when the subject comes in focus.

### MF Assist function

When you stop rotating the focus ring with the MF Assist function active, auto focusing starts, performing fine focus adjustment for the subject in the center of the screen. When the fine adjustment is completed, automatic focusing with the MF Assist function is terminated.

#### Activating the MF Assist function using the CAMERA SET menu

Set “MF Assist” (page 115) of the CAMERA SET menu to “On.”

#### Activating the MF Assist function using the Direct menu

The current focus adjustment mode is displayed on the screen when you press the DISPLAY/BATT INFO button.

### Adjusting in AF Mode

Slide the focus ring forward (toward the lens hood) and set the FOCUS switch to AUTO to set the camcorder to AF mode. In this mode, focus is always adjusted automatically.

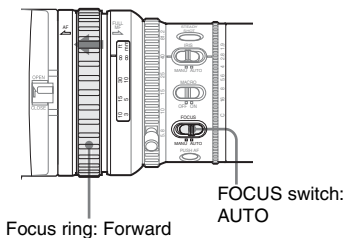

The range index of the ring is invalid in AF mode.

### Focusing in AF mode

In AF mode the camcorder continuously checks changes of images and activates auto focusing each time it detects a change. The auto focus adjustment is terminated when the subject comes into focus, and the camcorder stands by until the next change is detected.

In AF mode, auto focusing is also activated when you press the PUSH AF button or operate the focus ring.

## Using Macro Mode

When you set the MACRO switch to ON in AF or MF mode, Macro mode is activated, permitting you to adjust the focus in a range that includes the micro area.

The Macro mode is invalid in Full MF mode.

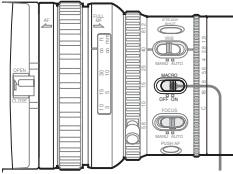

MACRO switch

## Eliminating Picture Blurring (Steady Shot)

By activating the Steady Shot function of the supplied lens, blurring of images due to camera shaking can be reduced.

**Press the STEADY SHOT button on the lens.**

Pressing the button turns the Steady Shot function ON or OFF.

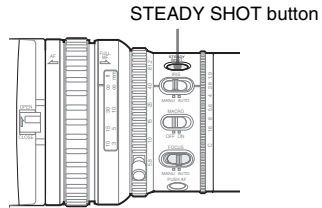

The setting of the Steady Shot function is displayed in the viewfinder.



### Note

If the camcorder is fixed to a tripod for stable condition, deactivate the Steady Shot function.



## Reducing Flickers

To reduce flickers, try either of the following two methods:

---

### Setting the shutter speed according to the power-supply frequency

---

Activate the electronic shutter (page 56) and set the shutter speed according to the power supply frequency.

#### When the frequency is 50 Hz

Set the shutter speed to  $1/50$  or  $1/100$  seconds.

#### When the frequency is 60 Hz

Set the shutter speed to  $1/60$  or  $1/120$  seconds.

---

### Using the Flicker-Reduction function

---

Set “Flicker Reduce” (page 115) of the CAMERA SET menu to “Auto” or “On” and set “Frequency” to the power-supply frequency (50 Hz or 60 Hz).

#### Note

If the frame rate selected for recording is close to the power-supply frequency, flicker may not be reduced sufficiently even if you activate the Flicker-Reduction function. In such cases, use the electronic shutter.

## Setting the Time Data

Time data, such as the timecodes, user bits, and the clock time, are recorded with pictures.

*The timecode can be locked to an external timecode generator. For details, see “External Synchronization” on page 134.*

---

### Running Modes of the Timecode

---

For the timecode, three running modes and Clock mode can be selected.

---

#### Rec Run mode

---

The timecode advances during recording only. The continuity of the timecode is maintained between clips in the sequence of recording as long as the SxS memory card is not changed. If you remove the memory card and record on another card, the timecode will not continue when you return the first card to the slot again.

---

#### Free Run mode

---

The timecode keeps advancing regardless of recording.

---

#### Regen mode

---

The timecode advances during recording only. When you insert another memory card, the camcorder starts next recording so that the timecode continues to the last recorded timecode on the card.

---

#### Clock mode

---

The current clock time is recorded for the timecode.

#### Note

In Interval Recording, Frame Recording, Slow & Quick Motion Recording, the timecode advances in Rec Run mode regardless of the “Run” setting if you set “Mode” of “Timecode” to “Preset” with the TC/UB SET menu.

If you set it to “Clock,” the timecode advances in Regen mode.

## Setting the Timecode

Specify the timecode to be recorded with “Timecode” and “TC Format” of the TC/UB SET menu.

For details on menu operations, see “Basic Menu Operations” on page 111.

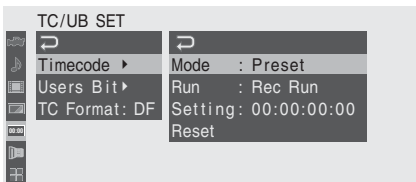

### Setting the timecode to a desired value

- 1 Set “Mode” of “Timecode” to “Preset.”
- 2 Specify the timecode value on the Setting line and select “SET.”

### Resetting the timecode

You can reset the timecode to be recorded in running modes to “00:00:00:00.”

- 1 Select “Reset” of “Timecode.”
- 2 Select “Execute.”

### Using the actual time as the timecode

#### Set “Mode” of “Timecode” to “Clock.”

The time of the built-in clock is recorded as the timecode.

### Switching between DF and NDF of the timecode

Using “TC Format” of the TC/UB SET menu, DF (drop-frame mode) and NDF (non-drop frame mode) of the timecode can be switched.

Note, however, that the mode is fixed either to DF or NDF regardless of the TC Format setting, depending on the current frame-rate setting.

### Restrictions on the timecode

The timecode setting is restricted by the current video format.

Video formats	Frame setting	TC Format
HQ1080/60i	00 to 29	DF/NDF switchable (Fixed to DF in Clock mode)
SP 1080/60i		
HQ1080/30P		
HQ 1080/50i	00 to 24	Fixed to NDF
SP 1080/50i		
HQ 1080/25P		
HQ 1080/24P	00 to 23 <sup>1)</sup>	Fixed to NDF <sup>2)</sup>
HQ 720/24P		
SP 1080/24P	00 to 29 <sup>3)</sup>	DF/NDF switchable (Fixed to DF in Clock mode)
HQ 720/60P	00 to 29 (double count)	DF/NDF switchable (Fixed to DF in Clock mode)
HQ 720/50P	00 to 24 (double count)	Fixed to NDF
HQ 720/30P	00 to 29	DF/NDF switchable (Fixed to DF in Clock mode)
HQ 720/25P	00 to 24	Fixed to NDF

1) The frame digits in “Setting” are limited to 00, 04, 08, 12, 16, and 20.

The frame at the beginning of recording is limited to 00, 04, 08, 12, 16, and 20.

The frame digits of the timecode added to the SDI OUT connector output are changed to values in the range of 00 to 29.

2) Even in Clock mode, the timecode may be gradually shifted, because it is counted by NDF.

When adding the timecode to the output from the COMPONENT OUT connector or the video output from the MONITOR OUT and S VIDEO connectors, there may be a field that has dual timecodes because of the 2-3 pull-down process.

3) With DF, the frame digits can be set as desired in the range of 00 to 29.

With NDF, the frame at the beginning of recording is limited to 00, 05, 10, 15, 20, and 25.

## Setting the User Bits

You can add a hexadecimal number of 8 digits for pictures as the user bits.

The user bits can also be set to the current date. Use “Users Bit” of the TC/UB SET menu.

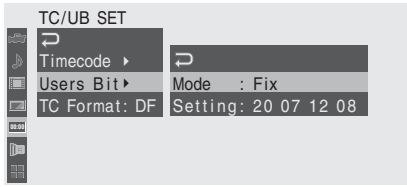

## Setting eight digits as desired

- 1 Set “Mode” of “Users Bit” to “Fix.”
- 2 Specify the values on the Setting line and select “SET.”

You can set hexadecimal digits A to F with the corresponding alphabets.

## Recording the current date as the user bits

Set “Mode” of “Users Bit” to “Date.”

The current date is displayed on the Setting line.

## Displaying the Time Data

In Camera mode, pressing the DISPLAY/BATT INFO button displays the time data on the screen.

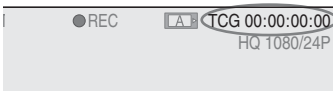

The indication is switched among the timecode, user bits, and recording duration each time you press the TC/U-BIT/DURATION button.

Display	Contents
TCG **:**:**:**:**	Timecode
CLK **:**:**:**:**	Timecode (Clock mode)
UBG ** ** ** **	User bits
DUR **:**:**:**	Duration from the beginning of recording

# Recording Audio Signals

Two channels (CH-1/CH-2) of audio can be recorded (Linear PCM recording) in synchronization with video recording. You can use the built-in stereo microphones (omni-directional electret condenser microphones) or 2-channel external audio inputs to the AUDIO IN connectors by switching with the AUDIO IN switches.

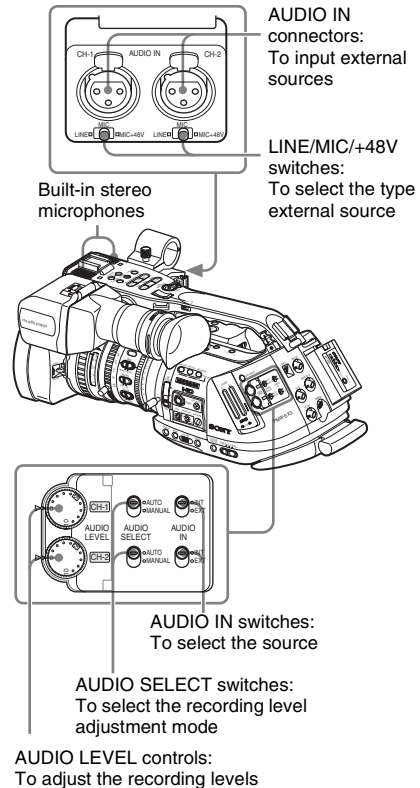

## Using the Built-in Stereo Microphones

Set the AUDIO IN switches, both CH-1 and CH-2, to INT.

## Using External Inputs

- 1 Set the **AUDIO IN** switches **CH-1** and **CH-2** to **EXT.**
- 2 Connect external audio sources to the **AUDIO IN** connectors **CH-1** and **CH-2**.
- 3 Set the **LINE/MIC/+48V** switches **CH-1** and **CH-2** to **LINE** (line level: +4 dBu).

## Using an External Microphone

You can use an external microphone for recording, such as the ECM-673 Electret Condenser Microphone.

- 1 Loosen the screw of the microphone holder and open the cover.

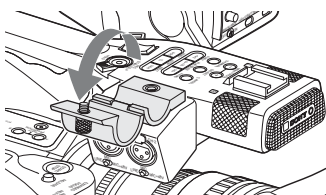

- 2 Attach a microphone, close the microphone holder cover for the original condition to secure, then connect the microphone cable to either of the **AUDIO IN** connectors (**CH-1** or **CH-2**).

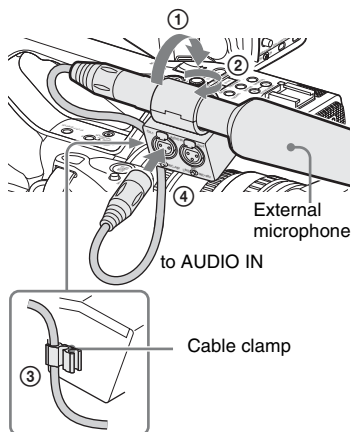

- 3 Set the corresponding **AUDIO IN** switch (**CH-1** or **CH-2**) to **EXT.**
- 4 Set the corresponding **LINE/MIC/+48V** switch (**CH-1** or **CH-2**) according to the connected microphone.
  - MIC:** For a microphone that requires no power supply
  - +48V:** For a microphone that requires +48V power supply (such as the ECM-673)

## Adjusting the Audio Recording Levels

You can select automatic or manual adjustment mode independently for each channel.

### To adjust the levels automatically (AGC)

When the **AUDIO SELECT** switches **CH-1** and **CH-2** are set to **AUTO**, the audio recording levels are automatically adjusted.

### To adjust the levels manually

Set the **AUDIO SELECT** switches **CH-1** and **CH-2** to **MANUAL**, and adjust the audio recording levels by turning the **AUDIO LEVEL** controls. The value is set to 0 dB when the control is set to 5. Setting to 10 maximizes the level (+12 dB) and setting to 0 minimizes it ( $-\infty$ ).

The input levels are displayed on the screen when you press the **DISPLAY/BATT INFO** button.



## Audio recording in special recording modes

- No audio recording is made in Interval Recording or Frame Recording.
- No audio recording is made in Slow & Quick recording if the recording frame rate is set to a value different from the playback frame rate.

## Monitoring the Audio

You can monitor the sounds being recorded with the headphones connected to the headphone connector (stereo mini jack).

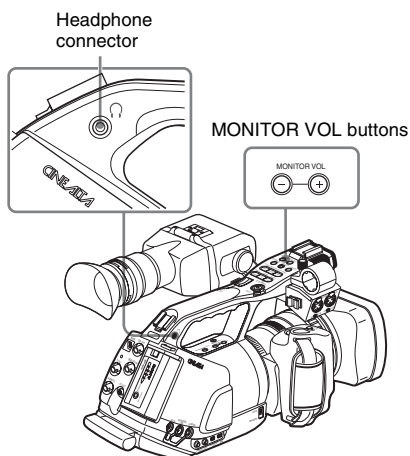

### Note

The built-in speaker is disabled in Camera mode.

### To adjust the audio monitoring volume

Use the MONITOR VOL buttons. Pressing the + button increases the volume, and pressing the – button decreases it. To muffle the sound, set it to the minimum level. While you adjust the volume, the level is displayed as a bar on the screen.

## Outputting the Color Bars and Reference Tone

The camcorder can output a color-bar signal in place of the camera picture. A 1-kHz reference tone is output with the color bar signal if “1kHz Tone” of “Audio Input” (page 118) is set to “On” with the AUDIO SET menu. The color-bar signal is also fed out from the SDI OUT, COMPONENT OUT, MONITOR OUT and S VIDEO connectors, and the reference-tone signal is fed from the AUDIO OUT connectors.

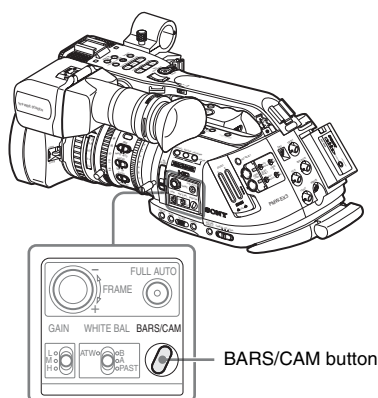

### Press the BARS/CAM button.

The camera picture is switched to color bars. To return to the camera picture, press the button again.

You can select the type of color bars with “Color Bar Type” (page 115) of the CAMERA SET menu.

- Multi:** ARIB multiformat color bars
- 75%:** Vertical stripes of 75% luminance
- 100%:** Vertical stripes of 100% luminance

### Notes

- When recording of the camera image is in progress, it cannot be switched to the color-bar picture even if you press the BARS/CAM button. (You can switch the color-bar picture to the camera picture.)

- The color bar mode cannot be selected in Slow & Quick Motion mode and EX Slow Shutter mode.

## Recording Shot Marks

When you record shot marks for important scenes as subsidiary data, you can access the marked points easily on a Shot Mark screen, which only displays scenes with shot marks only. This increases editing efficiency.

*For the Shot Mark Screen, see “Displaying the SHOT MARK Screen” on page 102.*

The camcorder permits you to record two types of shot marks: shot mark 1 and shot mark 2. Shot marks can be recorded as needed during recording or can be added after recording while checking the playback pictures.

### Inserting a shot mark during recording

Activate the IR Remote Commander (*page 39*), and use the SHOTMARK 1 or 2 button.

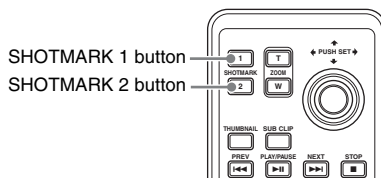

**Press the SHOTMARK 1 or 2 button where you wish to insert a mark.**

If the Shot Mark1 or Shot Mark2 function is assigned to an assignable button, you can also use it instead (*page 72*).

A shot mark of the type corresponding to the button you press is recorded.

*For operations to add shot marks after recording, see “Adding shot marks during playback” on page 96 and “Adding/Deleting Shot Marks” on page 103.*

## Rec Review

- If the video format is changed after recording, Rec Review cannot be performed.
- The Setup and PICTURE PROFILE menus cannot be operated during Rec Review.

You can review the last recorded clip on the screen (Rec Review).

Use the REC REVIEW button on the supplied lens or assign the Rec Review function to an assignable button to use it instead (*page 72*).

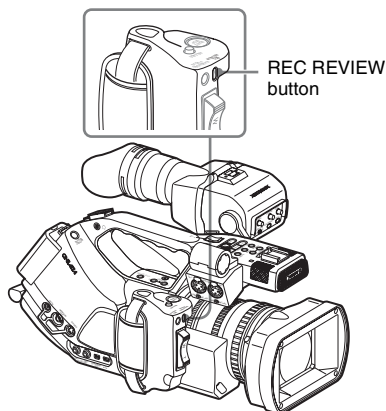

**After recording is finished, press the REC REVIEW button or the assignable button to which you assigned the Rec Review function.**

Playback of the specified block of the clip begins. In Rec Review, the last 3 seconds, 10 seconds, or the entire part of the clip is displayed, depending on the “Rec Review” setting (*page 116*) of the CAMERA SET menu. It is set to 3 seconds at the factory.

Rec Review is terminated at the end of the clip, resuming STBY (recording standby) status.

### Notes

- If the duration of the last recorded clip is less than the time (3 or 10 seconds) specified for Rec Review, the clip is played back from the beginning to the end.
- During Rec Review playback, only the STOP button is valid.

When the STOP button is pressed, Rec Review is canceled, and the camcorder returns to STBY (recording standby) status.

# Changing Functions of the Assignable Buttons

The camcorder has four assignable buttons to which you can assign various functions for convenience.

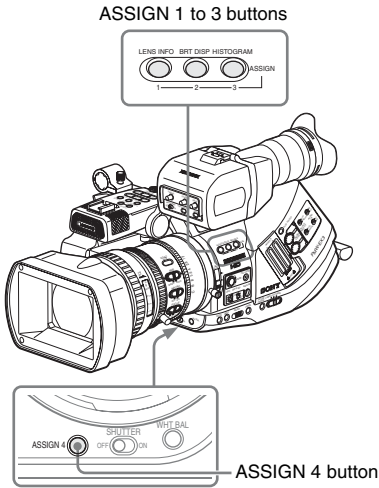

The following functions are assigned at the factory:

**ASSIGN 1 button (LENS INFO)**

Depth-of-field indication on/off

**ASSIGN 2 button (BRT DISP)**

Brightness-level indication on/off

**ASSIGN 3 button (HISTOGRAM)**

Histogram indication on/off

**ASSIGN 4 button**

No function is assigned (Off).

## Changing Functions

Use “Assign Button” of the OTHERS menu.

For details on menu operations, see “Basic Menu Operations” on page 111.

**1 Select “Assign Button” from the OTHERS menu.**

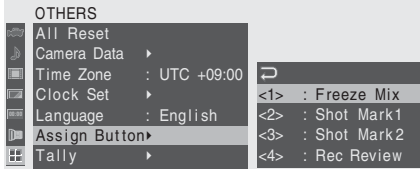

**2 Select the button to which you wish to assign a function.**

**3 Select the function to be assigned.**

Function	Contents
Marker	All marker indications (safety-zone marker, center marker, aspect marker, guide frames) on/off
Last Clip DEL	Last clip delete
ATW	ATW function on/off
Rec Review	Rec Review start/stop
Rec	Recording start/stop
Freeze Mix	Freeze Mix start/stop
Expanded	Expanded Focus function on/off
Focus	
Spotlight	TLCS Spotlight mode on/off
Backlight	TLCS Backlight mode on/off
IR Remote	IR Remote Commander enable/disable
Shot Mark1	Shot mark 1 insert
Shot Mark2	Shot mark 2 insert
Fader	Fader on/off
VF Mode	Viewfinder screen mode (color/monochrome) switching
BRT Disp	Brightness level indication on/off
Histogram	Histogram indication on/off
Lens Info	Depth-of-Field indication on/off

**4 Exit the menu.**

The assigned functions can be viewed on the BUTTON/REMOTE status screen (page 108).



# Interval Recording

The Interval Recording (time-lapse recording) function is especially effective for shooting objects that move very slowly.

The specified number of frames are automatically recorded at the specified intervals.

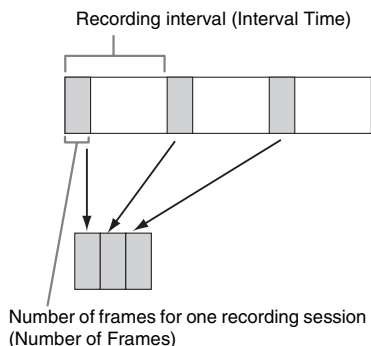

It is recommended to fix the camcorder to a tripod or equivalent and use the IR Remote Commander to start/stop recording rather than pressing the REC START/STOP button of the camcorder.

## Notes

- Interval Recording cannot be set to “On” simultaneously with Frame Recording or Slow & Quick Motion. When you set Interval Recording to “On,” Frame Recording and Slow & Quick Motion are forcibly set to “Off.”
- No audio recording is executed in Interval Recording.
- Interval Recording cannot be performed if an SP video format is selected with “Video Format” and “i.LINK I/O” is set to “Enable” with the OTHERS menu.
- Interval Recording cannot be performed if “Video Format” of the OTHERS menu is set to SP 1080/24P.

## Preparatory Settings

Before starting Interval Recording, make the necessary settings on the CAMERA SET menu in advance.

For details on menu operations, see “Basic Menu Operations” on page 111.

### 1 Select “Interval Rec” of the CAMERA SET menu.

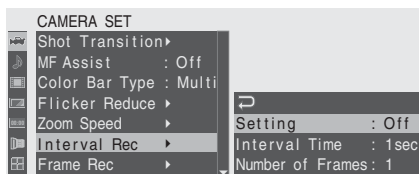

### 2 Set “Setting” to “On.”

The camcorder enters Interval Recording mode.

When the special recording mode indication on the screen is active, “Interval Rec” flashes on the screen.

### 3 Set the time between recordings with “Interval Time.”

You can select the time from among 1 to 10/15/20/30/40/50 seconds, 1 to 10/15/20/30/40/50 minutes, and 1 to 4/6/12/24 hours by scrolling the display.

### 4 Set the number of frames to be recorded at a time with “Number of Frames.”

When “Video Format” (page 127) is set to “720/60P” or “720/50P,” you can select from among 2, 6, and 12 frames.

With other settings, you can select from among 1, 3, 6, and 9 frames.

### 5 Exit the menu.

## Performing Interval Recording

When the preparatory settings are completed, you can start recording.

### Press the REC START/STOP button.

Interval Recording begins.

The flashing “Interval Rec” on the screen is now steadily lit.

## Notes

- You cannot change the “Interval Time” and “Number of Frames” settings while Interval Recording is in progress. To change them, pause recording.

- The Freeze Mix function and Rec Review function cannot be used in Interval Recording mode.
- The timecode is recorded in Rec Run mode (page 66) during Interval Recording.
- Some extra frames may be recorded if you stop recording or switch the card slot while recording is halted in Interval Recording mode.

## Stopping Interval Recording

### Press the REC START/STOP button.

Interval Recording stops.

To restart Interval Recording, press the button again.

## Canceling Interval Recording mode

Set “Setting” of “Interval Rec” of the CAMERA SET menu to “Off.”

### Note

It automatically returns to “Off” when you set the power switch to OFF, while the “Interval Time” and “Number of Frames” settings are maintained.

## Frame Recording

The Frame Recording function is especially effective for clay animation recording.

The specified number of frames are recorded intermittently when you press the REC START/STOP button.

It is recommended to fix the camcorder to a tripod or equivalent and use the IR Remote Commander to start/stop recording rather than pressing the REC START/STOP button of the camcorder.

### Notes

- Frame Recording cannot be set to “On” simultaneously with Interval Recording or Slow & Quick Motion. When you set Frame Recording to “On,” Interval Recording and Slow & Quick Motion are forcibly set to “Off.”
- No audio recording is executed in Frame Recording.
- Frame Recording cannot be performed if an SP video format is selected with “Video Format” and “i.LINK I/O” is set to “Enable” with the OTHERS menu.
- Frame Recording cannot be performed if “Video Format” of the OTHERS menu is set to SP 1080/24P.

## Preparatory Settings

Before starting Frame Recording, make the necessary settings on the CAMERA SET menu in advance.

For details on menu operations, see “Basic Menu Operations” on page 111.

### 1 Select “Frame Rec” of the CAMERA SET menu.

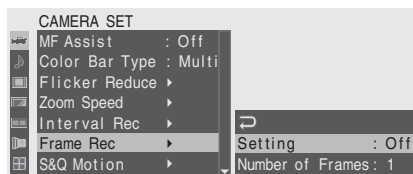

### 2 Set “Setting” to “On.”

The camcorder enters Frame Recording mode.

When the special recording mode indication on the screen is active, “Frame Rec” flashes on the screen.

### 3 Select the “Number of Frames” value for one recording session.

You can select from among 2, 6, and 12 when “Video Format” (page 49) is set to 720/60P or 720/50P.

With other video formats, you can select from among 1, 3, 6, and 9.

### 4 Exit the menu.

- Some extra frames may be recorded if you stop recording or switch the card slot while recording is paused in Frame Rec mode.

---

## Stopping Frame Recording

---

### Set “Setting” of “Frame Rec” of the CAMERA SET menu to “Off.”

Recording stops and Frame Rec mode is canceled.

#### Note

It automatically returns to “Off” when you set the power switch to OFF, while the “Number of Frames” setting is maintained.

## Performing Frame Recording

When the preparatory settings are completed, you can start recording.

### 1 Press the REC START/STOP button.

Recording in Frame Rec mode begins.

The “Frame Rec” indication stops flashing.

When the number of frames you specified with the menu are recorded, the camcorder automatically enters FRM STBY (Frame Rec Standby) status.

### 2 Press the REC START/STOP button again.

Each time you press the REC START/STOP button, the camcorder records the specified number of frames then enters FRM STBY status.

#### Notes

- Recording cannot be stopped until the specified number of frames are recorded. If the power switch is set to OFF during recording, the power is only shut off after the specified number of frames are recorded.
- The Freeze Mix function and Rec Review function cannot be used while recording in Frame Rec mode is in progress.
- You cannot change the “Number of Frames” setting while recording in Frame Rec mode is in progress. To change it, pause the recording.
- The timecode is recorded in Rec Run mode (page 66) during Frame Recording.

## Slow & Quick Motion Recording

When an HQ Progressive (P) video format is selected (*page 49*), you can set the frame rate for recording different from that for playback. By recording at the different frame rate, you can obtain smoother slow-motion or quick-motion effect when compared with slow-speed or fast-speed playback of a material recorded at the normal recording speed.

### Example

When the video format is HQ 720/24P, recording with a frame rate between 1 and 23 fps provides a quick-motion effect in playback, and recording with the frame rate between 25 and 60 fps provides a slow-motion effect in playback.

### Notes

- Slow & Quick Motion cannot be activated simultaneously with Frame Recording or Interval Recording. When you activate Slow & Quick Motion, Frame Recording and Interval Recording are forcibly set to “Off.”
- No audio recording is made if the recording frame rate is set to a value different from the playback frame rate.
- Slow & Quick Motion recording cannot be made if “Video Format” of the OTHERS menu is set to HQ 1080/60i, HQ 1080/50i, SP 1080/60i, SP 1080/50i, or SP 1080/24P.
- When using a PHU-60K (*page 45*), set the camcorder to one of the following conditions. Slow & Quick Motion recording cannot be done properly with other conditions.

—NTSC Area

Video format	Recording frame rate
HQ 1080/30P	1 to 30 fps
HQ 1080/24P	1 to 24 fps
HQ 720/60P	1 to 60 fps
HQ 720/30P	1 to 30 fps
HQ 720/24P	1 to 24 fps

—PAL Area

Video format	Recording frame rate
HQ 1080/25P	1 to 25 fps
HQ 720/50P	1 to 50 fps
HQ 720/25P	1 to 25 fps

## Preparatory Settings

Before starting Slow & Quick Motion recording, make the necessary settings in advance.

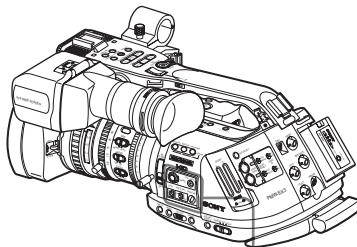

S&Q Motion dial

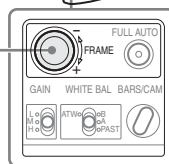

### 1 Press the S&Q Motion dial for more than 1 second.

The camcorder enters the Slow & Quick Motion standby status.

The special recording mode indication on the screen shows “S&Q Motion” and [Recording frame rate]/[Playback frame rate] fps beneath.

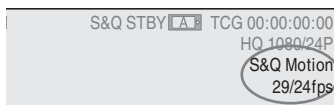

### 2 Set the frame rate for recording by turning the S&Q Motion dial.

The setting range varies depending on the current video format.

**With a 1080 format:** 1 to 30 fps

**With a 720 format:** 1 to 60 fps

**When the RM-B750/B150 Remote Control Unit is connected,** “S&Q Motion” of the CAMERA SET menu is activated, enabling the operation from the Remote Control Unit.

For details, see “Operating the Slow & Quick Motion recording from the Remote Control Unit” on *page 137*.

---

## Setting the recording frame rate with the Direct menu

---

When the special recording mode indication on the screen is active, you can change the recording frame rate with the Direct menu by operating the joystick or the jog dial.

For details on the Direct menu, see “Direct Menu Operation” on page 24.

## Recording in Slow & Quick Motion Mode

When the preparatory settings are completed, you can start recording.

**Press the REC START/STOP button.**

Slow & Quick Motion recording begins.

### Notes

- You cannot change the frame rate setting while Slow & Quick Motion recording is in progress. To change it, pause the recording.
- The timecode is recorded in Rec Run mode during Slow & Quick Motion recording (page 65).

---

## Stopping recording

---

**Press the REC START/STOP button.**

Slow & Quick Motion recording stops.

### Note

When recording at a low-speed frame rate, it may take time until recording stops after you press the REC START/STOP button.

---

## Canceling Slow & Quick Motion mode

---

Push the S&Q Motion dial.

### Note

It automatically returns to “Off” when you set the power switch to OFF, while the frame rate setting is maintained.

## Freeze Mix: Image Alignment

Using the Freeze Mix function, an image (still picture) of a recorded clip can be temporarily superimposed on the current camera picture, permitting you to easily align images for next recording.

---

### To use the Freeze Mix function

---

Assign the Freeze Mix function to one of the assignable buttons.

For details, see “Changing Functions of the Assignable Buttons” on page 72.

---

### Superimposing a Freeze Mix image

---

- 1 Stop recording to set the camcorder to STBY (recording standby) status.**
- 2 Press the REC REVIEW button to review the recorded images, or press the ASSIGN button to which you assigned “Freeze Mix.”**
- 3 Press the ASSIGN button to which you assigned “Freeze Mix” at the image with which you want align.**

The image where you pressed the ASSIGN button in step 3 is displayed as a still picture over the current camera picture.

---

### Canceling Freeze Mix status

---

You can cancel it with the ASSIGN button to which you assigned “Freeze Mix” or the REC START/STOP button.

- When you cancel Freeze Mix status by pressing the ASSIGN button, the normal camera picture is restored.
- When you cancel Freeze Mix status by pressing the REC START/STOP button, normal recording begins.

### Notes

- If the recorded picture and the current camera picture differ in video format, the Freeze Mix display cannot be achieved.

- The Freeze Mix function cannot be used if the recording video format is SP 1080/24P.
- The Freeze Mix display cannot be obtained in Quick & Slow Motion mode or Slow Shutter mode.
- You cannot operate the Setup menus and PICTURE PROFILE menu in Freeze Mix status.

## Shot Transition

The Shot Transition function helps you to easily obtain complex picture effects by registering camera settings or conditions as a “shot” to be reproduced in a recording sequence.

Your settings for focus, zoom, iris, gain, shutter speed, white balance, color matrix, and detail level can be registered in combination in one shot, and you can change the current camera settings to those of the shot, or the settings reproduced from one shot to those of another Shot, resulting in a smooth transition of scenes.

For example, you can shift the focus from a closer object to a farther object, or change the depth of field by adjusting the iris. In addition, you can develop scenes under different recording conditions smoothly. If you register the manual adjustment function for white balance, the scenes will develop smoothly between objects indoors and those outdoors.

### Notes

- Use the exclusive lens for Shot Transition. This function may not operate correctly with a non-exclusive lens.
- Shot transition cannot be activated in combination with any of the EX Slow Shutter, Interval Recording, Frame Recording, and Slow & Quick Motion functions.
- If you wish to shift the focus in a shot transition, set the focus adjustment mode to MF or AF (*see page 61*). The focus will not be shifted if Full MF mode is selected.
- If you wish to shift the zoom in a shot transition, set the ZOOM switch to SERVO (*see page 59*). The zoom will not be shifted with the MANU setting.
- If you register a focus position in a macro area with the MACRO switch ON, the focus may not be shifted to the registered position if a shot transition is executed with the MACRO switch set to OFF.

## Shot-transition operation buttons and indications

For shot-transition operations, use the three TRANSITION operation buttons on the upper panel.

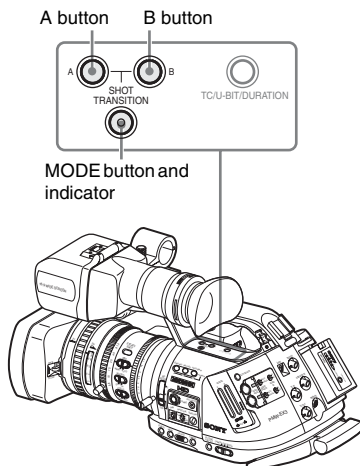

### A button and B button

You can register a Shot to each of the buttons.

### MODE button and indicator

When you press this button, the camcorder enters Shot Transition operation mode, and the indicator of the button lights.

The shot transition operation area is displayed on the screen.

Each time you press the button, the shot-transition operation mode cycles among Store, Check, Execute, and Off (normal Camera mode).

In Execute mode, the shot transition information area appears.

Shot-transition operation area

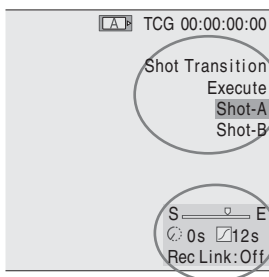

Shot-transition information area

### Note

Camera operations are disabled when the shot transition operation mode is Check or Execute. When adjustments are required, set the mode to Store.

## Preparatory Settings

Before you start recording using the Shot Transition function, make the necessary settings with the CAMERA SET menu in advance.

The conditions you set are indicated in the shot transition information area on the screen when you set the shot-transition operation mode to "Execute."

### Shot-transition information area

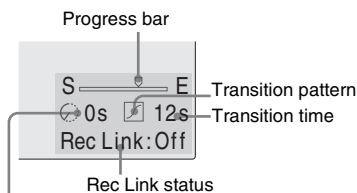

Start timer indication

### Setting procedure

- 1 Select "Shot Transition" from the CAMERA SET menu.

CAMERA SET	
Auto BLK Balance ▶	Trans Time : 2sec
Gain Setup ▶	Trans Speed : 5
Shutter ▶	Time/Speed : Speed
EX Slow Shutter ▶	Trans Curve : Soft Stop
Shot Transition ▶	Start Timer : Off
MF Assist : Off	Rec Link : Off

## 2 Specify the conditions for a shot transition.

### Trans Time

After you set “Time/Speed” to “Time,” set the duration of a transition in the range of 2 to 15 sec in steps of 1 second.

### Trans Speed

After you set “Time/Speed” to “Speed,” set the zoom transition speed (specifying the time to be taken for the zoom moving from the TELE end to the WIDE end at a certain speed).

The setting range is from 1 to 10. The larger the number you set, the higher speed.

### Time/Speed

Set whether to specify the duration of a transition by time or by speed of zoom transition.

Setting	Contents
Time	The “Transition Time” setting is valid.
Speed	The “Transition Speed” setting is valid.

### Trans Curve

Select the transition pattern.

The corresponding icon is displayed in the shot transition information area.

Setting and icon	Contents
	To make the transition linearly.

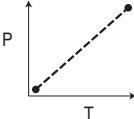

Setting and icon	Contents
	Soft Trans To make the transition slowly at the beginning and end but linearly in between.

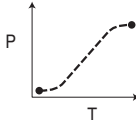

	Soft Stop To make the transition slowly near the end.
---	---

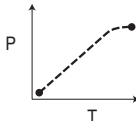

P: Parameter level T: Transition of time

### Start Timer

Set the time from start of recording to start of the shot transition.

The countdown indication is displayed in the shot-transition information area until the shot transition is started by the Start Timer.

### Rec Link

Set whether to link shot-transition start and target shot selection to recording start.

The setting status is displayed in the shot transition information area.

**Off:** Not to link to recording start

(To use the A or B button to start the transition and specify the target shot)

**Shot-A:** To start the transition to Shot A in synchronization with recording start

**Shot-B:** To start the transition to Shot B in synchronization with recording start

## 3 Exit the menu to finish the settings.

### Registering a shot

You can register two kinds of shots: A and B.

**1 Press the MODE button to display “Store” in the shot-transition operation area.**

**2 Adjust the camera settings to obtain an image you wish to register.**



### 3 When adjustment is finished, press the Shot A or Shot B button.

The camera settings are registered to the pressed button.

The registered camera settings are maintained until you register them next.

## Checking the registered settings (Shot)

- 1 Press the MODE button to display “Check” in the shot-transition operation area.
- 2 Press the A or B button, whichever you assigned to the shot you wish to check.

The selected shot (camera settings or conditions) takes effect on the picture on the screen.

With this operation, you cannot check the conditions of the transition.

## Recording with a Shot Transition

When the preparatory settings are completed, you can start recording.

Operations differ depending the “Rec Link” setting.

## Making a transition from the current picture to a registered shot

- 1 Adjust the camera settings to obtain an image with which you wish to start recording.
- 2 Press the MODE button to display “Execute” in the shot-transition operation area.
- 3 Press the REC START/STOP button.  
Recording begins.
- 4 When “Rec Link” is “Off,” press the button of the target shot (A or B) when you wish to start the shot transition.  
The current camera settings are gradually shifted to those registered to the specified shot.

When “Rec Link” is “Shot-A” or “Shot-B,” the camcorder automatically performs the shot transition to the camera settings registered to Shot A or Shot B, respectively. You need not press the button.

### Notes

- You cannot return to the status in step 1 once after you start the shot transition. If the status must be resumed, register it as a shot.
- When you perform recording on an external device connected via the i.LINK(HDV) connector in synchronization with REC START/STOP operations on this camcorder, recording start on the external device and shot-transition start may not be synchronized even if “Rec Link” has been set to “Shot-A” or “Shot-B,” depending on the performance of the external device.

## Making a transition from Shot A to Shot B

When “Rec Link” is set to “Off” or “Shot-B,” a shot transition from Shot A to Shot B is possible.

- 1 Press the MODE button to display “Check” in the shot-transition operation area.
- 2 Press the A button.  
The picture is adjusted according to the camera settings registered for Shot A.
- 3 Press the MODE button to display “Execute” in the shot-transition operation area.
- 4 Press the REC START/STOP button.  
Recording begins with the camera settings registered for Shot A.
- 5 When “Rec Link” is “Off,” press the B button when you wish to start the shot transition.  
When “Rec Link” is “Shot-B,” the camcorder automatically performs the shot transition to the camera settings registered for Shot B. It is not necessary to press the B button.

## Making a transition from Shot B to Shot A

When “Rec Link” is set to “Off” or “Shot-A,” a shot transition from Shot B to Shot A is possible.

- 1 **Press the MODE button to display “Check” in the shot-transition operation area.**
- 2 **Press the B button.**  
The picture is adjusted according to the camera settings registered for Shot B.
- 3 **Press the MODE button to display “Execute” in the shot-transition operation area.**
- 4 **Press the REC START/STOP button.**  
Recording begins with the camera settings registered for Shot B.
- 5 **When “Rec Link” is “Off,” press the A button when you wish to start the shot transition.**  
When “Rec Link” is “Shot-A,” the camcorder automatically performs the shot transition to the camera settings registered for Shot A. It is not necessary to press the A button.

## Ending recording

When recording is completed, press the REC START/STOP button.

### To cancel recording while a transition is in progress

If you press the REC START/STOP button during recording, the recording stops, even when a shot transition is in progress.

The E-E picture of the settings where the recording stops is displayed.

## Releasing a Shot Transition

Press the MODE button so that the button indicator goes dark.

The viewfinder screen resumes the normal condition.

## Fader Function

Using the Fader function, you can start a recording by fading in a scene or end a recording by fading out of a scene.

The fader function can be assigned to an assignable button.

For function assignment, see “Changing Functions of the Assignable Buttons” on page 72.

### Notes

- The fader function cannot be used in combination with the Slow & Quick Motion, Interval Recording, Frame Recording, or EX Slow Shutter function.
- When a clip is recorded using the fade-in function, a white or black screen becomes the index frame on the thumbnail screen (*page 93*). Change the index frame for easier identification.
- When you perform recording on an external device connected via the i.LINK(HDV) connector in synchronization with REC START/STOP operations on this camcorder, recording start/stop on the external device and fade-in start/fade-out end may not be synchronized, depending on the performance of the external device.

## Preparatory Settings

Specify the conditions to activate the Fader function in advance with the following procedure:

- 1 **Select “Fader” of the CAMERA SET menu.**

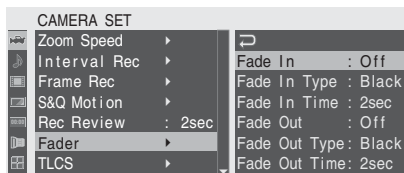

- 2 **Specify the fade-in conditions.**

**Fade In**

Set this to “On” to start recording with fade in.

(When you operate the function using an assignable button, it is not necessary to set “Fade In” to “On” with the menu.)

**Fade In Type**

Select the initial status of the fade-in.

**White:** To fade in from a white screen

**Black:** To fade in from a black screen

**Fade In Time**

Set the duration (1/2/3/5/10 sec.) of fade-in.

**3 Specify the fade-out conditions.****Fade Out**

Set this to “On” to end recording with fade out.

(When you operate the function using an assignable button, it is not necessary to set “Fade Out” to “On” with the menu.)

**Fade Out Type**

Select the final status of the fade-out.

**White:** To fade out to a white screen

**Black:** To fade out to a black screen

**Fade Out Time**

Set the duration (1/2/3/5/10 sec.) of fade-out.

**4 Exit the menu.**

- If you set “Fade In” to “On” with the menu, the camcorder enters Fade-in standby status when you exit the menu.
- When the Fader indication on the screen is active, the initial status (“White Fader” or “Black Fader”) you set with “Fade In Type” flashes.

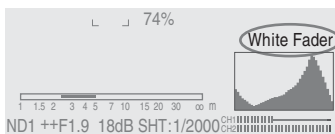
**When using an assignable button**

If you assigned the Fader function to an assignable button, the Fade In/Fade Out On/Off settings can be made using the button.

**For fading in a scene**

Press the ASSIGN button to which you assigned the Fader function in STBY (recording standby) status.

The fade-in function is turned on.

**For fading out**

Press the ASSIGN button to which you assigned the Fader function during recording.

The camcorder enters in the fade-out standby status.

**Starting Recording with a Fade In**

When the preparatory settings are completed, you can start recording.

**Press the REC START/STOP button.**

Recording begins by fading in the camera picture.

When the fade-in process you specified is completed, the camcorder enters Normal Recording mode.

The Fade-In Type indication flashes during the fade-in process and goes off when the process ends.

**Ending Recording with a Fade Out**

- If you set “Fade Out” to “On” with the menu, the camcorder automatically enters Fade-out standby status when it is set to Recording mode.
- When you press the ASSIGN button to which you assigned the Fader function after starting recording, the camcorder enters fade-out standby status.

**Press the REC START/STOP button to start fading out of the camera picture.**

The fading-out process begins.

When the fading-out process you specified is completed, recording simultaneously stops. The Fade-Out Type indication flashes during the fade-out process and goes off when the process ends.

**Canceling the Fader function**

Set “Fade In” and “Fade Out” to “Off” with the menu.

Or press the ASSIGN button again.

### Note

The Fade In/Fade Out settings automatically return to “Off” when you turn off the camcorder, while the Type and Time settings set with the menu are maintained.

## Picture Profiles

You can customize the picture quality, depending on the conditions or circumstances of recording, and store them as a picture profile, enabling the picture quality to be resumed just by your selecting the picture profile.

Six different picture profiles (PP1 to PP6) can be stored in memory.

The same standard (reference) values are registered to six picture profiles at the factory as those specified for the Picture Profile Off status. The PICTURE PROFILE menu is available for picture-profile operations.

### Note

The picture profiles can be operated only in Camera mode. They cannot be operated in Media mode.

When the RM-B750/B150 Remote Control Unit is connected, the picture profiles can be adjusted from the RM-B750/B150.

*For details, see “Operating From the RM-B750/B150” on page 136.*

## Registering the Customized Settings as a Picture Profile

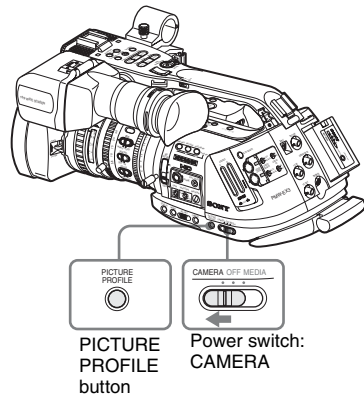

- 1 Set the power switch to **CAMERA** to turn the camcorder on in **Camera mode**.
- 2 Press the **PICTURE PROFILE** button.  
The **PICTURE PROFILE** menu is displayed.
- 3 Operating the jog dial or the joystick, select **“SEL”** from the **PICTURE PROFILE** menu then select the picture profile number (**PP1** to **PP6**) to operate.

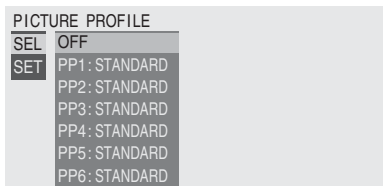

- 4 Operating the jog dial or the joystick, select **“SET”** and make the settings of the picture profile items.

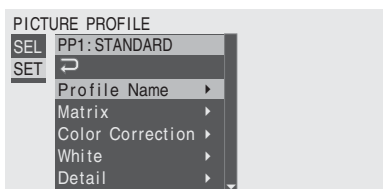

For details on the setting items, see “Picture Profile Items” on page 87.

- 5 When the settings are completed, press the **PICTURE PROFILE** button to exit the menu.

## Selecting a Picture Profile

### Selecting a Picture Profile using the PICTURE PROFILE menu

Once you store a picture profile, you can call the picture quality registered in the picture profile as follows:

- 1 Set the power switch to **CAMERA** to turn the camcorder on in **Camera mode**.
- 2 Press the **PICTURE PROFILE** button.

The **PICTURE PROFILE** menu is displayed.

- 3 Operating the jog dial or the joystick, select **“SEL”** then the desired picture profile from the list.

**Example:**

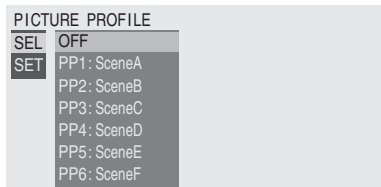

The camcorder is adjusted to the picture quality specified by the selected Profile. (If you select **“OFF”**, the camcorder will be fixed at the standard picture quality, and no picture adjustment is allowed.)

- 4 Press the **PICTURE PROFILE** button to exit the menu.

### Selecting a Picture Profile using the Direct menu

The picture profile being selected is displayed when you press the **DISPLAY/BATT INFO** button.

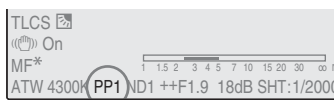

You can select picture profiles with the **Direct** menu by operating the joystick or the jog dial.

For details on the **Direct** menu, see “Direct Menu Operation” on page 24.

### Copying the Settings of a Picture Profile

You can copy the settings of a selected picture profile to another picture profile.

- 1 Select the source picture profile by proceeding from step 1 to 3 of “Selecting a Picture Profile using the **PICTURE PROFILE** menu” on page 85.

**2 Select “Copy” from “SET” of the PICTURE PROFILE menu.**

The picture profile numbers are listed on the screen.

**3 Specify the target picture profile.**

“Execute” and “Cancel” are displayed.

**4 Select “Execute.”**

Copying begins.

When copying ends, the completion message is displayed for three seconds, and the original screen display is restored.

## Resetting a Picture Profile

You can reset a selected picture profile to the factory settings (standard status).

**1 Select the picture profile you wish to reset by proceeding from step 1 to 3 of “Selecting a Picture Profile using the PICTURE PROFILE menu” on page 85.**

**2 Select “Reset” from “SET” of the PICTURE PROFILE menu.**

“Execute” and “Cancel” are displayed.

**3 Select “Execute.”**

Resetting begins.

When resetting ends, the completion message is displayed for three seconds, and the original screen display is restored.

## Picture Profile Items

The values when “Off” is selected at “SEL” of the PICTURE PROFILE menu are shown in bold face (example: **Standard**).

PICTURE PROFILE SET		
Items	Subitems and setting values	Contents
<b>Profile Name</b> Changing the picture profile name	Profile name	Set the profile name in 8 characters at maximum. You can use upper- and lowercase alphabets, numerics 0 to 9, - (hyphen), _ (underscore) and space.
	<b>Matrix</b> Adjusting the color phase over the entire area with matrix operations	Setting <b>On / Off</b>
	Select <b>Standard</b> /High SAT / FL Light / Cinema	Select the built-in preset matrix provided for convenience.
	Level -99 to +99 ( <b>±0</b> )	Adjust the color saturation for the entire picture area.
	Phase -99 to +99 ( <b>±0</b> )	Adjust the hue for the entire picture area.
	R-G, R-B, G-R, G-B, B-R, B-G -99 to +99 ( <b>±0</b> )	Finely adjust the color phase for the entire picture area by independently setting each of the factors.
<b>Color Correction</b> Adjusting the color phase in a specific area	Setting <b>On / Off</b>	Set to “On” to enable the color phase adjustment for a specific area. (Simultaneous adjustment of multiple areas is not allowed. You can adjust it for one area only.)
	Area Detection <sup>1)</sup> Execute/Cancel	Execute to detect the color in the center of the screen. The area centering around the detected color of the range specified by “Target Width” becomes the target area of Color Correction.
	Area Indication <sup>2)</sup> <b>On / Off</b>	Set to “On” to display the Zebra 1 pattern for the target area of Color Correction.
	Target Phase 0 to 359 ( <b>130</b> )	Manually adjust the center color for the target area for Color Correction.  <b>Note</b> When Area Detection is executed, this setting is overwritten by the Area Detection result. Perform fine adjustment with this item as required.
	Target Width 0 to 90 ( <b>40</b> )	Set the width of color phase for the target area for Color Correction.
	Level -99 to +99 ( <b>±0</b> )	Set the saturation for the color in the target area.
	Phase -99 to +99 ( <b>±0</b> )	Adjust the hue for the color in the target area.

**PICTURE PROFILE SET**

<b>Items</b>	<b>Subitems and setting values</b>	<b>Contents</b>
<b>White</b> Setting the white balance offset and the color temperature of the preset white	Offset White <b>On / Off</b>	Set to "On" to shift the conversion value for auto white balance in Memory A or B mode and that for auto tracing white in ATW mode to a lower color temperature or a higher color temperature.
	Offset<A> -99 to +99 ( <b>±0</b> )	Adjust the volume of the offset white (shifting volumes) of the conversion value in Memory A, Memory B, or ATW mode, respectively.
	Offset<B> -99 to +99 ( <b>±0</b> )	
	Offset<ATW> -99 to +99 ( <b>±0</b> )	
Preset White 2100 to 10000 ( <b>3200</b> )	Adjust the preset color temperature when Preset white balance mode is selected in steps of 100K.	
<b>Notes</b>		
<ul style="list-style-type: none"> <li>• Except when the white balance is in Memory A or B mode or when ATW is active, you cannot confirm the result of changing the Offset White and Offset settings on the screen.</li> <li>• Except when Preset white balance mode is selected, you cannot confirm the result of changing the Preset White settings on the screen.</li> </ul>		
<b>Detail</b> Adjusting the details to be applied to the picture	Setting <b>On / Off</b>	Set to "On" to apply the details to the video signal.
	Level -99 to +99 ( <b>±0</b> )	Adjust the detail level.
	Frequency -99 to +99 ( <b>±0</b> )	Set the center frequency of the details. Setting the center frequency higher decreases the details, and setting it lower increases the details.
	Crispening -99 to +99 ( <b>±0</b> )	Adjust the noise-suppression level. When you set it to a higher level, less noise may be seen, as fine elements of details are deleted leaving only high-level elements. When you set it to a lower level, fine elements are applied while increasing noise.
	H/V Ratio -99 to +99 ( <b>±0</b> )	Adjust the horizontal-to-vertical ratio of detail elements. A higher value makes the vertical elements increased with respect to the horizontal elements.
	White Limiter -99 to +99 ( <b>±0</b> )	Limit the white details.
	Black Limiter -99 to +99 ( <b>±0</b> )	Limit the black details.
	V DTL Creation NAM / Y / G / G+R	Select the source signal to generate vertical details from among NAM (G or R whichever is higher), Y, G, and G+R.
	Knee APT Level -99 to +99 ( <b>±0</b> )	Adjust the knee aperture level (level of details to be applied to the sections above the knee point).



**PICTURE PROFILE SET**

Items	Subitems and setting values	Contents
<b>Skin Tone Detail</b> Adjusting the details to be applied to the areas of a specific color phase	Setting On / <b>Off</b>	Set to “On” to enable the detail level adjustment for specific color-phase areas. The detail level is uniform over the entire picture with the Off setting.
	Level -99 to +99 ( <b>±0</b> )	Adjust the skin-tone detail level.
	Area Detection <sup>1)</sup> Execute/Cancel	Execute to detect the color in the center of the screen. The area centering around the detected color becomes the target area for Skin Tone Detail control.
	Area Indication <sup>2)</sup> On / <b>Off</b>	Set to “On” to display the Zebra 1 pattern for the target area for Skin Tone Detail control.
	Saturation -99 to +99 ( <b>±0</b> )	Adjust the color (saturation) level for Skin Tone Detail control.  <div style="background-color: #cccccc; padding: 2px;"><b>Note</b></div> When Area Detection is executed, this setting is automatically returned to 0.
	Phase 0 to 359 ( <b>130</b> )	Adjust the center color-phase value for the target area for Skin Tone Detail control.  <div style="background-color: #cccccc; padding: 2px;"><b>Note</b></div> When Area Detection is executed, this setting is automatically changed to the value equivalent to that of the detected color.
	Width 0 to 90 ( <b>40</b> )	Adjust the width of the color phase of the target area for Skin Tone Detail control.  <div style="background-color: #cccccc; padding: 2px;"><b>Note</b></div> When Area Detection is executed, the Width setting automatically returns to 40.
<b>Knee</b> Adjusting the knee level	Setting On / <b>Off</b>	Set to “On” to compress the high-luminance area of the picture.  <div style="background-color: #cccccc; padding: 2px;"><b>Note</b></div> Knee is fixed and cannot be changed in the following cases:
		<ul style="list-style-type: none"> <li>• When Gamma is set to CINE1 to 4</li> <li>• When the electronic shutter is in SLS mode</li> <li>• When EX Slow Shutter is active</li> </ul>
	Auto Knee On / <b>Off</b>	Set to “On” to automatically set the best knee conditions according to the luminance level of the picture. With “Off” the knee conditions can be manually adjusted independently of the luminance level of the picture.
	Point 50 to 109 ( <b>90</b> )	Set the knee point when Auto Knee is “Off.”
	Slope -99 to +99 ( <b>±0</b> )	Set the knee slope (volume of compression) when Auto Knee is “Off.”
	Knee SAT Level 0 to 99 ( <b>50</b> )	Adjust the knee saturation level for the area over the knee point.

PICTURE PROFILE SET		
Items	Subitems and setting values	Contents
<b>Gamma</b> Adjusting the gamma compensation level and selecting the gamma curve	Level –99 to +99 ( $\pm 0$ )	Adjust the gamma compensation level.
	Select <sup>3)</sup> STD1 / STD2 / <b>STD3</b> / STD4 / CINE1 / CINE2 / CINE3 / CINE4	Select the type of reference curve for gamma compensation.
<b>Black</b> Adjusting the black	–99 to +99 ( $\pm 0$ )	Adjust the master black level.
<b>Black Gamma</b> Adjusting the black gamma level	–99 to +99 ( $\pm 0$ )	Adjust the level of black gamma function that emphasizes only the dark areas of the picture to clear the tones or on the contrary de-emphasizes it to reduce noise.
<b>Low Key SAT</b> Adjusting the low key saturation	–99 to +99 ( $\pm 0$ )	Adjust the level of the low key saturation to heighten the colors only in the dark areas of the picture or pale them to reduce noise.
<b>Copy</b> Copying a picture profile	Execute / Cancel	Select “Execute” to copy.
<b>Reset</b> Resetting a picture profile	Execute / Cancel	Select “Execute” to reset.

1) To execute “Area Detection”

### 1. Select “Area Detection.”

A square marker that indicates the detection area appears in the center of the screen, and “Execute” and “Cancel” are displayed below.

### 2. Select “Execute.”

Color-phase detection in the marker area is performed.

When detection successfully ends, a completion message is displayed. Then the screen is restored, on which the target area for the Color Correction or Skin Tone Detail adjustment is changed to the area centering around the color detected by “Area Detection,” and the Area Indication (zebra pattern) appears.

If detection fails, an error message appears, then the precious screen is restored.

2) The Area Indication setting is common to all picture profiles PP1 to PP6.

3) Available gamma curves

STD1: This deemphasizes the contrast in dark areas more than STD2 and emphasizes the contrast in intermediate areas.

STD2: This deemphasizes the contrast in dark areas more than STD3.

STD3: Standard (factory setting)

STD4: This emphasizes the contrast in dark areas more than STD3.

CINE1: This smoothes the contrast in darker areas and accentuates gradation changes in brighter areas, for a calm and quiet effect.

CINE2: This gives almost the same results as CINE1. Select this when you wish to obtain 100% video signals for editing or other purposes.

CINE3: This emphasizes the contrast between light and dark more than CINE1 and CINE2, and also accentuates gradation changes on the black side.

CINE4: This emphasizes the contrast in dark areas more than CINE3. Contrast in dark areas is weaker and contrast in bright areas is stronger than STD curves.

## Deleting Clips

In Camera mode, the Last Clip DEL function for deleting the last recorded clip and the All Clips DEL function for deleting all clips from a memory card are available.

In Media mode, you can specify the clip to be deleted.

For clip deletion in Media mode, see “Deleting a Clip” on page 101.

### Deleting the Last Recorded Clip

Using the assignable button to which you assigned the Last Clip DEL function or the Setup menu, the last recorded clip is easily deleted.

#### To delete using the assignable button

Assign the Last Clip DEL function to one of the assignable buttons (see page 72) in advance.

- 1 Press the assignable button to which you have assigned “Last Clip DEL.”**  
The confirmation message is displayed.
- 2 Operating the joystick or the jog dial, select “Execute.”**  
The last recorded clip is deleted from the memory card.

#### To delete using the Setup menu

- 1 Select “Last Clip DEL” from “Clip” of the OTHERS menu.**

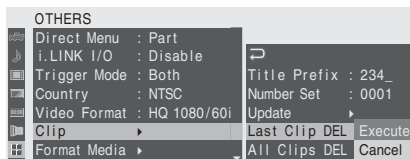

- 2 Select “Execute.”**  
The confirmation message is displayed.

- 3 Select “Execute” again.**

The last recorded clip is deleted from the memory card.

For details on menu operations, see “Basic Menu Operations” on page 111.

### Deleting All Clips

Using the Setup menu, you can delete all recorded clips from the memory card in the selected card slot.

- 1 Select “All Clips DEL” from “Clip” of the OTHERS menu.**
- 2 Select “Execute.”**  
The confirmation message is displayed.
- 3 Select “Execute” again.**  
All the clips are deleted from the memory card.

#### Note

Clips with the OK mark applied cannot be deleted.

For details on the OK mark, see “Adding the OK Mark to a Clip” on page 100.

## Storing/Retrieving the Setting Data

You can store all the menu settings (including picture profiles) as a setup file on an SxS memory card.

By retrieving the stored setup file, the proper setup condition can be immediately obtained. For the setup file operations, use “Camera Data” of the OTHERS menu.

### Note

The Clock Set, Time Zone, Hours Meter (page 125) values are excluded.

## Storing the Setup File

Only one setup file can be stored on one SxS memory card.

### 1 Insert a memory card on which you wish to store the setup file to a card slot.

Check that the corresponding memory card icon is displayed on the screen. If a memory card in the other slot is selected, press the SLOT SELECT button to switch.

### 2 Select “Camera Data” from the OTHERS menu.

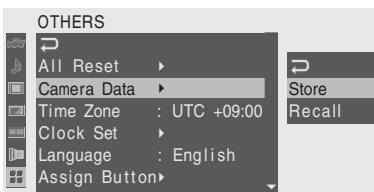

### 3 Select “Store.”

“Cancel” and “Execute” appear to the right.

### 4 Select “Execute.”

Writing of data to the memory card begins.

An in-progress message is displayed during writing. When writing is completed, a completion message is displayed.

### Notes

- If a setup file already exists on the memory card you specified in step 1, a message to confirm whether to overwrite the file is displayed.
- If there is not sufficient space on the memory card, an error message is displayed.

## Retrieving the Setup File

When you retrieve the stored setup file, the camcorder settings are changed according to the file.

### 1 Insert the memory card on which you stored the setup file into a card slot.

Check that the corresponding memory card icon is displayed on the screen. If a memory card in the other slot is selected, press the SLOT SELECT button to switch.

### 2 Select “Camera Data” from the OTHERS menu.

### 3 Select “Recall.”

“Cancel” and “Execute” appear to the right.

### 4 Select “Execute.”

Reading of data from the memory card begins.

An in-progress message is displayed during data reading. When the read-out is completed, a completion message is displayed, indicating that the camcorder settings have been changed according to the setup file.

## Resetting to the Standard Values

The current camcorder settings you made through various menu and button operations can be collectively returned to the standard statuses (factory settings) by executing “All Reset” of the OTHERS menu.

## Playing Back Clips

Turning the camcorder on with the power switch set to MEDIA sets it to Media mode, and the clips recorded on the SxS memory card are displayed as thumbnails on the screen. (If no clips are recorded on the card, a no-clip message is displayed.)

You can start playback from the clip selected on the thumbnail screen.

The playback picture can be seen in the viewfinder and external monitors.

For connection of external monitors, see "Connecting External Monitors" on page 128.

### Thumbnail Screen

The index frame images of the clips on the SxS memory card are displayed as thumbnails. The recording date and starting time are displayed below the index image of each clip. (The OK mark symbol is displayed if the clip is marked.)

#### Clip index frame

The first frame is automatically specified as the index frame of a clip when recorded. You can change it to another one as required (see page 104).

The icon of the current memory card is highlighted, shading the nonselected one. (If the card is write-protected, a lock icon is displayed to the left.)

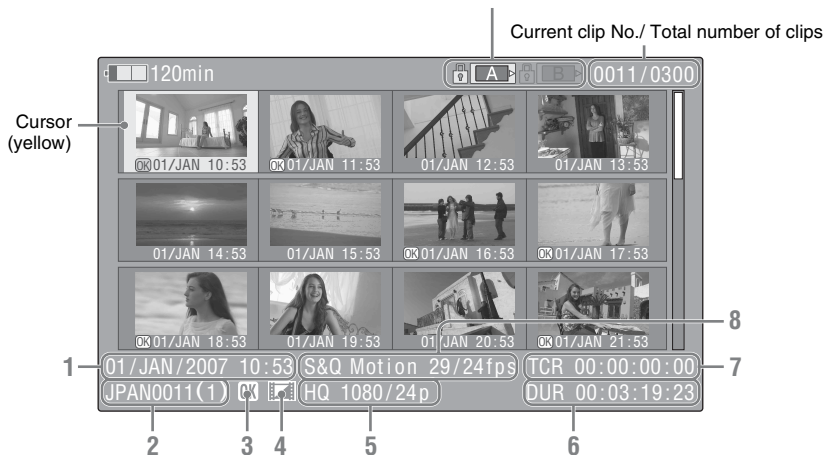

Data for the clip at the cursor are displayed in 1 to 8.

**1. Date and starting time of recording**

**2. Clip name**

**3. OK mark**

Displayed only if the selected clip is marked OK (page 100).

**4. AV independent file icon**

Displayed if the selected clip is an AV independent file. This indicates that the clip is

an AV independent file, such as those added to the memory card using a computer. Not all operations and indications may be available for such clips.

**5. Recording video format**

**6. Duration of the clip**

**7. Timecode**

The timecode of the index frame is displayed.

## 8. Special recording information

If the selected clip was recorded in a special recording mode (S&Q Motion, Interval Rec, or Frame Rec), the mode is displayed.

For a clip recorded in S&Q Motion mode, [recording frame rate/playback frame rate] fps is displayed to the right.

### Switching the SxS memory cards

When two memory cards are loaded, press the SLOT SELECT button to switch memory cards.

#### Note

In Media mode, card switching is enabled only when the thumbnail screen is displayed or when an external input picture is displayed by pressing the STOP button.

You cannot switch memory cards during playback.

### Displaying only the clips marked OK on the thumbnail screen

Press the THUMBNAIL button.

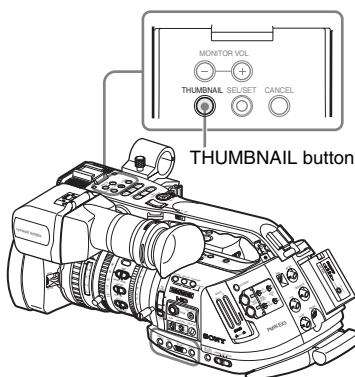

The thumbnail screen changes such that it contains only the clips marked OK among the clips on the current memory card. To return to the thumbnail screen with all the clips, press the THUMBNAIL button again.

For operations of the OK mark, see "Adding the OK Mark to a Clip" on page 100.

## Playback

For playback operations, use the playback control buttons on the handle.

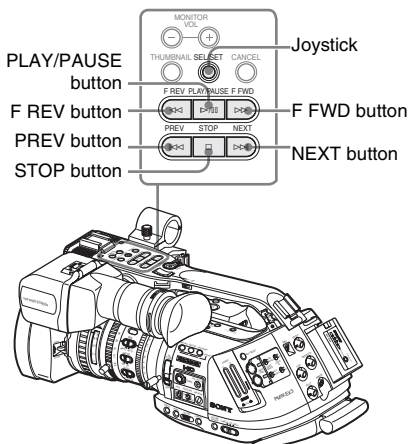

- When the IR Remote Commander is enabled, you can use its playback control buttons instead (see page 39).
- Functions of the playback control buttons are occasionally assigned to the joystick (see page 95).
- The jog dial is also valid when you move the cursor on the thumbnail screen or proceed to the next step of operations.

### Playing back the selected and subsequent clips in sequence

- 1 Operating the joystick or the jog dial, move the cursor to the thumbnail image of the clip with which you wish to start playback.**
- 2 Press the PLAY/PAUSE button.**  
Playback starts from the beginning of the selected clip.

The clips after the selected clips are played back in sequence.

When playback of the last clip ends, the camcorder enters PAUSE (still picture) mode at the last frame of the last clip.

Press the THUMBNAIL button to return to the thumbnail screen.

### Notes

- The playback picture may be momentarily distorted or frozen between clips. The playback control buttons and THUMBNAIL button do not function during this condition.
- When you select a clip on the thumbnail button and start playback, the playback picture at the beginning of the clip may be distorted. To start playback without distortion, once pause playback after starting it, press the PREV button to return to the top of the clip, then restart playback.

## Information displayed on the playback screen

The following information is superimposed on the playback picture.

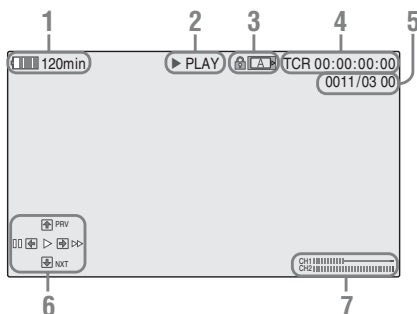

### 1. Battery remaining/DC IN voltage

### 2. Playback mode

### 3. SxS memory card in use

A mark appears if the memory card is write-protected.

### 4. Time data

The time data for the playback picture are displayed. Each time you press the TC/U-BIT/DURATION button, the indication is switched between timecode (TCR) and user-bit (UB) data.

### 5. Clip no./total number of clips on the memory card

### 6. Joystick operation guidance area

The functions assigned to the joystick in the current condition are displayed.

## Display example (Playback mode):

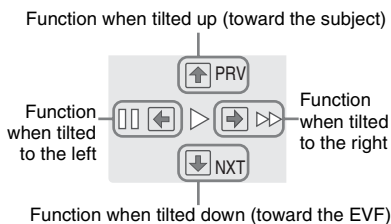

Guide marks	Functions
▶▶▶▶	4-times playback in forward direction
▶▶▶▶▶▶	15-times playback in forward direction
◀◀◀◀	4-times playback in reverse direction
◀◀◀◀◀◀	15-times playback in reverse direction
▶	Normal playback
	Pause
PRV	Jump to the top of the current clip
NXT	Jump to the top of the next clip

## 7. Audio levels

The audio levels in recording are displayed.

## Pausing the playback

Press the PLAY/PAUSE button.

The playback is restarted by pressing the button again.

## Switching to high-speed playback

The camcorder permits you to play clips at 4 times or 15 times normal speed in the forward or reverse direction. Audio is muffled in high-speed playback.

### To play at a high speed in the forward direction

Press the F FWD button.

Each time you press the button, the playback speed switches between 4 times and 15 times normal speed.

### To play at a high speed in the reverse direction

Press the F REV button.

Each time you press the button, the playback speed switches between 4 times and 15 times normal speed.

### To return to normal playback

Press the PLAY/PAUSE button.

---

## Cueing up

---

### To return to the top of the current clip

Press the PREV button.

- When you press the button in normal or fast-forward playback, the top of the current clip is cued up then playback begins.
- When you press the button in fast-reverse playback or in Pause mode, the top of the current clip is cued up, then the still picture is displayed.
- Repeated pressing of the button cues up the previous clips one by one.

### To start playback from the top of the first clip

Press the PREV button and F REV button simultaneously. The top of the first-recorded clip on the memory card is cued up.

### To jump to the top of the next clip

Press the NEXT button.

- When you press the button in normal or fast-forward playback, the top of the next clip is cued up then playback begins.
- When you press the button in fast-reverse playback or in Pause mode, the top of the next clip is cued up, then the still picture is displayed.
- Repeated pressing of the button cues up the subsequent clips one by one.

### To start playback from the top of the last clip

Press the F FWD button and NEXT button simultaneously. The top of the last-recorded clip on the memory card is cued up.

---

## Monitoring audio

---

In Normal playback mode, you can monitor the recorded audio signals through the built-in speaker or connected headphones.

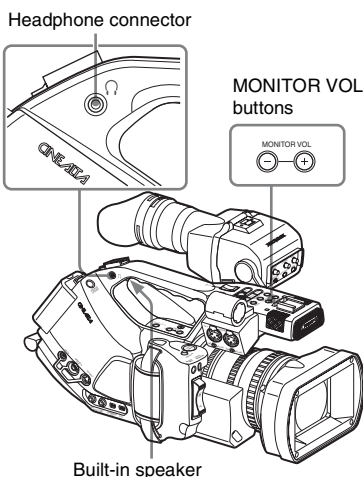

With the headphones connected to the headphone jack, the built-in speaker is turned off.

Press the MONITOR VOL buttons to adjust the sound volume.

The level bar is displayed during adjustment.

You can select audio channel(s) to be monitored with “Audio Output” (*page 118*) of the AUDIO SET menu.

---

## Adding shot marks during playback

---

In the same manner as in recording, you can add shot marks to the clip during playback.

**At the point where you wish to add a shot mark, press the “Shot Mark1” or “Shot Mark2” assigned button, or the SHOTMARK 1 or 2 button on the IR Remote Commander.**

### Notes

- No shot mark can be added if the memory card is write-protected.
- No shot mark can be added to the first or last frame of a clip.

---

## Stopping playback

---

You can stop playback with either of the following operations:

**Press the THUMBNAIL button.**

Playback mode is canceled, restoring the thumbnail screen.



**Press the STOP button.**

Playback mode is canceled, showing any external input or a blue screen.

To display the thumbnail screen, press the THUMBNAIL button.



# Clip Operations

In Media mode, you can operate the clips or confirm and change the subsidiary data for clips using the Clip Operation menus.

The corresponding Clip Operation menu pops up on the screens as shown below.

## Clip Operation Menus

### Thumbnail screen (*page 99*)

- CANCEL
- DISP CLIP INFO
- OK MARK ADD
- OK MARK DEL
- COPY CLIP
- DELETE CLIP
- SHOT MARK
- SHOT MARK1
- SHOT MARK2
- EXPAND CLIP

### Still picture in Pause mode (*page 99*)

- CANCEL
- DISP CLIP INFO
- OK MARK ADD
- SHOT MARK1 ADD
- SHOT MARK2 ADD
- EXPAND CLIP

### EXPAND CLIP screen (*page 102*)

- CANCEL
- EXPAND (COARSE)
- EXPAND (FINE)
- PAUSE
- SET INDEX PIC
- SHOT MARK1 ADD
- SHOT MARK2 ADD
- SHOT MARK1 DEL
- SHOT MARK2 DEL
- DIVIDE CLIP

### SHOT MARK screen (*page 103*)

- CANCEL
- PAUSE
- SET INDEX PIC
- SHOT MARK1 DEL
- SHOT MARK2 DEL
- DIVIDE CLIP

## Basic Operations of the Clip Operation Menus

### Displaying a Clip Operation menu

Press the joystick or the jog dial.  
The Clip Operation menu for the current display pops up.

### Selecting a Clip Operation menu item

Turn the jog dial or tilt the joystick to select a menu item then press the jog dial or the joystick. Pressing the CANCEL button restores the previous condition.

Selecting “CANCEL” from a Clip Operation menu turns the Clip Operation menu off.

#### Notes

- When the SxS memory card is write-protected, you cannot copy/delete/divide clips, change the index frames, and add/delete the OK and shot marks.
- There may be items that cannot be selected depending on the status when the menu is displayed.

### Clip Operation menu on the thumbnail screen

Pressing the joystick or the jog dial with the thumbnail screen (*page 93*) displayed calls the Clip Operation menu for the clip at the cursor.

Item	Function
DISP CLIP INFO	To display the CLIP INFO screen for the clip ( <i>page 100</i> )
OK MARK ADD	To add the OK mark to the clip ( <i>page 100</i> )
OK MARK DELETE	To delete the OK mark from the clip ( <i>page 100</i> )
COPY CLIP	To copy the clip to another SxS memory card ( <i>page 101</i> )
DELETE CLIP	To delete the clip ( <i>page 101</i> )
SHOT MARK	To display thumbnails only of the frames with shot mark 1 and/or shot mark 2 recorded ( <i>page 102</i> )
SHOT MARK1	To display thumbnails only of the frames with shot mark 1 recorded ( <i>page 102</i> )

Item	Function
SHOT MARK2	To display thumbnails only of the frames with shot mark 2 recorded ( <i>page 102</i> )
EXPAND CLIP	To display the EXPAND CLIP screen ( <i>page 101</i> ) for the clip

### Clip Operation menu in Pause mode

Pressing the joystick or the jog dial with a still picture displayed in Pause mode calls the Clip Operation menu for the clip in Pause mode.

Item	Function
DISP CLIP INFO	To display the CLIP INFO screen for the clip ( <i>page 100</i> )
OK MARK ADD	To add the OK mark to the clip ( <i>page 100</i> )
SHOT MARK1 ADD	To add shot mark 1 ( <i>page 102</i> )
SHOT MARK2 ADD	To add shot mark 2 ( <i>page 102</i> )
EXPAND CLIP	To display the EXPAND CLIP screen ( <i>page 101</i> ) for the clip

## Displaying the Detailed Information of a Clip

When you select “DISP CLIP INFO” from a Clip Operation menu, the CLIP INFO screen appears.



Playback

### 1. Image of the current clip

### 2. Image of the previous clip

Press the PREV button to switch to the CLIP INFO screen of the previous clip.

### 3. Image of the next clip

Press the NEXT button to switch to the CLIP INFO screen of the next clip.

### 4. Clip name

### 5. OK mark

Displayed only when the selected clip is marked OK.

### 6. Date and starting time of recording

### 7. Recording format

### 8. Special recording information

If the selected clip was recorded in a special recording mode (S&Q Motion, Interval Rec, or Frame Rec), the mode is displayed.

For a clip recorded in S&Q Motion mode, [recording frame rate/playback frame rate] fps is displayed to the right.

### 9. Timecode of the displayed frame

### 10. Timecode at the recording starting point

### 11. Timecode at the recording ending point

### 12. Duration of the clip

### 13. Recorded audio channels

## Adding the OK Mark to a Clip

By adding the OK mark to clips, you can obtain a thumbnail screen of only the marked clips when you press the THUMBNAIL button.

Clips with the OK mark cannot be deleted or divided. To delete or divide the clip, remove the OK mark.

### Adding the OK mark

- 1 Select “OK MARK ADD” from the Clip Operation menu.

The CLIP INFO screen for the clip appears and a confirmation message appears below the index frame.

- 2 Select “Execute,” and press the jog dial or the joystick.

The OK mark is applied to the selected clip.

### Deleting the OK mark

For a clip already marked with OK, the Clip Operation menu of the thumbnail screen permits you to select “OK MARK DEL.”

## 1 Select “OK MARK DEL” from the Clip Operation menu.

The information screen for the selected clip appears, and a confirmation message is displayed below the index frame image.

## 2 To delete, select “Execute” then press the jog dial or the joystick.

The OK mark is deleted from the selected clip.

## Copying a Clip

You can copy a clip selected on the thumbnail screen to another SxS memory card.

### 1 On the thumbnail screen of the current memory card, select the clip you wish to copy then press the joystick or the jog dial.

The Clip Operation menu of the thumbnail screen pops up.

### 2 Select “COPY CLIP” from the Clip Operation menu.

The information screen of the selected clip appears, and a confirmation message is displayed below the index frame image.

### 3 To copy, select “Execute” then press the jog dial or the joystick.

Copying begins.

The clip is copied with the same name to the destination SxS memory card.

An execution message and an in-progress bar are displayed during copying.

When copying ends, the thumbnail screen is restored.

#### Notes

- If there is another clip having the same name on the destination SxS memory card, the clip is copied under a name adding a single-digit number in parentheses to the end of the original clip name.  
The parenthetical number is the minimum value that does not exist in the destination memory card.

#### Examples:

ABCD0002(1) if ABCD0002 exists

ABCD0002(2) if ABCD0002(1) exists

ABCD0005(4) if ABCD0005(3) exists

- If parenthetical numbers (1) to (9) already exist as the result of repeated copying, copying to that card cannot be done any more.
- A warning message is displayed if there is not sufficient space on the destination SxS memory card. Replace the SxS memory card with one with sufficient space.

### To cancel copying on the way

Press the CANCEL button.

Copying is canceled and the thumbnail screen is restored.

## Deleting a Clip

You can delete a clip selected on the thumbnail screen from the SxS memory card.

### 1 Select the clip you wish to delete on the thumbnail screen then press the joystick or the jog dial.

The Clip Operation menu of the thumbnail screen pops up.

### 2 Select “DELETE CLIP” from the Clip Operation menu.

The information screen for the selected clip appears, and a confirmation message is displayed below the index frame image.

### 3 To delete, select “Execute” then press the jog dial or the joystick.

The clip is deleted.

The subsequent clips are shifted by one on the thumbnail screen.

## Displaying the EXPAND CLIP Screen

The EXPAND CLIP screen permits you to divide a clip into 12 blocks of equal duration and show a thumbnail image of the first frame of each block on the screen.

This helps you to quickly cue up to a desired scene in a clip of long duration.

You can display the EXPAND CLIP screen by selecting the clip on the thumbnail screen or on the still picture of the clip in Pause mode.

- 1 **Pause the playback or select a clip on the thumbnail screen then press the joystick or the jog dial.**

The corresponding Clip Operation menu pops up.

- 2 **Select “EXPAND CLIP” from the Clip Operation menu.**

The EXPAND CLIP screen appears for the clip in Pause mode or that you selected on the thumbnail screen.

On the EXPAND CLIP screen displayed by using the Clip Operation menu in Pause mode, the clip is displayed with the finest possible partitions.

## EXPAND CLIP screen

Playback

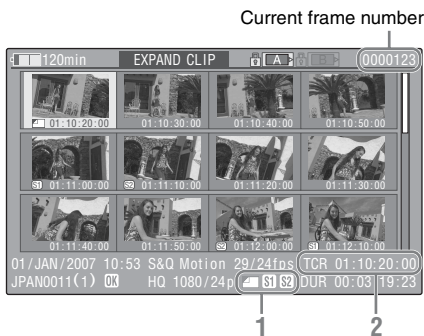

Detailed information for the clip is displayed at the bottom of the screen.

The items other than the following are the same as those on the normal thumbnail screen:

### 1. Frame information

The following icons show the marking for the frame at the cursor.

	Index frame
	Frame with shot mark 1 added
	Frame with shot mark 2 added

The same icons may also be displayed below the thumbnail image of each frame. If the frame has multiple markings, one of the icons is displayed, in the priority order of index frame, shot mark 1, and shot mark 2.

## 2. Timecode indication

The timecode of the frame at the cursor is displayed.

## Clip Operation menu on the EXPAND CLIP screen

When you select a frame on the EXPAND CLIP screen and press the joystick or the jog dial, the Clip Operation menu pops up to enable further operations.

Item	Function
EXPAND (COARSE)	To decrease the number of partitions of the clip
EXPAND (FINE)	To increase the number of partitions of the clip
PAUSE	To set to Pause mode at the selected frame
SET INDEX PIC	To specify the selected frame for the index frame of the clip ( <i>page 104</i> )
SHOT MARK1 ADD	To add shot mark 1 to the selected frame ( <i>page 103</i> )
SHOT MARK2 ADD	To add shot mark 2 to the selected frame ( <i>page 103</i> )
SHOT MARK1 DEL	To delete shot mark 1 from the selected frame ( <i>page 103</i> )
SHOT MARK2 DEL	To delete shot mark 2 from the selected frame ( <i>page 103</i> )
DIVIDE CLIP	To divide the clip into two clips at the selected frame ( <i>page 104</i> )

## Displaying the SHOT MARK Screen

When one or more shot marks are recorded for a single clip, the SHOT MARK screen permits you to display only the marked frames as the thumbnail images on the screen.

- 1 **Select a clip on the thumbnail screen.**

- 2 **Press the joystick or the jog dial.**

The Clip Operation menu pops up.

- 3 **Select “SHOT MARK,” “SHOT MARK1,” or “SHOT MARK2.”**

**SHOT MARK:** To display thumbnails only of the frames marked with shot mark 1 and/or shot mark 2 recorded

**SHOT MARK1:** To display thumbnails only of the frames marked with shot mark 1

**SHOT MARK2:** To display thumbnails only of the frames marked with shot mark 2

## SHOT MARK screen example



The detailed information of the clip is displayed at the bottom of the screen.

The items other than the following are the same as those on the EXPAND CLIP screen:

### 1. Timecode indication

The timecode of the frame at the cursor on the SHOT MARK screen is displayed.

## Clip Operation menu on the SHOT MARK screen

When you select a frame on the SHOT MARK screen and press the joystick or the jog dial, the Clip Operation menu pops up to permit you further operations.

Item	Function
PAUSE	To set to Pause mode at the selected frame
SET INDEX PIC	To specify the selected frame for the index frame of the clip ( <i>page 104</i> )
SHOT MARK1 DEL	To delete the shot mark 1 from the selected frame ( <i>page 103</i> )
SHOT MARK2 DEL	To delete the shot mark 2 from the selected frame ( <i>page 103</i> )
DIVIDE CLIP	To divide the clip into two clips at the selected frame ( <i>page 104</i> )

## Adding/Deleting Shot Marks

You can add shot marks to the clips after recording or delete the recorded shot marks.

## Adding a shot mark in Pause mode

**1 Pause the playback at the frame to which you wish to add a shot mark then press the joystick or the jog dial.**

The Clip Operation menu pops up.

**2 Select “SHOT MARK1 ADD” or “SHOT MARK2 ADD” from the Clip Operation menu.**

The information screen for the selected frame appears, and a confirmation message is displayed below the image.

**3 Select “Execute.”**

## Adding a shot mark on the EXPAND CLIP screen

**1 Select the frame to which you wish to add a shot mark on the EXPAND CLIP screen then press the joystick or the jog dial.**

The Clip Operation menu pops up.

**2 Select “SHOT MARK1 ADD” or “SHOT MARK2 ADD” from the Clip Operation menu.**

The information screen for the selected frame appears, and a confirmation message is displayed below the image.

**3 Select “Execute.”**

## Deleting a shot mark

You can delete shot marks on the EXPAND CLIP screen (*page 101*) or on the SHOT MARK screen (*page 102*).

**1 Select a frame from which you wish to delete the shot mark on the EXPAND CLIP screen or the SHOT MARK screen then press the joystick or the jog dial.**

The Clip Operation menu pops up.

**2 Select the “SHOT MARK1 DEL” or “SHOT MARK2 DEL” from the Clip Operation menu.**

The information screen for the selected frame appears and a confirmation message is displayed below the image.

### 3 Select “Execute.”

## Changing the Index Frame

You can change the index frame of a clip to another frame you selected on the EXPAND CLIP screen (*page 101*) or the SHOT MARK screen (*page 102*).

### 1 Select a frame to be the index frame on the EXPAND CLIP screen or the SHOT MARK screen then press the joystick or the jog dial.

### 2 Select “SET INDEX PIC” from the Clip Operation menu.

The information screen of the selected frame appears and the confirmation message is displayed below the image.

### 3 Select “Execute.”

#### Note

Even if you specify a frame other than the top frame for the index frame, playback always begins from the top frame when you start it from the thumbnail screen.

## Dividing a Clip

You can divide a clip into two different clips at the frame you select on the EXPAND CLIP screen (*page 101*) or the SHOT MARK screen (*page 102*).

### 1 Select the frame at which the clip is to be divided on the EXPAND CLIP screen or the SHOT MARK screen then press the joystick or the jog dial.

The Clip Operation menu pops up.

### 2 Select “DIVIDE CLIP” from the Clip Operation menu.

The information screen for the selected frame appears, and a confirmation message is displayed below the image.

### 3 Select “Execute.”

The selected and subsequent frames are divided, creating two clips having different names.

The first 4 characters of the original clip name are carried on, continuing to the last number on the memory card by the second 4 numerics.

**Example:** If you divide a clip named ABCD0002 into two clips under the condition where a new clip will be named EFGH0100, clip ABCD0100 and clip ABCD0101 are created.

#### Note

If the remaining space on the memory card is insufficient for divided clips, a message informing you of it appears.



# Showing the Status Screens

This camcorder provides status screens of five kinds in Camera mode and four kinds in Media mode, permitting you to check the various settings and statuses of this unit.

The status screens can also be displayed on an external monitor.

*For connections of an external monitor, see “Connecting External Monitors” on page 128.*

### Available status screens

- CAMERA status screen (displayed only in Camera mode) (page 106)
- AUDIO status screen (page 107)
- VIDEO status screen (page 108)
- BUTTON/REMOTE status screen (page 108)
- BATTERY/MEDIA status screen (page 109)

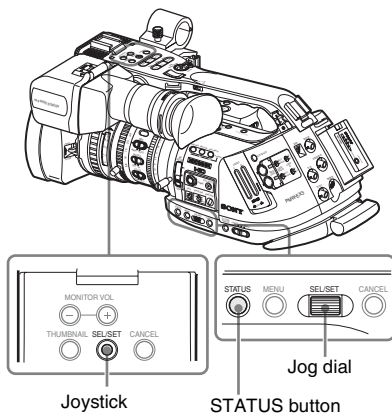

### Activating the status screen display

**Press the STATUS button.**

### Switching the status screens

Operating the joystick or the jog dial switches the screens in sequence.

### Canceling the status screen display

Press the STATUS button again. The status screen display is canceled.

Also, when the S&Q Motion dial is pressed or when an external device is connected to the REMOTE connector, the status display disappears.

# CAMERA Status Screen

The settings and statuses related to image shooting are displayed.

The CAMERA status screen is obtained only in Camera mode. It is not displayed in Media mode.

CAMERA		1/5	
White Bal B:	12000K	Gain L:	0dB
A:	4700K	M:	9dB
PRST:	3200K	H:	18dB
Handle Zoom Speed H:	70	Zebra1:	On 70%
L:	30	2:	Off
Skin Tone Detail:	Off	LensID:	Standard_Lens
Picture Profile:	PP1 STANDARD		

## White Bal: White balance status

### Display Contents

B	The color temperature stored in white memory B is indicated. The color temperature of white memory B is detected/stored when you execute the auto white balance operation in Memory B mode.
A	The color temperature stored in white memory A is indicated. The color temperature of white memory A is detected/stored when you execute the auto white balance operation in Memory A mode.
PRST	The color temperature set as the preset white is indicated. The color temperature of preset white can be changed using the PICTURE PROFILE menu.

## Gain: GAIN switch settings

The gain values of the positions L, M, and H of the GAIN switch assigned with the CAMERA SET menu are displayed.

## Handle Zoom Speed: Handle zoom speed settings

The speed values assigned to the on-handle ZOOM button on the CAMERA SET menu are displayed.

### Display Contents

H	Speed obtained when the speed switch is set to the H position
L	Speed obtained when the speed switch is set to the L position

### Note

The display is not available when a non-serial lens is mounted.

## Zebra: Zebra status

### Display Contents

1	This indication becomes “On” if you turn zebra on with the ZEBRA button when “1” or “Both” is selected for “Zebra Select” of the VF SET menu. The setting value of “Zebra1 Level” of the VF SET menu is displayed at the right. It shows “Off” when zebra is off or “2” is selected for “Zebra Select.”
2	This indication becomes “On” if you turn zebra on with the ZEBRA button when “2” or “Both” is selected for “Zebra Select” of the VF SET menu. It shows “Off” when zebra is off or “1” is selected for “Zebra Select.”

## Skin Tone Detail: Skin-tone detail status

The current status (On or Off) of “Setting” of “Skin Tone Detail” of the PICTURE PROFILE menu is displayed.

## Lens ID

The ID of the mounted lens is displayed.

### Note

The display is not available when a non-serial lens is mounted.

## Picture Profile: Picture Profile selection status

The selected Picture Profile number and name are displayed. (If Picture Profile is off, “Off” is displayed.)

# AUDIO Status Screen

Information regarding audio signals is displayed. The display configuration varies between Camera mode and Media mode.

## In Camera Mode

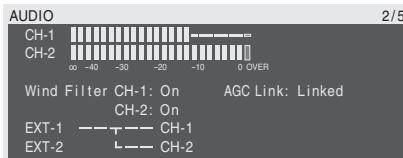

### CH-1/CH-2: Audio level meters

The levels of the CH-1 and CH-2 audio inputs (E-E audio levels) are displayed.

### Wind Filter: Wind filter settings

The current settings of “Wind Filter CH-1” and “Wind Filter CH-2” of the AUDIO SET menu are displayed.

### AGC Link: AGC link status

The “AGC Link” status (Linked or Separate) of the AUDIO SET menu is displayed.

### INT/EXT-CH-1/CH-2: Audio input settings

The inputs to CH-1 and CH-2 according to the “EXT CH Select” setting of the AUDIO SET menu and the AUDIO IN switch status are displayed.

AUDIO IN switch	EXT CH Select	Display
CH-1: INT	—	INT-L ----- CH-1
CH-2: INT	—	INT-R ----- CH-2
CH-1: EXT	—	EXT-1 ----- CH-1
CH-2: INT	—	INT-R ----- CH-2
CH-1: INT	—	INT-L ----- CH-1
CH-2: EXT	—	EXT-2 ----- CH-2
CH-1: EXT	CH-1/CH-2	EXT-1 ----- CH-1
CH-2: EXT	CH-1/CH-2	EXT-2 ----- CH-2
CH-1: EXT	CH-1	EXT-1 ---T--- CH-1
CH-2: EXT	CH-1	EXT-2 L--- CH-2

## In Media Mode

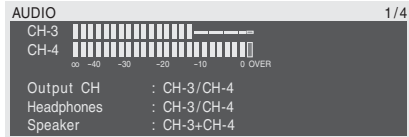

### CH-1/CH-2/CH-3/CH-4: Audio level meters

The playback audio levels of CH-1/CH-2 or CH-3/CH-4 are displayed according to the “Output CH” setting of the AUDIO SET menu.

If audio input is fed in via the i.LINK connector in STOP status or in external input recording, the input audio levels are indicated. In this case, the channel indications at the left of the meters are CH-1 and CH-2 regardless of the “Output CH” setting of the AUDIO SET menu.

In other conditions, the meters do not function.

### Output CH: Output channel setting

The “Output CH” setting of the AUDIO SET menu is displayed.

### Headphones: Headphone output

The output audio channel(s) for the headphones is(are) displayed. The “Monitor CH” setting of the AUDIO SET menu is valid as-is.

### Speaker: Speaker output

The output audio channel(s) for the built-in speaker is(are) displayed. As the speaker is monaural, the outputs are CH-1+CH2 or CH-3+CH4 even in stereo mode.

With nonstereo settings, the “Monitor CH” setting of the AUDIO SET menu is valid as-is.

## VIDEO Status Screen

The information on video formats and settings for the COMPONENT OUT, SDI OUT, MONITOR OUT, S VIDEO, and i.LINK connectors is displayed.

VIDEO	3/5
Video Format	: 1080/60i
Rec Mode	: HQ
YPbPr/SDI Out	: 1080/60i
Video Out	: NTSC
Down Converter	: Squeeze
i.LINK I/O	: Disable

### Video Format: Video format setting

The picture size (effective vertical lines), frame rate, and scan format set in “Video Format” of the OTHERS menu are displayed.

### Rec Mode: Recording bit rate

The bit rate (HQ or SP) set in “Video Format” of the OTHERS menu is displayed.

### YPbPr/SDI Out: Component and SDI output status

The picture size (effective vertical lines), frame rate, and scan format of the signal being fed from the COMPONENT OUT and SDI OUT connectors according to the “YPbPr/SDI Out Select” setting of the VIDEO SET menu are displayed.

### Video Out: Output status of the MONITOR OUT and S VIDEO connectors

The format (NTSC or PAL) of the analog composite signal being fed from the MONITOR OUT connector and S VIDEO connector is displayed.

### Down Converter: Down-converter setting of the SD output

The “Down Converter” setting (Squeeze, Edge Crop, Letterbox) of the VIDEO SET menu is displayed.

### i.LINK I/O: i.LINK I/O status

The i.LINK I/O setting (Enable /Disable) of the OTHERS menu is displayed.

## BUTTON/REMOTE Status Screen

The functions assigned to the assignable buttons and the status of the IR Remote Commander are displayed.

BUTTON/REMOTE	4/5
Assign Button 1:	Freeze Mix
2:	Off
3:	Off
4:	Rec Review
IR Remote	: On

### Assign Button: Assignable button statuses

The functions assigned with the “Assign Button” of the OTHERS menu to the respective assignable buttons are displayed.

### IR Remote: IR Remote Commander status

The status (On: enabled, Off: disabled) of the IR Remote Commander is displayed.

# BATTERY/MEDIA Status Screen

The information on the battery pack and SxS memory cards is displayed.

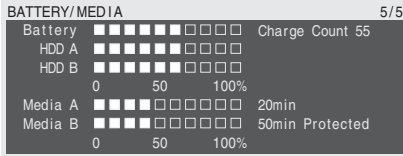

## Battery: Battery charge remaining

The remaining charge level of the mounted battery pack is displayed.

## Charge Count: Repeated charge times

The number of times that the mounted battery pack has been charged is displayed.

## HDD A/HDD B: Battery remaining of PHU-60K units

When PHU-60K Professional Hard Disk units are connected, the remaining power levels of the batteries of the PHU-60K units connected via the respective card slots are displayed.

## Media A/Media B: Remaining space and available recording time

The remaining space of the SxS memory cards in the respective card slots are indicated on the meters.

At the right, the available time for recording if done at the current bit rate is displayed, in minutes.

The time indication will be “- - min” if no SxS memory card or an invalid card is in the slot. If the card is write-protected, “Protected” is shown to the right of the time indication.

# Overview of the Setup Menus

This camcorder permits you to make various settings for recording and playback with Setup menus in the viewfinder.

The Setup menus can also be displayed on an external monitor.

For connections of an external monitor, see “Connecting External Monitors” on page 128.

## Setup Menu Configuration

The following menu icons are displayed when you press the MENU button, permitting you to select the corresponding menus.

### CAMERA SET menu

For setting the items related to recording other than those on picture quality (page 114).

The picture-quality items are set with the PICTURE PROFILE menu (page 87).

### AUDIO SET menu

For setting the audio-related items (page 118).

### VIDEO SET menu

For setting the items related to video outputs (page 119).

### VF SET menu

For setting the items related to the displays in the viewfinder (page 120).

### TC/UB SET menu

For setting the items related to timecodes and user bits (page 122).

### LENS menu

For setting the items related to lenses (page 122).

### OTHERS menu

For setting the other items (page 124).

## Setup Menu Layers

### MENU

CAMERA SET	Auto BLK Balance
	Gain Setup
	Shutter
	EX Slow Shutter
	Shot Transition
	MF Assist
	Color Bar Type
	Flicker Reduce
	Zoom Speed
	Interval Rec
	Frame Rec
	S&Q Motion
	Rec Review
	Fader
	TLCS
	Shockless White
	White Switch
	ATW Speed
	Wide Conversion
AUDIO SET	Audio Input
	Audio Output
VIDEO SET	YPbPr/SDI Out Select
	YPbPr/SDI Out Display
	Video Out Display
	Setup
	Down Converter
VF SET	VF
	Peaking
	Marker
	Zebra
	Display On/Off
TC/UB SET	Timecode
	Users Bit
	TC Format

(continues)

LENS	<ul style="list-style-type: none"> <li>— Auto FB ADJ</li> <li>— File</li> <li>— Flare</li> <li>— Shading</li> </ul>
OTHERS	<ul style="list-style-type: none"> <li>— All Reset</li> <li>— Camera Data</li> <li>— Time Zone</li> <li>— Clock Set</li> <li>— Language</li> <li>— Assign Button</li> <li>— Tally</li> <li>— Hours Meter</li> <li>— IR Remote</li> <li>— Battery Alarm</li> <li>— Battery INFO</li> <li>— Genlock</li> <li>— Direct Menu</li> <li>— i.LINK I/O</li> <li>— Trigger Mode</li> <li>— Country</li> <li>— Video Format</li> <li>— Clip</li> <li>— Format Media</li> </ul>

## Basic Menu Operations

This section covers basic operations for setting the Setup menu items.

### Menu controls

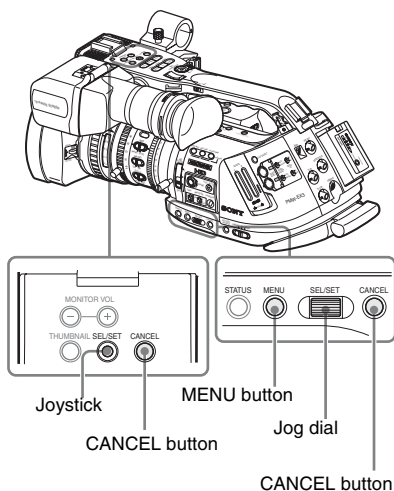

#### **MENU button**

To turn Menu mode to use Setup menus on/off.

#### **Joystick (SEL/SET button)**

When you tilt it, the cursor moves in the corresponding direction, permitting you to select menu items or setting values.

#### **Jog dial (SEL/SET dial)**

When you turn the dial, the cursor moves up or down, permitting you to select menu items or setting values.

#### **CANCEL button**

To return to the previous layer of the menu. An uncompleted change is canceled.

### Displaying the Setup menu

#### **Press the MENU button.**

The menu icons appear on the screen.

The cursor is displayed on the icon of the menu used last, and the corresponding menu item selection area is displayed to the right.

**Example: When the cursor is located at (CAMERA SET menu icon)**

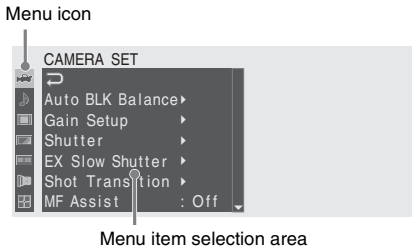

**Note**

When the camcorder is in EXPAND FOCUS mode (page 62), the Setup menus cannot be operated. Press the EXPAND FOCUS button to release the mode.

**Setting the Setup menus**

**1 Rotate the jog dial or tilt the joystick back or forth to set the cursor to the icon of the menu you wish to set.**

The selectable menu items are displayed in the menu item selection area to the right of the icon.

**2 Press the jog dial or the joystick.**

The cursor moves to the menu item selection area.

You can also move the cursor to the menu item selection area by tilting the joystick to the right.

- The menu item selection area can show 7 lines at maximum. When all the selectable items cannot be displayed at one time, you can scroll the display up or down by moving the cursor.

A triangle appears at the upper or lower right corner of the menu item selection area to indicate that scrolling is enabled.

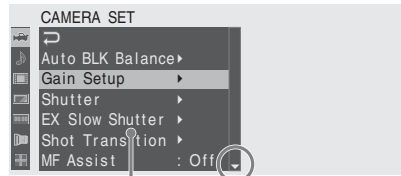

Displayed when there are more menu items beneath. (▲ shown at the top indicates that there are more menu items above.)

**Menu item selection area**

- A ► symbol is displayed to the right of any item that has subitems.
- The current setting value is displayed to the right of an item that has no subitems.
- To return to the previous layer, select ◀ or tilt the joystick to the left.

**3 Turn the jog dial or tilt the joystick back or forth to set the cursor to the menu item you wish to set then press the dial or the joystick to proceed.**

The setting area appears to the right of the menu item selection area, and the cursor moves to the top of its subitems.

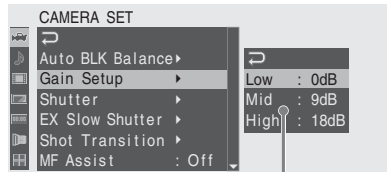

**Setting area**

- The subitems and their current values are displayed.
- To return to the previous layer, select ◀ or tilt the joystick to the left.

When you select an item that has no subitems and to be only On /Off or switched, the choices are displayed to the right of the item. In this case, proceed to step 5.



## Example

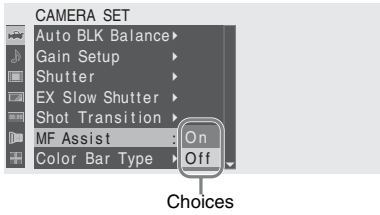

- 4 For the item that has subitems, turn the jog dial or tilt the joystick back or forth to set the cursor to the subitem you wish to set then press the dial or the joystick to proceed.**

The available values of the selected subitems are displayed, and the cursor moves to the current value.

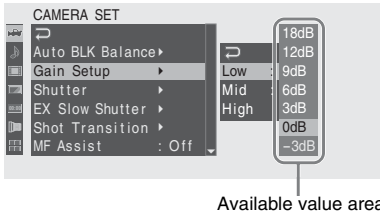

- The available value area can show 7 lines at maximum. When all the selectable values cannot be displayed at one time, you can scroll the display up or down by moving the cursor.

A triangle appears at the upper or lower right corner of the available value area to indicate that scrolling is enabled.

- For items having a wide range of available values (example: -99 to +99), the available value area is not displayed. The current setting is highlighted instead, indicating that the setting is ready for change.

- 5 Select the desired value by turning the jog dial or tilting the joystick back or forth then press the dial or the joystick to make the setting.**

The setting is changed, and the new setting is displayed.

When you select "Execute" for an execution item, the corresponding function is executed.

## For an item that requires your confirmation

When you select an item that you must confirm before execution in step 3, the menu display temporarily disappears, and a confirmation message is displayed. Following the instructions of message, specify whether to execute or cancel.

---

## Entering a character string

---

When you select an item for which a character string, such as a time value or filename, is to be specified, the input area for the character string is highlighted, and "SET" appears at the right end.

- 1 Select characters by turning the jog dial or tilting the joystick back and forth then press the dial or joystick to proceed.**

The cursor moves to the next column.

To return to the previous column, tilt the joystick to the left.

- 2 Perform setting in the same manner up to the last column/digit.**

The cursor moves to "SET."

- 3 Press the jog dial or the joystick.**

The setting is completed.

---

## Terminating the menu operation

---

**Press the MENU button.**

The normal camera picture is resumed.

# Setup Menu List

The functions and available settings of menus are listed below.

The default settings set at the factory are shown in bold face (example: **Speed**).

## CAMERA SET Menu

### CAMERA SET

Menu items	Subitems and setting values	Contents
<b>Auto BLK Balance</b> Adjusting the black balance automatically	Execute/Cancel	Select "Execute" to start the automatic black balance adjustment.
<b>Gain Setup</b> Assigning gain levels to the three GAIN switch positions	Low -3 / <b>0</b> / 3 / 6 / 9 / 12 / 18 dB	Set the gain level to be used when the switch is set to the L position.
	Mid -3 / 0 / 3 / 6 / <b>9</b> / 12 / 18 dB	Set the gain level to be used when the switch is set to the M position.
	High -3 / 0 / 3 / 6 / 9 / 12 / <b>18</b> dB	Set the gain level to be used when the switch is set to the H position.
<b>Shutter</b> Specifying operating conditions of the electrical shutter	Mode <b>Speed</b> / Angle / ECS / SLS	Select modes of the Electronic Shutter.
	Shutter Speed <b>1/100</b>	Set the shutter speed when Speed mode is selected. <i>The available setting values vary depending on the video format being selected (see page 56).</i>
	Shutter Angle <b>180°</b> / 90° / 45° / 22.5° / 11.25°	Set the shutter angle when Angle mode is selected.
	ECS Frequency <b>60.02</b>	Set the ECS frequency when ECS mode is selected. <i>The available setting values vary depending on the frame rate of the video format selected.</i>
	SLS Frame <b>2</b> to 8	Set the number of frames to accumulate when SLS mode is selected.
<b>EX Slow Shutter</b> Setting the Supersensitized Slow Shutter mode	Setting On / <b>Off</b>	Turn EX Slow Shutter mode on/off.
	Number of Frames <b>16</b> / 32 / 64	Set the number of frames to accumulate.

CAMERA SET		
Menu items	Subitems and setting values	Contents
<b>Shot Transition<sup>1)</sup></b> Setting the operating conditions of Shot Transition	Trans Time 2 to 15 sec ( <b>4 sec</b> )	Set the time it takes to make a shot transition.
	Trans Speed 1 to 10 ( <b>5</b> )	Set the speed of the transition.
	Time / Speed Time / <b>Speed</b>	Determine whether to specify the transition by time or speed.
	Trans Curve Linear / Soft Trans / <b>Soft Stop</b>	Select the transition pattern. Linear: To make the transition linearly Soft Trans: To make the transition slowly at the beginning and end, but linearly in between Soft Stop: To make the transition slow down near the end
	Start Timer <b>Off</b> / 5 sec / 10 sec / 20 sec	Set the waiting time until the shot transition begins.
	Rec Link <b>Off</b> / Shot-A / Shot-B	Set the function to start a shot transition linked to recording start. Off: To start the transition using a button without linked to recording start Shot-A: To start a transition to Shot-A linked to recording start Shot-B: To start a transition to Shot-B linked to recording start
<b>MF Assist<sup>1)</sup></b> Turning the MF Assist Function on/off	<b>On / Off</b>	Set to "On" to precisely adjust the focus automatically after you roughly adjust it manually.
<b>Color Bar Type</b> Selecting the types of color bar	<b>Multi</b> / 75% / 100%	Select the type of color bars displayed when you press the BARS/CAM button. Multi: To output multiformat color bars 75%: To output 75% color bars 100%: To output 100% color bars
<b>Flicker Reduce</b> Setting Flicker Compensation	Mode <b>Auto</b> / On / Off	Set the operation of the Flicker-Reduction function. On: To always activate it Auto: To automatically activate it when flicker is detected. Off: To not activate it
	Frequency <b>50 Hz</b> / 60 Hz	Set to the power supply frequency of the light source causing flicker.
<b>Zoom Speed</b> Setting the zoom speed	High 0 to 99 ( <b>70</b> )	Set the speed of zooming to be executed when you press the on-handle ZOOM button with the zoom speed switch set to H.
	Low 0 to 99 ( <b>30</b> )	Set the speed of zooming to be executed when you press the on-handle ZOOM button with the zoom speed switch set to L.
	Remote 0 to 99 ( <b>50</b> )	Set the speed of zooming to be executed when you press the ZOOM button of the IR Remote Commander.

## CAMERA SET

Menu items	Subitems and setting values	Contents
<b>Interval Rec</b> Setting the Interval Recording function	Setting On / <b>Off</b>	Turn the Interval Recording function on/off.
	Interval Time 1 to 10/15/20/30/40/50 sec 1 to 10/15/20/30/40/50 min 1 to 4/6/12/24 hour	Set the interval of recording in Interval Recording.
	Number of Frames 1 / 3 / 6 / 9 or 2 / 6 / 12 (720/60P, 720/50P)	Set the number of frames to be recorded at a time in Interval Recording.
<b>Frame Rec</b> Setting the Frame Recording function	Setting On / <b>Off</b>	Turn the Frame Recording function on/off.
	Number of Frames 1 / 3 / 6 / 9 or 2 / 6 / 12 (720/60P, 720/50P)	Set the number of frames to be recorded at a time in Frame Recording.
<b>S&amp;Q Motion<sup>2)</sup></b> Setting the S&Q Motion function	Setting On / <b>Off</b>	Turn the Slow & Quick Motion function on/off.
	Frame Rate 1 to <b>30</b> (1080 size) 1 to 60 (720 size)	Set the recording frame rate in Slow & Quick Motion recording.
<b>Rec Review</b> Setting the playback time for Rec-Review	<b>3 sec</b> / 10 sec / Clip	Set the time to play the last recorded clip using the Rec-Review function. 3 sec: Last 3 seconds 10 sec: Last 10 seconds Clip: Entire duration of the clip
<b>Fader</b> Setting the fade-in/ fade-out functions	Fade In On / <b>Off</b>	Turn the fade-in function on/off.
	Fade In Type White / <b>Black</b>	Select the fade-in mode. White: To fade in from a white screen Black: To face in from a black screen
	Fade In Time 1 sec / <b>2 sec</b> / 3 sec / 5 sec / 10 sec	Set the duration of the fade in.
	Fade Out On / <b>Off</b>	Turn the fade-out function on/off.
	Fade Out Type White / <b>Black</b>	Select the fade-out mode. White: To fade out to a white screen Black: To face out to a black screen
	Fade Out Time 1 sec / <b>2 sec</b> / 3 sec / 5 sec / 10 sec	Set the duration of the fade out.

CAMERA SET		
Menu items	Subitems and setting values	Contents
<b>TLCS<sup>3)</sup></b> Setting the Total Level Control System (auto adjustment system of gain, iris and shutter)	Level +1.0 / +0.5 / <b>±0</b> / -0.5 / -1.0	Set the target level (to make brighter or darker) of auto iris control in TLCS. (This setting also affects the gain control in AGC mode and shutter-speed control in Auto Shutter mode.) +1.0: Approx. one stop further open +0.5: Approx. half a stop further open ±0: Standard -0.5: Approx. half a stop further closed -1.0: Approx. one stop further closed
	Mode Backlight / <b>Standard</b> / Spotlight	Set the auto iris control mode in TLCS. Backlight: Backlight mode to reduce darkening of the center subject against lights Standard: Standard mode Spotlight: Spotlight mode to reduce blown-out highlights on the center subject in the spotlight
	Speed -99 to +99 ( <b>+50</b> )	Set the tracing speed of TLCS control.
	AGC <b>On / Off</b>	Turn the AGC (Auto Gain Control) function on/off.
	AGC Limit 3 / 6 / 9 / <b>12</b> / 18 dB	Set the maximum gain in AGC.
	AGC Point F5.6 / F4 / <b>F2.8</b>	Set the iris point for switching to auto-iris and auto-shutter control when AGC is on.
	Auto Shutter <b>On / Off</b>	Turn the Auto Shutter control function on/off.
	A.SHT Limit 1/100 1/150 1/200 <b>1/250</b>	Set the maximum shutter speed in Auto Shutter control.
	A.SHT Point F5.6 / F8 / F11 / <b>F16</b>	Set the iris point for switching auto-iris and auto-shutter control when Auto Shutter is on.
	<b>Shockless White</b> Setting the shockless white balance	Off / 1 / <b>2</b> / 3
<b>White Switch</b> Setting for the WHITE BAL switch	<b>ATW</b> / MEM	Select the mode (ATW or Memory B) selected at the B position of the WHITE BAL switch.
<b>ATW Speed</b> Setting for Auto Tracing White Balance	1 / 2 / <b>3</b> / 4 / 5	Set the tracing speed of ATW. The larger the number you set, the speed becomes faster.
<b>Wide Conversion<sup>1)</sup></b> Setting for use of a wide conversion lens	<b>On / Off</b>	Set to "On" when a wide conversion lens is attached.

1) Valid with exclusive lenses only

2) Valid only when the RM-B750/B150 Remote Control Unit is connected

3) If the mouted lens does not have Auto Iris function, only the gain and shutter are adjusted automatically.

## AUDIO SET Menu

### AUDIO SET

Menu items	Subitems and setting values	Contents	
<b>Audio Input</b> Setting for audio inputs	TRIM CH-1 -11 dBu to -65 dBu ( <b>-41 dBu</b> )	Finely adjust the sensitivity of channel 1 of external microphone input in steps of 6 dB.	
	TRIM CH-2 -11 dBu to -65 dBu ( <b>-41 dBu</b> )	Finely adjust the sensitivity of channel 2 of external microphone input in steps of 6 dB.	
	AGC Link <b>Linked</b> / Separated	Select the gain link condition when the audio level adjustment is in AGC mode. Linked: To vary the CH-1 gain and the CH-2 gain in synchronization. Separated: To vary the CH-1 gain and the CH-2 gain independently according to the respective levels.	
	1KHz Tone On / <b>Off</b>	Turn the 1-kHz reference tone signal on/off.	
	Wind Filter CH-1 On / <b>Off</b>	Turn the wind filter for channel 1 on/off.	
	Wind Filter CH-2 On / <b>Off</b>	Turn the wind filter for channel 2 on/off.	
	EXT CH Select CH-1 <b>CH-1/CH-2</b>	CH-1: To record channel 1 audio input on both channels 1 and 2. CH-1/CH-2: To record channel 1 and channel 2 inputs on the respective channels.	
	<b>Audio Output</b> Setting for audio outputs	Monitor CH <b>CH-1/CH-2</b> (CH-3/CH-4) CH-1+CH-2 (CH-3+CH-4) CH-1 (CH-3) CH-2 (CH-4)	Select the audio channel(s) to be fed to the headphones and the built-in speaker. CH-1/CH-2 (CH-3/CH-4): Stereo CH-1+CH-2 (CH-3+CH-4): Mix CH-1 (CH-3): CH-1 (CH-3) only CH-2 (CH-4): CH-2 (CH-4) only ( ): with Output CH set to "CH-3/CH-4"
		Output CH <b>CH-1/CH-2</b> CH-3/CH-4	Select audio output channels from either channels 1 and 2 or channels 3 and 4.
		Alarm Level 0 to 10 ( <b>5</b> )	Set the alarm sound volume.
Beep On / <b>Off</b>		Select whether or not to sound a beep upon each operation.	

## VIDEO SET Menu

VIDEO SET		
Menu items	Setting values	Contents
<b>YPbPr/SDI Out Select</b> Setting the component/SDI outputs	HD / SD/ Off	Select the output signal from the COMPONENT OUT connector and the SDI OUT connector. HD: To output the same HD signal as that in recording and playback SD: To output a down-converted SD signal Off: No output
<b>YPbPr/SDI Out Display</b> Setting the character information for the component/SDI outputs	On / Off	Set whether to add the same menus and status indications as those in the viewfinder to the output signals from the COMPONENT OUT connector and the SDI OUT connector.
<b>Video Out Display</b> Setting the character information for the composite output	On / Off	Set whether to add the same menus and status indications as those in the viewfinder to the output signal from the MONITOR OUT and S VIDEO connectors.  <b>Note</b> On the thumbnail, EXPAND CLIP and SHOTMARK screens, the same menus and status indications as those in the viewfinder are displayed regardless of the setting of this item.
<b>Setup</b> Setting 7.5% setup for the composite signal	On / Off	Set whether to add 7.5% setup to the output signal from the MONITOR OUT and S VIDEO connectors when a format of NTSC is selected (Invalid when a format of PAL is selected).  <b>Note</b> The default setting is different among the sales areas. United States and Canada: On Other areas: Off
<b>Down Converter</b> Selecting the operation mode of the down converter	<b>Squeeze</b> / Letterbox / Edge Crop	Set the output mode (aspect) for SD output from the MONITOR OUT, S VIDEO, COMPONENT OUT, and SDI OUT connectors. Squeeze: To horizontally reduce a 16:9 picture to output a 4:3 picture Letterbox: To mask the upper and lower areas of a 4:3 picture to display a 16:9 picture in the center of the screen Edge Crop: To cut the both sides of a 16:9 picture to output a 4:3 picture

## VF SET Menu

VF SET		
Menu items	Subitems and setting values	Contents
<b>VF</b> Setting the viewfinder	Color -99 to +99 ( $\pm 0$ )	Adjust the color of pictures in the viewfinder.
	Mode <b>Color</b> / B&W	Select the display mode of the viewfinder. Color: Color mode B&W: Monochrome mode
<b>Peaking</b> Setting the peaking function for the viewfinder	Type <b>Normal</b> / Color	Select the circuit to be used for the peaking function. Normal: To use the VF DETAIL circuit of the viewfinder Color: To use the peaking circuit of the camcorder
	Color <b>White</b> / Red / Yellow / Blue	When you select "Color" for "Type," select the color of the peaking signal.
	Frequency <b>Normal</b> / High	When you select "Normal" for "Type," select the frequency to be detected by the VF DETAIL circuit.
<b>Marker</b> Setting the markers added to pictures in the viewfinder	Setting <b>On</b> / Off	Turn all marker indications on/off in combination.
	Safety Zone <b>On</b> / Off	Turn the safety marker on/off.
	Safety Area 80% / <b>90%</b> / 92.5% / 95%	Select the size (ratio to the entire screen) of the safety zone marker.
	Center Marker <b>On</b> / Off	Turn the center marker on/off.
	Aspect Marker <b>On</b> / <b>Off</b>	Turn the aspect marker on/off.
	Aspect Select <b>4:3</b> / 13:9 / 14:9 / 15:9	Select the type of the aspect marker.
	Guide Frame <b>On</b> / <b>Off</b>	Turn the guide frame marker on/off.
<b>Zebra</b> Setting the zebra pattern	Zebra Select <b>1</b> / 2 / Both	Select the zebra pattern(s) to be displayed. 1: To display zebra 1 only 2: To display zebra 2 only Both: To display both zebra 1 and zebra 2
	Zebra1 Level 50 to 107 ( <b>70</b> )	Set the display level of zebra 1.



VF SET		
Menu items	Subitems and setting values	Contents
Display On/Off Selecting the items to be displayed in the viewfinder	Video Level Warnings <b>On / Off</b>	Turn the warning indication to be displayed when the picture is too bright or too dark on/off.
	Brightness Display <b>On / Off</b>	Turn the numeric indication to show the picture brightness on/off.
	Histogram <b>On / Off</b>	Turn the histogram indication to show the level distribution of the picture on/off.
	Lens Info Meter / Feet / <b>Off</b>	Select the depth-of-field indication. Meter: To indicate in meters Feet: To indicate in feet Off: To not indicate
	Zoom Position <b>Number / Bar / Off</b>	Select the type of zoom position indication. Number: Indication with a number Bar: Indication with a bar Off: To not display (only when a serial lens is mounted)
	Audio Level Meter <b>On / Off</b>	Turn the audio level meter indication on/off.
	Timecode <b>On / Off</b>	Turn the time data (timecode, user bits, duration) indication on/off.
	Battery Remain <b>On / Off</b>	Turn the battery remaining/DC input voltage indication on/off.
	Media Remain <b>On / Off</b>	Turn the media remaining indication on/off.
	TLCS Mode <b>On / Off</b>	Turn the TLCS mode indication on/off.
	Steady Shot <b>On / Off</b>	Turn the Steady Shot indication on/off. (only when the exclusive lens is mounted)
	Focus Mode <b>On / Off</b>	Turn the focus operation mode indication on/off. (only when an auto-focus lens is mounted)
	White Balance Mode <b>On / Off</b>	Turn the white balance mode indication on/off.
	Picture Profile <b>On / Off</b>	Turn the Picture Profile indication on/off.
	Filter Position <b>On / Off</b>	Turn the ND filter setting indication on/off.
	Iris Position <sup>1)</sup> <b>On / Off</b>	Turn the iris setting indication on/off.
	Gain Setting <b>On / Off</b>	Turn the gain setting indication on/off.
	Shutter Setting <b>On / Off</b>	Turn the shutter mode and speed indication on/off.
	Fader Status <b>On / Off</b>	Turn the fader operation mode indication on/off.
	Rec Mode <b>On / Off</b>	Turn the special recording mode (Frame Rec, Interval Rec, S&Q Motion) indication on/off.
Video Format <b>On / Off</b>	Turn the video format indication on/off.	

## TC/UB SET Menu

TC/UB SET		
Menu items	Subitems and setting values	Contents
<b>Timecode</b> Setting the timecode	Mode <b>Preset</b> / Regen / Clock	Set the timecode mode. Preset: To start the timecode from the specified value Regen (regeneration): To continue the timecode from that of the previous clip Clock: To use the current clock time as the timecode
	Run <b>Rec Run</b> / Free Run	Set the running mode when the timecode mode is set to "Preset." Rec Run: The timecode advances only in recording mode. Free Run: The timecode keeps advancing regardless of recording.
	Setting	Set the timecode to a desired value. Select "SET" to finish the setting.
	Reset Execute / Cancel	Select "Execute" to reset the timecode to 00:00:00:00.
<b>Users Bit</b> Setting the user bits	Mode <b>Fix</b> / Date	Set the user bit mode. Fix: To use a desired fixed value as the user bits Date: To use the current date
	Setting	Set the user bits to a desired value.
<b>TC Format</b> Setting the timecode format	<b>DF</b> / NDF	Set the timecode format. DF: Drop frame NDF: Non drop frame

## LENS Menu

LENS		
Menu items	Subitems and setting values	Contents
<b>Auto FB ADJ</b> Adjusting the flange focal length	Execute/Cancel	Select "Execute" to start the automatic adjustment of the flange focal length.
<b>File</b> Retrieving/storing lens files	Lens ID	The ID of the mounted lens is displayed (for serial lenses only).
	Recall	Retrieve the lens file.
	Store	Store the data in the lens files.
	File ID	Set the filename of the lens file being selected.
	No Offset Execute/Cancel	Select "Execute" to clear the lens compensation data to the factory-set condition.
Auto Recall <b>On</b> / Off	Turn the function to automatically retrieve the lens file whose Lens ID is identical to that of the mounted lens.	

<b>LENS</b>		
<b>Menu items</b>	<b>Subitems and setting values</b>	<b>Contents</b>
<b>Flare</b> Adjusting the flare for a lens	R Flare -99 to +99 ( $\pm 0$ )	Adjust the flare (R).
	G Flare -99 to +99 ( $\pm 0$ )	Adjust the flare (G).
	B Flare -99 to +99 ( $\pm 0$ )	Adjust the flare (B).
	R Flare EX -99 to +99 ( $\pm 0$ )	Adjust the flare (R) (when an extender is in use).
	G Flare EX -99 to +99 ( $\pm 0$ )	Adjust the flare (G) (when an extender is in use).
	B Flare EX -99 to +99 ( $\pm 0$ )	Adjust the flare (B) (when an extender is in use).
	<b>Shading</b> Adjusting the lens shading	Shading CH <b>R / G / B</b>
M VMOD -99 to +99 ( $\pm 0$ )		Adjust the master V modulation shading.
H SAW -99 to +99 ( $\pm 0$ )		Compensate the H Saw shading.
H PARA -99 to +99 ( $\pm 0$ )		Compensate the H Para shading.
V SAW -99 to +99 ( $\pm 0$ )		Compensate the V Saw shading.
V PARA -99 to +99 ( $\pm 0$ )		Compensate the V Para shading.
Shading CH EX <b>R / G / B</b>		Select the target channel for the shading adjustments (when an extender is in use).
M VMOD EX -99 to +99 ( $\pm 0$ )		Adjust the master V modulation shading (when an extender is in use).
H SAW EX -99 to +99 ( $\pm 0$ )		Compensate the H Saw shading (when an extender is in use).
H PARA EX -99 to +99 ( $\pm 0$ )		Compensate the H Para shading (when an extender is in use).
V SAW EX -99 to +99 ( $\pm 0$ )		Compensate the V Saw shading (when an extender is in use).
V PARA EX -99 to +99 ( $\pm 0$ )		Compensate the V Para shading (when an extender is in use).

## OTHERS Menu

### OTHERS

Menu items	Subitems and setting values	Contents
<b>All Reset</b> Resetting to the factory status	Execute/Cancel	Select "Execute" to reset the camcorder to the factory status.
<b>Camera Data</b> Storing/recalling the menu settings	Store Execute/Cancel	Select "Execute" to store the setting values in an SxS memory card.
	Recall Execute/Cancel	Select "Execute" to retrieve the setting values from an SxS memory card.
<b>Time Zone</b> Setting the time difference	UTC -12:00 to +14:00	Set the time-zone difference from UTC in steps of 30 minutes.  <b>Note</b> The default setting is different among the sales areas. United States and Canada: -5:00 Europe area: 0:00 Oceania: +10:00
<b>Clock Set</b> Setting the built-in clock	Date/Time	Set the current time and date.
	12H/24H 12H / <b>24H</b>	Select the display mode of time. 12H: 12-hour mode 24H: 24-hour mode
	Date Mode <b>YYMMDD</b> / MMDDYY / DDMMYY	Select the display mode of the date. YYMMDD: In sequence of year, month, day MMDDYY: In sequence of month, day, year DDMMYY: In sequence of day, month, year
<b>Language</b> Selecting the language for messages	<b>English</b> / Chinese / Japanese	English: To display the messages in English Chinese: To display the messages in Chinese Japanese: To display the messages in Japanese  <b>Note</b> The "Japanese" is effective only on messages for warning and caution. The menus and status indications do not change.

OTHERS		
Menu items	Subitems and setting values	Contents
<b>Assign Button</b> Assigning functions to the assignable buttons	<1> Off / Marker / Last Clip DEL / ATW / Rec Review / Rec / Freeze Mix / Expanded Focus / Spotlight / Backlight / IR Remote / Shot Mark1 / Shot Mark2 / Fader / VF Mode / BRT Disp / Histogram / <b>Lens Info</b>	Assign a function to the ASSIGN button of the corresponding number. The selectable functions are common. Marker: For turning the markers on/off Last Clip DEL: For deleting the last recorded clip ATW: For turning ATW on/off Rec Review: For starting a Rec Review Rec: For starting/stopping recording Freeze Mix: For executing Freeze Mix Expanded Focus: For turning Expanded Focus on/off Spotlight: For selecting TLCS Spotlight mode Backlight: For selecting TLCS Backlight mode IR Remote: For activating/deactivating the IR Remote Commander Shot Mark1: For adding shot mark 1 Shot Mark2: For adding shot mark 2 Fader: For turning the Fader function on/off VF Mode: For switching between color and monochrome modes of the viewfinder
	<2> Off / Marker / Last Clip DEL / ATW / Rec Review / Rec / Freeze Mix / Expanded Focus / Spotlight / Backlight / IR Remote / Shot Mark1 / Shot Mark2 / Fader / VF Mode / <b>BRT Disp</b> / Histogram / Lens Info	BRT Disp: For turning the brightness level indication on/off Histogram: For turning the histogram indication on/off Lens Info: For turning the depth-of-field indication on/off Off: No function
	<3> Off / Marker / Last Clip DEL / ATW / Rec Review / Rec / Freeze Mix / Expanded Focus / Spotlight / Backlight / IR Remote / Shot Mark1 / Shot Mark2 / Fader / VF Mode / BRT Disp / <b>Histogram</b> / Lens Info	
	<4> <b>Off</b> / Marker / Last Clip DEL / ATW / Rec Review / Rec / Freeze Mix / Expanded Focus / Spotlight / Backlight / IR Remote / Shot Mark1 / Shot Mark2 / Fader / VF Mode / BRT Disp / Histogram / Lens Info	
	<b>Tally</b> Setting the tally lamps	Front <b>High</b> / Low / Off  Rear <b>On</b> / Off
<b>Hours Meter</b> Displaying the hours meter	Hours (Sys)	The non-resettable accumulated time of use is displayed
	Hours (Reset)	The resettable accumulated time of use is displayed
	Reset Execute/Cancel	Select "Execute" to reset the Hours (Reset) value to 0.
<b>IR Remote</b> Activating/ deactivating the Remote Commander	<b>On / Off</b>	Set to "On" to activate remote control operations from the supplied IR Remote Commander.
	<b>Note</b>	The setting automatically returns to "Off" when the camcorder is turned off.

OTHERS		
Menu items	Subitems and setting values	Contents
<b>Battery Alarm</b> Setting the low power alarm	Low BATT 5% / <b>10%</b> / 15% / ... / 45% / 50%	Set the battery level at which the Low BATT warning is generated (in steps of 5%).
	BATT Empty 3% to 7% ( <b>3%</b> )	Set the battery level at which the BATT Empty warning is generated.
	DC Low Volt1 11.5 V to 17.0 V ( <b>11.5 V</b> )	Set the DC IN voltage at which the DC Low Volt1 warning is generated.
	DC Low Volt2 11.0 V to 14.0 V ( <b>11.0 V</b> )	Set the DC IN voltage at which the DC Low Volt2 warning is generated.
<b>Battery INFO</b> Showing information regarding the battery pack (display only)	Type	The type (product name) is displayed.
	MFG Date	The date of manufacture is displayed.
	Charge Count	The accumulated number of times of charge/discharge is displayed.
	Capacity	The estimated total capacity of full charge is displayed.
	Voltage	The current output voltage is displayed.
	Remaining	The current remaining level is displayed.
<b>Genlock</b> Setting Genlock operation	24P System <b>60i</b> / 24PsF	Select the synchronization mode when the video format is HQ1080/24P. (Invalid with formats other than HQ1080/24P.)
	GL H Phase -999 to +999 ( <b>±0</b> )	Set the H phase (phase of the horizontal sync signal) for genlock operation.
	H Advance <b>0H</b> / 90H	Adjust the output phase with respect to the reference signal: 0H: The phase of the output signal is to match that of the reference signal. 90H: When the reference signal is SD, the phase of HD output is to advance 90H. (There will be no phase difference between the reference signal and SD.) When the reference signal is HD, the phase of SD output delays 90H. (There will be no phase difference between the reference signal and HD output.)
<b>Direct Menu</b> Setting the Direct menu function	All / <b>Part</b> / Off	All: All Direct menu operations are permitted. Part: A part of Direct menu operations is permitted. The operation is limited depending on the GAIN, SHUTTER, or WHITE BAL switch setting. Off: No Direct menu operation is permitted.
<b>i.LINK I/O</b> Setting for input/output at the i.LINK connector	Enable / <b>Disable</b>	Enable: To use the i.LINK connector Disable: To not use the i.LINK connector
<b>Trigger Mode</b> Setting whether to trigger recording start/stop for an external device connected to via the i.LINK connector	Internal / <b>Both</b> / External	<b>Notes</b>
		<ul style="list-style-type: none"> <li>When you set this item to “Enable,” no signal is fed out from the SDI OUT connector.</li> <li>When the video format is not SP mode, signal input/output via the i.LINK connector is not enabled, even if this item is set to “Enable.”</li> </ul>
		Internal: To activate recording start/stop operations only for an SxS memory card in a built-in slot. Both: To activate recording start/stop operations both for an SxS memory card in a built-in slot and the external recording device connected via the i.LINK connector. External: To activate recording start/stop operations only for the external recording device connected via the i.LINK connector.

## OTHERS

Menu items	Subitems and setting values	Contents
<b>Country</b> Setting the area for use	NTSC Area / PAL Area	Select the color system for the area where you will use the camcorder.
		<p><b>Note</b></p> <p>The default setting is different among the sales areas.            United States and Canada: NTSC            Other areas: PAL</p>
<b>Video Format</b> Selecting the video format	Country: NTSC Area	Select the video format (bit rate, picture size, frame rate, and scan system in combination).
	HQ 1080/60i	<ul style="list-style-type: none"> <li>• Bit rate               <ul style="list-style-type: none"> <li>HQ or SP</li> </ul> </li> <li>• Picture size               <ul style="list-style-type: none"> <li>1080 or 720</li> </ul> </li> <li>• Frame rate               <ul style="list-style-type: none"> <li>24, 25, 30, 50, or 60</li> </ul> </li> <li>• Scan system               <ul style="list-style-type: none"> <li>i (interlace) or P (progressive)</li> </ul> </li> </ul> <p><b>Note</b></p> <p>The default setting is different among the sales areas.            United States and Canada: HQ 1080/60i            Other areas: HQ 1080/50i</p>
	SP 1080/60i	
	HQ 1080/30P	
	HQ 1080/24P	
	SP 1080/24P	
	HQ 720/60P	
	HQ 720/30P	
	HQ 720/24P	
	Country: PAL Area	
HQ 1080/50i		
SP 1080/50i		
HQ 1080/25P		
HQ 720/50P		
HQ 720/25P		
<b>Clip</b> Setting for clip name or deletion	Title Prefix <b>nnn_</b> (nnn=least three digits of the serial number)	Set the first 4-alphanumeric part of the clip names. You can use upper- and lowercase alphabets, numerics 0 to 9, - (hyphen), and _ (underscore).
	Number Set 0001 to 9999	Set the second 4-numeric part of the clip name.
	Update Media(A)/Media(B) Execute / Cancel	Select "Execute" to update the managerial file on the SxS memory card in the selected slot. <sup>1)</sup>
	Last Clip DEL Execute / Cancel	Select "Execute" to delete the last recorded clip.
	All Clips DEL Execute / Cancel	Select "Execute" to delete all clips on the active SxS memory card.
		<p><b>Note</b></p> <p>Clips to which you applied OK mark cannot be deleted.</p>
		Select "Execute" to format the SxS memory card in slot A.
<b>Format Media</b> Formatting SxS memory cards	Media (A) Execute / Cancel	Select "Execute" to format the SxS memory card in slot A.
	Media (B) Execute / Cancel	Select "Execute" to format the SxS memory card in slot B.

<sup>1)</sup>If clips cannot be played back, updating the managerial file on the card may improve the condition.

## Connecting External Devices

# Connecting External Monitors

To display recording/playback pictures on an external monitor, select the output signal and use

an appropriate cable for the monitor to be connected.

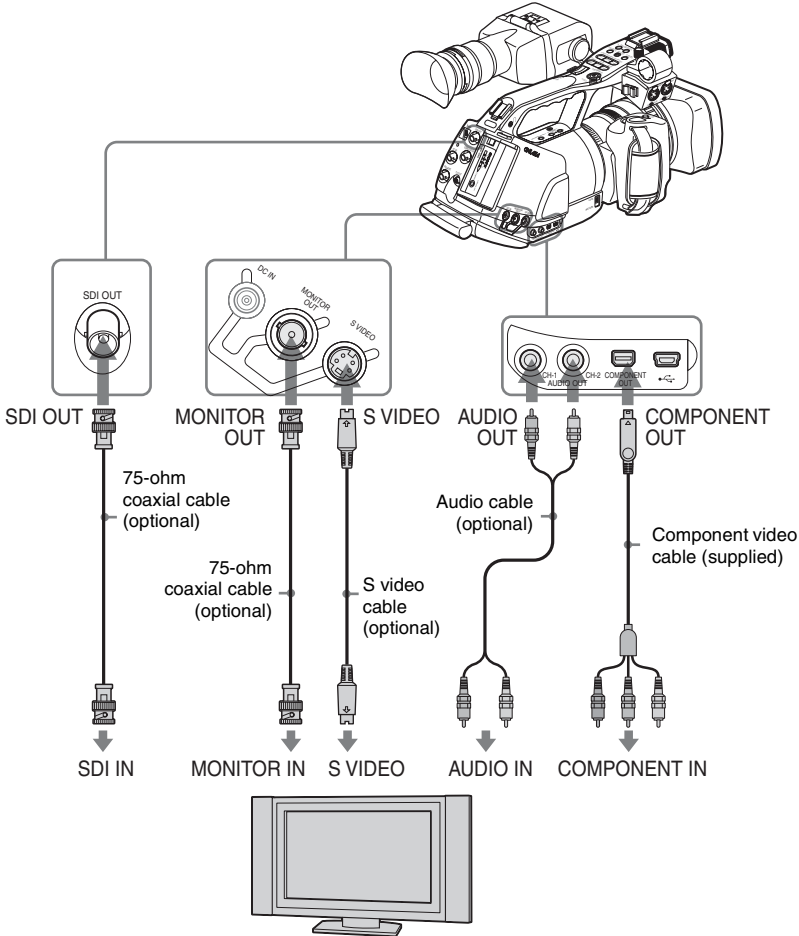

Connecting External Devices

Regardless of whether the signal is HD or SD, the same status information and menus can be displayed on the external monitor as those in the viewfinder.

According to the signal fed to the monitor, set “YPbPr/SDI Out Display” or “Video Out Display” of the VIDEO SET menu (page 119) to “On.”

When outputting SD signals, select in advance the output mode (Squeeze, Letterbox, or Edge Crop) with “Down Converter” of the VIDEO SET menu.

### Note

SD signals down-converted for output have the following restrictions:



Images of 50P/50i/25P are output as PAL signals, those of 59.94P/59.94i/29.97P are output as NTSC signals, and those of 23.98P are output as 2-3 pulled-down NTSC signals.

---

### SDI OUT connector (BNC type)

---

The connector is set at the factory to output an HD SDI signal.

Using “YPbPr/SDI Out Select” (*page 119*) of the VIDEO SET menu, you can change the setting so that it outputs an SD SDI signal. (The HD/SD switching becomes valid also on the COMPONENT OUT connector in synchronization.)

Use a commercially available 75-ohm coaxial cable for connection.

#### To display the menus and status information on the connected monitor

Set “YPbPr/SDI Out Display” (*page 119*) of the VIDEO SET menu to “On.”

#### Note

If input/output at the i.LINK (HDV) connector are enabled (*page 132*), no signal is fed out from the SDI OUT connector.

---

### COMPONENT OUT connector (mini-D connector)

---

The connector is set at the factory to output HD analog component signals for monitoring.

Using “YPbPr/SDI Out Select” (*page 119*) of the VIDEO SET menu, you can change the setting so that it outputs down-converted analog component signals for monitoring. (The HD/SD switching becomes valid also on the SDI OUT connector in synchronization.)

Use the supplied component video cable for connection.

#### To display the menus and status information on the connected monitor

Set “YPbPr/SDI Out Display” (*page 119*) of the VIDEO SET menu to “On.”

---

### MONITOR OUT connector (BNC type)

---

The connector outputs down-converted SD analog composite signals for monitoring.

Use a commercially available 75-ohm coaxial cable for connection.

#### To display the menus and status information on the connected monitor

Set “Video Out Display” (*page 119*) of the VIDEO SET menu to “On.”

---

### S VIDEO connector (S connector)

---

The connector outputs YC separate signals for monitoring.

Use a commercially available S video cable for connection.

#### To display the menus and status information on the connected monitor

Set “Video Out Display” (*page 119*) of the VIDEO SET menu to “On.”

---

### AUDIO OUT CH1/CH2 connectors (RCA phono jacks)

---

The connectors output recording/playback audio signals of the respective channels.

Use a commercially available audio cable for connections.

# Operating Clips With a Computer

The clips recorded on SxS memory cards with this camcorder can be controlled on a computer or edited using the optional nonlinear editing software.

For these purposes, the clips on an SxS memory card can be operated by directly loading the card in a computer or by connecting the camcorder or the optional SBAC-US10 SxS Memory Card USB Reader/Writer to the computer, using an USB cable as shown below.

## Preparations

### To use the ExpressCard slot of a computer

If the computer is equipped with an ExpressCard/34 or ExpressCard/54 slot, you can directly insert the SxS memory card containing clips recorded with this camcorder and access to the files.

For the operating requirements for the computer, see "Using the CD-ROM" on page 14..

#### Note

The SxS Device Driver Software on the CD-ROM supplied with the camcorder must be installed on your computer. Before installation, be sure to read the enclosed SxS Device Driver Software End-User License Agreement.

For information on installation of the driver, refer to the *ReadMe* on the supplied CD-ROM.

For support information for the driver, visit the following URL:

<http://www.sony.net/SxS-Support/>

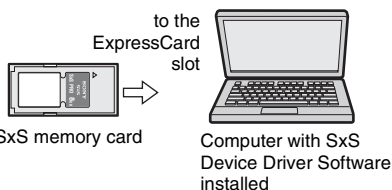

With a Windows computer, check that a Removable Disk appears in My Computer. This indicates normal status.

With a Macintosh computer, an icon is displayed on the menu bar.

### To connect with a USB cable

When you connect the camcorder or the SBAC-US10 SxS Memory Card USB Reader/Writer (optional) using the supplied USB cable, the memory card in the slot is acknowledged as an extended drive by the computer.

When two memory cards are mounted in this camcorder, they are acknowledged as two independent extended drives by the computer.

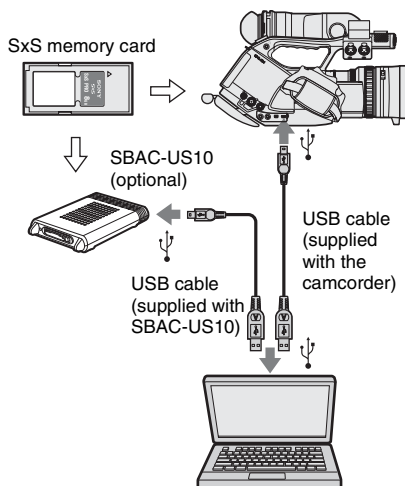

#### Notes

- When connecting the USB cable to the computer, be careful to check the form and direction of the USB connector.
- The camcorder and the SBAC-US10 do not work on the bus power from the computer. Supply the operating power independently.

### To check the connection to the camcorder

#### 1 Turn the camcorder on by setting the power switch to CAMERA or MEDIA.

A message prompting you to confirm that you wish to enable the USB connection is displayed in the viewfinder.

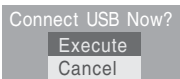

#### Note

This message will not be displayed while another confirmation message or in-progress

message (e.g., for formatting or restoration of an SxS memory card) is shown on the screen. It appears when formatting or restoration is completed.

The message is also not displayed while the CLIP INFO screen is shown on the screen. It appears when an operation on the CLIP INFO screen is completed or you return to the thumbnail screen.

## 2 Select “Execute” by operating the jog dial or the joystick.

The screen displays the following:



## 3 With Windows, check that the memory card is displayed as a removable disk in My Computer.

**With Macintosh, check that a “NO NAME” or “Untitled” folder was created on the desktop.**

This indicates that the connection is active. (The folder name on the desktop of the Macintosh computer can be changed as needed.)

### Note

The following operations must be eliminated when the access lamp is lit in red.

- Turning the power off or disconnecting the power cord
- Removing the SxS memory card
- Disconnecting the USB cable

*When using the SBAC-US10, refer to the operating instructions of the SBAC-US10.*

---

## Removing an SxS memory card

---

### Windows

1. Click on the icon of “Safely Remove Hardware” on the task bar of the computer.
2. Select “Safely remove SxS Memory Card - Drive(X:)” from the displayed menu.
3. Check that the Safe To Remove Hardware message appears then remove the card.

### Macintosh

Drag the SxS memory card icon on the desktop to Trash.

If the SxS memory card icon is located on Finder, click on the eject icon on its side.

### Note

Do not select “Card Power Off” from the SxS memory card icon displayed on the menu bar.

---

## Using the XDCAM EX Clip Browsing Software

---

To copy clips to the local disk of a computer, the XDCAM EX Clip Browsing Software must be used.

Install the XDCAM EX Clip Browsing Software on the supplied CD-ROM to your computer.

Although the data regarding recorded materials are stored over multiple files and folders, you can easily handle the clips without considering such data and directory structure by using the XDCAM EX Clip Browsing Software.

### Note

If you operate, e.g. copy the clips on the SxS memory card by using the Explorer (Windows) or Finder (Macintosh), the subsidiary data contained by the clips may not be maintained. To avoid such a problem, use the XDCAM EX Clip Browsing Software.

*See page 14 for the operating requirements, and refer to the User’s Guide contained in the CD-ROM.*

*For support information on the XDCAM EX Clip Browsing Software, visit the web sites shown in “XDCAM EX web sites” on page 13 or on the cover page of the supplied CD-ROM.*

---

## Using a nonlinear editing system

---

For a nonlinear editing system, optional editing software that corresponds to the recording formats used with this camcorder is required.

Store the clips to be edited on the HDD of your computer in advance, using the supplied XDCAM EX Clip Browsing Software.

Some editing software may not operate properly. Be sure to confirm before use that it conforms to the recording formats used with this camcorder.

### To use Final Cut Pro of Apple Inc.

It is necessary to convert the clips to files that can be edited with the Final Cut Pro, using XDCAM Transfer.

For information on XDCAM Transfer, visit the web sites shown in “XDCAM EX web sites” on page 13 or on the cover page of the supplied CD-ROM.

## Connecting an External Device (i.LINK Connection)

When an HDV-compatible video format (SP 1080/60i, SP 1080/50i, or SP 1080/24P) is selected, you can record the same images as those recorded on the memory card in this camcorder on an external device connected to the i.LINK(HDV) connector, or record the playback picture of the external device on the memory card in the camcorder.

Nonlinear editing conforming to the HDV format is also enabled.

### Notes

- When the video format is not SP mode, signal input/output via the i.LINK connector is not enabled, even if “i.LINK I/O” is set to “Enable.”
- When a cable is connected to the i.LINK(HDV) connector during playback, the display returns to the thumbnail screen.
- Use the i.LINK(HDV) connector only for one-to-one i.LINK connection.

## Recording the Camcorder Picture on an External Device

When you set the camcorder to Camera mode, the picture being shot with this camcorder is output as an HDV stream via the i.LINK(HDV) connector. It can be recorded on a connected HDV recorder in synchronization with the REC START/STOP operation on this camcorder.

### 1 Perform the preparatory settings of the camcorder.

- Set the video format to SP 1080/60i, SP 1080/50i, or SP 1080/24P.
- Set “i.LINK I/O” (page 126) of the OTHERS menu to “Enable.”
- Set “Trigger Mode” (page 126) of the OTHERS menu to “Both” or “External.”

**Both:** To record both on the memory card in the camcorder and on the external device

**External:** To record only on the external device

## 2 Set the external device to recording standby status.



For operations of the external device, refer to the operation manual of that device.

## 3 Set the camcorder to Camera mode by setting the power switch to CAMERA.

## 4 Press the REC START/STOP button.

The external device starts recording in synchronization.

The status of the external device is displayed in the i.LINK status indication area (page 23) in the viewfinder.

Indication	Status of the external device
STBY 	In HDV recording standby
●REC 	In HDV recording

### Notes

- Operation may be different depending on the type of external device.
- Although there is some time lag from which you press the REC START/STOP button until the i.LINK status indication changes, the same pictures are recorded on the memory card in this camcorder and the external device if “Trigger Mode” is set to “Both.”
- While you can record shot marks on the memory card during recording, they are not added to the pictures recorded on the external device.

## Nonlinear Editing

You can transfer an HDV stream to a nonlinear editing system connected via the i.LINK(HDV) connector.

### Notes

- The i.LINK(HDV) connector of this camcorder is a 4-pin connector. Check the number of pins of the i.LINK connector on your computer and use an appropriate i.LINK cable.
- In searching pictures of this camcorder on the computer, it may take some time until the display is reflected on the computer.
- If the playback clip is short or the playback starting point is near the end of the clip, the i.LINK signal may be interrupted between the clip and the next clip. When you try to capture

such a signal using the nonlinear editing system, a malfunction may occur, depending on the nonlinear editing software in use.

- If you specify a search speed other than 4 or 15 times normal with the nonlinear editing system, no i.LINK signal is fed out. In such a case, the picture may stay frozen.
- High-speed playback picture may not be displayed on the computer screen, depending on the nonlinear editing software in use.

### Setting on this camcorder

Set “i.LINK I/O” of the OTHERS menu to “Enable.”

For operations of the nonlinear editing software, refer to the operation manual of the software.

## Recording External Input Signals

The HDV stream input from a device connected via the i.LINK connector can be recorded on an SxS memory card in this camcorder.

The timecodes superimposed on the i.LINK input are recorded regardless of the settings of the camcorder.

### 1 Set the external signal to a format that can be recorded on the camcorder.

Signals of 1440 × 1080/59.94i can be recorded when “Video Format” (page 127) is set to SP 1080/60i or SP 1080/24P. Signals of 1440 × 1080/50i can be recorded when set to SP 1080/50i.

Recording is not allowed with other combinations of “Video Format” and input signals.

### 2 Set “i.LINK I/O” (page 126) of the OTHERS menu to “Enable.”

### 3 Set the camcorder to Media mode.

### 4 Press the STOP button to set the camcorder to STOP mode.

The input image is displayed in the viewfinder and the monitor connected via the COMPONENT OUT connector or MONITOR OUT connector.

The audio signal is output from the built-in speaker (or headphones connected to the headphone jack) and the monitor speakers connected to the AUDIO OUT connectors.

## 5 Press the REC START/STOP button on the handle.

Recording begins.

### Notes

- The REC START/STOP button on the grip does not function.
- An error is generated in the following cases. In such a case, cancel Recording mode by pressing the REC START/STOP button.
  - The video format of input signal does not match that specified on the camcorder.
  - A copy-protected stream is being fed in.
- If the input to the camcorder becomes no signal during recording, the tally lamps and the i.LINK ●REC status indication in the viewfinder flash, indicating that no signal is being recorded on the SxS memory card. When an input signal is resumed, recording is restarted, incrementing the clip number on the memory card.

## External Synchronization

When multiple units of the PMW-EX3 are used in the same shooting location, recording can be made in synchronization with a specific reference signal, and the timecode can be matched among all the units.

### Aligning the phase of the video signal (Genlock)

Genlock operation is enabled by supplying an SD or HD reference signal to the GENLOCK IN connector of the camcorder.

If the video format is set to HQ 1080/24P, select the sync mode (60i or 24PsF) with “Genlock” (*page 126*) of the OTHERS menu.

The phase adjustment for the reference signal can also be made with “Genlock” of the OTHERS menu.

### Notes

- If the reference signal is unstable, genlock is not possible.
- The subcarrier is not synchronized.

### Synchronizing the timecode of your camcorder with that of another unit

The timecode of your camcorder can be locked to that of another unit.

Set the unit that supplies the timecode to a mode in which the timecode output keeps advancing (Free Run or Clock mode).

- 1 Set “Timecode” of the TC/UB SET menu as follows:**
  - Mode: Preset
  - Run: Free Run
- 2 Press the TC/U-BIT/DURATION button so that the timecode is displayed on the screen.**
- 3 Supply an HD or SD reference video signal to the GENLOCK IN connector and the reference timecode to the TC IN connector.**

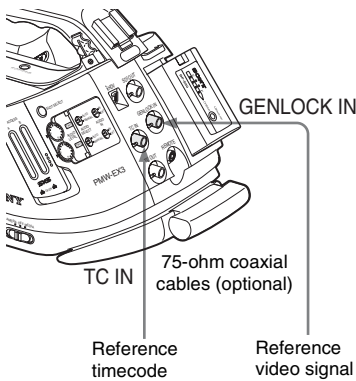

Thus the built-in timecode generator of your camcorder locks to the reference timecode. The message “EXT-LK” is displayed on the screen.



After about 10 seconds, you can disconnect the external timecode without losing the synchronization.

#### Notes

- Check that the reference timecode and the reference video signal are in a phase relation that complies the SMPTE timecode standards.
- When you finish the above procedure, the timecode is immediately synchronized with the external timecode, and the time data indication will show the value of the external timecode. However, wait for a few seconds until the timecode generator stabilizes before recording.
- If the frequency of the reference video signal is not the same as the frame frequency of the camcorder, the camcorder cannot be correctly genlocked. In such a case, the timecode is not correctly synchronized with the external timecode.
- When the connection is removed, the timecode advance may shift one frame per hour with respect to the reference timecode.

### To release the external timecode synchronization

Change the “Timecode” setting of the TC/UB SET menu or turn off the camcorder.

External synchronization is also released when you start recording in a special recording mode (Slow & Quick Motion, Frame Rec, or Interval Rec).

### Synchronizing the timecode of another unit with that of your camcorder

The timecode of another unit can be locked to that of your camcorder.

- 1 Specify the timecode of your camcorder with “Timecode” and “TC Format” (see page 66).
- 2 Connect the TC OUT connector and MONITOR OUT connector with the timecode input and reference signal input of the other unit, respectively.

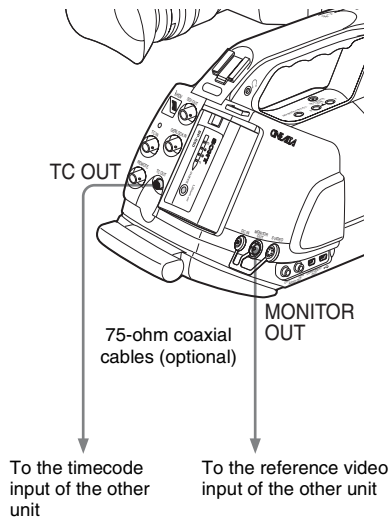

## Operating From the RM-B750/B150

When the optional RM-B750 or RM-B150 Remote Control Unit is connected, various settings of the camcorder can be performed from the Remote Control Unit.

You can operate the menus of the camcorder and monitor the picture on the RM-B750 or a video monitor connected via the MONITOR connector of the RM-B750/B150.

### Connection

Using the remote cable (10 m) supplied with the RM-B750/B150, connect between the REMOTE connector of the camcorder and the camera connector of the Remote Control Unit.

When you turn on the camcorder after the connection, the camcorder enters Remote Control mode.

#### Note

Use the RM-B750 of serial number 120000 or higher.

### Adjusting the camcorder from the Remote Control Unit

Turn on the camcorder by setting the power switch to the CAMERA position (Camera mode). The Picture Profile function is activated, automatically selecting Picture Profile 6.

From this status, you can control menu and recording operations from the RM-B750/B150.

*For the functions that can be controlled from the Remote Control Unit, see "Functions Operable From the RM-B750/B150 (Camera Mode)" on page 138.*

#### Notes

- Remote Control operations cannot be made if USB connection to the camcorder is enabled.
- Do not connect or disconnect the Remote Control Unit when the camcorder is on.
- The following controls of the camcorder becomes inoperative when the Remote Control Unit is connected.
  - GAIN switch
  - WHITE BAL switch
  - SHUTTER switch

- BARS/CAM button
- WHT BAL button
- FULL AUTO button

- Direct menu operation of the camcorder is disabled when the Remote Control Unit is connected.
- The ECS frequency value displayed on the Remote Control Unit may slightly differ from that on the camcorder.

### Releasing Remote Control mode

Turn off the camcorder and disconnect the RM-B750/B150.

The settings on the controls on the camcorder become valid.

## Operating the Menus of the Camcorder

In Remote Control mode, **PP** (the icon for the Picture Profile menu) is displayed at the bottom with the Setup menu icons, enabling you select the Picture Profile menu from this screen.

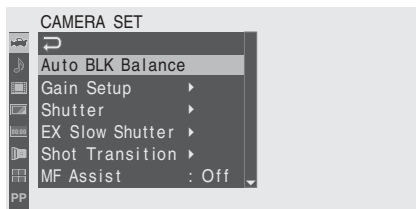

#### Note

The menu items that cannot be set in Remote Control mode are shaded and cannot be selected.

### Operating the menu from the RM-B150

Set the camcorder to Camera mode by setting the power switch to the CAMERA position in advance.

#### 1 Set the DISPLAY switch to MENU.

The menu of the camcorder appears on the monitor screen connected via the MONITOR connector of the RM-B150.

#### 2 Select and set the menu items using the MENU SELECT knob and the CANCEL/ENTER switch.



**3 When the settings are completed, set the DISPLAY switch to ON or OFF to exit the menu.**

*For details on operations of the RM-B150, refer to the Operation Manual of the RM-B150.*

---

### Operating the menu from the RM-B750

Set the camcorder to Camera mode by setting the power switch to the CAMERA position in advance.

**1 Press and light the MONITOR button then press the VF MENU button.**

The menu of the camcorder appears on the RM-B750 display and the monitor screen connected via the MONITOR connector of the RM-B750.

**2 Select and set the menu items, using the MENU SELECT knob, ENTER button, and CANCEL button.**

**3 When the settings are completed, press the VF MENU button to exit the menu.**

*For details on operations of the RM-B750, refer to the Operation Manual of the RM-B750.*

---

### Operating the Slow & Quick Motion recording from the Remote Control Unit

When the Remote Control Unit is connected, selection of “S&Q Motion” is enabled on the CAMERA SET menu, and you can perform Slow & Quick Motion recording from the Remote Control Unit.

Before starting Slow & Quick Motion recording, make the necessary settings on the menu.

**1 Select “S&Q Motion” from the CAMERA SET menu.**

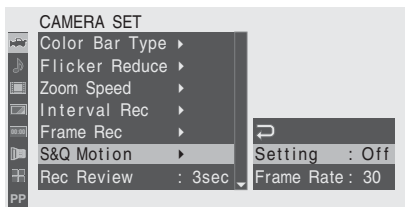

**2 Set “Setting” to “On.”**

The camcorder enters Slow & Quick Motion mode.

**3 Select the frame rate for recording with “Frame Rate.”**

**4 Press the VTR/START STOP button.**  
Slow & Quick Motion recording begins.

**To stop recording**

Press the VTR/START STOP button.

**To cancel Slow & Quick Motion mode**

Set “Setting” of “S&Q Motion” of the CAMERA SET menu to “Off.”

## Functions Operable From the RM-B750/B150 (Camera Mode)

When the camcorder is set to Camera mode, the following functions can be made using the controls, the switches, or the touch panel (RM-

B750) on the Remote Control Unit, in addition to menu operations.

Function	Operation on the camcorder	Operation on the RM-B150	Operation on the RM-B750
Menu ON/OFF	MENU button	yes	yes
Master gain selection	GAIN switch	yes	
Gain adjustment	CAMERA SET menu → Gain Setup	yes	
Step gain selection			yes
Color bar signal output ON/OFF	CAM/BAR button	yes	yes
Shutter ON/OFF	SHUTTER switch + CAMERA SET menu → Shutter	yes	yes
Shutter speed selection	CAMERA SET menu → Shutter	yes	yes
ECS ON/OFF	SHUTTER switch + CAMERA SET menu → Shutter	yes	yes
ECS frequency selection	CAMERA SET menu → Shutter	yes	yes
Auto white balance	AUTO W BAL button	yes	yes
Auto black balance	CAMERA SET menu → Auto BLK Balance	yes	yes
White R/B level adjustments		yes	yes
Black R/B level adjustments		yes	yes
White balance memory selection	WHITE BAL switch	yes	yes
Auto Tracing White ON/OFF	Assignable button (with "ATW" assigned)	yes	yes
Recording start/stop	REC START/STOP button	yes	yes
Rec Review	REC REVIEW button	yes	yes
Rec Review stop	STOP button	yes	yes
Call signal ON/OFF <sup>1)</sup>			yes

1) When you press the CALL button on the RM-B750, the message "CALL" is displayed in the viewfinder of the camcorder.

### Adjustments of the lens functions

When the supplied or optional exclusive lens is used, the following functions can also be controlled from the Remote Control Unit.

Function	Operation on the lens	Operation on the RM-B150	Operation on the RM-B750
Iris adjustment	Iris ring	yes	yes
Iris close			yes
Switching between auto iris and manual iris	IRIS switch	yes	yes

### Adjustments of the Picture Profiles

The Picture Profile menu of the camcorder can be operated from the Remote Control Unit in the same manner as on the camcorder. In addition,

some items of the Picture Profile menu can also be adjusted by using the menus or controls of the Remote Control Unit.

For details on operations of the Remote Control Unit, refer to the Operation Manual of the RM-B150/B750.

#### Notes

- The following menu and knob/switch operations on the Remote Control Unit are enabled when the menu of the camcorder is not

displayed.

The changes becomes valid and reflected on the Picture Profile menu.

- If the control knobs on the Remote Control Unit is set to Absolute mode, the corresponding items cannot be changed on the Picture Profile menu.

Picture Profile item		Operation on the RM-B150	Operation on the RM-B750
Matrix	Setting		yes
	Level		yes
	R-G, R-B, G-R, G-B, B-R, B-G		yes
Detail	Setting		yes
	Level	yes	yes
	Frequency		yes
	Crispning		yes
	H/V Ratio		yes
	White Limiter		yes
	Black Limiter		yes
	Knee APT Level		yes
Skin Tone Detail	Setting	yes	yes
	Level	yes	yes
	Area Indication		yes
	Saturation		yes
	Phase		yes
	Width		yes
Knee	Setting		yes
	Auto Knee	yes	yes
	Point	yes	yes
	Slope	yes	yes
	Knee SAT Level	yes	yes
Gamma	Level	yes	yes
	Select		yes
Black		yes	yes
Black Gamma			yes
Low Key SAT			yes

## Important Notes on Operation

### Use and Storage

#### Do not subject the unit to severe shocks

The internal mechanism may be damaged or the body warped.

#### Do not cover the unit while operating

Putting a cloth, for example, over the unit can cause excessive internal heat build-up.

#### After use

Always set the power switch to OFF.

#### Before storing the unit for a long period

Remove the battery pack.

#### Grip the handle when carrying

Grip the handle to carry. If you carry it by other parts, such as the front microphone block or the viewfinder, the camcorder may drop, causing injury.

#### Do not leave the camcorder with the lenses facing the sun

Direct sunlight can enter through the lenses, be focused in the camcorder, and cause fire.

### Shipping

- Remove the memory cards before transporting the unit.
- If sending the unit by truck, ship, air or other transportation service, pack it in the shipping carton of the unit.

### Care of the unit

Remove dust and dirt from the surfaces of the lens using a blower.

If the body of the unit is dirty, clean it with a soft, dry cloth. In extreme cases, use a cloth steeped in a little neutral detergent, then wipe dry. Do not use organic solvents such as alcohol or thinner, as these may cause discoloration or other damage to the finish of the unit.

#### In the event of operating problems

If you should experience problems with the unit, contact your Sony dealer.

### Use and storage locations

Store in a level, ventilated place. Avoid using or storing the unit in the following places:

- In excessive heat or cold (operating temperature range: 0°C to 40°C or 32°F to 104°F)  
Remember that in summer in warm climates the temperature inside a car with the windows closed can easily exceed 50°C (122°F).
- In damp or dusty locations
- Locations where the unit may be exposed to rain
- Locations subject to violent vibration
- Near strong magnetic fields
- Close to radio or TV transmitters producing strong electromagnetic fields.
- In direct sunlight or close to heaters for extended periods

#### To prevent electromagnetic interference from portable communications devices

The use of portable telephones and other communications devices near this unit can result in malfunctions and interference with audio and video signals.

It is recommended that the portable communications devices near this unit be powered off.

### About the LCD panels

The LCD panels are manufactured with extremely high-precision technology that yields effective pixel rates of 99.99% or higher.

However, very rarely, one or more pixels may be permanently dark or permanently lit in white, red, blue, or green.

This phenomenon is not a malfunction. Such pixels have no effect on the recorded data, and the unit may be used with confidence even if they are present.

### Phenomena specific to CMOS image sensors

The following phenomena that may appear in images are specific to CMOS (Complementary Metal Oxide Semiconductor) image sensors. They do not indicate malfunctions.

## White flecks

Although the CMOS image sensors are produced with high-precision technologies, fine white flecks may be generated on the screen in rare cases, caused by cosmic rays, etc.

This is related to the principle of CMOS image sensors and is not a malfunction.

The white flecks especially tend to be seen in the following cases:

- when operating at a high environmental temperature
- when you have raised the master gain (sensitivity)
- when operating in Slow-Shutter mode

## Aliasing

When fine patterns, stripes, or lines are shot, they may appear jagged or flicker.

## Flicker

If recording is made under lighting produced by discharge tubes, such as fluorescent, sodium, or mercury-vapor lamps, the screen may flicker, colors may vary, or horizontal stripes may appear distorted. In such cases, turn the Flicker-Reduction function on (*see page 65*).

In some cases, such phenomena may not be improved with the Flicker-Reduction function.

It is recommend to set the electronic shutter speed to  $1/100$  sec. in 50-Hz areas and to  $1/60$  in 60-Hz areas.

## Focal plane

Owing to the characteristics of the pickup elements (CMOS sensors) for reading video signals, subjects that quickly move across the screen may appear slightly skewed.

The luminance at the top and bottom of the screen may change when shooting a flashlight or a light source that quickly flashes.

# Formats and Limitations of Outputs

## Video Formats and Output Formats

The format of output signals from the COMPONENT OUT connector and the SDI OUT connector varies according to the recording/playback video formats and the kind of the output signal (the setting of “YPbPr/SDI Out Select” of the VIDEO SET menu).

### Output formats in E-E mode<sup>1)</sup>/recording mode (Camera mode)

Analog component signals from the COMPONENT OUT connector are output in the format shown below according to the “Video Format” setting of the OTHERS menu and the “YPbPr/SDI Out Select” setting (HD or SD) of the VIDEO SET menu.

The SDI OUT connector outputs serial digital signals of the same format as that of the analog component signals fed from the COMPONENT OUT connector.

<sup>1)</sup>E-E mode: Recording standby status

Video format	Output format	
	YPbPr Out Select: HD	YPbPr Out Select: SD
1080/59.94i	1080/59.94i	480/59.94i
1080/29.97P	1080/29.97PsF	480/59.94i
1080/23.98P	1080/59.94i <sup>1)</sup>	480/59.94i
720/59.94P	720/59.94P	480/59.94i
720/29.97P	720/59.94P	480/59.94i
720/23.98P	720/59.94P	480/59.94i
1080/50i	1080/50i	576/50i
1080/25P	1080/25PsF	576/50i
720/50P	720/50P	576/50i
720/25P	720/50P	576/50i

<sup>1)</sup>It becomes 1080/24PsF if “24P System” of “Genlock” (*page 126*) is set to “24PsF” on the OTHERS menu.

### Output formats in clip playback mode (Media mode)

Analog component signals from the COMPONENT OUT connector are output in the

format shown below according to the video format of the playback clip and the “YPbPr/SDI Out Select” setting (HD or SD) of the VIDEO SET menu.

The SDI OUT connector outputs serial digital signals of the same format as that of the analog component signals fed from the COMPONENT OUT connector.

**When the frame rate setting of the video format is 59.94i/59.94P/29.97P/23.98P**

Clip format	Output format	
	YPbPr Out Select: HD	YPbPr Out Select: SD
1080/59.94i	1080/59.94i	480/59.94i
1080/29.97P	1080/29.97PsF	480/59.94i
1080/23.98P	1080/59.94i	480/59.94i
720/59.94P	720/59.94P	480/59.94i
720/29.97P	720/59.94P	480/59.94i
720/23.98P	720/59.94P	480/59.94i
1080/50i	1080/59.94i <sup>1), 2)</sup>	480/59.94i <sup>1)</sup>
1080/25P	1080/29.97PsF <sup>1), 2)</sup>	480/59.94i <sup>1)</sup>
720/50P	720/59.94P <sup>1), 2)</sup>	480/59.94i <sup>1)</sup>
720/25P	720/59.94P <sup>1), 2)</sup>	480/59.94i <sup>1)</sup>

- 1) No signal is fed from the SDI OUT connector.
- 2) The actual frame rate of the output signal is 1.001 times of the value shown in the table. Some frame may be repeated when converting the frame rate.

**When the frame rate setting of the video format is 50i/50P/25P**

Clip format	Output format	
	YPbPr Out Select: HD	YPbPr Out Select: SD
1080/59.94i	1080/50i <sup>1), 2)</sup>	576/50i <sup>1)</sup>
1080/29.97P	1080/25PsF <sup>1), 2)</sup>	576/50i <sup>1)</sup>
1080/23.98P	1080/50i <sup>1), 2)</sup>	576/50i <sup>1)</sup>
720/59.94P	720/50P <sup>1), 2)</sup>	576/50i <sup>1)</sup>
720/29.97P	720/50P <sup>1), 2)</sup>	576/50i <sup>1)</sup>
720/23.98P	720/50P <sup>1), 2)</sup>	576/50i <sup>1)</sup>
1080/50i	1080/50i	576/50i
1080/25P	1080/25PsF	576/50i
720/50P	720/50P	576/50i
720/25P	720/50P	576/50i

- 1) No signal is fed from the SDI OUT connector.
- 2) The actual frame rate of the output signal is 1/1.001 of the value shown in the table. Some frame may be deleted when converting the frame rate.

## Limitations of Outputs

The outputs from the camcorder are limited by the VIDEO SET menu settings as follows. These limitations are common to Camera mode and Media mode.

Menu settings	i.LINK I/O	Enable	Disable	Enable	Disable	Enable	Disable
	YPbPr/SDI Out Select		HD	HD	SD	SD	Off
Outputs from the output connectors	i.LINK(HDV)	HDV	No signal	HDV	No signal	HDV	No signal
	SDI OUT	No signal	HD	No signal	SD	No signal	No signal
	COMPONENT OUT	HD	HD	SD	SD	No signal	No signal
	MONITOR OUT	SD	SD	SD	SD	SD	SD
	S VIDEO	SD	SD	SD	SD	SD	SD

# Lens File Operations

Up to 6 lens files can be used with this camcorder.

File ID		Applicable lens
File No.	File name	
01	VCL-614B2X	VCL-614B2X exclusive standard zoom lens (supplied)
02	XS8X4AS-XB8	Fujinon XS8X4AS-XB8 exclusive wide zoom lens (optional)
U1	User_File1	User-definable
U2	User_File2	
U3	User_File3	
U4	User_File4	

By storing the characteristics (compensation data) specific to lenses in the files in the built-in memory, the optimum compensation can be easily made merely by retrieving the appropriate file upon lens replacement.

The optimum compensation data for the exclusive lenses are stored in File 01 and File 02, respectively, at the factory and are automatically retrieved when the corresponding lenses are mounted.

When using other lenses than the exclusive lenses, you can store the compensation data in Files U1 to U4 with the LENS menu.

## Storing compensation data for a non-exclusive lens

The same compensation data as those in the file for the supplied standard lens (01: VCL-614B2X) are stored in all the user-definable files U1 to U4.

To use a non-exclusive lens, store the compensation data in a file by proceeding as follows:

- 1 Mount a lens for which you wish to store the compensation data in a file.**
- 2 Set the camcorder to Camera mode by setting the power switch to the CAMERA position.**

- 3 Adjust the white balance.**
- 4 Press the MENU button to set the camcorder to Menu mode and select the LENS menu with .**
- 5 Select “Flare” and set the flare compensation values for R, G, and B.**



(Set the items with “EX” when a lens extender is in use.)

- 6 Select “Shading” and set the shading compensation values for each channel (R, G, and B).**

First specify the channel (R, G, or B) with “Shading CH” then set the values.

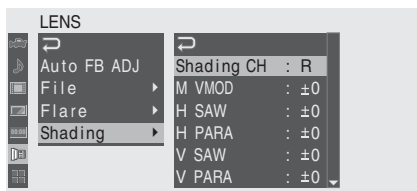

(Set the items with “EX” when a lens extender is in use.)

- 7 When the adjustments are finished, select “File.”**

When the mounted lens is a serial lens, the corresponding lens ID is displayed in the Lens ID column.

When the mounted lens is a non-serial lens, “unknown” is displayed in the Lens ID column.

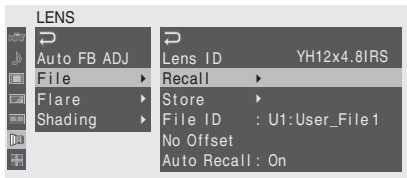

**8 Select “Store” and specify the file in which you wish to store the data.**

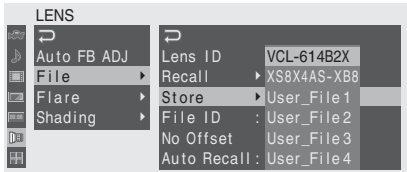

**9 When the confirmation message is displayed, select “Execute.”**

If the lens is a serial lens, the corresponding lens file is automatically retrieved when you next mount the lens, as long as “Auto Recall” is set to “On.”

If the lens is a non-serial lens or if “Auto Recall” is set to “Off,” retrieve the corresponding file with a menu operation (Recall) when you next mount the lens.

**To change the file name**

The initial file names (User\_File1 to User\_File4) can be changed with “File ID” of the menu (up to 16 characters).

**To clear the compensation data**

The compensation data of the current lens file can be cleared to the factory-set values by selecting “No Offset” from the menu.

*For details on menu operations, see “Basic Menu Operations” on page 111.*

# Backup Battery

This camcorder uses a backup battery to retain various setting data.

A lithium battery (CR2032) for backup is mounted in the camcorder at the factory.

The backup battery retains the date, time, and timecode in Free Run mode even when no operating power is being supplied.

## Service life of the backup battery

When the backup battery’s voltage falls, the backup battery low-voltage warning appears in the viewfinder.

If this warning appears, replace the battery as soon as possible.

**WARNING**

Battery may explode if mistreated.

Do not recharge, disassemble, or dispose of in fire.

**CAUTION**

Danger of explosion if battery is incorrectly replaced. Replace only with the same or equivalent type recommended by the manufacturer. Dispose of used batteries according to the manufacturer’s instructions.

## Replacing the backup battery

**Notes**

- Be sure to set the power switch to OFF when replacing the backup battery.
- Be careful not to drop the removed screw into the camcorder.

**1 Open the cover of the backup battery holder on the bottom by loosening the screw, and remove the battery.**



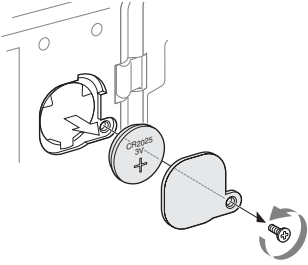

- 2** Insert a new backup battery (CR2032) with the + symbol on the battery facing outside.

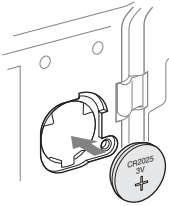

- 3** Attach the cover in the original position.

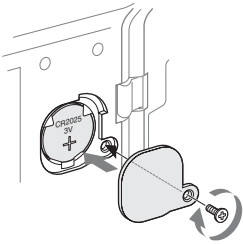

# Troubleshooting

## Operating Power

Symptoms	Cause	Remedy
The camcorder does not power on when you set the power switch either to CAMERA or MEDIA.	No battery pack is mounted and no power is supplied to the DC IN connector.	Mount a battery pack ( <i>page 26</i> ) or connect an AC power using the BC-U1( <i>page 27</i> ) .
	The battery pack is completely exhausted.	Replace the battery pack with a fully charged one ( <i>page 26</i> ).
The power supply cuts while operating.	The battery pack becomes exhausted.	Replace the battery pack with a fully charged one ( <i>page 26</i> ).
The battery pack becomes exhausted very quickly.	The ambient temperature is very low.	This owes to the battery characteristics and is not a defect.
	The battery pack is inadequately charged.	Recharge the battery pack ( <i>page 26</i> ). If the battery pack is soon exhausted even after you charged it fully, it may come to the end of its life. Replace it with a new one.

## Recording/Playback

Symptoms	Cause	Remedy
Recording does not start when you press the REC START/STOP button.	The power switch is set to OFF or MEDIA.	Set the power switch to CAMERA.
	The SxS memory card is write-protected.	Release the write protection ( <i>page 41</i> ), or replace the card with a non-protected SxS memory card.
	The SxS memory card is full.	Replace the card with one having sufficient space.
	The SxS memory card needs restoration.	Restore the memory card ( <i>page 44</i> ).
Playback does not start when you press the PLAY button.	The power switch is set to OFF or CAMERA.	Set the power switch to MEDIA.
The supplied IR Remote Commander does not work.	Remote control operation is disabled.	Enable remote control operation ( <i>page 39</i> ).
	The battery of the IR Remote Commander is exhausted.	Replace the battery with a new one.
Audio recording is not possible.	The AUDIO LEVEL (CH-1/CH-2) controls are set to the minimum level.	Adjust the audio recording levels with the AUDIO LEVEL (CH-1/CH-2) controls ( <i>page 68</i> ).
The recorded sound is distorted.	The audio level is too high.	Adjust the audio recording levels with the AUDIO LEVEL (CH-1/CH-2) controls ( <i>page 68</i> ), and record again.
The recorded sound has a high noise level.	The audio level is too low.	Adjust the audio recording levels with the AUDIO LEVEL (CH-1/CH-2) controls ( <i>page 68</i> ), and record again.

## External Devices

Symptoms	Cause	Remedy
The equipment connected to the camcorder via an i.LINK connection does not react as expected, for example, no picture appears on its screen.	It sometimes takes time for the connected equipment to recognize the operation.	Wait for about 15 seconds. If the connected equipment still does not react, do the following: <ul style="list-style-type: none"><li>• Check the i.LINK cable, for example, by re-plugging it.</li><li>• Turn the power off, and connect the cable again.</li><li>• Change the i.LINK cable.</li></ul>

# Error/Warning Indications

The camcorder informs you of situations where warning, caution, or an operation check is required, through messages in the viewfinder, the tally lamps, and a buzzer.

The buzzer is output to the built-in speaker or to the headphones connected via the headphone connector. The buzzer volume can be adjusted with “Alarm Level” in “Audio Output” of the AUDIO SET menu.

## Error Indications

The camcorder stops operation after the following indications.

Error indication in the viewfinder	Buzzer	Tally lamps	Cause and measures
E + Error code	Continuous	Rapidly flashing	The camcorder may be defective. Turn off the power and consult Sony service personnel. (If power cannot be turned off by setting the power switch to OFF, remove both the battery pack and the DC IN source.)

## Warning Indications

When one of the following indications is generated, follow the message to clear the problem.

Warning indication in the viewfinder	Buzzer	Tally lamps	Cause and measures
Media Near Full	Intermittent	Flashing	Free space on the SxS memory card has become insufficient. Replace it with another at the earliest opportunity.
Media Full	Continuous	Rapidly flashing	No space is left on the SxS memory card. Recording, clip copying and clip division cannot be performed. Replace it with another.
Battery Near End	Intermittent	Flashing	The battery power will be exhausted soon. Charge the battery pack at the earliest opportunity.
Battery End	Continuous	Rapidly flashing	The battery pack is exhausted. Recording cannot be performed. Connect a power source via the DC IN connector or stop operation to charge the battery pack.
Temperature High	Intermittent	Flashing	The internal temperature has risen above a safe operation limit. Suspend operation, turn off the power, and wait until the temperature falls.
Voltage Low	Intermittent	Flashing	The DC IN voltage has become low (stage 1). Check the power supply.
Insufficient Voltage	Continuous	Rapidly flashing	The DC IN voltage is too low (stage 2). Recording cannot be performed. Connect other power source.
Battery Error Please Change Battery.			An error was detected with the battery pack. Replace the battery pack with a normal one.
Backup Battery End Please Change.			The remaining power of the backup battery is insufficient. Replace the battery with a new one.

<b>Warning indication in the viewfinder</b>	<b>Buzzer</b>	<b>Tally lamps</b>	<b>Cause and measures</b>
Unknown Media(A) <sup>1)</sup> Please Change.			A partitioned memory card or one that contains recorded clips exceeding the number permitted with this camcorder is loaded. This card cannot be used with this camcorder. Remove it and load a compatible card.
Media Error Media(A) <sup>1)</sup> Needs to be Restored			An error occurred with the memory card. The card requires restoration. Remove the card, load it again, and restore it.
Media Error Cannot Record to Media(A) <sup>1)</sup>			Recording cannot be done, as the memory card is defective. As playback may be possible, it is recommended to replace it with another card after copying the clips, as required.
Media Error Cannot Use Media(A) <sup>1)</sup>			Neither recording nor playback can be done, as the memory card is defective. It cannot be operated with this camcorder. Replace it with another card.
Video Format Mismatch			The external signal input via the i.LINK connection cannot be recorded, as the Video Format setting is different from the signal format of the external input signal. Change "Video Format" of the OTHERS menu to match it to that of the external signal.
Copy Protected Input Cannot Record			The external signal input via the i.LINK connection cannot be recorded, as the stream is copy-protected. Check the input signal.
Media Error Playback Halted			An error occurred in reading data from the memory card, and playback cannot be continued. If this frequently occurs, change the memory card after copying the clips, as required.
Media(A) <sup>1)</sup> Error			Recording cannot be done, as an error occurred with the memory card. If this frequently occurs, change the memory card.
HDD A <sup>2)</sup> Battery Near End	Intermittent	Flashing	The battery power of the connected HDD will be exhausted soon. Change the battery at the earliest opportunity.
HDD A <sup>2)</sup> Battery End	Continuous	Rapidly flashing	The battery of the connected HDD is exhausted. Recording cannot be performed. Stop operation to change the battery.

1)B for the card in slot B

2)B for a HDD connected to slot B

# About i.LINK

This section explains the specifications and features of i.LINK.

## What is i.LINK?

i.LINK is a digital serial interface designed to integrate devices equipped with i.LINK connectors. i.LINK allows your device to:

- Perform two-way transmission and reception of data such as digital audio and digital video signals.
- Control other i.LINK devices.
- Easily connect multiple devices with a single i.LINK cable.

Your i.LINK device is capable of connecting to a wide range of digital AV devices for data transfer and other operations.

Other advantages include the following feature. When connected to multiple i.LINK devices, your i.LINK device can perform data transfer and other operations not only with the directly connected devices but also with any of the devices that are connected to those devices. Therefore, you do not need to be concerned with device connection order. However, depending on the features and specifications of the connected devices, you may need to use certain functions differently, and you may not be able to transfer data or perform certain operations.

i.LINK, a nickname for IEEE 1394 proposed by Sony, is a trademark supported by many companies worldwide.

IEEE 1394 is an international standard defined by IEEE, the Institute of Electrical and Electronics Engineers, Inc.

### Note

The camcorder can be connected to one device with the i.LINK cable (DV cable). When you connect with a device that has two or more i.LINK connectors, refer to the operating instructions supplied with the connected device.

## About data transfer speed of i.LINK

i.LINK defines a maximum data transfer speed of approximately 100, 200 and 400 Mbps<sup>1)</sup> that are described as S100, S200 and S400 respectively. For i.LINK devices, a maximum data transfer speed that the device supports is identified on “Specifications” page of the operating instructions supplied with the device or near its i.LINK connector.

<sup>1)</sup>When connecting with the device that support different data transfer speed, the actual data transfer speed may be different from those described on the i.LINK connectors.

### What is Mbps?

Mega bits per second. A measure of the rate at which data is transmitted per second. In case of 100 Mbps, 100 Mega bits of data can be transmitted per second.

## i.LINK operation with your camcorder

For details on operation when other equipment with i.LINK (HDV) connector is connected, *see page 132.*

For details on connection with i.LINK cable and necessary software, refer to the operating instructions supplied with the connected device.

## About the required i.LINK cable

Use the Sony 6-pin-to-4-pin or 4-pin-to-4-pin i.LINK cable (for HDV dubbing) to connect the i.LINK devices.

i.LINK and  are trademarks.

## MPEG-2 Video Patent Portfolio License

### PMW-EX3

ANY USE OF THIS PRODUCT OTHER THAN CONSUMER PERSONAL USE IN ANY MANNER THAT COMPLIES WITH THE MPEG-2 STANDARD FOR ENCODING VIDEO INFORMATION FOR PACKAGED MEDIA IS EXPRESSLY PROHIBITED WITHOUT A LICENSE UNDER APPLICABLE PATENTS IN THE MPEG-2 PATENT PORTFOLIO, WHICH LICENSE IS AVAILABLE FROM MPEG LA, L.L.C., 250 STEELE STREET, SUITE 300, DENVER, COLORADO 80206.

“PACKAGED MEDIA” means any storage media storing MPEG-2 video information such as DVD movie which are sold/distributed to general consumers. Disc replicators or sellers of the PACKAGED MEDIA need to obtain licenses for their own business from MPEG LA. Please contact MPEG LA for any further information. MPEG LA, L.L.C., 250 STEELE STREET, SUITE 300, DENVER, COLORADO 80206 <http://www.mpegla.com>

### XDCAM EX Clip Browsing Software

ANY USE OF THIS PRODUCT OTHER THAN CONSUMER PERSONAL USE IN ANY MANNER THAT COMPLIES WITH THE MPEG-2 STANDARD FOR ENCODING VIDEO INFORMATION FOR PACKAGED MEDIA IS EXPRESSLY PROHIBITED WITHOUT A LICENSE UNDER APPLICABLE PATENTS IN THE MPEG-2 PATENT PORTFOLIO, WHICH LICENSE IS AVAILABLE FROM MPEG LA, L.L.C., 250 STEELE STREET, SUITE 300, DENVER, COLORADO 80206.

## AVC Patent Portfolio License

### XDCAM EX Clip Browsing Software

THIS PRODUCT IS LICENSED UNDER THE AVC PATENT PORTFOLIO LICENSE FOR THE PERSONAL AND NON-COMMERCIAL USE OF A CONSUMER TO (i)ENCODE VIDEO IN COMPLIANCE WITH THE AVC STANDARD (“AVC VIDEO”) AND/OR (ii)DECODE AVC VIDEO THAT WAS ENCODED BY A CONSUMER ENGAGED IN A PERSONAL AND NON-COMMERCIAL ACTIVITY AND/OR WAS OBTAINED FROM A VIDEO PROVIDER LICENSED TO PROVIDE AVC VIDEO. NO LICENSE IS GRANTED OR SHALL BE IMPLIED FOR ANY OTHER USE. ADDITIONAL INFORMATION MAY BE OBTAINED FROM MPEG LA, L.L.C. SEE [HTTP://WWW.MPEGLA.COM](http://WWW.MPEGLA.COM)

# VC-1 Patent Portfolio License

## XDCAM EX Clip Browsing Software

THIS PRODUCT IS LICENSED UNDER THE VC-1 PATENT PORTFOLIO LICENSE FOR THE PERSONAL AND NON-COMMERCIAL USE OF A CONSUMER TO

(i) ENCODE VIDEO IN COMPLIANCE WITH THE VC-1 STANDARD ("VC-1 VIDEO") AND/OR

(ii) DECODE VC-1 VIDEO THAT WAS ENCODED BY A CONSUMER ENGAGED IN A PERSONAL AND NON-COMMERCIAL ACTIVITY AND/OR WAS OBTAINED FROM A VIDEO PROVIDER LICENSED TO PROVIDE VC-1 VIDEO.

NO LICENSE IS GRANTED OR SHALL BE IMPLIED FOR ANY OTHER USE.

ADDITIONAL INFORMATION MAY BE OBTAINED FROM MPEG LA, L.L.C. SEE [HTTP://WWW.MPEGLA.COM](http://www.mpegla.com)

# Specifications

## General

### Power requirements

DC 12 V

### Power consumption

Approx. 13.5 W (Typical) (Recording)

### Peak inrush current

(1) Power ON, current probe method:

15 A (240V)

(2) Hot switching inrush current,

measured in accordance with

European standard EN55103-1:

62 A (230V)

### Operating temperature

0°C to +40°C (32°F to 104°F)

### Storage temperature

-20°C to +60°C (-4°F to 140°F)

### Recording/playback formats

#### Video

HQ mode: MPEG-2 MP@HL,  
35 Mbps / VBR

1920 × 1080/59.94i, 50i, 29.97P, 25P,  
23.98P

1280 × 720/59.94P, 50P, 29.97P, 25P,  
23.98P

SP mode: MPEG-2 MP@H-14,  
25 Mbps /CBR

1440 × 1080 /59.94i, 50i

(23.98P is converted to 59.94i in 2-3  
pull-down processing.)

#### Audio

LPCM (16 bits, 48 kHz, 2 channels)

### Recording/playback time

With one SBP-8

SP mode: Approx. 35 min.

HQ mode: Approx. 25 min.

With one SBP-16

SP mode: Approx. 70 min.

HQ mode: Approx. 50 min.



**Continuous operation time (recording)**

With the BP-U60  
Approx. 210 min.  
With the BP-U30  
Approx. 100 min.

**Mass**

Camcorder: 1.9 kg (4 lb 2 oz)  
With the supplied lens, lens hood,  
eyepiece, BP-U30 battery pack and one  
SxS memory card: 3.6 kg (7 lb 15 oz)

**Dimensions**

*See page 155.*

**Supplied accessories**

*See page 10.*

**Camera Block****Pickup device**

$\frac{1}{2}$ -inch type, CMOS image sensor  
Effective picture elements:  
1920 (H)  $\times$  1080 (V)

**Format**

3-chip RGB

**Optical system**

F1.6 prism system

**Lens mount**

$\frac{1}{2}$ -inch EX Mount

**Built-in filters**

ND filters  
OFF: Clear  
1:  $\frac{1}{8}$ ND  
2:  $\frac{1}{64}$ ND

**Sensitivity**

F10 (Typical) (With 1080/60i, 89.9%  
reflection, 2000 lx)

**Minimum illumination**

0.14 lx (F1.9, +18 dB, 64-frame  
accumulation)

**Video S/N**

54 dB (Y) (Typical)

**Horizontal resolution**

1000TV lines or more (with HQ 1080,  
HD SDI output)

**Gain**

-3, 0, 3, 6, 9, 12, 18 dB, AGC

**Shutter speed**

$\frac{1}{32}$  to  $\frac{1}{2000}$  sec.

**Slow shutter**

2 to 8 frames  
EX Slow Shutter: 16, 32, 64 frames

**Audio Block****Built-in microphones**

Stereo electret condenser microphones  
Directivity: Omnidirectional

**Built-in speaker**

Monaural  
Output: 250 mW

**Viewfinder****Screen size of the built-in LCD**

8.8 cm diagonal (3.5-inch)

**Aspect ratio**

16:9

**Picture size**

640 (H)  $\times$  3 (RGB)  $\times$  480 (V) delta  
sequence

**Transmission**

Hybrid (semi-transmissive) type

**Inputs/Outputs****Input connectors****GENLOCK IN connector**

BNC type (1), 1.0 Vp-p, 75 $\Omega$ ,  
unbalanced

**TC IN connector**

BNC type (1), 0.5 to 1.8 Vp-p, 10k $\Omega$

**AUDIO IN CH-1/CH-2 connectors**

XLR 3-pin (2), female  
LINE: +4 dBu  
MIC: -11 dBu to -65 dBu (6dB steps)  
(Reference level: 0 dBu=0.775 Vrms)

**DC IN connector**

DC jack (1)

---

**Output connectors**

---

**SDI OUT connector**

BNC type (1), conforming to SMPTE292M/259M standards

**MONITOR OUT connector**

BNC type (1), 1.0 Vp-p, 75Ω, unbalanced

**COMPONENT OUT connector**Mini D connector (1)  
Y: 1.0 Vp-p, 75Ω  
Pb / Pr: 0.7 Vp-p, 75Ω**S VIDEO connector**

4-pin S connector (1)

**TC OUT connector**

BNC type (1), 1.0 Vp-p, 75Ω,

**AUDIO OUT CH-1/CH-2 connectors**

RCA phono jacks (2), -10 dBu (47kΩ load, reference level)

**Headphone connector**

Stereo mini jack (1), -20.5 dBu (reference level output, 16Ω load)

---

**Computer connectors**

---

**i.LINK (HDV) connector**

i.LINK, IEEE1394, 4-pin connector (1), S400

**USB connector**

mini-B/USB2.0 Hi-Speed (1)

**Supplied Lens (VCL-614B2X)****Focal length**5.8 mm to 81.2 mm  
(equivalent to 31.4 mm to 439 mm on 35 mm lens)**Zoom**

Servo/Manual selectable

**Zoom ratio**

14×

**Maximum relative aperture**

1:1.9

**Iris**Auto/Manual selectable  
F1.9 to F16 and C (close)**Focus**Auto/Manual selectable  
Ranges:  
800 mm to ∞ (Macro OFF)  
50 mm to ∞ (Macro ON, Wide)  
735 mm to ∞ (Macro ON, Tele)**Picture stabilizing function**

SteadyShot ON/OFF possible, shift-lens system

**Filter thread**

M77 mm, pitch 0.75 mm

**Macro**

ON/OFF switchable

**Optional Accessories**

Exclusive wide zoom lens

Fujinon XS8X4AS-XB8

Battery pack

BP-U30, BP-U60

Battery charger

BC-U1

SxS memory card

SxS PRO SBP-8 (8 GB), SBP-16 (16 GB)

SxS memory card USB reader/writer

SBAC-US10

Electret condenser microphone

ECM-673

Remote control unit

RM-B150, RM-B750

Professional hard disk unit

PHU-60K

Design and specifications are subject to change without notice.

## Dimensions

Unit: mm (inches)

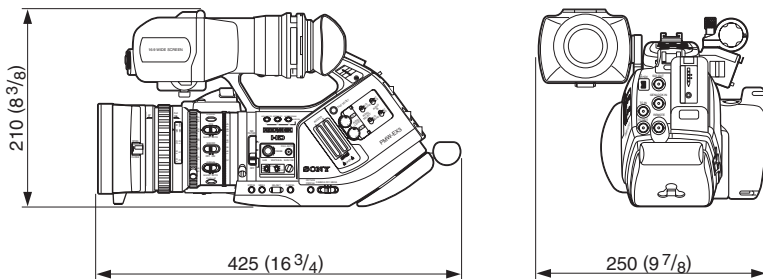

### Notes

- Always make a test recording, and verify that it was recorded successfully.  
SONY WILL NOT BE LIABLE FOR DAMAGES OF ANY KIND INCLUDING, BUT NOT LIMITED TO, COMPENSATION OR REIMBURSEMENT ON ACCOUNT OF FAILURE OF THIS UNIT OR ITS RECORDING MEDIA, EXTERNAL STORAGE SYSTEMS OR ANY OTHER MEDIA OR STORAGE SYSTEMS TO RECORD CONTENT OF ANY TYPE.
- Always verify that the unit is operating properly before use. SONY WILL NOT BE LIABLE FOR DAMAGES OF ANY KIND INCLUDING, BUT NOT LIMITED TO, COMPENSATION OR REIMBURSEMENT ON ACCOUNT OF THE LOSS OF PRESENT OR PROSPECTIVE PROFITS DUE TO FAILURE OF THIS UNIT, EITHER DURING THE WARRANTY PERIOD OR AFTER EXPIRATION OF THE WARRANTY, OR FOR ANY OTHER REASON WHATSOEVER.

# Index

## A

AC adaptor 27  
AC power source 27  
ACCESS lamps 41, 42  
add shot marks 103  
AF mode 63  
AGC mode 55, 56  
All Clips DEL 91  
All Reset 92, 124  
Angle mode 56  
Area Detection 90  
Aspect Marker 54  
Aspect Select 54  
Assign Button 72, 125  
assignable buttons 72  
ATW 51, 72  
ATW Speed 117  
Audio 67  
AUDIO IN connectors 67  
AUDIO IN switches 67  
Audio Input 118  
AUDIO LEVEL controls 67  
audio monitoring 69  
Audio Output 118  
audio recording levels 68  
AUDIO SELECT switches 67  
AUDIO Status 107  
Auto BLK Balance 53, 114  
Auto FB ADJ 122  
Auto Focus 61  
Auto Iris mode 58  
Auto Shutter 58  
Auto Shutter mode 56  
Auto Tracing White 51  
Auto White Balance 52

## B

Backlight 72  
backup battery 144  
BARS/CAM button 69  
Battery Alarm 126  
Battery INFO 126

BATTERY INFO display 27  
Battery Pack 26  
BATTERY RELEASE button 26  
BATTERY/MEDIA Status 109  
Bayonet Mount lens 35  
BC-U1 Battery Charger 26, 27  
Black 90  
black balance 53  
Black Gamma 90  
BP-U30 26  
BP-U60 26  
BRIGHT control 30  
BRT DISP 72  
BRT Disp 72  
built-in clock 29  
Built-in microphones 67  
Built-in speaker 96  
BUTTON/REMOTE Status 108  
Buzzer 148

## C

Camera Data 92, 124  
Camera mode 28  
CAMERA SET Menu 114  
CAMERA Status 106  
CANCEL button 99, 111  
Card slots 41  
Center Marker 54  
cheek pad 37  
Clip 49, 127  
CLIP INFO screen 100  
clip name 49  
Clip Operation menu 98, 99  
Clock mode 65  
Clock Set 124  
CMOS Image Sensors 140  
color bar 69  
Color Bar Type 115  
Color Correction 87  
COMPONENT OUT connector 129  
CONTRAST control 30  
copy a clip 101  
COPY CLIP 101  
Country 127  
Cueing up 96

## D

Date/Time 29  
DC cable clamp 38  
DC IN connector 27  
DC IN Power 27  
delete a clip 101  
DELETE CLIP 101  
delete shot marks 103  
Detail 88  
DF 66  
diopter compensation 30  
Direct Menu 126  
Direct menu 24, 51, 56, 59, 63, 77, 85  
DISP CLIP INFO 100  
Display On/Off 121  
DISPLAY/BATT INFO button 23, 27  
divide a clip 104  
DIVIDE CLIP 104  
Down Converter 119

## E

ECS 56  
EJECT buttons 41  
electronic shutter 56  
Entering a character string 113  
Error Indications 148  
EX Mount lens 34  
EX Slow Shutter 56, 58, 114  
EXPAND CLIP 102  
EXPAND CLIP screen 101  
EXPAND FOCUS button 62  
Expanded Focus 72  
ExpressCard slot of a computer 130  
Extended Clear Scan 56  
external microphone 68  
external monitor 128  
External Synchronization 134  
eyepiece 32  
Eyepiece focusing knob 30

## F

F FWD button 95  
F REV button 95  
Fade In 83  
Fade Out 83  
Fader 72, 82, 116  
File 122

Fixed gain mode 55  
Fixed Shutter mode 56  
flange focal length 33  
Flare 123  
Flicker Reduce 65, 115  
focus 61  
Focus ring 62  
Format Media 127  
Formatting 43  
Frame Rec 116  
Frame Recording 74  
Free Run mode 65  
Freeze Mix 72, 77  
FULL AUTO button 48  
Full Auto mode 48  
Full Manual Focus 61  
Full MF mode 61

## G

gain 55  
Gain Setup 56, 114  
GAIN switch 55  
Gamma 90  
Genlock 126, 134  
GENLOCK IN connector 134  
Grip 36  
Guide Frame 54

## H

Headphone connector 69, 96  
high-speed playback 95  
HISTOGRAM 72  
Histogram 72  
Hooks for the shoulder strap 17  
Hours Meter 125

## I

i.LINK 150  
i.LINK cable 150  
i.LINK I/O 126  
i.LINK(HDV) connector 132  
index frame 93, 104  
Interval Rec 116  
Interval Recording 73  
IR Remote 39, 72, 125  
IR Remote Commander 39  
iris 58

iris opening 58  
Iris ring 58  
IRIS switch 58

## J

Jog dial 19, 111  
Joystick 18, 111

## K

Knee 89

## L

Language 124  
Last Clip DEL 72, 91  
lens adaptor 35  
lens cap 47  
lens files 35, 143  
LENS INFO 72  
Lens Info 72  
LENS Menu 122  
lens mount lever 34  
lens mount stopper switch 34  
LENS REMOTE connector 61  
LINE/MIC/+48V switches 67  
Low Key SAT 90

## M

Macro mode 64  
MACRO switch 64  
Manual Focus 61  
Manual Iris mode 58  
Manual Zoom mode 59  
Marker 53, 72, 120  
Matrix 87  
MEDIA 93  
Media mode 28  
MENU button 111  
Menu controls 111  
MF Assist 63, 115  
MF mode 62  
microphone holder 68  
MIRROR IMAGE switch 31  
MONITOR VOL buttons 69, 96

## N

ND filter switch 50  
ND filters 50

NDF 66  
NEXT button 96

## O

OK mark 100  
OK MARK ADD 100  
OK MARK DEL 101  
One-Push Auto Focusing 63  
OTHERS Menu 124  
Output Formats 141

## P

Peaking 62, 120  
PEAKING control 62  
PHU-60K 45  
PICTURE FROFILE menu 84, 87  
PICTURE PROFILE button 84  
Picture Profiles 84  
PLAY/PAUSE button 94  
Playback 94  
Power switch 28  
Power Zoom 60  
Power Zoom (Servo) mode 59  
Power zoom lever 60  
PREV button 96  
Profile Name 87  
PUSH AF button 63

## R

Range index 62  
Rec 72  
REC HOLD lever 48  
Rec Review 48, 71, 72, 116  
REC REVIEW button 48, 71  
Rec Run mode 65  
REC START/STOP button 48  
Recall 92  
reference tone 69  
Regen mode 65  
RELEASE button 36  
REMOTE connector 136  
Remote Control Unit 136  
restoration 44  
RM-B150 136  
RM-B750 136

## S

S&Q Motion 116, 137  
Safety Area 53  
Safety Zone 53  
SBAC-US10 130  
SBP-16 40  
SBP-8 40  
SDI OUT connector 129  
SEL/SET button 111  
SEL/SET dial 111  
SET INDEX PIC 104  
Setup 119  
setup file 92  
Setup menus 110  
Shading 123  
Shockless White 117  
SHOT MARK 102  
SHOT MARK screen 102  
SHOT MARK1 102  
Shot Mark1 72  
SHOT MARK1 ADD 103  
SHOT MARK1 DEL 103  
SHOT MARK2 102  
Shot Mark2 72  
SHOT MARK2 ADD 103  
SHOT MARK2 DEL 103  
shot marks 70, 96  
Shot Transition 78, 115  
Shutter 57, 114  
SHUTTER switch 57  
Skin Tone Detail 89  
SLOT SELECT button 41, 94  
Slow & Quick Motion 76  
Slow Shutter 56  
SLS 56  
Speed mode 56  
Spotlight 72  
STATUS button 105  
status screens 105  
Steady Shot 64  
STOP button 97  
Store 92  
SxS Device Driver Software 14, 130  
SxS memory cards 40

## T

Tally 125

Tally lamps 148  
TC Format 66, 122  
TC IN connector 134  
TC/UB SET Menu 122  
TC/U-BIT/DURATION button 67, 95  
THUMBNAIL button 94, 96  
Thumbnail Screen 93  
Time Zone 29, 124  
Timecode 122  
TLCS 24, 48, 117  
TRANSITION operation buttons 79  
Trigger Mode 126  
Tripod receptacle 20  
Troubleshooting 146

## U

USB cable 130  
user bits 66  
Users Bit 122

## V

VF 120  
VF Mode 72  
VF SET Menu 120  
Video Format 49, 127  
Video Out Display 119  
VIDEO Status 108  
Viewfinder 30

## W

Warning Indications 148  
White 88  
WHITE BAL switch 51  
white balance 51  
White Switch 117  
WHT BAL button 52  
Wide Conversion 117  
write protection 41

## X

XDCAM EX Clip Browsing Software 14,  
131

## Y

YPbPr/SDI Out Display 119  
YPbPr/SDI Out Select 119

## **Z**

Zebra 54, 120

ZEBRA button 54

zebra patterns 54

Zebra Select 55

Zebra1 Level 55

zoom 59

ZOOM button 60

Zoom Position 59

Zoom ring 60

Zoom Speed 115

Zoom speed switch 60

ZOOM switch 60



