

SAMSUNG

GSM TELEPHONE

SGH-B100

SERVICE *Manual*

GSM TELEPHONE



CONTENTS

1. Safety Precautions
2. Specification
3. Product Function
4. Array course control
5. Exploded View and Parts list
6. MAIN Electrical Parts List
7. Disassembly and Assembly Instructions
8. Block Diagrams
9. PCB Diagrams
10. Chart of Troubleshooting
11. Reference data

**SAMSUNG
ELECTRONICS**



GSPN (Global Service Partner Network)

Country	Web Site
North America	service.samsungportal.com
Latin America	latin.samsungportal.com
CIS	cis.samsungportal.com
Europe	europe.samsungportal.com
China	china.samsungportal.com
Asia	asia.samsungportal.com
Mideast & Africa	mea.samsungportal.com

1. Safety Precautions

1-1. Repair Precaution

- Repair in Shield Box, during detailed tuning.
Take specially care of tuning or test,
because specipcty of cellular phone is sensitive for surrounding interference(RF noise).
- Be careful to use a kind of magnetic object or tool,
because performance of parts is damaged by the influence of manetic force.
- Surely use a standard screwdriver when you disassemble this product,
otherwise screw will be worn away.
- Use a thicken twisted wire when you measure level.
A thicken twisted wire has low resistance, therefore error of measurement is few.
- Repair after separate Test Pack and Set because for short danger (for example an
overcurrent and furious flames of parts etc) when you repair board in condition of
connecting Test Pack and tuning on.
- Take specially care of soldering, because Land of PCB is small and weak in heat.
- Surely tune on/off while using AC power plug, because a repair of battery charger is
dangerous when tuning ON/OFF PBA and Connector after disassembling charger.
- Don't use as you pleases after change other material than replacement registered on SEC
System. Otherwise engineer in charge isn't charged with problem that you don't keep this
rules.

1-2. ESD(Electrostatically Sensitive Devices) Precaution

Several semiconductor may be damaged easily by static electricity. Such parts are called by ESD(Electrostatically Sensitive Devices), for example IC,BGA chip etc. Read Precaution below. You can prevent from ESD damage by static electricity.

- Remove static electricity remained your body before you touch semiconductor or parts with semiconductor. There are ways that you touch an earthed place or wear static electricity prevention string on wrist.
- Use earthed soldering steel when you connect or disconnect ESD.
- Use soldering removing tool to break static electricity. , otherwise ESD will be damaged by static electricity.
- Don't unpack until you set up ESD on product. Because most of ESD are packed by box and aluminum plate to have conductive power,they are prevented from static electricity.
- You must maintain electric contact between ESD and place due to be set up until ESD is connected completely to the proper place or a circuit board.

2. Specification

2-1. GSM General Specification

	EGSM 900 Phase 2	DCS1800 Phase 1
Freq. Band[MHz] Uplink/Downlink	880~915 925~960	1710~1785 1805~1880
ARFCN range	0~124 & 975~1023	512~885
Tx/Rx spacing	45 MHz	95 MHz
Mod. Bit rate/ Bit Period	270.833 kbps 3.692 us	270.833 kbps 3.692 us
Time Slot Period/Frame Period	576.9 us 4.615 ms	576.9 us 4.615 ms
Modulation	0.3 GMSK	0.3 GMSK
MS Power	33 dBm~5 dBm	30 dBm~0 dBm
Power Class	5 pcl ~ 19 pcl	0 pcl ~ 15 pcl
Sensitivity	-102 dBm	-100 dBm
TDMA Mux	8	8
Cell Radius	35 Km	2 Km

2-2. GSM Tx Power Class

TX Power control level	GSM900	TX Power control level	DCS1800
5	33±2 dBm	0	30±3 dBm
6	31±2 dBm	1	28±3 dBm
7	29±2 dBm	2	26±3 dBm
8	27±2 dBm	3	24±3 dBm
9	25±2 dBm	4	22±3 dBm
10	23±2 dBm	5	20±3 dBm
11	21±2 dBm	6	18±3 dBm
12	19±2 dBm	7	16±3 dBm
13	17±2 dBm	8	14±3 dBm
14	15±2 dBm	9	12±4 dBm
15	13±2 dBm	10	10±4 dBm
16	11±3 dBm	11	8±4 dBm
17	9±3 dBm	12	6±4 dBm
18	7±3 dBm	13	4±4 dBm
19	5±3 dBm	14	2±5 dBm
		15	0±5 dBm

3. Product Function

Main Function

- Speed dial
- Phonebook memory status
- SDN(Service Dialling Numbers)
- Network services
- Read SMS or MMS messages
- Send SMS or MMS messages
- Voicemail
- Broadcast message
- MMS profile
- SOS messages
- Web browser
- Menu shortcuts

4. Array course control



Test Jig (GH80-00865A)



**Test Cable
(GH39-00895A/GH39-00892A)**



RF Test Cable (GH39-00397A)

Software Downloading

4-1. Downloading Binary Files

- Three binary files for downloading B100.
 - B100XXYY.s3 : Main source code binary.

4-2. Pre-requisite for Downloading

- Downloader Program([OptiFlash.exe](#))
- B100 Mobile Phone
- Data Cable
- Binary files

4-3. S/W Downloader Program

1. Load the binary download program by executing the “**OptiFlash.exe**”

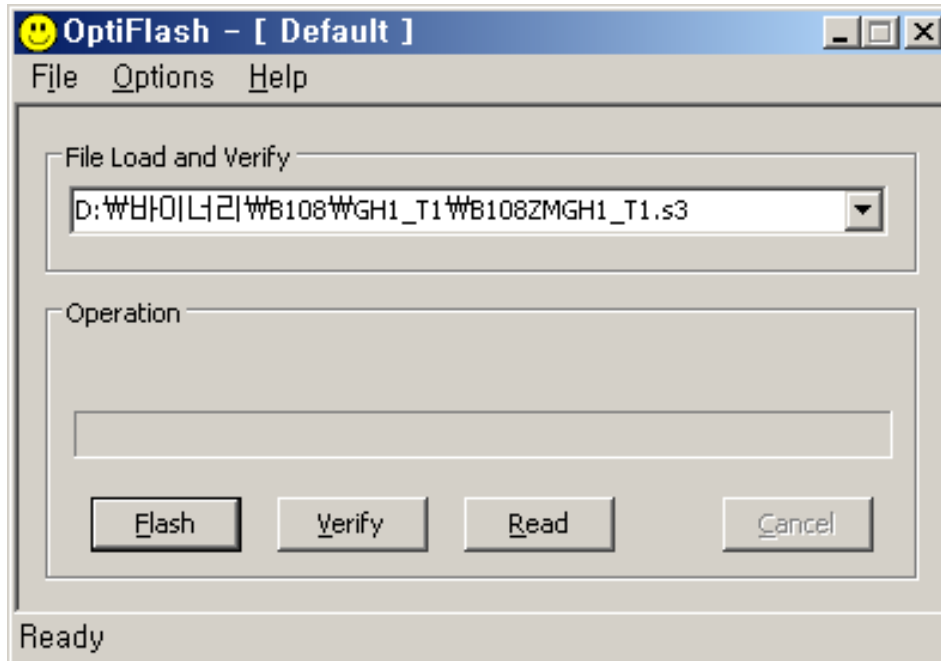

2. Select the “**Options**” -> “**Settings**” -> “**Generic**” -> “**Specify hardware platform**”. Choose hardware platform for the downloader file setting. Set the everything else as the default values which are shown below

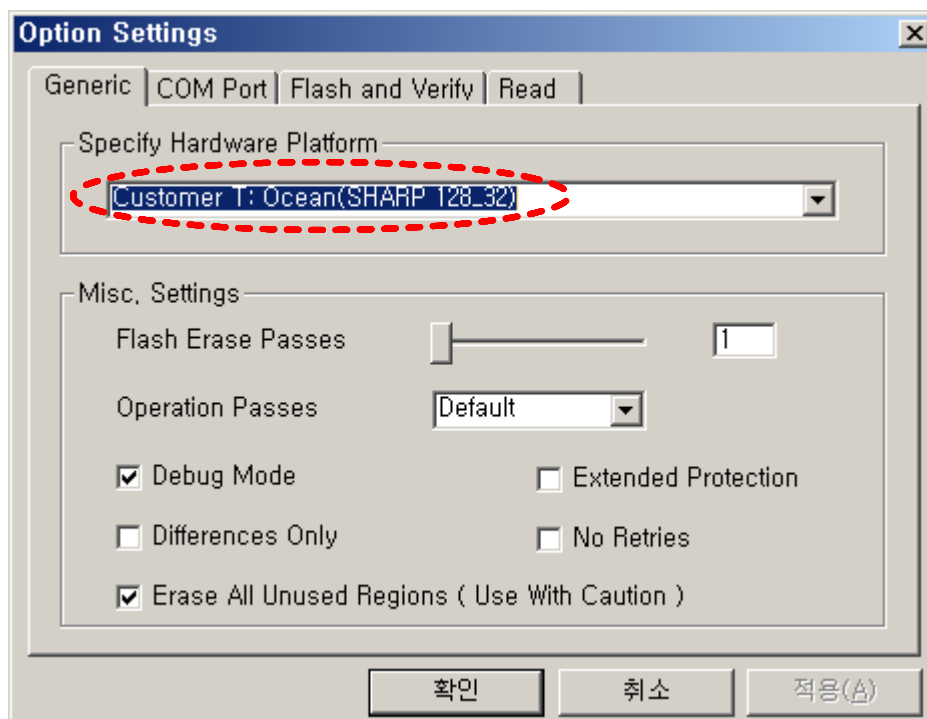

3. Select the **COM port** when the download cable is connected

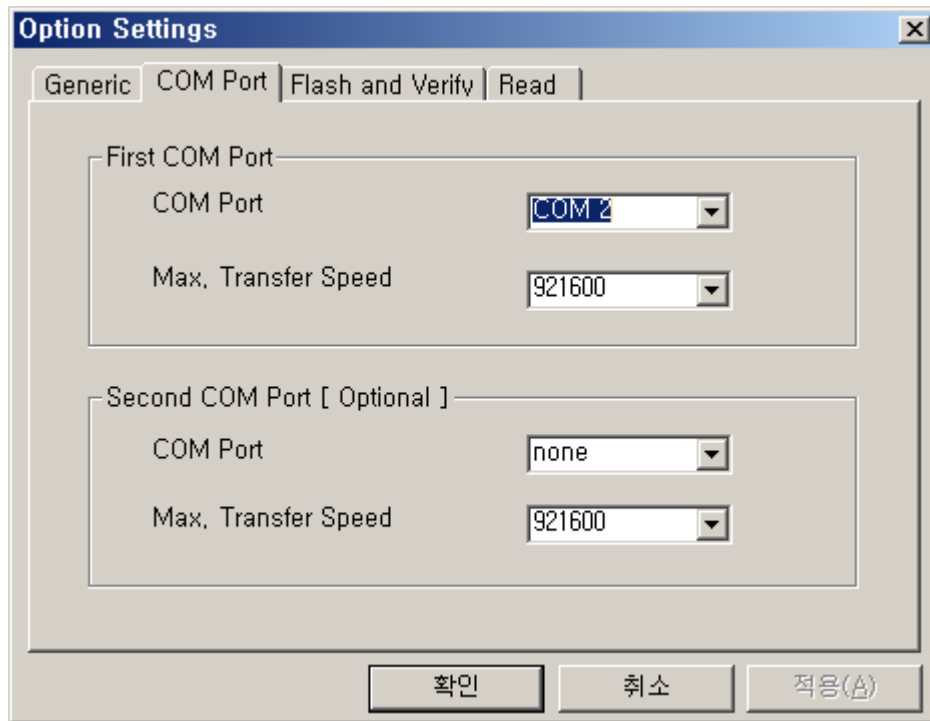

Up to twelve ports are supported. Additionally you can select the maximum transfer speed OptiFlash will use to communicate with the phone. However, OptiFlash will use a slower speed if either the PC's or the phone's serial hardware is incapable of handling the selected speed

4. Select the “Flash&Verify” -> “Browse”

Set the directory path and choose the latest s/w binary, for example “B100XXYY.s3”, for the downloader binary setting.

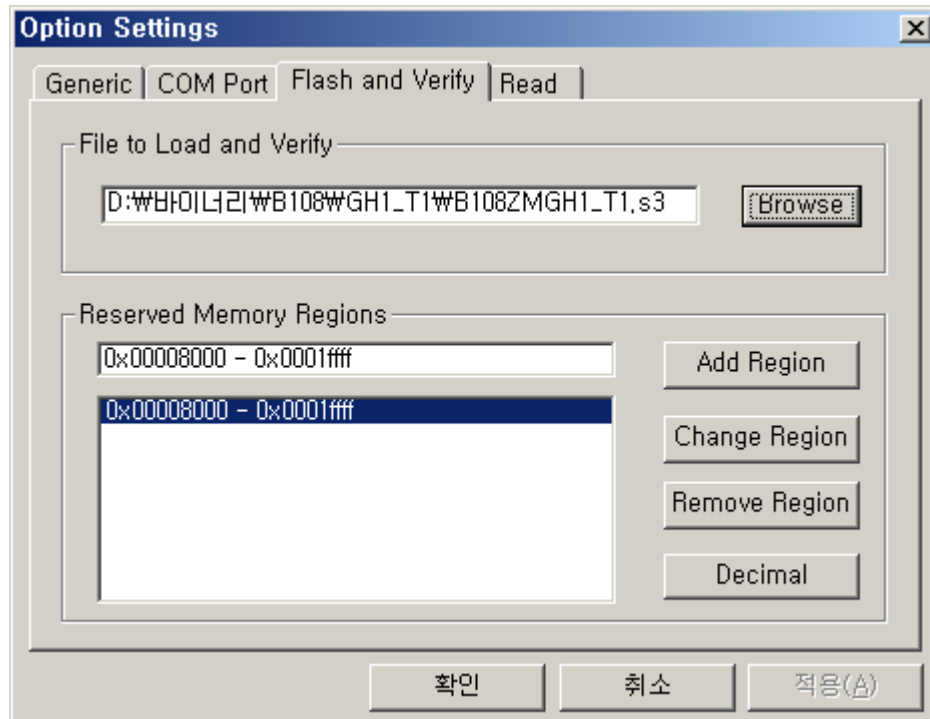

Make sure that not to change the reserved memory regions.

**In case of B108 the reserved memory regions are :
-0x00008000 - 0x0001ffff**

5. Click “**OK**” button then press “**Flash**”.

(Before pressing ‘Flash’ button, push the button “*” and ‘END’ at the same time. Then press ‘Flash’.)

Downloader will upload the binary file as below for the downloading.

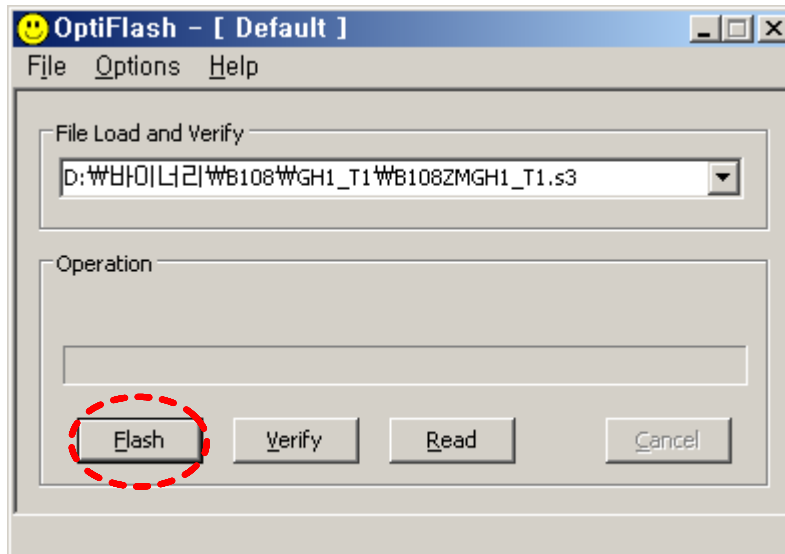

6. When downloading is finished successfully, there is a “All is well” message.

7. After finishing downloading, Certain memory resets should be done to guarantee the normal performance.

8. Confirm the downloaded version name and etc. :

***#1111#**

Full Reset :

***2767*3855#**

5. Exploded View and Parts List

5-1. Cellular phone Exploded View

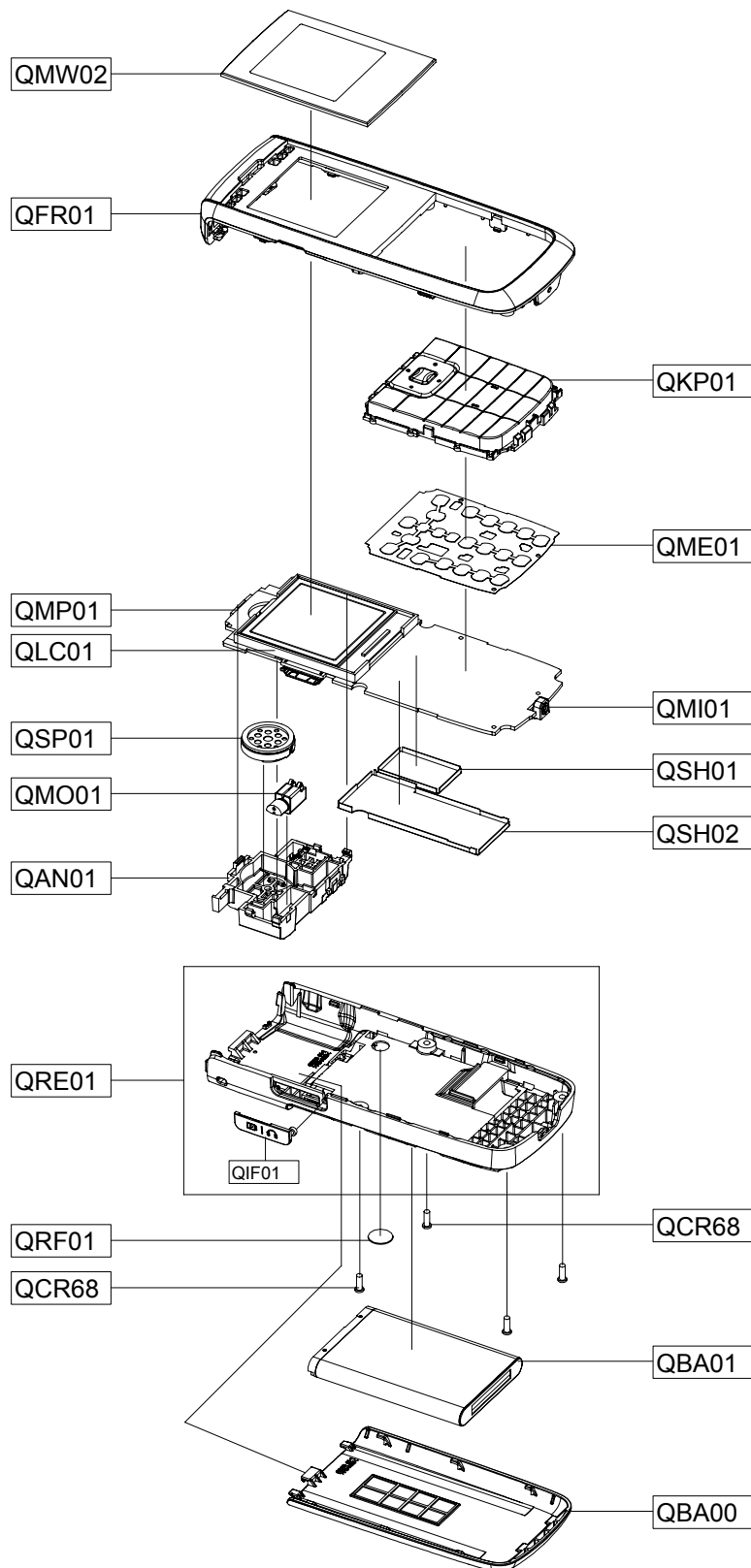

5-2. Cellular phone Parts list

Design LOC		Discription	SEC CODE
QAN01		INTENNA-SGH_B108	GH42-01421A
QBA00		PMO COVER-BATTERY	GH72-45634A
QBA01		INNER BATTERY PACK-1000MAH,BLA	GH43-02424A
QCR68		SCREW-TAPPING	6002-001399
QCR68		SCREW-TAPPING	6002-001399
QFR01		ASSY CASE-FRONT	GH98-06846A
QKP01		ASSY KEYPAD-(XEF/LKA)	GH98-07043A
QLC01		LCD-LCD MODULE	GH07-01056A
QME01		DOME SHEET-22 KEY	GH59-05216A
QMI01		MICROPHONE-ASSY-SGH_B108	GH30-00447A
QMO01		MOTOR DC-SCH-S369	GH31-00392A
QMP01		PBA MAIN-SGH_B100	GH92-04320A
QMW02		PMO WINDOW-LCD	GH72-45617A
QRF01		TAPE-RF SHEET	GH74-36593A
QSH01		IPR SHIELD-COVER A	GH70-02974A
QSH02		IPR SHIELD-COVER B	GH70-02975A
QSP01		SPEAKER	3001-002289
QRE01		ASSY CASE-REAR	GH98-06845A
	QIF01	PMO COVER-IF	GH72-45106A

Discription	SEC CODE
BAG PE	6902-000297
ADAPTOR-ATADS10EBE,BLK,EU	GH44-01702A
LABEL(P)-UNIT SEAL	GH68-00518B
LABEL(R)-WATER SOAK	GH68-09361A
MANUAL USERS-EU SPANISH	GH68-17128A
LABEL(R)-MAIN(EU)	GH68-17232A
BOX(P)-UNIT MAIN EU	GH69-06338A
SPONGE-INTENNA	GH74-35738A
SPONGE-SPK	GH74-35739A
VINYL-BOHO WINDOW A	GH74-36876A

6. MAIN Electrical Parts List

SEC CODE	Design LOC	Discription	STATUS
0401-001141	D600	DIODE-SWITCHING	SA
0403-001547	ZD300	DIODE-ZENER	SA
0406-001286	ZD301	DIODE-TVS	SA
0406-001286	ZD302	DIODE-TVS	SA
0504-000168	TR300	TR-DIGITAL	SA
0601-002361	LED600	LED	SA
0601-002361	LED601	LED	SA
0601-002361	LED602	LED	SA
0601-002361	LED603	LED	SA
0601-002361	LED604	LED	SA
0601-002361	LED605	LED	SA
0801-003206	U104	IC-CMOS LOGIC	SA
1001-001349	U603	IC-ANALOG MULTIPLEX	SA
1001-001371	U401	IC-ANALOG SWITCH	SA
1108-000111	UME200	IC-MCP	SA
1201-002490	PAM100	IC-POWER AMP	SA
1203-003897	UCP300	IC-POWER SUPERVISOR	SA
1203-004640	U602	IC-DC/DC CONVERTER	SA
1203-005005	U301	IC-BATTERY	SA
1204-002783	U400	IC-SOUND GENERATOR	SA
1205-003098	U103	IC-TRANSCEIVER	SA
1205-003412	UCP200	IC-COMM. CONTROLLER	SA
1404-001165	TH200	THERMISTOR-NTC	SA
1405-001082	VR300	VARISTOR	SA
1405-001082	VR301	VARISTOR	SA
1405-001082	VR302	VARISTOR	SA
1405-001082	VR402	VARISTOR	SA
1405-001082	VR403	VARISTOR	SA
1405-001082	VR600	VARISTOR	SA
1405-001082	VR601	VARISTOR	SA
1405-001082	VR602	VARISTOR	SA
1405-001082	VR603	VARISTOR	SA
1405-001082	VR604	VARISTOR	SA
1405-001082	VR605	VARISTOR	SA
1405-001082	VR606	VARISTOR	SA
1405-001082	VR607	VARISTOR	SA
1405-001082	VR608	VARISTOR	SA

SEC CODE	Design LOC	Discription	STATUS
1405-001082	VR609	VARISTOR	SA
1405-001082	VR610	VARISTOR	SA
1405-001121	VR400	VARISTOR	SA
1405-001121	VR401	VARISTOR	SA
2007-000138	R304	R-CHIP	SA
2007-000138	R412	R-CHIP	SA
2007-000140	R307	R-CHIP	SA
2007-000140	R308	R-CHIP	SA
2007-000140	R309	R-CHIP	SA
2007-000140	R310	R-CHIP	SA
2007-000140	R311	R-CHIP	SA
2007-000140	R312	R-CHIP	SA
2007-000140	R313	R-CHIP	SA
2007-000141	R410	R-CHIP	SA
2007-000141	R506	R-CHIP	SA
2007-000148	R102	R-CHIP	SA
2007-000148	R316	R-CHIP	SA
2007-000148	R317	R-CHIP	SA
2007-000148	R408	R-CHIP	SA
2007-000148	R409	R-CHIP	SA
2007-000148	R502	R-CHIP	SA
2007-000148	R504	R-CHIP	SA
2007-000157	R204	R-CHIP	SA
2007-000157	R303	R-CHIP	SA
2007-000157	R419	R-CHIP	SA
2007-000160	R401	R-CHIP	SA
2007-000161	R503	R-CHIP	SA
2007-000161	R505	R-CHIP	SA
2007-000162	R203	R-CHIP	SA
2007-000162	R205	R-CHIP	SA
2007-000162	R207	R-CHIP	SA
2007-000162	R301	R-CHIP	SA
2007-000170	R107	R-CHIP	SA
2007-000170	R110	R-CHIP	SA
2007-000170	R314	R-CHIP	SA
2007-000170	R315	R-CHIP	SA
2007-000171	R100	R-CHIP	SA

SEC CODE	Design LOC	Discription	STATUS
2007-000171	R105	R-CHIP	SA
2007-000171	R109	R-CHIP	SA
2007-000171	R111	R-CHIP	SA
2007-000171	R420	R-CHIP	SA
2007-000171	R421	R-CHIP	SA
2007-000172	R200	R-CHIP	SA
2007-000172	R202	R-CHIP	SA
2007-000172	R402	R-CHIP	SA
2007-000172	R403	R-CHIP	SA
2007-000172	R600	R-CHIP	SA
2007-000172	R601	R-CHIP	SA
2007-000172	R602	R-CHIP	SA
2007-000172	R603	R-CHIP	SA
2007-000172	R604	R-CHIP	SA
2007-000172	R605	R-CHIP	SA
2007-000242	R407	R-CHIP	SA
2007-000242	R501	R-CHIP	SA
2007-000775	R400	R-CHIP	SA
2007-000982	R209	R-CHIP	SA
2007-001119	R405	R-CHIP	SA
2007-001119	R500	R-CHIP	SA
2007-001284	R201	R-CHIP	SA
2007-001284	R300	R-CHIP	SA
2007-001288	R417	R-CHIP	SA
2007-001288	R418	R-CHIP	SA
2007-001292	R305	R-CHIP	SA
2007-001292	R306	R-CHIP	SA
2007-001301	R103	R-CHIP	SA
2007-001307	R108	R-CHIP	SA
2007-001308	R106	R-CHIP	SA
2007-001325	R404	R-CHIP	SA
2007-001339	R302	R-CHIP	SA
2007-002797	R104	R-CHIP	SA
2007-007148	R318	R-CHIP	SA
2007-007590	R406	R-CHIP	SA
2007-007590	R411	R-CHIP	SA
2007-007741	R101	R-CHIP	SA

SEC CODE	Design LOC	Discription	STATUS
2007-008403	R206	R-CHIP	SA
2007-008403	R208	R-CHIP	SA
2203-000233	C220	C-CER,CHIP	SA
2203-000233	C302	C-CER,CHIP	SA
2203-000254	C203	C-CER,CHIP	SA
2203-000254	C204	C-CER,CHIP	SA
2203-000254	C208	C-CER,CHIP	SA
2203-000254	C209	C-CER,CHIP	SA
2203-000254	C210	C-CER,CHIP	SA
2203-000254	C213	C-CER,CHIP	SA
2203-000254	C215	C-CER,CHIP	SA
2203-000254	C217	C-CER,CHIP	SA
2203-000254	C300	C-CER,CHIP	SA
2203-000330	C222	C-CER,CHIP	SA
2203-000359	C401	C-CER,CHIP	SA
2203-000386	C129	C-CER,CHIP	SA
2203-000386	C221	C-CER,CHIP	SA
2203-000438	C133	C-CER,CHIP	SA
2203-000438	C324	C-CER,CHIP	SA
2203-000438	C413	C-CER,CHIP	SA
2203-000466	C115	C-CER,CHIP	SA
2203-000489	C408	C-CER,CHIP	SA
2203-000489	C411	C-CER,CHIP	SA
2203-000627	C134	C-CER,CHIP	SNA
2203-000679	C132	C-CER,CHIP	SA
2203-000679	C206	C-CER,CHIP	SA
2203-000812	C119	C-CER,CHIP	SA
2203-000812	C120	C-CER,CHIP	SA
2203-000812	C121	C-CER,CHIP	SA
2203-000812	C131	C-CER,CHIP	SA
2203-000812	C305	C-CER,CHIP	SA
2203-000812	C306	C-CER,CHIP	SA
2203-000812	C600	C-CER,CHIP	SA
2203-000812	C601	C-CER,CHIP	SA
2203-000812	C602	C-CER,CHIP	SA
2203-000812	C603	C-CER,CHIP	SA
2203-000812	C604	C-CER,CHIP	SA

SEC CODE	Design LOC	Discription	STATUS
2203-000812	C605	C-CER,CHIP	SA
2203-000812	C606	C-CER,CHIP	SA
2203-000812	C607	C-CER,CHIP	SA
2203-000812	C608	C-CER,CHIP	SA
2203-000812	C610	C-CER,CHIP	SA
2203-000812	C611	C-CER,CHIP	SA
2203-000812	C612	C-CER,CHIP	SA
2203-000940	C303	C-CER,CHIP	SA
2203-000995	C307	C-CER,CHIP	SA
2203-000995	C501	C-CER,CHIP	SA
2203-002709	C614	C-CER,CHIP	SA
2203-005065	C312	C-CER,CHIP	SA
2203-005065	C313	C-CER,CHIP	SA
2203-005065	C315	C-CER,CHIP	SA
2203-005065	C316	C-CER,CHIP	SA
2203-005065	C317	C-CER,CHIP	SA
2203-005234	C105	C-CER,CHIP	SA
2203-005234	L100	C-CER,CHIP	SA
2203-005344	C207	C-CER,CHIP	SA
2203-005344	C219	C-CER,CHIP	SA
2203-005344	C319	C-CER,CHIP	SA
2203-005382	C103	C-CER,CHIP	SA
2203-005482	C128	C-CER,CHIP	SA
2203-005482	C130	C-CER,CHIP	SA
2203-005482	C402	C-CER,CHIP	SA
2203-005683	C108	C-CER,CHIP	SA
2203-005683	C110	C-CER,CHIP	SA
2203-005719	C101	C-CER,CHIP	SA
2203-005719	C106	C-CER,CHIP	SA
2203-005719	C107	C-CER,CHIP	SA
2203-005719	C117	C-CER,CHIP	SA
2203-005719	C124	C-CER,CHIP	SA
2203-005736	C111	C-CER,CHIP	SA
2203-005736	C118	C-CER,CHIP	SA
2203-005736	C125	C-CER,CHIP	SA
2203-005777	C114	C-CER,CHIP	SA
2203-005819	C321	C-CER,CHIP	SA

SEC CODE	Design LOC	Discription	STATUS
2203-005819	C619	C-CER,CHIP	SA
2203-005819	C621	C-CER,CHIP	SA
2203-005819	C622	C-CER,CHIP	SA
2203-006048	C200	C-CER,CHIP	SA
2203-006048	C201	C-CER,CHIP	SA
2203-006048	C202	C-CER,CHIP	SA
2203-006048	C205	C-CER,CHIP	SA
2203-006048	C211	C-CER,CHIP	SA
2203-006048	C212	C-CER,CHIP	SA
2203-006048	C214	C-CER,CHIP	SA
2203-006048	C216	C-CER,CHIP	SA
2203-006048	C218	C-CER,CHIP	SA
2203-006048	C301	C-CER,CHIP	SA
2203-006048	C311	C-CER,CHIP	SA
2203-006048	C314	C-CER,CHIP	SA
2203-006048	C318	C-CER,CHIP	SA
2203-006048	C320	C-CER,CHIP	SA
2203-006048	C323	C-CER,CHIP	SA
2203-006048	C405	C-CER,CHIP	SA
2203-006048	C407	C-CER,CHIP	SA
2203-006048	C409	C-CER,CHIP	SA
2203-006048	C410	C-CER,CHIP	SA
2203-006048	C414	C-CER,CHIP	SA
2203-006048	C417	C-CER,CHIP	SA
2203-006048	C418	C-CER,CHIP	SA
2203-006048	C500	C-CER,CHIP	SA
2203-006048	C502	C-CER,CHIP	SA
2203-006137	C326	C-CER,CHIP	SA
2203-006137	C400	C-CER,CHIP	SA
2203-006194	C104	C-CER,CHIP	SA
2203-006194	C112	C-CER,CHIP	SA
2203-006257	C304	C-CER,CHIP	SA
2203-006257	C309	C-CER,CHIP	SA
2203-006257	C403	C-CER,CHIP	SA
2203-006260	C127	C-CER,CHIP	SA
2203-006324	C308	C-CER,CHIP	SA
2203-006348	C322	C-CER,CHIP	SA



SEC CODE	Design LOC	Discription	STATUS
2203-006361	C613	C-CER,CHIP	SA
2203-006423	C100	C-CER,CHIP	SA
2203-006423	C122	C-CER,CHIP	SA
2203-006423	C123	C-CER,CHIP	SA
2203-006462	C126	C-CER,CHIP	SA
2203-006556	C116	C-CER,CHIP	SA
2203-006562	C412	C-CER,CHIP	SA
2203-006562	C415	C-CER,CHIP	SA
2203-006562	C421	C-CER,CHIP	SA
2203-006626	C113	C-CER,CHIP	SA
2203-006824	C325	C-CER,CHIP	SA
2203-006824	C404	C-CER,CHIP	SA
2203-006839	C109	C-CER,CHIP	SA
2203-006841	C327	C-CER,CHIP	SA
2203-006872	C406	C-CER,CHIP	SA
2203-006872	C416	C-CER,CHIP	SA
2404-001336	TA400	C-TA,CHIP	SA
2404-001336	TA500	C-TA,CHIP	SA
2404-001406	TA300	C-TA,CHIP	SA
2404-001415	TA100	C-TA,CHIP	SA
2404-001415	TA600	C-TA,CHIP	SA
2703-001236	L106	INDUCTOR-SMD	SA
2703-001722	L103	INDUCTOR-SMD	SA
2703-001723	L603	INDUCTOR-SMD	SA
2703-001723	L604	INDUCTOR-SMD	SA
2703-001723	L605	INDUCTOR-SMD	SA
2703-001723	L606	INDUCTOR-SMD	SA
2703-001737	L101	INDUCTOR-SMD	SA
2703-001737	L107	INDUCTOR-SMD	SA
2703-001747	L104	INDUCTOR-SMD	SA
2703-001990	L108	INDUCTOR-SMD	SA
2703-002200	L400	INDUCTOR-SMD	SA
2703-002200	L401	INDUCTOR-SMD	SA
2703-002484	L102	INDUCTOR-SMD	SA
2801-003856	OSC200	CRYSTAL-SMD	SA
2801-004689	OSC100	CRYSTAL-SMD	SA
2904-001792	F100	FILTER-SAW	SA

SEC CODE	Design LOC	Discription	STATUS
3301-001534	L105	BEAD-SMD	SA
3301-001729	L600	BEAD-SMD	SA
3705-001358	RFS100	CONNECTOR-COAXIAL	SA
3709-001355	SIM300	CONNECTOR-CARD EDGE	SA
3710-002499	IFC300	SOCKET-INTERFACE	SA
3711-006084	BTC300	HEADER-BATTERY	SA
GH70-02367A	SC100	ICT-ON-BOARD CLIP	SA
GH70-02367A	SC104	ICT-ON-BOARD CLIP	SA
GH70-02640A	SC101	ICT SHIELD-CAN CLIP	SA
GH70-02640A	SC102	ICT SHIELD-CAN CLIP	SA
GH70-02640A	SC103	ICT SHIELD-CAN CLIP	SA
GH70-02640A	SC105	ICT SHIELD-CAN CLIP	SA
GH71-07891A	U604	NPR SHIELD-FRAME A	SA

Please consult the GSPN website (Samsung Portal) for the most recent version of the product's part list.

7. Disassembly and Assembly Instructions

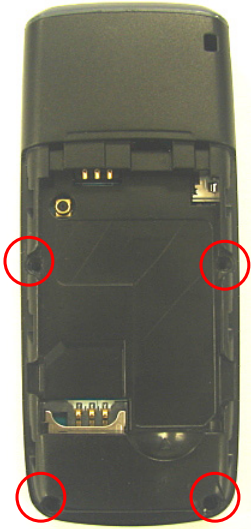
7-1. Disassembly

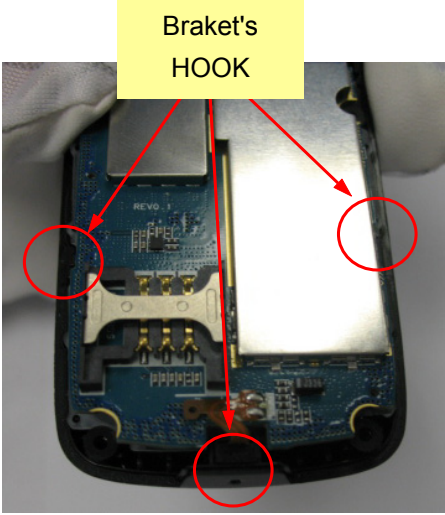
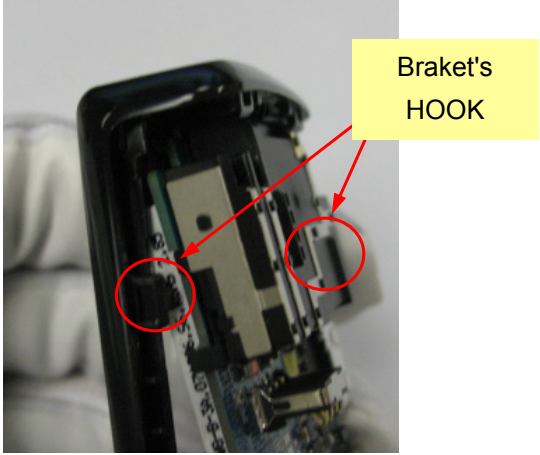
<p>1</p> 	<p>2</p> 
<p>1) Release SCREW 4 POINT at Rear ※ caution 1) Be careful not to make scratch and molding damage!</p>	<p>1) Disjoint HOOK from down to up. ※ caution 1) Be careful not to make scratch and molding damage!</p>
<p>3</p> 	<p>4</p> 
<p>1) Disjoint the Low Braket's HOOK (3 point) ※ caution 1) Be careful not to make scratch and molding damage!</p>	<p>1) Disjoint the HIGH Braket's HOOK (2 point) ※ caution 1) Be careful not to make scratch and molding damage!</p>

5

1 Separate Bracket from the main PBA.

※ **caution**

- 1) Be careful not to make scratch and molding damage!
- 2) Beware that you do not damage MIC F-PCB.

7-2. Assembly

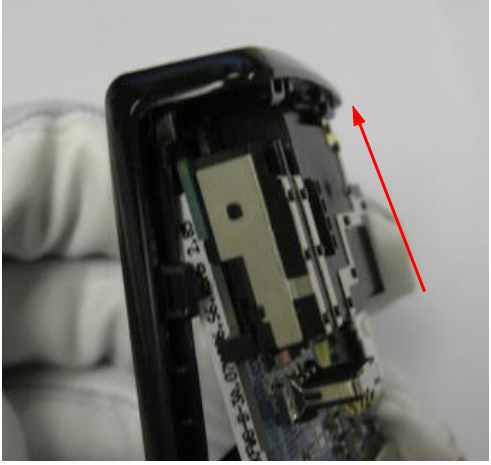
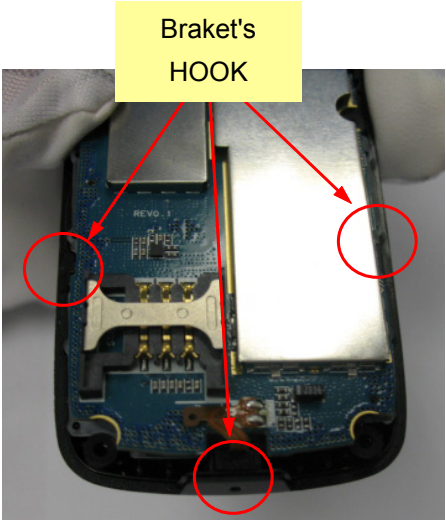
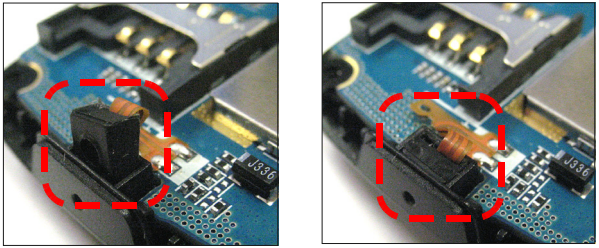
<p>1</p> 	<p>2</p> 
<p>1) Set a PBA on the FRONT. ※ caution 1) Be careful not to make scratch and molding damage!</p>	<p>1) Put the PBA on the FRONT. ※ caution 1) Be careful not to make scratch and molding damage!</p>
<p>3</p> 	<p>4</p> 
<p>1) Assemble the FRONT's hook 3point. ※ caution 1) Be careful not to make scratch and molding damage! 2) Beware that you do not damage MIC F-PCB.</p>	<p>1) Put the MIC on the FRONT. ※ caution 1) Be careful not to make scratch and molding damage! 2) Beware that you do not damage MIC F-PCB.</p>

5



- 1) Assemble REAR and FRONT ass'y.
※ caution
- 1) Be careful not to make scratch and molding damage!

6



- 1) Assemble the FRONT's hook
※ caution
- 1) Be careful not to make scratch and molding damage!

7

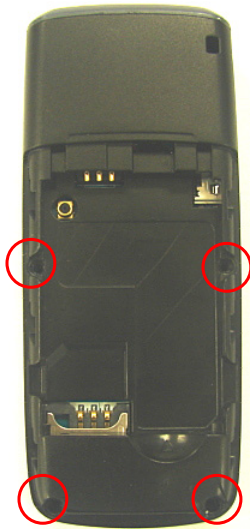

- 1) Drivers 4 screws on the REAR.
※ caution
- 1) Be careful not to make scratch and molding damage!

8. Block Diagrams

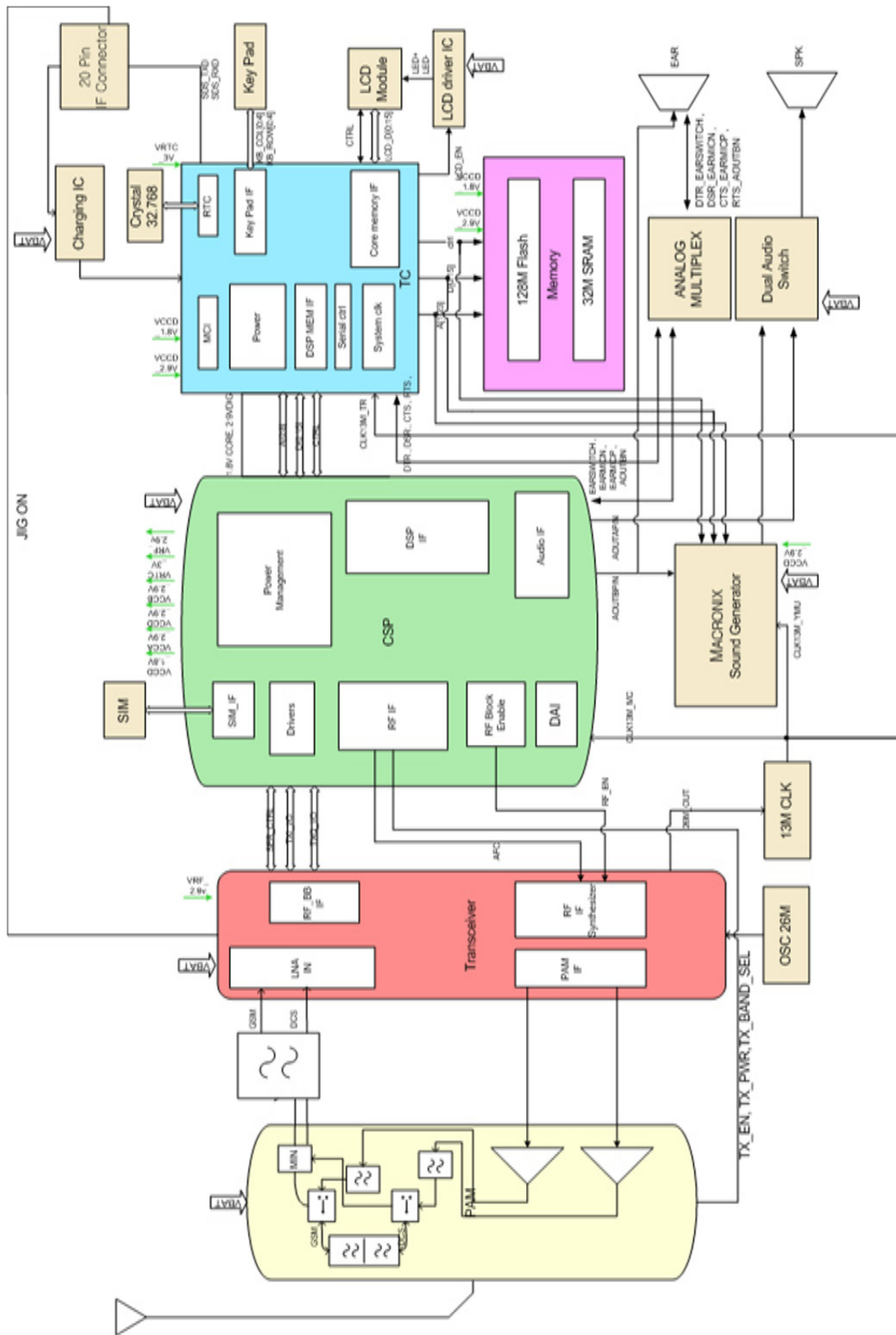

9. PCB Diagrams

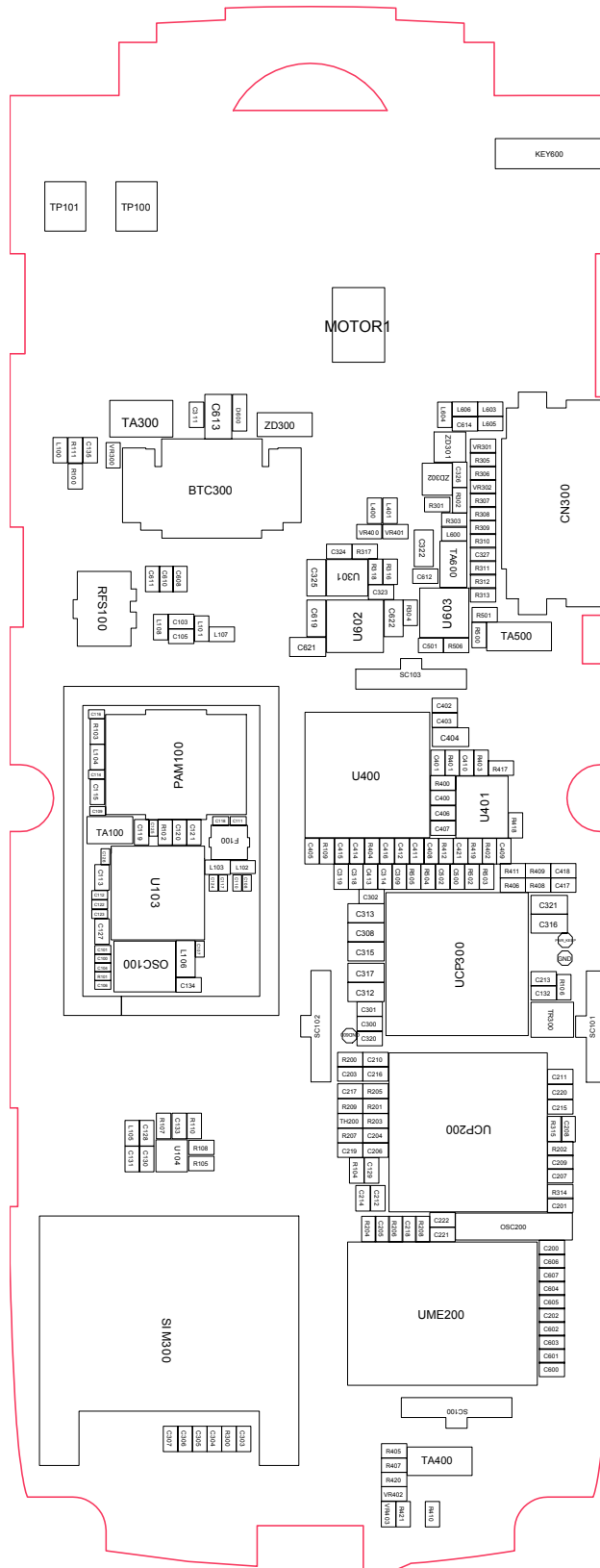

10. Flow Chart of Troubleshooting

10-1. Baseband

10-1-1. Power ON

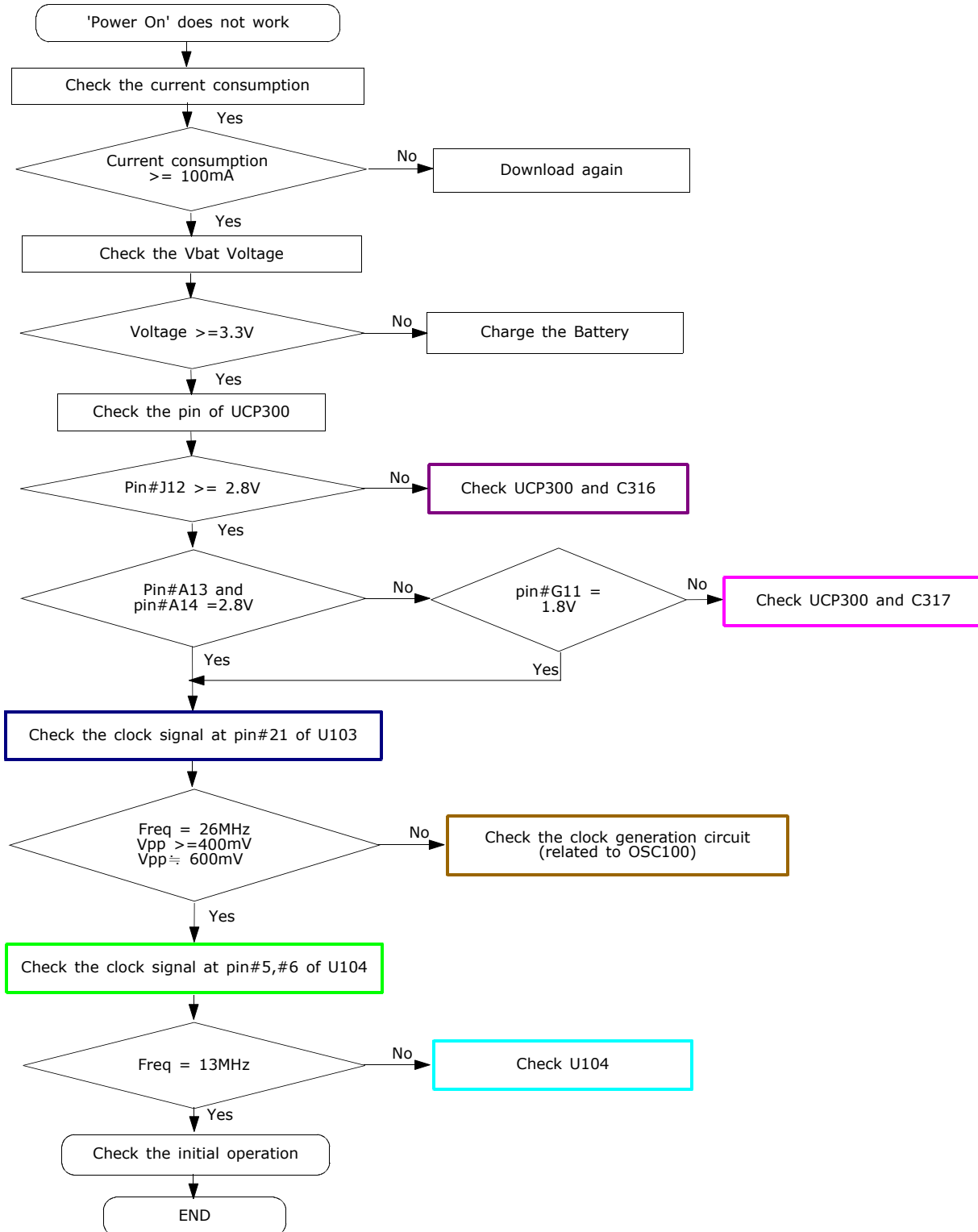

10-1-2. System Initial

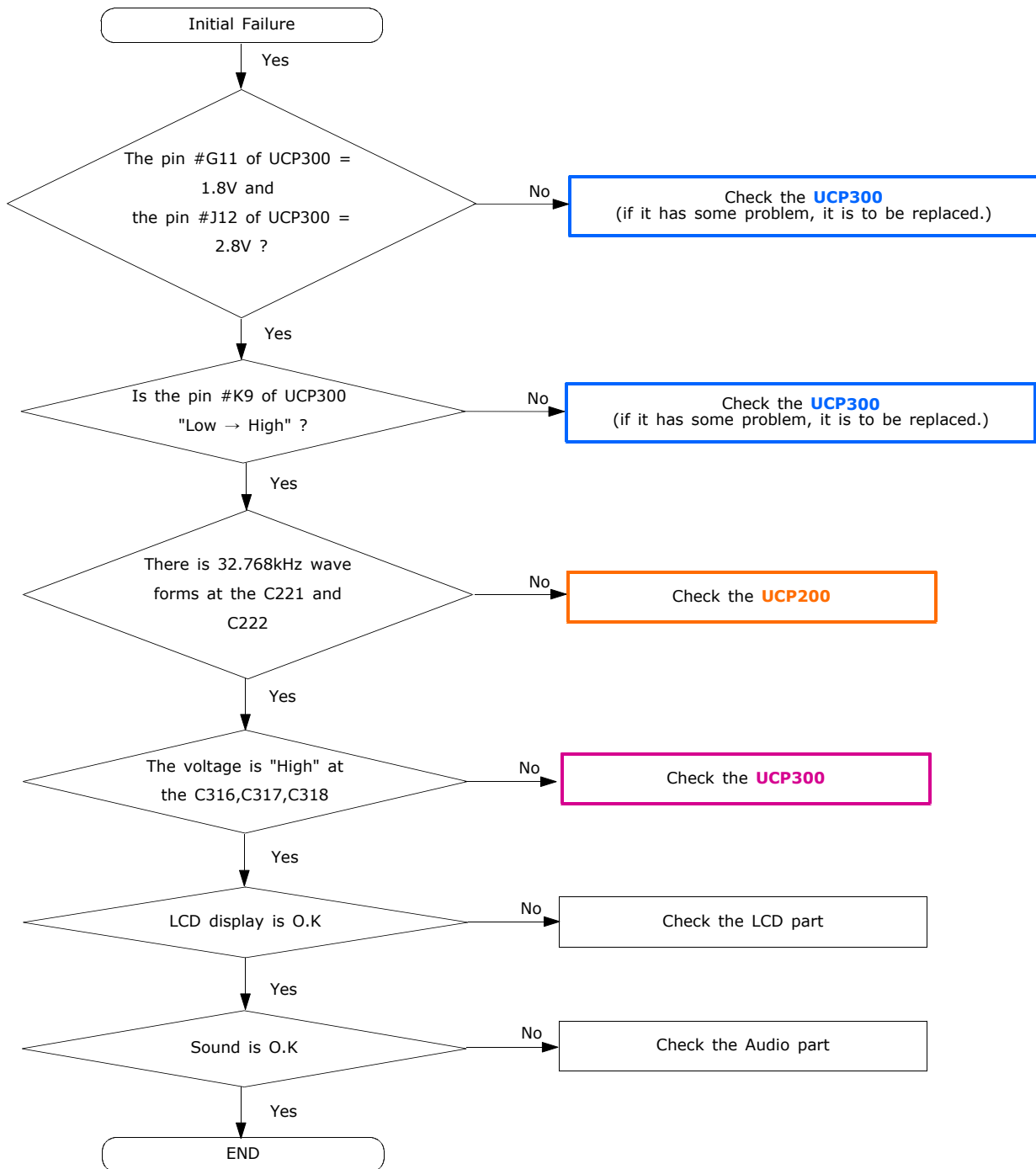

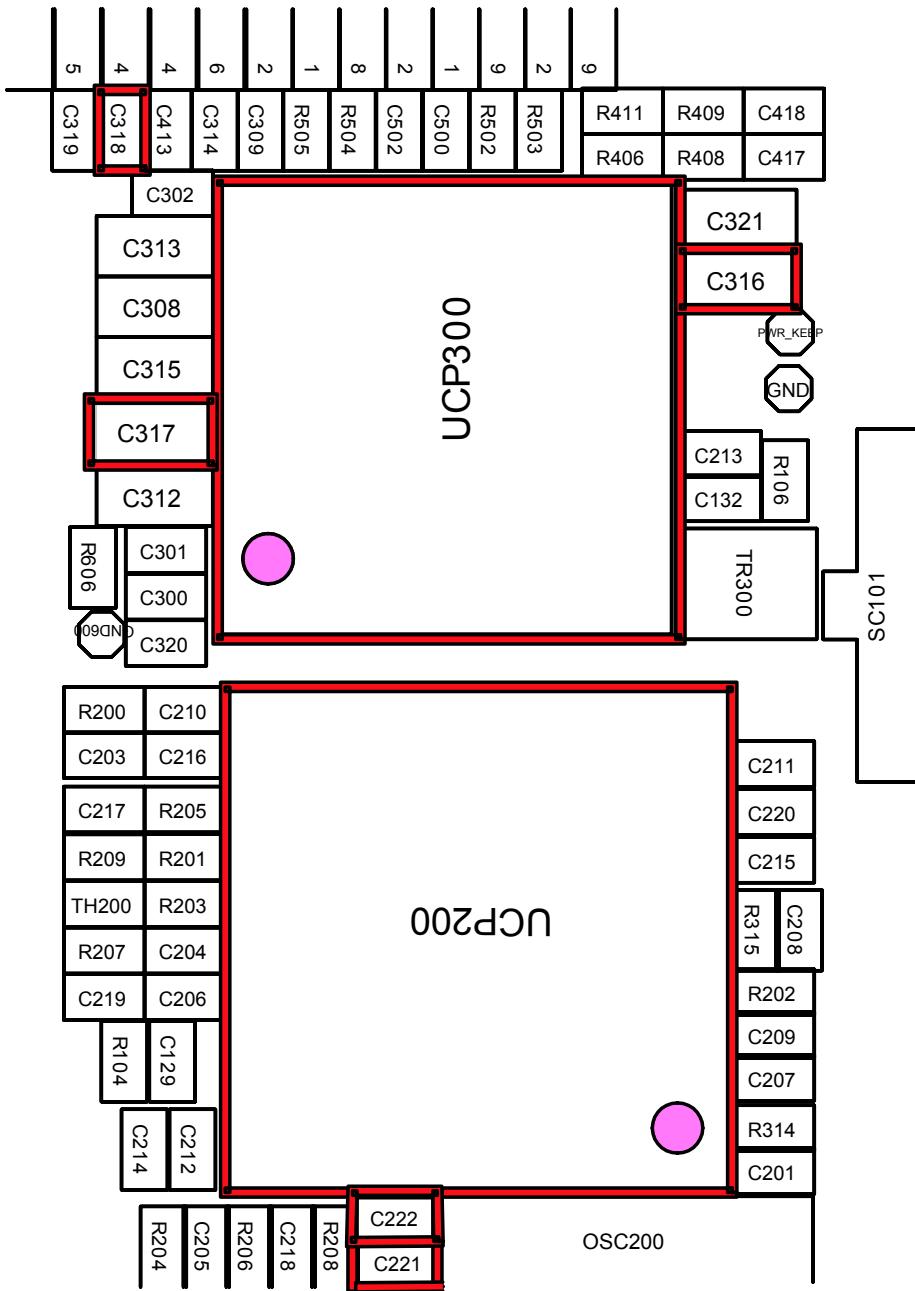

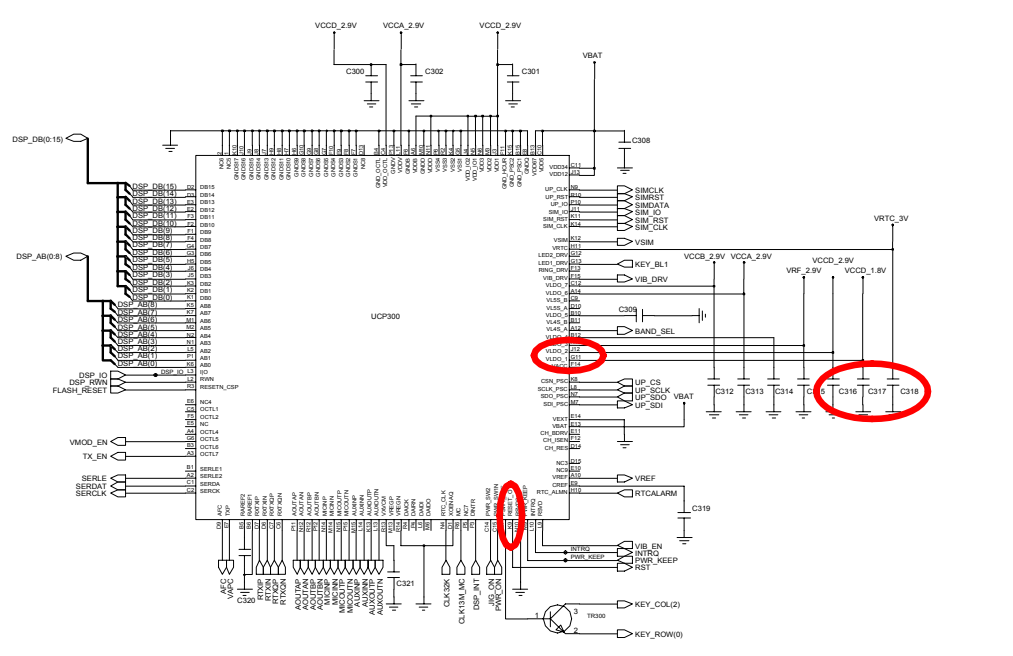
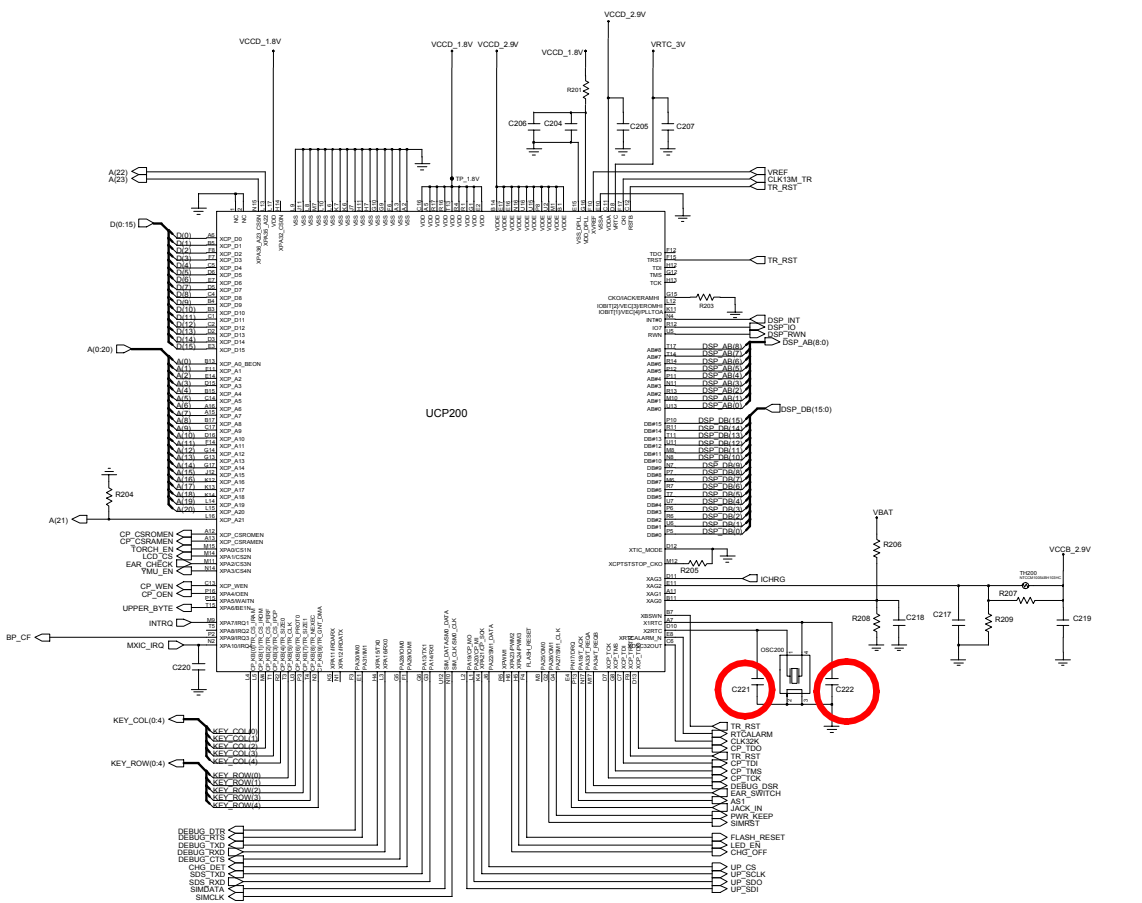

10-1-3. Sim Part

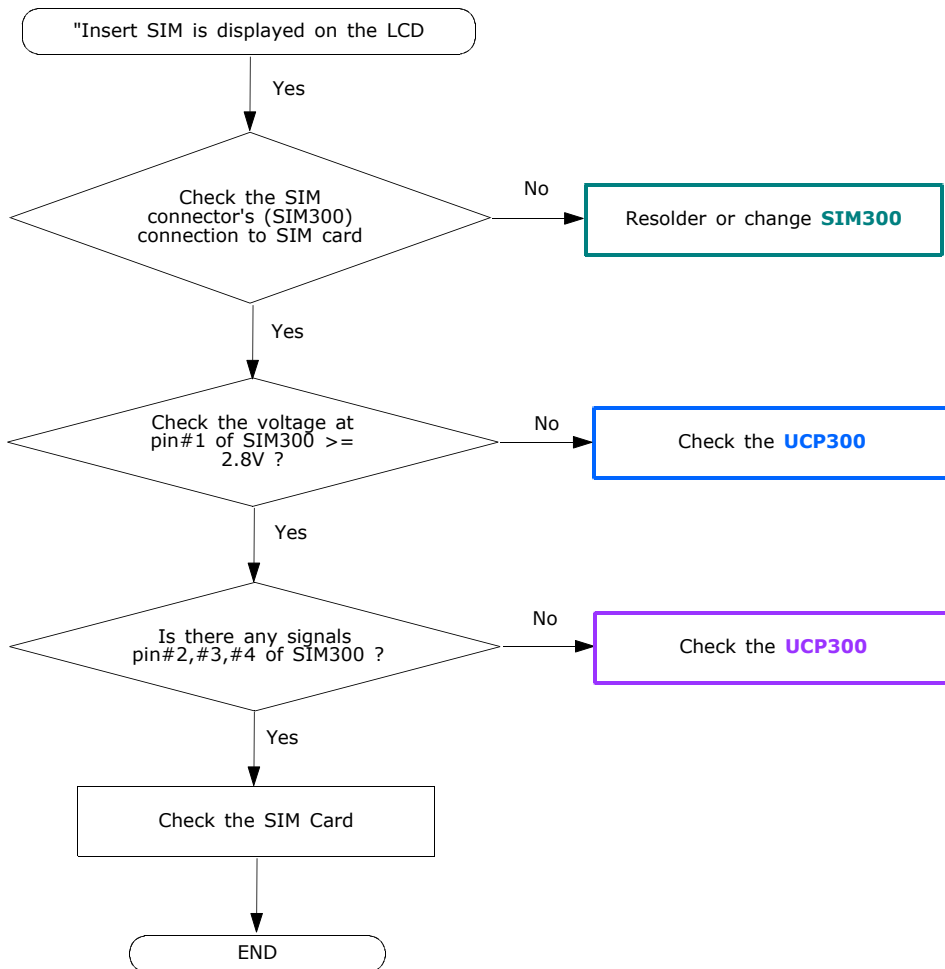



Flow Chart of Troubleshooting

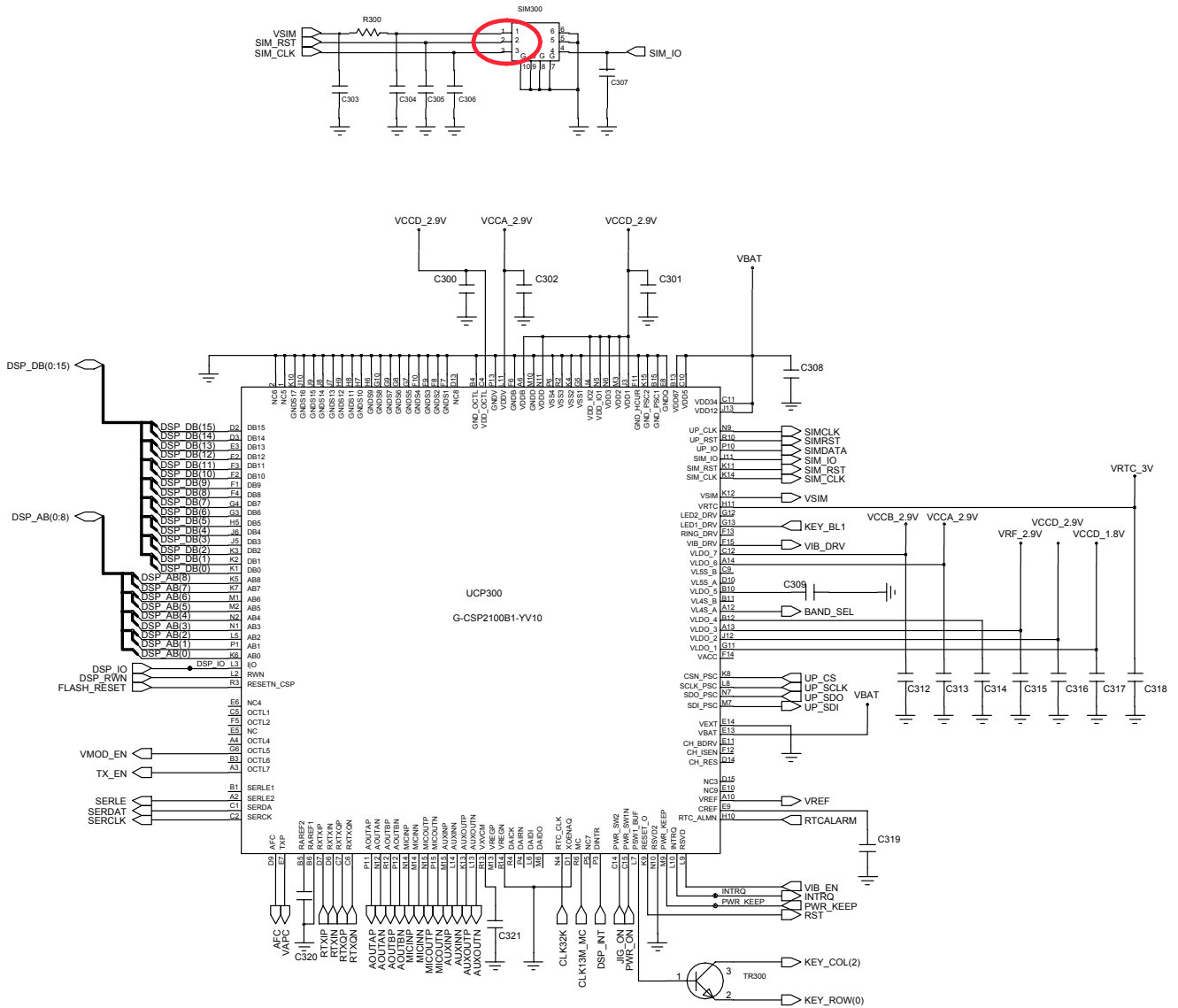

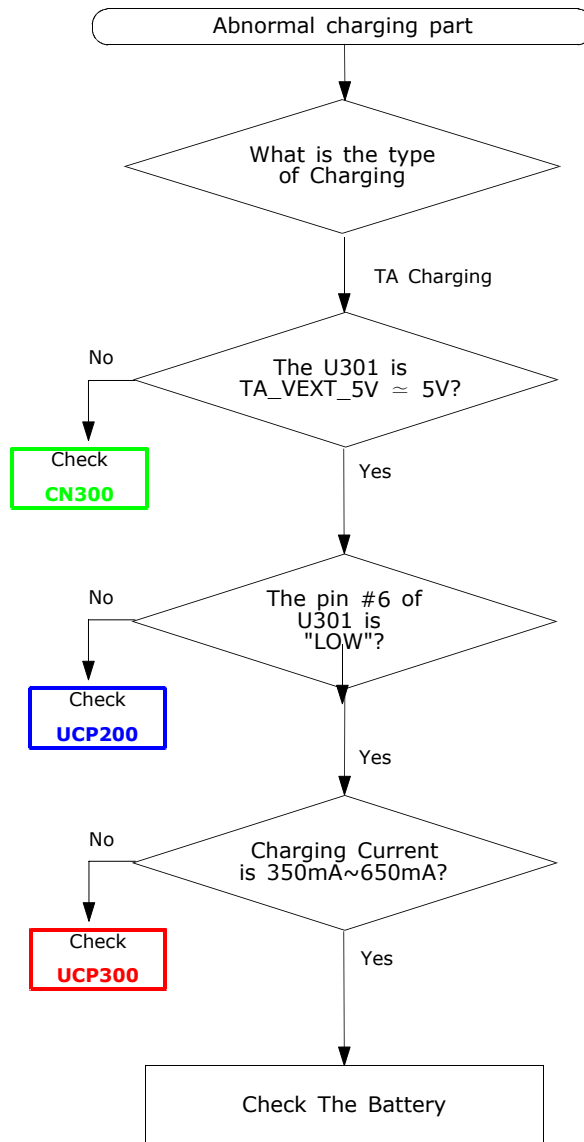
10-1-4. Charging Part

Flow Chart of Troubleshooting

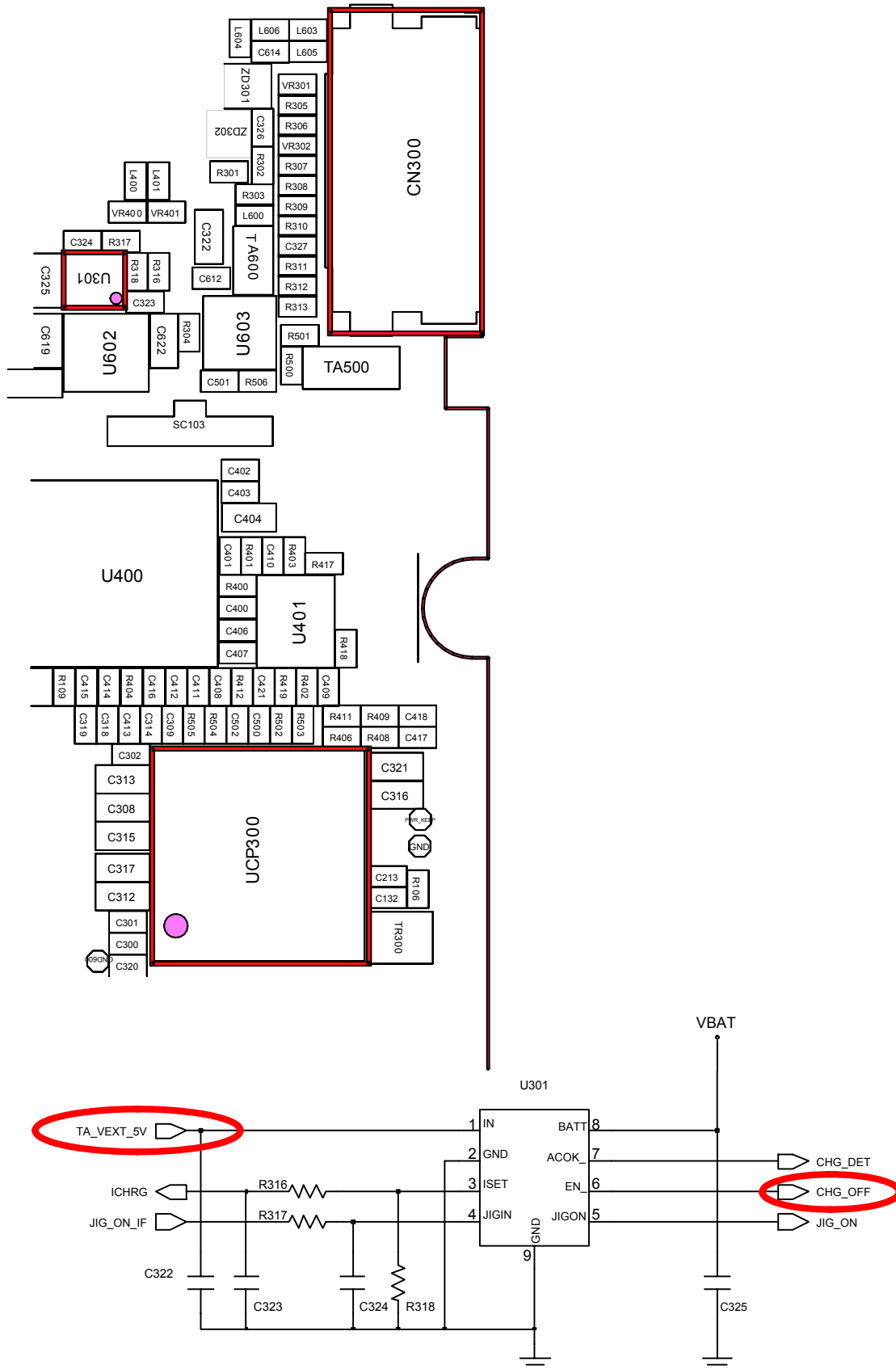

10-1-5. Microphone Part

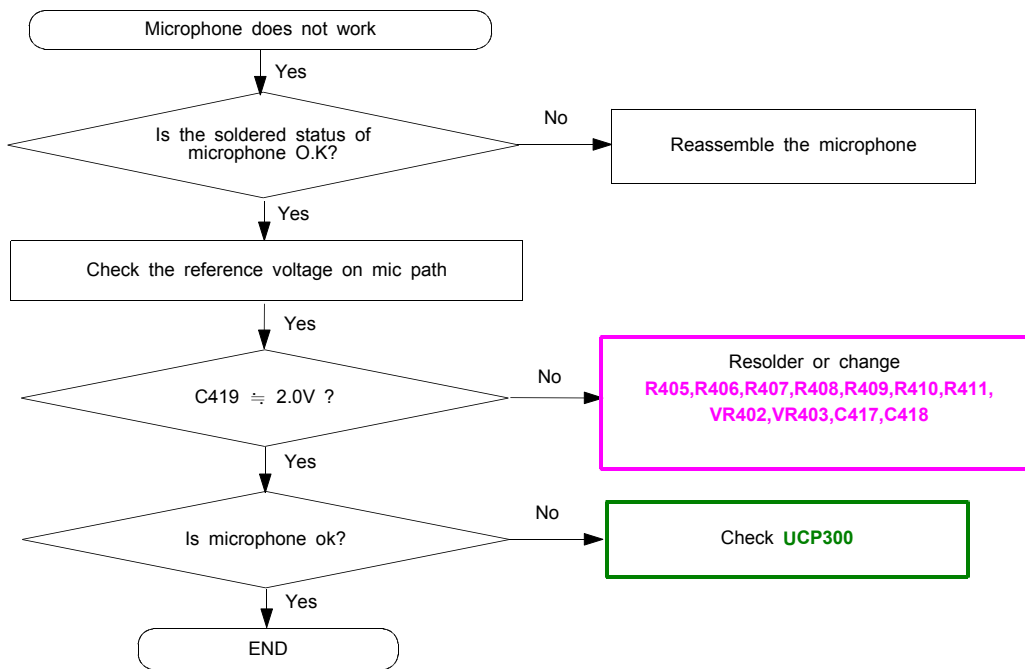

10-1-6. Receiver Part

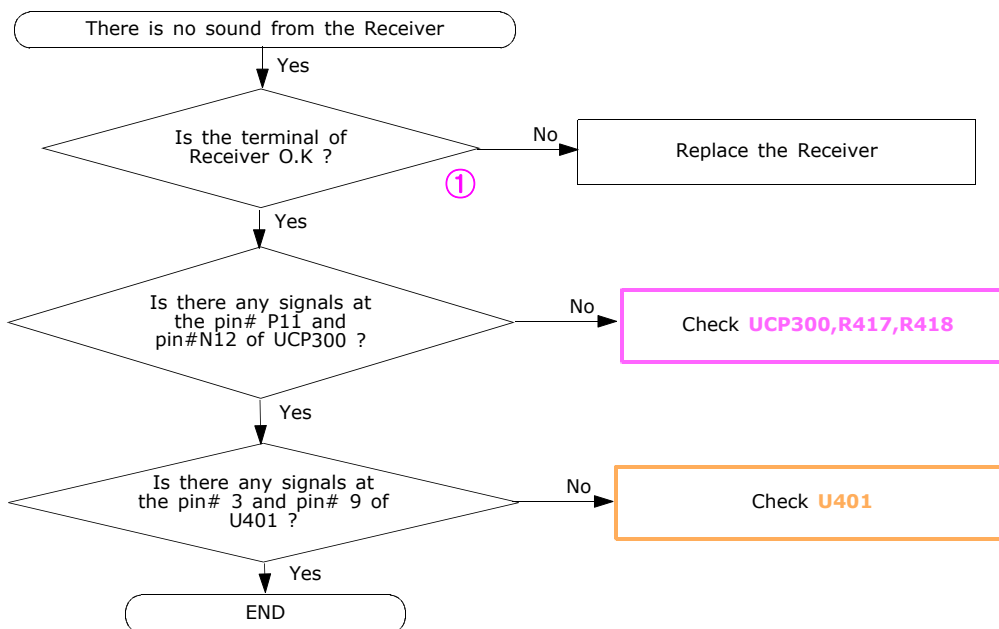

10-1-7. Speaker Part

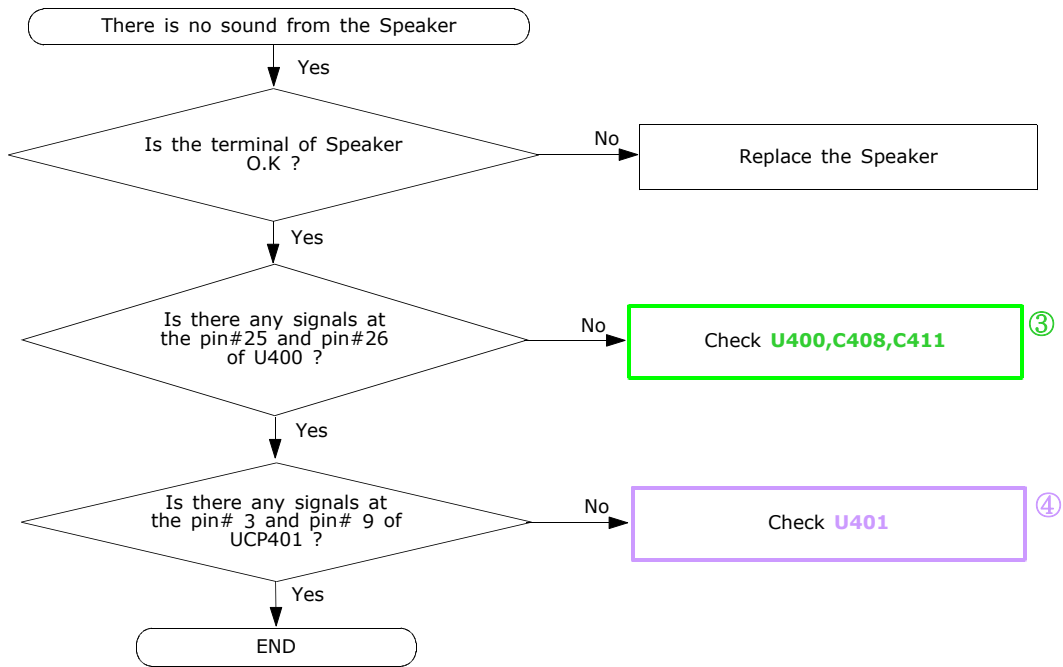

Flow Chart of Troubleshooting

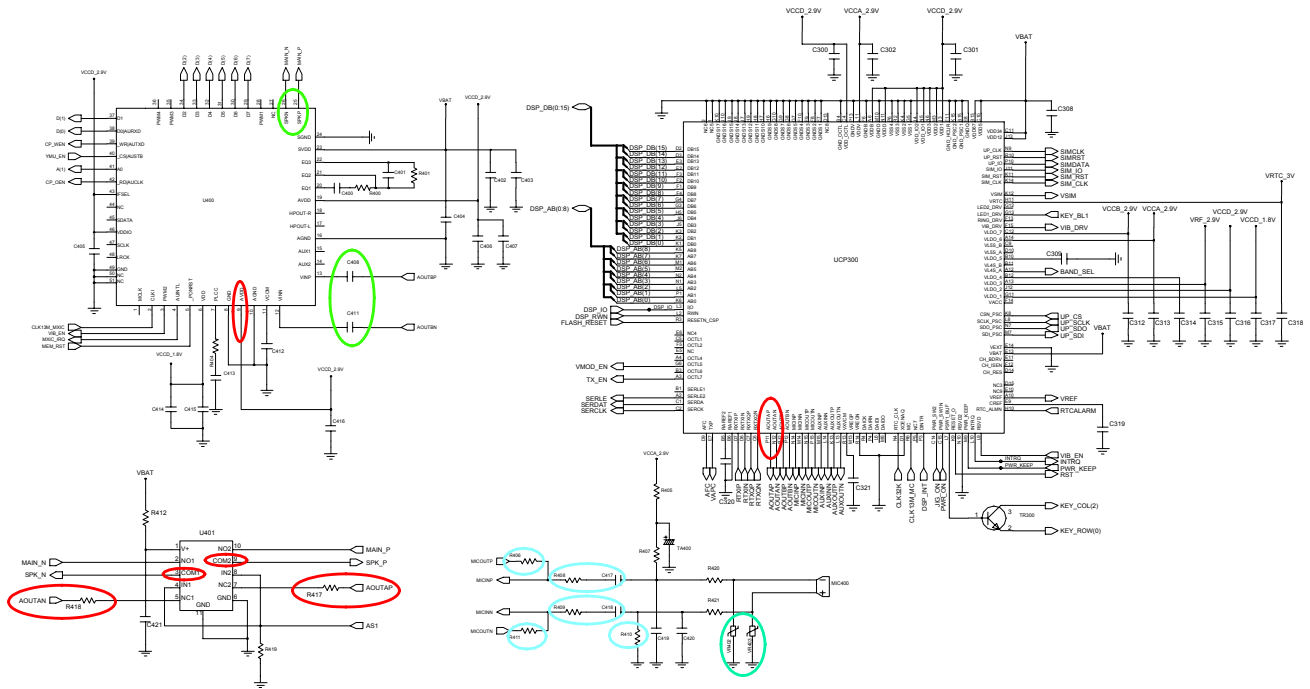

10-1-8. LCD

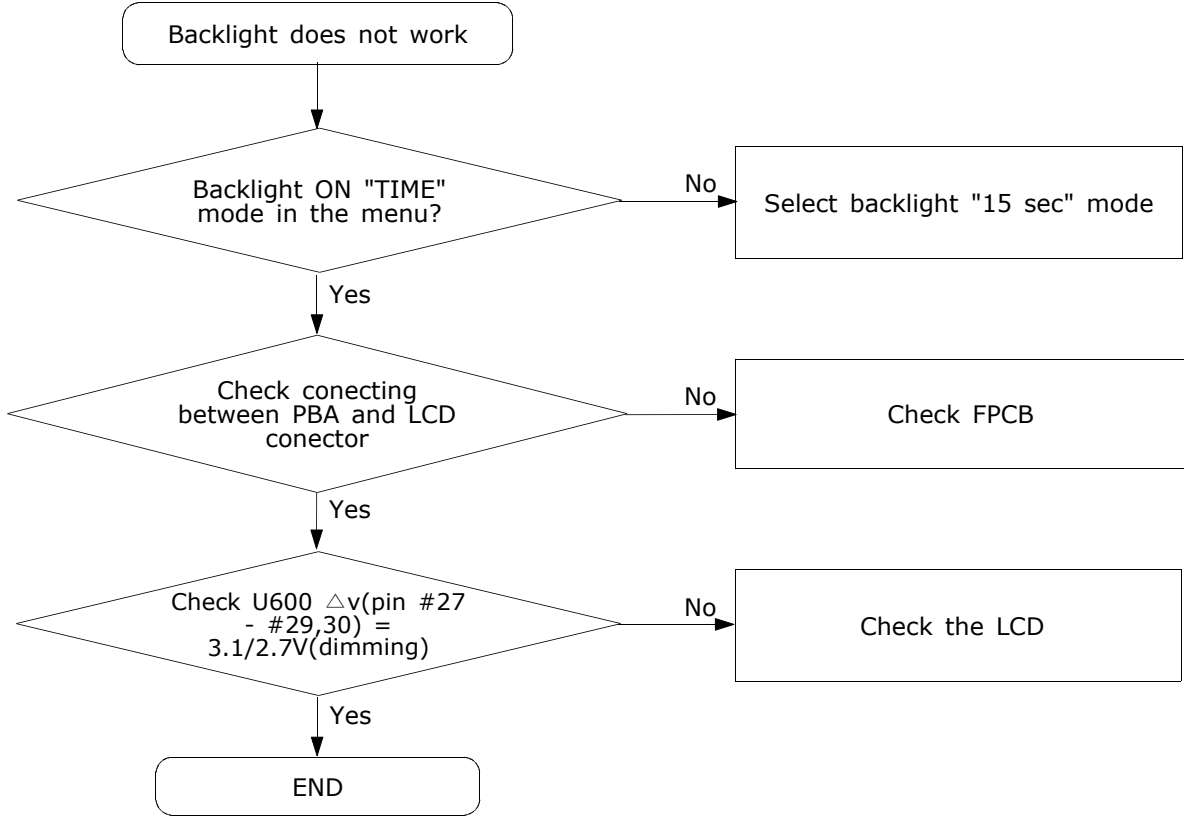

10-2.RF
10-2-1. EGSM Rx

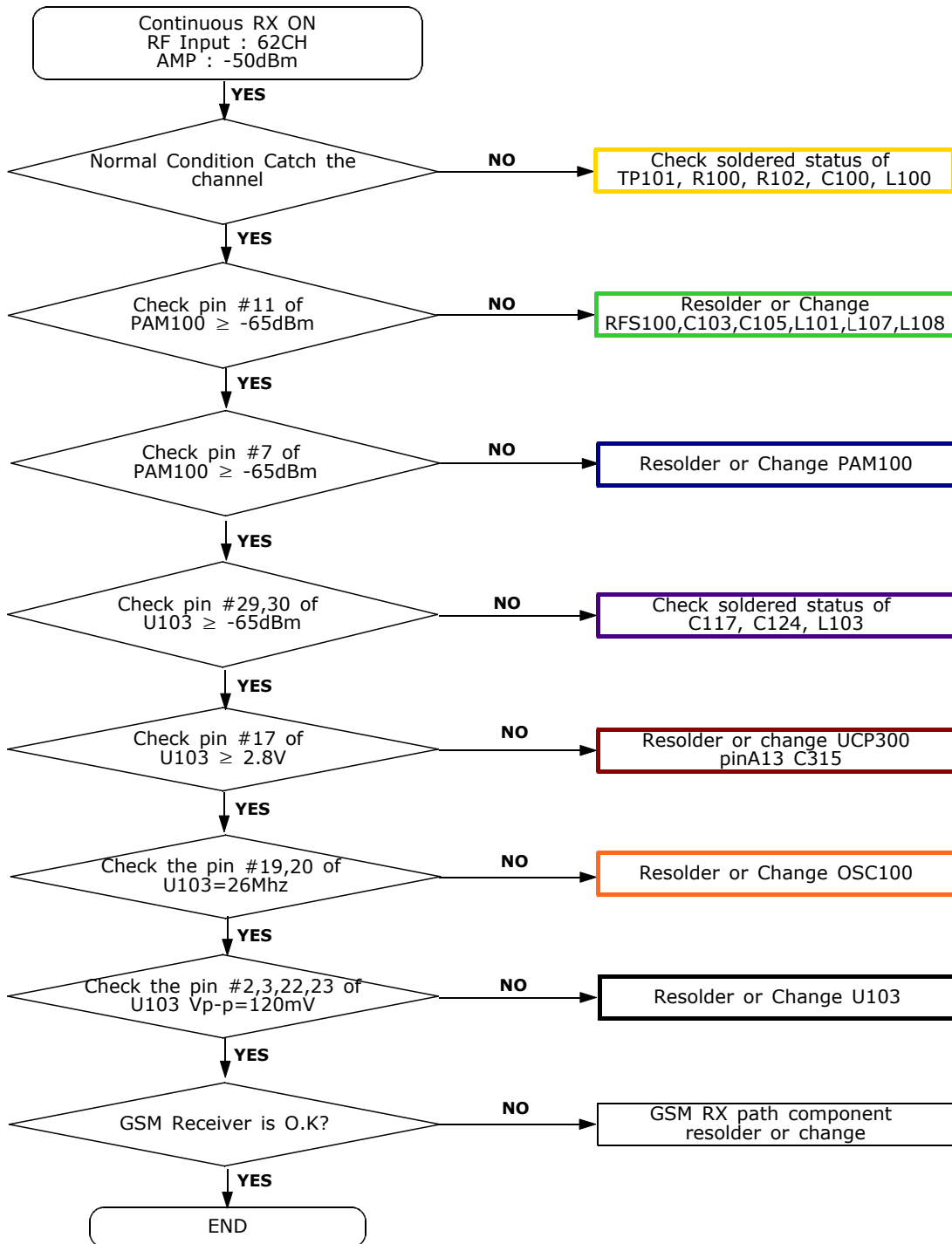

10-2-2. DCS Rx

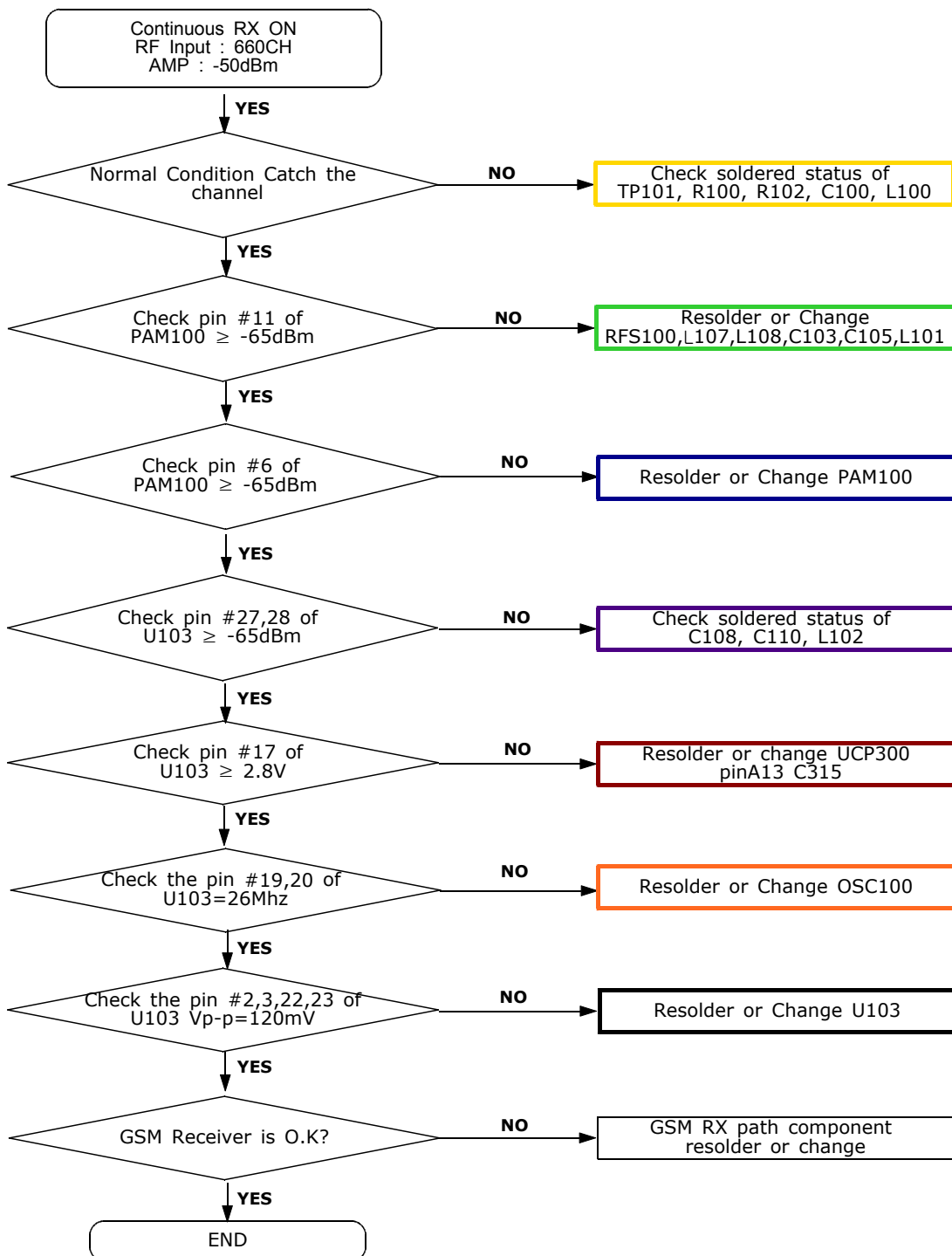

10-2-3. EGSM Tx

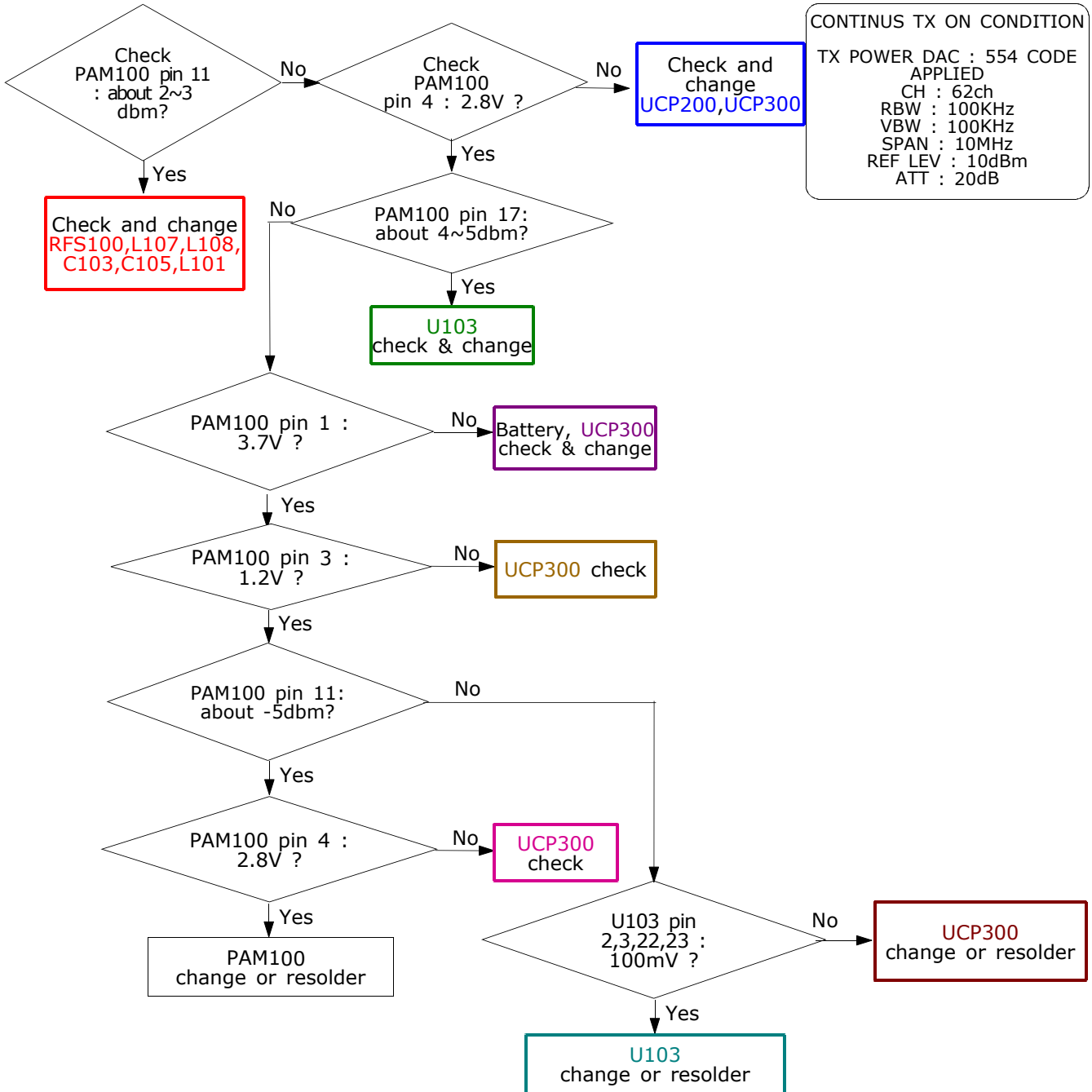

10-2-4. DCS Tx

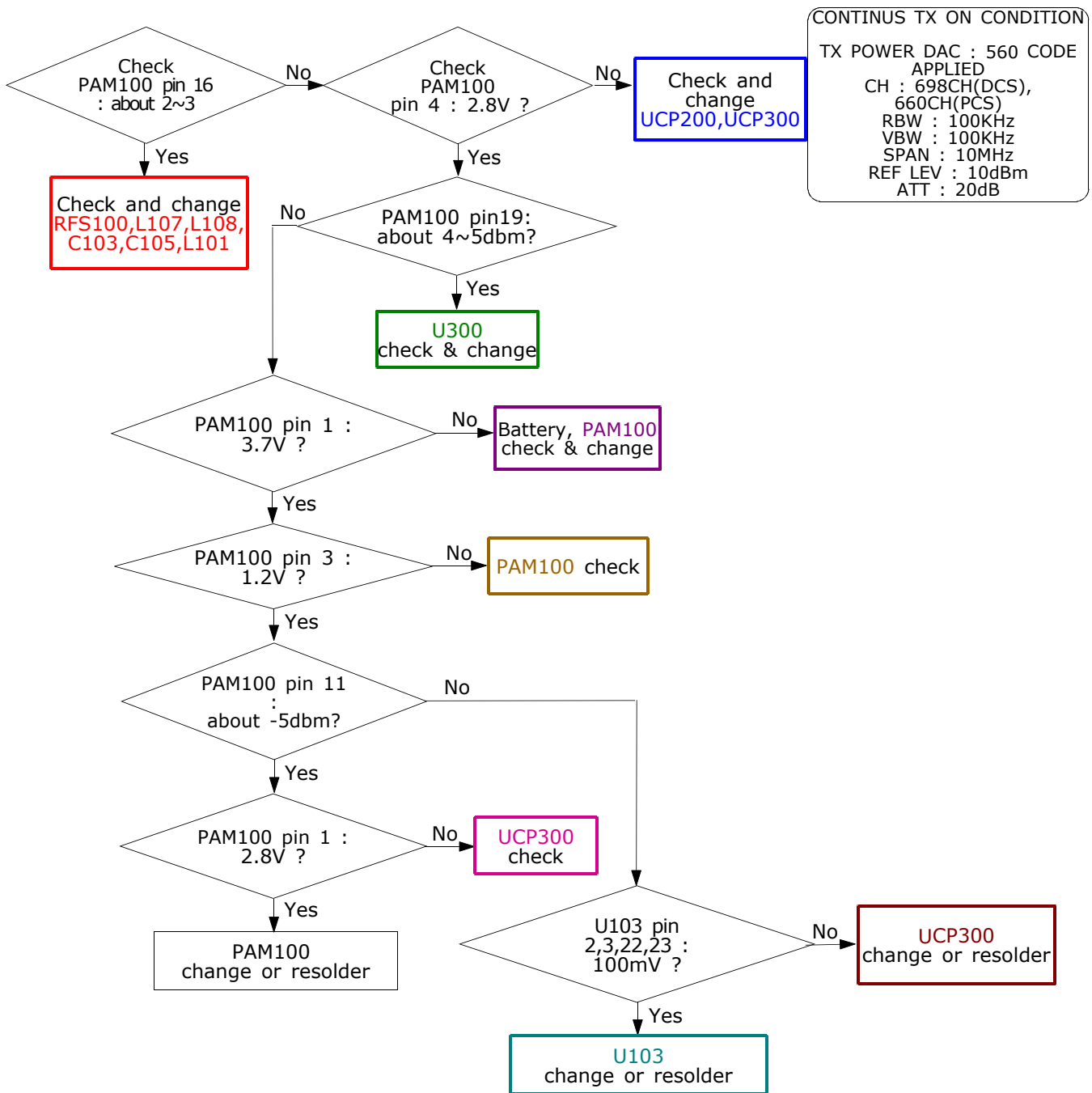

CONTINUS TX ON CONDITION
 TX POWER DAC : 560 CODE APPLIED
 CH : 698CH(DCS), 660CH(PCS)
 RBW : 100KHz
 VBW : 100KHz
 SPAN : 10MHz
 REF LEV : 10dBm
 ATT : 20dB

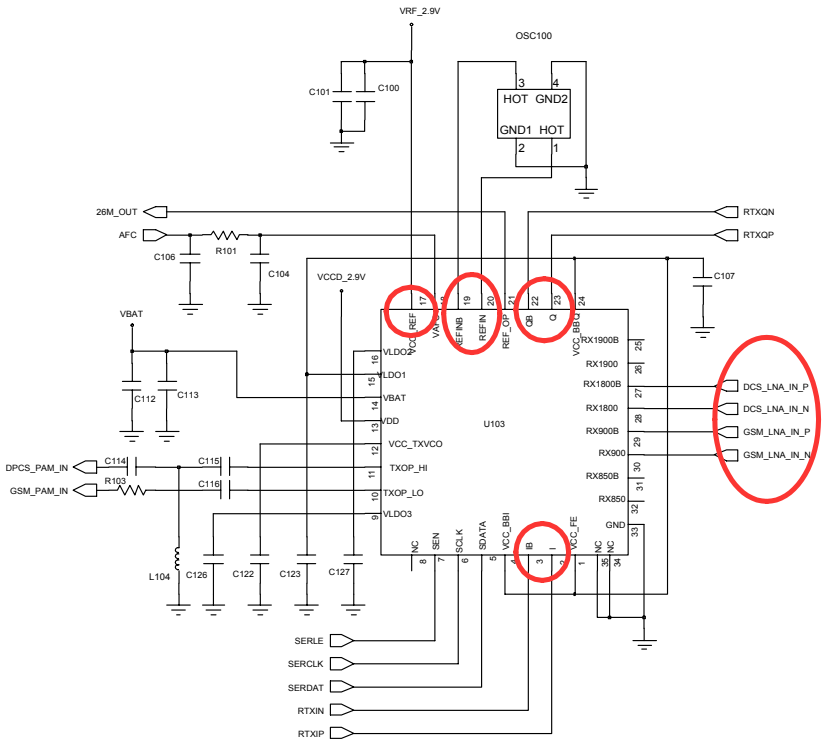
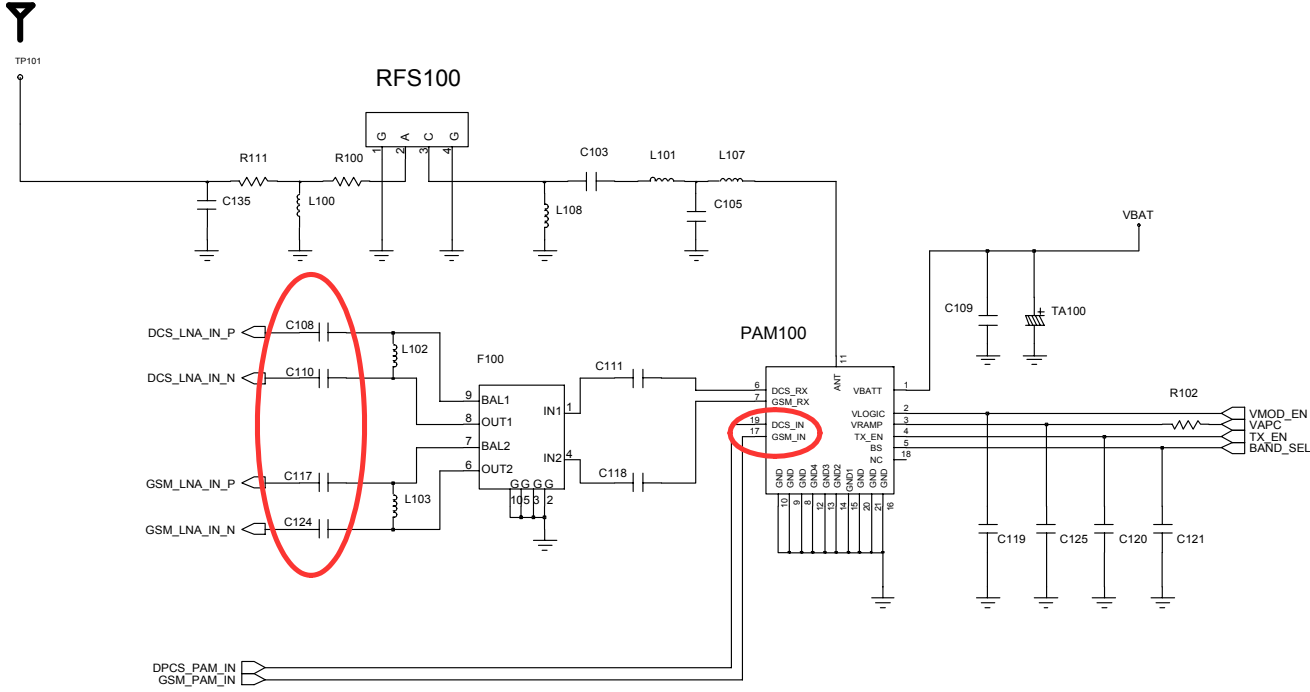

11. Reference data

11-1. Reference Abbreviate

AAC: Advanced Audio Coding.
AVC : Advanced Video Coding.
BER : Bit Error Rate
BPSK: Binary Phase Shift Keying
CA : Conditional Access
CDM : Code Division Multiplexing
C/I : Carrier to Interference
DMB : Digital Multimedia Broadcasting
EN : European Standard
ES : Elementary Stream
ETSI: European Telecommunications Standards Institute
MPEG: Moving Picture Experts Group
PN : Pseudo-random Noise
PS : Pilot Symbol
QPSK: Quadrature Phase Shift Keying
RS : Reed-Solomon
SI : Service Information
TDM : Time Division Multiplexing
TS : Transport Stream