

DENON

DVD AUDIO-VIDEO / SUPER AUDIO CD PLAYER

DVD-3930

OPERATING INSTRUCTIONS

BEDIENUNGSANLEITUNG

MODE D'EMPLOI

ISTRUZIONI PER L'USO

INSTRUCCIONES DE FUNCIONAMIENTO

GEBRUIKSAANWIJZING

BRUKSANVISNING



CAUTION
RISK OF ELECTRIC SHOCK
DO NOT OPEN



CAUTION:
TO REDUCE THE RISK OF ELECTRIC SHOCK, DO NOT REMOVE COVER (OR BACK). NO USER-SERVICEABLE PARTS INSIDE. REFER SERVICING TO QUALIFIED SERVICE PERSONNEL.



The lightning flash with arrowhead symbol, within an equilateral triangle, is intended to alert the user to the presence of uninsulated "dangerous voltage" within the product's enclosure that may be of sufficient magnitude to constitute a risk of electric shock to persons.



The exclamation point within an equilateral triangle is intended to alert the user to the presence of important operating and maintenance (servicing) instructions in the literature accompanying the appliance.

WARNING:
TO REDUCE THE RISK OF FIRE OR ELECTRIC SHOCK, DO NOT EXPOSE THIS APPLIANCE TO RAIN OR MOISTURE.

DECLARATION OF CONFORMITY

We declare under our sole responsibility that this product, to which this declaration relates, is in conformity with the following standards: EN60065, EN55013, EN55020, EN61000-3-2 and EN61000-3-3. Following the provisions of 73/23/EEC, 89/336/EEC and 93/68/EEC Directive.

ÜBEREINSTIMMUNGSERKLÄRUNG

Wir erklären unter unserer Verantwortung, daß dieses Produkt, auf das sich diese Erklärung bezieht, den folgenden Standards entspricht: EN60065, EN55013, EN55020, EN61000-3-2 und EN61000-3-3. Entspricht den Verordnungen der Direktive 73/23/EEC, 89/336/EEC und 93/68/EEC.

DECLARATION DE CONFORMITE

Nous déclarons sous notre seule responsabilité que l'appareil, auquel se réfère cette déclaration, est conforme aux standards suivants: EN60065, EN55013, EN55020, EN61000-3-2 et EN61000-3-3. D'après les dispositions de la Directive 73/23/EEC, 89/336/EEC et 93/68/EEC.

DICHIARAZIONE DI CONFORMITÀ

Dichiariamo con piena responsabilità che questo prodotto, al quale la nostra dichiarazione si riferisce, è conforme alle seguenti normative: EN60065, EN55013, EN55020, EN61000-3-2 e EN61000-3-3. In conformità con le condizioni delle direttive 73/23/EEC, 89/336/EEC e 93/68/EEC. QUESTO PRODOTTO È CONFORME AL D.M. 28/08/95 N. 548

DECLARACIÓN DE CONFORMIDAD

Declaramos bajo nuestra exclusiva responsabilidad que este producto al que hace referencia esta declaración, está conforme con los siguientes estándares: EN60065, EN55013, EN55020, EN61000-3-2 y EN61000-3-3. Siguiendo las provisiones de las Directivas 73/23/EEC, 89/336/EEC y 93/68/EEC.

EENVORMIGHEIDSVERKLARING

Wij verklaren uitsluitend op onze verantwoordelijkheid dat dit produkt, waarop deze verklaring betrekking heeft, in overeenstemming is met de volgende normen: EN60065, EN55013, EN55020, EN61000-3-2 en EN61000-3-3. Volgens de bepalingen van de Richtlijnen 73/23/EEC, 89/336/EEC en 93/68/EEC.

ÖVERENSSTÄMMELSEINTYG

Härmed intygas helt på eget ansvar att denna produkt, vilken detta intyg avser, uppfyller följande standarder: EN60065, EN55013, EN55020, EN61000-3-2 och EN61000-3-3. Enligt stadgarna i direktiv 73/23/EEC, 89/336/EEC och 93/68/EEC.

NOTE ON USE / HINWEISE ZUM GEBRAUCH / OBSERVATIONS RELATIVES A L'UTILISATION / NOTE SULL'USO / NOTAS SOBRE EL USO / ALVORENS TE GEBRUIKEN / OBSERVERA

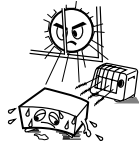

- Avoid high temperatures. Allow for sufficient heat dispersion when installed on a rack.
- Vermeiden Sie hohe Temperaturen. Beachten Sie, daß eine ausreichend Luftzirkulation gewährleistet wird, wenn das Gerät auf ein Regal gestellt wird.
- Éviter des températures élevées. Tenir compte d'une dispersion de chaleur suffisante lors de l'installation sur une étagère.
- Evitate di esporre l'unità a temperature alte. Assicuratevi che ci sia un'adeguata dispersione del calore quando installate l'unità in un mobile per componenti audio.
- Evite altas temperaturas. Permite la suficiente dispersión del calor cuando está instalado en la consola.
- Vermijd hoge temperaturen. Zorg voor een degelijk hitteafvoer indien het apparaat op een rek wordt geplaatst.
- Undvik höga temperaturer. Se till att det finns möjlighet till god värmeavledning vid montering i ett rack.

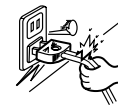

- Handle the power cord carefully. Hold the plug when unplugging the cord.
- Gehen Sie vorsichtig mit dem Netzkabel um. Halten Sie das Kabel am Stecker, wenn Sie den Stecker herausziehen.
- Manipuler le cordon d'alimentation avec précaution. Tenir la prise lors du débranchement du cordon.
- Maneggiare il filo di alimentazione con cura. Agite per la spina quando scollegate il cavo dalla presa.
- Maneje el cordón de energía con cuidado. Sostenga el enchufe cuando desconecte el cordón de energía.
- Hanteer het netsnoer voorzichtig. Houd het snoer bij de stekker vast wanneer deze moet worden aan- of losgekoppeld.
- Hantera nätkabeln varsamt. Håll i kabeln när den kopplas från el-uttaget.

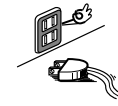

- Unplug the power cord when not using the set for long periods of time.
- Wenn das Gerät eine längere Zeit nicht verwendet werden soll, trennen Sie das Netzkabel vom Netzstecker.
- Débrancher le cordon d'alimentation lorsque l'appareil n'est pas utilisé pendant de longues périodes.
- Disinnestare il filo di alimentazione quando avete l'intenzione di non usare il filo di alimentazione per un lungo periodo di tempo.
- Desconecte el cordón de energía cuando no utilice el equipo por mucho tiempo.
- Neem altijd het netsnoer uit het stopcontact wanneer het apparaat gedurende een lange periode niet wordt gebruikt.
- Koppla ur nätkabeln om apparaten inte kommer att användas i lång tid.



- Do not let insecticides, benzene, and thinner come in contact with the set.
- Lassen Sie das Gerät nicht mit Insektiziden, Benzin oder Verdünnungsmitteln in Berührung kommen.
- Ne pas mettre en contact des insecticides, du benzène et un diluant avec l'appareil.
- Assicuratevi che l'unità non venga in contatto con insetticidi, benzolo o solventi.
- No permita el contacto de insecticidas, gasolina y diluyentes con el equipo.
- Laat geen insektenverdelgende middelen, benzine of verfverdunder met dit apparaat in contact komen.
- Se till att inte insektsmedel på spraybruk, bensen och thinner kommer i kontakt med apparatens hölje.



- * (For sets with ventilation holes)
- Do not obstruct the ventilation holes.
 - Die Belüftungsöffnungen dürfen nicht verdeckt werden.
 - Ne pas obstruer les trous d'aération.
 - Non coprire i fori di ventilazione.
 - No obstruya los orificios de ventilación.
 - De ventilatieopeningen mogen niet worden beblokkeerd.
 - Täpp inte till ventilationsöppningarna.



- Do not let foreign objects in the set.
- Keine fremden Gegenstände in das Gerät kommen lassen.
- Ne pas laisser des objets étrangers dans l'appareil.
- E' importante che nessun oggetto è inserito all'interno dell'unità.
- No deje objetos extraños dentro del equipo.
- Laat geen vreemde voorwerpen in dit apparaat vallen.
- Se till att främmande föremål inte tränger in i apparaten.



- Keep the apparatus free from moisture, water, and dust.
- Halten Sie das Gerät von Feuchtigkeit, Wasser und Staub fern.
- Protéger l'appareil contre l'humidité, l'eau et l'asséjour.
- Tenete l'unità lontana dall'umidità, dall'acqua e dalla polvere.
- Mantenga el equipo libre de humedad, agua y polvo.
- Laat geen vochtigheid, water of stof in het apparaat binnendringen.
- Utsätt inte apparaten för fukt, vatten och damm.

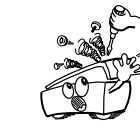

- Never disassemble or modify the set in any way.
- Versuchen Sie niemals das Gerät auseinander zu nehmen oder auf jegliche Art zu verändern.
- Ne jamais démonter ou modifier l'appareil d'une manière ou d'une autre.
- Non smontate mai, nè modificate l'unità in nessun modo.
- Nunca desarme o modifique el equipo de ninguna manera.
- Nooit dit apparaat demonteren of op andere wijze modifieren.
- Ta inte isär apparaten och försök inte bygga om den.

CAUTION:

- The ventilation should not be impeded by covering the ventilation openings with items, such as newspapers, tablecloths, curtains, etc.
- No naked flame sources, such as lighted candles, should be placed on the apparatus.
- Attention should be drawn to the environmental aspects of battery disposal.
- Do not expose the set to dripping or splashing fluids.
- No objects filled with liquids, such as vases, shall be placed on the apparatus.

- Das Gerät sollte keinerlei Flüssigkeit, also keinem Tropfen oder Spritzen ausgesetzt werden.
- Auf dem Gerät sollten keinerlei mit Flüssigkeit gefüllten Behälter wie beispielsweise Vasen aufgestellt werden.

ATTENTION:

- La ventilation ne doit pas être gênée en recouvrant les ouvertures de la ventilation avec des objets tels que journaux, rideaux, tissus, etc.
- Aucune flamme nue, par exemple une bougie, ne doit être placée sur l'appareil.
- Veillez à respecter l'environnement lorsque vous jetez les piles usagées.
- L'appareil ne doit pas être exposé à l'eau ou à l'humidité.
- Aucun objet contenant du liquide, par exemple un vase, ne doit être placé sur l'appareil.

ACHTUNG:

- Die Belüftung sollte auf keinen Fall durch das Abdecken der Belüftungsöffnungen durch Gegenstände wie beispielsweise Zeitungen, Tischtücher, Vorhänge o. Ä. behindert werden.
- Auf dem Gerät sollten keinerlei direkten Feuerquellen wie beispielsweise angezündete Kerzen aufgestellt werden.
- Bitte beachten Sie bei der Entsorgung der Batterien die geltenden Umweltbestimmungen.

- Non posizionare sull'apparecchiatura fiamme libere, come ad esempio le candele accese.
- Prestare attenzione agli aspetti legati alla tutela dell'ambiente quando si smaltisce la batteria.
- L'apparecchiatura non deve essere esposta a goccioli o spruzzi.
- Non posizionare sull'apparecchiatura nessun oggetto contenente liquidi, come ad esempio i vasi.

PRECAUCIÓN:

- La ventilación no debe quedar obstruida por hacerse cubierto las aperturas con objetos como periódicos, manteles, cortinas, etc.
- No debe colocarse sobre el aparato ninguna fuente inflamable sin protección, como velas encendidas.
- A la hora de deshacerse de las pilas, respete la normativa para el cuidado del medio ambiente.
- No se expondrá el aparato al goteo o salpicaduras cuando se utilice.
- No se colocarán sobre el aparato objetos llenos de líquido, como jarras.

WAARSCHUWING:

- De ventilatie mag niet worden belemmerd door de ventilatieopeningen af te dekken met bijvoorbeeld kranten, een tafelkleed, gordijnen, enz.
- Plaats geen open vlammen, bijvoorbeeld een brandende kaars, op het apparaat.
- Houd u steeds aan de milieuvorschriften wanneer u gebruikte batterijen wegdoet.
- Stel het apparaat niet bloot aan druppels of spatten.
- Plaats geen voorwerpen gevuld met water, bijvoorbeeld een vaas, op het apparaat.

OBSERVERA:

- Ventilations bör inte förhindras genom att täcka för ventilationsöppningarna med föremål såsom tidningar, bordssdukar, gardiner osv.
- Inga blottade brandkällor, såsom tända ljus, bör placeras på apparaten.
- Tänk på miljöaspekterna när du bortskaffar batteri.
- Apparaten får inte utsättas för vätska.
- Inga objekt med vätskor, såsom vaser, får placeras på apparaten.

CAUTION:

To completely disconnect this product from the mains, disconnect the plug from the wall socket outlet. The mains plug is used to completely interrupt the power supply to the unit and must be within easy access by the user.

VORSICHT:

Um dieses Gerät vollständig von der Stromversorgung abzutrennen, trennen Sie bitte den Netzstecker von der Wandsteckdose ab.

Die Hauptstecker werden verwendet, um die Stromversorgung zum Gerät völlig zu unterbrechen; er muss für den Benutzer gut und einfach zu erreichen sein.

PRECAUTION:

Pour déconnecter complètement ce produit du courant secteur, débranchez la prise de la prise murale.

La prise secteur est utilisée pour couper complètement l'alimentation de l'appareil et l'utilisateur doit pouvoir y accéder facilement.

ATTENZIONE:

Per scollegare definitivamente questo prodotto dalla rete di alimentazione elettrica, togliere la spina dalla relativa presa.

La spina di rete viene utilizzata per interrompere completamente l'alimentazione all'unità e deve essere facilmente accessibile all'utente.

PRECAUCIÓN:

Para desconectar completamente este producto de la alimentación eléctrica, desconecte el enchufe del enchufe de la pared.

El enchufe de la alimentación se utiliza para interrumpir por completo el suministro de alimentación a la unidad y debe encontrarse en un lugar al que el usuario tenga fácil acceso.

VOORZICHTIGHEID:

Om de voeding van dit product volledig te onderbreken moet de stekker uit het stopcontact worden getrokken.

De netstekker wordt gebruikt om de stroomtoevoer naar het toestel volledig te onderbreken en moet voor de gebruiker gemakkelijk bereikbaar zijn.

FÖRSIKTIHETSMÅTT:

Koppla loss stickproppen från eluttaget för att helt skilja produkten från nätet.

Stickproppen används för att helt bryta strömförsörjningen till apparaten, och den måste vara lättillgänglig för användaren.

CLASS 1 LASER PRODUCT
LUOKAN 1 LASERLAITE
KLASS 1 LASERAPPARAT

“CLASS 1
LASER PRODUCT”

ADVARSEL: USYNLIG LASERSTRÅLING VED ÅBNING, NÅR SIKKERHEDSAFBRYDERE ER UDE AF FUNKTION. UNDGÅ UDSAETTELSE FOR STRÅLING.

VAROITUS! LAITTEEN KÄYTTÄMINEN MUULLA KUIN TÄSSÄ KÄYTTÖOHJEESSA MAINITULLA TAVALLA SAATTAA ALTISTAA KÄYTTÄJÄN TURVALLISUUSLUOKAN 1 YLITTÄVÄLLE NÄKYMÄMTTÖMÄLLE LASERSÄTEILYLLE.

WARNING: OM APPARATEN ANVÄNDS PÅ ANNAT SÄTT ÄN I DENNA BRUKSANVISNING SPECIFICERATS, KAN ANVÄNDAREN UTSÄTTAS FÖR OSYNLIG LASERSTRÅLNING SOM ÖVERSKRIDER GRÄNSEN FÖR LASERKLASS 1.

ATTENZIONE: QUESTO APPARECCHIO E' DOTATO DI DISPOSITIVO OTTICO CON RAGGIO LASER. L'USO IMPROPRIO DELL'APPARECCHIO PUO' CAUSARE PERICOLOSE ESPOSIZIONI A RADIAZIONI!

CAUTION:

USE OF CONTROLS OR ADJUSTMENTS OR PERFORMANCE OF PROCEDURES OTHER THAN THOSE SPECIFIED HEREIN MAY RESULT IN HAZARDOUS RADIATION EXPOSURE.

THIS PRODUCT SHOULD NOT BE ADJUSTED OR REPAIRED BY ANYONE EXCEPT PROPERLY QUALIFIED SERVICE PERSONNEL.

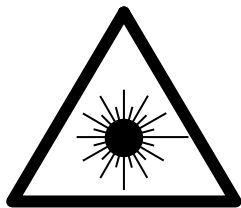
**A NOTE ABOUT RECYCLING:**

This product's packaging materials are recyclable and can be reused. Please dispose of any materials in accordance with the local recycling regulations.

When discarding the unit, comply with local rules or regulations.

Batteries should never be thrown away or incinerated but disposed of in accordance with the local regulations concerning chemical waste.

This product and the accessories packed together constitute the applicable product according to the WEEE directive except batteries.

**HINWEIS ZUM RECYCLING:**

Das Verpackungsmaterial dieses Produktes ist für zum Recyceln geeignet und kann wieder verwendet werden. Bitte entsorgen Sie alle Materialien entsprechend der örtlichen Recycling-Vorschriften.

Beachten Sie bei der Entsorgung des Gerätes die örtlichen Vorschriften und Bestimmungen.

Die Batterien dürfen nicht in den Hausmüll geworfen oder verbrannt werden; bitte geben Sie die Batterien gemäß örtlichen Bestimmungen an den Sammelstellen oder Sondermüllplätzen ab.

Dieses Produkt zusammen mit den Zubehörteilen ist das geltende Produkt der WEEE-Direktive, davon ausgenommen sind die Batterien.

UNE REMARQUE CONCERNANT LE RECYCLAGE:

Les matériaux d'emballage de ce produit sont recyclables et peuvent être réutilisés. Veuillez disposer de tout matériau conformément aux règlements de recyclage locaux.

Lorsque vous mettez cet appareil au rebut, respectez les lois ou réglementations locales.

Les piles ne doivent jamais être jetées ou incinérées, mais mises au rebut conformément aux règlements locaux concernant les déchets chimiques.

Ce produit et les accessoires emballés ensemble sont des produits conformes à la directive DEEE sauf pour les piles.

NOTA RELATIVA AL RICICLAGGIO:

I materiali di imballaggio di questo prodotto sono riutilizzabili e riciclabili. Smaltire i materiali conformemente alle normative locali sul riciclaggio.

Per smaltire l'unità, osservare la normativa in vigore nel luogo di utilizzo.

Non gettare le batterie, né incenerirle, ma smaltirle conformemente alla normativa locale sui rifiuti chimici. Questo prodotto e gli accessori inclusi nell'imballaggio sono applicabili alla direttiva RAEE, ad eccezione delle batterie.

ACERCA DEL RECICLAJE:

Los materiales de embalaje de este producto son reciclables y se pueden volver a utilizar. Disponga de estos materiales siguiendo los reglamentos de reciclaje de su localidad.

Cuando se deshaga de la unidad, cumpla con las reglas o reglamentos locales.

Las pilas nunca deberán tirarse ni incinerarse. Deberá disponer de ellas siguiendo los reglamentos de su localidad relacionados con los desperdicios químicos.

Este producto junto con los accesorios empaquetados es el producto aplicable a la directiva RAEE excepto pilas.

EEN AANTEKENING WAT BETREFT HET RECYCLEREN:

Het inpakmateriaal van dit product is recycleerbaar en kan opnieuw gebruikt worden. Er wordt verzocht om zich van elk afvalmateriaal te ontdoen volgens de plaatselijke voorschriften.

Volg voor het wegdoen van de speler de voorschriften voor de verwijdering van wit- en bruingoed op.

Batterijen mogen nooit worden weggegooid of verbrand, maar moeten volgens de plaatselijke voorschriften betreffende chemisch afval worden verwijderd.

Op dit product en de meegeleverde accessoires, m.u.v. de batterijen is de richtlijn voor afgedankte elektrische en elektronische apparaten (WEEE) van toepassing.

EN KOMMENTAR OM ÅTERVINNING:

Produktens emballage är återvinningsbart och kan återanvändas. Kassera det enligt lokala återvinningsbestämmelser.

När du kasserar enheten ska du göra det i överensstämmelse med lokala regler och bestämmelser.

Batterier får absolut inte kastas i soporna eller brännas. Kassera dem enligt lokala bestämmelser för kemiskt avfall. Denna apparat och de tillbehör som levereras med den är de som uppfyller gällande WEEE-direktiv, med undantag av batterierna.

Getting Started

Thank you for purchasing this DENON DVD Audio-Video / Super Audio CD player. Please read the operation instructions thoroughly in order to acquaint yourself with the DVD Audio-Video / Super Audio CD player and achieve maximum satisfaction from it. Be sure to keep these instructions for future reference, should any questions or problems arise.

Contents

Getting Started	
Accessories	3
Before using	3
Cautions on installation	3
About discs	
Discs usable on this set	3, 4
Holding discs	4
Loading discs	4
Cautions on loading discs	4
Cautions on handling	5
Cautions on storing discs	5
Cleaning discs	5
About the remote control unit	
Inserting the batteries	5
Operating range of the remote control unit	5
Part names and functions	
Front panel	6
Display	6
Rear panel	7
Remote control unit	7
Connections	
Cable indications	8
Connection to a TV	9
Digital connection to an AV amplifier with built-in decoder	9, 10
Connection to a device with 2-channels of analog audio inputs	10
Surround connections to a device with 5.1-channels of analog audio inputs	10
DENON LINK connections	11
Connection to a device with an HDMI terminal	11, 12
Digital connection to a recording device (MD recorder, etc.) ..	12
Connecting the power supply cord	12

Making the initial settings	
Table of initial settings	13, 14
Operations for making the initial settings	15
Language setting	16
Digital interface settings	
Setting the HDMI RGB picture quality settings	17
Setting the HDMI audio	17
Setting the HDMI speaker settings	17~19
Setting the HDMI auto format	19
Setting the DENON LINK	19
Video setting	
Setting the TV aspect ratio	20
Setting the TV type	20
Setting the component video output	20
Setting the AV Synchronized	21
Setting the squeeze mode	21
Setting the progressive mode	21
Setting the horizontal display range	22
Setting the AV1 video out	22
Audio settings	
Setting the audio channels	22
Setting the digital output	23
Setting the downsampling	23
Setting the source direct	23, 24
Setting the bass enhancer	24
Setting the dynamic range compression	24
Viewing restriction setting	
Setting the viewing restriction level	25
Setting the password	25
Setting the displaying the registration code	26
Special settings	
Setting the player mode	26
Setting the captions	26
Setting the wallpaper	26
Setting the screensaver	27
Setting the display	27
Setting the auto power mode	27
Setting the slide switching time	27

Other settings	
Using the pure direct mode	28
Making the settings for the picture output from the HDMI terminal	
Changing the signal format	29
Changing the resolution	29, 30
Performing keystone correction	
Performing keystone correction in the horizontal direction	30
Performing keystone correction in the vertical direction	30
Audio synchronization adjustment procedure	
Adjusting the picture quality	
Storing the picture quality settings in the memory	31, 32
Gamma correction	33

Basic Operation	
Turning the power on	34
Loading discs	34
Playing discs	
To stop playback	34
To pause playback	35
About DVD-Video discs	
Playing DVD-Video discs	35
Using the top menu and DVD menu	36
Switching the audio language (Multiple-Audio Function)	36
Switching the subtitle language (Multiple-Subtitle Function)	36
Switching the angle (Multiple-Angle Function)	36
About DVD-Audio discs	
Switching between groups and tracks	37
Playing bonus groups	37
Selecting still pictures	37
About Super Audio CDs	
Setting the Super Audio CD playback area/layer	38
About Video and Music CDs	
Playing discs with playback control	38
About discs containing MP3 and WMA format files	
About discs containing DivX® format files	
About discs containing still picture files	
Playing a disc containing files in JPEG format	40
Playing Picture CDs and Fujicolor CDs	41
Repeat and random play of MP3, WMA, JPEG and DivX® files	
42	

Getting Started

Convenient operations	
Fast-forwarding/Fast-reversing	42
Moving to the beginning	42
Searching using the NUMBER buttons.....	42
Frame-by-frame playback (for DVD-Video discs and Video CDs only)	43
Slow playback	43
Repeat playback	43, 44
Repeating a section between two specific points (A-B repeat playback)	44
Programmed playback	44
Playing in random order	44
Operating using the on-screen display	45, 46
Marking scenes you want to see again later	46
Adding marks	46
Calling out marked scenes	46
Zoomed play	47
Setting the video format	47
Adjusting the brightness of the display	47
Others	
About the DENON LINK function	48
Advanced AL24 Processing	48
Copyright protection technology	48
Resetting	48
Registered trademarks	48
Troubleshooting	49
Specifications	50

Getting Started

Accessories

Check that the following parts are attached in addition to the main unit:

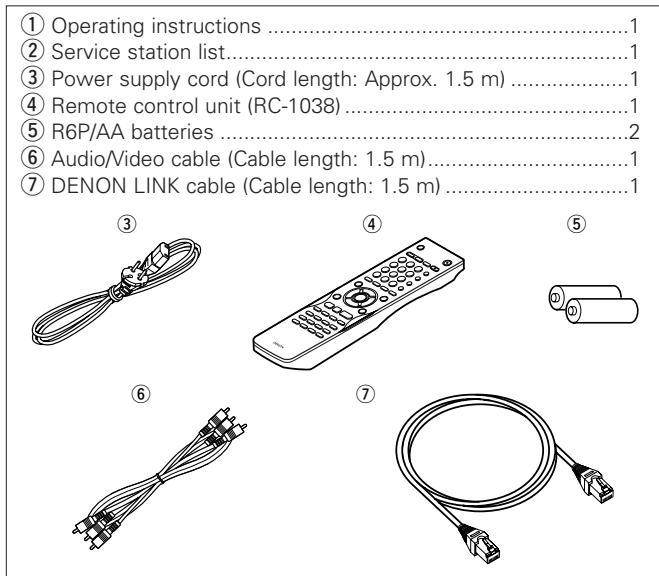

Before using

Pay attention to the following before using this unit:

• Moving the unit.

To prevent short-circuits or damaged wires in the connection cables, always unplug the power supply cord and disconnect the connection cables between all other audio components when moving the unit.

• Cautions on using mobile phones.

Using a mobile phone near this unit may result in noise. If so, move the mobile phone away from this unit when it is in use.

• Condensation (dew).

Water droplets may condense on internal operation parts if the set is brought into a heated room from the cold outdoors or when the room is heated rapidly. If this happens, the set may not operate properly.

• Should condensation occur.

The condensation will evaporate in one hour or less, at which time the system will function normally.

• Before turning the power operation button on.

Check once again that all connections are correct and that there are not problems with the connection cables. Always set the power operation button to the standby position before connecting and disconnecting connection cables.

• Sufficiently ventilate the place of installation.

If the unit is left in a room full of the smoke from cigarettes, etc., for long periods of time, the surface of the optical pickup could get dirty, in which case it will not be able to read the signals properly.

• Store the operating instructions in a safe place.

After reading the operating instructions, store them in a safe place as they could come in handy in the future.

• Whenever the power operation button is in the STANDBY state, the unit is still connected to AC line voltage.

Please be sure to turn off the power operation button or unplug the cord when you leave home for, say, a vacation.

• Note that the illustrations in these instructions may differ from the actual unit for explanation purposes.

Cautions on installation

Note:

For heat dispersal, do not install this unit in a confined space such as a bookcase or similar enclosure.

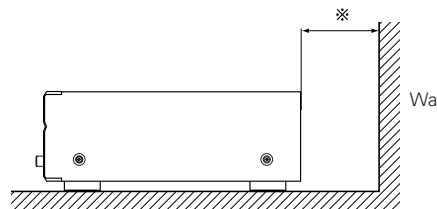
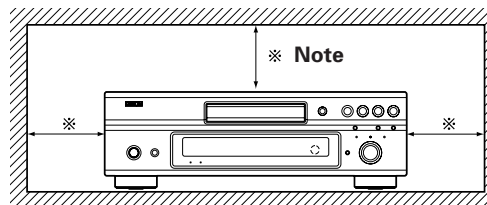

Getting Started

About discs

Discs usable on this set

The discs playable on the DVD-3930 are the discs shown on the table at the right.

Do not use discs with special shapes, as they could damage the player.

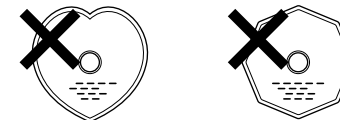

NOTE:

• DVD players and DVDs have specific region numbers (assigned by country).

The disc's region number must be the same as the player's or the disc cannot be played.

For European model:

The Region number for this DVD player is 2.



For Oceanian, South American model:

The Region number for this DVD player is 4.



Getting Started

Playable discs	Mark (logo)	Signal content	Disc size
DVD-Audio (*1)		Digital audio + Digital video (MPEG2 format)	12 cm/ 8 cm
DVD-Video (*1)			
DVD-R/DVD+R (*2)			
DVD-RW (*2) (*3) DVD+RW (*2)			
SUPER AUDIO CD	 Stereo Multi-ch	Digital audio	12 cm
Video CD (*1)		Digital audio + Digital video (MPEG1 format)	12 cm/ 8 cm
CD		Digital audio	12 cm/ 8 cm
CD-R (*4)		MP3	
CD-RW (*4)		Digital images (JPEG format)	
Picture CD		Digital images (JPEG format)	12 cm
Fujicolor CD		Digital images (JPEG format)	12 cm
WMA		Digital audio	12 cm
DivX®		Digital audio + Digital video (MPEG4 format)	12 cm

- *1 : Some DVD-Audio discs, DVD-Video discs and video CDs may be designed to by the software producer to operate in ways other than described in this manual.
- *2 : This player can play DVD±R/DVD±RW discs recorded in video format on DVD recorders. Depending on the recording conditions, however, the disc may not be recognized or it may not play normally (the picture or sound may be broken, etc.). Discs that have not been finalized cannot be played.
- *3 : DVD-RW discs can be played if they have been recorded in the VR (Video Recording) mode and finalized.
- *4 : Depending on the recording conditions, CD-R/CD-RW discs may not play normally.



The discs described below cannot be played:

- For European model:
DVDs with region numbers other than "2" or "ALL"
For Oceanian, South American model:
DVDs with region numbers other than "4" or "ALL"
- DVD-ROM/RAM (For DVD-ROM discs, data files in DivX® 3.11, 4.x, 5.x and 6 format can be played)
- CD-ROM (Data files in MP3, JPEG, WMA, and DivX® 3.11, 4.x, 5.x and 6 can be played)
- VSD/CVD/SVCD
- CDV (Only the audio part can be played)
- CD-G (Only the audio signals can be output)
- Photo CDs, etc.

Holding discs

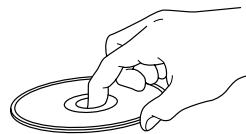

Do not touch the signal surface.

Getting Started

Loading discs

- Set the disc with the labeled side facing up.
- Make sure the disc tray is fully open when inserting the disc.
- Place the discs flatly, 12 cm discs in the outer tray guide (Figure 1), 8 cm discs in the inner tray guide (Figure 2).

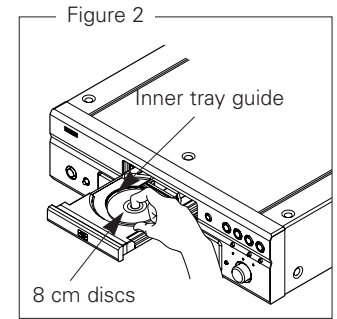
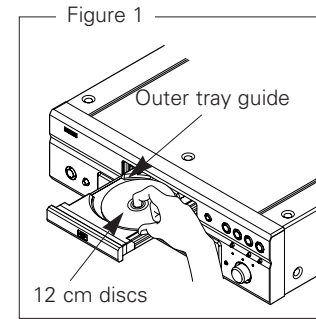

- Place 8 cm discs in the inner tray guide without using an adapter.



- If a disc that cannot be played is loaded or the disc is loaded upside-down, "0h00m00s" is displayed on the player's display.

NOTE:

- Do not push the disc tray in by hand when the power is off. Doing so could damage it.

Cautions on loading discs

- Only load one disc at a time. Loading two or more discs can damage the set or scratch the discs.
- Do not use cracked or warped discs or discs that have been repaired with adhesive, etc.
- Do not use discs on which the sticky part of cellophane tape or labels is exposed or on which there are traces of where labels have been removed. Such discs could get caught inside the player and damage it.

Getting Started

Cautions on handling

- Do not get fingerprints, oil or dirt on discs.
- Take special care not to scratch discs when removing them from their cases.
- Do not bend or heat discs.
- Do not enlarge the hole at the center.
- Do not write on the labeled (printed) surface with ball-point pens, pencils, etc., or stick new labels on discs.
- Water droplets may form on discs if they are moved suddenly from a cold place (outdoors for example) to a warm place, but do not try to dry them off using a hairdryer, etc.

Cautions on storing discs

- Be sure to remove discs after using them.
- Be sure to store discs in their cases to protect them from dust, scratches, warping, etc.
- Do not store discs in the following places:
 1. Places exposed to direct sunlight for long periods of time
 2. Dusty or humid places
 3. Places exposed to heat from heating appliances, etc.

Cleaning discs

- If there are fingerprints or dirt on discs, wipe them off before using the disc. If not the sound quality could be reduced and the sound may be broken.
- Use a commercially available disc cleaning set or a soft cloth to clean discs.

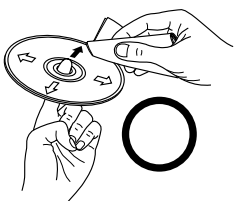

Gently wipe the disc from the inside towards the outside.

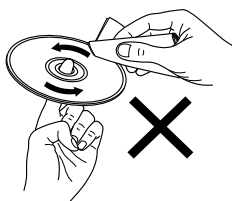

Do not wipe with a circular motion.

NOTE:

- Do not use record spray, antistatic agents, or benzene, thinner or other solvents.

About the remote control unit

Inserting the batteries

- ① Remove the cover.
- ② Set two R6P/AA batteries in the battery compartment in the indicated direction.

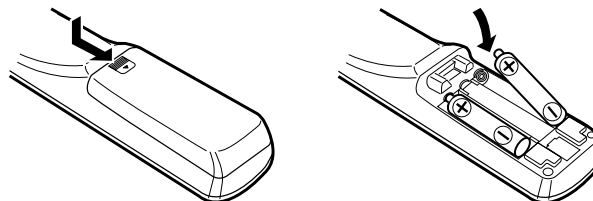

- ③ Set the cover back in place.

Notes on batteries:

- Replace the batteries with new ones if the set does not operate even when the remote control unit is operated nearby the unit. (The attached batteries are only for verifying operation.)
- When inserting the batteries, be sure to do so in the proper direction, following the “+” and “-” marks in the battery compartment.
- To prevent damage or leakage of battery fluid:
 - Do not use a new battery together with an old one.
 - Do not use two different types of batteries.
- Do not short-circuit, disassemble, heat or dispose of batteries in flames.
- Remove the batteries from the remote if it will not be in use for long periods.
- If the battery fluid should leak, carefully wipe the fluid off the inside of the battery compartment and insert new batteries.
- When replacing the batteries, have the new batteries ready and insert them as quickly as possible.

Getting Started

Operating range of the remote control unit

- Point the remote control unit at the remote sensor when operating it.
- The remote control unit can be used from a distance of up to about 7 meters, at a horizontal angle of up to 30° with respect to the sensor.

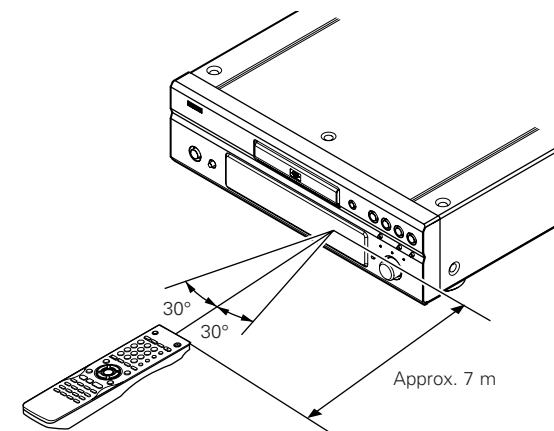

NOTE:

- It may be difficult to operate the remote control unit if the remote sensor is exposed to direct sunlight or strong artificial light.

Getting Started

Part names and functions

For buttons not explained here, see the page indicated in parentheses ().

Front panel

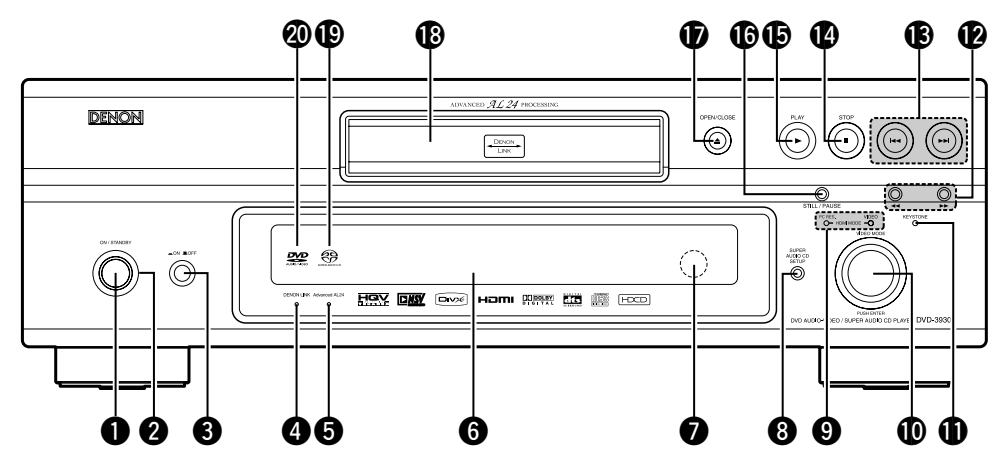

- 1 Power operation button (ON/STANDBY)(34)
- 2 Power indicator(34)
- 3 Power switch (ON/OFF)(15, 34)
- 4 DENON LINK indicator(48)
- 5 Advanced AL24 indicator(48)
- 6 Display
- 7 Remote control sensor(5)
- 8 SUPER AUDIO CD SETUP button(38)
- 9 HDMI MODE PC RES/VIDEO indicator(29)
- 10 VIDEO MODE knob(29)
- 11 KEYSTONE indicator(30)
- 12 Slow/Search buttons (◀◀, ▶▶)(42)
- 13 Skip buttons (◀◀, ▶▶)(41)
- 14 STOP button (■)(34)
- 15 PLAY button (▶)(34)
- 16 STILL/PAUSE button(35)
- 17 OPEN/CLOSE button (▲)(34)
- 18 Disc Tray(4)
- 19 Super Audio CD indicator
- 20 DVD-AUDIO/VIDEO indicator

Getting Started

Display

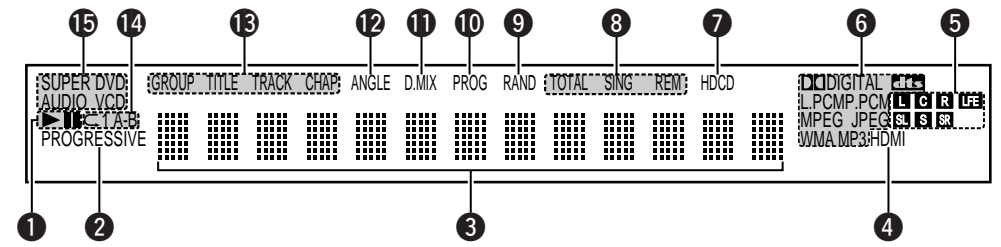

- 1 ▶ : Displayed during playback.
 ■ : Displayed when in the pause or frame-by-frame play mode.
- 2 Displayed when "COMPONENT VIDEO OUT" is set to "PROGRESSIVE".
- 3 Various types of information on the disc, the elapsed playing time, etc., are displayed here.
- 4 Displayed when HDMI video or audio signals are being output.
 Flashes when connection of the HDMI terminal is being checked.
- 5 These indicate the channels being played.
 L : Front left
 C : Center
 R : Front right
 LFE : Subwoofer
 SL : Surround left
 S : Surround monaural
 SR : Surround right
- 6 These indicate the format being played.
- 7 Displayed when playing HDCD-compatible discs.
- 8 Indicates the time display mode.
- 9 Displayed during random playback.
- 10 Displayed during program playback.
- 11 Displayed when the audio signals can be down-mixed.
- 12 Displayed when playing discs containing multiple angles.
- 13 These indicate the type of the different sections of the currently playing disc.
- 14 Displayed during repeat playback.
- 15 These indicate the type of the currently playing disc.

Rear panel

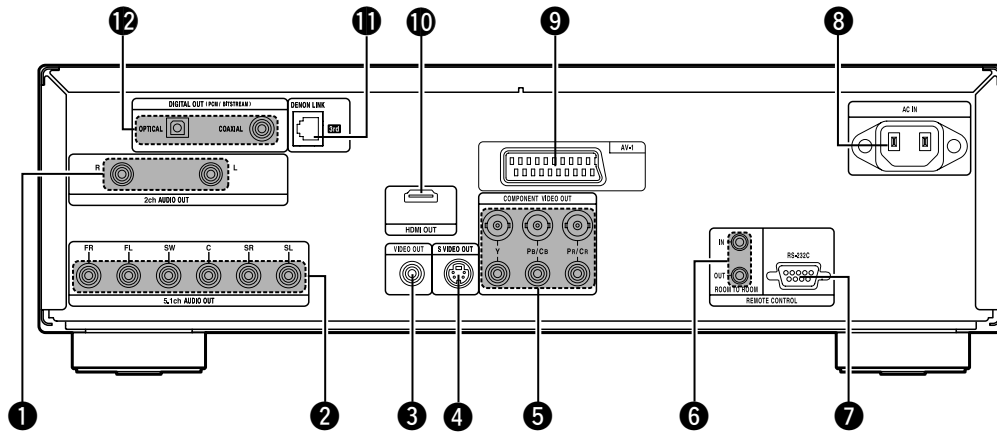

- 1 2ch AUDIO OUT terminals(9, 10)
- 2 5.1ch AUDIO OUT terminals(10)
- 3 VIDEO OUT terminal.....(9)
- 4 S-VIDEO OUT terminal.....(9)
- 5 COMPONENT VIDEO OUT terminals(9)
- 6 ROOM TO ROOM IN/OUT jacks
Control terminal for system extension.
- 7 RS-232C input/output terminal
Control terminal for system extension.
- 8 AC inlet(12)
- 9 AV-1 output terminal(9)
- 10 HDMI OUT terminal(11)
- 11 DENON LINK output terminal(11)
- 12 DIGITAL OUT COAXIAL/
OPTICAL terminals.....(9, 12)

Remote control unit

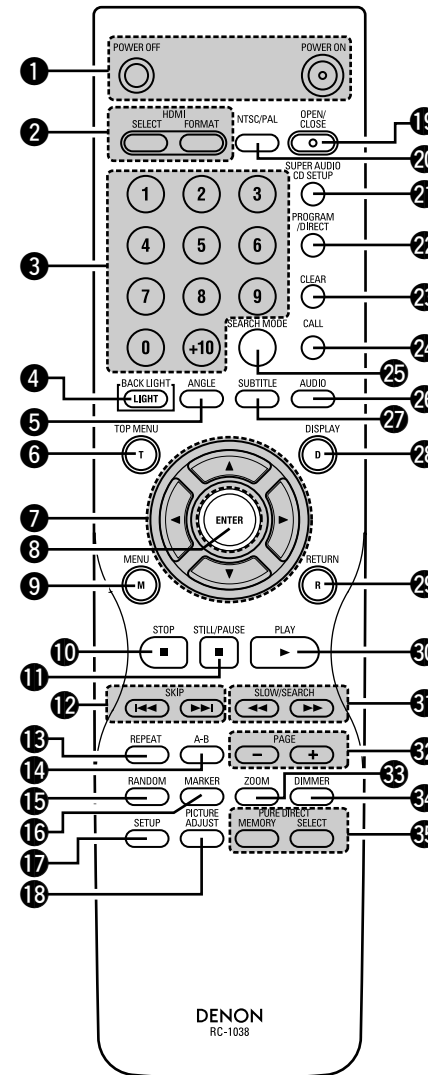







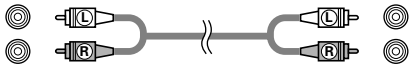

- 1 POWER ON/OFF buttons(34)
- 2 HDMI SELECT/FORMAT buttons(29)
- 3 Number buttons (0 ~ 9, +10).....(16, 36)
- 4 BACK LIGHT button
Press this to light the opal color button.
Press again this to put out light.
- 5 ANGLE button(36)
- 6 TOP MENU button(36)
- 7 Cursor buttons (Δ ▽ ◀ ▶)(15)
- 8 ENTER button(15)
- 9 MENU button(36)
- 10 STOP button(34)
- 11 STILL/PAUSE button(35)
- 12 SKIP buttons.....(41, 42)
- 13 REPEAT button(39)
- 14 A-B button(44)
- 15 RANDOM button(39)
- 16 MARKER button(46)
- 17 SETUP button.....(15)
- 18 PICTURE ADJUST button.....(32)
- 19 OPEN/CLOSE button(34)
- 20 NTSC/PAL button(47)
- 21 SUPER AUDIO CD SETUP button.....(38)
- 22 PROGRAM/DIRECT button(44)
- 23 CLEAR button(37)
- 24 CALL button(44)
- 25 SEARCH MODE button.....(37)
- 26 AUDIO button.....(36)
- 27 SUBTITLE button(36)
- 28 DISPLAY button.....(39, 45)
- 29 RETURN button.....(19)
- 30 PLAY button.....(34)
- 31 SLOW/SEARCH buttons.....(42)
- 32 PAGE buttons(37)
- 33 ZOOM button(41)
- 34 DIMMER button(47)
- 35 PURE DIRECT
MEMORY/SELECT buttons(28)

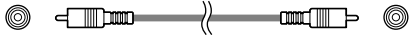
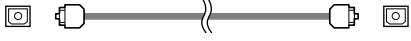
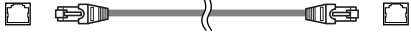
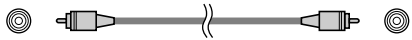
Connections

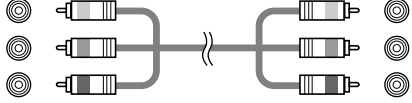
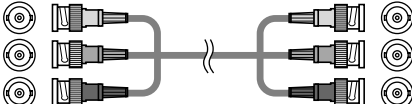
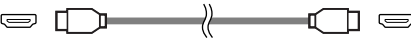
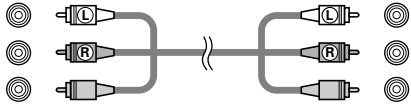
Cable indications

Connect using the connection cables shown below.

Audio cable	Video cable	Audio and Video cable
<p>A Analog audio connections</p>  <p>Pin-plug cable</p> <p>B Analog audio connections</p>  <p>Pin-plug cable</p> <p>C Coaxial digital connections</p>  <p>Coaxial digital cable (75 Ω/ohms pin-plug cable)</p> <p>D Digital connections (Optical)</p>  <p>Optical fiber cable</p> <p>E DENON LINK connections</p>  <p>DENON LINK cable (Included)</p>	<p>F Video connections</p>  <p>Video cable (75 Ω/ohms pin-plug cable)</p> <p>G S-Video connections</p>  <p>S-terminal cable</p> <p>H Component video connections (when pin-plug cable connected)</p>  <p>Component video cable</p> <p>I Component video connections (when BNC cable connected)</p>  <p>Component video cable</p>	<p>J HDMI connections</p>  <p>HDMI cable</p> <p>K Analog audio/video connections</p>  <p>Audio/video cable (Included)</p> <p>L AV-1 connections</p>  <p>21-pin SCART cable</p> <hr/> <p style="text-align: center;">Signal direction</p> <p>Audio signal </p> <p>Video signal </p>

- NOTE:**
- Do not plug in the power supply cord until all connections have been completed.
 - When making connections, also refer to the operating instructions of the other components.
 - Be sure to connect the left and right channels properly (left with left, right with right).
 - Making connections with the power turned on could result in noise or damage the speakers.
 - Bunching the power supply cords and connection cables together could result in humming or noise.
 - Do not connect to the amplifier's PHONO input terminal. Doing so could result in damage.
 - Install the player in a place where the surrounding temperature is 35°C or below.

Connections

Connection to a TV

For a TV equipped with a video input or S-Video input terminal

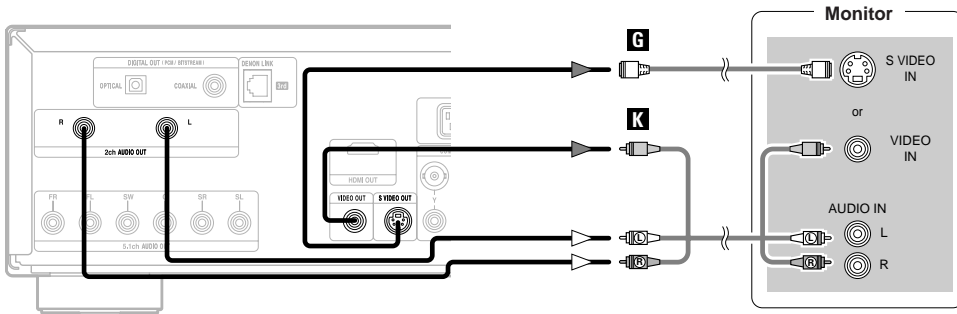

For a TV equipped with component video input terminals

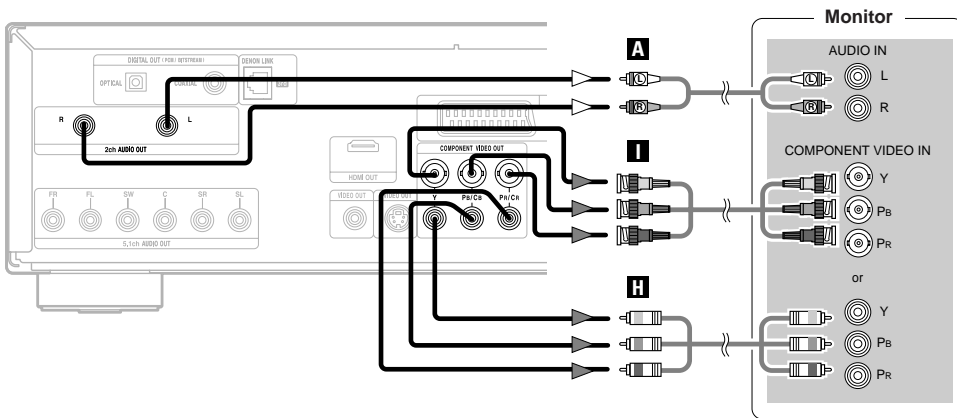

- If the TV to which the player is to be connected is compatible with progressive scan video, connect to the component video input terminals.
- For TVs not compatible with the progressive mode, set "COMPONENT VIDEO OUT" at "VIDEO SETUP" to "INTERLACED".

CONSUMERS SHOULD NOTE THAT NOT ALL HIGH DEFINITION TELEVISION SETS ARE FULLY COMPATIBLE WITH THIS PRODUCT AND MAY CAUSE ARTIFACTS TO BE DISPLAYED IN THE PICTURE. IN CASE OF 525 OR 625 PROGRESSIVE SCAN PICTURE PROBLEMS, IT IS RECOMMENDED THAT THE USER SWITCH THE CONNECTION TO THE "STANDARD DEFINITION" OUTPUT. IF THERE ARE QUESTIONS REGARDING OUR TV SET COMPATIBILITY WITH THIS MODEL 525p AND 625p DVD PLAYER, PLEASE CONTACT OUR CUSTOMER SERVICE CENTER.

Connections

For a TV equipped with an AV-1 input terminal

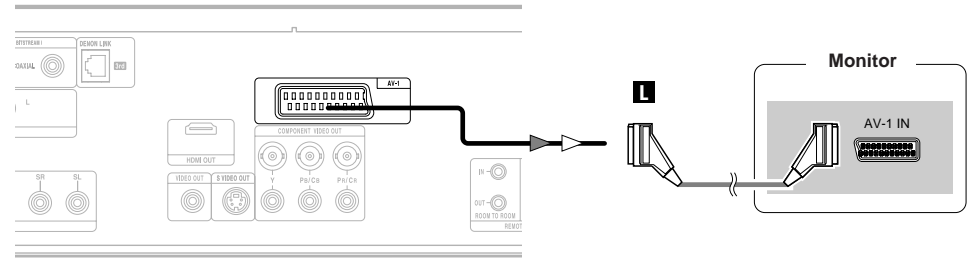

- To improve picture quality, you can change the video signal output from the AV-1 terminal from "VIDEO" to either "S-VIDEO" or "RGB" to suit the type of television you are using (page 22).

NOTE:

- Connect the DVD-3930's video output either directly to the TV or indirectly via an AV amplifier. Do not connect it via a VCR (video cassette recorder). Some discs include copy prohibit signals. If such discs are played via a VCR, the copy guard system may disturb the picture.

Digital connection to an AV amplifier with built-in decoder

When playing DVDs recorded in Dolby Digital or DTS, the Dolby Digital or DTS bitstream is output from the DVD-3930's digital audio output terminal. By connecting the DVD-3930 to an AV amplifier equipped with a built-in Dolby Digital or DTS decoder you can achieve sound with a power and sense of presence like that of a movie theater or concert hall.

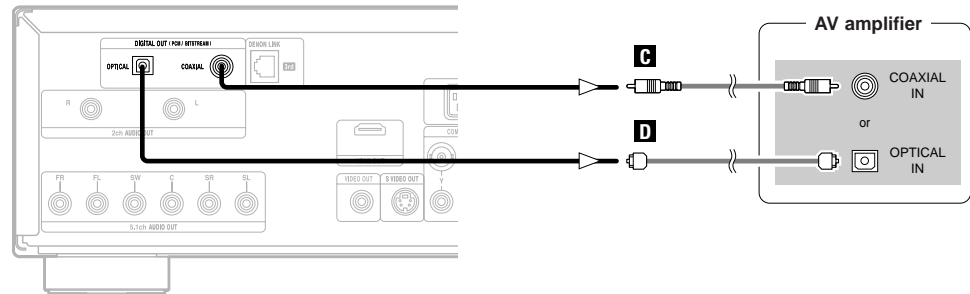

NOTE:

- Playing a DVD recorded in DTS when connected to an AV amplifier (decoder) that is not DTS compatible could result in noise that is unpleasant on the ears and could damage the speakers.

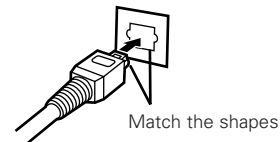

- When using an optical fiber cable (commercially available), insert its plug fully in the proper direction.

Connections

Audio signals output from the DVD-3930's digital audio output terminals

Bitstream output			
Disc type	Audio recording format	With "DIGITAL OUTPUT" as initial setting	
		NORMAL	PCM
DVD-Video	Dolby Digital	Dolby Digital bitstream	2-channel PCM (48 kHz / 16 bit)
	DTS	DTS bitstream	
	MPEG Audio	2-channel PCM (48 kHz / 16 bit)	

PCM output					
Disc type	Audio recording format	With "DOWN SAMPLING" as initial setting			
		OFF		ON	
		With copyright protection	Without copyright protection		
DVD-Video	Linear PCM	48 kHz / 16 ~ 24 bit	No output *1	48 kHz / 16 ~ 24 bit PCM	48 kHz / 16 bit PCM
		96 kHz / 16 ~ 24 bit	No output	96 kHz / 16 ~ 24 bit PCM	
DVD-Audio	Linear PCM or Packed PCM	44.1/88.2/176.4 kHz / 16 ~ 24 bit	No output *2	44.1/88.2 kHz / 16 ~ 24 bit *3	44.1 kHz / 16 bit PCM
		48/96/192 kHz / 16 ~ 24bit	No output *1	48/96 kHz / 16 ~ 24bit *3	48 kHz / 16 bit PCM
Video CD	MPEG1			44.1 kHz / 16 bit PCM	44.1 kHz / 16 bit PCM
Music CD	44.1 kHz / 16 bit Linear PCM				
MP3 CD	MP3 (MPEG-1 Audio Layer 3)				
WMA CD	WMA (Windows Media Audio)			32/44.1/48 kHz / 16 bit PCM	32/44.1/48 kHz / 16 bit PCM
Super audio CD	DSD (Direct Stream Digital)			No output *4	No output *4

*1 : Only 48 kHz/16 bit sources output

*2 : Only 44.1 kHz/16 bit sources output

*3 : 176.4 kHz/192 kHz signals are converted to 88.2 kHz/96 kHz respectively.

*4 : When playing the CD layer, 44.1 kHz/16 bit linear PCM signal output



• **Bitstream:**

These are signals that have been compressed and converted to digital.

Depending on the decoder, they are decoded for example into 5.1-channel multi-channel audio signals.

• **Linear PCM (LPCM):**

These are audio signals that have been converted to digital without being compressed (the signal recording format used for music CDs).

While music CDs are recorded in 44.1 kHz/16 bit format, DVDs are recorded in anything between 44.1 kHz/16 bit and 192 kHz/24 bit format, so they generally offer higher sound quality than music CDs.

• **Packed PCM (PPCM):**

These are compressed PCM signals providing high sound quality with virtually no data loss when restored to the original signals.

• When a DVD source containing PCM signals recorded in multi-channel is played, the signals are down-mixed to the 2-channels for output (the DVD-3930's "D.MIX" indicator lights).

For sources for which down-mixing is prohibited, only the FL and FR channels are output.

Connections

Connection to a device with 2-channels of analog audio inputs

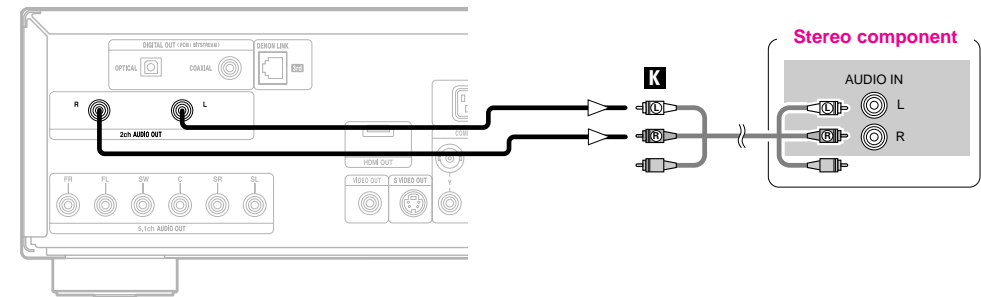

NOTE:

• When connecting to a 2-channel audio stereo device, use the "2ch AUDIO OUT" terminals. If the "5.1ch AUDIO OUT FL/FR" terminals are used, set "AUDIO SETUP" in "initial settings" to "2CH (VSS OFF)", "2CH (VSS1 ON)" or "2CH (VSS2 ON)" (page 22). For software recorded in multi-channel, analog signals that have been down-mixed into 2 channels are output. (For sources for which down-mixing is prohibited, only the FL/FR signals are output.)

Surround connections to a device with 5.1-channels of analog audio inputs

The multi-channel audio signals of Super Audio CDs and multi-channel audio signals recorded in packed PCM format can be played.

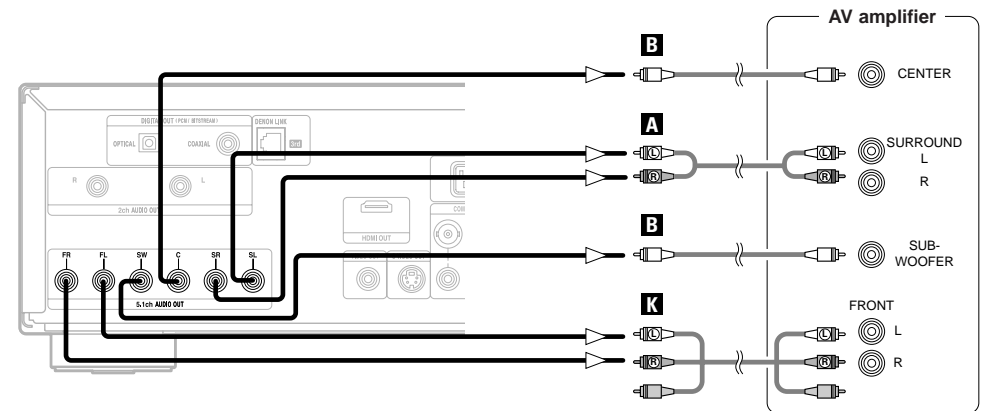

Connections

DENON LINK connections

When connected to a DENON LINK-compatible AV amplifier, the multi-channel signals of DVD-Audio discs, Super Audio CDs, etc., can be transferred as such in digital format.

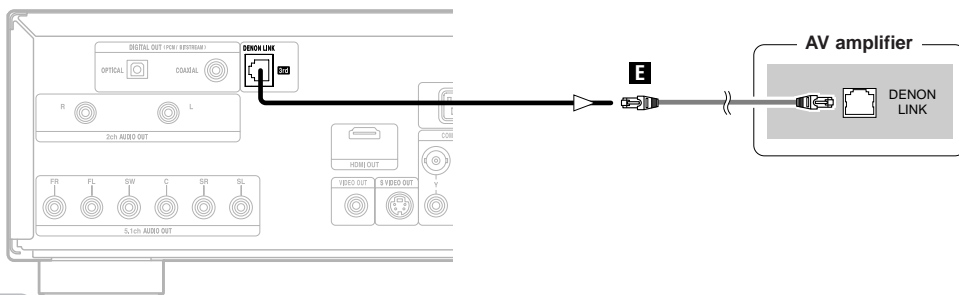

- Digital transfer is possible up to 24 bit/2ch for 192/176.4 kHz, 24 bit/6ch for 96 kHz or less.
- When making DENON LINK connections, be sure to check the version of the AV amplifier to be connected then make the "DENON LINK" setting at "initial settings" appropriately (page 19). If two DENON LINK terminals of different versions are interconnected, there may be no sound or only noise.
- When "DENON LINK" is set, downmixed audio signals are output from the DVD-3930's analog audio output terminals (L/R, FL/FR and AV-1). When using the 5.1-channel analog audio terminals, set the "DENON LINK" setting in the initial settings to "OFF".
- The DVD-3930's speaker settings are invalidated when the DENON LINK terminal is connected. (Make the speaker settings on the AV amplifier to which the DVD-3930 is connected.)
- With the DENON LINK 2nd connection, Super Audio CD's multi and stereo signals are not output from the DENON LINK terminal. Please use the analog audio output terminals.

Connection to a device with an HDMI terminal

Connecting the DVD-3930 to device with an HDMI terminal using an HDMI cable (sold separately) enables digital transfer of both digital video signals and multi-channel audio signals.

For a TV, amplifier, etc.

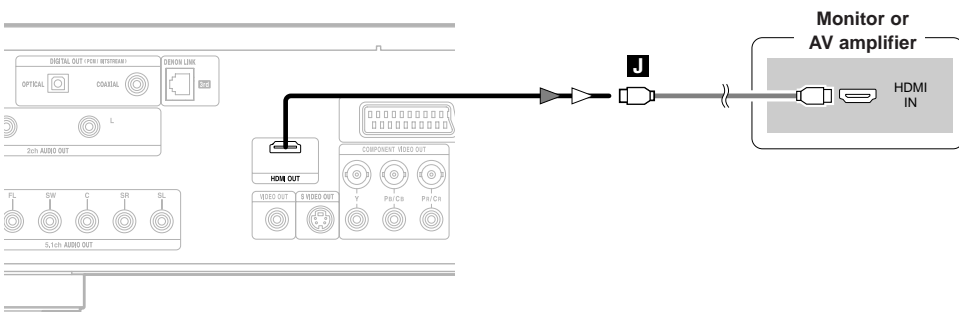

Connections

Audio setting of device to be connected with an HDMI terminal (page 17)

Device to be connected	HDMI audio setting	
Device compatible with 2-channel audio input or device not compatible with audio input	2CH	The multi-channel audio signals are output from the analog audio output and DENON LINK terminal. Down-mixed 2-channel audio signals are output from the HDMI output terminal.
Device compatible with DTS or Dolby Digital decoding	MULTI (NORMAL)	The DTS or Dolby Digital signals can be decoded by the connected TV or AV amplifier. (The HDMI audio speaker setting, etc., cannot be made.)
Device compatible with 3 or more channels of audio inputs (not DTS or Dolby Digital compatible)	MULTI (LPCM)	Multi-channel audio signals are output from the HDMI terminal. The HDMI audio speaker setting, etc., can be made.

Disc type	Audio recording format	HDMI audio		
		2CH	MULTI (NORMAL)	MULTI (LPCM)
DVD-Video	Dolby Digital	2-channel PCM	Dolby Digital	Multi PCM
	DTS	2-channel PCM	DTS	Multi PCM
	PCM	2-channel PCM	Multi PCM	Multi PCM
	MPEG Audio	2-channel PCM	Multi PCM	Multi PCM
DVD-Audio	LPCM or PPCM	2-channel PCM	Multi PCM	Multi PCM
Video CD		2-channel PCM	2-channel PCM	2-channel PCM
Music CD		2-channel PCM	2-channel PCM	2-channel PCM
MP3 CD		2-channel PCM	2-channel PCM	2-channel PCM
WMA CD		2-channel PCM	2-channel PCM	2-channel PCM
Super audio CD	Multi area	No output	No output	No output
	Stereo area	No output	No output	No output
	CD layer	2-channel PCM	2-channel PCM	2-channel PCM

Connection with an HDMI/DVI-D conversion cable (adapter)

- HDMI video streams (video signals) are compatible with DVI-D. The DVD-3930 can be connected to a TV with a DVI-D terminal using an HDMI/DVI-D conversion cable (adapter), but depending on the combination of devices in some cases no picture will be output.
- When using an HDMI/DVI-D conversion adapter, the picture may not be output properly due to poor contact with the connected cable.

Status of signal from the DVD-3930's HDMI output terminal	HDMI-compatible monitor	DVI-D-compatible monitor (HDCP compatible)	DVI-D-compatible monitor (Not HDCP compatible)
	Both video and audio signals output	Both video and audio signals output	Only video signals output *

* The video signals are only output in RGB format.

Connections

NOTE:

- The audio signals of the multi and stereo areas of Super Audio CDs are not HDMI output.
- DVD-Audio discs that are copyright protected by CPPM can only be played on devices that are mutually compatible with HDMI Ver. 1.1. (The DVD-3930 is compatible with HDMI Ver. 1.1.)
- Some HDMI compatible devices can be used to control other devices via the HDMI terminal, but the DVD-3930 cannot be controlled via the HDMI terminal by other devices.
- The audio signals from the HDMI terminal (sampling frequency, bit length, etc.) may be restricted by the connected device.
- Set the DVD-3930's resolution according to the resolutions with which the connected TV or monitor are compatible.
- Use a cable including the HDMI logo (HDMI certified product) for connection of the HDMI terminal. Normal playback may not be possible if a cable that does not include the HDMI logo (non-HDMI-certified product) is used.

Copyright protection system

In order to play the digital video and audio signals of DVD-Video and DVD-Audio discs using HDMI connections, both the player and the TV, AV amplifier, etc., must be compatible with a copyright protection system called "HDCP" (High-bandwidth Digital Content Protection system). HDCP is a copyright protection technology consisting of data encrypting and authentication of the connected device. The DVD-3930 is HDCP compatible.

When a device that is not compatible with HDCP is connected, video signals will not be output normally. For information on your TV, AV amplifier, etc., refer to its operating instructions.

Connections

Digital connection to a recording device (MD recorder, etc.)

At "AUDIO SETUP", set "DIGITAL OUTPUT" to "PCM" (page 23), "DOWN SAMPLING" to "ON" (page 23).
 Playing a DVD without first making the correct settings could result in noise that is unpleasant on the ears and could damage the speakers.

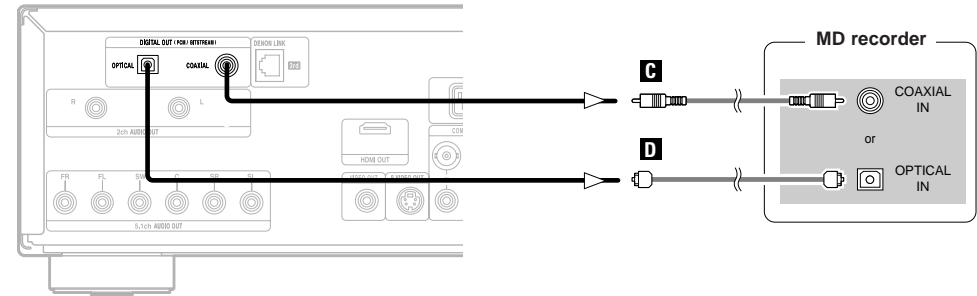

Connecting the power supply cord

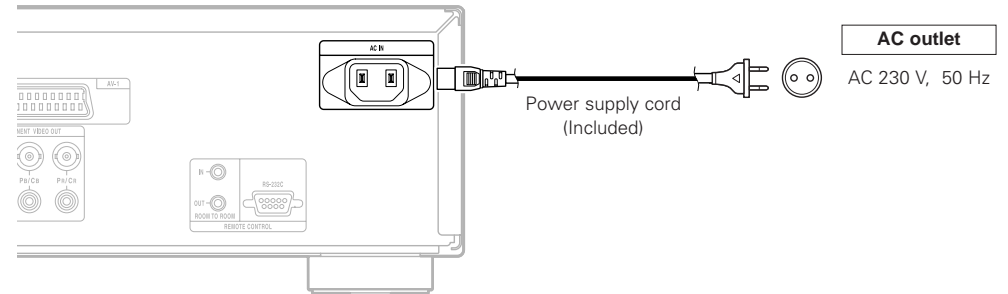

NOTE:

- Insert the plugs securely. Incomplete connections will result in the generation of noise.

Making the initial settings

Table of initial settings

Language setting

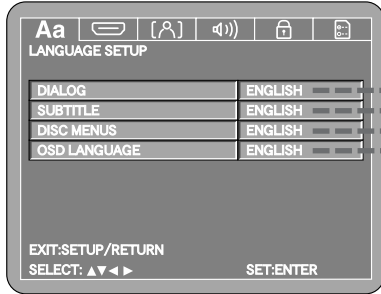

Description		Item you want to set (* indicates the setting upon purchase)						Page	
DIALOG	Set the audio language to be output.	ENGLISH*	FRENCH	SPANISH	GERMAN	ITALIAN	OTHERS	16	
SUB TITLE	Sets the language of the subtitles displayed on the TV screen.	OFF	ENGLISH*	FRENCH	SPANISH	GERMAN	ITALIAN	OTHERS	16
DISC MENUS	Sets the language of the menus (top menu, etc.), recorded on the disc.	ENGLISH*	FRENCH	SPANISH	GERMAN	ITALIAN	OTHERS	16	
OSD LANGUAGE	Sets the language of the initial settings screen and the messages displayed on the TV screen ("PLAY", etc.).	ENGLISH*	FRANÇAIS		ESPAÑOL		DEUTSCH	16	

Digital interface settings

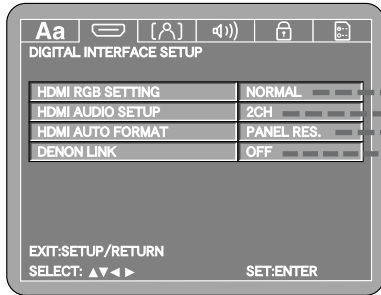

Description		Item you want to set (* indicates the setting upon purchase)						Page
HDMI RGB SETTING	Use this procedure to set the digital RGB image range (data range) output from the HDMI terminal.	NORMAL*			ENHANCED			17
HDMI AUDIO SETUP (Can only be set when "MULTI (LPCM)" is selected)	Use this procedure to set the audio signals output from the HDMI terminal.	2CH*		MULTI (NORMAL)		MULTI (LPCM)		17
		SPEAKER CONFIGURATION The properties and components of the different channels are set automatically for the combination of speakers being used.	FRONT SP	CENTER SP	SUBWOOFER	SURROUND SP	CROSSOVER	
	CHANNEL LEVEL Set the volume of the different speakers so that the test tones output from them sound to have the same volume.	LARGE* / SMALL	LARGE* / SMALL / (NONE)	YES* / (NO)	LARGE* / SMALL / (NONE)	40 / 60 / 80* / 100 / 120Hz		
		DELAY TIME This is a parameter for optimizing the timing at which the sound is output from the speakers and subwoofer according to their distance from the listening position.	TEST TONE	FRONT LCH	CENTER	FRONT RCH	SURROUND RCH	SURROUND LCH
		OFF / AUTO / MANUAL	0 ~ -10dB (0dB*)					
HDMI AUTO FORMAT	Use this procedure to make the settings for the "AUTO" function selected with the HDMI FORMAT button on the remote control unit.	PANEL RES.*			MAX RES.			19
DENON LINK	Set the DENON LINK terminal's output according to the DENON LINK version of the connected AV amplifier.	OFF*		2nd		3rd		19

Video setting

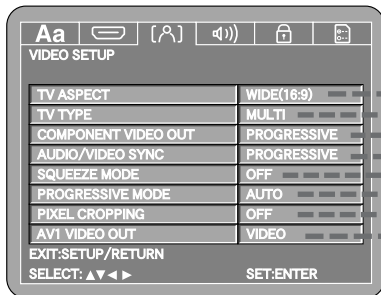

Description		Item you want to set (* indicates the setting upon purchase)						Page	
TV ASPECT	Set this according to the screen of the connected TV.	4:3 PS		4:3 LB		WIDE (16:9)*		20	
TV TYPE	Set this according to the video format of the connected TV.	NTSC			PAL			MULTI*	20
COMPONENT VIDEO OUT	Use this procedure to set the DVD-3930's component video output format.	PROGRESSIVE*			INTERLACED			20	
AUDIO / VIDEO SYNC	Set the video output to synchronize the audio signal.	PROGRESSIVE*	INTERLACED		HDMI		OTHERS	21	
SQUEEZE MODE	Use this procedure to set the output picture when "WIDE (16:9)" is selected at "TV ASPECT".	OFF*		ON		AUTO		21	
PROGRESSIVE MODE	Sets the optimum progressive mode for the image material.	AUTO*		VIDEO1		VIDEO2		21	
PIXEL CROPPING	Set the horizontal display range with respect to the interlaced output.	OFF*			ON			22	
AV1 VIDEO OUT	To select whether composite video signals or S-Video signals or RGB signals will be output from the AV-1 terminal.	VIDEO*		S-VIDEO		RGB		22	

Making the initial settings

Audio settings

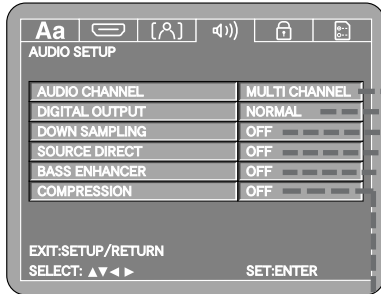

Description		Item you want to set (* indicates the setting upon purchase)				Page			
AUDIO CHANNEL	Set the audio output.	MULTI CHANNEL*	2CH (VSS OFF)	2CH (VSS1 ON)	2CH (VSS2 ON)	22			
	SPEAKER CONFIGURATION	The properties and components of the different channels are set automatically for the combination of speakers being used.	FRONT SP	CENTER SP	SUBWOOFER	SURROUND SP	CROSSOVER		
			LARGE* / SMALL	LARGE* / SMALL / NONE	YES* / NO	LARGE* / SMALL / NONE	40 / 60 / 80* / 100 / 120Hz		
	CHANNEL LEVEL	Set the volume of the different speakers so that the volume of the test tones output from them sounds the same.	TEST TONE	FRONT LCH	CENTER	FRONT RCH	SURROUND RCH	SURROUND LCH	SUBWOOFER
		OFF / AUTO / MANUAL	0 ~ -10dB (0dB*)						OFF* / ON
DELAY TIME	This is a parameter for optimizing the timing at which the sound is output from the speakers and subwoofer according to their distance from the listening position.	DISTANCE	FRONT LCH	FRONT RCH	CENTER	SURROUND LCH	SURROUND RCH	SUBWOOFER	DEFAULT
		METERS* / FEET	0 ~ 18m (3.6m*) (0 ~ 60ft (12ft*))		0 ~ 18m (3.0m*) (0 ~ 60ft (10ft*))		0 ~ 18m (3.6m*) (0 ~ 60ft (12ft*))		ON
DIGITAL OUTPUT	Use this procedure to set the signal format of the digital audio output.	NORMAL*			PCM				23
DOWN SAMPLING	Use this procedure to set the digital audio output when playing DVDs recorded in linear PCM or packed PCM.	OFF*			ON				23
SOURCE DIRECT	Use this procedure to making the setting for direct audio output of the disc's data without making the "SPEAKER SETUP" settings at "AUDIO CHANNEL".	OFF*		50kHz		100kHz			23, 24
BASS ENHANCER	Sets the subwoofer output for when playing 2-channel or other sources without LFE signals.	OFF*			ON				24
COMPRESSION	Use this procedure to set the dynamic range of the output signals when playing DVDs recorded in Dolby Digital.	OFF*			ON				24

Making the initial settings

Viewing restriction setting

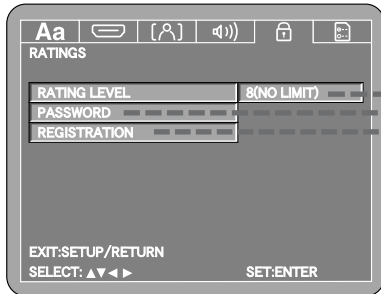

Description		Item you want to set (* indicates the setting upon purchase)								Page	
RATING LEVEL	A password can be set to restrict (prohibit) the playing of adult DVDs so that children or others cannot view them.	0 (LOCK ALL)	1	2	3	4	5	6	7	8 (NO LIMIT)*	25
PASSWORD	Use this procedure to change the password for the "RATING LEVEL".	CHANGE									25
REGISTRATION	Use this procedure to display the registration code for leasing or purchasing DivX® VOD format video files using the DivX® VOD (Video On Demand) service.	SHOW CODE									26

Special settings

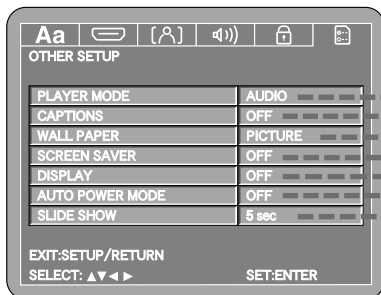

Description		Item you want to set (* indicates the setting upon purchase)				Page
PLAYER MODE	Set the playback mode for playing the DVD-Video contents recorded on DVD-Audio discs.	AUDIO*		VIDEO		26
CAPTIONS	Use this procedure to set the output of the closed caption signals to display captions using a caption decoder (commercially available).	OFF*		ON		26
WALL PAPER	Use this procedure to set the picture to be displayed on the TV screen when in the stop mode or when playing CDs.	PICTURE*	BLACK	GRAY	BLUE	26
SCREEN SAVER	The screensaver functions protects the TV screen from imprinting.	OFF*		ON		27
DISPLAY	If the display is turned off with the pure direct or dimmer function, a description of operations can be displayed for about 2 seconds.	OFF*		ON		27
AUTO POWER MODE	This function automatically sets the player's power to the standby mode if the player is left in the stop mode for about 30 minutes.	OFF*		ON		27
SLIDE SHOW	Use this procedure to set the time after which the still picture (in JPEG format) switches when playing still pictures.	5 ~ 15 sec (5 sec*)				27

Making the initial settings

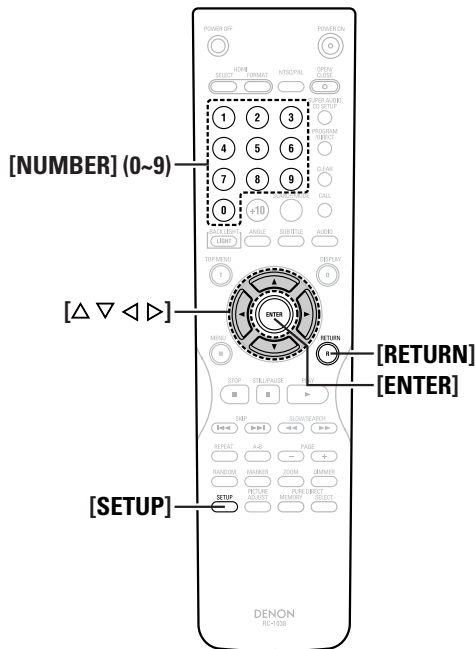
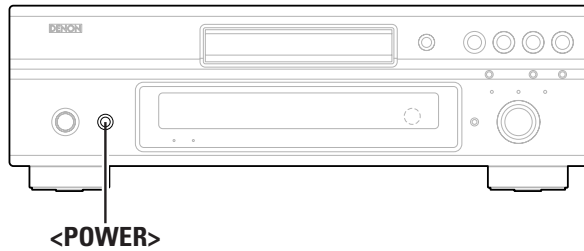

About the button names in this explanation
 < > : Buttons on the main unit
 [] : Buttons on the remote control unit
Button name only :
 Buttons on the main unit and remote control unit

Operations for making the initial settings

Before starting playback, make the initial settings according to your usage conditions.

- 1** Check that all the connections are proper.
- 2** Turn on the TV's power and switch its video input so that the DVD-3930's image can be seen.
- 3** Press <POWER>.
 - ON: The power indicator lights green.
 - OFF: The power indicator turns off.
- 4** Press [SETUP].
 - The initial settings screen is displayed.
- 5** Use [◀ ▶] to select the item to be set.
- 6** Use [Δ ∇] to select the item you want to change, then press [ENTER].
- 7** Use [Δ ∇] again to select the item to be set, then press [ENTER].
- 8** Once the settings are completed, press [SETUP].



- The initial settings are stored in the memory and remain in effect until they are changed, even if the power is turned off.
- Some of the items can be changed while a disc is playing.

Making the initial settings

- 4**

LANGUAGE SETUP	
DIALOG	ENGLISH
SUBTITLE	ENGLISH
DISC MENUS	ENGLISH
OSD LANGUAGE	ENGLISH
EXIT:SETUP/RETURN SELECT: ▲▼◀▶	
- 5**

VIDEO SETUP	
TV ASPECT	WIDE(16:9)
TV TYPE	MULTI
COMPONENT VIDEO OUT	PROGRESSIVE
AUDIO/VIDEO SYNC	PROGRESSIVE
SQUEEZE MODE	OFF
	AUTO
	OFF
	VIDEO
SET:ENTER	

Icon
- Item you want to change
- 6**

VIDEO SETUP	
TV ASPECT	
TV TYPE	NTSC
COMPONENT VIDEO OUT	PAL
AUDIO/VIDEO SYNC	MULTI
SQUEEZE MODE	
PROGRESSIVE MODE	
PIXEL CROPPING	
AV1 VIDEO OUT	
EXIT:SETUP/RETURN SELECT: ▲▼◀▶	
- 7**

VIDEO SETUP	
TV ASPECT	
TV TYPE	NTSC
COMPONENT VIDEO OUT	PAL
AUDIO/VIDEO SYNC	MULTI
SQUEEZE MODE	
PROGRESSIVE MODE	
PIXEL CROPPING	
AV1 VIDEO OUT	
EXIT:SETUP/RETURN SELECT: ▲▼◀▶	

Item to be set

Making the initial settings

Language setting ([Aa])

Use [◀ ▶] to select “ Aa ”.

1 Use [△ ▽] to select the item to be set, then press [ENTER].

DIALOG:

Set the audio language to be output.

SUBTITLE:

Sets the language of the subtitles displayed on the TV screen.

DISC MENUS:

Sets the language of the menus (top menu, etc.), recorded on the disc.

OSD LANGUAGE:

Sets the language of the initial settings screen and the messages displayed on the TV screen (“PLAY”, etc.).

2 Use [△ ▽] to select the language to be set, then press [ENTER].

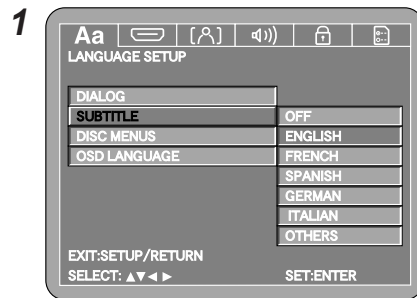

(Select “ENGLISH” under “SUBTITLE”)



- If “OTHERS” is selected, refer to the “Language code list”, and use [NUMBER] (0 ~ 9) to input the code number.
- If you do not want to display the subtitles, select “OFF” at “SUBTITLE”. For some discs it is not possible to turn off the subtitles.

Making the initial settings

Language code list

Code	Language	Code	Language	Code	Language	Code	Language
4747	Afar	5271	Frisian	5868	Latvian; Lettish	6558	Slovenian
4748	Abkhazian	5347	Irish	5953	Malagasy	6559	Samoan
4752	Afrikaans	5350	Gaelic (Scotland)	5955	Maori	6560	Shona
4759	Ameharic	5358	Galician	5957	Macedonish	6561	Somali
4764	Arabic	5360	Guarani	5958	Malayalam	6563	Albanian
4765	Assamese	5367	Gujarati	5960	Mongolian	6564	Serbian
4771	Aymara	5447	Hausa	5961	Moldavian	6565	Siswati
4772	Azerbaijani	5455	Hindi	5964	Marathi	6566	Sesotho
4847	Bashkir	5464	Croatian	5965	Malay	6567	Sundanese
4851	Byelorussian	5467	Hungarian	5966	Maltese	6568	Swedish
4853	Bulgarian	5471	Armenian	5971	Burmese	6569	Swahili
4854	Bihari	5547	International language	6047	Nauru	6647	Tamil
4855	Bislama	5551	International language	6051	Nepali	6651	Telugu
4860	Bengali; Bangla	5557	Inupik	6058	Dutch	6653	Tajik
4861	Tibetan	5560	Indonesian	6061	Norwegian	6654	Thai
4864	Breton	5565	Icelandic	6149	Provençal	6655	Tigrinya
4947	Catalan	5566	Italian	6159	Oromo	6657	Turkmen
4961	Corsican	5569	Hebrew	6164	Oriya	6658	Tagalog
4965	Czech	5647	Japanese	6247	Panjabi	6660	Setswana
4971	Welsh	5655	Yiddish	6258	Polish	6661	Tonga
5047	Danish	5669	Javanese	6265	Pashto; Pushto	6664	Turkish
5051	German	5747	Georgian	6266	Portuguese	6665	Tsonga
5072	Bhutani	5757	Kazakh	6367	Quechua	6666	Tatar
5158	Greek	5758	Greenlandic	6459	Rhaeto-Romance	6669	Twi
5160	English	5759	Cambodian	6460	Kirundi	6757	Ukrainian
5161	Esperanto	5760	Kannada	6461	Romanian	6764	Urdu
5165	Spanish	5761	Korean	6467	Russian	6772	Uzbek
5166	Estonian	5765	Kashmiri	6469	Kinya-rwanda	6855	Vietnamese
5167	Basque	5767	Kurdish	6547	Sanskrit	6861	Volapük
5247	Persian	5771	Kirghiz	6550	Sindhi	6961	Wolof
5255	Finnish	5847	Latin	6553	Sango	7054	Xhosa
5256	Fiji	5860	Lingala	6554	Serbo-Croatian	7161	Yoruba
5261	Faroese	5861	Laothian	6555	Singhalese	7254	Chinese
5264	French	5866	Lithuanian	6557	Slovak	7267	Zulu

Making the initial settings

Digital interface settings ()

Use [◀ ▶] to select “  ”.

Setting the HDMI RGB picture quality settings

Use this procedure to set the digital RGB image range (data range) output from the HDMI terminal.

1 Use [△ ▽] to select “HDMI RGB SETTING”, then press [ENTER].

2 Use [△ ▽] to select the item to be set, then press [ENTER].

NORMAL (Upon purchase):

Output as “16 (black)” to “235 (white)”.

ENHANCED:

Output as “0 (black)” to “246 (white)”.

※ Depending on the TV you are using, the black colors may seem to stand out when using HDMI connections. If so, set to “ENHANCED”.

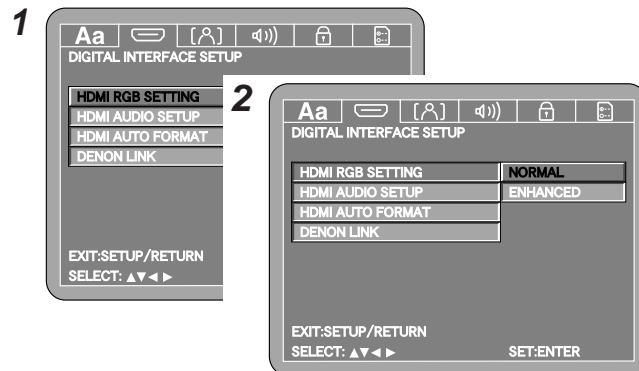

• No effect when the HDMI terminal's video setting is set to “YCbCr” ( page 29).

Setting the HDMI audio

Use this procedure to set the audio signals output from the HDMI terminal.

1 Use [△ ▽] to select “HDMI AUDIO SETUP”, then press [ENTER].

2 Use [△ ▽] to select the item to be set, then press [ENTER].

2CH (Upon purchase):

2-channel linear PCM audio signals are output.

MULTI (NORMAL):

Multi- (5.1-) channel audio signals are output.

- ※ Output signal
 - Dolby Digital/DTS discs: Bitstream signals are output
 - Linear PCM / Packed PCM discs: Linear PCM signals are output

MULTI (LPCM):

Multi- (5.1-) channel audio signals are output.

It is also possible to make the “SPEAKER CONFIGURATION”, “CHANNEL LEVEL” and “DELAY TIME” settings ( page 17~19).

- ※ Output signal
 - Dolby Digital/DTS discs: Decoded Linear PCM signals output
 - Linear PCM / Packed PCM discs: Linear PCM signals are output

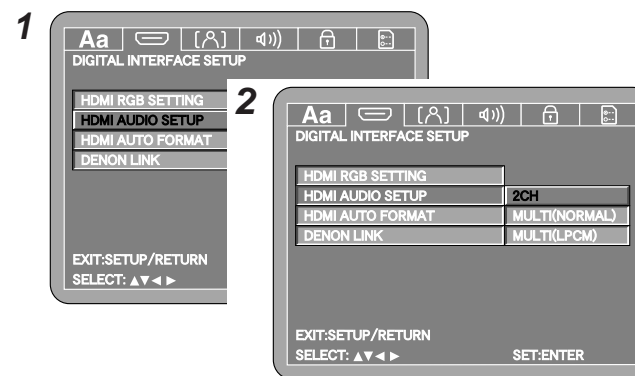

Making the initial settings

Setting the HDMI speaker settings

At “HDMI AUDIO SETUP”, select “MULTI (LPCM)”. The “HDMI SPEAKER SETUP” screen appears. Make the “SPEAKER CONFIGURATION”, “CHANNEL LEVEL” and “DELAY TIME” settings.

 Speaker settings

The properties and components of the different channels are set automatically for the combination of speakers being used.

1 Use [△ ▽] to select “MULTI (LPCM)”, then press [ENTER].

2 Use [△ ▽] to select “SPEAKER CONFIGURATION”, then press [ENTER].

3 Use [△ ▽] to select the speaker, then press [ENTER].

4 Use [△ ▽] to select the speaker type, then press [ENTER].

LARGE (Upon purchase), SMALL:

Select “LARGE” if you have connected large speakers with strong low frequency reproduction capabilities, “SMALL” if you have connected small speakers that do not provide strong bass sound.

HDMI SPEAKER SETUP:

It is not possible to select “NO” for the HDMI speaker setting.

CROSSOVER:

For speakers set to “SMALL”, the sound with frequencies below that of the crossover frequency are cut. This bass sound that has been cut is output from the subwoofer or a speaker for which “LARGE” is set.

• **40, 60, 80 (Upon purchase), 100, 120Hz:**

Select according to the low frequency reproduction capabilities of the connected speaker.

Making the initial settings

1

2

3

4

EXIT:SETUP/RETURN SELECT: ▲▼◀▶

SET:ENTER

* The display differs depending on the connected speaker.



- To return to the setting screen: Press [RETURN].

Channel level

Set the volume of the different speakers so that the test tones output from them sound to have the same volume.

1 At the HDMI speaker setting screen, use [△ ▽] to select “CHANNEL LEVEL”, then press [ENTER].

2 Use [△ ▽] to select “TEST TONE”, use [◀ ▶] again to make the settings, then press [ENTER].

OFF:

No test tones are output.

AUTO:

Adjust the volumes while listening to the test tones output automatically from the different speakers.

MANUAL:

Switch the speaker from which the test tone is output manually as you adjust the volumes.

3 If “AUTO” is selected:

-1 Use [◀ ▶] to adjust the volume.

- The volume can be adjusted between the range of 0 to -10 dB.
- The test tones are output automatically in the order shown below.

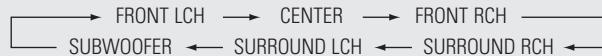

3 If “MANUAL” is selected:

-2 Use [△ ▽] to select the speaker, use [◀ ▶] to adjust the volume, then press [ENTER].

Making the initial settings

1

2

3

-1

3

-2

EXIT:SETUP/RETURN SELECT: ▲▼◀▶

SET:ENTER



- To return to the setting screen: Press [RETURN].

Making the initial settings

Delay time

This is a parameter for optimizing the timing at which the sound is output from the speakers and subwoofer according to their distance from the listening position.

1 At the HDMI speaker setting screen, use [Δ ∇] to select “DELAY TIME”, then press [ENTER].

2 Use [Δ ∇] to select “DISTANCE”, use [\leftarrow \rightarrow] to set “METERS” or “FEET”.

3 Use [Δ ∇] to select the speaker, then use [\leftarrow \rightarrow] to set the distance.

- The distance can be set within the range of 0 to 18 meters (60 feet).
The maximum difference in speaker distance for which adjustment is possible is 4.5 meters (15 feet).

※ If you select “DEFAULT” and press [ENTER], the delay time settings are restored to the values set when you purchased the player.

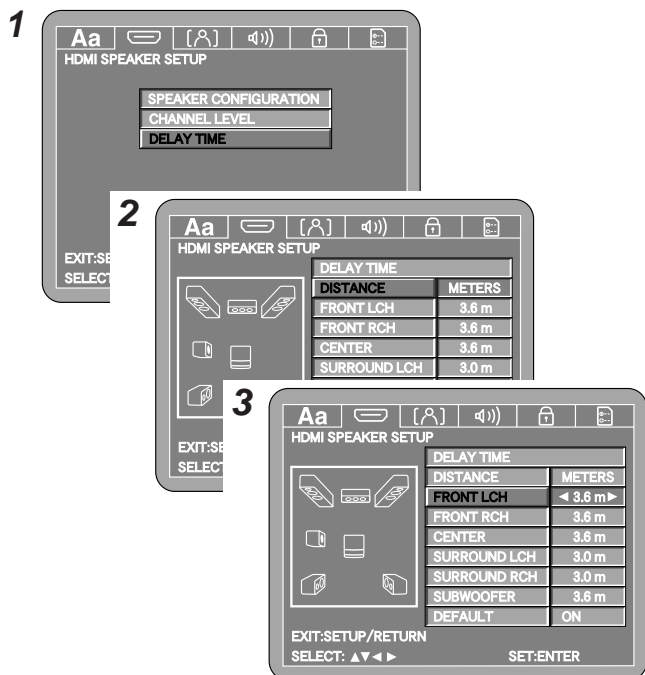

- To return to the setting screen:
Press [RETURN].

Setting the HDMI auto format

Use this procedure to make the settings for the “AUTO” function selected with [HDMI FORMAT] (page 29).

1 Use [Δ ∇] to select “HDMI AUTO FORMAT”, then press [ENTER].

2 Use [Δ ∇] to select the item to be set, then press [ENTER].

PANEL RES. (Upon purchase):

The number of pixels of the connected HDMI device’s panel is detected and the HDMI output resolution is selected automatically.

MAX RES.:

The maximum resolution that can be input to the connected HDMI device is detected and the HDMI output resolution is selected automatically.

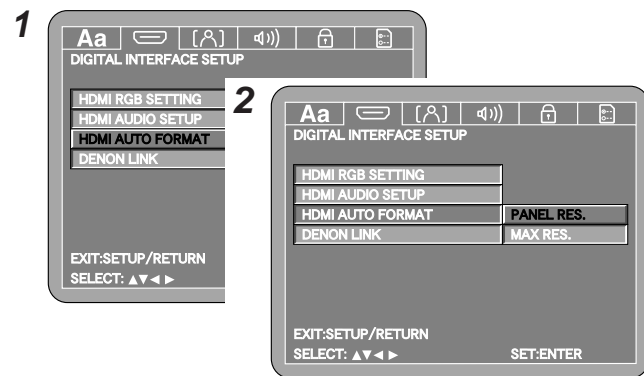

Making the initial settings

Setting the DENON LINK

Set the DENON LINK terminal’s output according to the DENON LINK version of the connected AV amplifier.

1 Use [Δ ∇] to select “DENON LINK”, then press [ENTER].

2 Use [Δ ∇] to select the item to be set, then press [ENTER].

OFF (Upon purchase):

No digital audio signals are output from the DENON LINK terminal. Select this when not connecting the DENON LINK terminal.

2nd:

The signals are output in DENON LINK 2nd Edition format. The following digital audio signals can be transferred: DVD-Audio, DVD-Video, music CD and video CD signals

3rd:

The signals are output in DENON LINK 3rd Edition format. The following digital audio signals can be transferred: Super Audio CD, DVD-Audio, DVD-Video, music CD and video CD signals

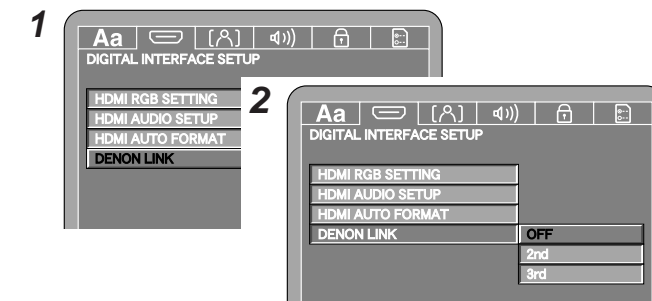

- The DENON LINK setting with respect to the DENON LINK version of the connected AV amplifier is as shown below.

AV amplifier’s DENON LINK version	DENON LINK setting
2nd Edition (“S.E.” is indicated near the terminal)	“2nd”
3rd Edition (“3rd” is indicated near the terminal)	“3rd” (or 2nd)

Making the initial settings

Video setting ([F8])

Use [◀ ▶] to select “[F8]”.

Setting the TV aspect ratio

Set this according to the screen of the connected TV.

1 Use [△ ▽] to select “TV ASPECT”, then press [ENTER].

2 Use [△ ▽] to select the item to be set, then press [ENTER].

4:3 PS:

Select this if the screen’s vertical:horizontal ratio is 4:3. Software recorded in wide screen format is played in the pan & scan mode (with the left and right sides of the screen cut. Software for which pan & scan is not specified, however, is played in the letter box mode (with black bands at the top and bottom of the screen).

4:3 LB:

Select this if the screen’s vertical:horizontal ratio is 4:3. Software recorded in wide screen format is played in the letter box mode.

WIDE (16:9) (Upon purchase):

Select this when a wide-screen TV is connected. Software recorded in wide screen format is played over the entire screen.

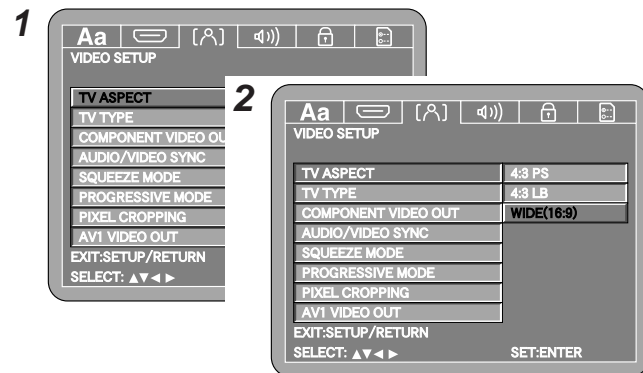

Setting the TV type

Set this according to the video format of the connected TV.

1 Use [△ ▽] to select “TV TYPE”, then press [ENTER].

2 Use [△ ▽] to select the item to be set, then press [ENTER].

NTSC:

Select this if the connected TV is of the NTSC type.

PAL:

Select this if the connected TV is of the PAL type.

MULTI (Upon purchase):

Select this if the connected TV is of both the NTSC and PAL types.

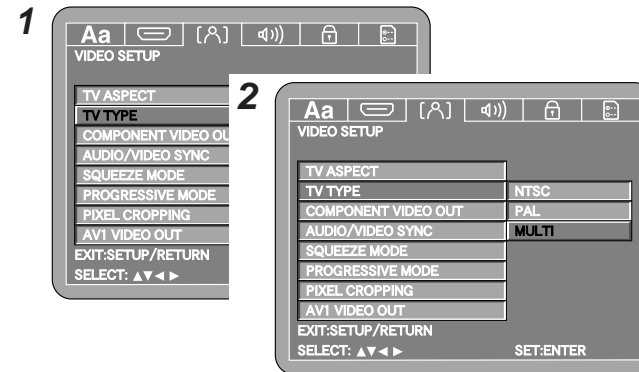

• The picture will not be displayed properly if a video format different from the connected TV’s type is set.

Making the initial settings

Setting the component video output

Use this procedure to set the DVD-3930’s component video output format.

1 Use [△ ▽] to select “COMPONENT VIDEO OUT”, then press [ENTER].

2 Use [△ ▽] to select the item to be set, then press [ENTER].

PROGRESSIVE (Upon purchase):

Sets to the progressive format. In this format there is less flickering than with the interlaced format.

INTERLACED:

Sets to the interlaced format.

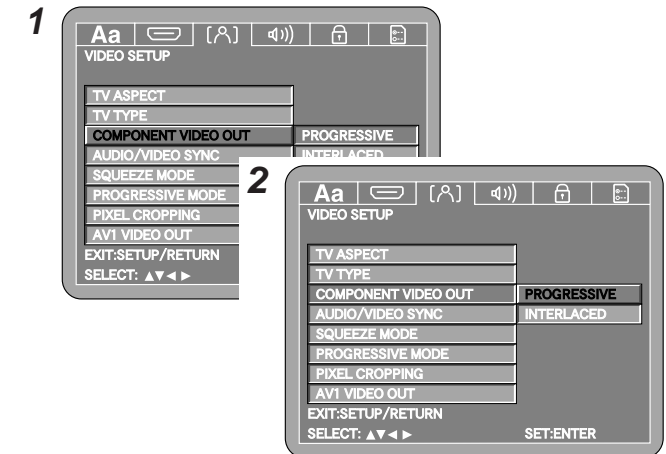

• When outputting video signals from the HDMI terminal, the video signals output from the component video terminals are interlaced.

Making the initial settings

Setting the AV Synchronized

Set the video output to synchronize the audio signal.

1 Use [△ ▽] to select “AUDIO/VIDEO SYNC”, then press [ENTER].

2 Use [△ ▽] to select the item to be set, then press [ENTER].

PROGRESSIVE (Upon purchase):

Synchronizes the sound with the progressive mode.

INTERLACED:

Synchronizes the sound with the interlaced mode.

HDMI:

Synchronizes the sound with the HDMI mode.

OTHERS:

Select this when you want to view progressive, interlaced and HDMI pictures simultaneously.

The audio signals are set to the optimum timing for the respective pictures. (They are not synchronized.)

※ To synchronize the audio signals, set to something other than “OTHERS”.

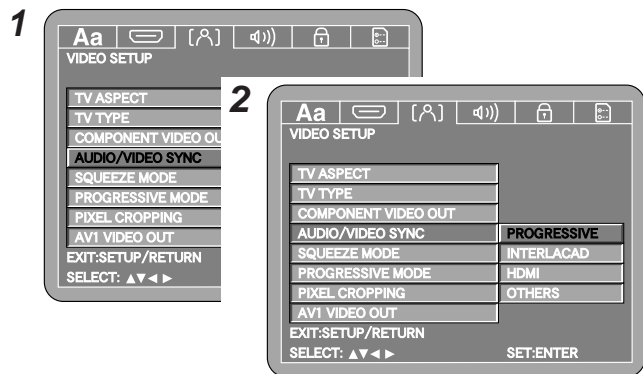

Setting the squeeze mode

Use this procedure to set the output picture when “WIDE (16:9)” is selected at “TV ASPECT” (page 20).

1 Use [△ ▽] to select “SQUEEZE MODE”, then press [ENTER].

2 Use [△ ▽] to select the item to be set, then press [ENTER].

OFF (Upon purchase):

The picture is displayed over the entire 16:9 TV screen, regardless of the original image size.

ON:

The picture is displayed in the center of the 16:9 TV screen with a 4:3 aspect ratio, regardless of the original image size.

AUTO:

When playing 4:3 images, the picture is displayed in the center of the 16:9 TV screen with a 4:3 aspect ratio.

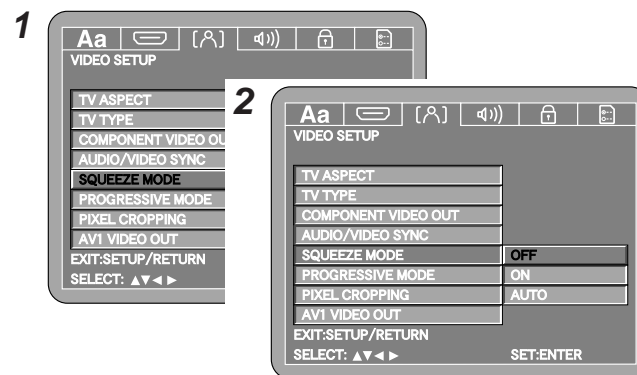

• No effect for interlaced video outputs.

Making the initial settings

Setting the progressive mode

Sets the optimum progressive mode for the image material.

1 Use [△ ▽] to select “PROGRESSIVE MODE”, then press [ENTER].

2 Use [△ ▽] to select the item to be set, then press [ENTER].

AUTO (Upon purchase):

The material type (film or video) is automatically identified from the disc and the mode is selected automatically.

VIDEO1:

This mode is suited for playing video material discs.

VIDEO2:

This mode is suited for playing video material discs and 30-frame film material discs.

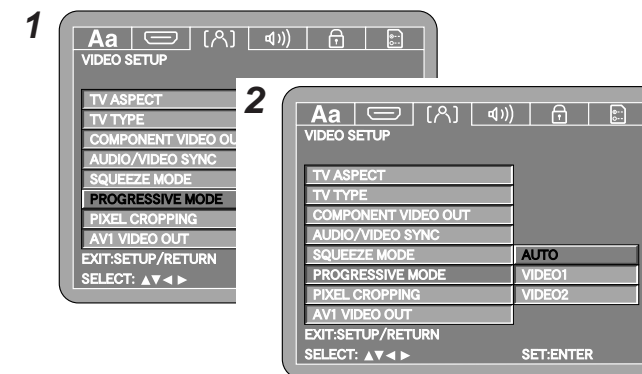

Making the initial settings

Setting the horizontal display range

Set the horizontal display range with respect to the interlaced output.

1 Use [Δ ▽] to select “PIXEL CROPPING”, then press [ENTER].

2 Use [Δ ▽] to select the item to be set, then press [ENTER].

OFF (Upon purchase):

Select this when a regular consumer TV is connected.

ON:

When a professional monitor is connected, select this if the image’s synchronization is disturbed.

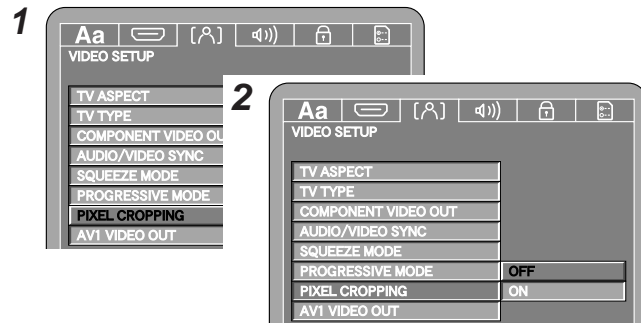

Setting the AV1 video out

To select whether composite video signals or S-Video signals or RGB signals will be output from the AV-1 terminal.

1 Use [Δ ▽] to select “AV1 VIDEO OUT”, then press [ENTER].

2 Use [Δ ▽] to select the item to be set, then press [ENTER].

VIDEO (Upon purchase):

Composite video signals will be output from the AV-1 terminal.

S-VIDEO:

S-Video signals will be output from the AV-1 terminal.

RGB:

RGB signals will be output from the AV-1 terminal.

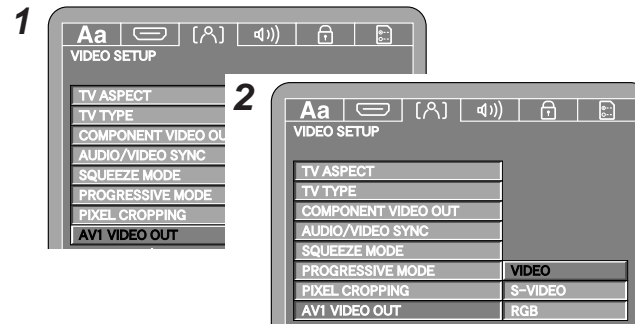

Audio settings ([Speaker Icon])

Use [◀ ▶] to select “ [Speaker Icon] ”.

Setting the audio channels

Set the audio output.

1 Use [Δ ▽] to select “AUDIO CHANNEL”, then press [ENTER].

2 Use [Δ ▽] to select the item to be set, then press [ENTER].

MULTI CHANNEL (Upon purchase):

Select this when using 3 or more speakers. The “SPEAKER CONFIGURATION”, “CHANNEL LEVEL” and “DELAY TIME” setting screens appear.

Making the initial settings

2CH (VSS OFF):

Select this when using 2 speakers and a Dolby Pro Logic decoder (Dolby Pro Logic compatible amplifier).

2CH (VSS1 ON):

This setting provides a natural surround effect in a system with 2 speakers connected.

2CH (VSS2 ON):

This settings provides a stronger surround effect in a system with 2 speakers connected than VSS1.

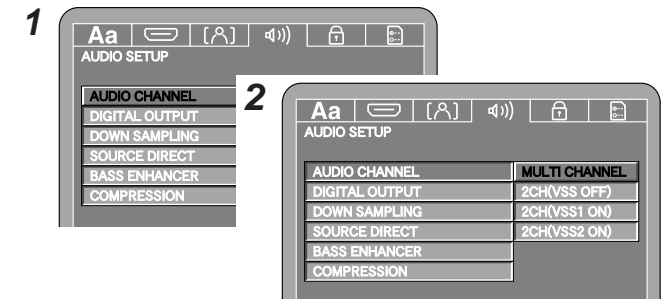

- The procedure for making the “SPEAKER CONFIGURATION”, “CHANNEL LEVEL” and “DELAY TIME” settings is the same as when “MULTI (LPCM)” is selected at “HDMI AUDIO SETUP” (page 17).
- When “ON” is selected for “SW+10dB” at “CHANNEL LEVEL”, the volume of the sound output from the subwoofer can be set 10 dB higher.

About V.S.S. (Virtual Surround Sound)

- Using the V.S.S. function lets you enjoy a surround effect with only two speakers (left and right).
- This function is only effective for DVDs recorded in Dolby Digital, DTS, MPEG, LPCM with 2 or more channels.
- For some discs the effect may be weak or there may be no effect at all.
- For some discs the sound may be distorted when using this function. If so, set the V.S.S. function to “OFF”.
- Cancel other surround functions (for example, the TV’s surround mode) when using this function.
- The effect is stronger if the listening position is approximately 3 to 4 times the distance of the space between the front speakers (or the sideways width of the TV when using the TV’s speakers).

Making the initial settings

Setting the digital output

Use this procedure to set the signal format of the digital audio output.

1 Use [Δ ▽] to select “DIGITAL OUTPUT”, then press [ENTER].

2 Use [Δ ▽] to select the item to be set, then press [ENTER].

NORMAL (Upon purchase):

Select this when an AV amplifier with built-in Dolby Digital or DTS decoder is connected to the DVD-3930's digital audio output terminal.

When playing discs recorded in Dolby Digital or DTS, the corresponding bitstream signals are output.

PCM:

When playing discs recorded in Dolby Digital or DTS, the signals are converted to 48 kHz/16 bit PCM (2-channel) before being output.

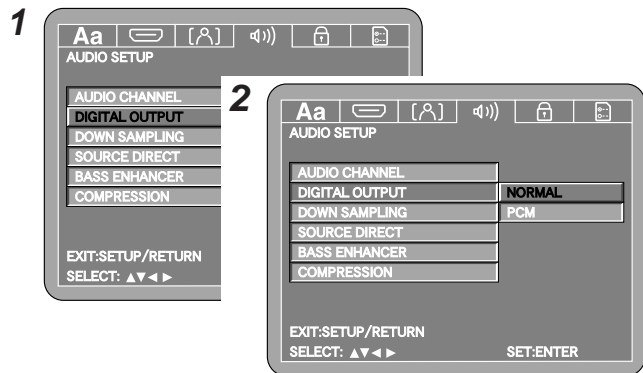

- When playing discs recorded in linear PCM or packed PCM, the signals are output in linear PCM format, regardless of this setting.

Setting the downsampling

Use this procedure to set the digital audio output when playing DVDs recorded in linear PCM or packed PCM.

1 Use [Δ ▽] to select “DOWN SAMPLING”, then press [ENTER].

2 Use [Δ ▽] to select the item to be set, then press [ENTER].

OFF (Upon purchase):

For DVDs recorded in linear PCM or packed PCM without copyright protection, 2-channel audio signals of up to 96 kHz are output as linear PCM signals with no conversion. (192 kHz and 176.4 kHz signals are converted to 96 kHz and 88.2 kHz, respectively.)

ON:

Linear PCM or packed PCM signals are converted to 48 kHz or less for output.

※ Set to “ON” when using digital connections to an AV amplifier that is not compatible with sampling frequencies of 192 kHz, 176.4 kHz, 96 kHz and 88.2 kHz.

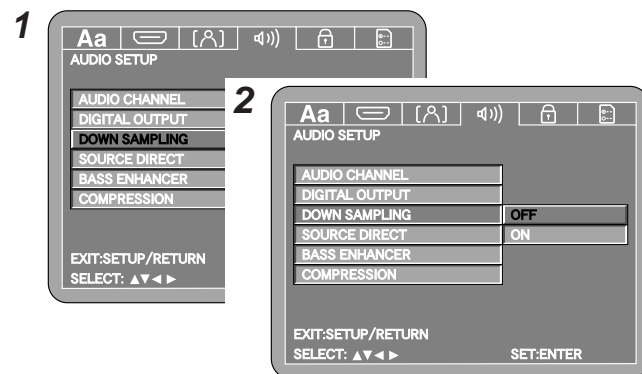

- For DVDs containing multi-channel PCM signals, the signals are down-mixed into the 2-channels and output in digital format. (For sources for which down-mixing is prohibited, only the FL and FR channels are output.)
- When playing linear PCM or packed PCM DVDs with copyright protection, due to considerations for the copyright holder, digital output is not possible for sources of 48 kHz/16 bit or more. To play such sources, either set to “ON”, use DENON LINK or analog connections (🔗 page 9, 10).

Making the initial settings

Setting the source direct

Set this to output the disc's audio information as such without making the “AUDIO CHANNEL”, “SPEAKER SETUP”.

With Super Audio CDs, the playback range can be restricted using this setting.

1 Use [Δ ▽] to select “SOURCE DIRECT”, then press [ENTER].

2 Use [Δ ▽] to select the item to be set, then press [ENTER].

OFF (Upon purchase):

Select this when playing using the “SPEAKER SETUP” and “BASS ENHANCER” settings.

50kHz, 100kHz:

Set this to output the disc's audio information as such without making the “SPEAKER SETUP” and “BASS ENHANCER” settings. With Super Audio CDs, if the disc's audio information is output as such and if an amplifier or speakers not compatible with the high frequencies is/are connected, the amplifier or speakers could be damaged. Set to “50kHz” if the amplifier or speakers is/are not compatible with the high frequencies, “100kHz” if it/they are. (For sources other than Super Audio CDs, the disc's audio information is output as such, regardless of whether this is set to “50kHz” or “100kHz”.)

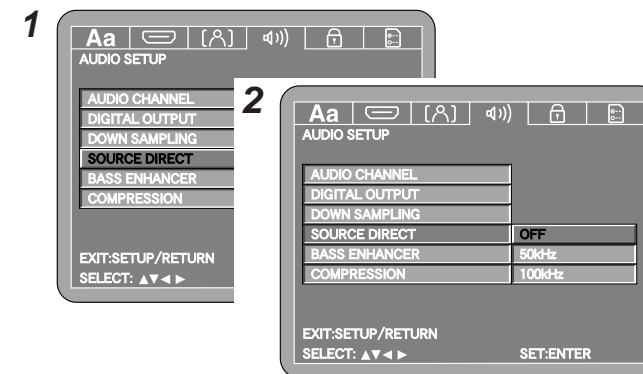

Making the initial settings



- When set to "50kHz" or "100kHz", you can enjoy the DTS recommended full range all-channel sound. (Note however that the subwoofer volume increases by 5 dB, or by 15 dB for Super Audio CDs.) In addition, the 6-channel sources of DVD-Audio discs recorded in the all-channel full range frequency model can also be played. In this case, make analog connections as described in the disc's instructions.
- When setting "50kHz" or "100kHz", set all the speaker sizes to "LARGE" and the subwoofer to "YES".
- The "CHANNEL LEVEL" and "DELAY TIME" settings remain in effect even when "50kHz" or "100kHz" is set.

Setting the bass enhancer

Sets the subwoofer output for when playing 2-channel or other sources without LFE signals.

1 Use [Δ ▽] to select "BASS ENHANCER", then press [ENTER].

2 Use [Δ ▽] to select the item to be set, then press [ENTER].

OFF (Upon purchase):

No sound is output from the subwoofer.

ON:

Sound is output from the subwoofer.

※ Set "SUBWOOFER" at "SPEAKER CONFIGURATION" to "YES".

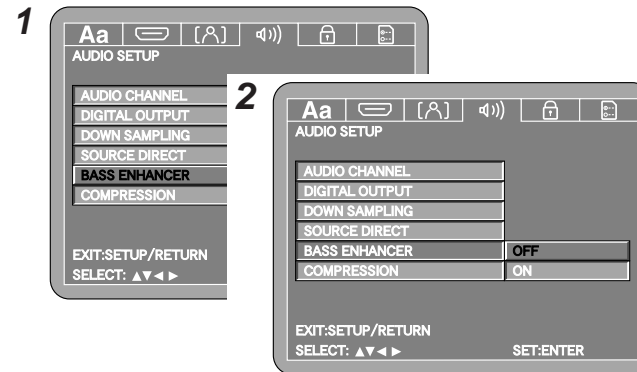

- This setting is only effective for analog outputs.
- This setting is ineffective when "SOURCE DIRECT" is set to "50kHz" or "100kHz".

Making the initial settings

Setting the dynamic range compression

Use this procedure to set the dynamic range of the output signals when playing DVDs recorded in Dolby Digital.

※ **Dynamic range:**

This is the ratio between the softest sound that can be played without being drowned out by the noise generated by the equipment and the loudest sound that can be produced without the sound breaking up.

1 Use [Δ ▽] to select "COMPRESSION", then press [ENTER].

2 Use [Δ ▽] to select the item to be set, then press [ENTER].

OFF (Upon purchase):

The sound is played with the standard dynamic range.

ON:

Select this to achieve a powerful sound even when the volume is low.

This setting is suited for use at night with the volume set low.

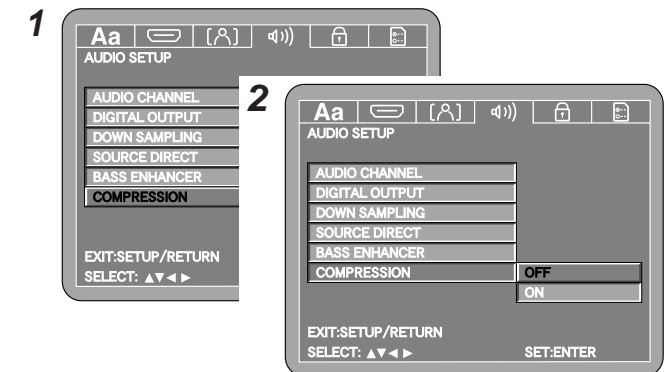

Making the initial settings

Viewing restriction setting ()

Use [**<**] [**>**] to select “  ”.

Setting the viewing restriction level

A password can be set to restrict (prohibit) the playing of adult DVDs so that children or others cannot view them.

1 Use [**△**] [**▽**] to select “RATING LEVEL”, then press [**ENTER**].

2 Use [**△**] [**▽**] to select the setting level, then press [**ENTER**].

0 (LOCK ALL):

This restricts playback of all DVDs.

1:

This restricts playback of adult and regular DVDs.

Select this when you only want to play DVDs for children.

2 ~ 7:

This restricts playback of adult DVDs.

Select this when you want to play both DVDs for children and regular DVDs.

8 (NO LIMIT) (Upon purchase):

With this setting, all DVDs can be played.

3 Use [**NUMBER**] (**0 ~ 9**) to input the password (4 digits), then press [**ENTER**].

※ The default setting for the password is “0000”.



- If the discs includes viewing restriction levels, the password input screen appears.
- If the discs does not include viewing restriction levels, viewing cannot be restricted.

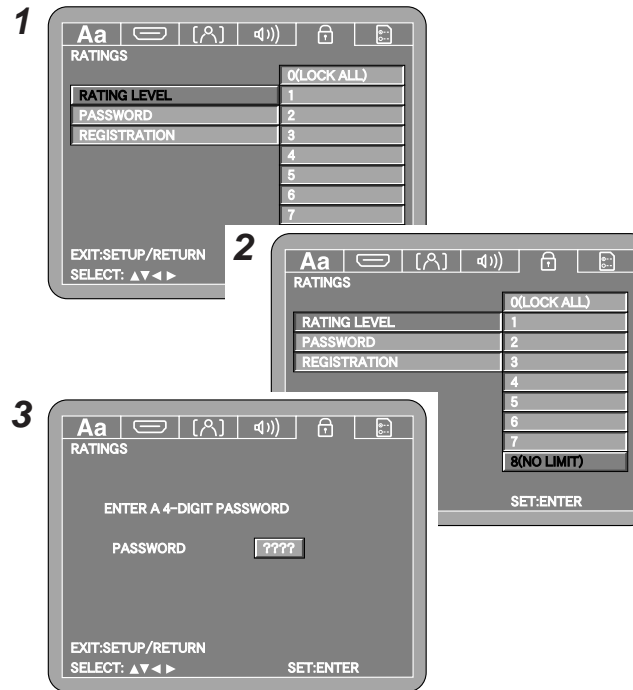

Making the initial settings

Setting the password

Use this procedure to change the password for the “RATING LEVEL”.

1 Use [**△**] [**▽**] to select “PASSWORD”, use [**>**] to select “CHANGE”, then press [**ENTER**].

2 Use [**NUMBER**] (**0 ~ 9**) to input the passwords (4 digits) (password → new password → new password (reinput)), then press [**ENTER**].

※ The default setting for the password is “0000”.

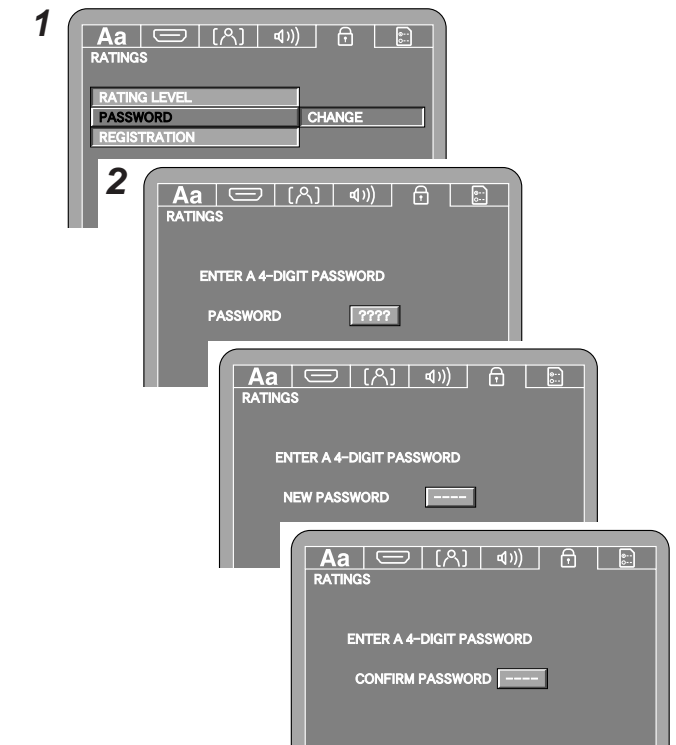

- Be careful not to forget the password. If you do, reset it to the default setting set when the player was purchased ( page 48).

Making the initial settings

Setting the displaying the registration code

Use this procedure to display the registration code for leasing or purchasing DivX® VOD format video files using the DivX® VOD (Video On Demand) service.

- 1 Use [△ ▽] to select “REGISTRATION”,
- 2 Use [▷] to select “SHOW CODE”, then press [ENTER].
 - The 8-digit registration code is displayed.

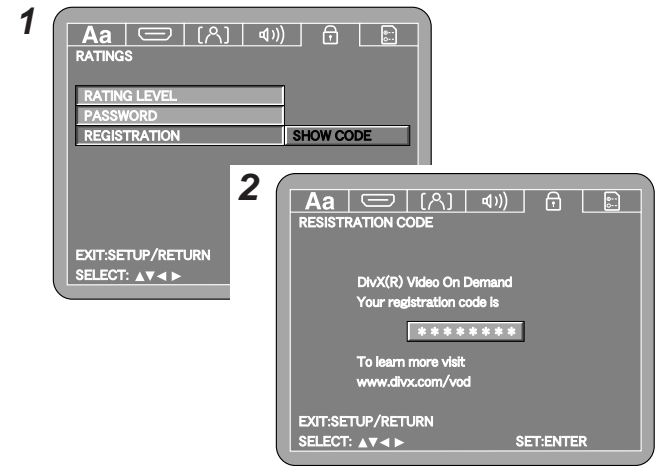

• For details, go to the URL: <http://www.divx.com/vod>

Special settings ()

Use [◀ ▶] to select “ ”.

Setting the player mode

Set the playback mode for playing the DVD-Video contents recorded on DVD-Audio discs.

- 1 Use [△ ▽] to select “PLAYER MODE”, then press [ENTER].
- 2 Use [△ ▽] to select the playing mode, then press [ENTER].

AUDIO (Upon purchase):
DVD-Audio discs are played as such.

VIDEO:
The DVD-Video contents included on DVD-Audio discs are played.

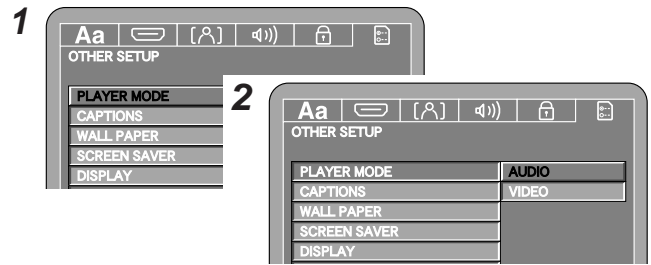

Setting the captions

Use this procedure to set the output of the closed caption signals to display captions using a caption decoder (commercially available).

- 1 Use [△ ▽] to select “CAPTIONS”, then press [ENTER].
- 2 Use [△ ▽] to select the item to be set, then press [ENTER].

OFF (Upon purchase), ON:
Select “OFF” if you do not want to display the captions on the screen, “ON” if you want to display them.

Making the initial settings

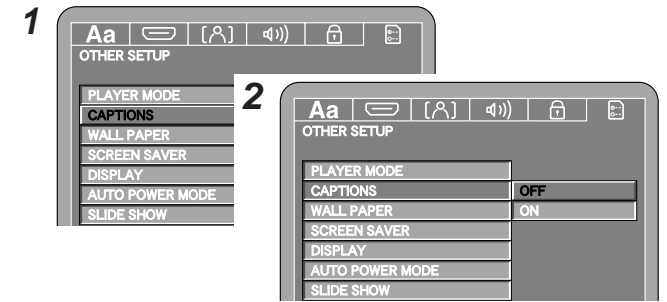

• A caption decoder is required in order to display captions.
• For DVDs including caption signals, the “ ”, “ ” or “ ” mark is displayed.

Setting the wallpaper

Use this procedure to set the picture to be displayed on the TV screen when in the stop mode or when playing CDs, etc.

- 1 Use [△ ▽] to select “WALL PAPER”, then press [ENTER].
- 2 Use [△ ▽] to select the item to be set, then press [ENTER].

PICTURE (Upon purchase), BLACK, GRAY, BLUE:
Set the wallpaper to “PICTURE”, “BLACK”, “GRAY” or “BLUE”.

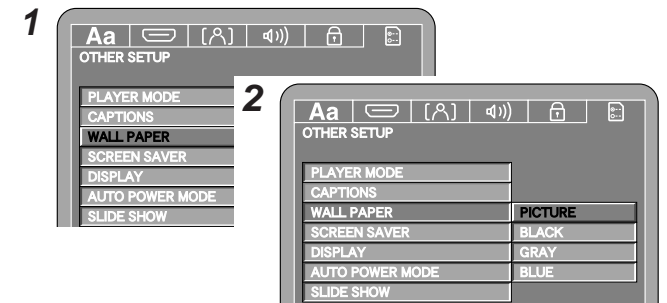

Making the initial settings

Setting the screensaver

The screensaver functions protects the TV screen from imprinting.

1 Use [△ ▽] to select “SCREEN SAVER”, then press [ENTER].

2 Use [△ ▽] to select the item to be set, then press [ENTER].

OFF (Upon purchase):

When this is set, the screensaver function does not work.

ON:

When this is set, the screensaver function is activated after about 5 minutes in the stop or pause mode.

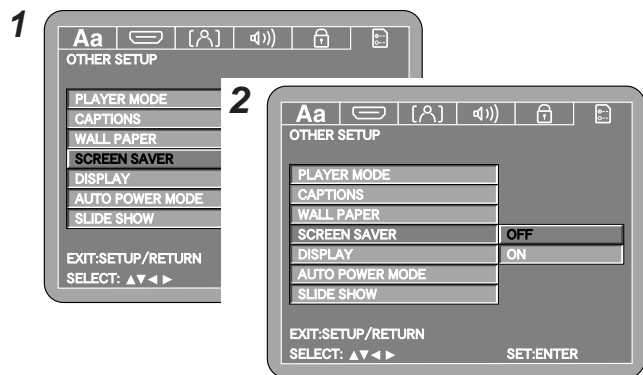

NOTE:

- The screensaver does not function for discs containing MP3, WMA, JPEG or DivX® files.

Setting the display

If the display is turned off with the pure direct or dimmer function, a description of operations can be displayed for about 2 seconds.

1 Use [△ ▽] to select “DISPLAY”, then press [ENTER].

2 Use [△ ▽] to select the item to be set, then press [ENTER].

OFF (Upon purchase), ON:

Set to “OFF” if you do not want the display to light, to “ON” if you do want the display to light.

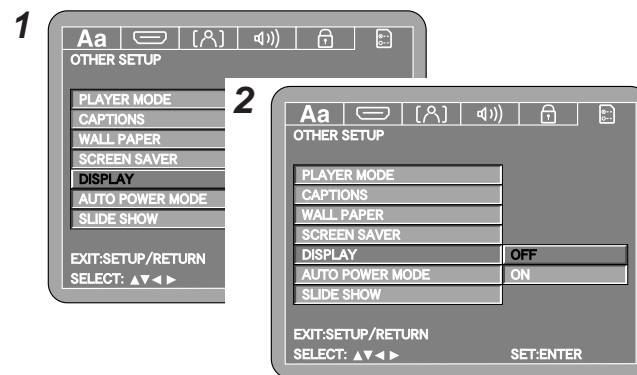

Setting the auto power mode

This function automatically sets the player’s power to the standby mode if the player is left in the stop mode for about 30 minutes.

1 Use [△ ▽] to select “AUTO POWER MODE”, then press [ENTER].

2 Use [△ ▽] to select the item to be set, then press [ENTER].

OFF (Upon purchase), ON:

Select “OFF” if you do not want the power to be set to the standby mode automatically, “ON” if you do want it to be set to the standby mode.

Making the initial settings

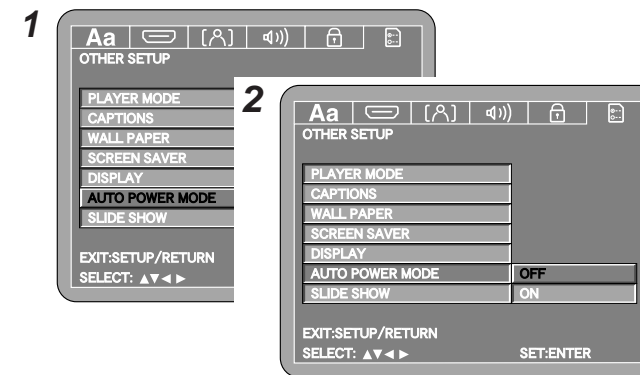

Setting the slide switching time

Use this procedure to set the time after which the still picture (in JPEG format) switches when playing still pictures.

1 Use [△ ▽] to select “SLIDE SHOW”, then press [ENTER].

2 Use [△ ▽] to select the time to be set, then press [ENTER].

5 (Upon purchase) ~ 15 sec:

The still picture switches after the selected time.

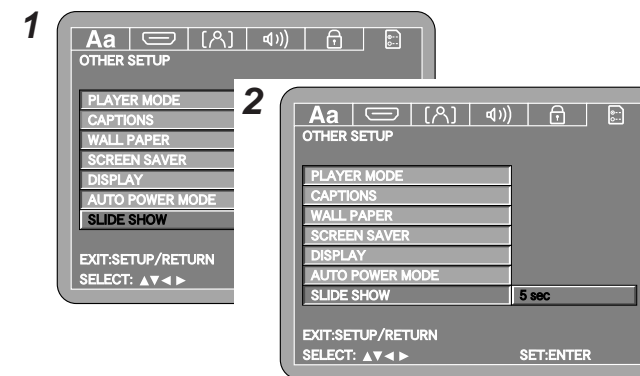

Other settings

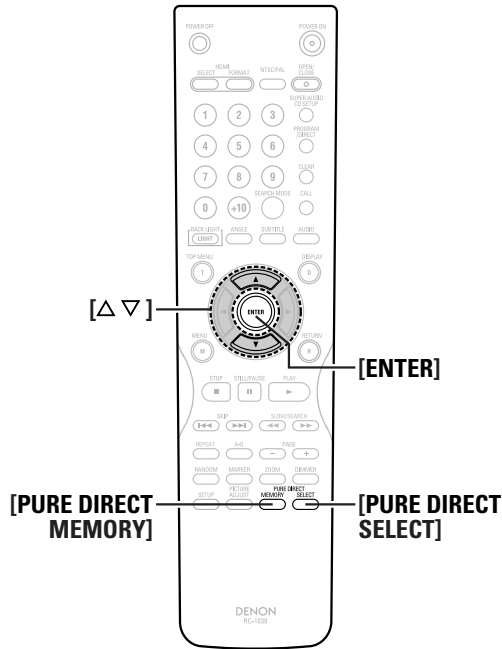

About the button names in this explanation
 < > : Buttons on the main unit
 [] : Buttons on the remote control unit
Button name only :
 Buttons on the main unit and remote control unit

Using the pure direct mode

Use this function to stop output of video signals, etc., and output only the analog audio signals to achieve high quality sound.

- 1 In the stop mode, press [PURE DIRECT MEMORY].**
 - The pure direct memory screen appears.
- 2 Use [Δ ▽] to select “MODE 1” or “MODE 2”, then press [ENTER].**
- 3 Use [Δ ▽] to select the item you want to set, press [ENTER], then use [Δ ▽] again to make the setting.**

DIGITAL OUTPUT:

• **ON (Upon purchase), OFF:**
 Select whether or not to output signals to the digital audio output terminals.

※ The DENON LINK digital output circuitry does not function.

VIDEO OUT:

• **ON (Upon purchase), OFF:**
 Select whether or not to output video signals.

DISPLAY:

• **ON (Upon purchase), OFF:**
 Select whether or not to light the DVD-3930's display.

- 4 Press [PURE DIRECT MEMORY].**
 - The settings are stored at “MODE 1” or “MODE 2”.

- 5 Press [PURE DIRECT SELECT] and select the setting mode.**
 - The mode is indicated on the display.

NORMAL:
 All signals are output.

MODE 1:
 The player operates as per the settings stored at “MODE 1”.

MODE 2:
 The player operates as per the settings stored at “MODE 2”.

ALL OFF:
 Only the analog audio signals are output.

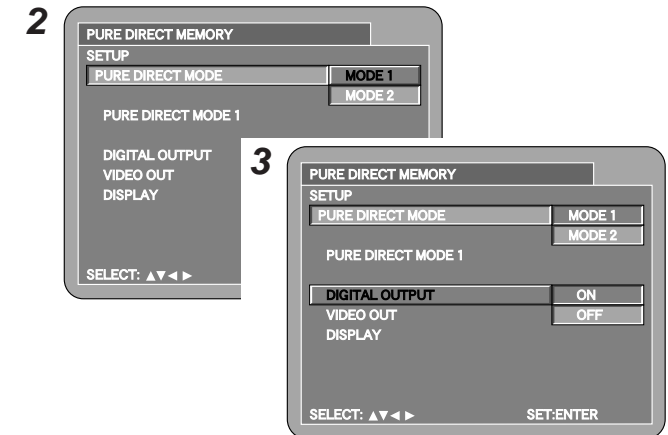

- With HDMI connections, no video or audio signals are output from the HDMI terminals if “VIDEO OUT” is set to “OFF” in step 3 or if the “ALL OFF” mode is selected in step 5.

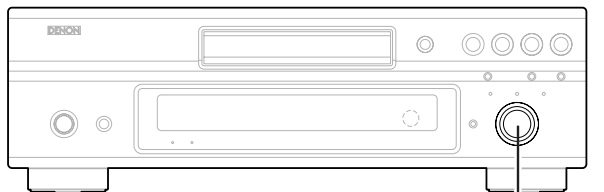

<VIDEO MODE>

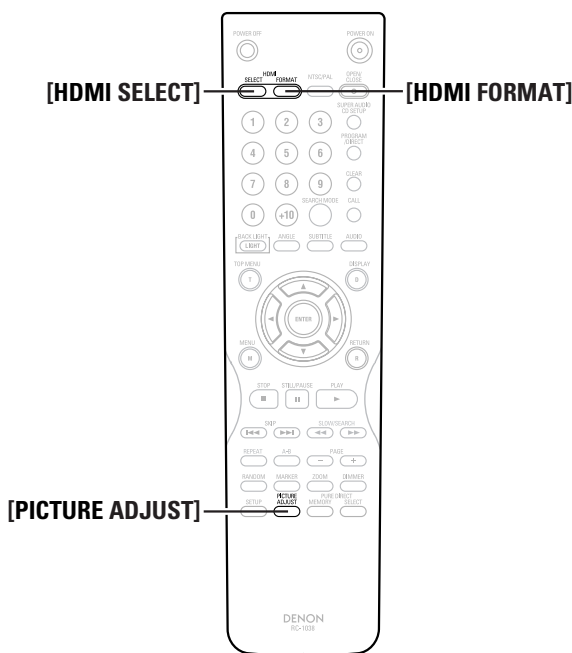

About the button names in this explanation
 < > : Buttons on the main unit
 [] : Buttons on the remote control unit
Button name only :
 Buttons on the main unit and remote control unit

NOTE:
 • The normal display reappears if no operation is performed for 3 seconds while making the selection using <VIDEO MODE>.

Making the settings for the picture output from the HDMI terminal

Changing the signal format

When operating from the remote control unit:
 Use [HDMI SELECT] to select the signal format.
When operating from the main unit :
 ① Turn <VIDEO MODE> to display “HDMI SELECT” on the display, then press <VIDEO MODE>.
 ② Turn <VIDEO MODE> to select the signal format, then press <VIDEO MODE>.

HDMI OFF (Upon purchase):
 Nothing is output from the HDMI terminal.

YCbCr:
 Component format video signals and audio signals are output from the HDMI terminal.

RGB:
 RGB format video signals and audio signals are output from the HDMI terminal.

PC RES.:
 RGB format video signals with a resolution for use on computers and audio signals are output from the HDMI terminal.
 The output is set to 60 Hz, regardless of whether the disc being played in NTSC or PAL.
 ※ Set to “YCbCr” or “RGB” if the TV or monitor connected to the HDMI terminal is not compatible with computer resolutions.

- The “HDMI MODE VIDEO” indicator on the front panel lights when “YCbCr” and “RGB” are selected, and the “HDMI MODE PC RES.” indicator lights when “PC RES.” is selected.
- The picture may be disturbed even if the TV or monitor connected to the HDMI terminal is compatible with computer resolutions.
- When outputting video signals from the HDMI terminal, the video signals output from the component video terminals are interlaced.

Changing the resolution

When the signal format is set to “YCbCr” or “RGB”

When operating from the remote control unit:
 Use [HDMI FORMAT] and select the resolution.
When operating from the main unit :
 ① Turn <VIDEO MODE> to display “HDMI FORMAT” on the display, then press <VIDEO MODE>.
 ② Turn <VIDEO MODE> and select the resolution, then press <VIDEO MODE>.

AUTO:
 The performance of the HDMI device connected to the HDMI terminal is detected automatically and the resolution for its panel’s pixel number or the maximum resolution that can be input is output.
 ※ The output resolution is set at “HDMI AUTO FORMAT” under “digital interface setting” (page 19).
 ※ “480p/576p” output when connected to a DVI device.

480/576i, 480/576P (Upon purchase), 720P, 1080i, 1080P:
 The video signal from the HDMI terminal is converted to the selected resolution for output.
 ※ The video output when “480/576i” is selected is 480i for NTSC, 576i for PAL.
 ※ The video output when “480/576P” is selected is 480P for NTSC, 576P for PAL.

- The resolution is the same for “YCbCr” and “RGB”.

Other settings

 When the signal format is set to "PC RES.":
When operating from the remote control unit:

Use [HDMI FORMAT] and select the resolution.

When operating from the main unit :

① Turn <VIDEO MODE> to display "HDMI SELECT" on the display, then press <VIDEO MODE>.

② Turn <VIDEO MODE> and select the resolution, then press <VIDEO MODE>.

VGA (Upon purchase):

The signal is converted to a resolution of 640 x 480 (60 Hz).

XGA:

The signal is converted to a resolution of 1024 x 768 (60 Hz).

WXGA:

The signal is converted to a resolution of 1280 x 768 (60 Hz).

SXGA:

The signal is converted to a resolution of 1280 x 1024 (60 Hz).

Performing keystone correction

Keystone distortion occurs when the connected projector or screen is at an angle. If so, correct.

※ Valid for progressive and HDMI outputs.



- The keystone correction is not reflected in the video output until the <VIDEO MODE> is pressed to set it. To fine-adjust, repeat step 2 within 3 seconds of pressing <VIDEO MODE>.

Performing keystone correction in the horizontal direction

1 Turn <VIDEO MODE> to display "KEYSTONE-H" on the display, then press <VIDEO MODE>.

2 Turn <VIDEO MODE> to select the amount of correction, then press <VIDEO MODE>.

※ The setting can be set to between -40 and +40.

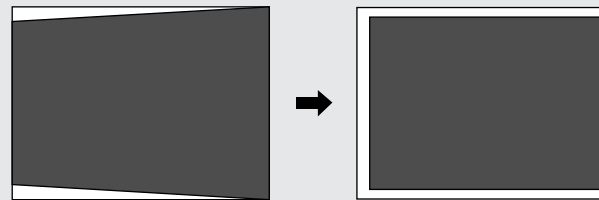
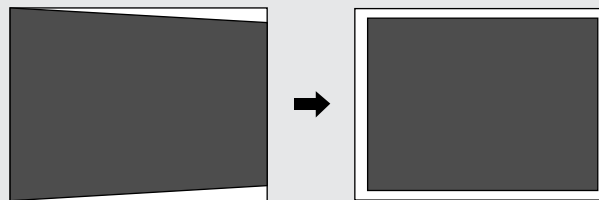
When turned clockwise:**When turned counterclockwise:**

Other settings

Performing keystone correction in the vertical direction

1 Turn <VIDEO MODE> to display "KEYSTONE-V" on the display, then press <VIDEO MODE>.

2 Turn <VIDEO MODE> to select the amount of correction, then press <VIDEO MODE>.

※ The setting can be set to between -30 and +30.

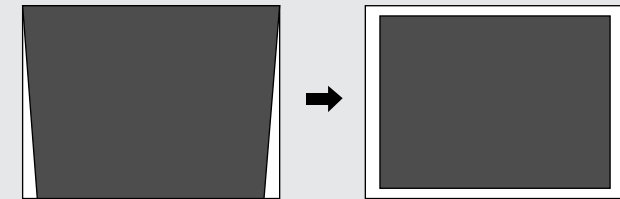
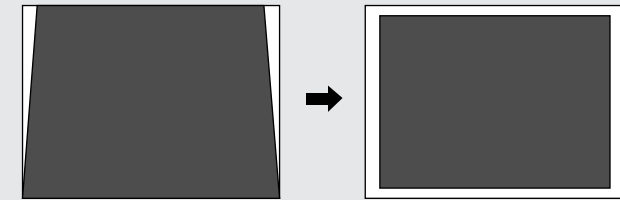
When turned clockwise:**When turned counterclockwise:****NOTE:**

- The greater the amount of keystone correction, the greater the loss of picture quality. For good picture quality, set the devices so that the correction value can be kept to the minimum.



- The image size changes when keystone correction is performed.
- The "KEYSTONE" indicator on the front panel lights when keystone correction is set.

Other settings

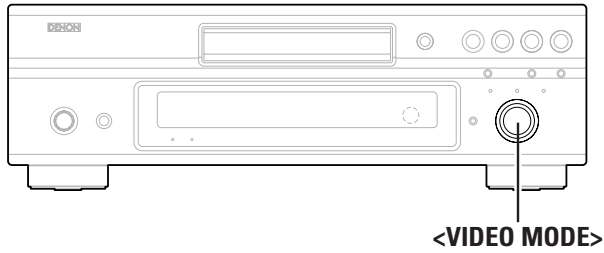

<VIDEO MODE>

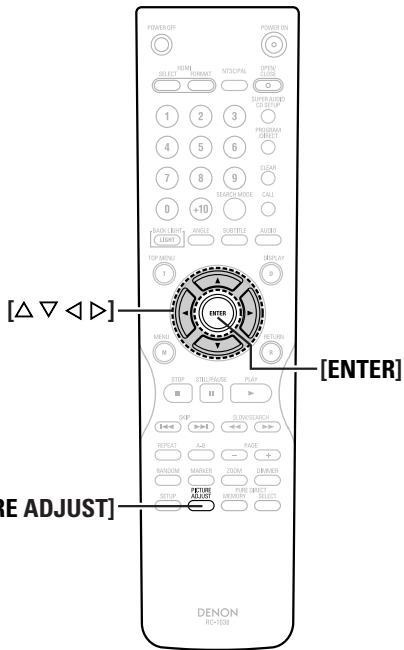

[Δ ▽ ◀ ▶]

[ENTER]

[PICTURE ADJUST]

About the button names in this explanation

< > : Buttons on the main unit

[] : Buttons on the remote control unit

Button name only :

Buttons on the main unit and remote control unit

Audio synchronization adjustment procedure

Use this procedure to set so that the video signal output method's video signal set at "AV Sync" (page 21) under "Making the initial settings" and the audio signal are synchronized.

1 Turn <VIDEO MODE> to display "AUDIO ADJUST" on the display, then press <VIDEO MODE>.

2 Turn <VIDEO MODE> to select the time by which the sound is to be delayed, then press <VIDEO MODE>.

※ The setting can be made between 0 and +200 msec in units of 10 msec. (The higher the value, the greater the delay of the sound with respect to the picture.)

Adjusting the picture quality

Storing the picture quality settings in the memory

Use this procedure to store picture quality settings you have adjusted to suit your tastes at memory positions 1 to 5.

1 Press [PICTURE ADJUST].

2 Use [◀ ▶] to select one of memory positions "M1" to "M5", then press [ENTER].

3 Use [◀ ▶] to select one setting from "Adjust 1" to "Adjust 4".

※ For instructions on making "Adjust 4", see "Gamma correction" (page 33).

4 Press [▽], use [◀ ▶] again to select the item to be adjusted, use [Δ ▽] to adjust, then press [ENTER].

• The settings are stored at the corresponding memory position.

Other settings

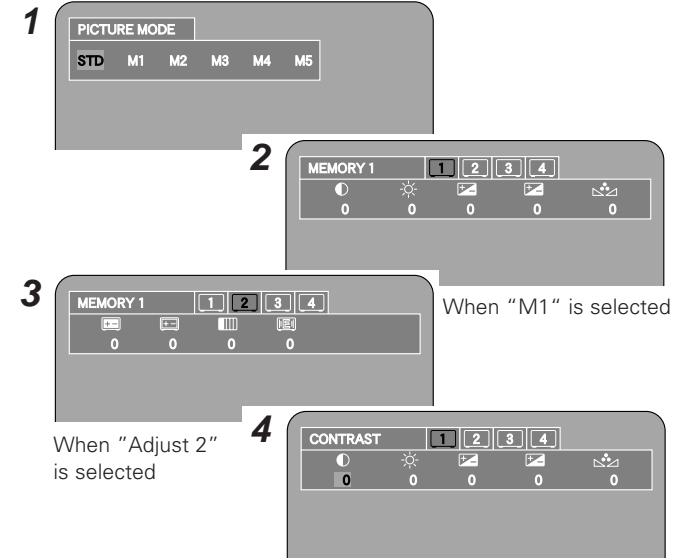

1

2

3

4

When "M1" is selected

When "Adjust 2" is selected

When "CONTRAST" is selected

To quit the picture quality adjustment mode:
Press [PICTURE ADJUST] again.















Other settings

Other settings

 Picture quality adjustment setting memory list

Item		Description
STD	STANDARD	Upon purchase (initial value)
M1	MEMORY1	Picture quality settings can be stored at "Adjust 1" to "Adjust 4".
M2	MEMORY2	
M3	MEMORY3	
M4	MEMORY4	
M5	MEMORY5	

 List of picture quality adjustment modes

Item		Description	Adjustment range (initial value)
Adjust 1	 CONTRAST	Adjusts the difference between the bright and dark parts of the picture.	-6 ~ +6 (0)
	 BRIGHTNESS	Adjust the brightness of the picture.	0 ~ +12 (0)
	 SHARPNESS (medium range)	Adjusts the sharpness of the picture for the medium frequency range. (*1)	-6 ~ +6 (0)
	 SHARPNESS (high range)	Adjusts the sharpness of the picture for the high frequency range. (*2)	-6 ~ +6 (0)
	 HUE (color tone)	Adjusts the balance between the green and red. (*3)	-6 ~ +6 (0)
Adjust 2	 WHITE LEVEL	Adjusts the white level.	-5 ~ +5 (0)
	 BLACK LEVEL	Adjusts the black level. (*2)	-5 ~ +5 (0)
	 CHROMA LEVEL	Adjusts the density of the colors.	-6 ~ +6 (0)
	 ENHANCER	Strengthens the contours of the picture. (*2)	0 ~ +11 (0)
Adjust 3	 DNR (Digital Noise Reduction)	Reduces the overall level of noise on the picture.	0 ~ +3 (0)
	 MPEG NR (MPEG Noise Reduction)	Reduces the noise of the contours of letters and other such parts.	ON/OFF (OFF)
	 SETUP LEVEL	Corrects for unnatural look in the black colors.	0 IRE/7.5 IRE (0)
	 H.POSITION (horizontal direction)	Adjusts the left/right position. (*2)	-7 ~ +7 (0)
	 V.POSITION (vertical direction)	Adjusts the top/bottom position. (*2)	-7 ~ +7 (0)
Adjust 4	 G0 ~ G9 (gamma correction)	Detailed adjustment of the picture's brightness.	16 ~ 235 (G0=24/G1=32/G2=48 /G3=64/G4=80/G5=96 /G6=128/G7=160/ G8=192/G9=224)

*1: Does not affect the HDMI output.

*2: Affects the progressive and HDMI output.

*3: Does not effect the component output's interlaced output.

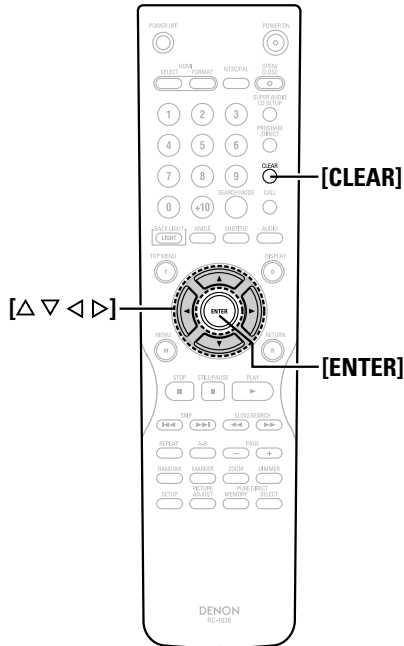

About the button names in this explanation
 < > : Buttons on the main unit
 [] : Buttons on the remote control unit
Button name only :
 Buttons on the main unit and remote control unit

Gamma correction

Make these adjustments using numerical tables or graphs.

- 1 To adjust using the numerical tables:**
 At “Adjust 4”, press [▽].
 To adjust using the graphs:
 At “Adjust 4”, press [ENTER].
 - 2 Use [◀ ▶] to select the point to be adjusted, use [△ ▽] to adjust the brightness level, then press [ENTER].**
 - The settings are stored at the corresponding memory position.
- ※ It is not possible to set the level of the selected point to a value overlapping those of the adjacent points.
 (For example, if G3 is set to 64 and G5 is set to 96, G4 cannot be set to values of 64 or less or 96 or greater.)

MEMORY 1									
G0	G1	G2	G3	G4	G5	G6	G7	G8	G9
024	032	048	064	080	096	128	160	192	224

(Numerical table)

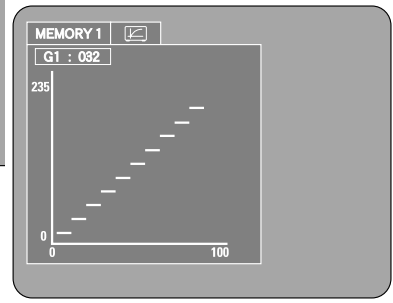

(Graph)

To set back to the standard level:
 Press [CLEAR].

Reference:

Horizontal axis: Brightness level of pictures recorded on disc
 Vertical axis: Brightness level of pictures upon output from the DVD-3930

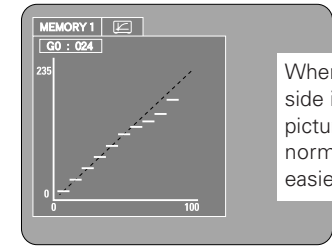

When a bright point on the disc side is adjusted to the “dark” side, pictures whose bright sections are normally hard to see become easier to see.

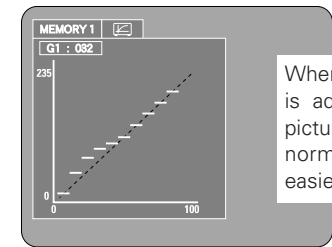

When a dark point on the disc side is adjusted to the “bright” side, pictures whose dark sections are normally hard to see become easier to see.

Basic Operation

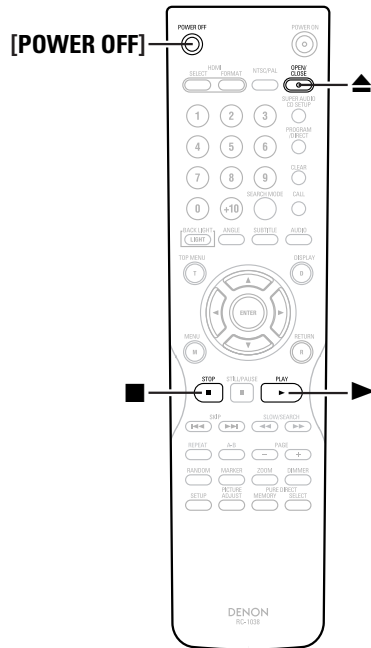
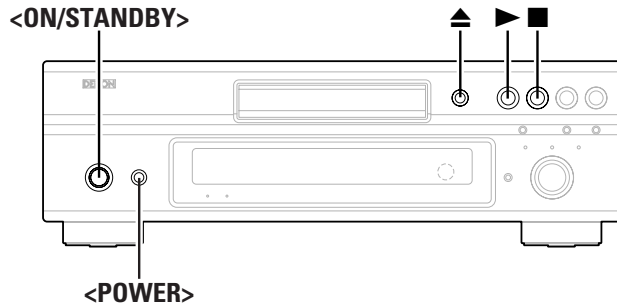

About the button names in this explanation
 < > : Buttons on the main unit
 [] : Buttons on the remote control unit
Button name only :
 Buttons on the main unit and remote control unit

Turning the power on

Press <POWER>.
 • "0h00m00s" is displayed if no disc is loaded.

■ ON: The power indicator lights green.

■ OFF: The power indicator turns off.

※ The power indicator lights red if the standby mode is set by pressing <ON/STANDBY> or [POWER OFF].

Turning the power off:
 Press <POWER> again.

When the power is turned off from the standby mode, it is set to the standby mode when the power is turned back on.

NOTE:
 • When in the standby mode, a very small amount of power is consumed, even if all the indicators are turned off.

Loading discs

Press ▲.
 ※ For instructions on loading discs, see page 4.

To close the disc tray:
 Press ▲ again.

Playing discs

Press ▶.
 • The "▶" indicator lights and playback starts.

For details, refer to the disc's instructions.
 Some discs may be designed by the software producer to operate in ways other than described in this manual.

To stop playback

Press ■.
 • Playback stops and the wallpaper is displayed.
 ※ If "AUTO POWER MODE" at "OTHER SETUP" is set to "ON" in the initial settings (page 27), the power automatically turns off and is set to the standby mode if the player is left in the stop mode for about 30 minutes.

About the resume function

If ■ is pressed during playback, the position at which the disc was stopped is stored in the memory ("▶" flashes on the display). If ▶ is pressed now, playback resumes from the point at which it was stopped.
 The resume function is canceled if the disc tray is opened or if ■ is pressed again.

The resume function operates for discs on which the elapsed time is indicated on the display during playback.
 • The resume function does not work when playing menus.

Basic Operation

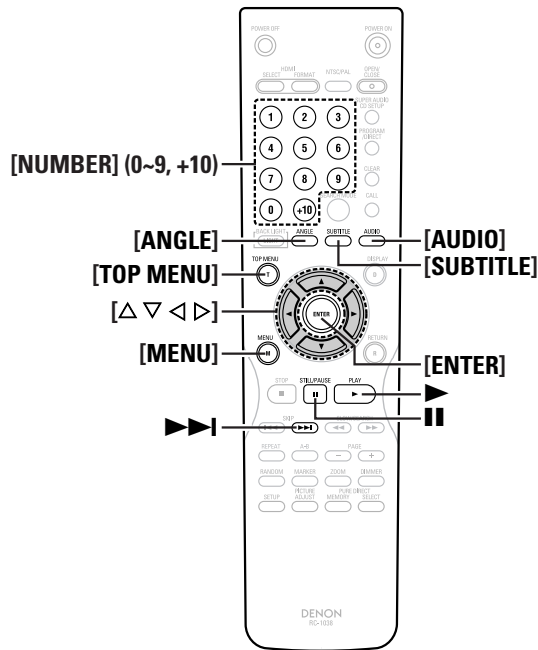
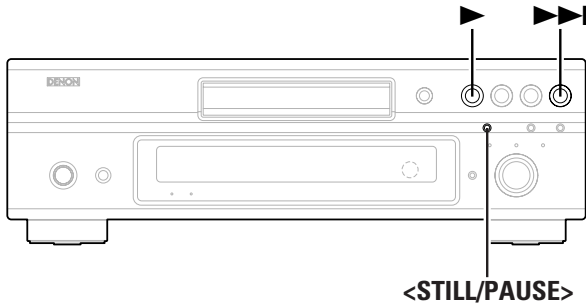

About the button names in this explanation
 < > : Buttons on the main unit
 [] : Buttons on the remote control unit
Button name only :
 Buttons on the main unit and remote control unit

To pause playback

Press **<STILL/PAUSE>**.
 • The "II" indicator lights and the pause mode is set.

To resume playback:
 Press **>**.

About DVD-Video discs

Titles and chapters:
 DVD-Video discs are divided into several large sections (titles) and small sections (chapter). These sections are all allotted numbers, called the title numbers and chapter numbers.

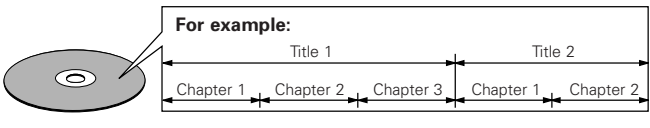

Playing DVD-Video discs

Some DVDs display menu screens.
 Select the desired item, then start playback.

1 Use **[Δ ▽ ◀ ▶]** to select the item you want to see.

2 Press **[ENTER]**.
 • Playback starts.

Basic Operation

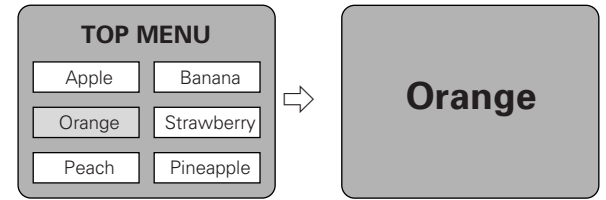

Example: When "Orange" is selected

- While playing a DVD, press **[TOP MENU]** or **[MENU]** to return to the menu screen.
- To display the next page of the menu, press **▶▶**.

Basic Operation

Using the top menu and DVD menu

For DVDs containing multiple titles, the desired title can be selected and played from the top menu.
Some DVDs also have special menus called "DVD menu".

1 Press **[TOP MENU]** or **[MENU]** during playback.

2 Use **[△ ▽ ◀ ▶]** or **[NUMBER] (0 ~ 9, +10)** to select the desired title.

※ Step 3 can be skipped if you use **[NUMBER] (0 ~ 9, +10)**.

3 Press **[ENTER]** or **▶**.
• Playback starts.

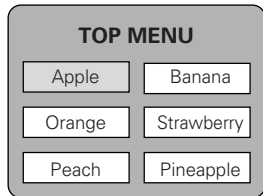

Example: Top menu

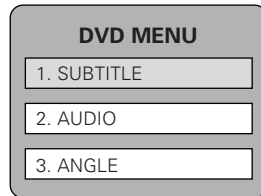

Example: DVD menu

Switching the audio language (Multiple-Audio Function)

The audio language can be switched when playing DVDs containing multiple audio languages.

1 Press **[AUDIO]** during playback.
• The currently playing audio number is displayed.

AUDIO 1/3 : DOLBY D3/2.1 ENGLISH

2 Use **[△ ▽]** to select the desired language.

※ The display turns off when **[AUDIO]** is pressed.

Switching the subtitle language (Multiple-Subtitle Function)

The subtitle language can be switched when playing DVDs containing multiple subtitle languages.

1 Press **[SUBTITLE]** during playback.
• The currently playing subtitle number is displayed.

SUBTITLE 01/03 : ENGLISH

2 Use **[△ ▽]** to select the desired language.

※ The display turns off when **[SUBTITLE]** is pressed.

Basic Operation

Switching the angle (Multiple-Angle Function)

The angle can be switched when playing DVDs containing multiple angles.

1 Press **[ANGLE]** during playback.
• The currently playing angle number is displayed.

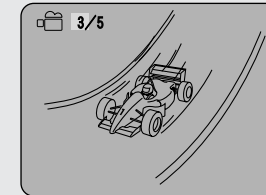

2 Use **[△ ▽]** to select the desired angle.

※ The display turns off when **[ANGLE]** is pressed.

About DVD-Audio discs

Groups and tracks:

DVD-Audio discs are divided into several large sections (groups) and small sections (tracks). These sections are all allotted numbers, called the group numbers and track numbers.

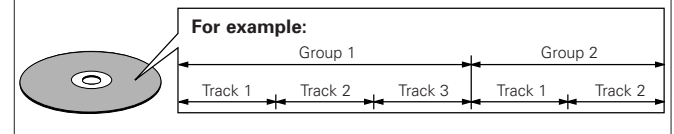

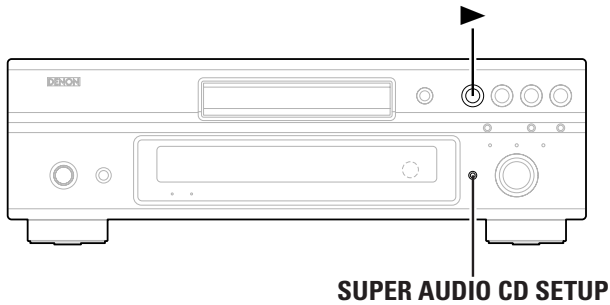

SUPER AUDIO CD SETUP

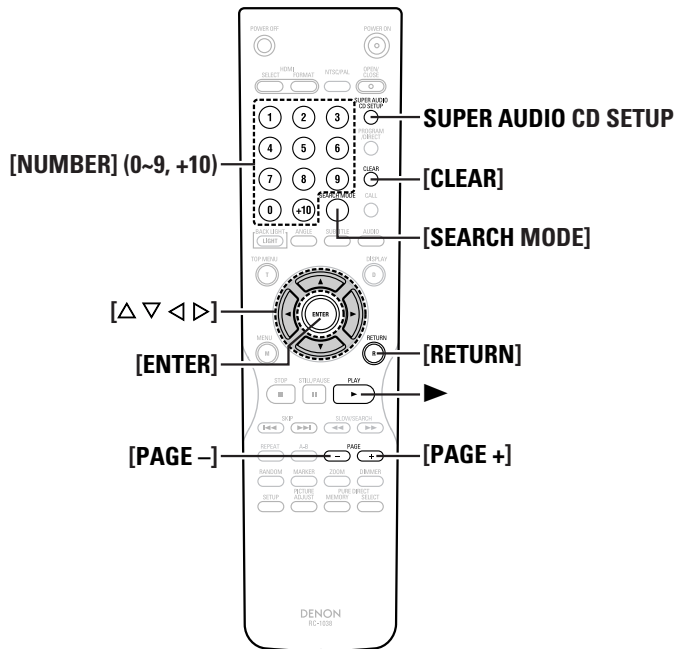

About the button names in this explanation

< > : Buttons on the main unit
 [] : Buttons on the remote control unit

Button name only :

Buttons on the main unit and remote control unit

Switching between groups and tracks

1 In the stop or play mode, press [SEARCH MODE] and select the search mode.

- The mode switches each time the button is pressed and is indicated at the bottom left of the screen, as shown below.



2 Use [NUMBER] (0 ~ 9, +10) input the number of the group or track you want to play.

- Playback starts from the specified group or track.



- The search mode set by pressing [SEARCH MODE] is stored in the memory until the disc tray is opened.

Playing bonus groups

Some DVD-Audio discs contain special groups called “bonus groups” which can only be played by inputting a password.

1 In the Stop mode, press [SEARCH MODE] and select the “GROUP”.

- The “GROUP” indicator lights.

2 Use [NUMBER] (0 ~ 9, +10) to input the bonus group number.

3 Use [NUMBER] (0 ~ 9) to input the passwords (4 digits), then press [ENTER].

- Playback starts from the first track in the specified group.

- ※ In some cases the password is input from a menu screen. Follow the instructions on the screen.

If you input the wrong password:

Press [CLEAR].

Selecting still pictures

For DVD-Audio discs containing still pictures, the desired still picture can be selected.

Press [PAGE +] or [PAGE -] during playback.

- ※ Some discs may be designed by the software producer so that the image cannot be selected.

About Super Audio CDs

There are three types of Super Audio CDs.

- ① Single layer disc
Single layer Super Audio CD with only an HD layer.
- ② Dual layer disc
Super Audio CD with a double HD layer, offering extended playing time and high sound quality.
- ③ Hybrid disc
Two-layer Super Audio CD with an HD layer and a CD layer. The signals on the CD layer can be played on a regular CD player.

- About the HD layer
All Super Audio CDs contain an HD (High Density) layer with high density Super Audio CD signals. This layer can contain a stereo channel area, a multi-channel area, or both a stereo channel and multi-channel area.

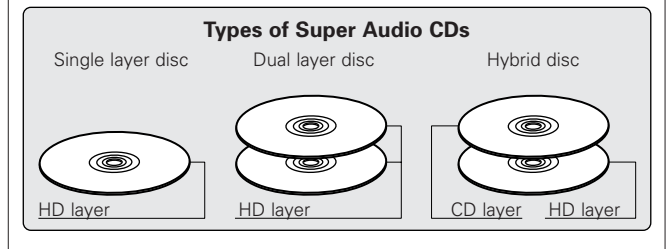

Basic Operation

Setting the Super Audio CD playback area/layer

Use this procedure to select the area/layer to be played once the disc is loaded.

Press **SUPER AUDIO CD SETUP** and select the area/layer.

MULTI (Upon purchase):

The multi-channel area of the HD layer is played.

STEREO:

The 2-channel area of the HD layer is played.

CD:

The CD layer is played.



- When playing discs that do not contain the selected area or layer, the disc is played with the following order of priority: MULTI, STEREO, CD.

About Video and Music CDs

Tracks:

Video and music CDs are divided into several sections (tracks). These sections are all allotted numbers, called the track numbers.

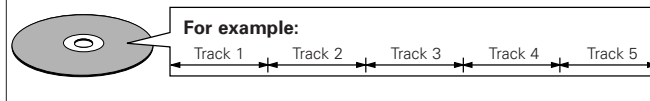

Playback Control (Video CDs):

With video CDs for which "playback control" or the like is indicated on the disc or jacket, the desired scene or information can be selected from menu screens displayed on the TV.

Playing discs with playback control

On most video CDs with playback control, a menu screen is displayed. Select the item you want to see then start playback.

Use **[NUMBER] (0 ~ 9, +10)** to select the item you want to see.

- Playback starts.

Example:

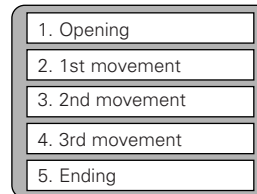

To return to the menu screen.

Press **[RETURN]** during playback.

About discs containing MP3 and WMA format files

Listening to CD-ROM, CD-R or CD-RW discs containing MP3 files

There are many music distribution sites on the Internet allowing you to download music files in MP3 format. When music files are downloaded from such sites following the instructions provided at the site then burned onto a CD-R/CD-RW disc, they can be played on the DVD-3930.

Listening to CD-ROM, CD-R or CD-RW discs containing WMA files

The DVD-3930 can play music files stored on CD-ROM/CD-R/CD-RW discs in WMA (Windows Media® Audio) * format.

* WMA (Windows Media® Audio):

"Windows Media" and "Windows" are registered trademarks or trademarks in the United States and other countries of the Microsoft Corporation of the United States. Audio codec of the Microsoft Corporation of the United States.

1 Load the disc onto which the music files in MP3 or WMA format have been burned.

Basic Operation

2 Use **[Δ ∇ ◀ ▶]** to select the folder you want to play, then press **[ENTER]**.

3 Use **[Δ ∇ ◀ ▶]** to select the file you want to play, then press **[ENTER]** or **▶**.
• Playback starts.

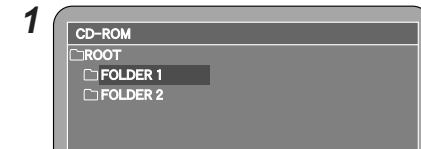

Example: MP3 screen

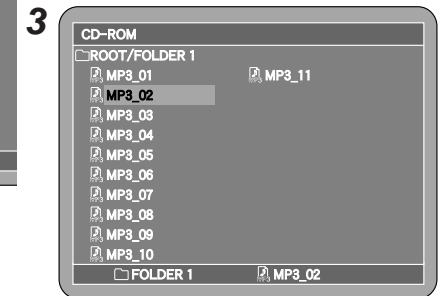
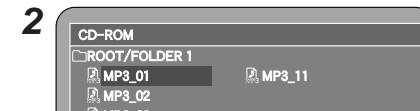

Example: WMA screen

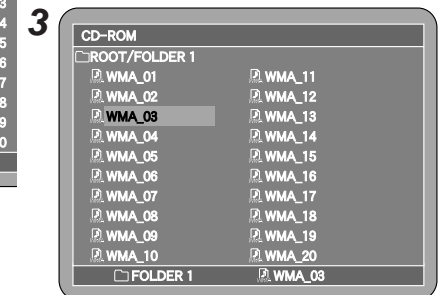
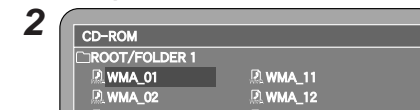

Basic Operation

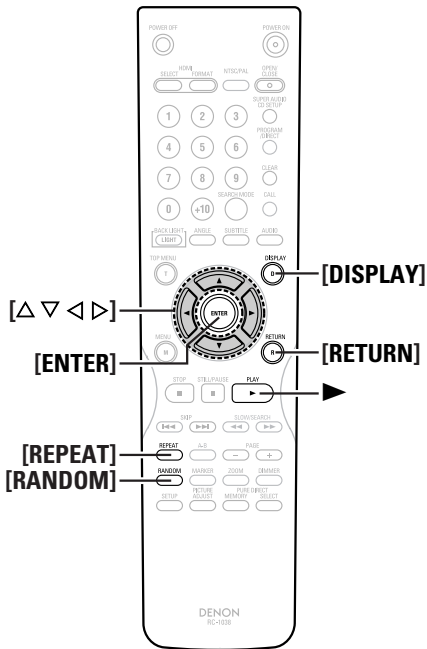
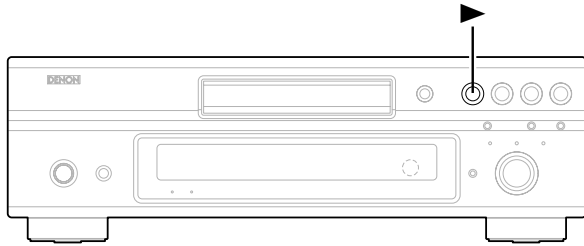

About the button names in this explanation
 < > : Buttons on the main unit
 [] : Buttons on the remote control unit
Button name only :
 Buttons on the main unit and remote control unit

To change the folder to be played:

Press **[RETURN]**, then select the new folder.

To change the file to be played:

Use **[Δ ∇ ◀ ▶]** to select the file, then press **[ENTER]**.

Playing in random order:

In the stop mode, press **[RANDOM]**, then press **[ENTER]** or **▶**.

Playing in repeat order:

Press **[REPEAT]**.

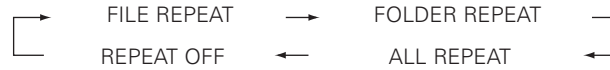

Switching the time display:

Press **[DISPLAY]** during playback.

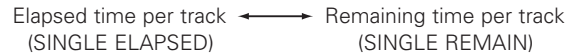

Basic Operation



- When writing MP3/WMA files on a CD-R or CD-RW disc, set the writing software's format to "ISO9660 Level 1". The files may not play properly if they are recorded in other formats. Also note that with some writing software it is not possible to record in ISO9660 format. For details, refer to the instructions of your writing software.
- The DVD-3930 is compatible with the "MPEG-1 Audio Layer-3" MP3 standard (sampling frequency (fs) of 32, 44.1 or 48 kHz). Not compatible with other formats such as "MPEG-2 Audio Layer-3", "MPEG-2.5 Audio Layer-3", "MP1", "MP2", "MP3 PRO", etc.
- The DVD-3930 is compatible with WMA files with sampling frequencies (fs) of 32, 44.1 or 48 kHz.
- The DVD-3930 is compatible with MP3 files with bit rates of 32 to 320 kbps, WMA files with bit rates of 64 to 160 kbps.
- Be sure to add the extensions ".MP3" or ".mp3" to MP3 files, respectively. Be sure to add the extensions ".WMA" or ".wma" to WMA files, respectively.
- The DVD-3930 can play [discs containing] up to 255 folders and 1000 files.
- When playing MP3 or WMA files, the signals are converted to PCM for output from the digital output terminals.
- The DVD-3930 can display folder and file names like titles. Up to 11 characters (letters of the English alphabet, numbers and the "_" (underscore) sign) are displayed. Characters that cannot be displayed are indicated by an "*" (asterisk).
- Copyright-protected files cannot be played. Note that depending on the software used for burning and other conditions, some files may not play or display correctly.
- The positions of the folders or files may have been changed by the writing software when burning the MP3/WMA files onto the CD-R/CD-RW disc, so the files may not play in the expected order.
- The DVD-3930 is not compatible with the ID3-Tag function.
- The DVD-3930 is not compatible with packet-write software.
- The DVD-3930 is not compatible with playlists.

Basic Operation

About discs containing DivX® format files

CD and DVD discs containing digital images recorded in DivX®** format can be played.

* DivX®:
A digital video compression technology with DivX® video coding by DivX Networks Inc.

- 1 Load a disc containing files in DivX® format.
- 2 Use [△ ▽ ◀ ▶] to select the folder you want to play, then press [ENTER].
- 3 Use [△ ▽ ◀ ▶] to select the file you want to play, then press [ENTER] or ▶.
• Playback starts.

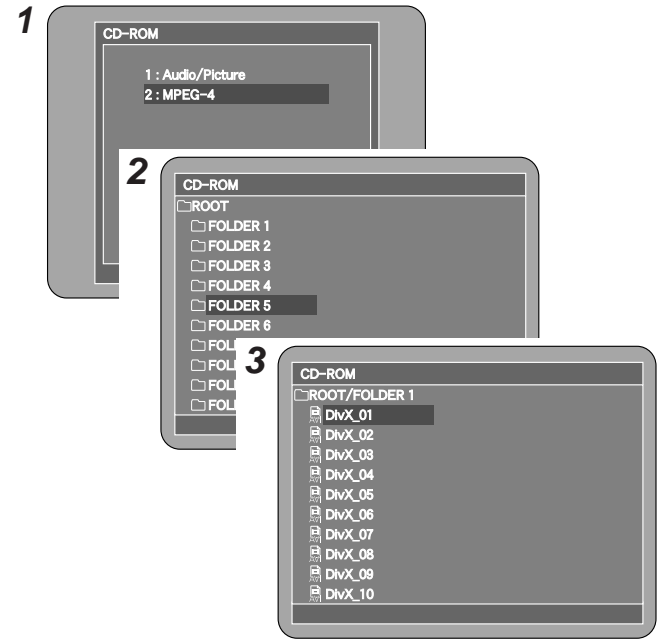

To change the folder to be played:
In the stop or resume mode, press [RETURN], and select the folder again.

To change the file to be played:
In the stop or resume mode, use [△ ▽ ◀ ▶] to select the file again.

Playing in random order:
In the stop mode, press [RANDOM], then press ▶.

Playing in repeat order:
Press [REPEAT].

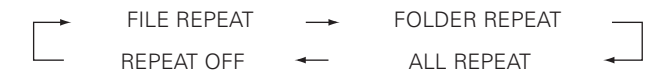

Switching the time display:
Press [DISPLAY] during playback.

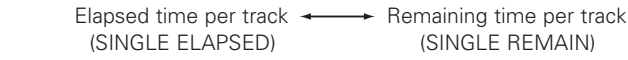

- The DVD-3930 can play [discs containing] up to 255 folders and 1000 files.
- Note that depending on the software used for burning and other conditions, some files may not play or display correctly.
- The DVD-3930 is compatible with DivX® audio sampling frequencies (fs) of 8 to 48 kHz.
- The DVD-3930 is not compatible with motion compensation technology (GMC) or PCM Audio.

Basic Operation

About discs containing still picture files

Use this procedure to play JPEG format files recorded on CD-R/CD-RW discs or Picture CDs or Fujicolor CDs as slideshows.

Playing a disc containing files in JPEG format

- 1 Load a disc containing still picture files in JPEG format.
- 2 Use [△ ▽ ◀ ▶] to select the folder you want to play, then press [ENTER].
- 3 Use [△ ▽ ◀ ▶] to select the file you want to play, then press ▶.
• Playback starts.

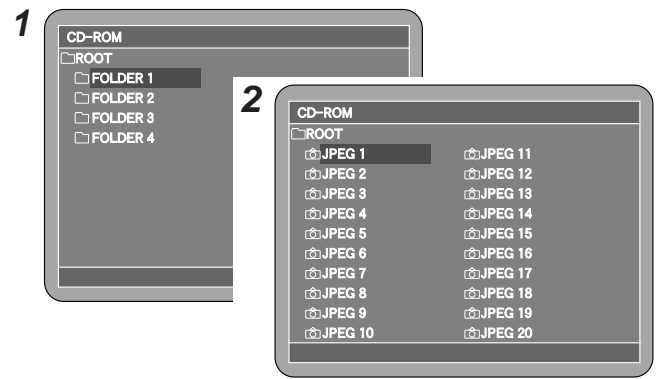

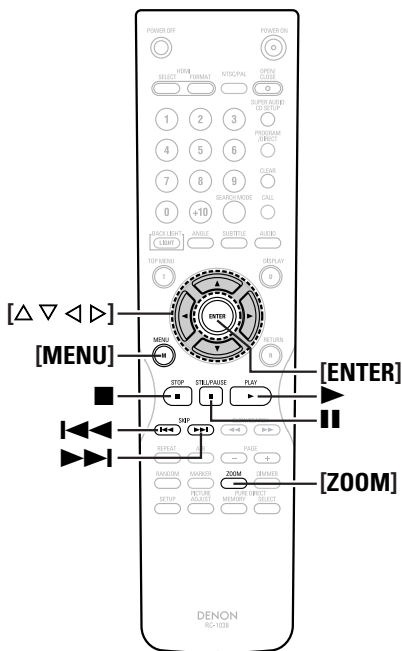
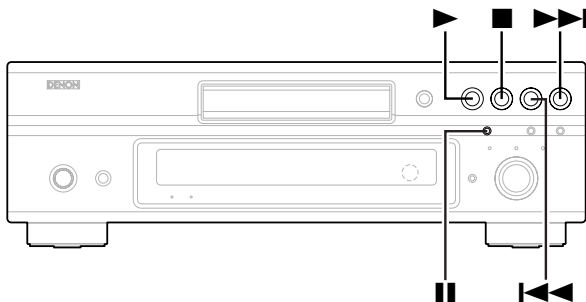

About the button names in this explanation
 < > : Buttons on the main unit
 [] : Buttons on the remote control unit
Button name only :
 Buttons on the main unit and remote control unit

Playing Picture CDs and Fujicolor CDs

The DVD-3930 can play Kodak Picture CDs and Fujifilm Fujicolor CDs, so you can view the photographs recorded on them on your TV.

- * Picture CDs and Fujicolor CDs are part of a service for converting photographs taken on conventional film cameras into digital data and storing them on a CD.
- For details on Picture CDs and Fujicolor CDs, contact a store offering film development services.

Load a disc containing the still pictures.

- Once the disc is loaded, playback starts automatically.
- The still pictures are played continuously until ■ is pressed.

To select the still picture to be played:

During playback, press ■ or [MENU] to display all the pictures, then use [Δ ▽ ◀ ▶] to select the desired picture and press [ENTER].

Cueing to the desired still picture:

Press I◀◀ or ▶▶I during playback.
 I◀◀: The previous still picture is displayed.
 ▶▶I: The following still picture is displayed.

Pausing playback:

Press II.
 Press ▶ to resume playback.

Rotating the still pictures:

In the play or still mode, use [Δ ▽ ◀ ▶] to rotate the still picture.
 Δ ▽ : The still picture is flipped vertically.
 ◀ : The still picture is rotated 90° counterclockwise.
 ▶ : The still picture is rotated 90° clockwise.

To play an image in the zoom mode:

In the pause mode, press [ZOOM]. ("ZOOM" is displayed on the TV screen.)

- The magnification changes each time the button is pressed.
 150% → 200% → 50% → 100% → 150%
- * When the still picture is enlarged, press [ENTER] ("MOVE" is displayed on the TV screen), then use [Δ ▽ ◀ ▶] to move the zoomed picture.
- * Pictures cannot be zoomed in the continuous playback (slideshow) mode.



- The DVD-3930 is compatible with picture data recorded in JPEG format, but it is not guaranteed that all picture data in JPEG format can be played.
- When burning JPEG files onto CD-R/CD-RW discs, do so with the writing software set to "ISO9660 level 1".
- Be sure to add the extension ".JPG" or ".JPE" to JPEG files. (JPEG files written on Macintosh computers cannot be played.)

NOTE:

- Your recordings may be used for your personal enjoyment only, and may not be used without the consent of the copyright holder as per copyright laws.
- Do not play music CDs (CD-DA format) or CD-R/CD-RW discs containing files other than files in MP3, WMA, DivX® or JPEG format. Attempting to play some files may cause malfunction or damage.

Basic Operation

Repeat and random play of MP3, WMA, JPEG and DivX® files

FILE REPEAT:

The selected file is played repeatedly.

FOLDER REPEAT:

Playback starts from the selected file, and all the files in that folder are played repeatedly.

ALL REPEAT:

Playback starts from the selected file, and all the files on the disc are played repeatedly.

RANDOM:

Playback starts from the selected folder, and the other files in that folder are played in random order.

Convenient operations

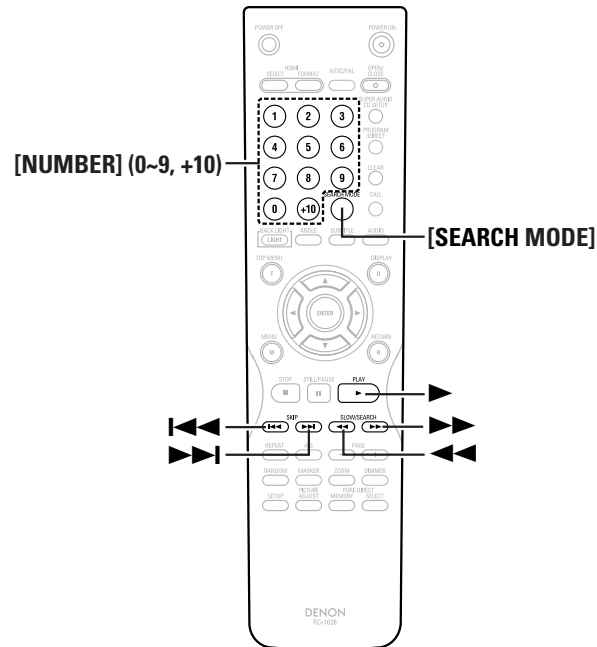
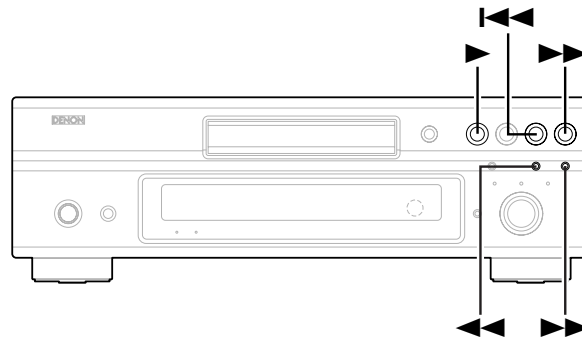
**About the button names in this explanation**

- < > : Buttons on the main unit
 [] : Buttons on the remote control unit

Button name only :

Buttons on the main unit and remote control unit

Fast-forwarding/Fast-reversing

During playback, press ◀◀ or ▶▶.

- The fast-forward/fast-backward speed increases each time one of these buttons is pressed. The speed can be changed in 5 steps.

 Returning to normal playback:

Press ▶.

Moving to the beginning

During playback, press ◀◀◀ or ▶▶▶.

- A number of chapters/tracks equivalent to the number of times the button is pressed is skipped.
- When pressed once in the backwards direction, playback returns to the beginning of the currently playing chapter/track.

Searching using the NUMBER buttons

1 During playback, press [SEARCH MODE] and select the setting mode (for DVD-Video and DVD-Audio discs).

- ※ For DVD-Video discs : TITLE ↔ CHAP
- ※ For DVD-Audio discs : GROUP ↔ TRACK

2 Use [NUMBER] (0 ~ 9, +10) to input the number of the chapter/track you want to play.

- The search mode set by pressing [SEARCH MODE] is stored in the memory until the disc tray is opened.

Convenient operations

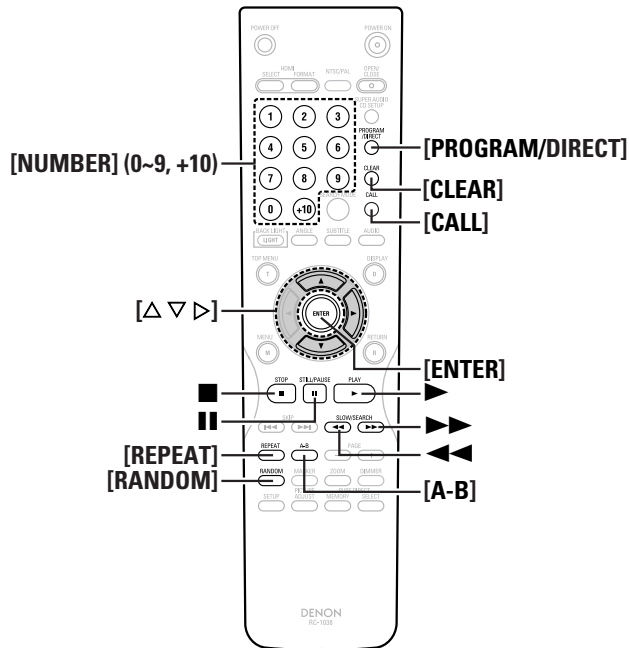
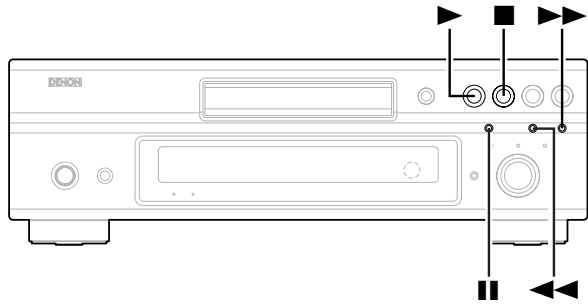

About the button names in this explanation
 < > : Buttons on the main unit
 [] : Buttons on the remote control unit
Button name only :
 Buttons on the main unit and remote control unit

Frame-by-frame playback
 (for DVD-Video discs and Video CDs only)

In the pause mode, press II.
 • The picture advances one frame each time the button is pressed.

Returning to normal playback:
 Press ►.

For DVD-Audio discs, frame-by-frame playback is only possible with the video part.

Slow playback

In the pause mode, press ◀◀ or ▶▶.
 • The speed of slow playback increases each time one of the buttons is pressed. The speed can be changed in 5 steps.

Returning to normal playback:
 Press ►.

For DVD-Audio discs, slow playback is only possible with the video part.
 • Reverse slow play is not possible with video CDs.

Repeat playback

During playback, press [REPEAT].
 • Each time the button is pressed, the repeat mode switches and playback starts in the respective repeat mode.

Convenient operations

For DVD-Video discs:

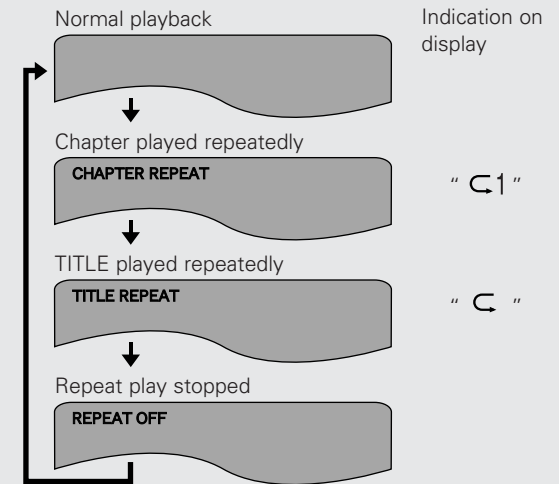

For DVD-Audio discs:

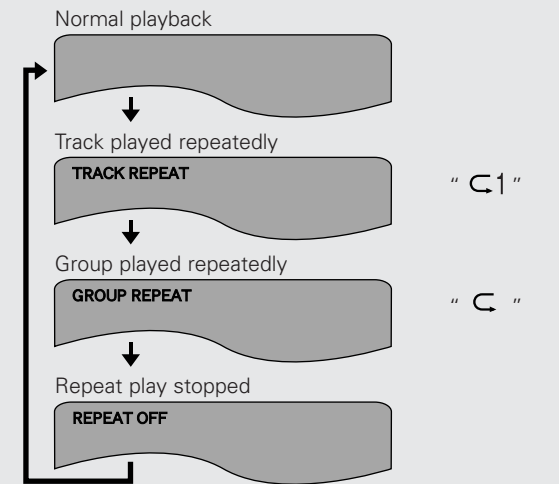

Convenient operations

For Video CDs / Super audio CDs / Music CDs discs:

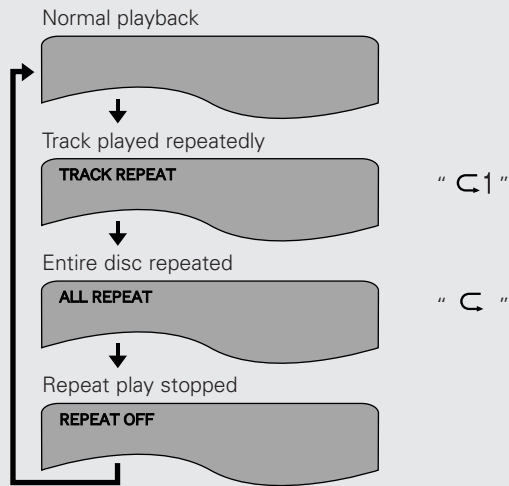

Repeating a section between two specific points (A-B repeat playback)

1 Press [A-B] during playback.

- This sets the starting point A.
- The " C A " indicator appears on the display.

2 Press [A-B] again.

- End point B is set and the A-B section is played repeatedly.
- The " C A-B " indicator appears on the display.

Returning to normal playback:

Press [A-B] until "A TO B CANCELED" appears on the display.



- For some discs, the repeat play and A-B repeat functions do not work.
- The repeat play and A-B repeat functions may not work for discs on which the elapsed playing time is not indicated on the DVD-3930's display during playback.
- During A-B repeat playback, the subtitles just before or after the A-B section may not be displayed.

Programmed playback

For DVD-Audio discs, video CDs, music CDs and Super Audio CDs, track numbers can be programmed to play in the desired order. **Programmed playback is not possible with DVD-Video discs.**

1 In the stop mode, press [PROGRAM/DIRECT].

- The "PROG" indicator appears on the display.

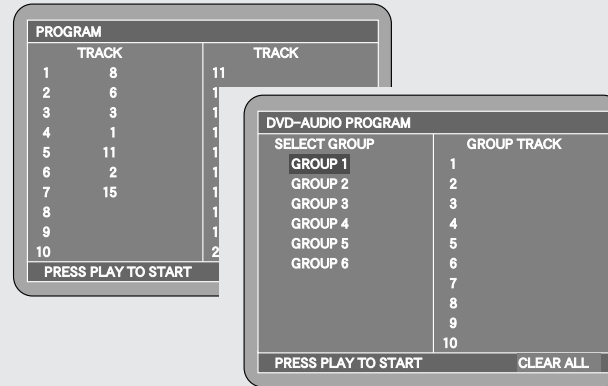

2 Use [NUMBER] (0 ~ 9, +10) to input the number to be set.

- Up to 20 tracks can be programmed.

※ For DVD-Audio discs, use [Δ ▽] to select "group number" and "track number", then press [ENTER].

3 Press [▶].

- Playback starts in the programmed order.

Returning to normal playback:

Press [STOP] twice to stop the disc.

- The program screen is displayed. In addition, when [CALL] is pressed while in the stop mode, the programmed number is shown on the display.

Clearing individual tracks from programs:

Video CDs, Super audio CDs and Music CDs:

In the stop mode, press [CLEAR].

- The last track set in the program is deleted each time the button is pressed.

DVD-Audio:

At the program screen, press [D], select the track to be programmed using [Δ ▽], then press [CLEAR].

Convenient operations

Returning to normal playback:

Press [PROGRAM/DIRECT].

Playing in random order

For DVD-Audio discs, video CDs, music CDs and Super Audio CDs, the tracks can be played in random order.

Random playback is not possible with DVD-Video discs.

1 In the stop mode, press [RANDOM].

- The "RAND" indicator appears on the display.

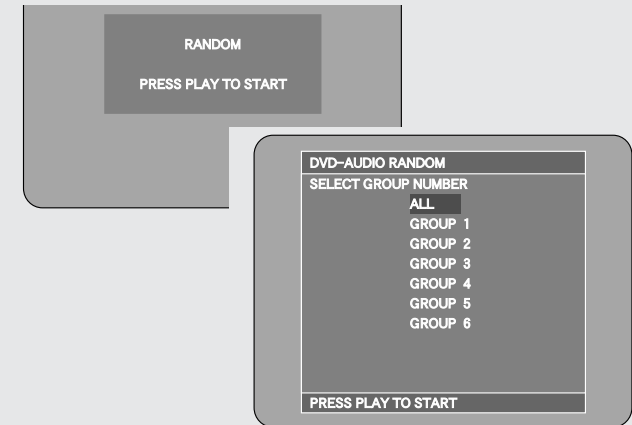

2 Press [▶].

- Random playback starts.

※ For DVD-Audio discs, the group selection screen is displayed. Use [Δ ▽] to select "ALL" or "GROUP number", then press [ENTER]. ("*" is displayed next to "GROUP number".) All the groups are played in random order when "ALL" is selected, and only the tracks within that group are played when "GROUP number" is selected.

Returning to normal playback:

In the stop mode, press [RANDOM].



- Random playback may not be possible for some discs.

Convenient operations

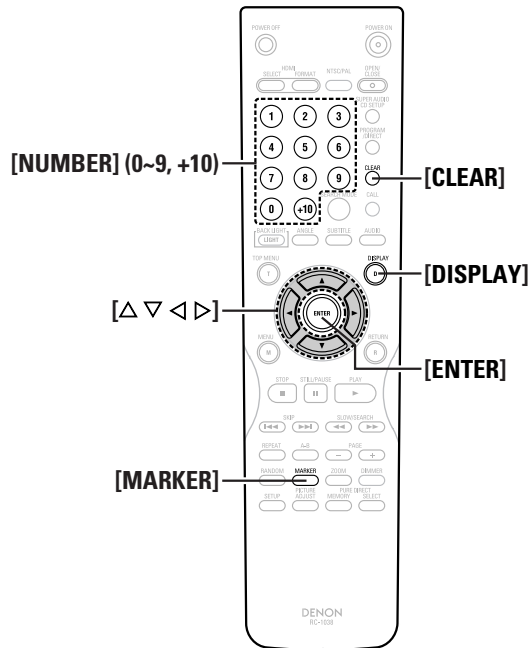

About the button names in this explanation
 < > : Buttons on the main unit
 [] : Buttons on the remote control unit
Button name only :
 Buttons on the main unit and remote control unit

Operating using the on screen display

This function lets you display information about the disc (titles, chapters, time, etc.) and specify the part you want to play.

1 Press **[DISPLAY]** during playback.

- The display on the TV screen switches each time the button is pressed.

※ The items displayed differ from disc to disc.

For DVD-Video discs:

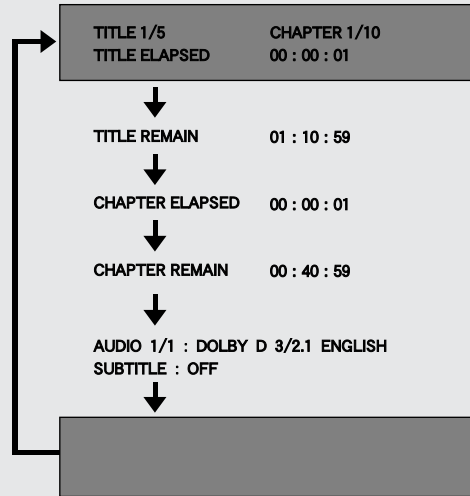

For DVD-Audio discs:

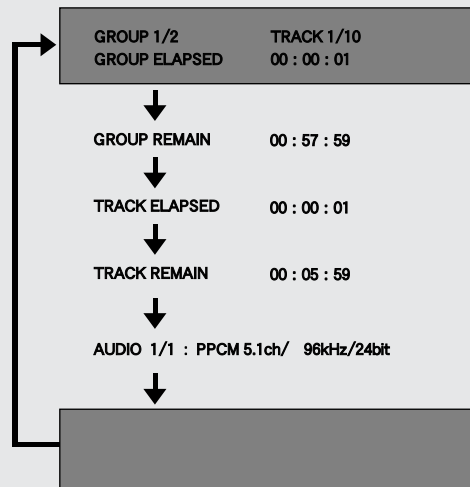

Convenient operations

For Video CDs / Super audio CDs / Music CDs discs:

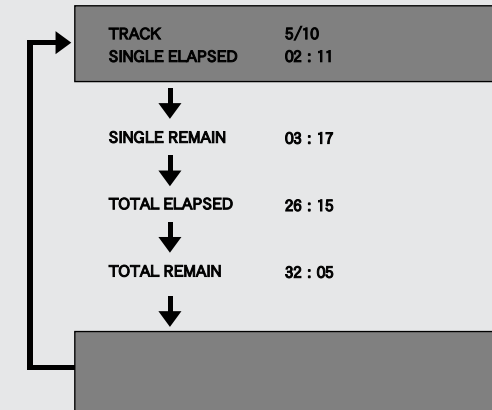

- ※ For video and music CDs, only the elapsed time switches.
- ※ Some Super Audio CDs contain text information. In such cases, the album titles and artists are also displayed in the stop mode, and the title of the currently playing track is also displayed in the play mode.
- ※ For Super Audio CDs containing text information, the total remaining time is displayed twice. The second time, the text information is shown on the DVD-3930's display.

※ It may not be possible to display the disc information either for discs on which the elapsed playing time is not indicated on the DVD-3930's display during playback.

2 Use **[Δ ∇ ◀ ▶]** to select the item you want to change.

- The selected item is displayed in a yellow frame.

Convenient operations

 Specifying the elapsed time

Use **[NUMBER]** (0 ~ 9, +10) to input the time, then press **[ENTER]**.

- Playback starts from the specified point.

※ For some discs it is not possible to specify the time.

For DVD-Video discs:

Example: To specify 1h32m47s

Press **[0] [1] [3] [2] [4] [7] [ENTER]**.

For Video CDs / Music CDs discs:

Example: To specify 1m26s

Press **[0] [1] [2] [6] [ENTER]**.

For Super audio CDs:

Example: To specify 1h32m47s (92m47s)

Press **[0] [9] [2] [4] [7] [ENTER]**.

 Specifying groups, titles, tracks or chapters

Use **[NUMBER]** (0 ~ 9, +10) to input the number, then press **[ENTER]**.

- Playback starts from the specified point.

※ For some discs it is not possible to specify the time.

Marking scenes you want to see again later

Scenes you want to see again later can be marked so you can play them any time.

Adding marks**1** Press **[MARKER]** during playback.

※ “” is displayed if there is no mark.

2 Use **[< >]** to select the marker, then press **[ENTER]** at the point you want to mark.

- A number is displayed.

※ Up to 8 parts can be marked.

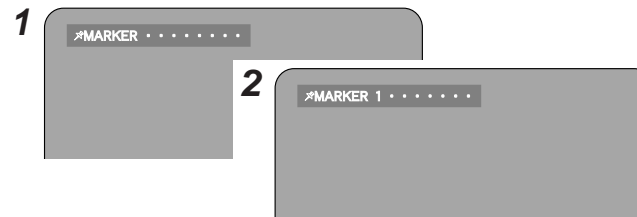

Convenient operations

Calling out marked scenes

Use **[< >]** to select the mark number, then press **[ENTER]**.

- Playback starts from the marked scene.

 To turn off the marker screen:

Press **[MARKER]**.

 Clearing the selected mark number:

Use **[< >]** to select the mark number, then press **[CLEAR]**.

- “” is displayed.



- Depending on where the mark is placed, the subtitles may not be displayed.
- The marks are stored in the memory until the power is turned off or the disc is removed from the player.

Convenient operations

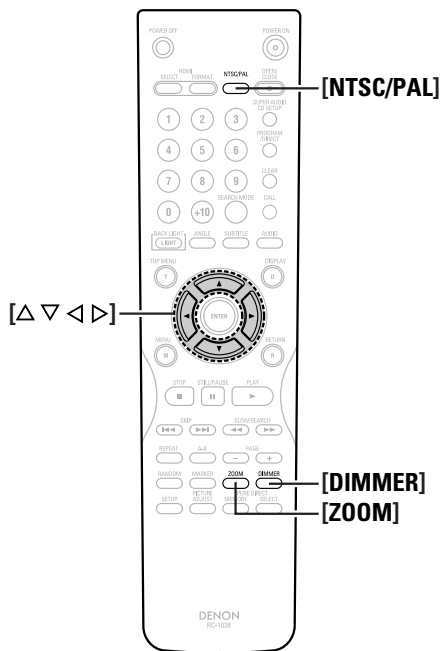
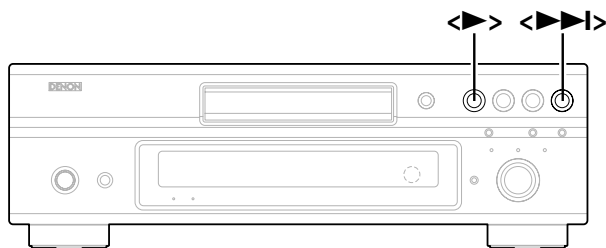

About the button names in this explanation
 < > : Buttons on the main unit
 [] : Buttons on the remote control unit
Button name only :
 Buttons on the main unit and remote control unit

Zoomed play

1 Press [ZOOM] while in the play or pause mode.
 • The magnification changes each time the button is pressed.

For DVD-Video / video-CD :

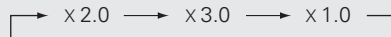

For DivX®:



2 Press [Δ ▽ ◀ ▶].
 • The zoomed picture moves.



- Zooming may not operate properly for certain scenes.
- The quality may be lower and the picture may be shaky when it is zoomed.
- Zoomed play may not work properly for some discs.
- Zoomed play is not possible at the top menu or other menu screens.

Convenient operations

Setting the video format

Set this according to the video format of the connected TV.

Press [NTSC/PAL].



- The picture will not be displayed properly if a video format different from the connected TV's type is set.

Adjusting the brightness of the display

Use this procedure to adjust the brightness of the DVD-3930's display. The brightness can be switched in 3 steps. The display can also be turned off.

Press [DIMMER].

- The brightness switches each time the button is pressed.

Others

About the DENON LINK function

DENON LINK is a balanced transfer type digital link using high speed transfer elements. Connecting the DENON LINK terminal to a DENON AV amplifier equipped with a special terminal using a special cable enables high speed, high quality transfer of digital audio signals with little loss of signal quality, resulting in high quality sound production. DENON LINK is an exclusive DENON digital interface, allowing digital transfer of the 2 channels of 192 kHz/24 bit digital signals of DVD-Audio discs and of PCM multi-channel signals. In addition, DENON LINK 3rd Edition allows for full specification digital transfer of the audio contents of Super Audio CDs.

The "DENON LINK" indicator lights on the display during DENON LINK processing.

Advanced AL24 Processing

"Advanced AL24 Processing" which greatly increases the amount of information in the time axis area using unique high speed signal detection and processing technology for the PCM signal (CD/DVD) playback circuitry is provided for 2-channel output. In addition to expansion of data to 24 bits, natural signal correction without marring the original data is performed with upconversion sampling.

In addition, DENON's original analog waveform reproduction technology, "AL24 Processing PLUS", is used for the 5.1-channel audio output, resulting in high sound quality for all PCM signal sources.

The "Advanced AL24" indicator lights on the display when Advanced AL24 Processing is activated.

Copyright protection technology

This product incorporates copyright protection technology that is protected by U.S. patents and other intellectual property rights. Use of this copyright protection technology must be authorized by Macrovision, and is intended for home and other limited viewing uses only unless otherwise authorized by Macrovision. Reverse engineering or disassembly is prohibited.

Resetting

If the display is abnormal or the main unit or remote control unit do not function, reset the DVD-3930 using the procedure described below.

1 In the stop mode, press <▶> and <▶▶|> simultaneously.

2 Check that the "INITIALIZE" indicator turns off from the TV screen, then release the buttons.

- This completes the resetting procedure.



- If the resetting procedure is not completed, start over from step 1.

Registered trademarks

The DVD-3930 is manufactured using the technologies listed below (in random order).

- "NSV" is a trademark of Analog Devices, Inc.
- "HDMI, the HDMI long and High-Definition Multimedia Interface are trademarks or registered trademarks of HDMI Licensing LLC."
- "HDCD[®], HDCD[®], High Definition Compatible Digital[®] and Microsoft[®] are either registered trademarks or trademarks of Microsoft Corporation, Inc. in the United States and/or other countries. HDCD system manufactured under license from Microsoft Corporation, Inc. This product is covered by one or more of the following: In the USA: 5,479,168, 5,638,074, 5,640,161, 5,808,574, 5,838,274, 5,854,600, 5,864,311, 5,872,531, and in Australia: 669114. Other patents pending.
- Manufactured under license from Dolby Laboratories. "Dolby" and the double-D symbol are trademarks of Dolby Laboratories.
- "DTS" and "DTS Digital Surround" are registered trademarks of Digital Theater Systems, Inc.
- "KODAK" is a trademark of Eastman Kodak Company.
- "FUJICOLOR CD" is a trademark of Fuji Photo Film Co, Ltd.
- "Windows Media™", "Windows[®]" are a trademarks of Microsoft Corporation, Inc.
- DivX, DivX Certified, and associated logos are trademarks of DivX, Inc. and are used under licence.

Others

Troubleshooting

If a problem should arise, first check the following:

1. Are all the connections correct ?

2. Is the set being operated as described in the Operating Instructions ?

If this unit is not operating properly, check the items listed in the table below. Should the problem persist, there may be a malfunction. Disconnect the power immediately and contact your store of purchase.

Symptom	Check	Page
Power does not turn on.	<ul style="list-style-type: none"> Plug the power supply cord into the power outlet. 	12
Playback does not start even when the ► button is pressed, or starts but stops immediately.	<ul style="list-style-type: none"> Condensation? (Let sit 1 or 2 hours) You are attempting to play a disc other than one with one of the marks on page 3. Wipe the dirt off the disc or replace the disc. 	3, 4 3
		4
Picture does not appear.	<ul style="list-style-type: none"> Check the connections. Check whether "VIDEO OUT" in the pure direct settings is set to "OFF" or "ALL OFF". Set the TV's input to "video". 	9 ~ 12 28
		—
No sound is heard or the sound is hard to hear.	<ul style="list-style-type: none"> Check the connections. Set the proper inputs (TV, stereo, etc.). Check the "DIGITAL OUTPUT" and "COMPRESSION" settings. Digital signals are not output for Super Audio CDs. Use analog or DENON LINK 3rd connections. No audio signals are output from the HDMI terminal if "VIDEO OUT" or "DIGITAL OUTPUT" in the pure direct settings is set to "OFF" or "ALL OFF". When HDMI connections are made with a device not compatible with HDMI Ver. 1.1, the audio signals of DVD-Audio discs that are copyright protected with CPPM are not output. 	9 ~ 12 —
		23, 24 10, 11
		28
		12
Menu playback does not work for video CDs.	<ul style="list-style-type: none"> Menu playback only works for video CDs with playback control. 	38
Picture is disturbed when fast-forwarded or fast-reversed.	<ul style="list-style-type: none"> The picture may be somewhat disturbed. This is normal. 	—
Buttons do not operate.	<ul style="list-style-type: none"> Some discs may prohibit certain operations. 	34
Subtitles are not displayed.	<ul style="list-style-type: none"> Subtitles cannot be displayed for DVDs that do not contain subtitles. The subtitles are set to "off". Set the subtitles. 	—
		16, 36
The audio (or subtitle) language cannot be switched.	<ul style="list-style-type: none"> The language cannot be switched unless the disc contains more than one language. With some discs, the audio (or subtitle) language is switched not as described in this manual but by using the DVD menu screen, etc. 	—
		36

Others

Symptom	Check	Page
The angle cannot be switched.	<ul style="list-style-type: none"> The angle cannot be switched unless the DVD contains more than one angle. In some cases, multiple angles are only provided for specific scenes. 	36
Playback does not start when a title is selected.	<ul style="list-style-type: none"> Check the "Viewing restriction level" setting. 	25
You have forgotten the password set for restricting viewing. Reset all the initial setting values to the values set upon purchase.	<ul style="list-style-type: none"> Use the following procedure to reset all the initial setting values to the values set upon purchase. In the stop mode, press the ► and ►► buttons on the main unit simultaneously. (Check that the "INITIALIZE" indicator turns off from the TV screen.) 	48
The audio or subtitle language is not the language set in the initial settings.	<ul style="list-style-type: none"> The selected language is not set if the DVD does not contain sound or subtitles in that language. 	16
The picture is not displayed in 4:3 (16:9) aspect ratio.	<ul style="list-style-type: none"> Set the "TV ASPECT" and "SQUEEZE MODE" items properly in function of your TV. Either set the keystone correction setting to "0" or readjust. 	20, 21 30
Menu screen messages are not displayed in the desired language.	<ul style="list-style-type: none"> Check the "DISC MENUS" setting at "LANGUAGE SETUP" in the initial settings. 	16
Picture does not appear with HDMI connections.	<ul style="list-style-type: none"> Check the HDMI connections. (Check the lighting conditions of HDMI-related indicators.) Check whether the compatible input formats of the connected monitor device match the DVD-3930's input format (HDMI FORMAT). Check whether "VIDEO OUT" in the pure direct settings is set to "OFF" or "ALL OFF". 	11, 12
		11, 12
		28
The set cannot be operated with the remote control unit.	<ul style="list-style-type: none"> Insert the batteries in the proper direction, checking the ⊕ and ⊖ marks. Replace the batteries with new ones. Point at the remote control sensor when operating. Operate within a distance of 7 meters from the remote control sensor. Remove the obstacle. 	5 5 5 5 —

Specifications

□ Audio performance

Signal format:	NTSC / PAL
Applicable discs:	(1) DVD-Audio / DVD-Video discs 12 cm 1 side 1 layer, 12 cm 1 side 2 layers / 12 cm 2 sides 2 layers (1 side 1 layer) 8 cm 1 side 1 layer, 8 cm 1 side 2 layers / 8 cm 2 sides 2 layers (1 side 1 layer) (2) Super Audio CDs 12 cm 1 layer / 12 cm 2 layer / 12 cm Hybrid (3) Compact Disc (CD-DA / VIDEO CD) : 12 cm / 8 cm disc Y output level : 1Vp-p (75 Ω/ohms) / C output level : 0.3 (PAL) / 0.286 (NTSC) Vp-p Output terminal : S-Video, 1 set / AV-1 (21-pin SCART), 1 set
S-Video output:	Output level : 1Vp-p (75 Ω/ohms) Output terminal : Pin-jack, 1 set / AV-1 (21-pin SCART), 1 set
Video output:	Y output level : 1Vp-p (75 Ω/ohms) PB/CB output level / PR/CR output level : 0.7 Vp-p (75 Ω/ohms) Output terminal : BNC jack, 1 set / Pin-jack, 1 set
Component video output:	Output terminal : HDMI (19-pin) , 1 set Output level : 0.7 Vp-p (75 Ω/ohms) / Output terminal : AV-1 (21-pin SCART), 1 set
HDMI output:	Output level : 2 Vrms (10 kΩ/kohms) 2 channels (L/R) output terminal : Pin-jack, 1 set / AV-1 (21-pin SCART), 1 set
RGB output:	Multi channels (FL/FR/C/SL/SR/SW) : Pin-jack, 1 set
Analog audio output:	(1) Frequency response ① DVD (linear PCM) : 2 Hz ~ 22 kHz (48 kHz Sampling) : 2 Hz ~ 44 kHz (96 kHz Sampling) : 2 Hz ~ 88 kHz (192 kHz Sampling) ② Super Audio CD : 2 Hz ~ 100 kHz ③ CD : 2 Hz ~ 20 kHz (2) S/N : 120 dB (3) Harmonic distortion : 0.0008 % (4) Dynamic range : 110 dB
Audio output characteristics:	Output terminal: Optical, 1 set / Coaxial, 1 set / DENON LINK, 1 set
Digital audio output:	

□ General

Power supply:	AC 230 V, 50 Hz
Power consumption:	70 W (In the standby mode : Approx. 1W)
Maximum external dimensions:	434 (W) x 139 (H) x 407 (D) mm (including protruding parts)
Mass:	11.5 kg

□ Remote control unit (RC-1038)

Remote control type:	Infrared pulse
Batteries:	R6P/AA Type (two batteries)
External dimensions:	58 (W) x 230 (H) x 35 (D) mm
Mass:	190 g (included batteries)

* For purposes of improvement, specifications and design are subject to change without notice.

DENON
TOKYO, JAPAN
www.denon.com

Denon Brand Company, D&M Holdings Inc.
Printed in China 00D 511 4531 004