

Panasonic®

使用说明书（另附保修证） Operating Instructions

（家用）电动剃须刀
(Household) AC/Rechargeable Shaver

型号 ES-GA20
Model No.

中文 2

English 9



在使用本产品前，请仔细阅读本说明书并妥善保管，以备将来参考。

Before operating this unit, please read these instructions completely and save them for future use.

重要事项

► 使用剃须刀

注意 - 因外刀网很薄，若使用不当就可能造成损坏。使用剃须刀前，请确认外刀网是否损坏。如果外刀网已损坏，请不要使用该剃须刀，因为这样会割伤皮肤。

请勿用于修剪宠物的毛发。

► 充电

请不要使用除 RE7-51 充电器以外的任何电源线或充电器进行充电。将充电器插入家用电源插座内进行充电，操作时双手应保持干燥。剃须刀在使用和充电过程中可能会变热，但这不是故障。不要将剃须刀放置在阳光直射或有其他热源的地方进行充电。从家用电源插座上拔出充电器时，不要用力拉电源线，因为可能会损坏电源线，应抓紧充电器的插头部位。电源线不能更换，如果电源线损坏，此充电器应废弃。

充电的最佳环境温度为 15 至 35 摄氏度。

若 ► 充电状态指示灯不亮，请稍等直至其亮起。

► 清洁剃须刀

警告 - 用水清洗剃须刀前，请将剃须刀与

电源线分离，以防触电。

请在装有两个内刀头的状态下进行清洗，若在仅装有一个内刀头的状态下进行清洗，可能会损坏剃须刀。用清水清洗剃须刀，不要使用盐水或热水。不要将剃须刀长时间浸泡在水中。可用蘸肥皂水的布擦拭剃须刀。不要使用稀释剂，汽油或酒精擦拭剃须刀任何部位。

► 存放剃须刀

- 存放剃须刀时请拔出电源线。不要折弯电源线或将电源线缠绕在剃须刀上。
- 本品不宜供肢体、感官或精神上有残疾者、或缺乏经验和知识者（包括儿童）使用，必须有监护者从旁监督并对本品的使用加以指导，且对使用者的安全能承担责任。请避免儿童将本品视为玩具，从而引发危险。
- 请妥善处理本产品的包装袋，避免婴幼儿窒息等意外发生。请置于儿童触摸不到的地方。请勿让婴幼儿接触润滑油。
- 请妥善保管本说明书。

各部分名称

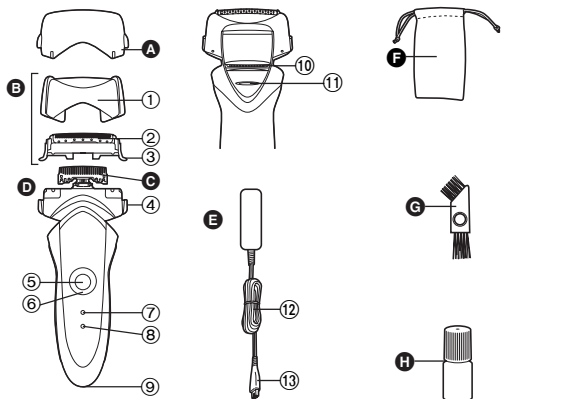

- A** 保护盖
- B** 外刀部
 - ① 外刀架
 - ② 外刀网
 - ③ 外刀网释放按钮
- C** 内刀头
- D** 机身
 - ④ 外刀架释放按钮
 - ⑤ 0/1 开关
 - ⑥ 锁环
 - ⑦ 电池电量指示灯
- E** 充电器 (RE7-51)
- F** 旅行携带小包
- G** 清洁刷
- H** 润滑油
- ⑧ 充电状态指示灯 ()
- ⑨ 电源线插孔
- ⑩ 修剪刀
- ⑪ 修剪刀操纵杆
- ⑫ 电源线
- ⑬ 电源线插头

充电

充电中

- 1 将充电器电源线插头与剃须刀连接。
- 2 将充电器插头插入家用电源插座里。

- 亮起，充电开始。
- 闪烁，充电完成。

(约 1 小时，即可完成充电)

- 购买后初次使用或半年以上未使用过，充电指示灯可能不会立即亮，继续充电几分钟后即正常。

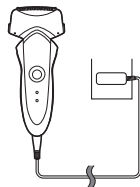

► 使用锁环

使用锁环上锁或开启 0/1 开关。

1. 旋转锁环直至发出咔嗒的响声到位。



开启 0/1 开关：

用于剃须、清洗剃须刀、或润滑剃须刀时



锁住 0/1 开关：

用于随身携带剃须刀时

► 利用交流电剃须

当电池电量低时，您可将剃须刀通过充电器连接至家用电源插座，利用交流电进行剃须。

- 如果剃须刀不能正常使用，请充电约 1 分钟后使用。

关于指示灯

充电时



红灯亮。

充电完成后



红灯闪烁，
每秒一次。

充电完成 10
分钟后



红灯闪烁，每
2 秒一次。

电池电量不足时

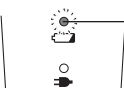

- 在“”闪烁后还可剃须 1 至 2 次。（根据使用情况而定。）

 闪烁。

- 充足电后大约可提供 14 次剃须所需的电量。（一次剃须约为 3 分钟）

► 使用修剪刀

将修剪刀操纵杆往上推，以打开修剪刀。将修剪刀放置与皮肤成直角（90 度）的位置，然后从上向下移动进行修剪。



剃须

使用剃须刀

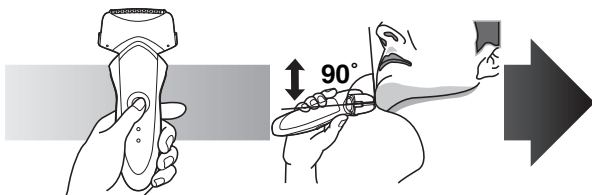

- 1 旋转锁环并按下 0/1 开关。
- 2 如上图所示握住剃须刀剃须。

第 3 页

- 轻轻地压向面部开始剃须。用另一只手绷紧脸上皮肤，逆着胡须生长方向前后移动剃须刀。当皮肤适应剃须刀之后您可以稍稍加大压力，但施加压力过大就可能会造成皮肤伤害。



1. 将剃须刀上的充电器电源线插头拔出。
2. 在外刀网上涂抹少量洗手液和水。
3. 旋转锁环，开启 0/1 开关。

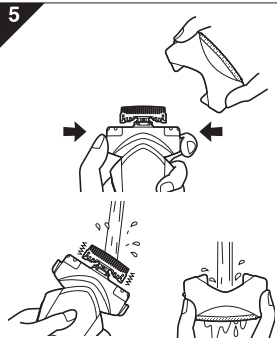

4. 按下 0/1 开关 2 秒钟以上以启动声波洗净模式。
 - 与 指示灯交替闪烁。
 - 约 20 秒钟后，电源自动关闭，或者按 0/1 开关关闭电源。
5. 取下外刀部，按下 0/1 开关 2 秒钟以上，启动声波洗净模式。使用流动水进行清洁。

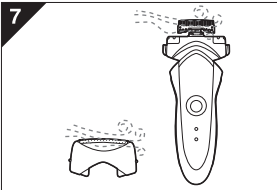

6. 用干布拭去水珠。
7. 使外刀部和剃须刀彻底干燥。
8. 将外刀部安装至剃须刀。
9. 给剃须刀上润滑油。



左侧符号表示适合用在打开的水龙头下进行清洗。

警告：用水清洗剃须刀前，请将剃须刀与电源线分离，以防触电。

使用声波洗净模式的注意事项

- 在声波洗净模式下剃须可能会损伤皮肤。请先关闭剃须刀电源，重新打开即可取消声波洗净模式。
- 使用剃须刀时不要将手指放在 0/1 开关上。这样会导致剃须刀关闭或进入声波洗净模式。

润滑

为长期保持剃须的舒适度，建议使用附赠的润滑油。

1. 关闭剃须刀电源。
2. 给每个外刀网滴一滴润滑油。
3. 推起修剪刀并滴一滴润滑油。
4. 开启剃须刀电源，运转约 5 秒钟。
5. 关闭剃须刀电源，使用软布将外刀网上多余的润滑油拭去。

更换外刀网和内刀头

为了维持剃须刀的剃须性能，建议外刀网每年更换一次，内刀头每两年更换一次。

▶更换外刀网

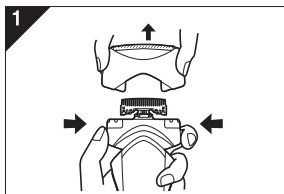

1. 如图所示，按下外刀架释放按钮并向上提起，取出外刀部。

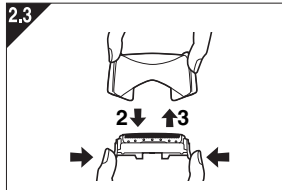

2. 如图所示，按下外刀网释放按钮，拉出外刀网。
3. 向内插入外刀网，直至卡到位。
 - 请注意外刀网的安装方向。
 - 安装到剃须刀时，请确保外刀网插入到外刀架内。

▶更换内刀头

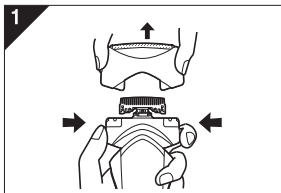

1. 如图所示，按下外刀架释放按钮并向上提起，取出外刀部。
2. 如图所示，取下内刀头，一次取一个。
 - 不要触摸内刀头的边沿（金属部分），以防止您的手受伤。
3. 如图所示，安装内刀头时，每次插入一只内刀头，直至其咔嗒入位。

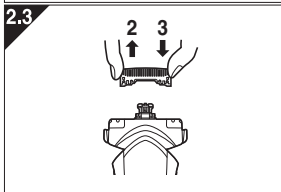

使用刷子清洁

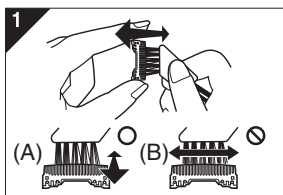

1. 使用短刷，沿左图所示 (A) 的移动方向移动，清洁内刀头。
使用长刷，清洁外刀网、剃须刀机身和修剪刀。
 - 请勿沿 (B) 方向移动短刷，因为这样将损坏内刀头而影响刀片的锋利度。
 - 请勿使用短刷清洁外刀网。

内置式充电电池的取出方式

剃须刀内藏有可充电的电池，在消费者决定废弃剃须刀前，请务必将电池从剃须刀中取出。

- 分解剃须刀，取出电池前，一定要断开电源。
- 鼓励消费者在决定废弃剃须刀前，事先征求经销商或本公司指定维修点的意见，尽量延长剃须刀的使用寿命。
- 当消费者决定废弃剃须刀又不想自行分解剃须刀取出电池时，鼓励消费者将器具送往本公司指定的维修站，由维修店对电池进行分解和回收。
- 电池务必废弃于政府规定的地方或回收处理单位按下图所示的 ① ~ ⑤ 的顺序拆开本体，卸下电池。

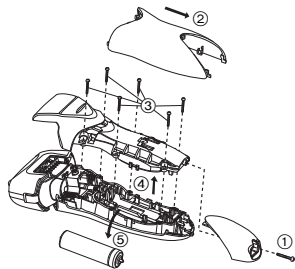

环境保护与资源回收

此剃须刀使用锂电池。

如果贵国有相关规定，请务必在指定处对旧电池进行统一处理。

规格

产品名称	电动剃须刀	
产品型号	ES-GA20	
充电器额定输入	100-240V~ 50-60Hz 180mA	
充电器额定输出	5.4V== 1.2A	
马达电压	3.6V==	
充电时间	约 1 小时	
原产地	本机：日本 充电器：中国	
生产日期	请见商品上刻印	
执行标准	中国国家 标准	GB4706.1 附录 B GB4706.9

本产品仅适合家庭使用。

Important

► Using the shaver

Caution - The outer foil is very thin and can be damaged if not used correctly. Check that the foil is not damaged before using the shaver. Do not use the shaver if the foil etc. is damaged as you will cut your skin.

► Charging the shaver

Do not use any power cord or AC adaptor other than this adaptor (RE7-51). Plug in the adaptor into a household outlet where there is no moisture and handle it with dry hands. The shaver may become warm during use and charging. However, this is not a malfunction. Do not charge the shaver where it will be exposed to direct sunlight or other heat sources. Hold the adaptor when disconnecting it from the household outlet. If you tug on the power cord, you may damage it. The supply cord cannot be replaced. If the cord is damaged, the appliance should be scrapped.

Adequate ambient temperature for charging is 15-35 °C.

If the charge status lamp ➔ does not glow initially when the shaver is plugged in, wait for a short while until it does.

► Cleaning the shaver

Warning - Disconnect the power cord from the shaver before cleaning it in water to prevent electric shock.

Keep both the inner blades inserted. If only one of the inner blades is inserted, the shaver may be damaged. If you clean the shaver with water, do not use salt water or hot water. Do not soak the shaver in water for a long period of time. Wipe it with a cloth dampened with soapy water. Do not use thinner, benzine or alcohol.

► Storing the shaver

- Disconnect the power cord when storing the shaver. Do not bend the power cord or wrap it around the shaver.
- This appliance is not intended for use by persons (including children) with reduced physical, sensory or mental capabilities, or lack of experience and knowledge, unless they have been given supervision or instruction concerning use of the appliance by a person responsible for their safety. Children should be supervised to ensure that they do not play with the appliance.
- Please properly store or dispose the plastic bag of the appliance to avoid any accidents, such as infants suffocation, etc. Keep the plastic bag away from infants. Keep the oil away from children.
- Keep these operating instructions in a safe place.

Parts identification

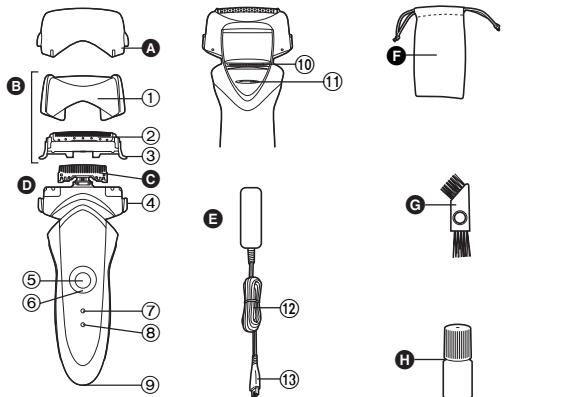

- A** Protective cap
- B** Outer foil section
 - ① Foil frame
 - ② System outer foil
 - ③ System outer foil release buttons
- C** Inner blades
- D** Main body
 - ④ Foil frame release buttons
 - ⑤ 0/1 switch
 - ⑥ Lock ring
 - ⑦ Battery capacity lamp
- 8** Charge status lamp (⇒)
- 9** Appliance socket
- 10** Trimmer
- 11** Trimmer handle
- E** Adaptor (RE7-51)
 - ⑫ Power cord
 - ⑬ Appliance plug
- F** Travel pouch
- G** Cleaning brush
- H** Oil

Charge

Charging

- 1** Insert the appliance plug into the shaver.
- 2** Plug in the adaptor into a household outlet.

- ⇒ glows and charging starts.
- Charging is completed when ⇒ blinks. (after approx. 1 hour)

- When charging the shaver for the first time or when it has not been in use for more than 6 months, the charge status lamp may not glow. It will eventually glow if kept connected.

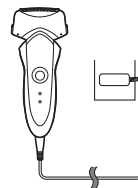

► Using the lock ring

Use the lock ring to lock or unlock the 0/1 switch.
1. Rotate the lock ring until it clicks.



Unlock the 0/1 switch:

For when shaving, washing the shaver, lubricating the shaver.



Lock the 0/1 switch:

For when carrying the shaver.

► Cord shaving

If you insert the appliance plug to the shaver and plug in the adaptor into a household outlet, you can use it even if the battery capacity is low.

- If the shaver does not work, continue charging it for approx. 1 minute.

About the lamp

While charging



Glows red.

After charging is completed



Blinks red once every second.

10 minutes after charging is completed



Blinks red once every 2 seconds.

When the battery capacity is low



- You can shave 1 to 2 times after  blinks. (This will differ depending on usage.)

 blinks.

- A full charge will supply enough power for approx. 14 shaves of 3 minutes each.

► Using the trimmer

Slide the trimmer handle up. Place at a right angle to your skin and move downwards to trim your sideburns.



Shave

Using the shaver

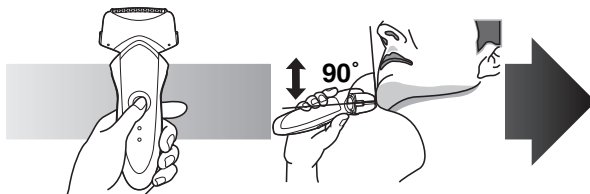

- 1** Rotate the lock ring and press the 0/1 switch.
- 2** Hold the shaver as illustrated above and shave.

Page 10

- Start out shaving by applying gentle pressure to your face. Stretch your skin with your free hand and move the shaver back and forth in the direction of your beard. You may gently increase the amount of pressure as your skin becomes accustomed to this shaver. Applying excessive pressure does not provide a closer shave.

Cleaning



1. Disconnect the power cord from the shaver.
2. Apply some hand soap and some water to the outer foil.

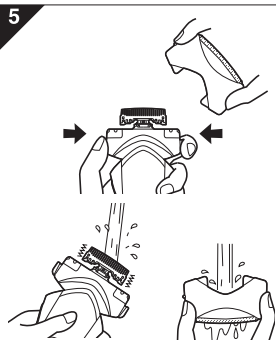

3. Rotate the lock ring to unlock the 0/1 switch.
4. Press the 0/1 switch for more than 2 seconds to activate the sonic vibration cleaning mode.

- ➡ or ⬅ flash around randomly.
- After about 20 seconds, it will be automatically turned off, or you can turn it off by pressing the 0/1 switch.

5. Remove the outer foil section and press the 0/1 switch for more than 2 seconds to activate the sonic vibration cleaning mode and clean it with running water.

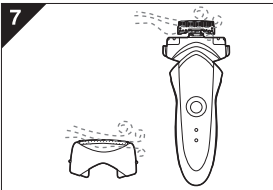

6. Wipe off any drops of water with a dry cloth.
7. Dry the outer foil section and the shaver completely.
8. Attach the outer foil section to the shaver.
9. Lubricate the shaver.

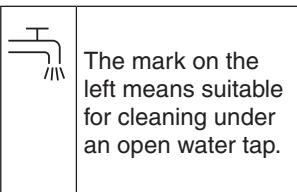

Warning - Disconnect the power cord from the shaver before cleaning it in water to prevent electric shock.

Caution for the sonic vibration cleaning mode

- Shaving in the sonic vibration cleaning mode may damage your skin. Turn the shaver off and then on again to cancel the sonic vibration cleaning mode.
- Do not place your fingers on the 0/1 switch while using the shaver. This may cause the shaver to turn off or enter the sonic vibration cleaning mode.

Lubrication

To maintain shaving comfort for a long time, it is recommended that the oil provided with the shaver is used.

1. Switch off the shaver.
2. Apply one drop of oil to each of the outer foils.
3. Raise the trimmer and apply a drop of oil.
4. Switch the shaver on, and run it for approximately five seconds.
5. Switch off the shaver, and wipe off any excess oil from the outer foils with a soft cloth.

Replacing the system outer foil and the inner blades

system outer foil	once every year
inner blade	once every two years

► Replacing the system outer foil

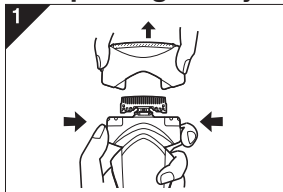

1. Press the foil frame release buttons and lift the outer foil section upwards as illustrated.

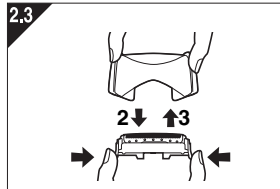

2. Press the system outer foil release buttons and pull down the system outer foil as illustrated.
3. Insert the system outer foil until it clicks.
 - Always attach the system outer foil in proper direction.
 - Always insert the system outer foil to the foil frame when attaching to the shaver.

► Replacing the inner blades

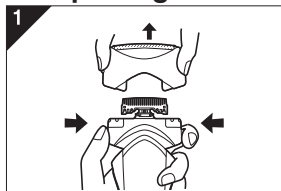

1. Press the foil frame release buttons and lift the outer foil section upwards as illustrated.
2. Remove the inner blades one at a time as illustrated.

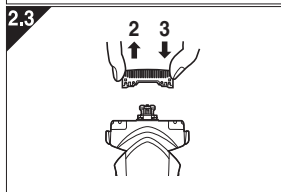

- Do not touch the edges (metal parts) of the inner blades to prevent injury to your hand.
3. Insert the inner blades one at a time until they click as illustrated.

Cleaning with the brush

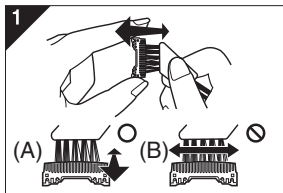

1. Clean the inner blades using the short brush by moving it in direction (A). Clean the system outer foil, the shaver body and the trimmer using the long brush.

- Do not move the short brush in direction (B) as it will damage the inner blades and affect their sharpness.
- Do not use the short brush to clean the outer foils.

Removing the built-in rechargeable battery

Remove the built-in rechargeable battery before disposing of the shaver. Please make sure that the battery is disposed of at an officially designated location if there is one. Do not dismantle or replace the battery so that you can use the shaver again. This could cause fire or an electric shock. Replace it at an authorized service center.

- Disconnect the power cord from the shaver when removing the battery.
- Perform steps ① to ⑤ and lift the battery, and then remove it.

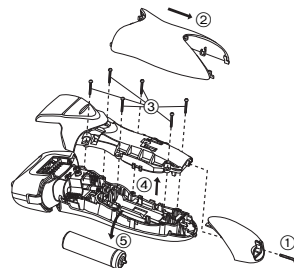

For environmental protection and recycling of materials

This shaver contains a Lithium-ion battery. Please make sure that the battery is disposed of at an officially assigned location, if there is one in your country.

Specifications

Product name	AC/Rechargeable Shaver	
Product model	ES-GA20	
Rated input	100-240V~ 50-60Hz 180mA	
Rated output	5.4V--- 1.2A	
Motor voltage	3.6V---	
Charging time	Approx. 1 hour	
Place of origin	Main body: Japan Adaptor: China	
Date of production	See engraving on the commodity.	
Execution standard	Chinese standard	GB4706.1 appendix B GB4706.9

This product is intended for household use only.

进口商：松下电工（中国）有限公司
地址：北京市朝阳区建国路79号 华贸中心2号写字楼6层、7层703室
电话：86-10-59255988
邮政编码：100025

制造商：松下电工株式会社
地址：日本大阪府门真市大字门真1048番地

Panasonic Electric Works Co., Ltd.
1048, Oaza Kadoma, Kadoma-shi, Osaka 571-8686, Japan

日本印刷
Printed in Japan
ES9700GA203K Y0510-2
发行：2010年5月