

DESCRIPTION

The 1N5518BUR-1 thru 1N5546BUR-1 series of 0.5 watt glass surface mount Zener voltage regulators provides a selection from 3.3 to 33 volts in standard 5% tolerances as well as tighter tolerances identified by different suffix letters on the part number. These have an internal-metallurgical-bond option as identified by the “-1” suffix. This internally bonded Zener package construction is also in JAN, JANTX, and JANTXV military qualifications. Microsemi also offers numerous other Zener products to meet higher and lower power applications.

APPEARANCE

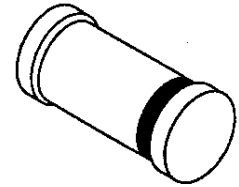

DO-213AA

IMPORTANT: For the most current data, consult MICROSEMI's website: <http://www.microsemi.com>

FEATURES

- Surface mount equivalent to JEDEC registered 1N5518 thru 1N5546 series
- Internal metallurgical bond with the “-1” suffix
- Also available in JAN, JANTX, and JANTXV qualifications per MIL-PRF-19500/437 by adding the JAN, JANTX, or JANTXV prefixes to part numbers for desired level of screening; (e.g. JANTX1N4099UR-1, JANTXV1N4109CUR-1, etc.)
- Nonbonded types also available without the “-1” suffix for both the axial and surface mount packages
- DO-7 or DO-35 glass body axial-leaded Zener equivalents also available per JEDEC registration with part numbers 1N5518 thru 1N5546 on separate data sheets

APPLICATIONS / BENEFITS

- Regulates voltage over a broad operating current and temperature range
- Extensive selection from 3.3 to 33 V
- Standard voltage tolerances are plus/minus 5% with a “B” suffix, e.g. 1N5518BUR-1, etc.
- Tight tolerances available in plus or minus 2% or 1% with C or D suffix respectively, e.g. 1N5518CUR-1, 1N5518DUR-1, etc.
- Hermetically sealed surface mount package
- Nonsensitive to ESD per MIL-STD-750 Method 1020
- Minimal capacitance (see Figure 3)
- Inherently radiation hard as described in Microsemi MicroNote 050

MAXIMUM RATINGS

- Operating and Storage temperature: -65°C to +175°C
- Thermal Resistance: 100°C/W junction to end cap, or 250°C/W junction to ambient when mounted on FR4 PC board (1 oz Cu) with recommended footprint (see last page)
- Steady-State Power: 0.5 watts at end cap temperature $T_{EC} \leq 125^{\circ}\text{C}$ or at ambient $T_A \leq 50^{\circ}\text{C}$ when mounted on FR4 PC board as described for thermal resistance above (see Figure 2 for derating)
- Forward voltage @200 mA: 1.1 volts
- Solder Temperatures: 260°C for 10 s (max)

MECHANICAL AND PACKAGING

- CASE: Hermetically sealed glass DO-213AA (SOD80 or MLL34) MELF style package
- TERMINALS: End caps tin-lead plated solderable per MIL-STD-750, method 2026
- POLARITY: Cathode indicated by band where diode is to be operated with the banded end positive with respect to the opposite end for Zener regulation
- MARKING: cathode band only
- TAPE & REEL option: Standard per EIA-481-1-A with 12 mm tape, 2000 per 7 inch reel or 5000 per 13 inch reel (add “TR” suffix to part number)
- WEIGHT: 0.04 grams
- See package dimensions on last page

ELECTRICAL CHARACTERISTICS ($T_A = 25^\circ\text{C}$ unless otherwise noted. Based on DC measurements at thermal equilibrium; $V_F = 1.1$ Max @ $I_F = 200$ mA for all types.)

JEDEC TYPE NUMBER (Note 1 and Note 7)	NOMINAL ZENER VOLTAGE $V_Z @ I_{ZT}$ (Note 2) VOLTS	TEST CURRENT I_{ZT} mAdc	MAX. ZENER IMPEDANCE B-C-D SUFFIX $Z_{ZT} @ I_{ZT}$ (Note 3) OHMS	MAX. REVERSE CURRENT (Note 4)			B-C-D SUFFIX MAXIMUM DC ZENER CURRENT I_{ZM} (Note 5) mAdc	B-C-D SUFFIX MAX. NOISE DENSITY AT $I_Z = 250\mu\text{A}$ N_D $\mu\text{V}/\sqrt{\text{Hz}}$	REGULATION FACTOR ΔV_Z (Note 6) VOLTS	LOW V_Z CURRENT I_{ZL} (Note 6) mAdc
				I_R μAdc	V_R - VOLTS					
					NON & A-SUFFIX	B-C-D SUFFIX				
1N5518BUR-1	3.3	20	26	5.0	0.90	1.0	115	0.5	0.90	2.0
1N5519BUR-1	3.6	20	24	3.0	0.90	1.0	105	0.5	0.90	2.0
1N5520BUR-1	3.9	20	22	1.0	0.90	1.0	98	0.5	0.85	2.0
1N5521BUR-1	4.3	20	18	3.0	1.0	1.5	88	0.5	0.75	2.0
1N5522BUR-1	4.7	10	22	2.0	1.5	2.0	81	0.5	0.60	1.0
1N5523BUR-1	5.1	5.0	26	2.0	2.0	2.5	75	0.5	0.65	0.25
1N5524BUR-1	5.6	3.0	30	2.0	3.0	3.5	68	1.0	0.30	0.25
1N5525BUR-1	6.2	1.0	30	1.0	4.5	5.0	61	1.0	0.20	0.01
1N5526BUR-1	6.8	1.0	30	1.0	5.5	6.2	56	1.0	0.10	0.01
1N5527BUR-1	7.5	1.0	35	0.5	6.0	6.8	51	2.0	0.05	0.01
1N5528BUR-1	8.2	1.0	40	0.5	6.5	7.5	46	4.0	0.05	0.01
1N5529BUR-1	9.1	1.0	45	0.1	7.0	8.2	42	4.0	0.05	0.01
1N5530BUR-1	10.0	1.0	60	0.05	8.0	9.1	38	4.0	0.10	0.01
1N5531BUR-1	11.0	1.0	80	0.05	9.0	9.9	35	5.0	0.20	0.01
1N5532BUR-1	12.0	1.0	90	0.05	9.5	10.8	32	10	0.20	0.01
1N5533BUR-1	13.0	1.0	90	0.01	10.5	11.7	29	15	0.20	0.01
1N5534BUR-1	14.0	1.0	100	0.01	11.5	12.6	27	20	0.20	0.01
1N5535BUR-1	15.0	1.0	100	0.01	12.5	13.5	25	20	0.20	0.01
1N5536BUR-1	16.0	1.0	100	0.01	13.0	14.4	24	20	0.20	0.01
1N5537BUR-1	17.0	1.0	100	0.01	14.0	15.3	22	20	0.20	0.01
1N5538BUR-1	18.0	1.0	100	0.01	15.0	16.2	21	20	0.20	0.01
1N5539BUR-1	19.0	1.0	100	0.01	16.0	17.1	20	20	0.20	0.01
1N5540BUR-1	20.0	1.0	100	0.01	17.0	18.0	19	20	0.20	0.01
1N5541BUR-1	22.0	1.0	100	0.01	18.0	19.8	17	20	0.25	0.01
1N5542BUR-1	24.0	1.0	100	0.01	20.0	21.6	16	20	0.30	0.01
1N5543BUR-1	25.0	1.0	100	0.01	21.0	22.4	15	20	0.35	0.01
1N5544BUR-1	28.0	1.0	100	0.01	23.0	25.2	14	20	0.40	0.01
1N5545BUR-1	30.0	1.0	100	0.01	24.0	27.0	13	20	0.45	0.01
1N5546BUR-1	33.0	1.0	100	0.01	28.0	29.7	12	20	0.50	0.01

NOTES:

- TOLERANCE AND VOLTAGE DESIGNATION –**
The JEDEC type numbers without a letter prior to the UR-1 suffix are +/-20% with guaranteed limits for only V_Z , I_R , and V_F . Units with "A" prior to the UR-1 suffix are +/-10% with guaranteed limits for V_Z , I_R , and V_F . Units with guaranteed limits for all six parameters are indicated by a B suffix for +/-5.0% units, C suffix for +/-2.0% and D suffix for +/-1.0% prior to the UR-1 suffix.
- ZENER VOLTAGE (V_Z) MEASUREMENT –**
Nominal zener voltage is measured with the device junction in thermal equilibrium with ambient temperature of 25°C .
- ZENER IMPEDANCE (Z_Z) MEASUREMENT –**
The zener impedance is derived from the 60 Hz ac voltage, which results when an ac current having an rms value equal to 10% of the dc zener current (I_{ZT}) is superimposed on I_{ZT} .
- REVERSE CURRENT (I_R) –**
Reverse currents are guaranteed and are measured at V_R as shown on the table.
- MAXIMUM REGULATOR CURRENT (I_{ZM}) –**
The maximum current shown is as shown in MIL-PRF-19500/437.
- MAXIMUM REGULATION FACTOR (ΔV_Z) –**
 ΔV_Z is the maximum difference between V_Z at I_{ZT} and V_Z at I_{ZL} measured with the device junction in thermal equilibrium.
- PART NUMBER –** These may be ordered as either 1N5518BUR-1 thru 1N5546BUR-1 or as MLL5518B-1 thru MLL5546B-1 part numbers. For military types, use the 1NxxxUR-1 format and also include JAN, JANTX, or JANTXV prefix for desired screening level, e.g. JANTX1N5518BUR-1, JANTXV1N5532BUR-1, JANTXV1N5534CUR-1, JANTXV1N5545DUR-1, etc.

GRAPHS and CIRCUIT

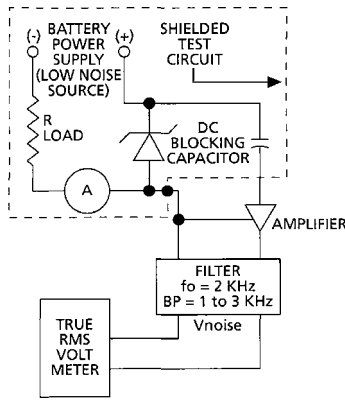

Noise density, (N_D) is specified in microvolt-rms per square-root-hertz. Actual measurement is performed using a 1 kHz to 3 kHz frequency bandpass filter at a constant Zener test current (I_{ZT}) at 25°C ambient temperature.

FIGURE 1 Noise Density Measurement Circuit

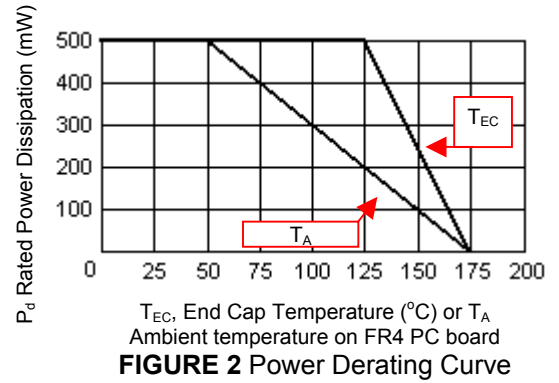

FIGURE 2 Power Derating Curve

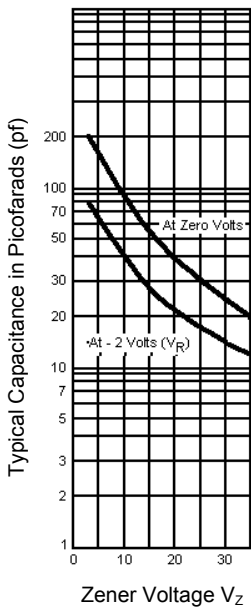

FIGURE 3 Capacitance vs. Zener Voltage (Typical)

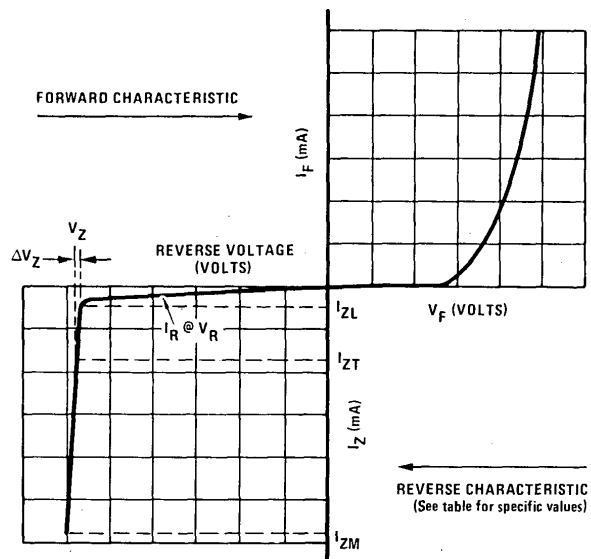
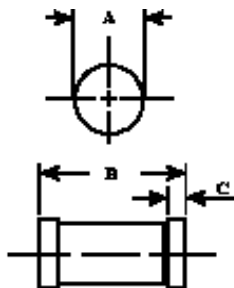

FIGURE 4

Zener Diode Characteristics and Symbol Identification

PACKAGE DIMENSIONS



DIM	INCHES		MILLIMETERS	
	MIN	MAX	MIN	MAX
A	0.063	0.067	1.60	1.70
B	0.130	0.146	3.30	3.70
C	0.016	0.022	0.41	0.55

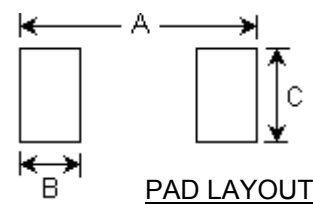

	INCHES	mm
A	.200	5.08
B	.055	1.40
C	.080	2.03

Copyright © Each Manufacturing Company.

All Datasheets cannot be modified without permission.

This datasheet has been download from :

www.AllDataSheet.com

100% Free DataSheet Search Site.

Free Download.

No Register.

Fast Search System.

www.AllDataSheet.com