

Register your product and get support at

www.philips.com/welcome

DVP3588K



EN	User manual	3
ZH-CN	用户手册	23

PHILIPS

部件名称 Name of the Parts	有毒有害物质或元素 Hazardous/Toxic Substance					
	铅 (Pb, Lead)	汞 (Hg, Mercury)	镉 (Cd, Cadmium)	六价铬 (Chromium 6+)	多溴联苯 (PBB)	多溴二苯醚 (PBDE)
Housing 外壳	O	O	O	O	O	O
DVD loader DVD 光盒	X	O	O	O	O	O
PWBs 电路板组件	X	O	O	O	O	O
Accessories (Remote control & cables) 附件 (遥控器, 电源线, 连接线)	X	O	O	O	O	O
Batteries in Remote Control (ZnC) 遥控器电池	X	O	O	O	O	O

O: 表示该有毒有害物质在该部件所有均质材料中的含量均在SJ/T11363 - 2006 标准规定的限量要求以下。
O: Indicates that this toxic or hazardous substance contained in all of the homogeneous materials for this part is below the limit requirement in SJ/T11363 - 2006.

X: 表示该有毒有害物质至少在该部件的某一均质材料中的含量超出SJ/T11363 - 2006 标准规定的限量要求。
X: Indicates that this toxic or hazardous substance contained in at least one of the homogeneous materials used for this part is above the limit requirement in SJ/T11363 - 2006.



环保使用期限 Environmental Protection Use Period

此标识指期限（十年），电子信息产品中含有的有毒有害物质或元素在正常使用的条件下不会发生外泄或突变，用户使用该电子信息产品不会对环境造成严重污染或对其人身、财产造成严重损害的期限。

This logo refers to the period (10 years) during which the toxic or hazardous substances or elements contained in electronic information products will not leak or mutate so that the use of these [substances or elements] will not result in any severe environmental pollution, any bodily injury or damage to any assets.

电池标识 Battery labeling logo



环保使用期限 Environmental Protection Use Period

此标识指期限（五年），电池中含有的有毒有害物质或元素在正常使用的条件下不会发生外泄或突变，用户使用该电池产品不会对环境造成严重污染或对其人身、财产造成严重损害的期限。

This logo refers to the period (5 years) during which the toxic or hazardous substances or elements contained in the **battery** will not leak or mutate so that the use of these [substances or elements] will not result in any severe environmental pollution, any bodily injury or damage to any assets.

Contents

1	Important	4
	Safety and important notice	4
	Trademark notice	4
2	Your DVD player	5
	Playable media	5
	Product overview	5
3	Connect	7
	Connect audio/video cables	7
	Optional audio connections	8
	Connect USB flash drive	8
	Connect power	9
4	Get started	9
	Prepare the remote control	9
	Find the TV input channel	9
	Select a menu display language	9
	Turn on progressive scan	9
	Use Philips EasyLink	10
5	Play	10
	Play a disc	10
	Play video	10
	Play music	12
	Play photo	13
	Play from a USB flash drive	13
6	Other features	13
	Media copy	13
	Create MP3 files	14
	Karaoke	14
7	Adjust settings	15
	General setup	15
	Audio setup	16
	Video setup	17
	Preferences	18
8	Additional information	20
	Update software	20
	Care	20
	Specifications	20
9	Troubleshooting	21
10	Glossary	22

1 Important

Safety and important notice



Warning

- Risk of overheating! Never install the product in a confined space. Always leave a space of at least 4 inches around the product for ventilation. Ensure curtains or other objects never cover the ventilation slots on the product.
- Never place the product, remote control or batteries near naked flames or other heat sources, including direct sunlight.
- Avoid high temperature, moisture, water and dust.
- This unit must not be exposed to dripping or splashing.
- Never place any object or items that can damage this unit (e.g., liquid filled objects, lighted candles).
- Never place this product on other electrical equipment.
- Keep away from this product during lightning storms.
- Where the mains plug or an appliance coupler is used as the disconnect device, the disconnect device shall remain readily operable.
- Visible and invisible laser radiation when open. Avoid exposure to beam.

About Progressive Scan

Consumers should note that not all high definition television sets are fully compatible with this product and may cause artifacts to be displayed in the picture. In case of 525 or 625 progressive scan picture problems, it is recommended that the user switch the connection to the 'standard definition' output. If there are questions regarding our TV set compatibility with this model 525p and 625p DVD player, please contact our customer service center.

Disposal of your old product and batteries



Your product is designed and manufactured with high quality materials and components, which can be recycled and reused. Never dispose of your product with other household waste. Please inform yourself about the local rules on the separate collection of electrical and electronic products and batteries. The correct disposal of these products helps prevent potentially negative consequences on the environment and human health. Your product contains batteries, which cannot be disposed of with normal household waste. Please inform yourself about the local rules on separate collection of batteries. The correct disposal of batteries helps prevent potentially negative consequences on the environment and human health. Please visit www.recycle.philips.com for additional information on a recycling center in your area.

Copyright notice



Be responsible
Respect copyrights

This item incorporates copy protection technology that is protected by U.S. patents and other intellectual property rights of Rovi Corporation. Reverse engineering and disassembly are prohibited.



Trademark notice



HDMI, and HDMI logo and High-Definition Multimedia Interface are trademarks or registered trademarks of HDMI licensing LLC.



The USB-IF Logos are trademarks of Universal Serial Bus Implementers Forum, Inc.



Manufactured under license from Dolby Laboratories. Dolby and the double-D symbol are trademarks of Dolby Laboratories.



Manufactured under license under U.S. Patent #'s: 5,451,942; 5,956,674; 5,974,380; 5,978,762; 6,487,535 & other U.S. and worldwide patents issued & pending. DTS and the Symbol are registered trademarks & DTS Digital Surround and the DTS logos are trademarks of DTS, Inc. Product includes software. © DTS, Inc. All Rights Reserved.



ABOUT DIVX VIDEO: DivX® is a digital video format created by DivX, Inc. This is an official DivX Certified device that plays DivX video. Visit www.divx.com for more information and software tools to convert your files into DivX video.

ABOUT DIVX VIDEO-ON-DEMAND: This DivX Certified® device must be registered in order to play DivX Video-on-Demand (VOD) content. To generate the registration code, locate the DivX VOD section in the device setup menu. Go to vod.divx.com with this code to complete the registration process and learn more about DivX VOD. DivX®, DivX Certified® and associated logos are registered trademarks of DivX, Inc. and are used under license.



'DVD Video' is a trademark of DVD Format/Logo Licensing Corporation.



Windows Media and the Windows logo are trademarks, or registered trademarks of Microsoft Corporation in the United States and/or other countries.

2 Your DVD player

Congratulations on your purchase, and welcome to Philips! To fully benefit from the support that Philips offers, register your product at www.philips.com/welcome.

Playable media

This product can play:

- DVD, DVD-Video, DVD+R/+RW, DVD-R/-RW, DVD+R/-R DL (Dual Layer)
- Video CD/SVCD
- Audio CD, CD-R/CD-RW,
- MP3 media, WMA media, WMV media, DivX (Ultra) media, JPEG files
- USB flash drive

Region codes

You can play discs with the following region codes.

DVD region code	Countries
	China

Product overview

Main Unit

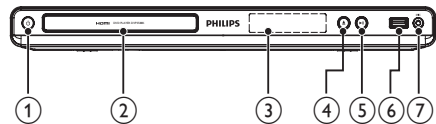

- ① **⏻ (Standby-On)**
 - Turn on the DVD player or switch to standby mode.
- ② **Disc compartment**
- ③ **Display panel**
- ④ **▲ (Open/Close)**
 - Open or close the disc compartment.
- ⑤ **▶|| (Play/Pause)**
 - Start, pause or resume disc play.
- ⑥ **↔ (USB) jack**
 - Connect a USB flash drive.
- ⑦ **MIC**
 - Connect a microphone.

Remote control

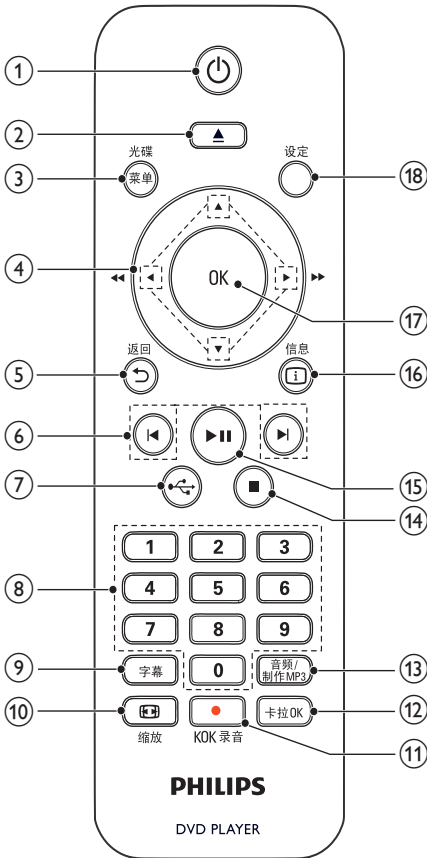

- ① 电源
- Turn on the unit or switch to standby.
- ② 光碟
- Open or close the disc compartment.
- ③ 光碟 / 菜单
- Access or exit the disc menu.
 - Switch to the disc mode.
 - During the play of a photo slideshow, switch between the Fun Mode and Simple Mode.
 - For VCD and SVCD, turn on or off PBC (playback control).

- ④ (Navigation buttons)
- Navigate the menus.
 - Search fast-forward () or fast-backward ().
 - Search slow-forward () or slow-backward ().
- ⑤ 返回
- Return to the previous display menu.
- ⑥ 跳
- Skip to the previous or next title, chapter, or track.
- ⑦ 切换
- Switch to the USB mode.
- ⑧ **Numeric buttons**
- Select an item to play.
- ⑨ 字幕
- Select a subtitle language on a disc.
 - Access the menu of copying/deleting audio files in a USB flash drive.
- ⑩ 缩放
- Fit the picture display to the TV screen.
 - Zoom the picture in or out.
- ⑪ KOK 录音
- Record the voice and music during karaoke into a USB flash drive.
- ⑫ 卡拉OK
- Access or exit the Karaoke setup menu.
- ⑬ 音频/制作MP3
- Select an audio language or channel on a disc.
 - Access the menu of creating MP3 files.
- ⑭ 停止
- Stop play.
- ⑮ 播放/暂停
- Start, pause or resume disc play.
- ⑯ 信息
- For discs, access the play options or display the current disc status.
 - For slideshows, display a thumbnail view of photo files.
- ⑰ OK
- Confirm an entry or selection.
- ⑱ 设定
- Access or exit the setup menu.

3 Connect

Make the following connections to use this product.

Basic connections:

- Video
- Audio

Optional connections:

- Route audio to other devices:
 - Digital amplifier/receiver
 - Analog stereo system
- USB flash drive

Connect audio/video cables

Select the best video connection that TV can support.

- **Option 1:** Connect to the HDMI jack (for a HDMI, DVI or HDCP-compliant TV).
- **Option 2:** Connect to the component video jacks (for a standard TV or Progressive Scan TV).
- **Option 3:** Connect to the composite video jack (for a standard TV).

Option 1: Connect to the HDMI jack

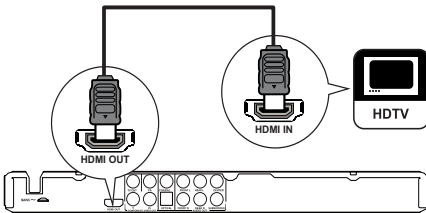

- 1 Connect an HDMI cable (not supplied) to
 - the **HDMI OUT** jack on this product.
 - the HDMI input jack on the TV.



Note

- If the device supports HDMI CEC, you can control compliant devices with a single remote control (see "Get started" > "Use Philips EasyLink").

Option 2: Connect to the component video jacks

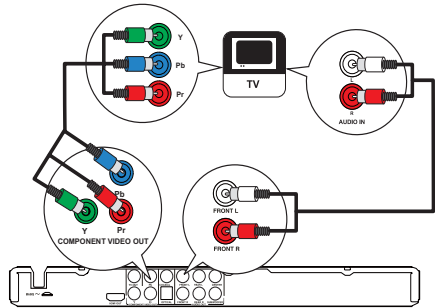

- 1 Connect the component video cables (not supplied) to:
 - the **Y Pb Pr** jacks on this product.
 - the **COMPONENT VIDEO** input jacks on the TV.
- 2 Connect the audio cables (supplied) to:
 - the **AUDIO OUT FRONT L/R** jacks on this product.
 - the audio input jacks on the TV.

Option 3: Connect to the video (CVBS) jack

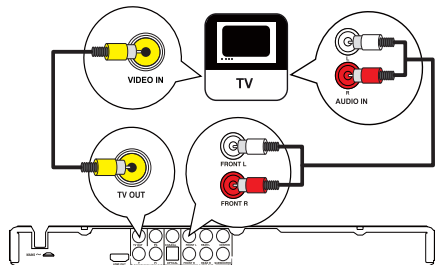

- 1 Connect a composite video cable (supplied) to:
 - the **TV OUT** jack on this product.
 - the video input jack on the TV.
- 2 Connect the audio cables (supplied) to:
 - the **AUDIO OUT FRONT L/R** jacks on this product.
 - the audio input jacks on the TV.

Optional audio connections

Connect the audio from this product to other devices to enhance sound.

Connect multi channel receiver

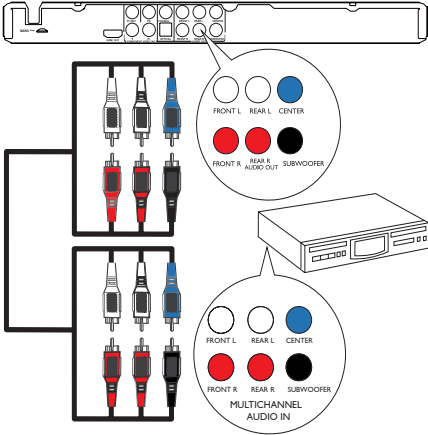

- 1 Connect the audio cables (not supplied) to:
 - the **AUDIO OUT (FRONT L/R, REAR L/R, CENTER and SUBWOOFER)** jacks on this product.
 - the audio input jacks on the device.

Connect to a digital AV amplifier/receiver

Connect to the COAXIAL jack

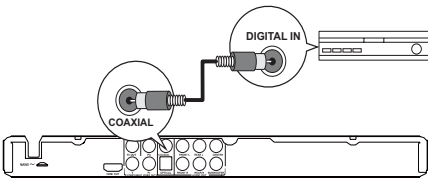

- 1 Connect a coaxial cable (not supplied) to:
 - the **COAXIAL** jack on this product.
 - the **COAXIAL/DIGITAL** input jack on the device.

Connect to the OPTICAL jack

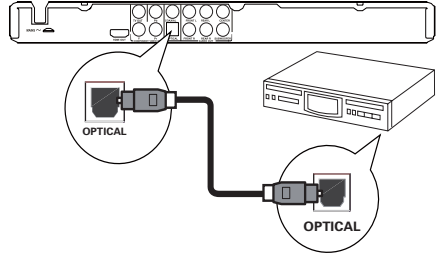

- 1 Connect an optical cable (not supplied) to:
 - the **OPTICAL** jack on this product.
 - the **OPTICAL/DIGITAL** input jack on the device.

Connect an analogue stereo system

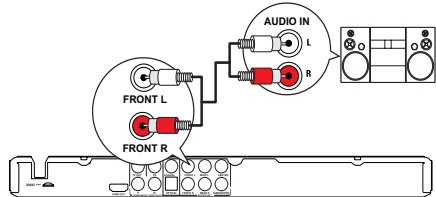

- 1 Connect the audio cables (supplied) to:
 - the **AUDIO OUT FRONT L/R** jacks on this product.
 - the audio input jacks on the TV.

Connect USB flash drive

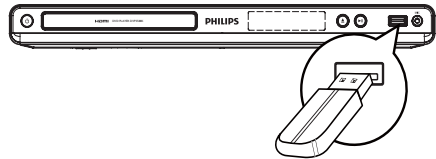

- 1 Connect a USB flash drive to the  jack on this product.

Note

- This product can only play/view MP3, WMA, WMV, DivX (Ultra) or JPEG files that are stored on a USB flash drive.
- Press the  button to access the content and play the files.

Connect power

! Caution

- Risk of product damage! Ensure that the power supply voltage corresponds to the voltage printed on the back of the product.
- Before connecting the AC power cord, ensure you have completed all other connections.

≡ Note

- The type plate is located on the back of the product.

- 1 Connect the AC power cable to the wall socket.
↳ The product is ready to be set up for use.

4 Get started

Prepare the remote control

- 1 Press and push the battery compartment to slide it open (see "1" in the illustration).
- 2 Insert two AAA batteries with correct polarity (+/-) as indicated.
- 3 Push and slide back the battery compartment (see "3" in the illustration).

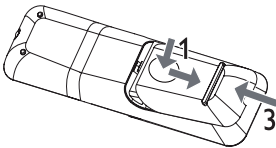

≡ Note

- If you are not going to use the remote control for a long time, remove the batteries.
- Do not mix batteries (old and new or carbon and alkaline, etc.).
- Batteries contain chemical substances, so they should be disposed of properly.

Find the TV input channel

- 1 Press \odot to turn on this product.
- 2 Turn on the TV and switch to the video input channel (refer to the TV user manual on how to select the A/V input channel).

Select a menu display language

≡ Note

- If this product is connected to a HDMI CEC compliant TV, skip this setting. It switches automatically to the same OSD menu language as per your TV setting (if the language set on TV is supported by this product).

General Setup		
	Disc Lock	<input type="radio"/> Auto (CHI)
	OSD Language	<input type="radio"/> English
	Sleep Timer	<input type="radio"/> 中文 (简体)
	Auto Standby	
	DivX(R) VOD Code	

- 1 Press 設定.
↳ [General Setup] menu is displayed.
- 2 Select [OSD Language], and then press ▶.
- 3 Press \blacktriangle to select a language, and then press OK.

Turn on progressive scan

≡ Note

- To use the progressive scan feature, you must connect a progressive scan TV with the component video jacks (see "Connect" > "Connect audio/video cables" > "Option 2: Connect to the component video jacks" for details).

Video Setup		
	TV System	<input type="radio"/> On
	TV Display	<input type="radio"/> Off
	Progressive	
	Picture Setting	
	My Wallpaper	
	HD JPEG	
	HDMI Setup	

- 1 Turn on the TV to the correct video input channel for this product.
- 2 Press 設定.
- 3 Press \blacktriangledown to select [Video Setup].

- 4 Select **[Progressive]** > **[On]**, and then press **OK**.
↳ A warning message is displayed.
- 5 To proceed, select **[Ok]** and then press **OK**.
↳ The progressive setup is complete.

Note

- If a blank/distorted screen is displayed, wait for 15 seconds for the auto recovery.
- If no picture is displayed, turn off the progressive scan mode as follows:
 - 1) Press **▲** to open the disc compartment.
 - 2) Press the **Numeric button '1'**.

- 6 Press **設定** to exit the menu.
- 7 You can now turn on the progressive scan mode on the TV (see the TV user manual).

Note

- During play, when the progressive scan mode is on for both this product and the TV, distorted picture may display. In this case, turn off the progressive scan feature on both this product and the TV.

Use Philips EasyLink

This product supports Philips EasyLink which uses the HDMI CEC (Consumer Electronics Control) protocol. You can use one single remote control to control EasyLink-compliant devices that are connected through HDMI connectors.

Note

- To enable the EasyLink feature, you must turn on the HDMI CEC operations on the TV and on other devices connected to TV. Refer to the TVs/devices manual for details.

One-touch play

- 1 Press **⏻** to turn on this product.
↳ The TV (if supports one-touch play) automatically turns on and switches to the correct video-in channel.
↳ If a disc is loaded in this product, disc play automatically starts.

One-touch standby

- 1 Press and hold **⏻** on the remote control for more than 3 seconds.
↳ All the connected devices (if the device supports one-touch standby) automatically switch to standby.

Note

- Philips does not guarantee 100% interoperability with all HDMI CEC devices.

5 Play

Play a disc

! Caution

- Do not place any objects other than discs into the disc compartment.
- Do not touch the disc optical lens inside the disc compartment.

- 1 Press **▲** to open the disc compartment.
- 2 Insert a disc with its label facing up.
- 3 Press **▲** to close the disc compartment and start disc play.

Note

- Check the types of discs supported (see "Your DVD player" > "Playable media").
- If the password entry menu is displayed, enter the password before you can play the locked or restricted disc (see "Adjust settings" > "Preferences" > **[Parental Control]**).

Play video

Note

- Some operations may not work with some discs. See the information accompanying the disc for details.

Control video play

- 1 Play a title.
- 2 Use the remote control to control the play.

Button	Action
	Start, pause or resume disc play.
	Stop disc play.
	Skip to a previous/next title or chapter.
	Search fast-backward or fast-forward. Press repeatedly to change the search speed.
	Search slow-forward or slow-backward. Press repeatedly to change the search speed. For VCD/SVCD, slow-backward search is not available.
音频/制作MP3	Select an audio language or channel available on a disc.
字幕	Select a subtitle language available on a disc.
缩放 (Screen fit)	Fit the picture format to the TV screen. Press repeatedly until the image is scaled to fit to the TV screen.
缩放	Toggle between screen aspect ratio and different zoom factor. To pan through the zoomed image, press the Navigation buttons.
信息	Access the play options and display the current disc status.

Access DVD menu

- 1 Press **光碟/菜单** to access the disc root menu.
- 2 Select a play option, then press **OK**.
 - In some menus, press the **Numeric buttons** to input your selection.

Access VCD menu

The PBC (playback control) feature is available for VCD/SVCD, which can display the contents menu for you to select a play option. The PBC is on by default in the factory.

Note

- See "Adjust settings" > "Preferences" > **[PBC]** on how to turn PBC on or off.

- 1 Display the contents menu via one of the following ways:
 - If PBC is on, load in a VCD/SVCD.
 - During play with PBC on, press **返回**.

- 2 Press the **Numeric buttons** to select a play option, and then press **OK** to start play.
 - If PBC is turned off, it skips the menu display and starts play from the first track.

Preview disc contents

- 1 During play, press **信息**.
 - ↳ The disc status menu is displayed.
- 2 Select **[Preview]**, and then press **▶**.
- 3 Select a preview option, and then press **OK**.
 - ↳ A thumbnails preview screen is displayed.
 - To go to the next/previous preview screen, select **[Prev]** or **[Next]**, and then press **OK**.
 - To start play, press **OK** at the selected thumbnail picture.

Skip play to a specific time

- 1 During play, press **信息**.
 - ↳ The disc status menu is displayed.
- 2 Select an option for the current elapsed playing time, and then press **▶**.
 - **[TT Time]** (title time)
 - **[CH Time]** (chapter time)
 - **[Disc Time]**
 - **[Track Time]**
- 3 Press the **Numeric buttons** to enter the time to skip to, then press **OK**.

Display play time

- 1 During play, press **信息**.
 - ↳ The disc status menu is displayed.
- 2 Select **[Time Disp.]**, and then press **▶**.
 - ↳ The display options vary from disc type.
- 3 Select an option, and then press **OK**.

View DVD play from different angles

- 1 During play, press **信息**.
 - ↳ The disc status menu is displayed.
- 2 Select **[Angle]**, and then press **▶**.
- 3 Press the **Numeric buttons** to change the angle.
 - ↳ Play changes to the selected angle.

Note

- Applicable only to discs that contain multi-angle scenes.

Repeat play for a specific section

- 1 During play, press 信息.
- 2 Press to select [REPEAT AB].
- 3 Press **OK** to set the start point.
- 4 Press **OK** to set the end point.
 - ↳ Repeat play starts.
 - To cancel repeat play, press **OK** again.

Note

- The marked section for repeat play is only possible within a track/title.

Play DivX® (Ultra) video

DivX® (Ultra) video is a digital media format that retains high quality despite a high rate of compression. You can enjoy DivX® (Ultra) video on this DivX (Ultra) certified product.

- 1 Insert a disc or USB flash drive that contains the DivX (Ultra) videos.
 - For USB, press .
 - ↳ A contents menu is displayed.
- 2 Select a title to play, then press **OK**.
 - You may select subtitle/audio language.

Note

- You can only play DivX (Ultra) video that is rented or purchased with the DivX registration code of this product (see "Adjust Settings" > "General setup" > [DivX(R) VOD Code]).

Play music

Control a track

- 1 Play a track.
- 2 Use the remote control to control the play.

Button	Action
	Start, pause or resume disc play.
	Stop disc play.
	Skip to a previous/next track.
	Select an item to play.

Searches fast-backward or fast-forward. Press repeatedly to change the search speed.

Quick skip play

This feature is only available for audio CDs.

- 1 During play, press 信息 repeatedly to select an option.

Display	Action
[Disc Go To]	Skip play to a specific time within the disc.
[Track Go To]	Skip play to a specific time within a track.
[Select Track]	Skip play to a specific track number.

- 2 Press the **numeric buttons** to change the time/number to skip to.

Play MP3/WMA music

MP3/WMA is a type of highly compressed audio file (files with .mp3, .wma extensions).

- 1 Insert a disc or USB flash drive that contains the MP3/WMA music.
 - For USB, press .
 - ↳ A contents menu is displayed.
- 2 If play does not automatically start, select a track to play.
 - To select another track/folder, press , then press **OK**.

Note

- For disc recorded in multiple sessions, only the first session is played.
- For a WMA file that is protected by Digital Rights Management (DRM), it cannot be played on this product.
- This product does not support MP3PRO audio format.
- For any special character that is present in the MP3 track name (ID3) or album name, it might not be displayed correctly on the screen because these characters are not supported.
- Folders/files that exceed the supported limit of this product cannot be displayed or played.

Repeat play for a specific section

For audio CDs,

- 1 During play, press 信息 repeatedly until [Off] is displayed.
- 2 Press to select a repeat option.

For MP3/WMA files,

- 1 During play, press 信息 repeatedly to select a repeat option.

Play photo

Play photo as slideshow

You can play JPEG photos (files with .jpeg or .jpg extensions).

- 1 Insert a disc or USB flash drive that contains the JPEG photos.
 - For USB, press .
 - ↳ Slideshow begins (for Kodak disc), or a contents menu (for JPEG disc) is displayed.
- 2 Select a photo, and then press **OK** to start slideshow.
 - ↳ For a photo recorded with the "exif" format, the display orientation is automatically optimized.
- To display photos in color (Fun Mode) or in black and white (Simple Mode), press **光碟 / 菜单**.
- To preview the photos in thumbnail, press **信息**.
 - To select a photo, press the **Navigation buttons**.
 - To enlarge the selected photo and start slideshow, press **OK**.
 - To return to the menu, press .

Note

- It may require longer time to display the disc content on the TV due to the large number of songs/photos compiled onto one disc/USB flash drive.
- If the JPEG photo is not recorded with an 'exif' type file, the actual thumbnail picture cannot be shown on the screen. It is replaced by a 'blue mountain' thumbnail picture.
- This product can only display digital camera pictures according to the JPEG-EXIF format, typically used by almost all digital cameras. It cannot display Motion JPEG, or pictures in formats other than JPEG, or sound clips associated with pictures.
- Folders/files that exceed the supported limit of this product cannot be displayed or played.

Control photo play

- 1 Play a photo slideshow.
- 2 Use the remote control to control the play.

Button	Action
	Rotate a photo anti-clockwise/clockwise.
	Rotate a photo horizontally/vertically.
	Zoom in or out of a photo. Play pauses in zoom mode.
	Stop a play.

Play musical slideshow

Create a musical slideshow to play MP3/WMA music files and JPEG photo files simultaneously.

Note

- To create a musical slideshow, you must store the MP3/WMA and JPEG files on the same disc/USB flash drive.

- 1 Play MP3/WMA music.
- 2 Press to return to the main menu.
- 3 Navigate to the photo folder/album and press **OK** to start slideshow play.
 - ↳ Slideshow begins and continues till the end of the photo folder or album.
 - ↳ Audio continues to play until the end of the disc.
 - To stop slideshow play, press **■**.
 - To stop music play, press **■** again.

Play from a USB flash drive

Note

- This product plays/views MP3, WMA, WMV, DivX (Ultra) or JPEG files that are stored on a USB flash drive.

- 1 Connect a USB flash drive to the jack on this product.
- 2 Press the button.
 - ↳ A contents menu is displayed.
- 3 If play does not start automatically, select a file to play.
 - For more information, see the chapters "Play music", "Play photo" and "Play video" for details.
- 4 To stop play, press **■**.
 - To switch to the disc mode, press the button.

6 Other features

Media copy

You can copy files (such as MP3, WMA or JPEG) from disc to a USB flash drive.

- 1 Insert a disc that contains the MP3/WMA/JPEG files.
- 2 In the stop mode, connect the USB flash drive to the jack on this product.
- 3 Select a file to copy, and then press **字幕**.

4 Select **[Yes]** in the menu, then press **OK**.

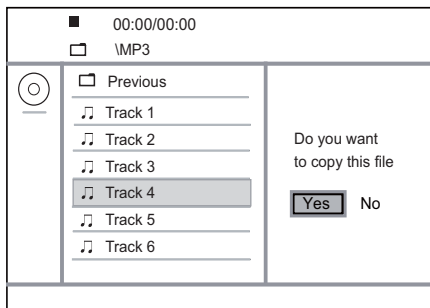

↳ Once complete, a new folder is created automatically in the USB flash drive to store all the new files.

5 To stop copy progress, press **■**, then press **OK**.

Note

- When you copy, never press any button.
- Copy-protected media cannot be copied.

Create MP3 files

With this product, you can convert audio CDs into MP3 audio files. The created MP3 audio files are saved in the USB flash drive.

- 1 Insert an audio CD.
- 2 Connect a USB flash drive to the jack on this product.
- 3 During disc play, press 音频/制作MP3.
 - ↳ The MP3 creation menu is displayed.
- 4 Select **[Yes]** in the menu, and then press **OK**.

OPTIONS		TRACK	
Speed	Normal	<input type="radio"/> Track01	04:14
Bitrate	128kbps	<input type="radio"/> Track02	04:17
CRT ID3	Yes	<input type="radio"/> Track03	03:58
Device	USB 1	<input type="radio"/> Track04	04:51
SUMMARY		<input type="radio"/> Track05	03:53
Press [OK] button to change speed.		<input type="radio"/> Track06	04:09
		<input type="radio"/> Track07	04:38
Start	Exit	Select all	Deselect all

5 Select a conversion option in the **[OPTIONS]** panel, and then press **OK** repeatedly to select an item.

Option	Description
[Speed]	Select a copying speed.
[Bitrate]	Select a quality level. Higher bitrate for better sound quality and bigger file size.
[CRT ID3]	Copy track information into the MP3 file.
[Device]	The created files can only be saved in a USB flash drive.

6 Press **▶** to access the **[TRACK]** panel.

7 Select an audio track, and then press **OK**.

- To select another track, repeat step 7.
- To select all tracks, select **[Select all]** in the menu, and press **OK**.
- To deselect all tracks, select **[Deselect all]** in the menu, and press **OK**.

8 Select **[Start]** in the menu, and then press **OK** to start to convert.

↳ Once complete, a new folder is created automatically in the USB flash drive to store all the new MP3 files.

- To exit the menu, select **[Exit]**, and then press **OK**.

Note

- When you convert, never press any button.
- DTS CDs and copy-protected CDs cannot be converted.
- Writer-protected or password-protected USB flash drives cannot be used to store MP3 files.

Karaoke

You can connect a microphone (not supplied) to sing along with a music source.

Note

- Before you connect a microphone, set the microphone volume to the minimum to prevent howling.

- 1 Turn on the TV, and select the TV input channel.
- 2 Connect a microphone to the **MIC** jack on this product.
- 3 Turn on the microphone sound output (see "Adjust Karaoke settings").

- 4 Play a Karaoke disc and sing through the microphone.

Adjust Karaoke settings

Note

- You need to turn on the microphone sound output in the **[Microphone]** option to activate karaoke-related menu options.

- 1 Press **卡拉OK**.
↳ The karaoke settings menu is displayed.
- 2 Select an option, and then press **OK**.
- 3 Change or set a setting, and then press **OK**.
- 4 Press **卡拉OK** again to exit the menu.

[Microphone] - Turn on or off the microphone sound output.

[MIC Volume] - Adjust the microphone volume.

[Echo] - Adjust the echo level.

[Karaoke Scoring] - Turn off the function of Karaoke scoring or select a scoring level (basic/intermediate/advance). If a level is selected, the score is displayed after each song ends.

[Karaoke Idol] - Song contest among 4 singers.

- 1) In the **[Karaoke Scoring]** option, select a level (basic/intermediate/advance).
- 2) In the **[Karaoke Idol]** option, turn on the contest.
↳ The song selection menu is displayed.
- 3) Input a track (VCD/SVCD) or a title/chapter (DVD) as the first song. Up to 4 songs can be selected.
- 4) Then select **[Start]**, and press **OK** to start play selected songs.
↳ After all the selected songs end, a contest result is displayed.

[Key Shift] - Adjust the pitch level that matches your voice.

[Vocal] - Select various Karaoke audio modes, or turn off original vocal.

Record Karaoke

You can record your singing into a USB flash drive. Each time you can record one song, and all the recorded songs are saved in .mp3 format. At the first time when you record to a USB flash drive, a folder named "PHILIPS" is automatically created to save the recorded files.

Note

- This product supports recording to MAS USB devices (MTP/NAS devices are excluded).





- 1 During Karaoke, press **● KOK 录音** to display the record menu:
[Start at current time] - start recording immediately.
[Start from beginning] - start recording from the beginning of the current song.
 - To exit without recording, press again **● KOK 录音**.
- 2 Press **▲▼** to select an option, and press **OK**.
 - ↳ The recording begins, and a recording progress bar is displayed.
 - ↳ When the current song ends, the recording completes and stops.
 - ↳ During recording, you may press **● KOK 录音** and follow the on-screen instructions to stop the recording.

7 Adjust settings

Note

- If the setup option is grayed out, it means the setting cannot be changed at the current state.

General setup

General Setup	
	Disc Lock _____
	OSD Language _____
	Sleep Timer _____
	Auto Standby _____
	DivX(R) VOD Code _____
	_____

- 1 Press **设定**.
↳ **[General Setup]** menu is displayed.
- 2 Press **▶** to enter the submenu.
- 3 Select an option, and then press **OK**.
- 4 Select a setting, and then press **OK**.
 - To return to the previous menu, press **↶ 返回**.
 - To exit the menu, press **设定**.

[Disc Lock]

Set the play restriction for a disc which is loaded in the disc compartment (maximum 20 discs can be locked).

- **[Lock]** - Restrict the access to the current disc. At the next time when you want to play this disc or unlock it, you need to enter the password.
- **[Unlock]** - Play all discs.

[OSD Language]

Select a language for on-screen menu.

[Sleep Timer]

Switch automatically to standby at the preset time.

- **[Off]** - Disable sleep mode.
- **[15 Mins], [30 Mins], [45 Mins], [60 Mins]** - Select the countdown time for this product to switch to standby.

[Auto Standby]

Turn on/off the auto standby mode.

- **[On]** - Switch to standby after 15 minutes of inactivity (for example, in pause or stop mode).
- **[Off]** - Disable the auto standby mode.

[DivX(R) VOD Code]

Display the DivX® registration code and deregistration code.

- **[Registration]** - Obtain a registration code to register this product on website.
- **[Deregistration]** - Obtain a deregistration code to cancel the registration of this product on website.



Note

- Use this product's DivX registration code when you rent or purchase video from www.divx.com/vod. The DivX videos rented or purchased through the DivX® VOD (Video On Demand) service can be played only on the device to which it is registered.

Audio setup

Audio Setup		
	Analogue Output	_____
	Digital Audio	_____
	HDMI Audio	_____
	Audio Sync	_____
	Volume	_____
	Sound Mode	_____
	Speaker Setup	_____
	CD Upsampling	_____

- 1 Press **設定**.
↳ **[General Setup]** menu is displayed.
- 2 Press **▼** to select **[Audio Setup]**, and then press **▶** to enter the submenu.
- 3 Select an option, and then press **OK**.
- 4 Select a setting, and then press **OK**.
 - To return to the previous menu, press **↶** 返回.
 - To exit the menu, press **設定**.

[Analogue Output]

Select an analogue setting based on the audio device that is connected through the analogue audio jack.

- **[LT/RT]** - For the surround sound output through two speakers.
- **[Stereo]** - For the stereo output.
- **[Multi Channel]** - For multi-channel output.

[Digital Audio]

Select a digital setting based on the digital amplifier/receiver that is connected through the digital jack (coaxial/digital).

- **[Digital Output]** - Select a type of digital output.
 - **[All]** - Support multi-channel audio formats.
 - **[Off]** - Disable digital output.
 - **[PCM Only]** - Downmix to two-channel audio format.
- **[LPCM Output]** - Select the LPCM (Linear Pulse Code Modulation) output sampling rate.
 - **[48kHz]** - For discs recorded at sampling rate of 48 kHz.
 - **[96kHz]** - For discs recorded at sampling rate of 96 kHz.



Note

- **[LPCM Output]** setting is only available if the **[Digital Output]** is set to **[PCM Only]**.
- The higher the sampling rate, the better the sound quality.

[HDMI Audio]

Select the HDMI audio setting when you connect this product and the TV with an HDMI cable.

- **[On]** - Allow audio output through the TV and the speaker system. If the audio format on the disc is not supported, it will be downmixed to two-channel sound (linear-PCM).
- **[Off]** - Disable the audio output from HDMI devices connected to this player.

[Audio Sync]

Set the delay time for audio output when you play a video disc.

1. Press **OK**.
2. Press **◀▶** to set the delay time.
3. Press **OK** to confirm and exit.

[Volume]

Set the default volume level when you play a disc.

1. Press **OK**.
2. Press **◀▶** to set the volume.
3. Press **OK** to confirm and exit.

[Sound Mode]

Select a preset sound effect to enhance the audio output.

- **[3D]** - Select a virtual surround sound effect that is produced from the left and right audio channels.
- **[Movie Mode]** - Select a sound effect for movies.
- **[Music Mode]** - Select a sound effect for music.

[Speaker Setup]

Optimize the surround output for the connected speakers.

[CD Upsampling]

For better sound quality in stereo mode, convert the music CD to a higher sampling rate.

- **[Off]** - Turn off CD-upsampling.
- **[88.2kHz]** - Convert to twice the original sampling rate.
- **[176.4kHz]** - Convert to four times the original sampling rate.

[Night Mode]





Make loud sound level softer and soft sound level louder so that you can watch the DVD movies at a low volume, without disturbing others.

- **[On]** - Enjoy quiet viewing at night.
- **[Off]** - Enjoy surround sound with a full dynamic range.

Note

- Applicable only to Dolby Digital encoded DVDs.

Video setup

Video Setup	
	TV System
	TV Display
	Progressive
	Picture Setting
	My Wallpaper
	HD JPEG
	HDMI Setup

- 1 Press 設定.
↳ **[General Setup]** menu is displayed.
- 2 Press ▼ to select **[Video Setup]**, and then press ▶ to enter the submenu.
- 3 Select an option, and then press **OK**.
- 4 Select a setting, and then press **OK**.
 - To return to the previous menu, press 返回.
 - To exit the menu, press 設定.

[TV System]

Change this setting if the video does not appear correctly. By default, this setting matches the most common setting for TVs in your country.

- **[PAL]** - For a PAL-system TV.
- **[Multi]** - For TV that is compatible with both PAL and NTSC.
- **[NTSC]** - For an NTSC-system TV.

[TV Display]

Select a display format:



4:3 Pan Scan (PS)



4:3 Letter Box (LB)



16:9 (Wide Screen)

- **[4:3 Pan Scan]** - For a 4:3 screen TV: full-height display with the trimmed sides.
- **[4:3 Letter Box]** - For a 4:3 screen TV: wide-screen display with black bars on the top and bottom of the screen.
- **[16:9]** - For a wide-screen TV: display ratio 16:9.

[Progressive]

If a progressive scan TV is connected to this product, turn on the progressive scan mode.

- **[On]** - Turn on progressive scan.
- **[Off]** - Turn off progressive scan mode.

Note

- For more detailed description, see "Get started" > "Turn on progressive scan".

[Picture Setting]

Select a predefined set of picture color settings or customize the personal setting.

- **[Standard]** - Original color setting.
- **[Bright]** - Vibrant color setting.
- **[Soft]** - Warm color setting.
- **[Personal]** - Customize the color setting. Set the level of brightness, contrast, sharpness and color saturation, and then press **OK**.

[My Wallpaper]

Select a picture as the wallpaper.

- **[Default picture]** - The default wallpaper preset as the Philips logo.
- **[Saved picture]** - A captured video image or JPEG photo.
- **[Current picture]** - Capture a video image or JPEG photo and save it on the product.

1. Play a video or photo slideshow.
2. Select a video image or photo: press **▶||** to pause, and then press **设定**.
3. Navigate to the option (**[Video Setup]** > **[My Wallpaper]** > **[Current picture]**).
4. Press **OK** to confirm.
 - ↳ One video image or JPEG photo is saved as wallpaper.
 - ↳ A newly saved image or photo replaces the earlier one.

[HD JPEG]

Enjoy untouched and uncompressed JPEG pictures at its original resolution when you connect this product and the TV with an HDMI cable.

- **[On]** - Display high definition picture.
- **[Off]** - Display standard picture.

[HDMI Setup]

When you connect this product and the TV with an HDMI cable, select the best HDMI setup that the TV can support.

- **[Resolution]** - Select a video resolution that is compatible with the TV display capability.
 - **[Auto]** - Detect and select the best supported video resolution automatically.
 - **[480i], [480p], [576i], [576p], [720p], [1080i], [1080p]** - Select a video resolution that is best supported by the TV. See the TV manual for details.
- **[Wide Screen Format]** - Define the wide screen format for disc play.

- **[Super Wide]** - Center position of the screen is stretched less than the side (applicable only when the video resolution is set to 720p, 1080i or 1080p).
- **[4:3 Pillar Box]** - No stretching of picture. Black bars are displayed on both sides of the screen (applicable only when the video resolution is set to 720p, 1080i or 1080p).
- **[Off]** - Picture is displayed according to the disc format.
- **[EasyLink Setup]** - If this product is connected to HDMI CEC compliant TV/devices, all connected devices can respond to the following commands simultaneously.
 - **[EasyLink]** - Turn on/off all EasyLink features.
 - **[One Touch Play]** - Turn on or off the feature of one-touch play.

When EasyLink is enabled, press **⓪**.

 - ↳ This product turns on.
 - ↳ The TV (if the TV supports one-touch play) automatically turns on and switches to the video-in channel.
 - ↳ Disc play starts if there is a disc in this product.
 - **[One Touch Standby]** - Turn on or off the feature of one-touch standby.

When EasyLink is enabled, press and hold **⓪** for at least three seconds.

 - ↳ All connected HDMI CEC compliant devices switch to standby mode.









Note

- You must turn on the HDMI CEC operations on the TV/devices before you can enjoy the EasyLink controls. See the TV/devices manual for details.
- Philips does not guarantee 100% interoperability with all HDMI CEC compliant devices.

Preferences

Note

- Stop disc play before you can access to **[Preferences]**.

Preferences	
	Audio
	Subtitle
	Disc Menu
	Parental Control
	PBC
	Mp3/Jpeg Nav
	Password
	DivX Subtitle

- 1 Press **设定**.
↳ **[General Setup]** menu is displayed.
- 2 Press **▼** to select **[Preferences]**, and then press **▶** to enter the submenu.
- 3 Select an option, and then press **OK**.
- 4 Select a setting, and then press **OK**.
 - To return to the previous menu, press **↶** **返回**.
 - To exit the menu, press **设定**.

[Audio]

Select an audio language for disc play.

[Subtitle]

Select a subtitle language for disc play.

[Disc Menu]

Select a disc menu language.

Note

- If the language you have set is not available on the disc, the disc uses its own default language.
- For some DVDs, the subtitle/audio language can only change from the disc menu.
- To select the languages that are not listed in the menu, select **[Others]**. Then check the "Language Code" list at the back of this user manual and enter the respective language code.

[Parental Control]

Restrict access to discs that are unsuitable for children. These types of discs must be recorded with ratings.

1. Press **OK**.
2. Select a rating level, then press **OK**.
3. Press the **numeric buttons** to enter the password.

Note

- Rated DVDs above the level you set in **[Parental Control]** require a password to be played.
- The ratings are country-dependent. To allow all discs to play, select **'8'**.
- Some discs have ratings printed on them but are not recorded with ratings. This function has no effect on such discs.

[PBC]

Turn on or off the content menu of VCDs/SVCDs with PBC (playback control) feature.

- **[On]** - Display the index menu when you load a disc for play.
- **[Off]** - Skip the menu and start play from the first track.

[Mp3/Jpeg Nav]

Select to display the folders or display all the files.

- **[View Files]** - Display all the files.
- **[View Folders]** - Display the folders of MP3/WMA files.

[Password]

Set or change the password for locked discs and play restricted DVDs.

Preferences Change Password	
Old Password	<input type="text"/>
New Password	<input type="text"/>
Confirm PWD	<input type="text"/>
<input type="button" value="OK"/>	

1. Press the **Numeric buttons** to enter '136900' or the last set password at **[Old Password]** field.
2. Enter the new password at **[New Password]** field.
3. Enter the new password again at **[Confirm PWD]** field.
4. Press **OK** to exit the menu.

Note

- If you forget the password, enter '136900' before you set a new password.

[DivX Subtitle]

Select a character set that supports the DivX subtitle.

- **[中文 (简体)]** - Simplified Chinese

Note

- Ensure that the subtitle file has the exact same file name as the movie file. If for example the file name of the movie is 'Movie.avi', then you need to name the text file 'Movie.sub' or 'Movie.srt'.

[Version Info]

Display the software version of this product.

Note

- This information is required when you want to find out if a newest software version is available at the Philips website that you may download and install on this product.

[Default]

Reset all the settings of this product to factory default, except for **[Disc Lock]**, **[Parental Control]** and **[Password]** settings.

8 Additional information

Update software

For software updates, check the current software version of this product to compare with the latest software (if available) at the Philips website.

Caution

- Power supply must not be interrupted during software upgrade.

- 1 Press **设定**.
- 2 Select **[Preferences]** > **[Version Info]**, and then press **OK**.
- 3 Write down the file name, and then press **设定** to exit the menu.
- 4 Visit www.philips.com/support to check for the latest software version, using the file name for this product.
- 5 Refer to the upgrade instructions on the website for more information.

Note

- Disconnect the power cord for a few seconds and connect again to turn on the product.

Care

Caution

- Never use solvents such as benzene, thinner, cleaners available commercially, or anti-static sprays intended for discs.

Clean discs

Wipe the disc with a micro fibre cleaning cloth from the centre to the edge in a straight line movement.

Specifications

Note

- Specification and design are subject to change without notice

USB

- Compatibility: Hi-Speed USB (2.0)
- Class support: UMS (USB Mass Storage Class)

Video

- Signal system: PAL / NTSC
- Composite video output: 1 Vpp ~ 75 ohm
- Component video output: 0.7 Vpp ~ 75 ohm
- HDMI output: 480i, 480p, 576i, 576p, 720p, 1080i, 1080p

Audio

- Analog stereo output
- Signal to noise ratio (1 kHz): > 90 dB (A-weighted)
- Dynamic Range (1 kHz): > 80 dB (A-weighted)
- Crosstalk (1 kHz): > 90 dB
- Distortion/noise: (1 kHz): > 75 dB
- MP3: MPEG Audio L3
 - Digital output
 - Optical, Coaxial
- HDMI output

Main unit

- Dimensions (w x h x d): 360 x 39 x 209 (mm)
- Net Weight: approximately 1.49 kg

Power

- Power supply rating: 110-240V, 50/60HZ
- Power consumption: < 10 W
- Power consumption in standby mode: < 0.1 W

Accessories supplied

- Remote control and batteries
- Audio/Video cables
- User Manual
- Quick Start Guide

Laser specification

- Type: Semiconductor laser InGaAlP (DVD), AlGaAs (CD)

- Wave length: 655 nm (DVD), 790 nm (CD)
- Output Power: 7.0 mW (DVD), 10.0 mW (VCD/CD)
- Beam divergence: 60 degrees

9 Troubleshooting



Warning

- Risk of electric shock. Never remove the casing of the product.

To keep the warranty valid, never try to repair the product yourself.

If you have problems using this product, check the following points before you request service. If you still have a problem, register your product and get support at www.philips.com/welcome.

If you contact Philips, you will be asked for the model and serial number of your product. The model number and serial number are on the back of your product. Write the numbers here:

Model No. _____

Serial No. _____

Main unit

The buttons on this unit do not work.

- Disconnect this product from the power outlet for a few minutes, then connect again.

No reaction to the remote control.

- Connect this product to the power outlet.
- Point the remote control at the IR sensor located on the front panel of this product.
- Insert the batteries correctly.
- Insert new batteries in the remote control.

Picture

No picture.

- See the TV's user manual on how to select the correct input on the TV. Change the TV channel until you see the Philips screen.
- If you have turned on the progressive scan setting or change the TV system setting, switch back to default mode: 1) Press **▲** to open the disc compartment. 2) Press the **Numeric button '1'** (for progressive scan) or the **Numeric button '3'** (for TV system).

No picture on HDMI connection.

- If this product is connected to an unauthorized display device with an HDMI cable, the audio/video signal may not be output.

- Check if the HDMI cable is faulty. Replace a new HDMI cable.
- If this happens when you change the HDMI video resolution, you have to switch to its default mode: 1) Press **▲** to open the disc compartment. 2) Press the **numeric button "1"**.

Sound

No audio output from the TV.

- Ensure that the audio cables are connected to the audio input of the TV.
- Assign the audio input of the TV to the corresponding video input. See the TV user manual for details.

No audio output from the loudspeakers of the audio device (stereo system/amplifier/receiver).

- Ensure that the audio cables are connected to the audio input of the audio device.
- Turn on the audio device to its correct audio input source.

No sound on HDMI connection.

- You may not hear any sound from the HDMI output if the connected device is non-HDCP compliant or only DVI-compatible.
- Ensure that the **[HDMI Audio]** setting is turned on.

No sound during DivX video playback.

- The audio codec may not be supported by this product.

Play

The disc cannot be played.

- The disc is badly scratched, deformed, or dirty. Replace or clean the disc.
- Use the correct disc format or file format.

DivX video files cannot be played.

- Ensure that the DivX video file is complete.
- Ensure that the file name extension is correct.
- Due to Digital Rights issue, the DRM-protected video files cannot be played through an analog video connection (e.g. composite, component and start). Use an HDMI connection to play these files.

The aspect ratio of the screen is not aligned with the TV display setting.

- The aspect ratio is fixed on the disc.

DivX subtitles are not displayed correctly.

- Ensure that the subtitle file name is the same as the movie file name.
- Select the correct character set.
 - Press **設定**.
 - Select **[Preferences] > [DivX Subtitle]** in the menu.
 - Select the character set that supports the subtitle.

10 Glossary

A

Aspect ratio

Aspect ratio refers to the length to height ratio of TV screens. The ratio of a standard TV is 4:3, while the ratio of a high-definition or wide TV is 16:9.

The letter box allows you to enjoy a picture with a wider perspective on a standard 4:3 screen.

D

DivX Video-On-Demand

This DivX Certified[®] device must be registered in order to play DivX Video-on-Demand (VOD) content. To generate the registration code, locate the DivX VOD section in your device setup menu. Go to vod.divx.com with this code to complete the registration process and learn more about DivX video.

H

HDMI

High-Definition Multimedia Interface is a high-speed digital interface that can transmit uncompressed high definition video and digital multichannel audio. It delivers high quality picture and sound quality, completely free from noise. HDMI is fully backward-compatible with DVI.

As required by the HDMI standard, connecting to HDMI or DVI products without HDCP (High-bandwidth Digital Content Protection) will result in no Video or Audio output.

J

JPEG

A very common digital still picture format. A still-picture data compression system proposed by the Joint Photographic Expert Group, which features small decrease in image quality in spite of its high compression ratio. Files are recognized by their file extension '.jpg' or '.jpeg'.

M

MP3

A file format with a sound data compression system. MP3 is the abbreviation of Motion Picture Experts Group 1 (or MPEG-1) Audio Layer 3. With the MP3 format, one CD-R or CD-RW can contain about 10 times more data than a regular CD.

P

PBC

Playback Control. A system where you navigate through a Video CD/Super VCD with on-screen menus that are recorded onto the disc. You can enjoy interactive playback and search.

Progressive scan

The progressive scan displays twice the number of frames per second than in an ordinary TV system. It offers higher picture resolution and quality.

W

WMA

Windows Media™ Audio. Refers to an audio compression technology developed by Microsoft Corporation. WMA data can be encoded with Windows Media player version 9 or Windows Media player for Windows XP. Files are recognized by their file extension '.wma.'

WMV [Windows Media Video]

Refers to a video compression technology developed by Microsoft Corporation. WMV content can be encoded by using Windows Media[®] Encoder 9 series. Files are recognised by their file extension '.wmv'.

目录

1	重要信息	24
	安全和重要注意事项	24
	商标声明	24

2	您的 DVD 播放机	25
	可播放的介质	25
	产品概述	25

3	连接	27
	连接音频/视频线缆	27
	可选音频连接	28
	连接 USB 闪存盘	28
	连接电源	29

4	使用入门	29
	准备遥控器	29
	查找电视输入频道	29
	选择菜单显示语言	29
	打开逐行扫描	29
	使用 Philips EasyLink	30

5	播放	30
	播放光盘	30
	播放视频	30
	播放音乐	32
	播放照片	32
	播放 USB 闪存盘中的内容	33

6	其它功能	33
	媒体复制	33
	创建 MP3 文件	34
	卡拉 OK	34

7	调整设置	35
	通用设定	35
	音频设定	36
	视频设定	37
	初期设定	38

8	其它信息	39
	更新软件	39
	养护	39
	规格	40

9	故障种类和处理方法	40
----------	------------------	----

10	词汇	41
-----------	-----------	----

1 重要信息

安全和重要注意事项



警告

- 小心过热！切勿将本产品安装在封闭的空间内。务必在产品周围留出至少 4 英寸的空间以便通风。确保窗帘或其它物体不会遮挡产品上的通风槽。
- 切勿将产品、遥控器或电池放在明火或其它热源（包括直射的阳光）附近。
- 避免接触高温、湿气、水和尘土。
- 切勿将本装置置于滴漏或溅水环境中。
- 切勿在本装置上放置任何可能损坏本装置的物品（例如，盛有液体的物体、点燃的蜡烛）。
- 切勿将本装置放在其它电器设备上。
- 雷电天气期间，请远离本产品。
- 将电源插头或设备耦合器用作断电设备时，该断电设备应可以随时使用。
- 该设备打开时，存在可见及不可见的激光辐射。避免直视激光束。

关于逐行扫描技术

消费者须注意，并非所有高清电视均与本产品完全兼容，且可能会导致显示伪像。如果 525 或 625 逐行扫描图像出现问题，建议用户将连接切换为“标准清晰度”输出。关于我们的电视机与 525p 和 625p 型号 DVD 播放机之间的兼容性，如果您还存在有任何疑问，请与我们的客户服务中心联系。

旧产品和电池的处理



本产品采用可回收利用的高性能材料和组件制造而成。

切勿将本产品与其它生活垃圾一起处理。请自行了解当地关于分类收集电子、电气产品及电池的规定。正确弃置这些产品有助于避免对环境 and 人体健康造成潜在的负面影响。

本产品所含的电池不能与一般的生活垃圾一同弃置。

请自行了解当地关于分类收集电池的规定。正确弃置电池有助于避免对环境和人类健康造成潜在的负面影响。

关于您所在地区回收中心的更多信息，请访问 www.recycle.philips.com。

版权注意事项



Be responsible
Respect copyrights

本商品采用版权保护技术，受美国专利和 Rovi Corporation 的其它知识产权保护。禁止反向工程或反汇编。



商标声明



HDMI、HDMI 徽标和高清多媒体接口是 HDMI Licensing LLC 的商标或注册商标。



USB-IF 徽标是 Universal Serial Bus Implementers Forum, Inc 的商标。



DIGITAL | 在杜比实验室许可下制造。

“Dolby”和双 D 符号是杜比实验室的商标。



Digital Surround 在美国第 5,451,942、5,956,674、

5,974,380、5,978,762、6,487,535 号专利和其它已注册及正在申请的美国和世界专利许可下制造。

DTS 和 Symbol 是 DTS, Inc. 的注册商标，DTS 数字环绕声和 DTS 徽标是 DTS, Inc. 的商标。产品包括软件。© DTS, Inc. 保留所有权利。



关于 DivX 视频：DivX® 是由 DivX, Inc. 创建的一种数字视频格式。这是由 DivX 正式认证的可播放 DivX 视频的设备。更多关于 DivX 视频以及将文件转换成 DivX 视频格式的软件工具的信息，请访问 www.divx.com。

关于 DivX 随选视频：这款 DivX Certified® 设备必须注册，才能播放 DivX 随选视频 (VOD) 内容。要生成注册码，请在设备设置菜单中找到 DivX VOD 部分。转至 vod.divx.com，使用此注册码完成注册过程，并了解更多有关 DivX VOD 的信息。

DivX®、DivX Certified® 及相关徽标是 DivX, Inc. 的注册商标，并在授权下使用。



“DVD Video”是 DVD Format/Logo Licensing Corporation 的商标。



Windows Media 和 Windows 徽标是 Microsoft Corporation 在美国和/或其它国家/地区的商标或注册商标。

2 您的 DVD 播放机

感谢您的惠顾，欢迎光临 Philips！为了您能充分享受 Philips 提供的支持，请在 www.philips.com/welcome 注册您的产品。

可播放的介质

本产品可播放：

- DVD、DVD-Video、DVD+R/+RW、DVD-R/-RW、DVD+R/-R DL (双层)
- VCD/SVCD
- 音频 CD、CD-R/CD-RW
- MP3 媒体、WMA 媒体、WMV 媒体、DivX (Ultra) 媒体和 JPEG 文件
- USB 闪存盘

区域码

您可以播放以下区码的光盘。

DVD 区域码	国家/地区
	中国大陆

产品概述

主装置

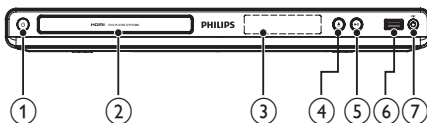

- ① **⏻ (待机-开机)**
 - 启动 DVD 播放机或切换到待机模式。
- ② **光盘舱**
- ③ **显示面板**
- ④ **▲ (打开/关闭)**
 - 打开或关闭光盘仓。
- ⑤ **▶|| (播放/暂停)**
 - 开始、暂停或继续播放光盘。
- ⑥ **↔ (USB) 插孔**
 - 连接 USB 闪存盘。
- ⑦ **MIC**
 - 连接麦克风。

遥控器

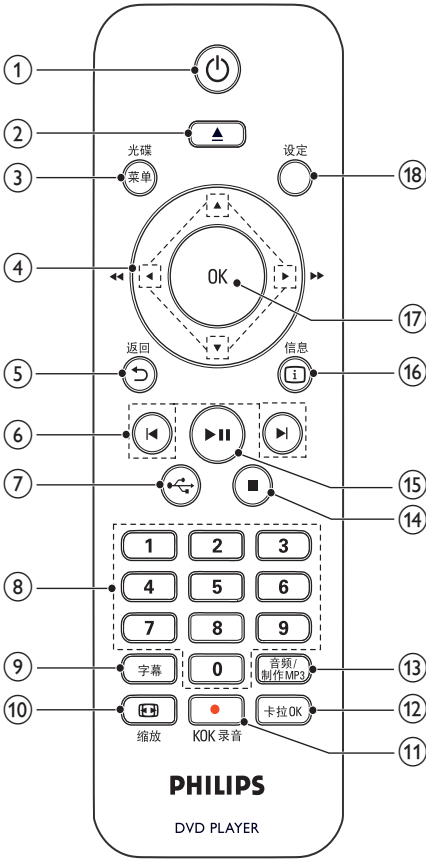

- ① 启动本装置或切换到待机模式。
- ② 打开或关闭光盘仓。
- ③ 光碟/菜单
- 进入或退出光盘菜单。
 - 切换至光盘模式。
 - 在播放照片幻灯片期间，在“娱乐模式”和“简单模式”之间切换。
 - 对于 VCD 和 SVCD，打开或关闭 PBC（播放控制）。

- ④ （导航按钮）
- 导航菜单。
 - 快速向前（▶）或向后（◀）搜索。
 - 慢进（▲）或慢退（▼）搜索。
- ⑤ 返回
- 返回上一个显示菜单。
- ⑥ 跳至上一或下一标题、章节或曲目。
- ⑦ 切换至 USB 模式。
- ⑧ 数字按钮
- 选择特定章节/曲目/标题进行播放。
- ⑨ 字幕
- 选择光盘的字幕语言。
 - 访问菜单，复制/删除 USB 闪存盘中的音频文件。
- ⑩ 缩放
- 使画面显示适合电视屏幕。
 - 放大或缩小画面。
- ⑪ KOK 录音
- 在卡拉 OK 期间将语音和音乐录制到 USB 闪存盘中。
- ⑫ 卡拉OK
- 进入或退出卡拉 OK 设置菜单。
- ⑬ 音频/制作MP3
- 选择光盘的音频语言或声道。
 - 访问创建 MP3 文件的菜单。
- ⑭ 停止播放。
- ⑮ 开始、暂停或继续播放光盘。
- ⑯ 信息
- 对于光盘，访问播放选项或显示当前光盘状态。
 - 对于幻灯片放映，显示照片文件的缩略图视图。
- ⑰ OK
- 确认输入或选择。
- ⑱ 设定
- 进入或退出设置菜单。

3 连接

建立以下连接以便使用本产品。

基本连接:

- 视频
- 音频

可选连接:

- 将音频引导至其它设备:
 - 数字功放器/接收器
 - 模拟立体声系统
- USB 闪存盘

连接音频/视频线缆

选择电视可支持的最佳视频连接。

- **选项 1:** 连接至 HDMI 插孔 (适合 HDMI、DVI 或 HDCP 兼容电视)。
- **选项 2:** 连接至分量视频插孔 (适合标准电视或逐行扫描电视)。
- **选项 3:** 连接至复合视频插孔 (适合标准电视)。

选项 1: 连接至 HDMI 插孔

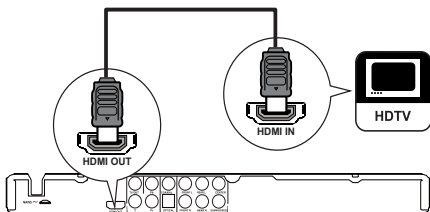

- 1 将 HDMI 电缆 (未提供) 连接至:
 - 本产品上的 **HDMI OUT** 插孔。
 - 电视上的 HDMI 输入插孔。

注

- 如果设备支持 HDMI CEC, 您可以通过一个遥控器来控制兼容设备 (请参阅“使用入门” > “使用 Philips EasyLink”)。

选项 2: 连接至分量视频插孔

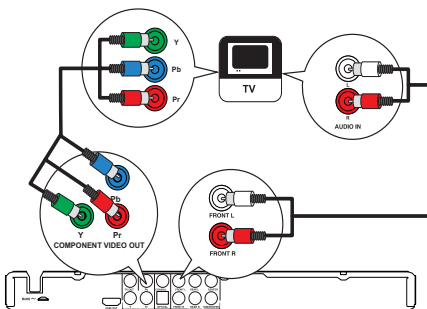

- 1 将分量视频线缆 (未提供) 连接至:
 - 本产品上的 **Y Pb Pr** 插孔。
 - 电视上的 **COMPONENT VIDEO** 输入插孔。
- 2 将音频线缆 (已提供) 连接到:
 - 本产品上的 **AUDIO OUT FRONT L/R** 插孔。
 - 电视上的音频输入插孔。

选项 3: 连接至视频 (CVBS) 插孔

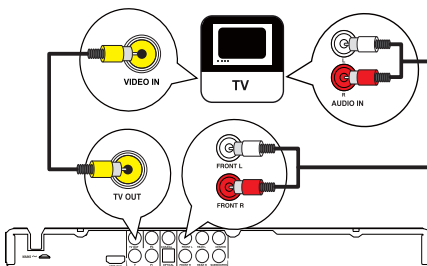

- 1 将复合视频线缆 (已提供) 连接至:
 - 本产品上的 **TV OUT** 插孔。
 - 电视上的视频输入插孔。
- 2 将音频线缆 (已提供) 连接到:
 - 本产品上的 **AUDIO OUT FRONT L/R** 插孔。
 - 电视上的音频输入插孔。

可选音频连接

将音频从本产品连接至其它设备，以增强音响效果。

连接多声道接收器

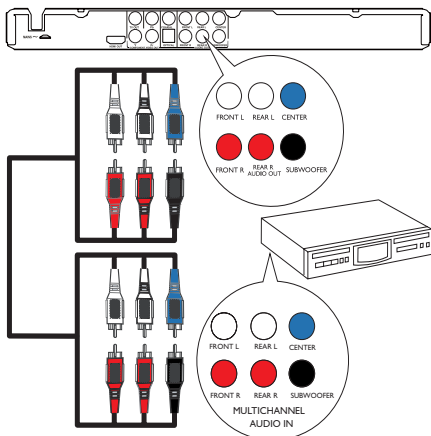

- 1 将音频线缆（未提供）连接到：
 - 本产品的 **AUDIO OUT**（FRONT L/R、REAR L/R、CENTER 和 SUBWOOFER）插孔。
 - 设备上的音频输入插孔。

连接至数字 AV 功放器/接收器

连接至 COAXIAL 插孔

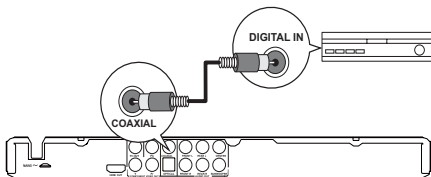

- 1 将同轴电缆（未提供）连接至：
 - 本产品上的 **COAXIAL** 插孔。
 - 设备上的 COAXIAL/DIGITAL 输入插孔。

连接至 OPTICAL 插孔

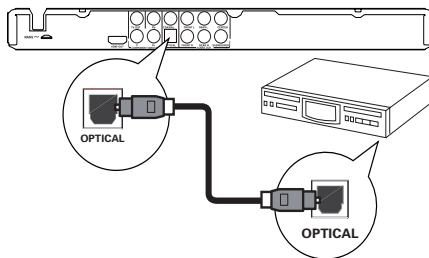

- 1 将光纤电缆（未提供）连接至：
 - 本产品上的 **OPTICAL** 插孔。
 - 设备上的 OPTICAL/DIGITAL 输入插孔。

连接模拟立体声系统

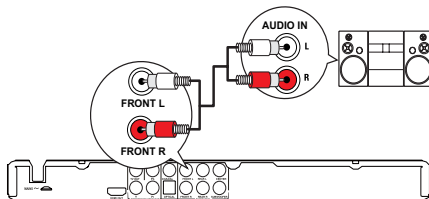

- 1 将音频线缆（已提供）连接到：
 - 本产品上的 **AUDIO OUT FRONT L/R** 插孔。
 - 电视上的音频输入插孔。

连接 USB 闪存盘

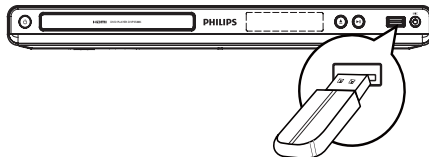

- 1 将 USB 闪存盘连接至本产品上的  接口。

注

- 本产品只能用于播放/查看 USB 闪存盘上存储的 MP3、WMA、WMV、DivX (Ultra) 或 JPEG 文件。
- 按  按钮访问内容并播放文件。

连接电源

注意

- 存在损坏产品的风险！确保实际电源电压与本产品背面标示的电源电压相符。
- 在连接交流电源线之前，确保已经完成所有其它连接。

注

- 型号铭牌位于本产品背面。

- 1 将交流电源线连接至插座。
↳ 本产品只需简单设置即可使用。

4 使用入门

准备遥控器

- 1 按下并推动电池盒盖将其打开（请参阅图中“1”）。
- 2 按照指示，以正确的极性 (+/-) 插入两节 AAA 电池。
- 3 推动电池盒盖将其滑回原位（请参阅图中“3”）。

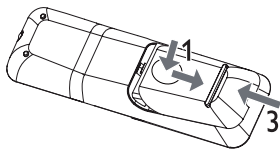

注

- 如果您打算很长一段时间不使用遥控器，请取出电池。
- 请勿混合使用电池（旧电池与新电池或碳电池与碱性电池，等等）。
- 电池含有化学物质，因此应正确处理。

查找电视输入频道

- 1 按 **⏻** 以启动本产品。
- 2 打开电视并切换至视频输入频道（请参阅电视的用户手册，了解如何选择 A/V 输入频道）。

选择菜单显示语言

注

- 如果本产品已连接至 HDMI CEC 兼容的电视，请跳过此设置。它将自动切换为与电视上设置的 OSD 菜单语言（如果本产品支持电视上设置的语言）。

General Setup		
	Disc Lock	<input type="radio"/> Auto (CHI)
	OSD Language	<input type="radio"/> English
	Sleep Timer	<input type="radio"/> 中文 (简体)
	Auto Standby	
	DivX(R) VOD Code	

- 1 按 **设定**。
↳ 将显示 **[通用设定页]** 菜单。
- 2 选择 **[显示语言]**，然后按 **▶**。
- 3 按 **▲▼** 以选择语言，然后按 **OK**。

打开逐行扫描

注

- 要使用逐行扫描功能，您必须通过分量视频插孔连接逐行扫描电视（有关详细信息，请参阅“连接”>“连接音频/视频线缆”>“选项 2：连接至分量视频插孔”）。

Video Setup		
	TV System	<input type="radio"/> On
	TV Display	<input type="radio"/> Off
	Progressive	
	Picture Setting	
	My Wallpaper	
	HD JPEG	
	HDMI Setup	

- 1 打开电视并调到本产品的正确视频输入频道。
- 2 按 **设定**。
- 3 按 **▼** 选择 **[视频设定]**。
- 4 选择 **[逐行扫描]>[开]**，然后按 **OK**。

↳ 将显示一则警告消息。

5 要继续, 请选择 [确认], 然后按 OK。

↳ 逐行扫描设置即已完成。

注

- 如果屏幕上无图像/图像失真, 请等待 15 秒钟以便自动恢复。
- 如果不显示图像, 请按照以下步骤关闭逐行扫描模式:
 - 1) 按 ▲ 打开光盘仓。
 - 2) 按数字按钮 '1'。

6 按 设定 退出菜单。

7 现在您可以打开电视的逐行扫描模式 (请参阅电视的用户手册)。

注

- 播放期间, 当打开此产品和电视的逐行扫描模式时, 可能会显示失真图像。在此情况下, 请关闭本产品和电视机上的逐行扫描功能。

使用 Philips EasyLink

本产品支持使用 HDMI CEC (消费电子控制) 协议的 Philips EasyLink 功能。您可以使用一个遥控器来控制通过 HDMI 连接器进行连接的 EasyLink 兼容设备。

注

- 要启用 EasyLink 功能, 必须在电视上以及连接到电视的其它设备上打开 HDMI CEC 操作。详细信息, 请参阅电视/设备的说明手册。

单键式播放

- 1 按  以启动本产品。
 - ↳ 电视 (如果支持单键式播放) 将自动开启, 并切换至正确的视频输入频道。
 - ↳ 如果本产品已载入光盘, 则会自动开始播放。

单键式待机

- 1 按住遥控器上的  超过 3 秒钟。
 - ↳ 所有连接设备 (如果支持单键式待机) 将自动切换至待机模式。

注

- Philips 不保证本产品可与所有 HDMI CEC 设备进行互操作。

5 播放

播放光盘

! 注意

- 切勿将光盘以外的任何物体放入光盘仓中。
- 切勿触摸光盘仓内的光盘光学镜头。

- 1 按 ▲ 打开光盘仓。
- 2 使标签朝上, 插入光盘。
- 3 按 ▲ 关闭光盘仓并开始播放光盘。

注

- 检查受支持的光盘类型 (请参阅“您的 DVD 播放机” > “可播放的介质”)。
- 如果显示了密码输入菜单, 则须输入密码才能播放锁定或受限的光盘 (请参阅“调整设置” > “初期设定” > [年龄控制])。





播放视频



注

- 一些操作可能对某些光盘不起作用。有关详情, 请参阅光盘随附的信息。

控制视频播放

- 1 播放标题。
- 2 使用遥控器来控制播放。

按钮	操作
	开始、暂停或继续播放光盘。
	停止播放光盘。
	跳至上一/下一标题或章节。
	快速向后或向前搜索。反复按可更改搜索速度。
	慢进或慢退搜索。反复按可更改搜索速度。 对于 VCD/SVCD, 慢退搜索不可用。

按钮	操作
音频/制作MP3	选择光盘上提供的的音频语言或声道。
字幕	选择光盘上提供的的字幕语言。
 缩放 (适应屏幕)	使画面格式适合电视屏幕。 反复按，直至图像完全适合电视屏幕。
 缩放	在屏幕宽高比和不同缩放因数之间切换。 要在缩放的图像上平移，请按导航按钮。
 信息	访问播放选项并显示当前光盘状态。

进入 DVD 菜单

- 1 按 **光碟/菜单** 进入 DVD 根菜单。
- 2 选择播放选项，然后按 **OK**。
 - 在某些菜单中，可按**数字按钮**输入选择。

进入 VCD 菜单

PBC (播放控制) 功能可用于 VCD/SVCD，它可以显示内容菜单，供您选择播放选项。默认情况下，PBC 已在出厂时打开。

注

- 有关如何打开或关闭 PBC，请参阅“调整设置”>“初期设定”>[PBC]。

- 1 通过以下方法之一显示内容菜单：
 - 如果 PBC 处于打开状态，装入 VCD/SVCD。
 - 在 PBC 处于打开状态下播放时，按 **返回**。
- 2 按**数字按钮**选择播放选项，然后按 **OK** 开始播放。
 - 如果 PBC 已关闭，则会跳过该菜单，并从第一个曲目开始播放。

预览光盘内容。

- 1 播放时，按 **信息**。
 - ↳ 此时将显示光盘状态菜单。
- 2 选择 **[预览]**，然后按 **▶**。
- 3 选择预览选项，然后按 **OK**。
 - ↳ 此时将显示缩略图预览屏幕。

- 要转至下一个/上一个预览屏幕，请选择 **[上一]** 或 **[下一]**，然后按 **OK**。
- 要开始播放，请在选定的缩略图上按 **OK**。

使播放跳至特定时间

- 1 播放时，按 **信息**。
 - ↳ 此时将显示光盘状态菜单。
- 2 为当前已播放时间选择一个选项，然后按 **▶**。
 - **[标题时间]** (标题时间)
 - **[章节时间]** (章节时间)
 - **[全碟时间]**
 - **[曲目时间]**
- 3 按**数字按钮**输入要跳至的时间，然后按 **OK**。

显示播放时间

- 1 播放时，按 **信息**。
 - ↳ 此时将显示光盘状态菜单。
- 2 选择 **[时间显示]**，然后按 **▶**。
 - ↳ 播放选项因光盘类型而异。
- 3 选择一个选项，然后按 **OK**。

从不同的角度观看 DVD 播放

- 1 播放时，按 **信息**。
 - ↳ 此时将显示光盘状态菜单。
- 2 选择 **[角度]**，然后按 **▶**。
- 3 按**数字按钮**更改角度。
 - ↳ 播放画面此时将切换到所选角度。

注

- 仅适用于包含多角度场景的光盘。

重复播放特定章节

- 1 播放时，按 **信息**。
- 2 按 **▼** 选择 **[重复 AB]**。
- 3 按 **OK** 设置起点。
- 4 按 **OK** 设置终点。
 - ↳ 重复播放即会开始。
 - 要取消重复播放，请再次按 **OK**。

注

- 标记为重复播放的章节只能位于同一个曲目/标题中。

播放 DivX® (Ultra) 视频

DivX® (Ultra) 视频是一种数字媒体格式，可在提供高压缩率的同时保持较高的画质。您可在经 DivX (Ultra) 认证的本产品上欣赏 DivX® (Ultra) 视频。

- 1 插入包含 DivX (Ultra) 视频的光盘或 USB 闪存盘。
 - 对于 USB，请按 。
- ↳ 将显示目录菜单。
- 2 选择要播放的标题，然后按 **OK**。
 - 您可以选择字幕/音频语言。







注

- 您仅可播放通过本产品的 DivX 注册码租借或购买的 DivX (Ultra) 视频 (请参阅“调整设置”>“通用设定”>[DivX(R)随选视讯])。

播放音乐

控制曲目

- 1 播放曲目。
- 2 使用遥控器来控制播放。

按钮	操作
	开始、暂停或继续播放光盘。
	停止播放光盘。
	跳至上一/下一曲目。
	选择特定章节/曲目/标题进行播放。
	
	快速向后或向前搜索。反复按可更改搜索速度。

快速跳转播放

此功能仅在播放音频 CD 时可用。



- 1 播放期间，反复按  信息 选择选项。

显示	操作
[盘片时间]	使播放跳至光盘中的特定时间点。
[曲目时间]	使播放跳至曲目中的特定时间点。
[选择曲目]	使播放跳至特定曲目编号。

- 2 按数字按钮更改要跳至的时间点/编号。

播放 MP3/WMA 音乐

MP3/WMA 是一种高压缩率的音频文件 (文件扩展名为 .mp3、.wma)。

- 1 插入包含 MP3/WMA 音乐的光盘或 USB 闪存盘。
 - 对于 USB，请按 。
- ↳ 将显示目录菜单。
- 2 如果未自动开始播放，请选择要播放的曲目。
 - 要选择其它曲目/文件夹，请按 ，然后按 **OK**。

注

- 对于以多段刻录方式刻录的光盘，将只播放第一段。
- 受数字版权管理 (DRM) 保护的 WMA 文件不能在本产品上播放。
- 本产品不支持 MP3PRO 音频格式。
- 如果 MP3 曲目名称 (ID3) 或专辑名称中含有任何特殊字符，它可能无法在屏幕上正确显示，因为不支持这类字符。
- 将不会显示或播放超出本产品支持范围的文件夹/文件。

重复播放特定章节

对于音频 CD，

- 1 在播放时，反复按  信息，直至显示 [关]。

- 2 按  选择重复播放选项。

对于 MP3/WMA 文件，

- 1 在播放时，反复按  信息 以选择重复播放选项。

播放照片

以幻灯片放映方式播放照片

您可播放 JPEG 照片 (文件扩展名为 .jpeg 或 .jpg)。

- 1 插入包含 JPEG 照片的光盘或 USB 闪存盘。
 - 对于 USB，请按 。
- ↳ 将开始幻灯片放映 (对于 Kodak 光盘)，或显示内容菜单 (对于 JPEG 光盘)。
- 2 选择照片，然后按 **OK** 开始幻灯片放映。
 - ↳ 对于以“exif”格式录制的照片，显示方向会自动优化。

- 要以彩色（娱乐模式）或黑白色（简单模式）显示照片，请按 **光碟/菜单**。
- 要在缩略图模式下预览照片，请按 **信息**。
 - 要选择照片，请按 **导航按钮**。
 - 要放大选中的照片并开始幻灯片放映，请按 **OK**。
 - 要返回到菜单，请按 **返回**。

注

- 由于编入光盘/USB 闪存盘中的歌曲/照片数量较多，在电视上显示光盘内容可能需要较长时间。
- 如果 JPEG 照片不是以“exif”类型的文件录制的，则屏幕上无法显示实际缩略图。而以“蓝色山脉”缩略图替代。
- 本产品只能显示符合 JPEG-EXIF 格式的数码相机照片，而几乎所有数码相机都使用该格式。它不能显示动态 JPEG 或非 JPEG 格式的照片，或与图像相关联的声音剪辑。
- 将不会显示或播放超出本产品支持范围的文件夹/文件。

控制照片播放

- 1 播放照片幻灯片。
- 2 使用遥控器来控制播放。

按钮	操作
◀/▶	逆时针/顺时针旋转照片。
▲/▼	水平/垂直旋转照片。
信息 缩放	放大或缩小照片。 在缩放模式下将暂停播放。
■	停止播放。

播放带音乐的幻灯片

创建音乐幻灯片，以同步播放 MP3/WMA 音乐文件和 JPEG 照片文件。

注

- 要创建音乐幻灯片，必须将 MP3/WMA 文件和 JPEG 文件存储在上一张光盘/USB 闪存盘上。

- 1 播放 MP3/WMA 音乐。
- 2 按 **返回** 返回主菜单。
- 3 导航到照片文件夹/相册，并按 **OK** 开始幻灯片放映。
 - ↳ 将开始幻灯片放映，一直播放到照片文件夹或相册的末尾。
 - ↳ 音频将持续播放至光盘的末尾。

- 要停止幻灯片播放，请按 **■**。
- 要停止音乐播放，请再次按 **■**。

播放 USB 闪存盘中的内容

注

- 本产品可用于播放/查看 USB 闪存盘上存储的 MP3、WMA、WMV、DivX (Ultra) 或 JPEG 文件。

- 1 将 USB 闪存盘连接至本产品上的 **USB** 接口。
- 2 按 **USB** 按钮。
↳ 此时将显示目录菜单。
- 3 如果未自动开始播放，请选择要播放的文件。
 - 有关详细信息，请参阅章节“播放音乐”、“播放照片”和“播放视频”。
- 4 要停止播放，请按 **■**。
 - 要切换至光盘模式，请按 **光碟/菜单** 按钮。

6 其它功能

媒体复制

可以将光盘中的文件（如 MP3、WMA 或 JPEG）复制到 USB 闪存盘。

- 1 插入包含 MP3/WMA/JPEG 文件的光盘。
- 2 在停止模式下，将 USB 闪存盘连接至本产品上的 **USB** 插孔。
- 3 选择要复制的文件，然后按 **字幕**。
- 4 在菜单中选择 **[是]**，然后按 **OK**。

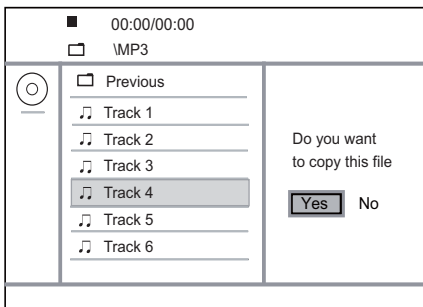

- ↳ 完成后，将自动在 USB 闪存盘中创建一个新文件夹，用于存储所有新文件。
- 5 要停止复制过程，请按 **■**，然后按 **OK**。

注

- 复制时，切勿按任何按钮。
- 受复制保护的媒体将无法复制。

创建 MP3 文件

您可以使用本产品将音频 CD 文件转换成 MP3 音频文件。所创建的 MP3 音频文件将保存在 USB 闪存盘中。

- 1 插入音频 CD。
- 2 将 USB 闪存盘连接至本产品上的  接口。
- 3 播放时，按 **音频/制作MP3**。
↳ 将显示 MP3 创建菜单。
- 4 在菜单中选择 **[是]**，然后按 **OK**。

Create MP3			
OPTIONS		TRACK	
Speed	Normal	<input type="radio"/> Track01	04:14
Bitrate	128kbps	<input type="radio"/> Track02	04:17
CRT ID3	Yes	<input type="radio"/> Track03	03:58
Device	USB 1	<input type="radio"/> Track04	04:51
SUMMARY		<input type="radio"/> Track05	03:53
Press [OK] button to change speed.		<input type="radio"/> Track06	04:09
		<input type="radio"/> Track07	04:38
Start	Exit	Select all	Deselect all

- 5 在 **[选项]** 面板中选择转换选项，然后反复按 **OK** 选择项目。

选项	描述
[速度]	选择复制速度。
[比特率]	选择质量级别。 比特率越高，音质越好，文件也就越大。
[CRT ID3]	将曲目信息复制到 MP3 文件中。
[设备]	所创建的文件只能保存在 USB 闪存盘中。

- 6 按 **▶** 访问 **[曲目]** 面板。
- 7 选择音频曲目，然后按 **OK**。
 - 要选择其它曲目，请重复步骤 7。
 - 要选择所有曲目，请选择菜单中的 **[全选]**，然后按 **OK**。

- 要取消选择所有曲目，请选择菜单中的 **[全部取消]**，然后按 **OK**。

- 8 选择菜单中的 **[开始]**，然后按 **OK** 以开始转换。
↳ 完成后，将自动在 USB 闪存盘中创建一个新文件夹，用于存储所有新的 MP3 文件。
 - 要退出菜单，请选择 **[退出]**，然后按 **OK**。

注

- 转换期间，切勿按任何按钮。
- 无法转换 DTS CD 和受复制保护的 CD。
- 不能用带有写保护或受密码保护的 USB 闪存盘来存储 MP3 文件。

卡拉 OK

可以连接麦克风（未提供），从而跟随音乐来源唱歌。

注

- 连接麦克风前，请将麦克风音量设为最低，以防止出现振鸣。

- 1 打开电视，然后选择电视输入频道。
- 2 将麦克风连接至本产品上的 **MIC** 插孔。
- 3 打开麦克风声音输出（请参阅“**调整卡拉 OK 设置**”）。
- 4 播放卡拉 OK 光盘，并对着麦克风唱歌。

调整卡拉 OK 设置

注

- 您需要打开 **[麦克风]** 选项中的麦克风声音输出，激活卡拉 OK 的相关菜单选项。

- 1 按 **卡拉OK**。
↳ 将显示卡拉 OK 设置菜单。
 - 2 选择一个选项，然后按 **OK**。
 - 3 更改或设定设置，然后按 **OK**。
 - 4 再次按 **卡拉OK** 退出菜单。
- [麦克风]** - 打开或关闭麦克风声音输出。
[麦克风音量] - 调节麦克风音量。
[回音] - 调节回音级数。

[卡拉OK计分] - 关闭卡拉 OK 计分功能或选择计分级别（基础/中级/高级）。如果选择了级别，则每首歌曲结束后将显示分数。

[歌唱比赛] - 4 位歌手之间的歌唱比赛。

- 1) 在 [卡拉OK计分] 选项中，选择级别（基础/中级/高级）。
- 2) 在 [歌唱比赛] 选项中，开启比赛。
 - ↳ 将显示歌曲选择菜单。
- 3) 输入曲目 (VCD/SVCD) 或标题/章节 (DVD) 作为第一首歌。最多可选择 4 首歌曲。
- 4) 然后选择 [开始]，并按 **OK** 开始播放选定歌曲。
 - ↳ 所有选定歌曲播放完后，将显示比赛结果。

[音调] - 根据您的嗓音调整音高级别。

[接唱] - 选择各种卡拉 OK 音频模式，或关闭原声。

卡拉 OK 录音

您可以将自己的演唱录制到 USB 闪存盘中。每次可以录制一首歌曲，且所有录制歌曲均以 .mp3 格式保存。首次录制到 USB 闪存盘时，会自动创建一个名为“PHILIPS”的文件夹，用于保存录制的文件。

注

- 本产品支持录制到 MAS USB 设备（MTP/NAS 设备除外）。





- 1 在卡拉 OK 期间，按 **● KOK 录音** 显示录制菜单：
 - [从现在开始] - 立即开始录制。
 - [从头开始] - 从当前歌曲的开头开始录制。
 - 要退出而不录制，请按 **● KOK 录音**。
- 2 按 **▲▼** 选择选项，然后按 **OK**。
 - ↳ 录制开始后，将显示录制进度栏。
 - ↳ 当前歌曲结束时，录制将完成并停止。
 - ↳ 在录制过程中，可以按 **● KOK 录音** 并遵照屏幕上的说明停止录制。

7 调整设置

注

- 如果设置选项呈灰色显示，则表示不能在当前状态下更改设置。

通用设定

General Setup		
	Disc Lock	_____
	OSD Language	_____
	Sleep Timer	_____
	Auto Standby	_____
	DivX(R) VOD Code	_____
		_____
		_____
		_____

- 1 按 **设定**。
 - ↳ 将显示 [通用设定页] 菜单。
- 2 按 **▶** 进入子菜单。
- 3 选择一个选项，然后按 **OK**。
- 4 选择设置，然后按 **OK**。
 - 要返回上一个菜单，请按 **↶** 返回。
 - 要退出菜单，请按 **设定**。

[锁碟]

对装入光盘仓的光盘设定播放限制（最多可锁定 20 张光盘）。

- **[锁]** - 限制对当前光盘的访问。下一次要播放此光盘或解锁时，需要输入密码。
- **[无锁]** - 播放所有光盘。

[显示语言]

选择屏幕菜单语言。

[睡眠定时]

在预设的时间自动切换至待机模式。

- **[关]** - 禁用休眠模式。
- **[15分钟]、[30分钟]、[45分钟]、[60分钟]** - 选择本产品切换到待机模式之前的倒计时时间。

[自动待机]

打开/关闭自动待机模式。

- **[开]** - 15 分钟不活动（例如，处于暂停或停止模式）后切换至待机模式。
- **[关]** - 禁用自动待机模式。

[DivX(R)随选视讯]

显示 DivX® 注册码和注销码。

- **[注册]** - 获取注册码以在网站上注册本产品。
- **[注销]** - 获取注销码以在网站上注销本产品。



注

- 从 www.divx.com/vod 租借或购买视频时，请使用本产品的 DivX 注册码。通过 DivX® VOD（随选视频）服务租借或购买的 DivX 视频只能在已注册该服务的设备上播放。

音频设定

Audio Setup	
	Analogue Output _____
	Digital Audio _____
	HDMI Audio _____
	Audio Sync _____
	Volume _____
	Sound Mode _____
	Speaker Setup _____
	CD Upsampling _____

- 1 按 **设定**。
↳ 将显示 **[通用设定页]** 菜单。
- 2 按 **▼** 选择 **[音频设定]**，然后按 **▶** 进入子菜单。
- 3 选择一个选项，然后按 **OK**。
- 4 选择设置，然后按 **OK**。
 - 要返回上一个菜单，请按 **↶** 返回。
 - 要退出菜单，请按 **设定**。

[模拟输出]

根据通过模拟音频插孔连接的音频设备选择模拟设置。

- **[左/右声道]** - 适用于来自两个扬声器的环绕声输出。
- **[立体声]** - 适用于立体声输出。
- **[多声道]** - 对于多声道输出。

[数字音频设置]

根据通过数字插孔（同轴/数字）连接的数字功放器/接收器选择数字设置。

- **[数字输出]** - 选择数字输出类型。
 - **[源码]** - 支持多声道音频格式。
 - **[关]** - 禁用数字输出。
 - **[仅PCM]** - 缩混成双声道音频格式。

- **[LPCM输出]** - 选择 LPCM（线性脉冲编码调制）输出采样率。
 - **[48kHz]** - 适用于以 48 千赫的采样率录制的光盘。
 - **[96kHz]** - 适用于以 96 千赫的采样率录制的光盘。



注

- 只有将 **[数字输出]** 设置为 **[仅PCM]** 时，**[LPCM输出]** 设置才可用。
- 采样率越高，音质越高。

[HDMI音频]

使用 HDMI 连接线连接本产品和电视时，请选择 HDMI 音频设置。

- **[开]** - 通过电视和扬声器系统输出音频。如果光盘上的音频格式不受支持，它将缩混成双声道声音（线性 PCM）。
- **[关]** - 禁用连接至本播放机的 HDMI 设备的音频输出。

[音频同步]

设置播放视频光盘期间音频输出的延迟时间。

1. 按 **OK**。
2. 按 **◀▶** 设置延迟时间。
3. 按 **OK** 确认并退出。

[音量]

设置播放光盘时的默认音量级别。

1. 按 **OK**。
2. 按 **◀▶** 设置音量。
3. 按 **OK** 确认并退出。

[声音模式]

选择预设的音效以增强音频输出。

- **[3D]** - 选择从左右声道产生的虚拟环绕声音效。
- **[影片模式]** - 选择适合电影的音效。
- **[音乐模式]** - 选择适合音乐的音效。

[扬声器设定]

优化所连接的扬声器的环绕声输出。

[CD 升频]

为在立体声模式下获得更好的音质，请将音乐 CD 转换为更高的采样率。

- **[关]** - 关闭 CD 升频。
- **[88.2kHz]** - 转换为原始采样率的两倍。
- **[176.4kHz]** - 转换为原始采样率的四倍。

[夜间模式]

让较大的声音变得柔和，并加大柔和的声音，使您能够以较低的音量欣赏 DVD 影片，不会打扰他人。

- [开] - 在夜间安静地欣赏。
- [关] - 欣赏具有全动态范围的环绕立体声。

注

- 仅适用于杜比数字编码的 DVD。

视频设定

Video Setup	
	TV System
	TV Display
	Progressive
	Picture Setting
	My Wallpaper
	HD JPEG
	HDMI Setup

- 1 按 **设定**。
↳ 将显示 **[通用设定页]** 菜单。
- 2 按 **▼** 选择 **[视频设定]**，然后按 **▶** 进入子菜单。
- 3 选择一个选项，然后按 **OK**。
- 4 选择设置，然后按 **OK**。
 - 要返回上一个菜单，请按 **↶** 返回。
 - 要退出菜单，请按 **设定**。

[电视制式]

如果视频显示不正确，可更改此设置。默认情况下，此设置与您所在国家/地区中电视的最常见设置相匹配。

- **[PAL制]** - 适用于 PAL 制式电视。
- **[自动]** - 适用于同时兼容 PAL 和 NTSC 的电视。
- **[NTSC制]** - 适用于 NTSC 制式电视。

[电视机形式]

选择显示格式:



4:3 Pan Scan (PS)

4:3 Letter Box (LB)

16:9 (Wide Screen)

- **[正常/全景]** - 4:3 屏幕电视：适用于侧面经过裁切的最高高度显示。
- **[正常/信箱]** - 4:3 屏幕电视：适用于屏幕顶部和底部带黑条的宽屏显示。
- **[宽银幕]** - 宽屏电视：显示比例为 16:9。

[逐行扫描]

如果将逐行扫描电视连接到本产品，请打开逐行扫描模式。

- **[开]** - 打开逐行扫描。
- **[关]** - 关闭逐行扫描模式。

注

- 有关详情，请参阅“使用入门”>“打开逐行扫描”。

[画质设定]

选择一套预定义的画面色彩设置，或者自定义个人设置。

- **[标准]** - 原始色彩设置。
- **[亮]** - 绚丽色彩设置。
- **[柔和]** - 暖色设置。
- **[个性化]** - 自定义色彩设置。设置亮度、对比度、清晰度和色彩饱和度，然后按 **OK**。

[墙纸设定]

选择图片用作壁纸。

- **[默认图片]** - 默认壁纸预设为 Philips 徽标。
- **[已存图片]** - 捕获的视频图像或 JPEG 照片。
- **[当前图片]** - 捕获视频图像或 JPEG 照片，将其保存在本产品上。

1. 播放视频或照片幻灯片。
2. 选择视频图像或照片：按 **▶▶▶** 暂停播放，然后按 **设定**。
3. 导航至选项 (**[视频设定]** > **[墙纸设定]** > **[当前图片]**)。
4. 按 **OK** 确认。
 - ↳ 将保存一张视频图像或 JPEG 照片作为壁纸。
 - ↳ 新保存的图像或照片将替代之前的图像或照片。

[HD JPEG]

使用 HDMI 连接线将本产品与电视连接起来，您便能以原始分辨率欣赏未经压缩的原始 JPEG 图像。

- **[开]** - 显示高清画面。
- **[关]** - 显示标准清晰度画面。

[HDMI设置]

使用 HDMI 连接线连接本产品和电视时，请选择电视可支持的最佳 HDMI 设置。

- **[分辨率]** - 选择与电视显示功能兼容的视频分辨率。
 - **[自动]** - 自动检测并选择支持的最佳视频分辨率。
 - **[480i]、[480p]、[576i]、[576p]、[720p]、[1080i]、[1080p]** - 选择电视支持的最佳视频分辨率。有关详细信息，请参阅电视手册。
- **[宽屏幕格式]** - 定义宽屏幕格式进行光盘播放。
 - **[超宽]** - 屏幕中央的拉伸少于侧面拉伸（仅在视频分辨率设为 720p、1080i 或 1080p 时适用）。
 - **[4:3信箱]** - 不拉伸画面。屏幕两侧将显示黑条（仅在视频分辨率设为 720p、1080i 或 1080p 时适用）。
 - **[关]** - 根据光盘格式显示画面。
- **[EasyLink 设定]** - 如果本产品连接的是 HDMI CEC 兼容电视/设备，则所有连接设备均可对以下命令做出同步反应。
 - **[EasyLink]** - 打开/关闭所有 EasyLink 功能。

启用 EasyLink 后，按 。

 - ↳ 本产品将启动。
 - ↳ 电视（如果电视支持单键式播放）将自动开启，并切换至视频输入频道。
 - ↳ 如果本产品中有光盘，将开始播放光盘。
 - **[单键式播放]** - 打开或关闭单键式播放功能。

启用 EasyLink 后，按 。

 - ↳ 所有已连接的 HDMI CEC 兼容设备都将切换为待机状态。









注

- 必须在电视/设备上打开 HDMI CEC 操作才能使用 EasyLink 控制。有关详细信息，请参阅电视/设备的说明手册。
- Philips 不保证本产品完全可以与所有 HDMI CEC 兼容设备进行互操作。

初期设定

注

- 需停止光盘播放才能访问 [初期设定页]。

Preferences	
	Audio
	Subtitle
	Disc Menu
	Parental Control
	PBC
	Mp3/Jpeg Nav
	Password
	DivX Subtitle

1. 按 **设定**。
 - ↳ 将显示 **[通用设定页]** 菜单。
2. 按 **▼** 选择 **[初期设定页]**，然后按 **▶** 进入子菜单。
3. 选择一个选项，然后按 **OK**。
4. 选择设置，然后按 **OK**。
 - 要返回上一个菜单，请按 **↶** 返回。
 - 要退出菜单，请按 **设定**。

[声音]

为光盘播放选择音频语言。

[字幕]

为光盘播放选择字幕语言。

[碟片选单语言]

选择光盘菜单语言。

注

- 如果光盘上没有所设置的语言，光盘将使用其默认语言。
- 有些 DVD 的字幕/音频语言只能从光盘菜单进行更改。
- 要选择菜单中未列出的语言，请选择 **[其它]**。然后检查本用户手册背面的“Language Code”（语言代码）列表，并输入相应的语言代码。

[年龄控制]

限制对不适合儿童的光盘的访问。这些类型的光盘必须按等级录制。

1. 按 **OK**。
2. 选择等级，然后按 **OK**。
3. 按**数字按钮**输入密码。

注

- 高于您在 [年龄控制] 中设置的等级的等级 DVD 需要密码才能播放。
- 具体分级视国家/地区而定。要允许播放所有光盘，请选择“8”。
- 有些光盘上印制了等级，但未根据该等级录制。此功能对此类光盘无效。

[PBC]

打开或关闭带有 PBC（播放控制）功能的 VCD/SVCD 的内容菜单。

- **[开]** - 装入光盘进行播放时，将显示索引菜单。
- **[关]** - 跳过该菜单，并从第一首曲目开始播放。

[MP3/JPEG播放]

选择此项以显示文件夹或所有文件。

- **[查看文件]** - 显示所有文件。
- **[查看文件夹]** - 显示 MP3/WMA 文件的文件夹。

[密码]

设置或更改锁定光盘的密码，播放受限制的 DVD。

Preferences Change Password	
Old Password	<input type="text"/>
New Password	<input type="text"/>
Confirm PWD	<input type="text"/>
<input type="button" value="OK"/>	

1. 按数字按钮在 [旧密码] 字段中输入“136900”或上次设定的密码。
2. 在 [新密码] 字段中输入新密码。
3. 在 [确认密码] 字段中再次输入新密码。
4. 按 **OK** 退出菜单。

注

- 如果您忘记了密码，请输入“136900”，然后设置新密码。

[DivX字幕]

选择支持 DivX 字幕的字符集。

- **[中文（简体）]** - 简体中文

注

- 确保字幕文件与影片文件两者的文件名完全相同。例如，如果影片的文件名是“Movie.avi”，则必须将文本文件名命名为“Movie.sub”或“Movie.srt”。

[版本信息]

显示本产品的软件版本。

注

- 如果您想知道是否可以在 Philips 网站上下载最新的软件版本，并将其安装在本产品上，就需要此信息。

[缺省值]

将本产品的所有设置重置为出厂默认值，[锁碟]、[年龄控制] 和 [密码] 设置除外。

8 其它信息

更新软件

要获得软件更新，请检查本产品的当前软件版本，将其与 Philips 网站上的最新软件版本（如果有）进行比较。

！ 注意

- 软件升级过程中切勿中断电源！

- 1 按 **设定**。
- 2 选择 [初期设定页]>[版本信息]，然后按 **OK**。
- 3 记下文件名，然后按 **设定** 退出菜单。
- 4 访问 www.philips.com/support，使用此产品的文件名检查是否有最新的软件版本。
- 5 详细信息，请参阅网站上的升级说明。

注

- 断开电源线数秒钟，然后重新连接以启动本产品。

养护

！ 注意

- 切勿将苯、稀释剂、商用清洁剂或防静电喷雾剂用于光盘。

清洁光盘

使用微纤维清洁布从光盘中心向边缘呈直线擦拭光盘。

规格

注

- 规格和设计如有更改，恕不另行通知。

USB

- 兼容性：高速 USB (2.0)
- 类别支持：UMS (USB 海量存储类)

视频

- 信号制式：PAL / NTSC
- 复合视频输出：1 Vpp ~ 75 欧姆
- 分量视频输出：0.7 Vpp ~ 75 欧姆
- HDMI 输出：480i、480p、576i、576p、720p、1080i、1080p

音频

- 模拟立体声输出
- 信噪比 (1 千赫)：> 90 分贝 (A 加权)
- 动态范围 (1 千赫)：> 80 分贝 (A 加权)
- 串音 (1 千赫)：> 90 分贝
- 失真/噪音 (1 千赫)：> 75 分贝
- MP3：MPEG 音频第 3 层
- 数字输出
 - 同轴、光纤
- HDMI 输出

主装置

- 尺寸 (宽 x 高 x 深)：360 x 39 x 209 (毫米)
- 净重：约 1.49 千克

电源

- 额定功率：110-240 伏，50/60 赫兹
- 功耗：< 10 瓦
- 待机模式下的功耗：< 0.1 瓦

提供的附件

- 遥控器和电池
- 音频/视频线缆
- 用户手册
- 快速入门指南

激光规格

- 类型：半导体激光 InGaAlP (DVD)，AlGaAs (CD)
- 波长：655 纳米 (DVD)，790 纳米 (CD)

- 输出功率：7.0 毫瓦 (DVD)，10.0 毫瓦 (VCD/CD)
- 发散角：60 度

9 故障种类和处理方法



警告

- 存在触电危险。切勿拆下本产品的外壳。

为保证保修的有效性，切勿尝试自行维修本产品。

如果在使用本产品时遇到问题，请在申请服务之前检查以下事项。如果仍遇到问题，请在 www.philips.com/welcome 页面上注册您的产品并获得支持。

如果您与 Philips 联系，将询问您本产品的型号和序列号。型号和序列号可以在本产品的背面找到。请在此处填写型号：

型号 _____

序列号 _____

主装置

本装置上的按钮不起作用。

- 将此产品从电源插座上断开几分钟，然后重新连接。

对遥控器没有反应。

- 将本产品连接至电源插座。
- 将遥控器指向本产品正面的红外传感器。
- 正确装入电池。
- 在遥控器中装入新电池。

画面

无画面。

- 有关如何在电视机上选择正确输入源的信息，请参阅电视的用户手册。切换电视频道直至看到 Philips 屏幕。
- 如果已打开逐行扫描设置或更改电视制式设置，请切换回默认模式：1) 按 **▲** 打开光盘仓。2) 按 **数字按钮 '1'** (对于逐行扫描电视) 或 **数字按钮 '3'** (对于电视制式)。

使用 HDMI 连接时无图像。

- 如果通过 HDMI 连接线将本产品连接至未授权的播放设备，则可能无法输出音频/视频信号。

- 检查 HDMI 连接线是否有故障。换用新的 HDMI 连接线。
- 如果在更改 HDMI 视频分辨率时出现这种情况，则必须将其切换回默认模式：1) 按 ▲ 打开光盘仓。2) 按数字按钮“1”。

声音

电视无音频输出。

- 确保已将音频电缆连接至电视的音频输入插孔。
- 将电视的音频输入分配至相应的视频输入。有关详细信息，请参阅电视的用户手册。

音频设备（立体声系统/功放器/接收器）的扬声器没有音频输出。

- 确保音频电缆已连接至音频设备的音频输入插孔。
- 打开音频设备，调至正确的音频输入源。

HDMI 连接无声音。

- 如果连接的设备不符合 HDCP 标准或仅兼容 DVI，则您可能无法听到 HDMI 输出的声音。
- 确保已打开 [HDMI 音频] 设置。

播放 DivX 视频时没有声音。

- 此产品可能不支持音频编解码器。

播放

不能播放光盘。

- 光盘严重刮花、变形或弄脏。更换或清洁光盘。
- 请使用正确的光盘格式或文件格式。

不能播放 DivX 视频文件。

- 确保 DivX 视频文件是完整的。
- 确保文件扩展名正确。
- 由于数字版权问题，受 DRM 保护的视频文件无法通过模拟视频连接（例如复合、分量 and scart）播放。使用 HDMI 连接播放这些文件。

屏幕的宽高比与电视的显示设置不符。

- 光盘内容的宽高比是固定的。

DivX 字幕没有正确显示。

- 确保字幕文件名与电影文件名相同。
- 选择正确的字符集。
 - 按 设定。
 - 在菜单中选择 [初期设定页] > [DivX 字幕]。
 - 选择支持字幕的字符集。

10 词汇

D

DivX 随选视频

此 DivX 认证® 设备必须注册，才能播放 DivX 随选视频 (VOD) 内容。要生成注册码，请在设备设置菜单中找到 DivX VOD 部分。转至 vod.divx.com，使用此注册码完成注册过程，并了解更多有关 DivX 视频的信息。

H

HDMI

高清晰度多媒体接口，是一种高速数字接口，可传输未经压缩的高清晰度视频和数字多声道音频。可以传输高质量的画面和音频，而没有任何干扰。HDMI 完全向后兼容 DVI。根据 HDMI 标准，连接至无 HDCP（高带宽数字内容保护）的 HDMI 或 DVI 产品将导致无视频或音频输出。

J

JPEG

一种常见的数字静态图片格式。联合图像专家组提出的一种静态图片数据压缩系统，特点是压缩比很高，但图像质量仅略有降低。JPEG 文件的扩展名为 .jpg 或 .jpeg。

M

MP3

一种具有声音数据压缩系统的文件格式。MP3 是 Motion Picture Experts Group 1（或称 MPEG-1）Audio Layer 3 的简称。使用 MP3 格式，一张 CD-R 或 CD-RW 光盘可以比一般 CD 多存储大约 10 倍的数据。

P

PBC

播放控制。一种系统，在该系统下您可以利用刻录到光盘中的屏幕菜单在 VCD/S-VCD 中导航。您可以享受互动播放和搜索。

W

WMA

Windows Media™ 音频。请参考 Microsoft Corporation 开发的音频压缩技术。WMA 数据可以使用第 9 版 Windows Media Player 或 Windows Media Player for Windows XP 进行编码。WMA 文件的扩展名为 .wma。

WMV [Windows Media Video]

指 Microsoft Corporation 开发的一种视频压缩技术。WMV 内容可通过 Windows Media® Encoder 9 系列进行编码。这些文件可通过其文件扩展名 “.wmv” 来识别。

宽

宽高比

宽高比指电视屏幕的长度与高度的比率。标准电视的比率为 4:3，而高清晰度和宽屏电视的比率为 16:9。“信箱”播放模式可以让您在比率为 4:3 的标准屏幕上以宽视角欣赏图片。

逐

逐行扫描

逐行扫描每秒显示的帧数是普通制式电视的两倍。它可以提供较高的图像分辨率和质量。

Language Code

Abkhazian	6566
Afar	6565
Afrikaans	6570
Amharic	6577
Arabic	6582
Armenian	7289
Assamese	6583
Avestan	6569
Aymara	6589
Azerhājani	6590
Bahasa Melayu	7783
Bashkir	6665
Belarusian	6669
Bengali	6678
Bihari	6672
Bislama	6673
Bokmål, Norwegian	7866
Bosanski	6683
Brezhoneg	6682
Bulgarian	6671
Burmese	7789
Castellano, Español	6983
Catalán	6765
Chamorro	6772
Chechen	6769
Chewa; Chichewa; Nyanja	7889
中文	9072
Chuang; Zhuang	9065
Church Slavīc; Slavonic	6785
Chuvash	6786
Corsican	6779
Česky	6783
Dansk	6865
Deutsch	6869
Dzongkha	6890
English	6978
Esperanto	6979
Estonian	6984
Euskara	6985
Ελληνικά	6976
Faroese	7079
Français	7082
Frysk	7089
Fijian	7074
Gaelic; Scottish Gaelic	7168
Galleɡan	7176
Georgian	7565
Gikuyu; Kikuyu	7573
Guarani	7178
Gujarati	7185
Hausa	7265
Herero	7290
Hindi	7273
Hiri Motu	7279
Hrwatski	6779
Ido	7379
Interlingua (International)	7365
Interlingue	7365
Inuktitut	7385

Inupiaq	7375
Irish	7165
Íslenska	7383
Italiano	7384
Ivrit	7269
Japanese	7465
Javanese	7486
Kalaallisut	7576
Kannada	7578
Kashmiri	7583
Kazakh	7575
Kernewek	7587
Khmer	7577
Kinyarwanda	8287
Kirghiz	7589
Komi	7586
Korean	7579
Kuanyama; Kwanyama	7574
Kurdish	7585
Lao	7679
Latina	7665
Latvian	7686
Letzeburgesch;	7666
Limburgan; Limburger	7673
Lingala	7678
Lithuanian	7684
Luxembourgish;	7666
Macedonian	7775
Malagasy	7771
Magyar	7285
Malayalam	7776
Maltese	7784
Manx	7186
Maori	7773
Marathi	7782
Marshallese	7772
Moldavian	7779
Mongolian	7778
Nauru	7865
Navaho; Navajo	7886
Ndebele, North	7868
Ndebele, South	7882
Ndonga	7871
Nederlands	7876
Nepali	7869
Norsk	7879
Northern Sami	8369
North Ndebele	7868
Norwegian Nynorsk;	7878
Occitan; Provençal	7967
Old Bulgarian; Old Slavonic	6785
Oriya	7982
Oromo	7977
Ossetian; Ossetic	7983
Pali	8073
Panjabi	8065
Persian	7065
Polski	8076
Português	8084

Pushto	8083
Russian	8285
Quechua	8185
Raeto-Romance	8277
Romanian	8279
Rundi	8278
Samoan	8377
Sango	8371
Sanskrit	8365
Sardinian	8367
Serbian	8382
Shona	8378
Shqip	8381
Sindhi	8368
Sinhalese	8373
Slovensky	8373
Slovenian	8376
Somali	8379
Sotho; Southern	8384
South Ndebele	7882
Sundanese	8385
Suomi	7073
Swahili	8387
Swati	8383
Svenska	8386
Tagalog	8476
Tahitian	8489
Tajik	8471
Tamil	8465
Tatar	8484
Telugu	8469
Thai	8472
Tibetan	6679
Tigrinya	8473
Tonga (Tonga Islands)	8479
Tsonga	8483
Tswana	8478
Türkçe	8482
Turkmen	8475
Twi	8487
Uighur	8571
Ukrainian	8575
Urdu	8582
Uzbek	8590
Vietnamese	8673
Volapuk	8679
Walloon	8765
Welsh	6789
Wolof	8779
Xhosa	8872
Yiddish	8973
Yoruba	8979
Zulu	9085

