

Varistor Products

Low Profile

RA Varistor Series



The RA Series transient surge suppressors are varistors (MOVs) supplied in a low-profile box that features a precise seating plane to increase mechanical stability for secure circuit-board mounting. This feature makes these devices suitable for industrial applications critical to vibration. Their construction permits operation up to 125°C (ambient) without derating.

The RA series are available in voltage ratings up to 275V $V_{M(AC)RMS}$ and energy levels up to 140J. These varistors are used in automotive, motor-control, telecommunication, and military applications.

See RA Series Device Ratings and Specifications table for part number and brand information.

Features

- Low Profile Outline with Precise Seating Plane
- No Derating up to 125°C Ambient
- Wide Operating Voltage Range
 - $V_{M(AC)RMS}$ 4V to 275V
 - $V_{M(DC)}$ 5.5V to 369V
- High Energy Absorption Capability W_{TM} up to 140J
- 3 Model Sizes Available RA8, RA16, and RA22
- In-Line Leads

AGENCY APPROVALS: Recognized under the components program of Underwriters Laboratories. Certified by CSA.

AGENCY FILE NUMBERS: UL E75961, E56529, E135010; CSA LR91788.

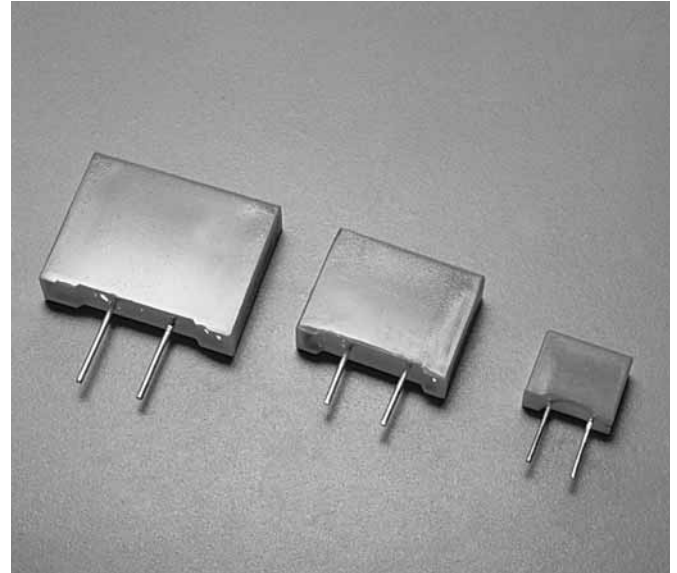

2

VARISTOR PRODUCTS

Varistor Products

Low Profile

RA Varistor Series

Absolute Maximum Ratings For ratings of individual members of a series, see Device Ratings and Specifications chart

Continuous:	RA8 SERIES	RA16 SERIES	RA22 SERIES	UNITS
Steady State Applied Voltage:				
AC Voltage Range ($V_{M(AC)RMS}$)	4 to 275	10 to 275	4 to 275	V
DC Voltage Range ($V_{M(DC)}$)	5.5 to 369	14 to 369	18 to 369	V
Transient:				
Peak Pulse Current (I_{TM})				
For 8/20 μ s Current Wave (See Figure 2)	100 to 1200	1000 to 4500	2000 to 6500	A
Single Pulse Energy Range (Note 1)				
For 10/1000 μ s Current Wave (W_{TM})	0.4 to 23	3.5 to 75	70 to 160	J
Operating Ambient Temperature Range (T_A)	-55 to 125	-55 to -125	-55 to -125	$^{\circ}$ C
Storage Temperature Range (T_{STG})	-55 to 150	-55 to 150	-55 to 150	$^{\circ}$ C
Temperature Coefficient (α_V) of Clamping Voltage (V_C) at Specified Test Current	<0.01	<0.01	<0.01	%/ $^{\circ}$ C
Hi-Pot Encapsulation (Isolation Voltage Capability)				
(Dielectric must withstand indicated DC voltage for one minute per MIL-STD 202, Method 301)	5000	5000	5000	V
Insulation Resistance	1000	1000	1000	M Ω

CAUTION: Stresses above those listed in "Absolute Maximum Ratings" may cause permanent damage to the device. This is a stress only rating and operation of the device at these or any other conditions above those indicated in the operational sections of this specification is not implied.

Device Ratings and Specifications (Note 1)

PART NUMBER	BRAND	MAXIMUM RATINGS (125 $^{\circ}$ C)				SPECIFICATIONS (25 $^{\circ}$ C)					
		CONTINUOUS		TRANSIENT		VARISTOR VOLTAGE AT 1mA DC TEST CURRENT			MAX CLAMPING VOLTAGE V_C AT TEST CURRENT (8/20 μ s)		TYPICAL CAPACITANCE
		V_{RMS}	V_{DC}	ENERGY (10/1000 μ s)	PEAK CURRENT (8/20 μ s)						
		$V_{M(AC)}$ (V)	$V_{M(DC)}$ (V)	W_{TM} (J)	I_{TM} (A)	MIN (V)	$V_{N(DC)}$ (V)	MAX (V)	V_C (V)	I_P (A)	f = 1MHz (pF)
† RA8 SERIES											
V8RA8	8R	4	5.5	0.4	150	6	8.2	11.2	22	5	3000
V12RA8	12R	6	8	0.6	150	9	12	16	34	5	2500
V18RA8	18R	10	14	0.8	250	14.4	18	21.6	42	5	2000
V22RA8	22R	14	18 (Note 3)	10 (Note 2)	250	18.7	22	26	47	5	1600
V27RA8	27R	17	22	1.0	250	23	27	31.1	57	5	1300
V33RA8	33R	20	26	1.2	250	29.5	33	36.5	68	5	1100
V39RA8	39R	25	31	1.5	250	35	39	43	79	5	900
V47RA8	47R	30	38	1.8	250	42	47	52	92	5	800
V56RA8	56R	35	45	2.3	250	50	56	62	107	5	700
V68RA8	68R	40	56	3.0	250	61	68	75	127	5	600
V82RA8	82R	50	66	4.0	1200	74	82	91	135	10	500
V100RA8	100R	60	81	5.0	1200	90	100	110	165	10	400
V120RA8	120R	75	102	6.0	1200	108	120	132	205	10	300
V150RA8	150R	95	127	8.0	1200	135	150	165	250	10	250
V180RA8	180R	115	153	10.0	1200	162	180	198	295	10	200
V200RA8	200R	130	175	11.0	1200	184	200	228	340	10	180
† V220RA8	220R	140	180	12.0	1200	198	220	242	360	10	160
† V240RA8	240R	150	200	13.0	1200	212	240	268	395	10	150
† V270RA8	270R	175	225	15.0	1200	247	270	303	455	10	130
† V360RA8	360R	230	300	20.0	1200	324	360	396	595	10	100

Varistor Products

Low Profile

RA Varistor Series

Device Ratings and Specifications (Note 1) (Continued)

PART NUMBER	BRAND	MAXIMUM RATINGS (125°C)				SPECIFICATIONS (25°C)					
		CONTINUOUS		TRANSIENT		VARISTOR VOLTAGE AT 1mA DC TEST CURRENT			MAX CLAMPING VOLTAGE V_C AT TEST CURRENT (8/20 μ S)		TYPICAL CAPACITANCE f = 1MHz
		V_{RMS}	V_{DC}	ENERGY (10/1000 μ S)	PEAK CURRENT (8/20 μ S)						
		$V_{M(AC)}$ (V)	$V_{M(DC)}$ (V)	W_{TM} (J)	I_{TM} (A)	MIN (V)	$V_{N(DC)}$ (V)	MAX (V)	V_C (V)	I_P (A)	(pF)
† V390RA8	390R	250	330	21.0	1200	354	390	429	650	10	90
† V430RA8	430R	275	369	23.0	1200	389	430	473	710	10	80
† RA16 SERIES											
V18RA16	18R16	10	14	3.5	1000	14.4	18	21.6	39	10	11000
V22RA16	22R16	14	18 (Note 3)	50 (Note 2)	1000	18.7	22	26	43	10	9000
V27RA16	27R16	17	22	5.0	1000	23	27	31.1	53	10	7000
V33RA16	33R16	20	26	6.0	1000	29.5	33	36.5	64	10	6000
V39RA16	39R16	25	31	7.2	1000	35	39	43	76	10	5000
V47RA16	47R16	30	38	8.8	1000	42	47	52	89	10	4500
V56RA16	56R16	35	45	10.0	1000	50	56	62	103	10	3900
V68RA16	68R16	40	56	13.0	1000	61	68	75	123	10	3300
V82RA16	82R16	50	66	15.0	4500	74	82	91	145	50	2500
V100RA16	100R16	60	81	20.0	4500	90	100	110	175	50	2000
V120RA16	120R16	75	102	22.0	4500	108	120	132	205	50	1700
V150RA16	150R16	95	127	30.0	4500	135	150	165	255	50	1400
V180RA16	180R16	115	153	35.0	4500	162	180	198	300	50	1100
† V200RA16	200R16	130	175	38.0	4500	184	200	228	340	50	1000
† V220RA16	220R16	140	180	42.0	4500	198	220	242	360	50	900
† V240RA16	240R16	150	200	45.0	4500	212	240	268	395	50	800
† V270RA16	270R16	175	225	55.0	4500	247	270	303	455	50	700
† V360RA16	360R16	230	300	70.0	4500	324	360	396	595	50	550
† V390RA16	390R16	250	330	72.0	4500	354	390	429	650	50	500
† V430RA16	430R16	275	369	75.0	4500	389	430	473	710	50	450
† RA22 SERIES											
V24RA22	24R22	14	18 (Note 3)	100.0 (Note 2)	2000	19.2	24 (Note 4)	26	43	20	18000
V36RA22	36R22	23	31	160.0 (Note 2)	2000	32	36 (Note 4)	40	63	20	12000
† V200RA22	200R22	130	175	70.0	6500	184	200	228	340	100	1900
† V240RA22	240R22	150	200	80.0	6500	212	240	268	395	100	1600
† V270RA22	270R22	175	225	90.0	6500	247	270	303	455	100	1400
† V390RA22	390R22	250	330	130.0	6500	354	390	429	650	100	1000
† V430RA22	430R22	275	369	140.0	6500	389	430	473	710	100	900

NOTES:

1. Average power dissipation of transients not to exceed 0.25W for RA8 Series, 0.60W for RA16 Series, or 1.0W for RA22 Series.
2. Energy ratings for impulse duration of 30ms minimum to one half of peak current value.
3. Also rated to withstand 24V for 5 minutes.
4. 10mA DC Test Current.

† Under UL File No. E75961 as a recognized component. CSA approved File No. LR91788.

Varistor Products

Low Profile

RA Varistor Series

Power Dissipation Ratings

Should transients occur in rapid succession, the average power dissipation required is simply the energy (watt-seconds) per pulse times the number of pulses per second. The power so developed must be within the specifications shown on the Device Ratings and Specifications table for the specific device. Furthermore, the operating values need to be derated at high temperatures as shown in Figure 1. Because varistors can only dissipate a relatively small amount of average power they are, therefore, not suitable for repetitive applications that involve substantial amounts of average power dissipation.

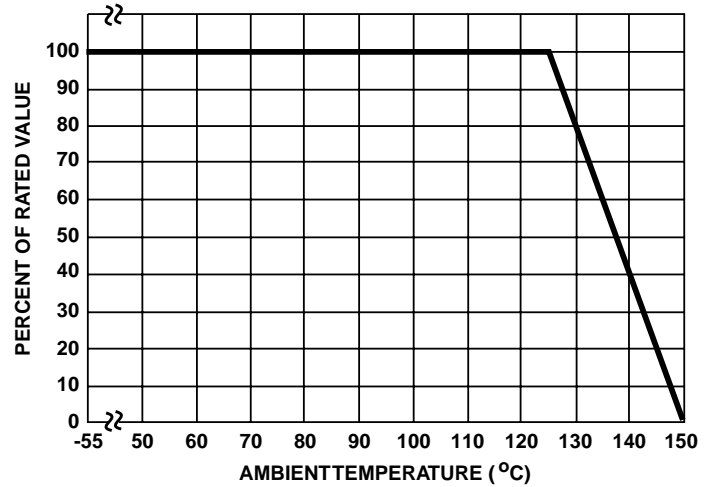

FIGURE 1. CURRENT, ENERGY AND POWER DERATING CURVE

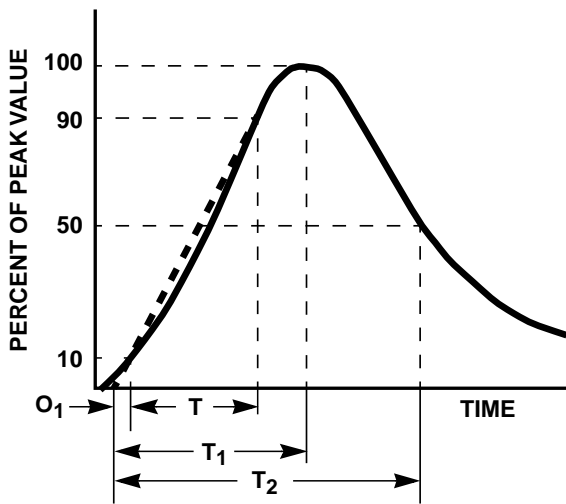

FIGURE 2. PEAK PULSE CURRENT TEST WAVEFORM

O_1 = Virtual Origin of Wave
 T = Time From 10% to 90% of Peak
 T_1 = Virtual Front time = $1.25 \cdot t$
 T_2 = Virtual Time to Half Value (Impulse Duration)
 Example: For an 8/20 μ s Current Waveform:
 8μ s = T_1 = Virtual Front Time
 20μ s = T_2 = Virtual Time to Half Value

Varistor Products

Low Profile

RA Varistor Series

Transient V-I Characteristics Curves (Continued)

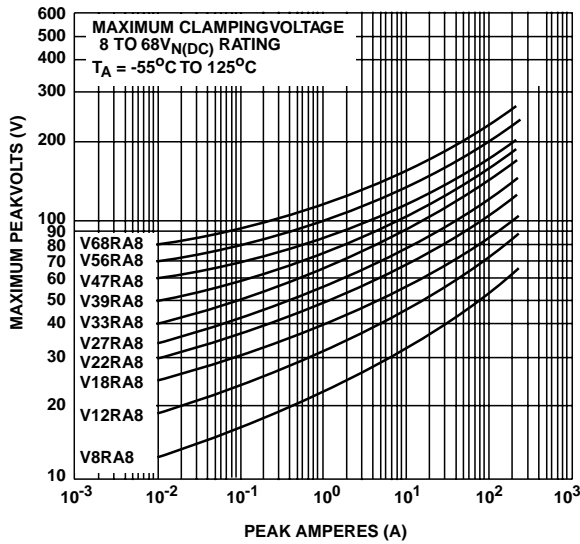

FIGURE 3. CLAMPING VOLTAGE FOR V8RA8 - V68RA8

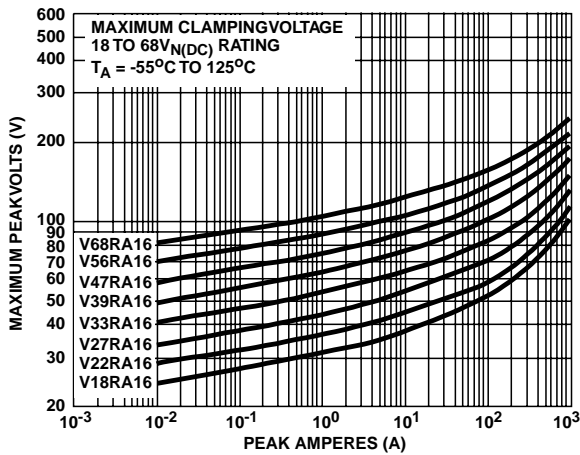

FIGURE 5. CLAMPING VOLTAGE FOR V18RA16 - V68RA16

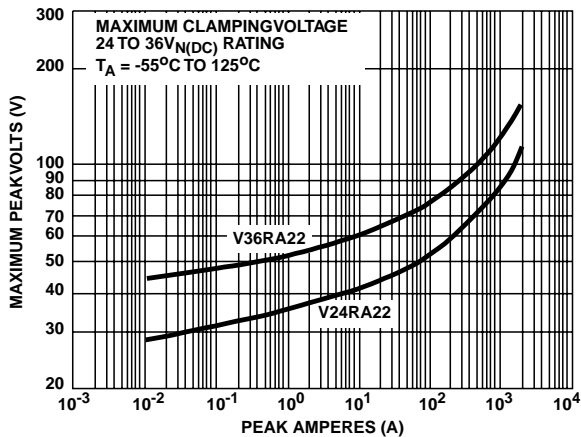

FIGURE 7. CLAMPING VOLTAGE FOR V24RA22 - V36RA22

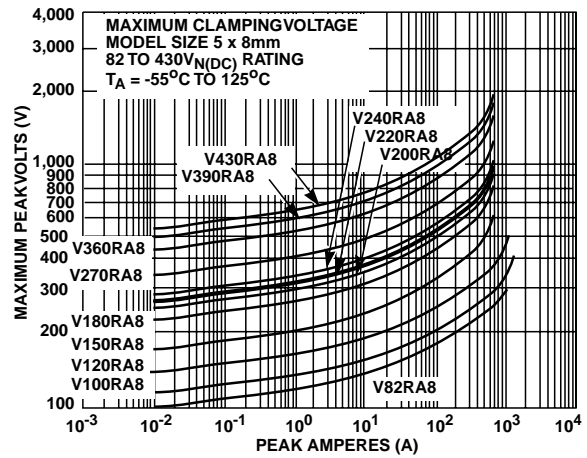

FIGURE 4. CLAMPING VOLTAGE FOR V82RA8 - V430RA8

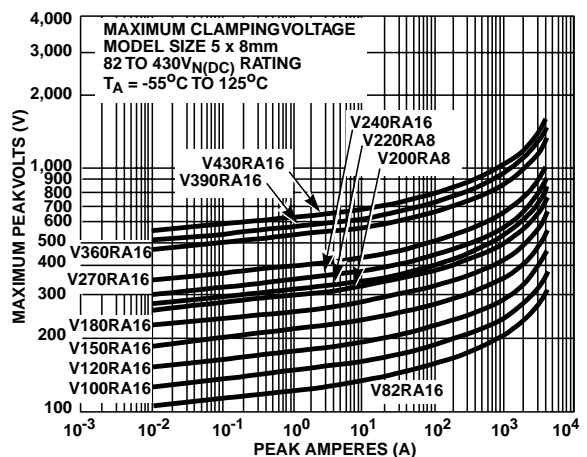

FIGURE 6. CLAMPING VOLTAGE FOR V82RA16 - V430RA16

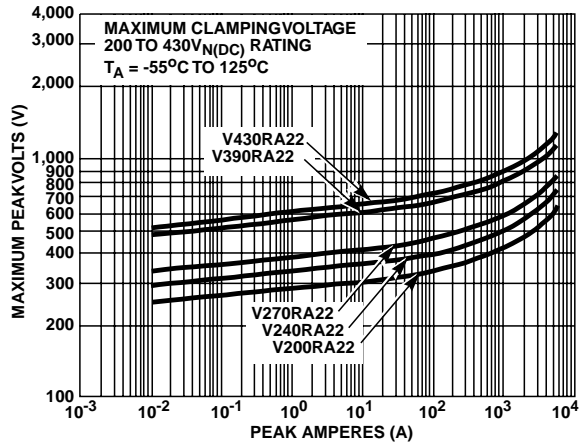

FIGURE 8. CLAMPING VOLTAGE FOR V200RA22 - V430RA22

Varistor Products

Low Profile

RA Varistor Series

Pulse Rating Curves (Continued)

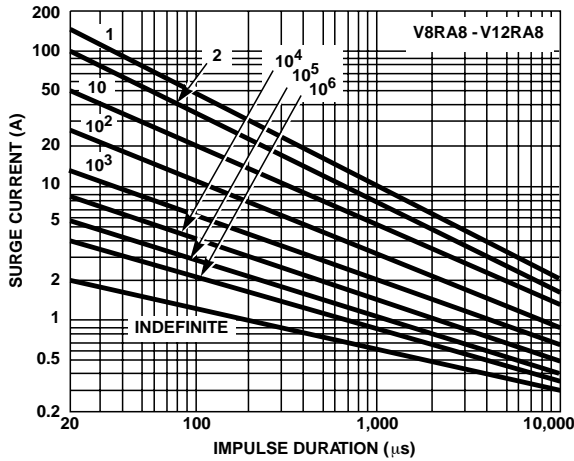

FIGURE 9. SURGE CURRENT RATING CURVES FOR V8RA8 - V12RA8

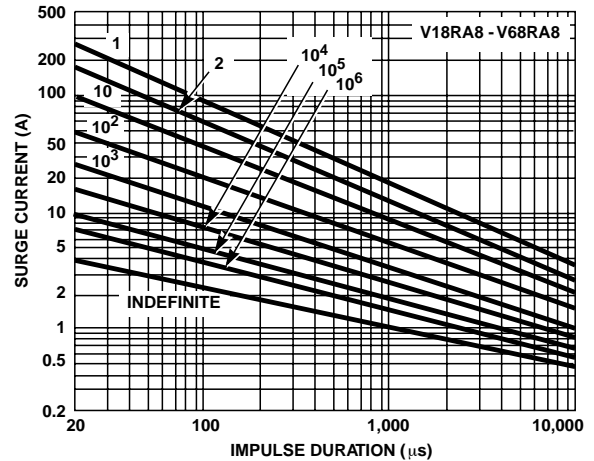

FIGURE 10. SURGE CURRENT RATING CURVES FOR V18RA8 - V68RA8

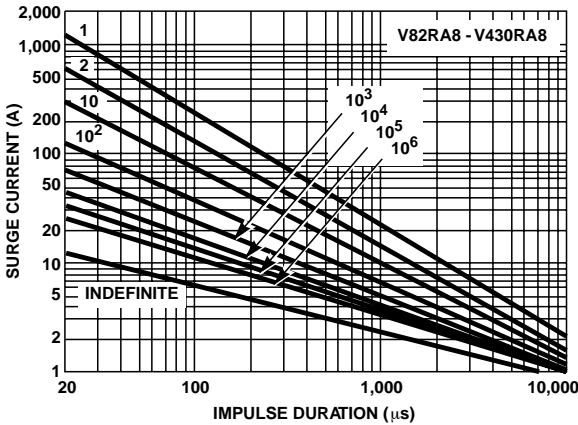

FIGURE 11. SURGE CURRENT RATING CURVES FOR V82RA8 - V430RA8

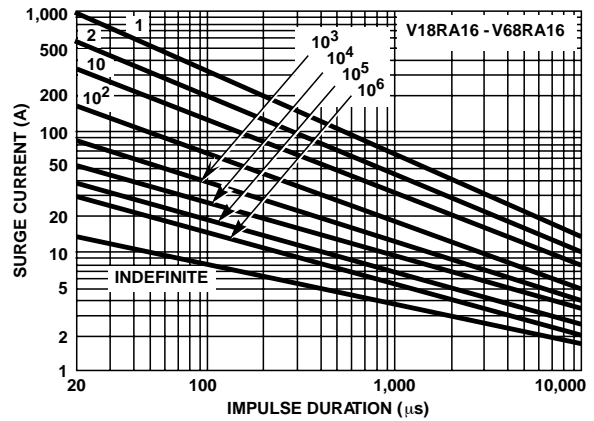

FIGURE 12. SURGE CURRENT RATING CURVES FOR V18RA16 - V68RA16

NOTE: If pulse ratings are exceeded, a shift of $V_{N(DC)}$ (at specified current) of more than $\pm 10\%$ could result. This type of shift, which normally results in a decrease of $V_{N(DC)}$, may result in the device not meeting the original published specifications, but it does not prevent the device from continuing to function, and to provide ample protection.

Varistor Products

Low Profile

RA Varistor Series

Pulse Rating Curves (Continued)

2

VARISTOR PRODUCTS

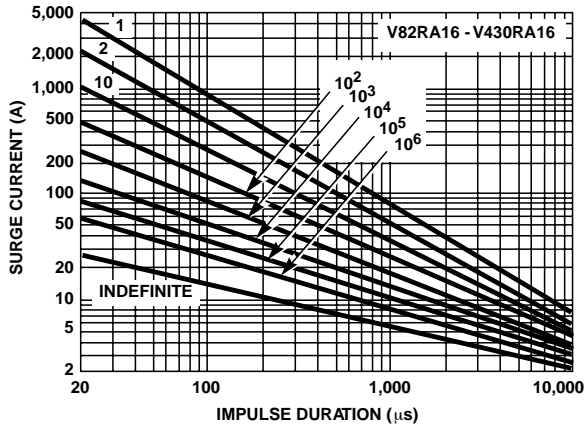

FIGURE 13. SURGE CURRENT RATING CURVES FOR V82RA16 - V430RA16

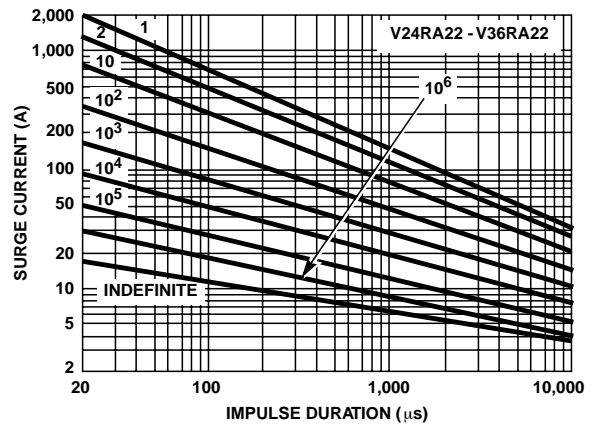

FIGURE 14. SURGE CURRENT RATING CURVES FOR V24RA22 - V36RA22

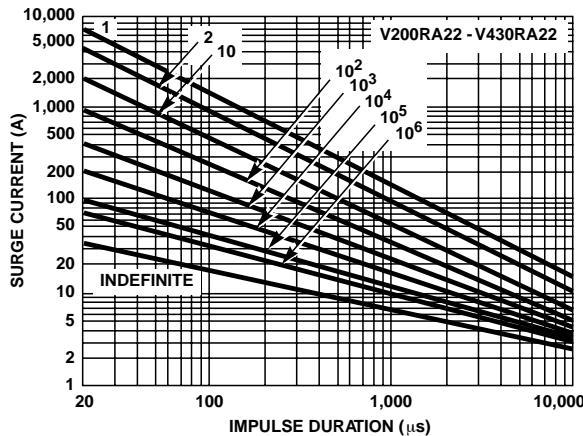

FIGURE 15. SURGE CURRENT RATING CURVES FOR V200RA22 - V430RA22

Varistor Products

Low Profile

RA Varistor Series

Mechanical Dimensions

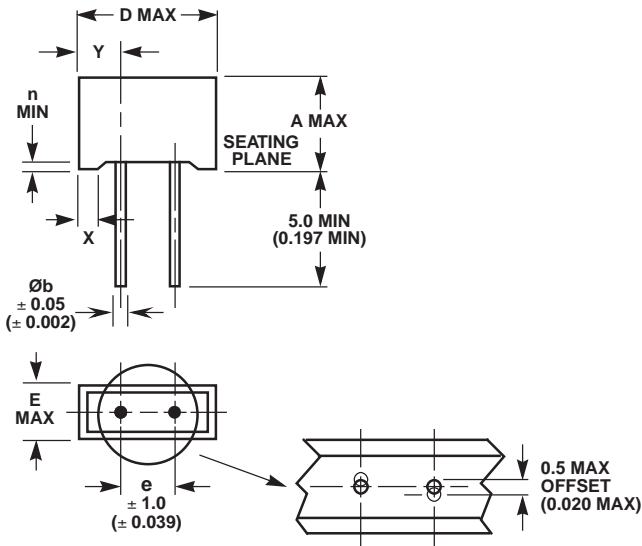

SYMBOL	RA8 SERIES	RA16 SERIES	RA22 SERIES
A MAX	8.85 (0.348)	15.1 (0.594)	19.1 (0.752)
D MAX	11.45 (0.450)	19.7 (0.776)	25.5 (1.004)
e	5 (0.197)	7.5 (0.295)	7.5 (0.295)
E MAX	5.2 (0.205)	6.3 (0.248)	6.3 (0.248)
n MAX	0.7 (0.027)	0.7 (0.027)	0.7 (0.027)
Øb	0.635 (0.025)	0.81 (0.032)	0.81 (0.032)
WEIGHT TYP	1 Gram	3.4 Grams	4.4 Grams
X	22 (0.087)	2.2 (0.087)	4.4 (0.173)
Y	3.1 ± 0.5 (0.122 ± 0.02)	6 ± 1 (0.236 ± 0.04)	8.9 ± 1 (0.35 ± 0.04)

NOTES:

- Dimensions in mm, dimensions in inches in parentheses.
- Inches for reference only.

Ordering Information

The RA Series is supplied in bulk pack.

