



DLP™ PROJECTOR

MODEL

EIP-4500

SETUP GUIDE

Setting up the Screen	2
Screen Size and Projection Distance	3
Connecting Pin Assignments	10
RS-232C Specifications and Commands	12
Setting up the Projector Network Environment ...	17
1. Connecting the Projector to a Computer.....	18
2. Setting an IP Address for the Computer	19
3. Setting up a Network Connection for the Projector ...	21
Controlling the Projector via LAN	23
Controlling the Projector Using Internet Explorer (Version 5.0 or later)	23
Confirming the Projector Status (Status)	24
Controlling the Projector (Control)	24
Setting and Adjusting the Projector (Settings & Adjustments)	25
Setting the Security (Network – Security)	25
Making General Settings for the Network (Network – General)	26
Setting for Sending E-mail when an Error Occurs (Mail – Originator Settings)	26
Setting Error Items and Destination Addresses to which E-mail is to be Sent when an Error Occurs (Mail – Recipient Settings) ...	27
Setting the Projector Using RS-232C or Telnet ...	28
When Connecting Using RS-232C	28
When Connecting Using Telnet	29
SETUP MENU (Main Menu)	30
ADVANCED SETUP MENU	30
Controlling the Projector Using RS-232C or Telnet ...	31
View Setting Detail List ([V]View All Setting)	31
Set Items	31
Save Settings and Quit ([S]Save & Quit)	32
Quit without Saving Settings ([Q]Quit Unchanged) ...	32
IP Address Setting ([1]IP Address)	33
Subnet Mask Setting ([2]Subnet Mask)	33
Default Gateway Setting ([3]Default Gateway)	33
User Name Setting ([4]User Name)	34
Password Setting ([5>Password)	34
RS-232C Baud Rate Setting ([6]RS-232C Baud Rate)	34
Projector Name Setting ([7]Projector Name)	34
Disconnecting All Connections ([D]Disconnect All)	35
Entering ADVANCED SETUP MENU ([A]Advanced Setup)	35
Setting Auto Logout Time (ADVANCED[1]Auto Logout Time)	35
Data Port Setting (ADVANCED[2]Data Port)	35
Carrying out Network Ping Test (ADVANCED[5]Network Ping Test)	36
Setting of Accept IP Address (ADVANCED[6]Accept IP Addr(1) – [8]Accept IP Addr(3))	36
Accepting All IP Addresses (ADVANCED[9]Accept All IP Addr)	36
Setting of Search Port (ADVANCED[0]Search Port)	37
Return to Default Settings (ADVANCED[!]Restore Default Setting)	37
Return to Main Menu (ADVANCED[Q]Return to Main Menu)	37
Stack Projection	38
Setting up the Stack Projection	39
Video Wall Projection	41
Setting up the Video Wall Projection [Basic]	42
Adjusting the Position Horizontally and Vertically ...	44
Returning to the Default Video Wall Setup	44
Assigning the Projected Image on the Video Wall Setup	44
Notes on the Wide Video Wall Projection	45
Setting up the Video Wall Projection [Application] ..	46
Troubleshooting	50
Dimensions	53

Setting up the Screen

Position the projector perpendicular to the screen with all feet flat and level to achieve an optimal image.

Note

- The projector lens should be centered in the middle of the screen. If the horizontal line passing through the lens center is not perpendicular to the screen, the image will be distorted, making viewing difficult.
- For an optimal image, position the screen so that it is not in direct sunlight or room light. Light falling directly on the screen washes out the colors, making viewing difficult. Close the curtains and dim the lights when setting up the screen in a sunny or bright room.

Standard Setup (Front Projection)

- Place the projector at the required distance from the screen according to the desired picture size.

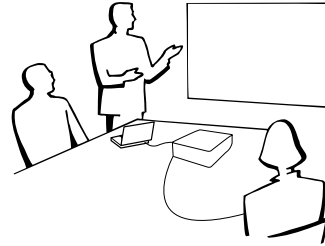

Example of standard setup

Screen size : 100 inch (254 cm) STRETCH Mode : 16:9 (When the standard zoom lens attached)

Side View

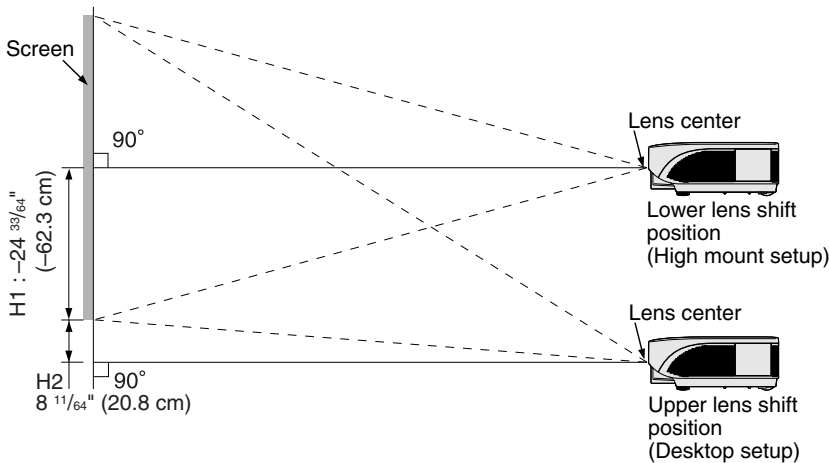

- The distance from the screen to the projector may vary depending on the size of the screen.
- The default setting can be used, when placing the projector in front of the screen. If the projected image is reversed, readjust the setting to "Front" in the "PRJ Mode" menu. (See page 84 on the owner's manual of the projector.)

Top View

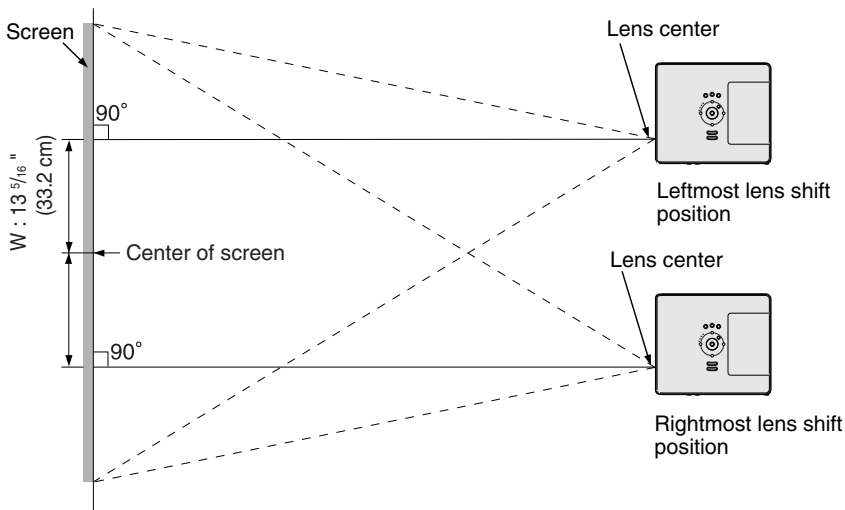

- Place the projector so that an imaginary horizontal line that passes through the center of the lens is perpendicular to the screen.



Screen Size and Projection Distance

The projection screen size varies according to the distance from the lens of the projector to the screen. The optional lenses from EIKI are also available for specialized application. Please see your nearest EIKI Authorized Dealer to details on all the lenses. (Refer to the lens owner's manual when using a lens.) Also, ensure to have service personnel install the optional lenses.

Install the projector so that projected images are projected onto the screen at the optimum size by referring to the table. Use the values in the table as a reference when installing the projector.

Throw Distance

The graph below is for 100 inches (254 cm) screen with 4:3 normal mode.

Screen

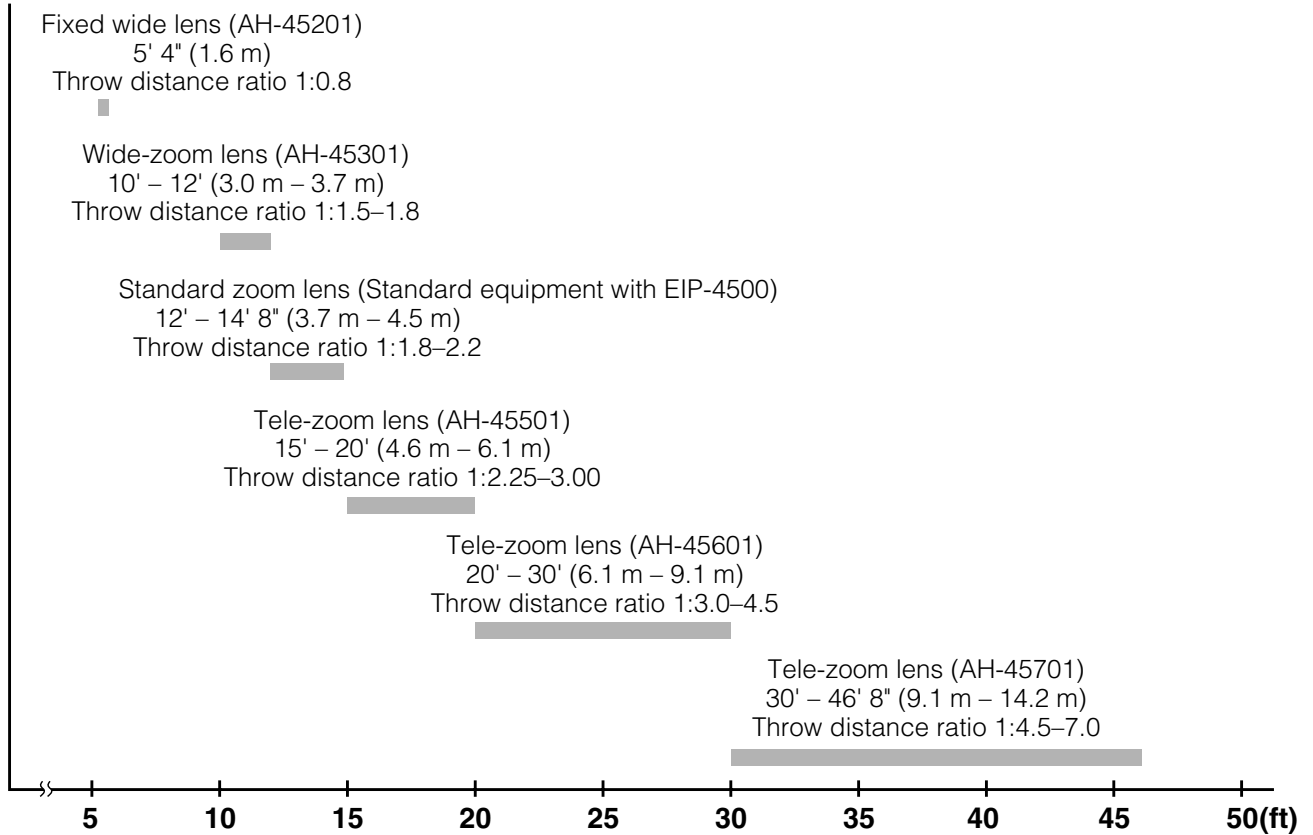

Screen Size and Projection Distance

Standard Zoom Lens (Standard equipment with EIP-4500) F1.8-F2.0, f=25.6-31.3 mm

NORMAL Mode (4:3)

Picture (Screen) size			Projection distance [L]		Distance from the lens center to the bottom of the image [H]		Distance from the lens center to the center of the image [W]
Diag. [χ]	Width	Height	Minimum [L1]	Maximum [L2]	Lower [H1]	Upper [H2]	
300" (762 cm)	610 cm (240")	457 cm (180")	11.0 m (36' 0")	13.4 m (44' 0")	-228.6 cm (-90")	0 cm (0")	±91.4 cm (36")
250" (635 cm)	508 cm (200")	381 cm (150")	9.1 m (30' 0")	11.2 m (36' 8")	-190.5 cm (-75")	0 cm (0")	±76.2 cm (30")
200" (508 cm)	406 cm (160")	305 cm (120")	7.3 m (24' 0")	8.9 m (29' 4")	-152.4 cm (-60")	0 cm (0")	±61.0 cm (24")
150" (381 cm)	305 cm (120")	229 cm (90")	5.5 m (18' 0")	6.7 m (22' 0")	-114.3 cm (-45")	0 cm (0")	±45.7 cm (18")
100" (254 cm)	203 cm (80")	152 cm (60")	3.7 m (12' 0")	4.5 m (14' 8")	-76.2 cm (-30")	0 cm (0")	±30.5 cm (12")
84" (213 cm)	171 cm (67")	128 cm (50")	3.1 m (10' 1")	3.8 m (12' 4")	-64.0 cm (-25 13/64")	0 cm (0")	±25.6 cm (10 5/64")
80" (203 cm)	163 cm (64")	122 cm (48")	2.9 m (9' 7")	3.6 m (11' 9")	-61.0 cm (-24")	0 cm (0")	±24.4 cm (9 19/32")
72" (183 cm)	146 cm (58")	110 cm (43")	2.6 m (8' 8")	3.2 m (10' 7")	-54.9 cm (-21 19/32")	0 cm (0")	±21.9 cm (8 41/64")
70" (178 cm)	142 cm (56")	107 cm (42")	2.6 m (8' 5")	3.1 m (10' 3")	-53.3 cm (-21")	0 cm (0")	±21.3 cm (8 13/32")
60" (152 cm)	122 cm (48")	91 cm (36")	2.2 m (7' 2")	2.7 m (8' 10")	-45.7 cm (-18")	0 cm (0")	±18.3 cm (7 13/64")
40" (102 cm)	81 cm (32")	61 cm (24")	1.5 m (4' 10")	1.8 m (5' 10")	-30.5 cm (-12")	0 cm (0")	±12.2 cm (4 51/64")

χ: Picture size (diag.) (in/cm)
 L: Projection distance(m/ft)
 L1: Minimum projection distance (m/ft)
 L2: Maximum projection distance (m/ft)
 H: Distance from the lens center to the bottom of the image (cm/in)
 H1: Lower distance from the lens center to the bottom of the image (cm/in)
 H2: Upper distance from the lens center to the bottom of the image (cm/in)
 W: Distance from the lens center to the center of the image (cm/in)

The formula for picture size and projection distance
[m/cm]
 L1 (m) = 0.03658X
 L2 (m) = 0.0447X
 H1 (cm) = -0.762X
 W (cm) = ±0.3048X
[Feet/inches]
 L1 (ft) = 0.03658X / 0.3048
 L2 (ft) = 0.0447X / 0.3048
 H1 (in) = -0.762X / 2.54
 W (in) = ±0.3048X / 2.54

STRETCH Mode (16:9)

Picture (Screen) size			Projection distance [L]		Distance from the lens center to the bottom of the image [H]		Distance from the lens center to the center of the image [W]
Diag. [χ]	Width	Height	Minimum [L1]	Maximum [L2]	Lower [H1]	Upper [H2]	
225" (572 cm)	498 cm (196")	280 cm (110")	9.0 m (29' 5")	11.0 m (35' 11")	-140.1 cm (-55 5/32")	46.7 cm (18 25/64")	±74.7 cm (29 27/64")
200" (508 cm)	443 cm (174")	249 cm (98")	8.0 m (26' 2")	9.7 m (31' 11")	-124.5 cm (-49 1/32")	41.5 cm (16 11/32")	±66.4 cm (26 9/64")
150" (381 cm)	332 cm (131")	187 cm (74")	6.0 m (19' 7")	7.3 m (24' 0")	-93.4 cm (-36 49/64")	31.1 cm (12 1/4")	±49.8 cm (19 39/64")
133" (338 cm)	294 cm (116")	166 cm (65")	5.3 m (17' 5")	6.5 m (21' 3")	-82.8 cm (-32 39/64")	27.6 cm (10 7/8")	±44.2 cm (17 25/64")
106" (269 cm)	235 cm (92")	132 cm (52")	4.2 m (13' 10")	5.2 m (16' 11")	-66.0 cm (-25 63/64")	22.0 cm (8 21/32")	±35.2 cm (13 55/64")
100" (254 cm)	221 cm (87")	125 cm (49")	4.0 m (13' 1")	4.9 m (16' 0")	-62.3 cm (-24 33/64")	20.8 cm (8 11/64")	±33.2 cm (13 5/64")
92" (234 cm)	204 cm (80")	115 cm (45")	3.7 m (12' 0")	4.5 m (14' 8")	-57.3 cm (-22 35/64")	19.1 cm (7 33/64")	±30.6 cm (12 1/32")
84" (213 cm)	186 cm (73")	105 cm (41")	3.3 m (11' 0")	4.1 m (13' 5")	-52.3 cm (-20 19/32")	17.4 cm (6 55/64")	±27.9 cm (10 63/64")
72" (183 cm)	159 cm (63")	90 cm (35")	2.9 m (9' 5")	3.5 m (11' 6")	-44.8 cm (-17 21/32")	14.9 cm (5 57/64")	±23.9 cm (9 13/32")
60" (152 cm)	133 cm (52")	75 cm (29")	2.4 m (7' 10")	2.9 m (9' 7")	-37.4 cm (-14 45/64")	12.5 cm (4 29/32")	±19.9 cm (7 27/32")
40" (102 cm)	89 cm (35")	50 cm (20")	1.6 m (5' 3")	1.9 m (6' 5")	-24.9 cm (-9 13/16")	8.3 cm (3 17/64")	±13.3 cm (5 15/64")

χ: Picture size (diag.) (in/cm)
 L: Projection distance(m/ft)
 L1: Minimum projection distance (m/ft)
 L2: Maximum projection distance (m/ft)
 H: Distance from the lens center to the bottom of the image (cm/in)
 H1: Lower distance from the lens center to the bottom of the image (cm/in)
 H2: Upper distance from the lens center to the bottom of the image (cm/in)
 W: Distance from the lens center to the center of the image (cm/in)

The formula for picture size and projection distance
[m/cm]
 L1 (m) = 0.03985X
 L2 (m) = 0.0487X
 H1 (cm) = -0.62263X
 H2 (cm) = 0.20754X
 W (cm) = ±0.33207X
[Feet/inches]
 L1 (ft) = 0.03985X / 0.3048
 L2 (ft) = 0.0487X / 0.3048
 H1 (in) = -0.62263X / 2.54
 H2 (in) = 0.20754X / 2.54
 W (in) = ±0.33207X / 2.54



Note

- There may be an error of ± 3% in the above values.
- Values with a minus (-) sign indicate the distance from the lens center below the bottom of the image.

Fixed Wide Lens (AH-45201)

F2.5, f=11.6 mm

NORMAL Mode (4:3)

Picture (Screen) size			Projection distance [L]	Distance from the lens center to the bottom of the image [H]		Distance from the lens center to the center of the image [W]
Diag. [χ]	Width	Height		Lower [H1]	Upper [H2]	
150" (381 cm)	305 cm (120")	229 cm (90")	2.4 m (8' 0")	-114.3 cm (-45")	-73.2 cm (-28 51/64")	±33.5 cm (13 13/64")
100" (254 cm)	203 cm (80")	152 cm (60")	1.6 m (5' 4")	-76.2 cm (-30")	-48.8 cm (-19 13/64")	±22.4 cm (8 51/64")
84" (213 cm)	171 cm (67")	128 cm (50")	1.4 m (4' 6")	-64.0 cm (-25 13/64")	-41.0 cm (-16 1/8")	±18.8 cm (7 25/64")
80" (203 cm)	163 cm (64")	122 cm (48")	1.3 m (4' 3")	-61.0 cm (-24")	-39.0 cm (-15 23/64")	±17.9 cm (7 3/64")

χ: Picture size (diag.) (in/cm)
 L: Projection distance(m/ft)
 H: Distance from the lens center to the bottom of the image (cm/in)
 H1: Lower distance from the lens center to the bottom of the image (cm/in)
 H2: Upper distance from the lens center to the bottom of the image (cm/in)
 W: Distance from the lens center to the center of the image (cm/in)

The formula for picture size and projection distance

[m/cm]
 L (m) = 0.01626χ
 H1 (cm) = -0.762χ
 H2 (cm) = -0.48768χ
 W (cm) = ±0.22352χ
[Feet/inches]
 L (ft) = 0.01626χ / 0.3048
 H1 (in) = -0.762χ / 2.54
 H2 (in) = -0.48768χ / 2.54
 W (in) = ±0.22352χ / 2.54

STRETCH Mode (16:9)

Picture (Screen) size			Projection distance [L]	Distance from the lens center to the bottom of the image [H]		Distance from the lens center to the center of the image [W]
Diag. [χ]	Width	Height		Lower [H1]	Upper [H2]	
133" (338 cm)	294 cm (116")	166 cm (65")	2.4 m (7' 9")	-82.8 cm (-32 39/64")	-43.1 cm (-16 61/64")	±32.4 cm (12 3/4")
106" (269 cm)	235 cm (92")	132 cm (52")	1.9 m (6' 2")	-66.0 cm (-25 63/64")	-34.3 cm (-13 33/64")	±25.8 cm (10 5/32")
100" (254 cm)	221 cm (87")	125 cm (49")	1.8 m (5' 10")	-62.3 cm (-24 33/64")	-32.4 cm (-12 3/4")	±24.4 cm (9 19/32")
92" (234 cm)	204 cm (80")	115 cm (45")	1.6 m (5' 4")	-57.3 cm (-22 35/64")	-29.8 cm (-11 47/64")	±24.4 cm (8 53/64")
84" (213 cm)	186 cm (73")	105 cm (41")	1.5 m (4' 11")	-52.3 cm (-20 19/32")	-27.2 cm (-10 45/64")	±20.5 cm (8 3/64")
72" (183 cm)	159 cm (63")	90 cm (35")	1.3 m (4' 2")	-44.8 cm (-17 21/32")	-23.3 cm (-9 11/64")	±17.5 cm (6 29/32")

χ: Picture size (diag.) (in/cm)
 L: Projection distance(m/ft)
 H: Distance from the lens center to the bottom of the image (cm/in)
 H1: Lower distance from the lens center to the bottom of the image (cm/in)
 H2: Upper distance from the lens center to the bottom of the image (cm/in)
 W: Distance from the lens center to the center of the image (cm/in)

The formula for picture size and projection distance

[m/cm]
 L (m) = 0.01771χ
 H1 (cm) = -0.62263χ
 H2 (cm) = -0.32377χ
 W (cm) = ±0.24352χ
[Feet/inches]
 L (ft) = 0.01771χ / 0.3048
 H1 (in) = -0.62263χ / 2.54
 H2 (in) = -0.32377χ / 2.54
 W (in) = ±0.24352χ / 2.54



Note

- There may be an error of ± 3% in the above values.
- Values with a minus (-) sign indicate the distance from the lens center below the bottom of the image.

Screen Size and Projection Distance

Wide-zoom Lens (AH-45301)

F2.5, f=21.2-25.8 mm

NORMAL Mode (4:3)

Picture (Screen) size			Projection distance [L]		Distance from the lens center to the bottom of the image [H]		Distance from the lens center to the center of the image [W]
Diag. [χ]	Width	Height	Minimum [L1]	Maximum [L2]	Lower [H1]	Upper [H2]	
250" (635 cm)	508 cm (200")	381 cm (150")	7.6 m (25' 0")	9.1 m (30' 0")	-190.5 cm (-75")	0 cm (0")	±76.2 cm (30")
200" (508 cm)	406 cm (160")	305 cm (120")	6.1 m (20' 0")	7.3 m (24' 0")	-152.4 cm (-60")	0 cm (0")	±61.0 cm (24")
150" (381 cm)	305 cm (120")	229 cm (90")	4.6 m (15' 0")	5.5 m (18' 0")	-114.3 cm (-45")	0 cm (0")	±45.7 cm (18")
100" (254 cm)	203 cm (80")	152 cm (60")	3.0 m (10' 0")	3.7 m (12' 0")	-76.2 cm (-30")	0 cm (0")	±30.5 cm (12")
84" (213 cm)	171 cm (67")	128 cm (50")	2.6 m (8' 5")	3.1 m (10' 1")	-64.0 cm (-25 13/64")	0 cm (0")	±25.6 cm (10 5/64")
80" (203 cm)	163 cm (64")	122 cm (48")	2.4 m (8' 0")	2.9 m (9' 7")	-61.0 cm (-24")	0 cm (0")	±24.4 cm (9 19/32")
72" (183 cm)	146 cm (58")	110 cm (43")	2.2 m (7' 2")	2.6 m (8' 8")	-54.9 cm (-21 19/32")	0 cm (0")	±21.9 cm (8 41/64")
70" (178 cm)	142 cm (56")	107 cm (42")	2.1 m (7' 0")	2.6 m (8' 5")	-53.3 cm (-21")	0 cm (0")	±21.3 cm (8 13/32")
60" (152 cm)	122 cm (48")	91 cm (36")	1.8 m (6' 0")	2.2 m (7' 2")	-45.7 cm (-18")	0 cm (0")	±18.3 cm (7 13/64")

χ: Picture size (diag.) (in/cm)
 L: Projection distance(m/ft)
 L1: Minimum projection distance (m/ft)
 L2: Maximum projection distance (m/ft)
 H: Distance from the lens center to the bottom of the image (cm/in)
 H1: Lower distance from the lens center to the bottom of the image (cm/in)
 H2: Upper distance from the lens center to the bottom of the image (cm/in)
 W: Distance from the lens center to the center of the image (cm/in)

The formula for picture size and projection distance
[m/cm]
 L1 (m) = 0.03048X
 L2 (m) = 0.03658X
 H1 (cm) = -0.762X
 W (cm) = ±0.3048X
[Feet/inches]
 L1 (ft) = 0.03048X / 0.3048
 L2 (ft) = 0.03658X / 0.3048
 H1 (in) = -0.762X / 2.54
 W (in) = ±0.3048X / 2.54

STRETCH Mode (16:9)

Picture (Screen) size			Projection distance [L]		Distance from the lens center to the bottom of the image [H]		Distance from the lens center to the center of the image [W]
Diag. [χ]	Width	Height	Minimum [L1]	Maximum [L2]	Lower [H1]	Upper [H2]	
225" (572 cm)	498 cm (196")	280 cm (110")	7.5 m (24' 6")	9.0 m (29' 5")	-140.1 cm (-55 5/32")	46.7 cm (18 25/64")	±74.7 cm (29 27/64")
200" (508 cm)	443 cm (174")	249 cm (98")	6.6 m (21' 9")	8.0 m (26' 2")	-124.5 cm (-49 1/32")	41.5 cm (16 11/32")	±66.4 cm (26 9/64")
150" (381 cm)	332 cm (131")	187 cm (74")	5.0 m (16' 4")	6.0 m (19' 7")	-93.4 cm (-36 49/64")	31.1 cm (12 1/4")	±49.8 cm (19 39/64")
133" (338 cm)	294 cm (116")	166 cm (65")	4.4 m (14' 6")	5.3 m (17' 5")	-82.8 cm (-32 39/64")	27.6 cm (10 7/8")	±44.2 cm (17 25/64")
106" (269 cm)	235 cm (92")	132 cm (52")	3.5 m (11' 7")	4.2 m (13' 10")	-66.0 cm (-25 63/64")	22.0 cm (8 21/32")	±35.2 cm (13 55/64")
100" (254 cm)	221 cm (87")	125 cm (49")	3.3 m (10' 11")	4.0 m (13' 1")	-62.3 cm (-24 33/64")	20.8 cm (8 11/64")	±33.2 cm (13 5/64")
92" (234 cm)	204 cm (80")	115 cm (45")	3.1 m (10' 0")	3.7 m (12' 0")	-57.3 cm (-22 35/64")	19.1 cm (7 33/64")	±30.6 cm (12 1/32")
84" (213 cm)	186 cm (73")	105 cm (41")	2.8 m (9' 2")	3.3 m (11' 0")	-52.3 cm (-20 19/32")	17.4 cm (6 55/64")	±27.9 cm (10 63/64")
72" (183 cm)	159 cm (63")	90 cm (35")	2.4 m (7' 10")	2.9 m (9' 5")	-44.8 cm (-17 21/32")	14.9 cm (5 57/64")	±23.9 cm (9 13/32")
60" (152 cm)	133 cm (52")	75 cm (29")	2.0 m (6' 6")	2.4 m (7' 10")	-37.4 cm (-14 45/64")	12.5 cm (4 29/32")	±19.9 cm (7 27/32")

χ: Picture size (diag.) (in/cm)
 L: Projection distance(m/ft)
 L1: Minimum projection distance (m/ft)
 L2: Maximum projection distance (m/ft)
 H: Distance from the lens center to the bottom of the image (cm/in)
 H1: Lower distance from the lens center to the bottom of the image (cm/in)
 H2: Upper distance from the lens center to the bottom of the image (cm/in)
 W: Distance from the lens center to the center of the image (cm/in)

The formula for picture size and projection distance
[m/cm]
 L1 (m) = 0.03321X
 L2 (m) = 0.03985X
 H1 (cm) = -0.62263X
 H2 (cm) = 0.20754X
 W (cm) = ±0.33207X
[Feet/inches]
 L1 (ft) = 0.03321X / 0.3048
 L2 (ft) = 0.03985X / 0.3048
 H1 (in) = -0.62263X / 2.54
 H2 (in) = 0.20754X / 2.54
 W (in) = ±0.33207X / 2.54



- There may be an error of ± 3% in the above values.
- Values with a minus (-) sign indicate the distance from the lens center below the bottom of the image.

Tele-zoom Lens (AH-45501)

F2.4-F2.5, f=31.9-42.5 mm

NORMAL Mode (4:3)

Picture (Screen) size			Projection distance [L]		Distance from the lens center to the bottom of the image [H]		Distance from the lens center to the center of the image [W]
Diag. [χ]	Width	Height	Minimum [L1]	Maximum [L2]	Lower [H1]	Upper [H2]	
250" (635 cm)	508 cm (200")	381 cm (150")	11.4 m (37' 6")	15.2 m (50' 0")	-190.5 cm (-75")	0 cm (0")	±76.2 cm (30")
200" (508 cm)	406 cm (160")	305 cm (120")	9.1 m (30' 0")	12.2 m (40' 0")	-152.4 cm (-60")	0 cm (0")	±61.0 cm (24")
150" (381 cm)	305 cm (120")	229 cm (90")	6.9 m (22' 6")	9.1 m (30' 0")	-114.3 cm (-45")	0 cm (0")	±45.7 cm (18")
100" (254 cm)	203 cm (80")	152 cm (60")	4.6 m (15' 0")	6.1 m (20' 0")	-76.2 cm (-30")	0 cm (0")	±30.5 cm (12")
84" (213 cm)	171 cm (67")	128 cm (50")	3.8 m (12' 7")	5.1 m (16' 10")	-64.0 cm (-25 13/64")	0 cm (0")	±25.6 cm (10 5/64")
80" (203 cm)	163 cm (64")	122 cm (48")	3.7 m (12' 0")	4.9 m (16' 0")	-61.0 cm (-24")	0 cm (0")	±24.4 cm (9 19/32")
72" (183 cm)	146 cm (58")	110 cm (43")	3.3 m (10' 10")	4.4 m (14' 5")	-54.9 cm (-21 19/32")	0 cm (0")	±21.9 cm (8 41/64")
70" (178 cm)	142 cm (56")	107 cm (42")	3.2 m (10' 6")	4.3 m (14' 0")	-53.3 cm (-21")	0 cm (0")	±21.3 cm (8 13/32")
60" (152 cm)	122 cm (48")	91 cm (36")	2.7 m (9' 0")	3.7 m (12' 0")	-45.7 cm (-18")	0 cm (0")	±18.3 cm (7 13/64")

χ: Picture size (diag.) (in/cm)
 L: Projection distance(m/ft)
 L1: Minimum projection distance (m/ft)
 L2: Maximum projection distance (m/ft)
 H: Distance from the lens center to the bottom of the image (cm/in)
 H1: Lower distance from the lens center to the bottom of the image (cm/in)
 H2: Upper distance from the lens center to the bottom of the image (cm/in)
 W: Distance from the lens center to the center of the image (cm/in)

The formula for picture size and projection distance
[m/cm]
 L1 (m) = 0.04572X
 L2 (m) = 0.06096X
 H1 (cm) = -0.762X
 W (cm) = ±0.3048X
[Feet/inches]
 L1 (ft) = 0.04572X / 0.3048
 L2 (ft) = 0.06096X / 0.3048
 H1 (in) = -0.762X / 2.54
 W (in) = ±0.3048X / 2.54

STRETCH Mode (16:9)

Picture (Screen) size			Projection distance [L]		Distance from the lens center to the bottom of the image [H]		Distance from the lens center to the center of the image [W]
Diag. [χ]	Width	Height	Minimum [L1]	Maximum [L2]	Lower [H1]	Upper [H2]	
225" (572 cm)	498 cm (196")	280 cm (110")	11.2 m (36' 9")	14.9 m (49' 0")	-140.1 cm (-55 5/32")	46.7 cm (18 25/64")	±74.7 cm (29 27/64")
200" (508 cm)	443 cm (174")	249 cm (98")	10.0 m (32' 8")	13.3 m (43' 7")	-124.5 cm (-49 1/32")	41.5 cm (16 11/32")	±66.4 cm (26 9/64")
150" (381 cm)	332 cm (131")	187 cm (74")	7.5 m (24' 6")	10.0 m (32' 8")	-93.4 cm (-36 49/64")	31.1 cm (12 1/4")	±49.8 cm (19 39/64")
133" (338 cm)	294 cm (116")	166 cm (65")	6.6 m (21' 9")	8.8 m (29' 0")	-82.8 cm (-32 39/64")	27.6 cm (10 7/8")	±44.2 cm (17 25/64")
106" (269 cm)	235 cm (92")	132 cm (52")	5.3 m (17' 4")	7.0 m (23' 1")	-66.0 cm (-25 63/64")	22.0 cm (8 21/32")	±35.2 cm (13 55/64")
100" (254 cm)	221 cm (87")	125 cm (49")	5.0 m (16' 4")	6.6 m (21' 9")	-62.3 cm (-24 33/64")	20.8 cm (8 11/64")	±33.2 cm (13 5/64")
92" (234 cm)	204 cm (80")	115 cm (45")	4.6 m (15' 0")	6.1 m (20' 1")	-57.3 cm (-22 35/64")	19.1 cm (7 33/64")	±30.6 cm (12 1/32")
84" (213 cm)	186 cm (73")	105 cm (41")	4.2 m (13' 9")	5.6 m (18' 4")	-52.3 cm (-20 19/32")	17.4 cm (6 55/64")	±27.9 cm (10 63/64")
72" (183 cm)	159 cm (63")	90 cm (35")	3.6 m (11' 9")	4.8 m (15' 8")	-44.8 cm (-17 21/32")	14.9 cm (5 57/64")	±23.9 cm (9 13/32")
60" (152 cm)	133 cm (52")	75 cm (29")	3.0 m (9' 10")	4.0 m (13' 1")	-37.4 cm (-14 45/64")	12.5 cm (4 29/32")	±19.9 cm (7 27/32")

χ: Picture size (diag.) (in/cm)
 L: Projection distance(m/ft)
 L1: Minimum projection distance (m/ft)
 L2: Maximum projection distance (m/ft)
 H: Distance from the lens center to the bottom of the image (cm/in)
 H1: Lower distance from the lens center to the bottom of the image (cm/in)
 H2: Upper distance from the lens center to the bottom of the image (cm/in)
 W: Distance from the lens center to the center of the image (cm/in)

The formula for picture size and projection distance
[m/cm]
 L1 (m) = 0.04981X
 L2 (m) = 0.06641X
 H1 (cm) = -0.62263X
 H2 (cm) = 0.20754X
 W (cm) = ±0.33207X
[Feet/inches]
 L1 (ft) = 0.04981X / 0.3048
 L2 (ft) = 0.06641X / 0.3048
 H1 (in) = -0.62263X / 2.54
 H2 (in) = 0.20754X / 2.54
 W (in) = ±0.33207X / 2.54



- There may be an error of ± 3% in the above values.
- Values with a minus (-) sign indicate the distance from the lens center below the bottom of the image.

Screen Size and Projection Distance

Tele-zoom Lens (AH-45601)

F2.5, f=40.8-62.8 mm

NORMAL Mode (4:3)

Picture (Screen) size			Projection distance [L]		Distance from the lens center to the bottom of the image [H]		Distance from the lens center to the center of the image [W]
Diag. [χ]	Width	Height	Minimum [L1]	Maximum [L2]	Lower [H1]	Upper [H2]	
250" (635 cm)	508 cm (200")	381 cm (150")	15.2 m (50' 0")	22.9 m (75' 0")	-190.5 cm (-75")	0 cm (0")	±76.2 cm (30")
200" (508 cm)	406 cm (160")	305 cm (120")	12.2 m (40' 0")	18.3 m (60' 0")	-152.4 cm (-60")	0 cm (0")	±61.0 cm (24")
150" (381 cm)	305 cm (120")	229 cm (90")	9.1 m (30' 0")	13.7 m (45' 0")	-114.3 cm (-45")	0 cm (0")	±45.7 cm (18")
100" (254 cm)	203 cm (80")	152 cm (60")	6.1 m (20' 0")	9.1 m (30' 0")	-76.2 cm (-30")	0 cm (0")	±30.5 cm (12")
84" (213 cm)	171 cm (67")	128 cm (50")	5.1 m (16' 10")	7.7 m (25' 2")	-64.0 cm (-25 13/64")	0 cm (0")	±25.6 cm (10 5/64")
80" (203 cm)	163 cm (64")	122 cm (48")	4.9 m (16' 0")	7.3 m (24' 0")	-61.0 cm (-24")	0 cm (0")	±24.4 cm (9 19/32")
72" (183 cm)	146 cm (58")	110 cm (43")	4.4 m (14' 5")	6.6 m (21' 7")	-54.9 cm (-21 19/32")	0 cm (0")	±21.9 cm (8 41/64")
70" (178 cm)	142 cm (56")	107 cm (42")	4.3 m (14' 0")	6.4 m (21' 0")	-53.3 cm (-21")	0 cm (0")	±21.3 cm (8 13/32")
60" (152 cm)	122 cm (48")	91 cm (36")	3.7 m (12' 0")	5.5 m (18' 0")	-45.7 cm (-18")	0 cm (0")	±18.3 cm (7 13/64")

χ: Picture size (diag.) (in/cm)
 L: Projection distance(m/ft)
 L1: Minimum projection distance (m/ft)
 L2: Maximum projection distance (m/ft)
 H: Distance from the lens center to the bottom of the image (cm/in)
 H1: Lower distance from the lens center to the bottom of the image (cm/in)
 H2: Upper distance from the lens center to the bottom of the image (cm/in)
 W: Distance from the lens center to the center of the image (cm/in)

The formula for picture size and projection distance
[m/cm]
 L1 (m) = 0.06096X
 L2 (m) = 0.09144X
 H1 (cm) = -0.762X
 W (cm) = ±0.3048X
[Feet/inches]
 L1 (ft) = 0.06096X / 0.3048
 L2 (ft) = 0.09144X / 0.3048
 H1 (in) = -0.762X / 2.54
 W (in) = ±0.3048X / 2.54

STRETCH Mode (16:9)

Picture (Screen) size			Projection distance [L]		Distance from the lens center to the bottom of the image [H]		Distance from the lens center to the center of the image [W]
Diag. [χ]	Width	Height	Minimum [L1]	Maximum [L2]	Lower [H1]	Upper [H2]	
225" (572 cm)	498 cm (196")	280 cm (110")	14.9 m (49' 0")	22.4 m (73' 6")	-140.1 cm (-55 5/32")	46.7 cm (18 25/64")	±74.7 cm (29 27/64")
200" (508 cm)	443 cm (174")	249 cm (98")	13.3 m (43' 7")	19.9 m (65' 4")	-124.5 cm (-49 1/32")	41.5 cm (16 11/32")	±66.4 cm (26 9/64")
150" (381 cm)	332 cm (131")	187 cm (74")	10.0 m (32' 8")	14.9 m (49' 0")	-93.4 cm (-36 49/64")	31.1 cm (12 1/4")	±49.8 cm (19 39/64")
133" (338 cm)	294 cm (116")	166 cm (65")	8.8 m (29' 0")	13.2 m (43' 6")	-82.8 cm (-32 39/64")	27.6 cm (10 7/8")	±44.2 cm (17 25/64")
106" (269 cm)	235 cm (92")	132 cm (52")	7.0 m (23' 1")	10.6 m (34' 8")	-66.0 cm (-25 63/64")	22.0 cm (8 21/32")	±35.2 cm (13 55/64")
100" (254 cm)	221 cm (87")	125 cm (49")	6.6 m (21' 9")	10.0 m (32' 8")	-62.3 cm (-24 33/64")	20.8 cm (8 11/64")	±33.2 cm (13 5/64")
92" (234 cm)	204 cm (80")	115 cm (45")	6.1 m (20' 1")	9.2 m (30' 1")	-57.3 cm (-22 35/64")	19.1 cm (7 33/64")	±30.6 cm (12 1/32")
84" (213 cm)	186 cm (73")	105 cm (41")	5.6 m (18' 4")	8.4 m (27' 5")	-52.3 cm (-20 19/32")	17.4 cm (6 55/64")	±27.9 cm (10 63/64")
72" (183 cm)	159 cm (63")	90 cm (35")	4.8 m (15' 8")	7.2 m (23' 6")	-44.8 cm (-17 21/32")	14.9 cm (5 57/64")	±23.9 cm (9 13/32")
60" (152 cm)	133 cm (52")	75 cm (29")	4.0 m (13' 1")	6.0 m (19' 7")	-37.4 cm (-14 45/64")	12.5 cm (4 29/32")	±19.9 cm (7 27/32")

χ: Picture size (diag.) (in/cm)
 L: Projection distance(m/ft)
 L1: Minimum projection distance (m/ft)
 L2: Maximum projection distance (m/ft)
 H: Distance from the lens center to the bottom of the image (cm/in)
 H1: Lower distance from the lens center to the bottom of the image (cm/in)
 H2: Upper distance from the lens center to the bottom of the image (cm/in)
 W: Distance from the lens center to the center of the image (cm/in)

The formula for picture size and projection distance
[m/cm]
 L1 (m) = 0.06641X
 L2 (m) = 0.09962X
 H1 (cm) = -0.62263X
 H2 (cm) = 0.20754X
 W (cm) = ±0.33207X
[Feet/inches]
 L1 (ft) = 0.06641X / 0.3048
 L2 (ft) = 0.09962X / 0.3048
 H1 (in) = -0.62263X / 2.54
 H2 (in) = 0.20754X / 2.54
 W (in) = ±0.33207X / 2.54



Note

- There may be an error of ± 3% in the above values.
- Values with a minus (-) sign indicate the distance from the lens center below the bottom of the image.

Tele-zoom Lens (AH-45701)

F2.4-F2.5, f=62.1-97.8 mm

NORMAL Mode (4:3)

Picture (Screen) size			Projection distance [L]		Distance from the lens center to the bottom of the image [H]		Distance from the lens center to the center of the image [W]
Diag. [χ]	Width	Height	Minimum [L1]	Maximum [L2]	Lower [H1]	Upper [H2]	
250" (635 cm)	508 cm (200")	381 cm (150")	22.9 m (75' 0")	35.6 m (116' 8")	-190.5 cm (-75")	0 cm (0")	±76.2 cm (30")
200" (508 cm)	406 cm (160")	305 cm (120")	18.3 m (60' 0")	28.4 m (93' 4")	-152.4 cm (-60")	0 cm (0")	±61.0 cm (24")
150" (381 cm)	305 cm (120")	229 cm (90")	13.7 m (45' 0")	21.3 m (70' 0")	-114.3 cm (-45")	0 cm (0")	±45.7 cm (18")
100" (254 cm)	203 cm (80")	152 cm (60")	9.1 m (30' 0")	14.2 m (46' 8")	-76.2 cm (-30")	0 cm (0")	±30.5 cm (12")
84" (213 cm)	171 cm (67")	128 cm (50")	7.7 m (25' 2")	11.9 m (39' 2")	-64.0 cm (-25 13/64")	0 cm (0")	±25.6 cm (10 5/64")
80" (203 cm)	163 cm (64")	122 cm (48")	7.3 m (24' 0")	11.4 m (37' 4")	-61.0 cm (-24")	0 cm (0")	±24.4 cm (9 19/32")
72" (183 cm)	146 cm (58")	110 cm (43")	6.6 m (21' 7")	10.2 m (33' 7")	-54.9 cm (-21 19/32")	0 cm (0")	±21.9 cm (8 41/64")
70" (178 cm)	142 cm (56")	107 cm (42")	6.4 m (21' 0")	10.0 m (32' 8")	-53.3 cm (-21")	0 cm (0")	±21.3 cm (8 13/32")
60" (152 cm)	122 cm (48")	91 cm (36")	5.5 m (18' 0")	8.5 m (28' 0")	-45.7 cm (-18")	0 cm (0")	±18.3 cm (7 13/64")

χ: Picture size (diag.) (in/cm)
 L: Projection distance(m/ft)
 L1: Minimum projection distance (m/ft)
 L2: Maximum projection distance (m/ft)
 H: Distance from the lens center to the bottom of the image (cm/in)
 H1: Lower distance from the lens center to the bottom of the image (cm/in)
 H2: Upper distance from the lens center to the bottom of the image (cm/in)
 W: Distance from the lens center to the center of the image (cm/in)

The formula for picture size and projection distance
[m/cm]
 L1 (m) = 0.09144X
 L2 (m) = 0.14224X
 H1 (cm) = -0.762X
 W (cm) = ±0.3048X
[Feet/inches]
 L1 (ft) = 0.09144X / 0.3048
 L2 (ft) = 0.14224X / 0.3048
 H1 (in) = -0.762X / 2.54
 W (in) = ±0.3048X / 2.54

STRETCH Mode (16:9)

Picture (Screen) size			Projection distance [L]		Distance from the lens center to the bottom of the image [H]		Distance from the lens center to the center of the image [W]
Diag. [χ]	Width	Height	Minimum [L1]	Maximum [L2]	Lower [H1]	Upper [H2]	
225" (572 cm)	498 cm (196")	280 cm (110")	22.4 m (73' 6")	34.9 m (114' 5")	-140.1 cm (-55 5/32")	46.7 cm (18 25/64")	±74.7 cm (29 27/64")
200" (508 cm)	443 cm (174")	249 cm (98")	19.9 m (65' 4")	31.0 m (101' 8")	-124.5 cm (-49 1/32")	41.5 cm (16 11/32")	±66.4 cm (26 9/64")
150" (381 cm)	332 cm (131")	187 cm (74")	14.9 m (49' 0")	23.2 m (76' 3")	-93.4 cm (-36 49/64")	31.1 cm (12 1/4")	±49.8 cm (19 39/64")
133" (338 cm)	294 cm (116")	166 cm (65")	13.2 m (43' 6")	20.6 m (67' 7")	-82.8 cm (-32 39/64")	27.6 cm (10 7/8")	±44.2 cm (17 25/64")
106" (269 cm)	235 cm (92")	132 cm (52")	10.6 m (34' 8")	16.4 m (53' 11")	-66.0 cm (-25 63/64")	22.0 cm (8 21/32")	±35.2 cm (13 55/64")
100" (254 cm)	221 cm (87")	125 cm (49")	10.0 m (32' 8")	15.5 m (50' 10")	-62.3 cm (-24 33/64")	20.8 cm (8 11/64")	±33.2 cm (13 5/64")
92" (234 cm)	204 cm (80")	115 cm (45")	9.2 m (30' 1")	14.3 m (46' 9")	-57.3 cm (-22 35/64")	19.1 cm (7 33/64")	±30.6 cm (12 1/32")
84" (213 cm)	186 cm (73")	105 cm (41")	8.4 m (27' 5")	13.0 m (42' 8")	-52.3 cm (-20 19/32")	17.4 cm (6 55/64")	±27.9 cm (10 63/64")
72" (183 cm)	159 cm (63")	90 cm (35")	7.2 m (23' 6")	11.2 m (36' 7")	-44.8 cm (-17 21/32")	14.9 cm (5 57/64")	±23.9 cm (9 13/32")
60" (152 cm)	133 cm (52")	75 cm (29")	6.0 m (19' 7")	9.3 m (30' 6")	-37.4 cm (-14 45/64")	12.5 cm (4 29/32")	±19.9 cm (7 27/32")

χ: Picture size (diag.) (in/cm)
 L: Projection distance(m/ft)
 L1: Minimum projection distance (m/ft)
 L2: Maximum projection distance (m/ft)
 H: Distance from the lens center to the bottom of the image (cm/in)
 H1: Lower distance from the lens center to the bottom of the image (cm/in)
 H2: Upper distance from the lens center to the bottom of the image (cm/in)
 W: Distance from the lens center to the center of the image (cm/in)

The formula for picture size and projection distance
[m/cm]
 L1 (m) = 0.09962X
 L2 (m) = 0.15497X
 H1 (cm) = -0.62263X
 H2 (cm) = 0.20754X
 W (cm) = ±0.33207X
[Feet/inches]
 L1 (ft) = 0.09962X / 0.3048
 L2 (ft) = 0.15497X / 0.3048
 H1 (in) = -0.62263X / 2.54
 H2 (in) = 0.20754X / 2.54
 W (in) = ±0.33207X / 2.54



- There may be an error of ± 3% in the above values.
- Values with a minus (-) sign indicate the distance from the lens center below the bottom of the image.

Connecting Pin Assignments

RGB Signal Terminal (INPUT 1 and OUTPUT (FOR INPUT 1, 2)): 15-pin mini D-sub female connector

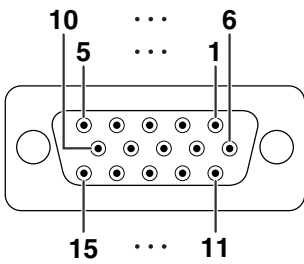

RGB Input

1. Video input (red)
2. Video input (green/sync on green)
3. Video input (blue)
4. Not connected
5. Not connected
6. Earth (red)
7. Earth (green/sync on green)
8. Earth (blue)
9. Not connected
10. GND
11. Not connected
12. Bi-directional data
13. Horizontal sync signal: TTL level
14. Vertical sync signal: TTL level
15. Data clock

Component Input

1. P_R (C_R)
2. Y
3. P_B (C_B)
4. Not connected
5. Not connected
6. Earth (P_R)
7. Earth (Y)
8. Earth (P_B)
9. Not connected
10. Not connected
11. Not connected
12. Not connected
13. Not connected
14. Not connected
15. Not connected

RS-232C Terminal: 9-pin D-sub male connector

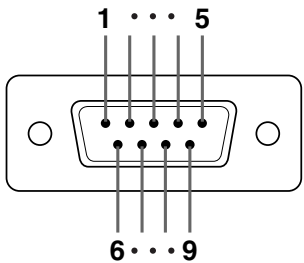

Pin No.	Signal	Name	I/O	Reference
1				Not connected
2	RD	Receive Data	Input	Connected to internal circuit
3	SD	Send Data	Output	Connected to internal circuit
4				Not connected
5	SG	Signal Ground		Connected to internal circuit
6				Not connected
7	RS	Request to Send		Connected to CS in internal circuit
8	CS	Clear to Send		Connected to RS in internal circuit
9				Not connected

RS-232C Cable Recommended Connection: 9-pin D-sub female connector

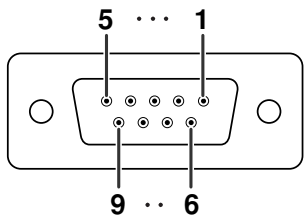

Pin No.	Signal	Pin No.	Signal
1	CD	1	CD
2	RD	2	RD
3	SD	3	SD
4	ER	4	ER
5	SG	5	SG
6	DR	6	DR
7	RS	7	RS
8	CS	8	CS
9	CI	9	CI

Note

- Depending on the controlling device used, it may be necessary to connect Pin 4 and Pin 6 on the controlling device (e.g. computer).



LAN Terminal: 8-pin RJ-45 modular connector

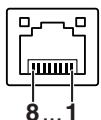

Pin No.	Signal	Pin No.	Signal
1	TX+	5	
2	TX-	6	RX-
3	RX+	7	
4		8	

Connecting Pin Assignments

DVI digital Terminal (INPUT 3)

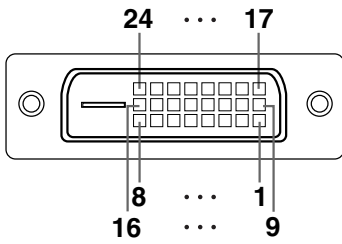

Pin No.	Signal	Pin No.	Signal
1	T.M.D.S. Data 2-	17	T.M.D.S. Data 0-
2	T.M.D.S. Data 2+	18	T.M.D.S. Data 0+
3	T.M.D.S. Data 2 Shield	19	T.M.D.S. Data 0 Shield
4	Not connected	20	Not connected
5	Not connected	21	Not connected
6	DDC Clock	22	T.M.D.S. Clock Shield
7	DDC Data	23	T.M.D.S. Clock+
8	Not connected	24	T.M.D.S. Clock-
9	T.M.D.S. Data 1-		
10	T.M.D.S. Data 1+		
11	T.M.D.S. Data 1 Shield		
12	Not connected		
13	Not connected		
14	+5 V Power		
15	Ground		
16	Hot Plug Detect		

RS-232C Specifications and Commands

Computer control

A computer can be used to control the projector by connecting an RS-232C serial control cable (cross type, commercially available) to the projector. (See page 27 on the owner's manual of the projector for connection.)

Communication conditions

Set the serial port settings of the computer to match that of the table.

Signal format: Conforms to RS-232C standard.

Parity bit: None

Baud rate*: 9,600 bps / 38,400 bps / 115,200 bps

Stop bit: 1 bit

Data length: 8 bits

Flow control: None

*Set the projector's baud rate to the same rate as used by the computer.

Basic format

Commands from the computer are sent in the following order: command, parameter, and return code. After the projector processes the command from the computer, it sends a response code to the computer.

Command format

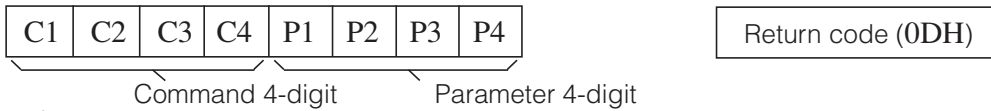

Response code format

Normal response

Problem response (communication error or incorrect command)



Info

- When you have more than one command to give to the projector, send each of them only after the response code for the previous one is received.
 - "POWR?????" "TABN ___ 1" "TLPS ___ 1" "TLPS ___ 2" "TPOW ___ 1" "TLPN ___ 1" "TLTT ___ 1" "TLTT ___ 2" "TLTL ___ 1" "TLTL ___ 2" "TNAM ___ 1" "MNRD ___ 1" "SNRD ___ 1" "PJN0 ___ 1"
- When the projector receives a command shown above :
- * The on-screen display will not disappear.
 - * The "Auto Power Off" timer will not be reset.

Note

- When controlling the projector using the RS-232C commands, you cannot confirm the projector setting values from the computer. To confirm each setting value, send the display command for each menu (e.g. RARE ___ 0), and then refer to the on-screen display. When using the setting/adjustment commands other than the menu display commands, the settings/adjustments are executed without the on-screen display.

Commands

Example: When turning on the projector, make the following setting.

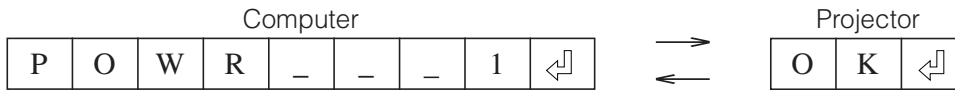

Control Contents	Command	Parameter	Return	
			Power on	Standby mode (or 40-second startup time)
Power Off	P O W R	0	OK or ERR	OK
Power On	P O W R	1	OK	OK or ERR
Power Status	P O W R ? ? ? ?	?	?	0
Projector Condition	T A B N	1	0:Normal, 1:Temp High, 8:Lamp Life 5% or less, 16:Lamp Burnt-out, 32:Lamp Ignition Failure	0:Normal, 1:Temp High, 2:Fan Error, 4:Intake Vent Cover Open, 8:Lamp Life 5% or less, 16:Lamp Burnt-out, 32:Lamp Ignition Failure, 64:Temp Abnormally High
Lamp 1 Status	T L P S	1	0:Off, 1:On, 2:Retry, 3:Waiting, 4:Lamp Error	0:Off, 4:Lamp Error
Lamp 2 Status	T L P S	2	0:Off, 1:On, 2:Retry, 3:Waiting, 4:Lamp Error	0:Off, 4:Lamp Error
Lamp Power Status	T P O W	1	1:On, 2:Cooling	0:Standby
Lamp Quantity	T L P N	1	2	
Volume (0 - 60)	V O L A	*	OK or ERR	ERR
Mute Off	M U T E	0	OK or ERR	ERR
Mute On	M U T E	1	OK or ERR	ERR
Lens Focus (-255 - +255)	L N F O	*	OK	ERR
Lens Zoom (-255 - +255)	L N Z O	*	OK	ERR
Vertical Lens Shift (Compatible with old command)	L N S H	*	OK or ERR	ERR
Vertical Lens Shift (-800 - +800)	L N U D	*	OK or ERR	ERR
Horizontal Lens Shift (-800 - +800)	L N L R	*	OK or ERR	ERR
Vertical Keystone (Compatible with old command)	K E Y S	*	OK or ERR	ERR
Vertical Keystone (-60 - +60)	K E Y V	*	OK or ERR	ERR
Horizontal Keystone (-60 - +60)	K E Y H	*	OK or ERR	ERR
Image Resizing(-30 - +30)	I M R S	*	OK or ERR	ERR
Black Screen Off	I M B K	0	OK or ERR	ERR
Black Screen On	I M B K	1	OK or ERR	ERR
INPUT 1 (RGB1)	I R G B	1	OK or ERR	ERR
INPUT 2 (RGB2)	I R G B	2	OK or ERR	ERR
INPUT 3 (RGB3)	I R G B	3	OK or ERR	ERR
INPUT RGB Check	I R G B ? ? ? ?	?	1:RGB1(INPUT1), 2:RGB2(INPUT2), 3:RGB3(INPUT3), ERR	ERR
INPUT 4 (Video1)	I V E D	1	OK or ERR	ERR
INPUT 5 (Video2)	I V E D	2	OK or ERR	ERR
INPUT Video Check	I V E D ? ? ? ?	?	1:Video1(INPUT4), 2:Video2(INPUT5), ERR	ERR
INPUT Mode Check	I M O D ? ? ? ?	?	1:RGB, 2:Video	ERR
INPUT Check	I C H K ? ? ? ?	?	1:INPUT1, 2:INPUT2, 3:INPUT3, 4:INPUT4, 5:INPUT5	ERR
Freeze Off	F R E Z	0	OK or ERR	ERR
Freeze On	F R E Z	1	OK or ERR	ERR
Auto Sync Start	A D J S	1	OK or ERR	ERR
INPUT 1 Resize : Normal	R A S R	1	OK or ERR	ERR
INPUT 1 Resize : Stretch (Video only)	R A S R	2	OK or ERR	ERR
INPUT 1 Resize : Dot By Dot (Computer) / Border (Video)	R A S R	3	OK or ERR	ERR
INPUT 1 Resize : Smart Stretch (Video only)	R A S R	4	OK or ERR	ERR
INPUT 1 Resize : Full	R A S R	5	OK or ERR	ERR
INPUT 2 Resize : Normal	R B S R	1	OK or ERR	ERR
INPUT 2 Resize : Stretch (Video only)	R B S R	2	OK or ERR	ERR
INPUT 2 Resize : Dot By Dot (Computer) / Border (Video)	R B S R	3	OK or ERR	ERR
INPUT 2 Resize : Smart Stretch (Video only)	R B S R	4	OK or ERR	ERR
INPUT 2 Resize : Full	R B S R	5	OK or ERR	ERR
INPUT 3 Resize : Normal	R C S R	1	OK or ERR	ERR
INPUT 3 Resize : Stretch (Video only)	R C S R	2	OK or ERR	ERR
INPUT 3 Resize : Dot By Dot (Computer) / Border (Video)	R C S R	3	OK or ERR	ERR
INPUT 3 Resize : Smart Stretch (Video only)	R C S R	4	OK or ERR	ERR
INPUT 3 Resize : Full	R C S R	5	OK or ERR	ERR
INPUT 4 Resize : Normal	R A S V	1	OK or ERR	ERR
INPUT 4 Resize : Stretch	R A S V	2	OK or ERR	ERR
INPUT 4 Resize : Border	R A S V	3	OK or ERR	ERR
INPUT 4 Resize : Smart Stretch	R A S V	4	OK or ERR	ERR
INPUT 5 Resize : Normal	R B S V	1	OK or ERR	ERR
INPUT 5 Resize : Stretch	R B S V	2	OK or ERR	ERR
INPUT 5 Resize : Border	R B S V	3	OK or ERR	ERR
INPUT 5 Resize : Smart Stretch	R B S V	4	OK or ERR	ERR
INPUT 1 Picture Mode : Standard	R A P S	1	OK or ERR	ERR
INPUT 1 Picture Mode : Presentation	R A P S	1	OK or ERR	ERR
INPUT 1 Picture Mode : Cinema	R A P S	1	OK or ERR	ERR
INPUT 1 Picture Mode : Custom	R A P S	1	OK or ERR	ERR
INPUT 1 Contrast (-30 - +30)	R A P I	*	OK or ERR	ERR
INPUT 1 Bright (-30 - +30)	R A B R	*	OK or ERR	ERR
INPUT 1 Color (-30 - +30)	R A C O	*	OK or ERR	ERR
INPUT 1 Tint (-30 - +30)	R A T I	*	OK or ERR	ERR
INPUT 1 Red (-30 - +30)	R A R D	*	OK or ERR	ERR
INPUT 1 Green (-30 - +30)	R A G N	*	OK or ERR	ERR
INPUT 1 Blue (-30 - +30)	R A B E	*	OK or ERR	ERR
INPUT 1 Sharp (-30 - +30)	R A S H	*	OK or ERR	ERR
INPUT 1 CLR Temp *1	R A C T	*	OK or ERR	ERR
INPUT 1 Bright Boost (0 - 10)	R A W E	*	OK or ERR	ERR
INPUT 1 Progressive : 2D	R A I P	0	OK or ERR	ERR
INPUT 1 Progressive : 3D	R A I P	1	OK or ERR	ERR
INPUT 1 Progressive : Film Mode	R A I P	2	OK or ERR	ERR

RS-232C Specifications and Commands

Control Contents	Command	Parameter	Return	
			Power on	Standby mode (or 40-second startup time)
INPUT 1 DNR : Off	R A N R	0	OK or ERR	ERR
INPUT 1 DNR : Level 1	R A N R	1	OK or ERR	ERR
INPUT 1 DNR : Level 2	R A N R	2	OK or ERR	ERR
INPUT 1 DNR : Level 3	R A N R	3	OK or ERR	ERR
INPUT 1 Adjustment Reset	R A R E	1	OK or ERR	ERR
INPUT 1 Signal Type : Auto	I A S I	0	OK or ERR	ERR
INPUT 1 Signal Type : RGB	I A S I	1	OK or ERR	ERR
INPUT 1 Signal Type : Component	I A S I	2	OK or ERR	ERR
INPUT 1 Display (Status display)	R A R E	0	OK or ERR	ERR
INPUT 2 Picture Mode : Standard	R B P S	1 0	OK or ERR	ERR
INPUT 2 Picture Mode : Presentation	R B P S	1 1	OK or ERR	ERR
INPUT 2 Picture Mode : Cinema	R B P S	1 2	OK or ERR	ERR
INPUT 2 Picture Mode : Custom	R B P S	1 3	OK or ERR	ERR
INPUT 2 Contrast (-30 - +30)	R B P I	* * * *	OK or ERR	ERR
INPUT 2 Bright (-30 - +30)	R B B R	* * * *	OK or ERR	ERR
INPUT 2 Color (-30 - +30)	R B C O	* * * *	OK or ERR	ERR
INPUT 2 Tint (-30 - +30)	R B T I	* * * *	OK or ERR	ERR
INPUT 2 Red (-30 - +30)	R B R D	* * * *	OK or ERR	ERR
INPUT 2 Green (-30 - +30)	R B G N	* * * *	OK or ERR	ERR
INPUT 2 Blue (-30 - +30)	R B B E	* * * *	OK or ERR	ERR
INPUT 2 Sharp (-30 - +30)	R B S H	* * * *	OK or ERR	ERR
INPUT 2 CLR Temp *1	R B C T	* * * *	OK or ERR	ERR
INPUT 2 Bright Boost (0 - 10)	R B W E	* * * *	OK or ERR	ERR
INPUT 2 Progressive : 2D	R B I P	0	OK or ERR	ERR
INPUT 2 Progressive : 3D	R B I P	1	OK or ERR	ERR
INPUT 2 Progressive : Film Mode	R B I P	2	OK or ERR	ERR
INPUT 2 DNR : Off	R B N R	0	OK or ERR	ERR
INPUT 2 DNR : Level 1	R B N R	1	OK or ERR	ERR
INPUT 2 DNR : Level 2	R B N R	2	OK or ERR	ERR
INPUT 2 DNR : Level 3	R B N R	3	OK or ERR	ERR
INPUT 2 Adjustment Reset	R B R E	1	OK or ERR	ERR
INPUT 2 Signal Type : Auto	I B S I	0	OK or ERR	ERR
INPUT 2 Signal Type : RGB	I B S I	1	OK or ERR	ERR
INPUT 2 Signal Type : Component	I B S I	2	OK or ERR	ERR
INPUT 2 Display (Status display)	R B R E	0	OK or ERR	ERR
INPUT 3 Picture Mode : Standard	R C P S	1 0	OK or ERR	ERR
INPUT 3 Picture Mode : Presentation	R C P S	1 1	OK or ERR	ERR
INPUT 3 Picture Mode : Cinema	R C P S	1 2	OK or ERR	ERR
INPUT 3 Picture Mode : Custom	R C P S	1 3	OK or ERR	ERR
INPUT 3 Contrast (-30 - +30)	R C P I	* * * *	OK or ERR	ERR
INPUT 3 Bright (-30 - +30)	R C B R	* * * *	OK or ERR	ERR
INPUT 3 Color (-30 - +30)	R C C O	* * * *	OK or ERR	ERR
INPUT 3 Tint (-30 - +30)	R C T I	* * * *	OK or ERR	ERR
INPUT 3 Red (-30 - +30)	R C R D	* * * *	OK or ERR	ERR
INPUT 3 Green (-30 - +30)	R C G N	* * * *	OK or ERR	ERR
INPUT 3 Blue (-30 - +30)	R C B E	* * * *	OK or ERR	ERR
INPUT 3 Sharp (-30 - +30)	R C S H	* * * *	OK or ERR	ERR
INPUT 3 CLR Temp *1	R C C T	* * * *	OK or ERR	ERR
INPUT 3 Bright Boost (0 - 10)	R C W E	* * * *	OK or ERR	ERR
INPUT 3 DNR : Off	R C N R	0	OK or ERR	ERR
INPUT 3 DNR : Level 1	R C N R	1	OK or ERR	ERR
INPUT 3 DNR : Level 2	R C N R	2	OK or ERR	ERR
INPUT 3 DNR : Level 3	R C N R	3	OK or ERR	ERR
INPUT 3 Adjustment Reset	R C R E	1	OK or ERR	ERR
INPUT 3 Signal Type : D. PC RGB	I C S I	3	OK or ERR	ERR
INPUT 3 Signal Type : D. PC Component	I C S I	4	OK or ERR	ERR
INPUT 3 Signal Type : D. Video RGB	I C S I	5	OK or ERR	ERR
INPUT 3 Signal Type : D. Video Component	I C S I	6	OK or ERR	ERR
INPUT 3 Display (Status display)	R C R E	0	OK or ERR	ERR
INPUT 4 Picture Mode : Standard	V A P S	1 0	OK or ERR	ERR
INPUT 4 Picture Mode : Presentation	V A P S	1 1	OK or ERR	ERR
INPUT 4 Picture Mode : Cinema	V A P S	1 2	OK or ERR	ERR
INPUT 4 Picture Mode : Custom	V A P S	1 3	OK or ERR	ERR
INPUT 4 Contrast (-30 - +30)	V A P I	* * * *	OK or ERR	ERR
INPUT 4 Bright (-30 - +30)	V A B R	* * * *	OK or ERR	ERR
INPUT 4 Color (-30 - +30)	V A C O	* * * *	OK or ERR	ERR
INPUT 4 Tint (-30 - +30)	V A T I	* * * *	OK or ERR	ERR
INPUT 4 Red (-30 - +30)	V A R D	* * * *	OK or ERR	ERR
INPUT 4 Green (-30 - +30)	V A G N	* * * *	OK or ERR	ERR
INPUT 4 Blue (-30 - +30)	V A B E	* * * *	OK or ERR	ERR
INPUT 4 Sharp (-30 - +30)	V A S H	* * * *	OK or ERR	ERR
INPUT 4 CLR Temp *1	V A C T	* * * *	OK or ERR	ERR
INPUT 4 Bright Boost (0 - 10)	V A W E	* * * *	OK or ERR	ERR
INPUT 4 Progressive : 2D	V A I P	0	OK or ERR	ERR
INPUT 4 Progressive : 3D	V A I P	1	OK or ERR	ERR
INPUT 4 Progressive : Film Mode	V A I P	2	OK or ERR	ERR
INPUT 4 DNR : Off	V A N R	0	OK or ERR	ERR
INPUT 4 DNR : Level 1	V A N R	1	OK or ERR	ERR
INPUT 4 DNR : Level 2	V A N R	2	OK or ERR	ERR
INPUT 4 DNR : Level 3	V A N R	3	OK or ERR	ERR
INPUT 4 Adjustment Reset	V A R E	1	OK or ERR	ERR
INPUT 4 Display (Status display)	V A R E	0	OK or ERR	ERR
INPUT 5 Picture Mode : Standard	V B P S	1 0	OK or ERR	ERR
INPUT 5 Picture Mode : Presentation	V B P S	1 1	OK or ERR	ERR
INPUT 5 Picture Mode : Cinema	V B P S	1 2	OK or ERR	ERR
INPUT 5 Picture Mode : Custom	V B P S	1 3	OK or ERR	ERR
INPUT 5 Contrast (-30 - +30)	V B P I	* * * *	OK or ERR	ERR
INPUT 5 Bright (-30 - +30)	V B B R	* * * *	OK or ERR	ERR

RS-232C Specifications and Commands

Control Contents	Command	Parameter	Return	
			Power on	Standby mode (or 40-second startup time)
INPUT 5 Color (-30 - +30)	V B C O	- * * *	OK or ERR	ERR
INPUT 5 Tint (-30 - +30)	V B T I	- * * *	OK or ERR	ERR
INPUT 5 Red (-30 - +30)	V B R D	- * * *	OK or ERR	ERR
INPUT 5 Green (-30 - +30)	V B G N	- * * *	OK or ERR	ERR
INPUT 5 Blue (-30 - +30)	V B B E	- * * *	OK or ERR	ERR
INPUT 5 Sharp (-30 - +30)	V B S H	- * * *	OK or ERR	ERR
INPUT 5 CLR Temp *1	V B C T	- * * *	OK or ERR	ERR
INPUT 5 Bright Boost (0 - 10)	V B W E	- * * *	OK or ERR	ERR
INPUT 5 Progressive : 2D	V B I P	- - - 0	OK or ERR	ERR
INPUT 5 Progressive : 3D	V B I P	- - - 1	OK or ERR	ERR
INPUT 5 Progressive : Film Mode	V B I P	- - - 2	OK or ERR	ERR
INPUT 5 DNR : Off	V B N R	- - - 0	OK or ERR	ERR
INPUT 5 DNR : Level 1	V B N R	- - - 1	OK or ERR	ERR
INPUT 5 DNR : Level 2	V B N R	- - - 2	OK or ERR	ERR
INPUT 5 DNR : Level 3	V B N R	- - - 3	OK or ERR	ERR
INPUT 5 Adjustment Reset	V B R E	- - - 1	OK or ERR	ERR
INPUT 5 Display (Status display)	V B R E	- - - 0	OK or ERR	ERR
INPUT 1 C.M.S. Adjustment : Standard	C S R A	- - - 00	OK or ERR	ERR
INPUT 1 C.M.S. Adjustment : sRGB	C S R A	- - - 01	OK or ERR	ERR
INPUT 1 C.M.S. Adjustment : Custom1	C S R A	- - - 11	OK or ERR	ERR
INPUT 1 C.M.S. Adjustment : Custom2	C S R A	- - - 12	OK or ERR	ERR
INPUT 1 C.M.S. Adjustment : Custom3	C S R A	- - - 13	OK or ERR	ERR
INPUT 2 C.M.S. Adjustment : Standard	C S R B	- - - 00	OK or ERR	ERR
INPUT 2 C.M.S. Adjustment : sRGB	C S R B	- - - 01	OK or ERR	ERR
INPUT 2 C.M.S. Adjustment : Custom1	C S R B	- - - 11	OK or ERR	ERR
INPUT 2 C.M.S. Adjustment : Custom2	C S R B	- - - 12	OK or ERR	ERR
INPUT 2 C.M.S. Adjustment : Custom3	C S R B	- - - 13	OK or ERR	ERR
INPUT 3 C.M.S. Adjustment : Standard	C S R C	- - - 00	OK or ERR	ERR
INPUT 3 C.M.S. Adjustment : sRGB	C S R C	- - - 01	OK or ERR	ERR
INPUT 3 C.M.S. Adjustment : Custom1	C S R C	- - - 11	OK or ERR	ERR
INPUT 3 C.M.S. Adjustment : Custom2	C S R C	- - - 12	OK or ERR	ERR
INPUT 3 C.M.S. Adjustment : Custom3	C S R C	- - - 13	OK or ERR	ERR
INPUT 4 C.M.S. Adjustment : Standard	C S V A	- - - 00	OK or ERR	ERR
INPUT 4 C.M.S. Adjustment : Custom1	C S V A	- - - 11	OK or ERR	ERR
INPUT 4 C.M.S. Adjustment : Custom2	C S V A	- - - 12	OK or ERR	ERR
INPUT 4 C.M.S. Adjustment : Custom3	C S V A	- - - 13	OK or ERR	ERR
INPUT 5 C.M.S. Adjustment : Standard	C S V B	- - - 00	OK or ERR	ERR
INPUT 5 C.M.S. Adjustment : Custom1	C S V B	- - - 11	OK or ERR	ERR
INPUT 5 C.M.S. Adjustment : Custom2	C S V B	- - - 12	OK or ERR	ERR
INPUT 5 C.M.S. Adjustment : Custom3	C S V B	- - - 13	OK or ERR	ERR
Target : Red	C M T G	- - - 1	OK or ERR	ERR
Target : Yellow	C M T G	- - - 2	OK or ERR	ERR
Target : Green	C M T G	- - - 3	OK or ERR	ERR
Target : Cyan	C M T G	- - - 4	OK or ERR	ERR
Target : Blue	C M T G	- - - 5	OK or ERR	ERR
Target : Magenta	C M T G	- - - 6	OK or ERR	ERR
Lightness (-30 - +30)	C M S L	- - - * *	OK or ERR	ERR
Chroma (-30 - +30)	C M S C	- - - * *	OK or ERR	ERR
Hue (-30 - +30)	C M S H	- - - * *	OK or ERR	ERR
Reset (This Color)	C M R E	- - - 1	OK or ERR	ERR
Reset (All Colors)	C M R E	- - - 2	OK or ERR	ERR
Clock (-150 - +150)	I N C L	- * * * *	OK or ERR	ERR
Phase (-60 - +60)	I N P H	- * * * *	OK or ERR	ERR
H-Position (-150 - +150)	I A H P	- * * * *	OK or ERR	ERR
V-Position (-60 - +60)	I A V P	- * * * *	OK or ERR	ERR
Fine Sync Display (Status display)	I A R E	- - - 0	OK or ERR	ERR
Fine Sync Adjustment Reset	I A R E	- - - 1	OK or ERR	ERR
Save Setting (1 - 7)	M E M S	- - - *	OK or ERR	ERR
Select Setting (1 - 7)	M E M L	- - - *	OK or ERR	ERR
RGB Horizontal Frequency Check	T F R Q	- - - 1	kHz (***. * or _)	ERR
RGB Vertical Frequency Check	T F R Q	- - - 2	Hz (***. * or _)	ERR
Auto Sync : Off	A A D J	- - - 0	OK or ERR	ERR
Auto Sync : Normal	A A D J	- - - 1	OK or ERR	ERR
Auto Sync : High Speed	A A D J	- - - 2	OK or ERR	ERR
Auto Sync Display : Off	I M A S	- - - 0	OK or ERR	ERR
Auto Sync Display : On	I M A S	- - - 1	OK or ERR	ERR
Balance (-30 - +30)	A A B L	- * * * *	OK or ERR	ERR
Treble (-30 - +30)	A A T E	- * * * *	OK or ERR	ERR
Bass (-30 - +30)	A A B A	- * * * *	OK or ERR	ERR
Audio Display (Status display)	A A R E	- - - 0	OK or ERR	ERR
Audio Adjustment Reset	A A R E	- - - 1	OK or ERR	ERR
Audio Out : FAO	A O U T	- - - 1	OK or ERR	ERR
Audio Out : VAO	A O U T	- - - 2	OK or ERR	ERR
Speaker : Off	A S P K	- - - 0	OK or ERR	ERR
Speaker : On	A S P K	- - - 1	OK or ERR	ERR
Pict in Pict : Bottom Right	P I N P	- - - 11	OK or ERR	ERR
Pict in Pict : Bottom Left	P I N P	- - - 12	OK or ERR	ERR
Pict in Pict : Upper Right	P I N P	- - - 13	OK or ERR	ERR
Pict in Pict : Upper Left	P I N P	- - - 14	OK or ERR	ERR
Pict in Pict : Off	P I N P	- - - 0	OK or ERR	ERR
Digital Shift (-96 - +96)	L N D S	- * * * *	OK or ERR	ERR
OSD Display : Normal	I M D I	- - - 1	OK or ERR	ERR
OSD Display : Level A	I M D I	- - - 2	OK or ERR	ERR
OSD Display : Level B	I M D I	- - - 0	OK or ERR	ERR
Black Screen Display : Off	I M B O	- - - 0	OK or ERR	ERR
Black Screen Display : On	I M B O	- - - 1	OK or ERR	ERR
Video System Selection : AUTO	M E S Y	- - - 1	OK or ERR	ERR
Video System Selection : PAL	M E S Y	- - - 2	OK or ERR	ERR
Video System Selection : SECAM	M E S Y	- - - 3	OK or ERR	ERR
Video System Selection : NTSC4.43	M E S Y	- - - 4	OK or ERR	ERR
Video System Selection : NTSC3.58	M E S Y	- - - 5	OK or ERR	ERR

RS-232C Specifications and Commands

Control Contents	Command	Parameter	Return	
			Power on	Standby mode (or 40-second startup time)
Video System Selection : PAL-M	M E S Y	6	OK or ERR	ERR
Video System Selection : PAL-N	M E S Y	7	OK or ERR	ERR
Background Selection : Logo	I M B G	1	OK or ERR	ERR
Background Selection : Custom	I M B G	2	OK or ERR	ERR
Background Selection : Blue	I M B G	3	OK or ERR	ERR
Background Selection : None	I M B G	4	OK or ERR	ERR
Startup Image Selection : Logo	I M S I	1	OK or ERR	ERR
Startup Image Selection : Custom	I M S I	2	OK or ERR	ERR
Startup Image Selection : None	I M S I	3	OK or ERR	ERR
Eco Mode : Standard	T H M D	0	OK or ERR	ERR
Eco Mode : Eco	T H M D	1	OK or ERR	ERR
Auto Search : Off	I N S E	0	OK or ERR	ERR
Auto Search : On	I N S E	1	OK or ERR	ERR
Auto Power Off : Disable	A P O W	0	OK or ERR	ERR
Auto Power Off : Enable	A P O W	1	OK or ERR	ERR
Lamp 1 Usage Time (Hour)	T L T T	1	0 - 9999 (Integer)	
Lamp 2 Usage Time (Hour)	T L T T	2	0 - 9999 (Integer)	
Lamp 1 Life (Percentage)	T L T L	1	0% - 100% (Integer)	
Lamp 2 Life (Percentage)	T L T L	2	0% - 100% (Integer)	
Lamp Mode : Both Lamps	L P M D	0	OK or ERR	ERR
Lamp Mode : Lamp 1 Only	L P M D	1	OK or ERR	ERR
Lamp Mode : Lamp 2 Only	L P M D	2	OK or ERR	ERR
Lamp Mode : Equal Use	L P M D	3	OK or ERR	ERR
PRJ Mode : Reverse Off	I M R E	0	OK or ERR	ERR
PRJ Mode : Reverse On	I M R E	1	OK or ERR	ERR
PRJ Mode : Invert Off	I M I N	0	OK or ERR	ERR
PRJ Mode : Invert On	I M I N	1	OK or ERR	ERR
Stack Setting : Normal	S T A K	0	OK or ERR	ERR
Stack Setting : Master	S T A K	1	OK or ERR	ERR
Stack Setting : Slave	S T A K	2	OK or ERR	ERR
Keylock Level : Normal	K E Y L	0	OK or ERR	ERR
Keylock Level : Level A	K E Y L	1	OK or ERR	ERR
Keylock Level : Level B	K E Y L	2	OK or ERR	ERR
Set Inputs : INPUT 1 No Use	R A S I	0	OK or ERR	ERR
Set Inputs : INPUT 1 Use	R A S I	1	OK or ERR	ERR
Set Inputs : INPUT 2 No Use	R B S I	0	OK or ERR	ERR
Set Inputs : INPUT 2 Use	R B S I	1	OK or ERR	ERR
Set Inputs : INPUT 3 No Use	R C S I	0	OK or ERR	ERR
Set Inputs : INPUT 3 Use	R C S I	1	OK or ERR	ERR
Set Inputs : INPUT 4 No Use	V A S I	0	OK or ERR	ERR
Set Inputs : INPUT 4 Use	V A S I	1	OK or ERR	ERR
Set Inputs : INPUT 5 No Use	V B S I	0	OK or ERR	ERR
Set Inputs : INPUT 5 Use	V B S I	1	OK or ERR	ERR
Monitor Out : Disable	M O U T	0	OK or ERR	
Monitor Out : Enable	M O U T	1	OK or ERR	
LAN/RS232C : Disable	L N R S	0	OK or ERR	*2
LAN/RS232C : Enable	L N R S	1	OK or ERR	
Language Selection : ENGLISH	M E L A	1	OK or ERR	ERR
Language Selection : DEUTSCH	M E L A	2	OK or ERR	ERR
Language Selection : ESPAÑOL	M E L A	3	OK or ERR	ERR
Language Selection : NEDERLANDS	M E L A	4	OK or ERR	ERR
Language Selection : FRANÇAIS	M E L A	5	OK or ERR	ERR
Language Selection : ITALIANO	M E L A	6	OK or ERR	ERR
Language Selection : SVENSKA	M E L A	7	OK or ERR	ERR
Language Selection : 日本語	M E L A	8	OK or ERR	ERR
Language Selection : PORTUGUES	M E L A	9	OK or ERR	ERR
Language Selection : 汉语	M E L A	10	OK or ERR	ERR
Language Selection : 한국어	M E L A	11	OK or ERR	ERR
Model Name Check	T N A M	1	EIP-4500	
Model Name Check 2	M N R D	1	EIP-4500	
Serial No. Check *3	S N R D	1	Serial No.	
Projector Name Setting 1 (First four characters) *4	P J N 1	* * * *	OK or ERR	
Projector Name Setting 2 (Middle four characters) *4	P J N 2	* * * *	OK or ERR	
Projector Name Setting 3 (Last four characters) *4	P J N 3	* * * *	OK or ERR	
Projector Name Check	P J N 0	- - - -	Projector Name	

Note

- If an underbar (_) appears in the parameter column, enter a space.
 - If an asterisk (*) appears in the parameter column, enter a value in the range indicated in brackets under Control Contents.
- *1 Parameters of CLR Temp settings are as follows.

CLR Temp	Parameter	CLR Temp	Parameter
4500K	_ 0 4 5	8500K	_ 0 8 5
5500K	_ 0 5 5	9300K	_ 0 9 3
6500K	_ 0 6 5	10500K	_ 1 0 5
7500K	_ 0 7 5		

*2 Because the RS-232C function stops, the projector send no response code.

*3 Serial No. Check command is used to read out the 12 digits of serial No..

*4 For setting the projector name, send the commands in order of PJN1, PJN2 and PJN3.

Setting up the Projector Network Environment

This section describes the basic procedure for using the projector via the network.

If the network is already constructed, the projector's network settings may need to be changed. Please consult your network administrator for assistance with these settings.

1. Connecting the projector to a computer

Connect a commercially available LAN cable (UTP cable, Category 5, cross-over type) between the computer and projector.

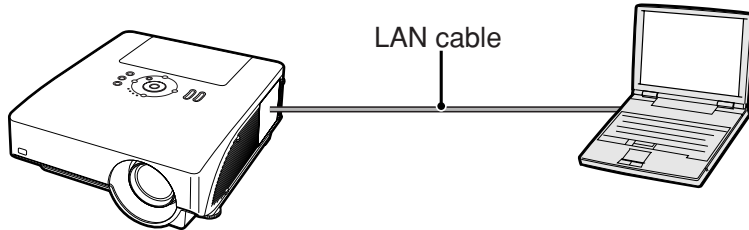

➔ Page 18

2. Setting an IP address for the computer

Adjust the IP settings of the computer to enable one-to-one communications with the projector.

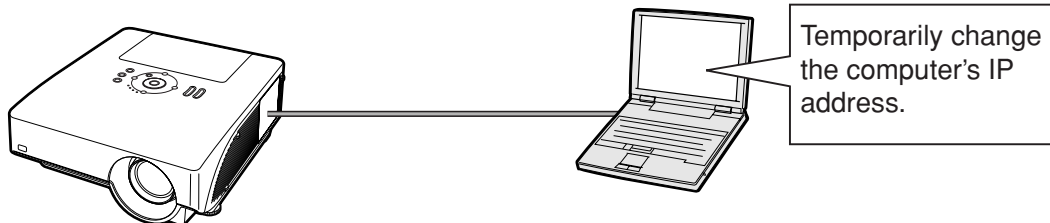

➔ Pages 19, 20

3. Setting up a network connection for the projector

Adjust the projector network settings to conform to your network.

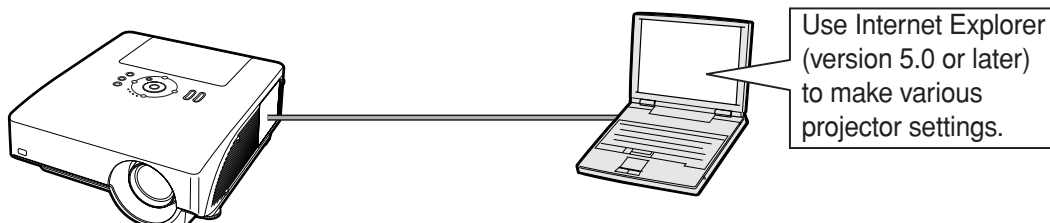

➔ Page 21

- Microsoft® and Windows® are registered trademarks of Microsoft Corporation in the United States and/or other countries.
- All other company or product names are trademarks or registered trademarks of their respective companies.

Setting up the Projector Network Environment

1. Connecting the Projector to a Computer

Establishing a one-to-one connection from the projector to a computer. Using a commercially available LAN cable (UTP cable, Category 5, cross-over type) you can configure the projector via the computer.

1 Disconnect the computer's LAN cable from the existing network.

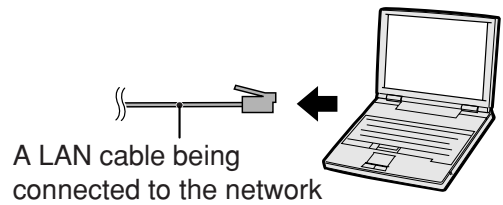

2 Connect a commercially available LAN cable (UTP cable, Category 5, cross-over type) to the projector's LAN terminal and connect the other end of the cable to the computer's LAN terminal.

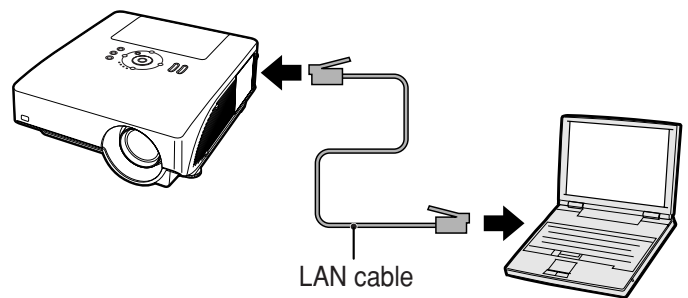

3 Turn on the projector.

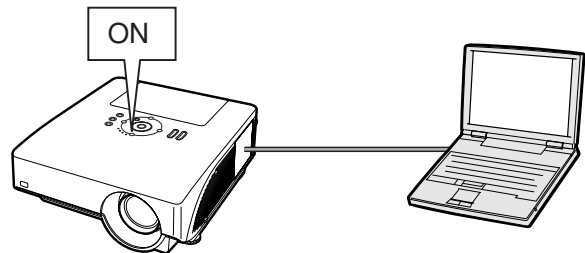

4 Turn on the computer.

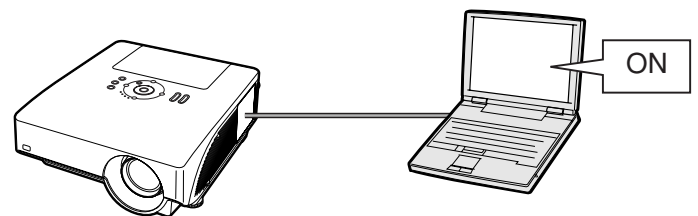

Info

Confirm that the LINK LED on the side of the projector illuminates. If the LINK LED does not illuminate, check the following :

- The LAN cable is properly connected.
- The power switches of both the projector and the computer are on.

This completes the connection. Now proceed to “**2. Setting an IP Address for the Computer**”.

2. Setting an IP Address for the Computer

The following describes how to make settings in Windows® XP (Professional or Home Edition).

1 Log on the network using the administrator's account for the computer.

2 Click "start", and click "Control Panel".

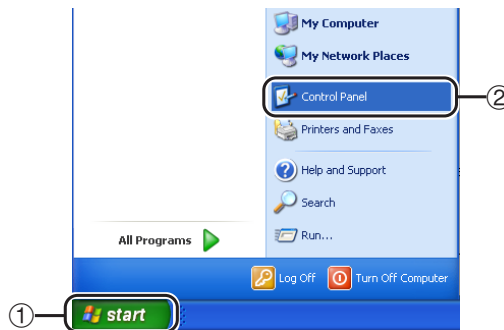

3 Click "Network and Internet Connections", and click "Network Connections" in the new window.

- This manual uses examples to explain the operations in Category View. If you are using Classic View, double-click "Network Connections".

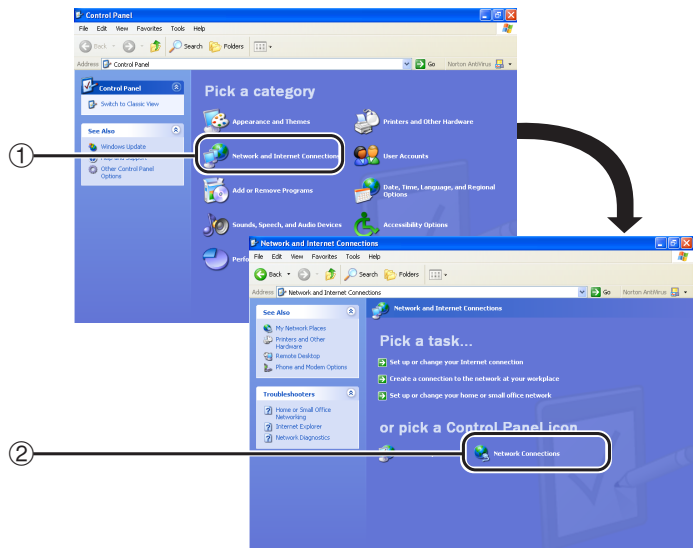

4 Right-click "Local Area Connection" and select "Properties" from the menu.

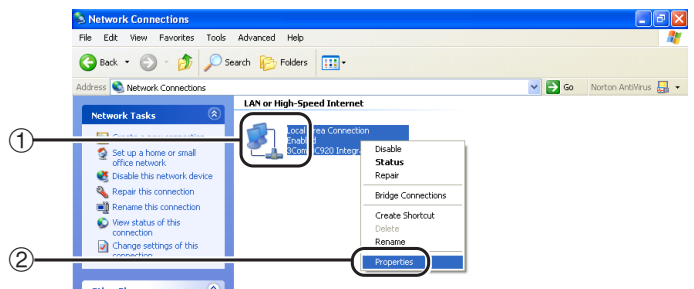

Setting up the Projector Network Environment

- 5** Click “Internet Protocol (TCP/IP)”, and click the “Properties” button.

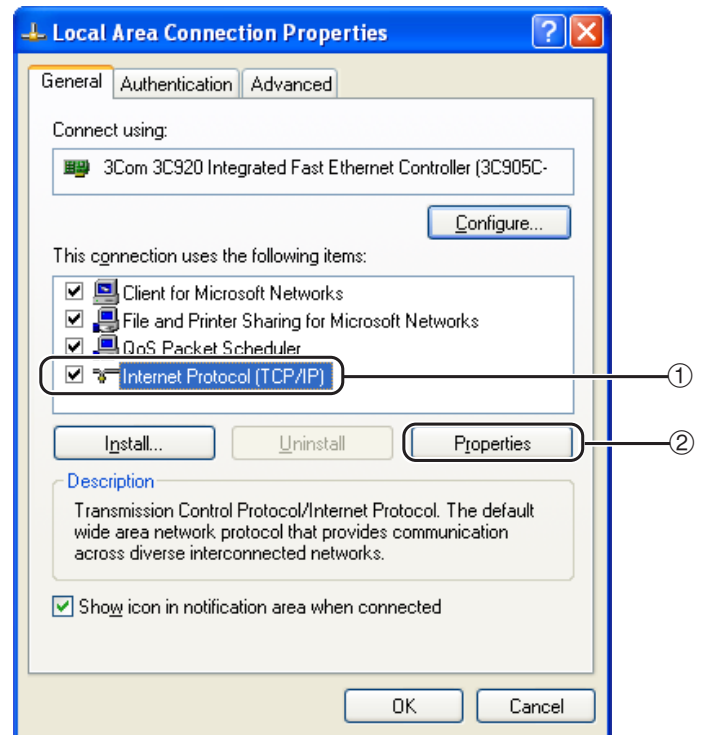

- 6** Confirm or change an IP address for the setup computer.

- ① **Confirm and note the current IP address, Subnet mask and Default gateway.**

Make sure to note the current IP address, Subnet mask and Default gateway as you will be required to re-set them later.

- ② **The factory default setting for the projector IP address is “192.168.150.2”, Subnet mask is “255.255.255.0” and Default gateway is “0.0.0.0”.**

Set temporarily as follows :

IP address : 192.168.150.3

Subnet mask : 255.255.255.0

Default gateway : (Do not input any values.)

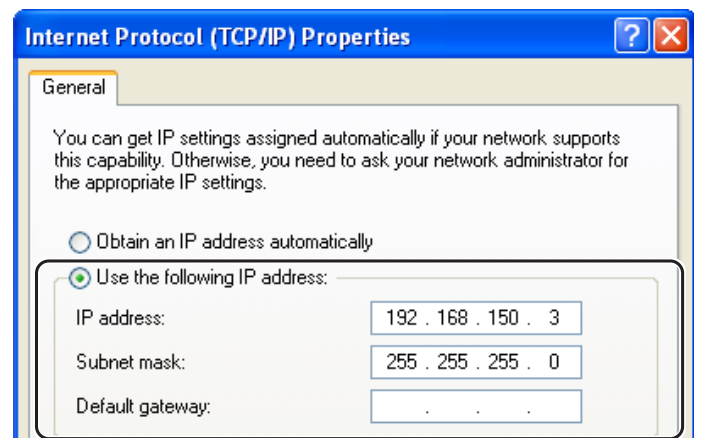

- 7** After setting, click the “OK” button, and then restart the computer.

After confirming or setting, proceed to “**3. Setting up Network Connection for the Projector**”.

3. Setting up a Network Connection for the Projector

Settings for such items as the projector's IP address and subnet mask are compatible with the existing network.

1 Start Internet Explorer (version 5.0 or later) on the computer, and enter "http://192.168.150.2/" in "Address", and then press the "Enter" key.

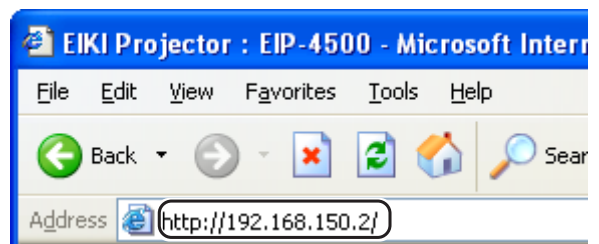

2 If a user name and a password have not yet been set, just click the "OK" button.

- If a user name and a password have been set, input the user name and the password, and click the "OK" button.
- If the user name or password is entered incorrectly three times, an error message will be displayed.



3 When the screen as shown on the right appears, click "TCP/IP".

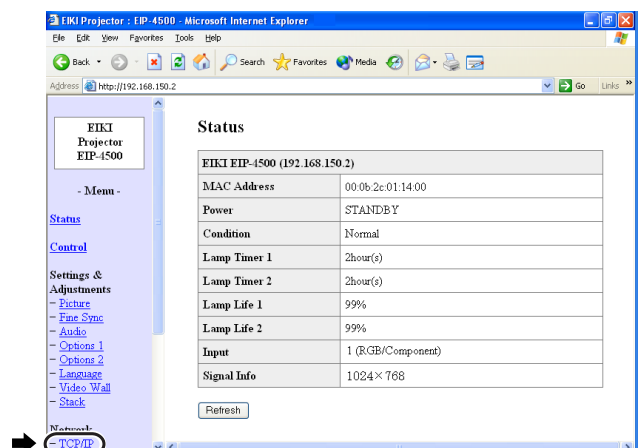

Setting up the Projector Network Environment

4 The TCP/IP setting screen appears, ready for network settings for the projector.

Items	Setting example / Remarks
IP Address	Factory default setting: 192.168.150.2 Enter an IP address appropriate for the network.
Subnet Mask	Factory default setting: 255.255.255.0 Set the subnet mask to the same as that of the computer and equipment on the network.
Default Gateway	Factory default setting: 0.0.0.0 * When not in use, set to "0.0.0.0".
DNS Server	Factory default setting: 0.0.0.0 * When not in use, set to "0.0.0.0".

Network - TCP/IP

IP Address	192 168 150 2
Subnet Mask	255 255 255 0
Default Gateway	0 0 0 0 * "0.0.0.0" means "Using no default gateway."
DNS Server	0 0 0 0 * "0.0.0.0" means "Using no DNS server."

Note

- Confirm the existing network's segment (IP address group) to avoid setting an IP address that duplicates the IP addresses of other network equipment or computers. If "192.168.150.2" is not used in the network having an IP address of "192.168.150.XXX", you don't have to change the projector IP address.
- For details about each setting, consult your network administrator.

5 Click the "Apply" button.

Network - TCP/IP

IP Address	192 168 150 2
Subnet Mask	255 255 255 0
Default Gateway	0 0 0 0 * "0.0.0.0" means "Using no default gateway."
DNS Server	0 0 0 0 * "0.0.0.0" means "Using no DNS server."



Apply

Refresh

Network - TCP/IP

The TCP/IP settings will be changed as below.

IP Address : 192.168.150.2
Subnet Mask : 255.255.255.0
Default Gateway : 0.0.0.0
DNS Server : 0.0.0.0

Do you want to change the TCP/IP settings?



Confirm Cancel

After you click "Confirm", if you want to continue to operate this projector via the network, please wait for 10 seconds and then re-access to "192.168.150.2".

6 The set values appear. Confirm that the values are set properly, and then click the "Confirm" button.

- After setting items, wait for 10 seconds and then re-access.

This completes the network settings.

Change the IP address of the setting computer back to its original address, and then connect the computer and the projector to the network.

Controlling the Projector via LAN

After connecting the projector to your network, enter the projector IP address in “Address” on Internet Explorer (version 5.0 or later) using a computer on the network to start a setup screen that will enable control of the projector via the network.

Controlling the Projector Using Internet Explorer (Version 5.0 or later)

Complete connections to external equipment before starting the operation. (See pages 24-36 on the owner’s manual of the projector.) Complete the AC cord connection. (See page 37 on the owner’s manual of the projector)

Note

- When connecting the projector to the LAN, use a commercially available LAN cable (UTP cable, Category 5, cross-over type). When connecting the projector to a hub, use a straight-through cable.

1 Start Internet Explorer (version 5.0 or later) on the computer.

2 Enter “http://” followed by the projector IP address set by the procedure on page 22 followed by “/” in “Address”, and then press the “Enter” key.

- The factory default setting for the projector IP address is 192.168.150.2. If you did not change the IP address in “3. Setting up a Network Connection for the Projector” (pages 21-22), enter “http://192.168.150.2/”.

3 A screen for controlling the projector appears, ready for performing various status conditions, control, and settings.

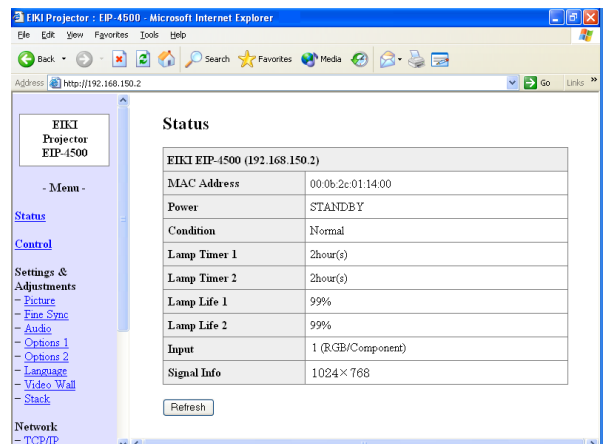
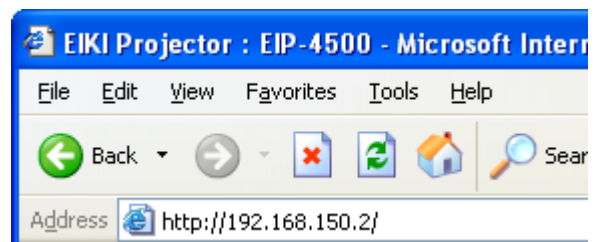

Controlling the Projector via LAN

Confirming the Projector Status (Status)

Status

EIKI EIP-4500 (192.168.150.2)	
MAC Address	00:0b:2c:01:14:00
Power	STANDBY
Condition	Normal
Lamp Timer 1	2hour(s)
Lamp Timer 2	2hour(s)
Lamp Life 1	99%
Lamp Life 2	99%
Input	1 (RGB/Component)
Signal Info	1024×768

Refresh

On this screen, you can confirm the projector status. You can confirm the following items :

- MAC Address
- Power
- Condition
- Lamp Timer 1
- Lamp Timer 2
- Lamp Life 1
- Lamp Life 2
- Input
- Signal Info

Note

- If you click the “Refresh” button before the screen is displayed completely, an error message (“Server Busy Error”) will be displayed. Wait for a moment and then operate again.
- For details about each item, refer to the owner’s manual of the projector.

Controlling the Projector (Control)

Control

Power	<input type="radio"/> STANDBY <input checked="" type="radio"/> ON
Input Select	INPUT1 (RGB/Component) ▾
Volume	1 ▾
Mute (Audio)	<input checked="" type="radio"/> OFF <input type="radio"/> ON
Black Screen	<input checked="" type="radio"/> OFF <input type="radio"/> ON

Refresh

On this screen, you can perform projector control. You can control the following items :

- Power
- Input Select
- Volume
- Mute (Audio) [OFF] [ON]
- Black Screen [OFF] [ON]

Note

- If you click the “Refresh” button before the screen is displayed completely, an error message (“Server Busy Error”) will be displayed. Wait for a moment and then operate again.
- You cannot operate this page while the projector is warming up.
- While the projector is in standby mode, you can only control “Power ON”.
- For details about each item, refer to the owner’s manual of the projector.

Setting and Adjusting the Projector (Settings & Adjustments)

Example: “Picture” screen display for INPUT 1 Settings & Adjustments - Picture (INPUT1)

Picture Mode	Standard <input type="button" value="Reset"/>
CLR Temp	7500K
Bright Boost	10
Progressive	3D Progressive
C.M.S. Adjustment	Standard
DNR	OFF
Signal Type	Auto

On these screens, you can make projector settings or adjustments. You can set or adjust the following items :

- Picture Mode
- CLR Temp
- Bright Boost
- Progressive
- C.M.S. Adjustment
- DNR
- Signal Type
- Auto Sync
- Auto Sync Disp
- Audio Out
- Internal Speaker [OFF][ON]
- Resize
- OSD Display
- Video System (INPUT 4/5)
- Background
- Startup Image
- Eco Mode [OFF][ON]
- Auto Search [OFF][ON]
- Auto Power Off [OFF][ON]
- Lamp Mode
- Projection Mode
- Keylock Level
- Set Inputs
- RS-232C Speed
- Monitor Out (Standby)
- OSD Language
- Video Wall (See page 41.)
- Stack Setting (See page 38.)

Note

- If you click the “Refresh” button before the screen is displayed completely, an error message (“Server Busy Error”) will be displayed. Wait for a moment and then operate again.
- You cannot operate this page while the projector is warming up.
- While the projector is in standby mode, you can only control “Power ON”.
- For details about each item, refer to the owner’s manual of the projector.

Setting the Security (Network – Security)

Network - Security

User Name	<input type="text"/> (MAX 8 characters)
Password	<input type="text"/> (MAX 8 characters)

This user name / password is for accessing via Web browser and Telnet.

*You will need to re-login with the new user name / new password after you change the user name / password.

Accept IP Address	<input checked="" type="radio"/> All IP Addresses
	<input type="radio"/> From only specific IP addresses
	Address 1 <input type="text"/> <input type="text"/> <input type="text"/> <input type="text"/>
	Address 2 <input type="text"/> <input type="text"/> <input type="text"/> <input type="text"/>
	Address 3 <input type="text"/> <input type="text"/> <input type="text"/> <input type="text"/>

On this screen, you can make settings relating to security.

Items	Description
User Name	Setting of user name for security protection.
Password	Setting of password for security protection.
Accept IP Address	It is possible to set up to three IP addresses allowing connection to the projector.
All IP Addresses	No limits are set to IP addresses connecting to the projector.
From only specific IP addresses	For security improvement, only an IP address set by “Address 1-3” can be connected to the projector.

After clicking the “Apply” button, the set values appear. Confirm that the values are set properly, and then click the “Confirm” button.

Note

- After setting items, wait for 10 seconds and then re-access.
- User Name and Password can be up to 8 characters.
- You can input the characters below :
a-z, A-Z, 0-9, -, _
- To cancel User Name and Password, enter nothing and then press “Apply” button.

Controlling the Projector via LAN

Making General Settings for the Network (Network - General)

Network - General

Projector Name	<input type="text" value="EIP-4500"/> (MAX 12 characters)
Auto Logout Time	<input type="text" value="5"/> minute(s) (0-65535) * If the set value is made 0, the Auto Logout function is disabled.
Data Port	<input type="text" value="10002"/> (1025-65535)
Search Port	<input type="text" value="9300"/> (1025-65535)

On this screen, you can make general settings relating to the network.

Items	Description
Projector Name	Setting the projector name.
Auto Logout Time	Setting the time interval in which the projector will be automatically disconnected from the network in units of a minute (from 1 to 65535 minutes). If the set value is made 0, the Auto Logout function is disabled.
Data Port	Setting the TCP port number used when exchanging a data with the projector (from 1025 to 65535).
Search Port	Setting the port number used when searching for the projector (from 1025 to 65535).

After clicking the “Apply” button, the set values appear. Confirm that the values are set properly, and then click the “Confirm” button.

Note

- After setting items, wait for 10 seconds and then re-access.
- Projector Name can be up to 12 characters.
- You can input the characters below :
A-Z, 0-9, -, _, (,), space
(When “a-z” are input, they are converted to “A-Z” automatically.)

Setting for Sending E-mail when an Error Occurs (Mail - Originator Settings)

Mail - Originator Settings

SMTP Server	<input type="text"/> (MAX 64 characters)
Originator E-mail Address	<input type="text"/> (MAX 64 characters)
Originator Name	<input type="text"/> (MAX 64 characters)

On this screen, you can make settings for sending e-mail to report when the projector has generated an error.

Items	Setting example / Remarks
SMTP Server	Setting an SMTP server address for e-mail transmission. e.g.1 : 192.168.150.253 e.g.2 : smtp123.eiki.co.jp * When using a domain name, make settings for the DNS server.
Originator E-mail Address	Setting the projector's e-mail address. The e-mail address set here becomes Originator E-mail Address.
Originator Name	Setting the sender's name. The name set here appears in the “Originator Name” column of the body of the message.

Note

- SMTP Server, Originator E-mail Address and Originator Name can be up to 64 characters.
- You can input the characters below:
SMTP Server and Originator E-mail Address :
a-z, A-Z, 0-9, !, #, \$, %, &, *, +, -, /, =, ?, ^, {, |, }, ~, _, ', ., @, ` (You can input “@” only one time for “Originator E-mail Address”.)
Originator Name : a-z, A-Z, 0-9, -, _, (,), space
- If the settings of “3. Setting up a Network Connection for the Projector” on pages 21 and 22 are incorrectly set, e-mail will not be send.

Setting Error Items and Destination Addresses to which E-mail is to be Sent when an Error Occurs (Mail – Recipient Settings)

Mail - Recipient Settings

Recipient Addresses	E-mail Address (MAX 64 characters)	Error Mail				Test
		Lamp	Temp	Fan	Cover	
1	<input type="text"/>	<input type="checkbox"/>	<input type="checkbox"/>	<input type="checkbox"/>	<input type="checkbox"/>	Test
2	<input type="text"/>	<input type="checkbox"/>	<input type="checkbox"/>	<input type="checkbox"/>	<input type="checkbox"/>	Test
3	<input type="text"/>	<input type="checkbox"/>	<input type="checkbox"/>	<input type="checkbox"/>	<input type="checkbox"/>	Test
4	<input type="text"/>	<input type="checkbox"/>	<input type="checkbox"/>	<input type="checkbox"/>	<input type="checkbox"/>	Test
5	<input type="text"/>	<input type="checkbox"/>	<input type="checkbox"/>	<input type="checkbox"/>	<input type="checkbox"/>	Test

Apply

Refresh

On this screen, you can input e-mail destinations to which error notification (error items) e-mails are sent.

Items	Description
E-mail Address	Set addresses to which error notification e-mail is sent. You can set up to five addresses.
Error Mail (Lamp, Temp, Fan, Cover)	Error e-mail is sent on the error items checked in their check boxes.
Test	Send test e-mail. This allows you to confirm that the settings for e-mail transmission are properly set.

Note

- E-mail Address can be up to 64 characters.
- You can input the characters below :
a-z, A-Z, 0-9, !, #, \$, %, &, *, +, -, /, =, ?, ^, {, |, }, ~, _ , ' , . , @ , ` (You can input “@” only one time.)
- For details about error items, refer to the owner’s manual of the projector.

Setting the Projector Using RS-232C or Telnet

Connect the projector to a computer using RS-232C or Telnet, and open the SETUP MENU on the computer to carry out various settings for the projector.

When Connecting Using RS-232C

1 Launch general purpose terminal emulator.

2 Input settings for the RS-232C port of the terminal emulator as follows.

Baud Rate : 9600 bps*
Data Length : 8 bit
Parity Bit : None
Stop Bit : 1 bit
Flow Control : None

* This is the factory default setting. If the value of Baud Rate for the projector has been changed, set Baud Rate here according to the changed value on the projector.

3 Input "PJS11234" and press the "Enter" key.

4 "OK" is displayed. Input "PJS25678" and press the "Enter" key within 10 seconds.

5 "OK" is displayed. Press the "Enter" key.

6 "User Name:" is displayed. Input the user name and press the "Enter" key.

• If a user name has not yet been set, just press the "Enter" key.

7 "Password:" is displayed. Input the password and press the "Enter" key.

• If a password has not yet been set, just press the "Enter" key.

8 Input "setup" and press the "Enter" key.

• SETUP MENU will be displayed.

▼SETUP MENU

```
-----SETUP MENU-----  
[1]IP Address      [2]Subnet Mask    [3]Default Gateway  
[4]User Name      [5>Password  
[6]RS-232C Baud Rate [7]Projector Name  
[A]Advanced Setup [D]Disconnect All  
[V]View All Setting [S]Save & Quit    [Q]Quit Unchanged  
  
setup>
```

Note

- User name and password are not set in the factory default settings.
- If the user name or password is entered incorrectly three times, SETUP MENU will be quit.

When Connecting Using Telnet

1 Click “start” from the Windows® desktop and select “Run”.

2 Enter “telnet 192.168.150.2” in the text box that opens up. (If the IP address of the projector is 192.168.150.2.)

3 Click the “OK” button.

4 “User Name:” is displayed. Input the user name and press the “Enter” key.

- If a user name has not yet been set, just press the “Enter” key.

5 “Password:” is displayed. Input the password and press the “Enter” key.

- If a password has not yet been set, just press the “Enter” key.

6 Input “setup” and press the “Enter” key.

- SETUP MENU will be displayed.

▼SETUP MENU

```
-----SETUP MENU-----  
[1]IP Address           [2]Subnet Mask       [3]Default Gateway  
[4]User Name           [5]Password  
[6]RS-232C Baud Rate   [7]Projector Name  
[A]Advanced Setup      [D]Disconnect All  
[V]View All Setting    [S]Save & Quit      [Q]Quit Unchanged  
  
setup>
```

Note

- If the IP address has been changed, ensure to enter the new IP address in step 2.
- User name and password are not set in the factory default settings.
- If the user name or password is entered incorrectly three times in steps 4 or 5, SETUP MENU will be quit.

Setting the Projector Using RS-232C or Telnet

SETUP MENU (Main Menu)

▼ SETUP MENU

```
-----SETUP MENU-----  
[1]IP Address      [2]Subnet Mask    [3]Default Gateway  
[4]User Name      [5]Password  
[6]RS-232C Baud Rate [7]Projector Name  
[A]Advanced Setup [D]Disconnect All  
[V]View All Setting [S]Save & Quit   [Q]Quit Unchanged  
  
setup>
```

- [1]IP Address (Factory default setting : 192.168.150.2)**
IP address settings. (Page 33)
- [2]Subnet Mask (Factory default setting : 255.255.255.0)**
Subnet mask settings. (Page 33)
- [3]Default Gateway (Factory default setting : Not Used)**
Default gateway settings. (Page 33)
- [4]User Name (Factory default setting : Not Required)**
Setting of user name for security protection. (Page 34)
- [5]Password (Factory default setting : Not Required)**
Setting of password for security protection. (Page 34)
- [6]RS-232C Baud Rate (Factory default setting : 9600 bps)**
Baud rate settings for the RS-232C terminals. (Page 34)
- [7]Projector Name (Factory default setting : EIP-4500)**
It is possible to assign a projector name. (Page 34)
- [A]Advanced Setup**
Enters ADVANCED SETUP MENU. (Page 35)
- [D]Disconnect All**
Disconnect all connections. (Page 35)
- [V]View All Setting**
Displays all setting values. (Page 31)
Can also be used with ADVANCED SETUP MENU.
- [S]Save & Quit**
Save set values and quit menu. (Page 32)
- [Q]Quit Unchanged**
Quit menu without saving setting values. (Page 32)

ADVANCED SETUP MENU

▼ ADVANCED SETUP MENU

```
***** ADVANCED SETUP MENU *****  
[1]Auto Logout Time [2]Data Port  
[5]Network Ping Test  
[6]Accept IP Addr(1) [7]Accept IP Addr(2) [8]Accept IP Addr(3)  
[9]Accept All IP Addr [0]Search Port  
  
[!]Restore Default Setting  
[Q]Return to Main Menu  
  
advanced>
```

- [1]Auto Logout Time (Factory default setting : 5 minutes)**
Setting of time until automatic disconnection of network connection. (Page 35)
- [2]Data Port (Factory default setting : 10002)**
Setting the TCP port number used when exchanging data. (Page 35)
- [5]Network Ping Test**
It is possible to confirm that a network connection between the projector and a computer etc. is working normally. (Page 36)
- [6]Accept IP Addr(1)**
- [7]Accept IP Addr(2)**
- [8]Accept IP Addr(3)**
- [9]Accept All IP Addr (Factory default setting : Accept All)**
For improved security, it is possible to set up to three IP addresses allowing connection to the projector. Set IP addresses can be cancelled using [9] Accept All IP Addr. (Page 36)
- [0] Search Port (Factory default setting : 9300)**
Setting the port number used when searching for the projector. (Page 37)
- [!] Restore Default Setting**
Restores all setting values that can be set using the menu to the default state. (Page 37)
- [Q]Return to Main Menu**
Return to the main SETUP MENU. (Page 37)

Controlling the Projector Using RS-232C or Telnet

Enter number or symbol of item to be selected on the SETUP MENU. When setting, input the details to be set. Setting is carried out one item at a time, and saved at the end.

View Setting Detail List ([V]View All Setting)

▼SETUP MENU

```
-----SETUP MENU-----
[1]IP Address      [2]Subnet Mask   [3]Default Gateway
[4]User Name       [5]Password
[6]RS-232C Baud Rate [7]Projector Name
[A]Advanced Setup  [D]Disconnect All
[V]View All Setting [S]Save & Quit    [Q]Quit Unchanged

setup>v
Model Name       : EIP-4500
Projector Name   : EIP-4500
MAC Address      : 00:0b:2c:01:14:00
IP Address       : 192.168.150.2
Subnet Mask      : 255.255.255.0
Default Gateway  : Not Used
RS-232 Baud Rate : 9600 bps
Password         : Not Required
***** (Advanced Status) *****
Data Port        : 10002
Accept IP Address : Accept All
Auto Logout Time : 5 minutes
Search Port      : 9300
```

- ① Enter “v” and press the “Enter” key.
Display all setting values(*).

Set Items

Example: When setting IP Address (change from 192.168.150.2 to 192.168.150.3)

▼SETUP MENU

```
-----SETUP MENU-----
[1]IP Address      [2]Subnet Mask   [3]Default Gateway
[4]User Name       [5]Password
[6]RS-232C Baud Rate [7]Projector Name
[A]Advanced Setup  [D]Disconnect All
[V]View All Setting [S]Save & Quit    [Q]Quit Unchanged

setup>1
IP Address       : 192.168.150.2
Please Enter     : 192.168.150.3
(change)        -> 192.168.150.3

-----SETUP MENU-----
[1]IP Address      [2]Subnet Mask   [3]Default Gateway
[4]User Name       [5]Password
[6]RS-232C Baud Rate [7]Projector Name
[A]Advanced Setup  [D]Disconnect All
[V]View All Setting [S]Save & Quit    [Q]Quit Unchanged

setup>v
Model Name       : EIP-4500
Projector Name   : EIP-4500
MAC Address      : 00:0b:2c:01:14:00
IP Address       : 192.168.150.3
Subnet Mask      : 255.255.255.0
Default Gateway  : Not Used
RS-232 Baud Rate : 9600 bps
Password         : Not Required
***** (Advanced Status) *****
Data Port        : 10002
Accept IP Address : Accept All
Busy Reply       : ERR+<CR> code
Input Hold Time  : 1000 milliseconds
Auto Logout Time : 5 minutes
Search Port      : 9300
```

- ① Enter “1” (number of item to be set), and press the “Enter” key.
Display current IP address (*1).
- ② Enter IP address to be set and press the “Enter” key.
Display IP address after change (*2).
- ③ Enter “v” and press the “Enter” key to verify setting detail list.
IP address is being changed (*3).

Note

- Verification of setting detail list can be omitted.
- Setting details are not effective until they have been saved. (Page 32)
- If an invalid number is entered, an error message (“Parameter Error!”) will be displayed.

Controlling the Projector Using RS-232C or Telnet

Save Settings and Quit ([S]Save & Quit)

Save set values and quit menu.

▼SETUP MENU

```
-----SETUP MENU-----
[1]IP Address      [2]Subnet Mask   [3]Default Gateway
[4]User Name      [5]Password
[6]RS-232C Baud Rate [7]Projector Name
[A]Advanced Setup [D]Disconnect All
[V]View All Setting [S]Save & Quit   [Q]Quit Unchanged

setup>s
All Connection will be disconnect.
Continue(y/n)? y
Apply New setting...Done.
```

- ① Enter “s” and press the “Enter” key.
- ② Enter “y” and press the “Enter” key.

Quit without Saving Settings ([Q]Quit Unchanged)

Quit menu without saving setting values.

▼SETUP MENU

```
-----SETUP MENU-----
[1]IP Address      [2]Subnet Mask   [3]Default Gateway
[4]User Name      [5]Password
[6]RS-232C Baud Rate [7]Projector Name
[A]Advanced Setup [D]Disconnect All
[V]View All Setting [S]Save & Quit   [Q]Quit Unchanged

setup>q
Quit Without Saving(y/n)? y
Setting Unchanged.
```

- ① Enter “q” and press the “Enter” key.
- ② Enter “y” and press the “Enter” key.

The setting procedure for each item will be explained. For the basic procedure, please refer to “Set Items” on page 31.

IP Address Setting ([1]IP Address)

Setting of IP address.

```
Setup>1  
IP Address      :192.168.150.2  
Please Enter    :192.168.150.3  
(change)  -> 192.168.150.3 *
```

- ① Enter “1” and press the “Enter” key.
- ② Enter numerical value to be set and press the “Enter” key.
Display IP address after change (*).

Subnet Mask Setting ([2]Subnet Mask)

Setting subnet mask.

```
Setup>2  
Subnet Mask    :255.255.255.0  
Please Enter    :255.0.0.0  
(change)  -> 255.0.0.0 *
```

- ① Enter “2” and press the “Enter” key.
- ② Enter numerical value to be set and press the “Enter” key.
Display subnet mask after change (*).

Default Gateway Setting ([3]Default Gateway)

Setting default gateway.

```
Setup>3  
note: “0.0.0.0” means “Using no default gateway.”  
Gateway Address :0.0.0.0  
Please Enter    :192.168.150.1  
(change)  -> 192.168.150.1 *
```

- ① Enter “3” and press the “Enter” key.
- ② Enter numerical value to be set and press the “Enter” key.
Display gateway address after change (*).

Note

- If the values for IP Address, Subnet Mask or Gateway of the projector have been changed via Telnet, the computer cannot be connected to the projector depending on the computer’s network settings.

Controlling the Projector Using RS-232C or Telnet

User Name Setting ([4]User Name)

Carrying out security protection using user name.

```
setup>4  
User Name      :  
Please Enter    : EIP-4500  
(change)      -> EIP-4500 *
```

- ① Enter “4” and press the “Enter” key.
- ② Enter user name and press the “Enter” key.
Display set user name (*).

Note

- User name can be up to 8 characters.
- You can input the characters below :
a-z, A-Z, 0-9, -, _
- In the default state, user name is not set.

Password Setting ([5]Password)

Carrying out security protection using password.

```
setup>5  
Password      :  
Please Enter    : eiki4500  
(change)      -> eiki4500 *
```

- ① Enter “5” and press the “Enter” key.
- ② Enter password and press the “Enter” key.
Display set password (*).

Note

- Password can be up to 8 characters.
- You can input the characters below :
a-z, A-Z, 0-9, -, _
- In the default state, the password is not set.

RS-232C Baud Rate Setting ([6]RS-232C Baud Rate)

Setting of baud rate for RS-232C (COMPUTER and PROJECTOR) terminals.

```
setup>6  
  
note: It sets both RS-232C (COMPUTER) and RS-232C (PROJECTOR).  
0 ... 9600 bps  
1 ... 38400 bps  
2 ... 115200 bps  
Baud Rate Select[0-2] :2  
RS-232C Baud Rate : 115200 bps *
```

- ① Enter “6” and press the “Enter” key.
- ② Select and enter the number 0, 1 or 2 and press the “Enter” key.
Display set baud rate (*).

Note

- Set the projector’s baud rate to the same rate as that used by the computer.

Projector Name Setting ([7]Projector Name)

It is possible to assign a projector name.

```
setup>7  
Projector Name : EIP-4500  
Please Enter    : MY EIP-4500  
(change)      -> MY EIP-4500 *
```

- ① Enter “7” and press the “Enter” key.
- ② Enter projector name.
Display set projector name (*).

Note

- Projector name can be up to 12 characters.
- You can input the characters below :
A-Z, 0-9, -, _, (,), space
(When “a-z” are input, they are converted to “A-Z” automatically.)
- It is the same as the name which can be confirmed or set, using RS-232C commands “PJN0”, “PJN1”, “PJN2” and “PJN3”.

Disconnecting All Connections ([D]Disconnect All)

It is possible to disconnect all the TCP/IP connections currently recognized by the projector. Even if the COM Redirect port is fixed in the Busy status due to a problem, it is possible to force the Ready status back by carrying out this disconnection.

```

setup>d
Disconnect All Connections(y/n)?y
Now Disconnecting...
    
```

- ① Enter “d” and press the “Enter” key.
- ② Enter “y” and press the “Enter” key.

Note

- If Disconnect All is performed, the connection to the projector via network will be forcibly disconnected.

Entering ADVANCED SETUP MENU

([A]Advanced Setup)

Enters ADVANCED SETUP MENU.

```

setup>a
***** ADVANCED SETUP MENU *****
[1]Auto Logout Time  [2]Data Port
[5]Network Ping Test
[6]Accept IP Addr(1)  [7]Accept IP Addr(2)  [8]Accept IP Addr(3)
[9]Accept All IP Addr  [0]Search Port

[!]Restore Default Setting
[Q]Return to Main Menu

advanced>
    
```

- ① Enter “a” and press the “Enter” key.

Setting Auto Logout Time (ADVANCED[1]Auto Logout Time)

If there is no input after a fixed time, the projector automatically disconnects network connection using the Auto Logout function. It is possible to set the time until the projector is automatically disconnected in units of a minute (from 1 to 65535 minutes).

```

advanced>1
Valid range      : 0 to 65535 (minute)
note: if you enter "0", auto logout function will be disable.
Auto Logout Time : 5
Please Enter      :15
(change)         -> 15 *
    
```

- ① Enter “1” and press the “Enter” key.
- ② Enter numerical value and press the “Enter” key. Display set numerical value (*).

Note

- If the set value is made 0, the Auto Logout function is disabled.
- If an invalid number is entered, an error message (“Parameter Error!”) will be displayed and the screen returns to the ADVANCED SETUP MENU.

Data Port Setting

(ADVANCED[2]Data Port)

Setting of TCP port number. It is possible to set in the range of 1025 to 65535.

```

advanced>2
Valid range      :1025 to 65535
Data Port        :10002
Please Enter      :10005
(change)         -> 10005 *
    
```

- ① Enter “2” and press the “Enter” key.
- ② Enter numerical value and press the “Enter” key. Display set numerical value (*).

Note

- Set according to need. Normally, use with the factory default setting.

Carrying out Network Ping Test (ADVANCED[5]Network Ping Test)

It is possible to confirm that a network connection between the projector and a computer etc. is working normally.

```
advanced>5 ①
Ping dest IP addr :192.168.150.1
Please Enter :192.168.150.152 ②
(change) -> 192.168.150.152 *1
32 bytes from 192.168.150.152: icmp_seq = 1, time = 0 ms
32 bytes from 192.168.150.152: icmp_seq = 2, time = 0 ms
32 bytes from 192.168.150.152: icmp_seq = 3, time = 0 ms
32 bytes from 192.168.150.152: icmp_seq = 4, time = 0 ms *2
```

- ① Enter “5” and press the “Enter” key.
- ② Enter IP address of device to be tested and press the “Enter” key.
Display entered IP address (*1).
Display test result (*2).

Note

- If the “Enter” key is pressed without entering an IP address, the Ping destination IP address used previously is entered.
- If there is a fault with the connection, “Error: No answer” is displayed after a 5 second retry. In this case, please confirm the settings for the projector and the computer, and contact your network administrator.

Setting of Accept IP Address (ADVANCED[6]Accept IP Addr(1) - [8]Accept IP Addr(3))

It is possible to improve security of the projector by allowing connection from only a prescribed IP address. It is possible to set up to three IP addresses allowing connection to the projector.

```
advanced>6 ①
Accept IP Addr(1) : 0.0.0.0
Please Enter : 192.168.150.152 ②
(change) -> 192.168.150.152 *
```

- ① Enter “6”, “7” or “8” and press the “Enter” key.
- ② Enter numerical value and press the “Enter” key.
Display set numerical value (*).

Note

- To invalidate the Accept IP Addr being currently set, enter “0.0.0.0”.
- If there is one or more Accept IP Addr being set, no connections are allowed from IP addresses that are not yet set. They can be cancelled using [9]Accept All IP Addr.

Accepting All IP Addresses (ADVANCED[9]Accept All IP Addr)

Removes IP addresses set with “Accept IP Addr”.

```
advanced>9 ①
Accept All IP Addresses(y/n)? y ②
```

- ① Enter “9” and press the “Enter” key.
- ② Enter “y” and press the “Enter” key.

Note

- At the point in time where “y” was entered, the numerical values for Accept IP Addr(1)-(3) are reset to “0.0.0.0”.
- If “n” is entered, setting is not altered.

Setting of Search Port (ADVANCED[0]Search Port)

Sets the port number used when searching for the projector from the network.

```
advanced>0
Please Enter Port Number for Search from Computer.
Valid range      : 1025 to 65535
Search Port      : 9300
Please Enter      : 9301
(change)         -> 9301 *
```

- ① Enter “0” and press the “Enter” key.
- ② Enter numerical value and press the “Enter” key.
Display set numerical value (*).

Note

- Set according to need. Normally, use with the factory default setting.

Return to Default Settings (ADVANCED[!]Restore Default Setting)

Returns all menu setting values to the default state.

```
advanced>!
Restore All Setting to Default(y/n)? y
— User Setting Initialized —
```

- ① Enter “!” and press the “Enter” key.
- ② Enter “y” and press the “Enter” key.

Note

- If the values for IP Address, Subnet Mask or Gateway of the projector have been returned to the default settings via Telnet, the computer cannot be connected to the projector depending on the computer’s network settings.

Return to Main Menu (ADVANCED[Q]Return to Main Menu)

Returns to the main SETUP MENU.

```
advanced>q
----- SETUP MENU -----
[1]IP Address      [2]Subnet Mask    [3]Default Gateway
[4]User Name       [5]Password
[6]RS-232C Baud Rate [7]Projector Name
[A]Advanced Setup  [D]Disconnect All
[V]View All Setting [S]Save & Quit     [Q]Quit Unchanged
setup>
```

- ① Enter “q” and press the “Enter” key.
Returns to the SETUP MENU.

Stack Projection

The stack projection allows you to increase the brightness of an image by stacking two projectors and projecting same image simultaneously.

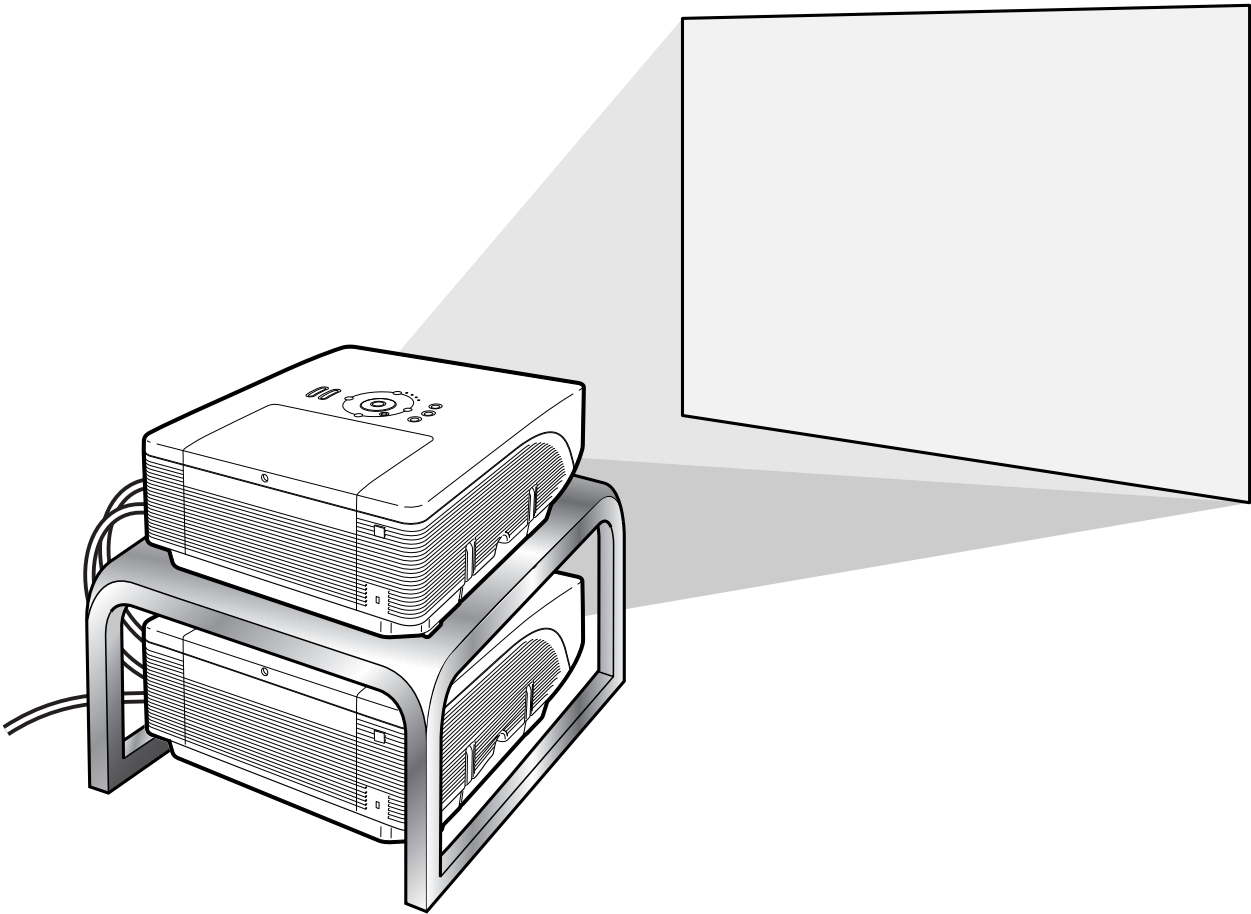

Info

- To set up the stack projection, assign a projector as the master and the other projector as the slave and connect the projectors with commercially available LAN cables (UTP cable, Category 5, cross-over type). In this way, you can control the both projectors with one remote control.
- The buttons below can control both the master and the slave at one time.
 - STANDBY-ON button
 - BLACK SCREEN button
 - INPUT 1 - 5 buttons
 - MUTE button
 - VOLUME buttons
 - AUTO SYNC button
 - RESIZE button
 - PICTURE MODE button
 - BREAK TIMER button
 - FREEZE button
- In normal operation, the projector set as the slave cannot be controlled by the remote control. Only while the remote control is connected to the projector with a $\varnothing 3.5$ mm minijack cable (commercially available), the projector set as the slave can be controlled by the remote control.
- Even while the projector is set as the slave, the buttons on the projector can be used.

Setting up the Stack Projection

Basic

This part shows an example for setting up the stack projection of a computer image with two projectors.

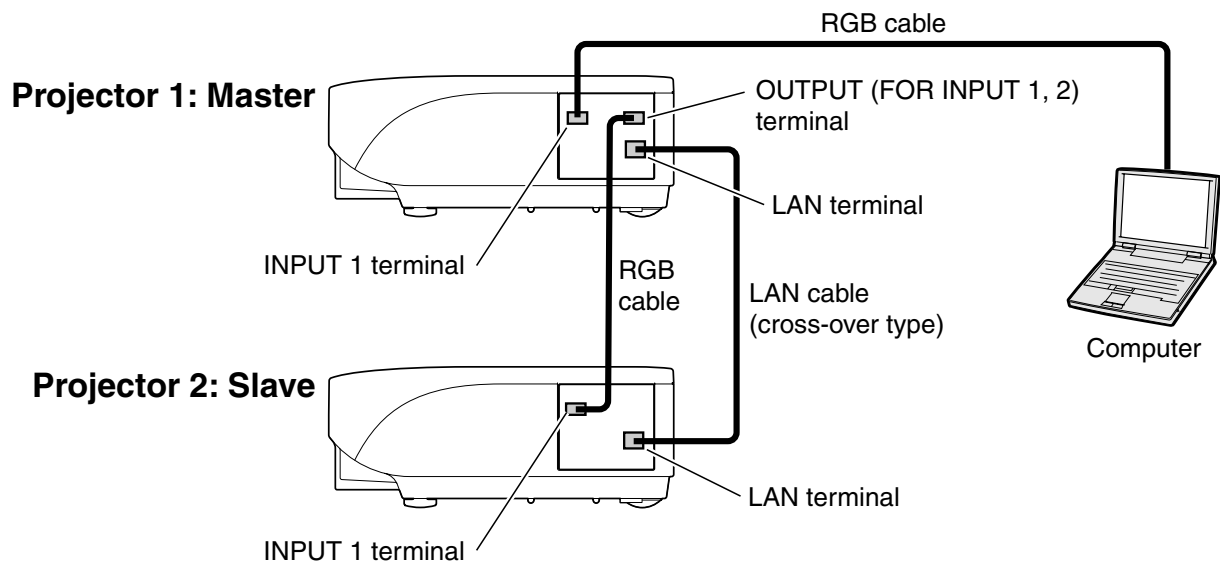

1 Set the “Stack Setting” of the projector 1 to “Master”.

(See page 84 on the owner’s manual of the projector.)

2 Set the “Stack Setting” of the projector 2 to “Slave”.

(See page 84 on the owner’s manual of the projector.)

3 Perform “Pair Stack” of the both projectors.

(See page 85 on the owner’s manual of the projector.)

4 Select inputs as specified in the table below.

(See page 86 on the owner’s manual of the projector.)

Projector 1		Projector 2	
Master		Slave	
Set Inputs		Set Inputs	
INPUT1	ON	INPUT1	ON
INPUT2	OFF	INPUT2	OFF
INPUT3	OFF	INPUT3	OFF
INPUT4	OFF	INPUT4	OFF
INPUT5	OFF	INPUT5	OFF

5 Turn off the both projectors.

Stack Projection

6 Connect the **INPUT 1** terminal on the projector 1 to the **RGB output terminal** on the computer using the **RGB cable**.
(See page 27 on the owner's manual of the projector.)

7 Connect the **OUTPUT (FOR INPUT 1, 2)** terminal on the projector 1 to the **INPUT 1** terminal on the projector 2 using an **RGB cable**.
(See page 36 on the owner's manual of the projector.)

8 Connect the **LAN terminal** on the projector 1 to the **LAN terminal** on the projector 2 using a commercially available **LAN cable (UTP cable, Category 5, cross-over type)**.

9 Turn on the projectors first, then turn on the computer.

Note

- When connecting an RGB cable to the projector 2, use the input terminal that has the same number as the projector 1. (INPUT 1 terminal, in this case)

Application

When inputting multiple image sources, refer to the example below.

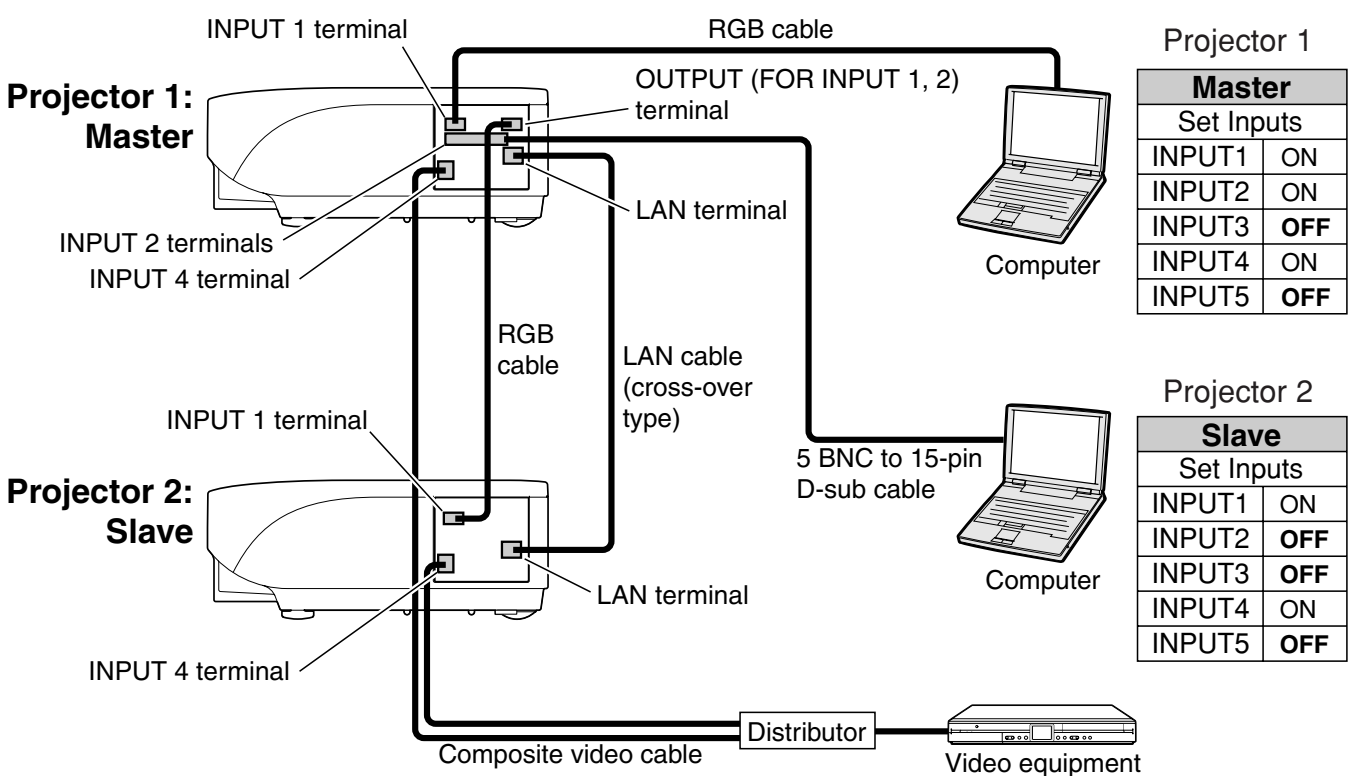

Video Wall Projection

Usually, a costly image-processing device is required to set up a video wall projection. This projector has built-in video wall capability that doesn't require additional equipment.

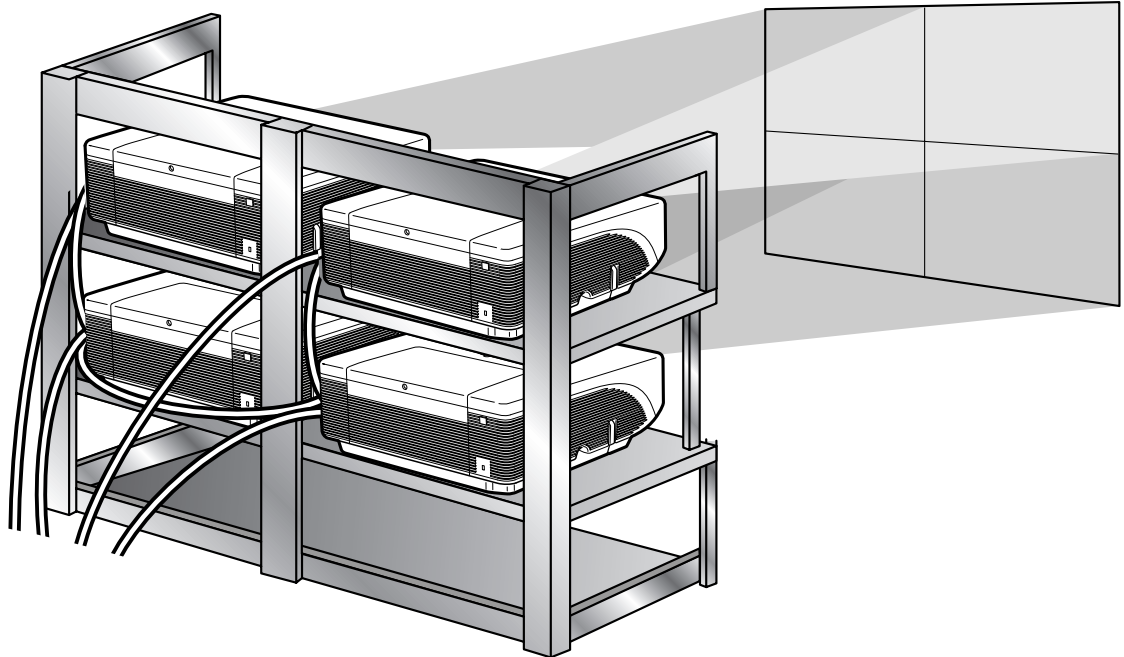

Info

- Before setting up the video wall projection, install Internet Explorer (version 5.0 or later).
- Video wall is not compatible with resolutions higher than SXGA.
- Image quality may deteriorate when picture signals are input through multiple projectors with an RGB cable or an RCA cable in a daisy chain connection.

Setting up the Video Wall Projection **Basic**

Following is an example of how to build a 2 X 2 video wall using 4 projectors.

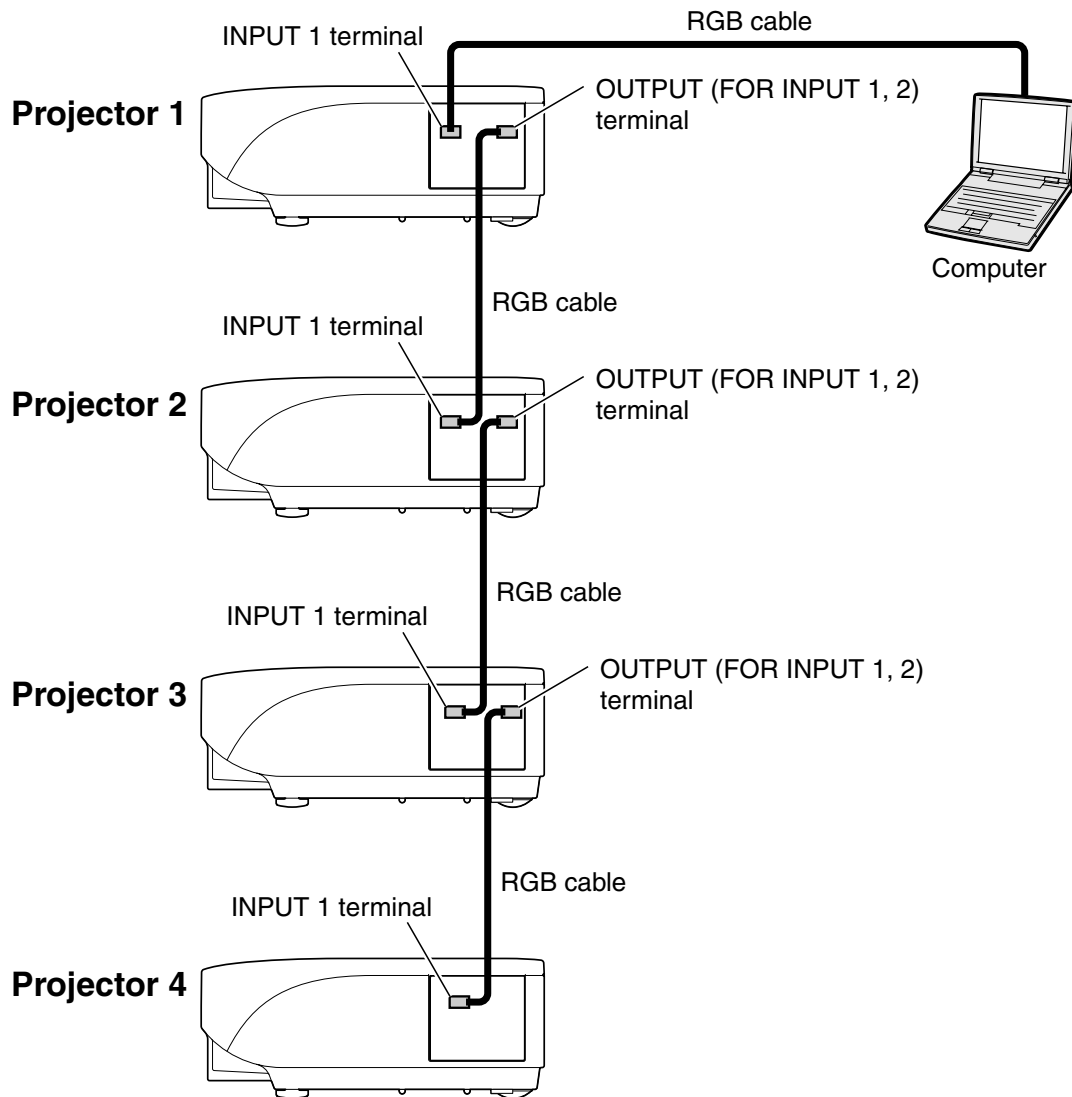

1 Access one of the four projectors via Internet Explorer.

(See “Controlling the Projector Using Internet Explorer (Version 5.0 or later)” (page 23) for the details.)

2 Click “Video Wall” on the menu.

- “Video Wall” display will appear.

3 Select “2 X 2” on “Division”.

4 Click the assigning button for the desired position.

- The projector will be assigned to the part of the video wall.

Note

- For more details on the assigned position and the actual position of the projector, see “Assigning the Projected Image on the Video Wall Setup” (page 44).

5 Repeat the same procedure from the step 1 to 4 for the other three projectors.

That completes the video wall setup. When the same image signal is input to all the projectors, the video wall projection starts.

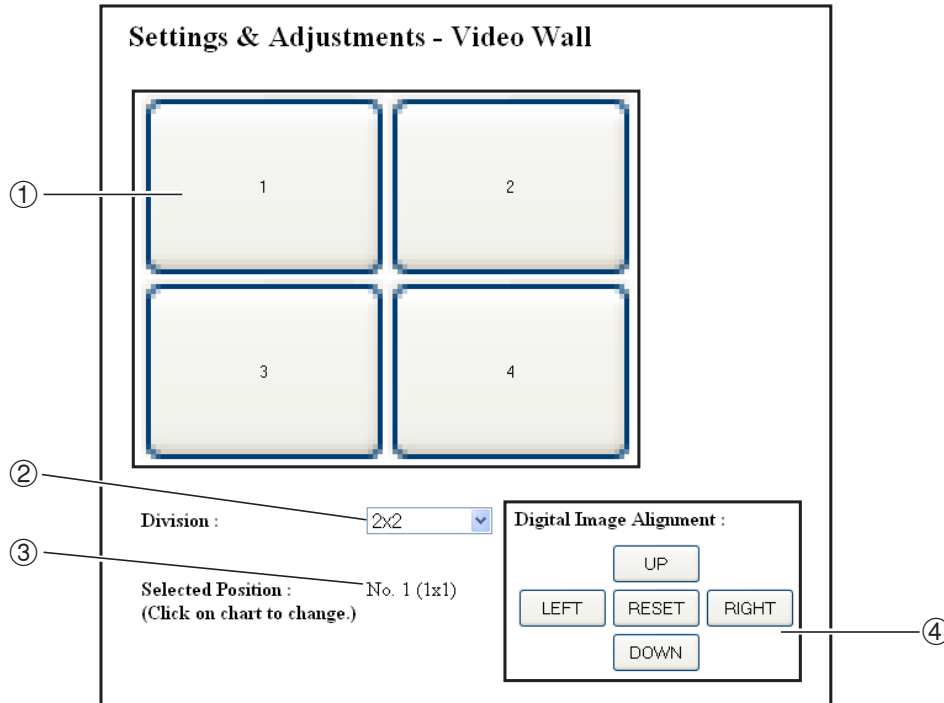

- ① Selects a position for each projector. (the assigning buttons)
- ② Selects a number of positions where the video wall is divided.
- ③ Displays the current status for the video wall setup.
- ④ Adjusts the position of the projected image horizontally and vertically.

Video Wall Projection

Adjusting the Position Horizontally and Vertically

Click “UP”, “DOWN”, “LEFT” or “RIGHT” to the position of the projected image.

Returning to the Default Video Wall Setup

- 1 Select “1 X 1” on “Division”.
- 2 Click the assigning button 1.
 - The video wall setup will return to the default settings.

Assigning the Projected Image on the Video Wall Setup

Followings are examples for assigning the projected images for the front and rear projections.

Front Projection

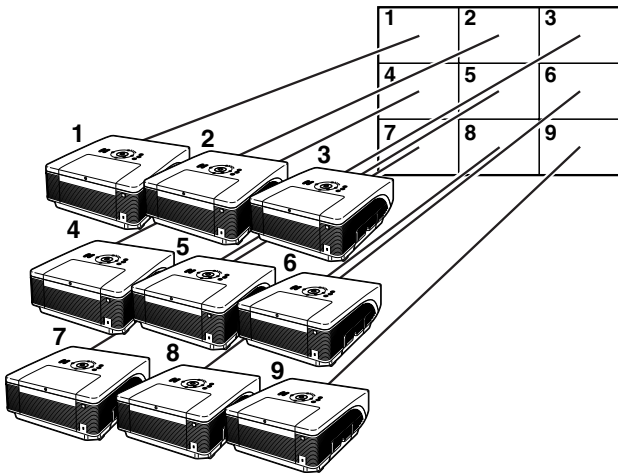

The numbers of the projector refer to the numbers of the projected positions.

Rear Projection

The numbers of the projector refer to the numbers of the projected positions.

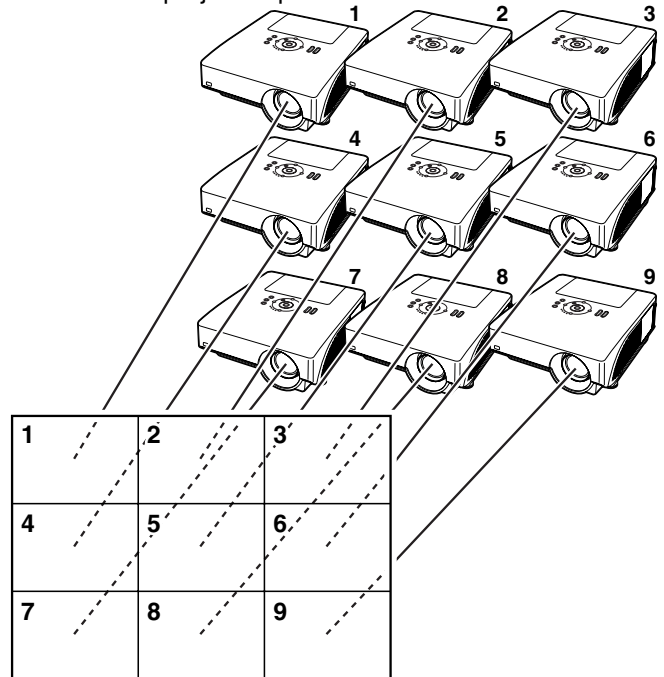

Notes on the Wide Video Wall Projection

Selecting “2 X 1”, “3 X 1”, “4 X 1”, “5 X 1”, “6 X 1”, “7 X 1” or “8 X 1” on “Division” (see page 43) allows you to create the wide video wall.

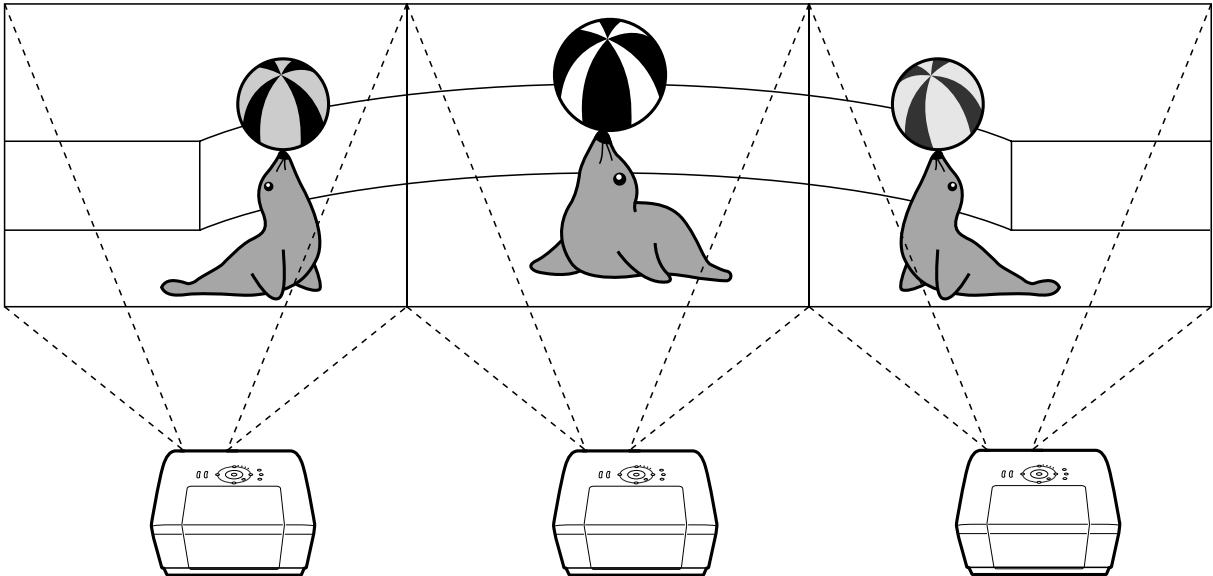

To create the wide video wall with three projectors lining up in single file from left to right (as shown above), select “3 X 1” on “Division”, select a position for each projector, and then input the image which width is compressed at 1/3 (as shown below).

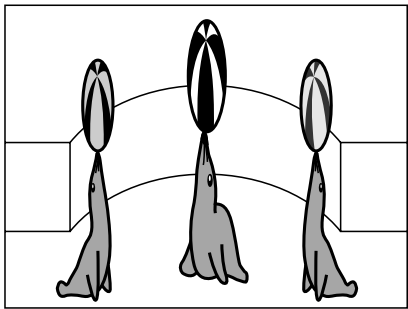

Setting up the Video Wall Projection **Application**

Using “Stack Setting” and “Set Inputs” functions together allows you to control the video wall with one remote control.

This part shows an example of a connecting procedure for inputting the video signals to the video wall based on the example in the previous section.

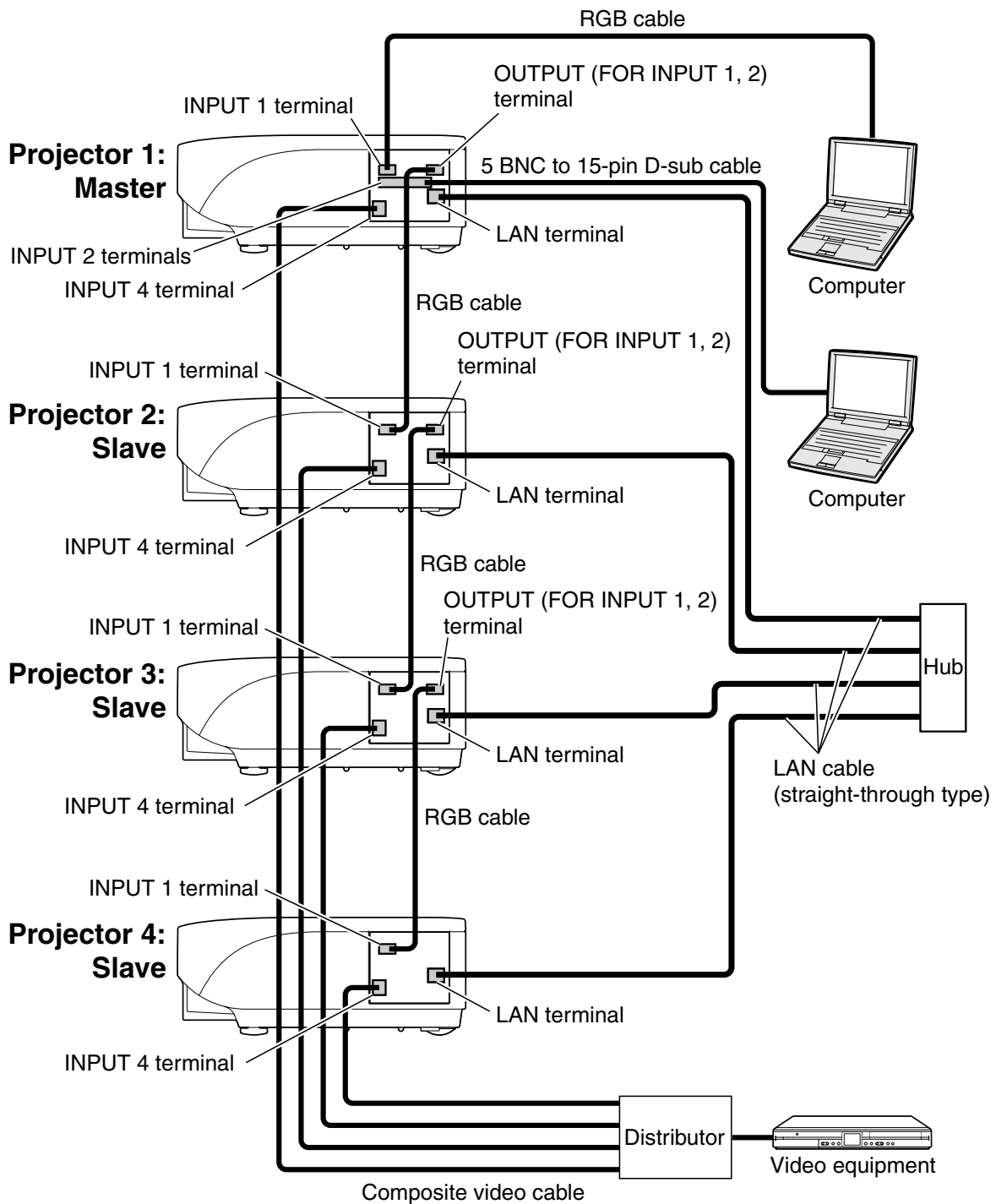

■ Preparation

- Follow the procedure below after setting up the basic connection.
- When “User Name” and “Password” have been set to the projector, reset them before the stack projection setup. To set “User Name” and “Password”, use the same user name and password for both of the master and slave projectors. (See page 25.)
- Set “Data Port” with the same number for both of the master and slave projectors. (See page 26.)

Info

- Do not use network software or equipment while it is accessing the projector via the port of the same number used for the master or slave projector, otherwise you cannot properly control multiple projectors with one remote control.

1 Change the TCP/IP settings for the computer as shown below.

(See “Setting an IP Address for the Computer” on page 19 for the details.)

- IP address : 192.168.150.2
- Subnet mask : 255.255.255.0
- Default gateway : (Do not input any values.)

Note

- The TCP/IP settings shown are examples to make connections following the diagram.
- When using other equipment in the same network, be careful about the IP address overlap or other network settings.
- Consult your network administrator for assistance with the network settings.

2 Change the TCP/IP settings for each projector as shown below.

(See “Setting up a Network Connection for the Projector” on page 21 for the details.)

- IP address
 - Projector 1 : 192.168.150.3
 - Projector 2 : 192.168.150.4
 - Projector 3 : 192.168.150.5
 - Projector 4 : 192.168.150.6
- Subnet mask : 255.255.255.0
- Default gateway : 0.0.0.0

3 Connect the computer and the projectors as shown below.

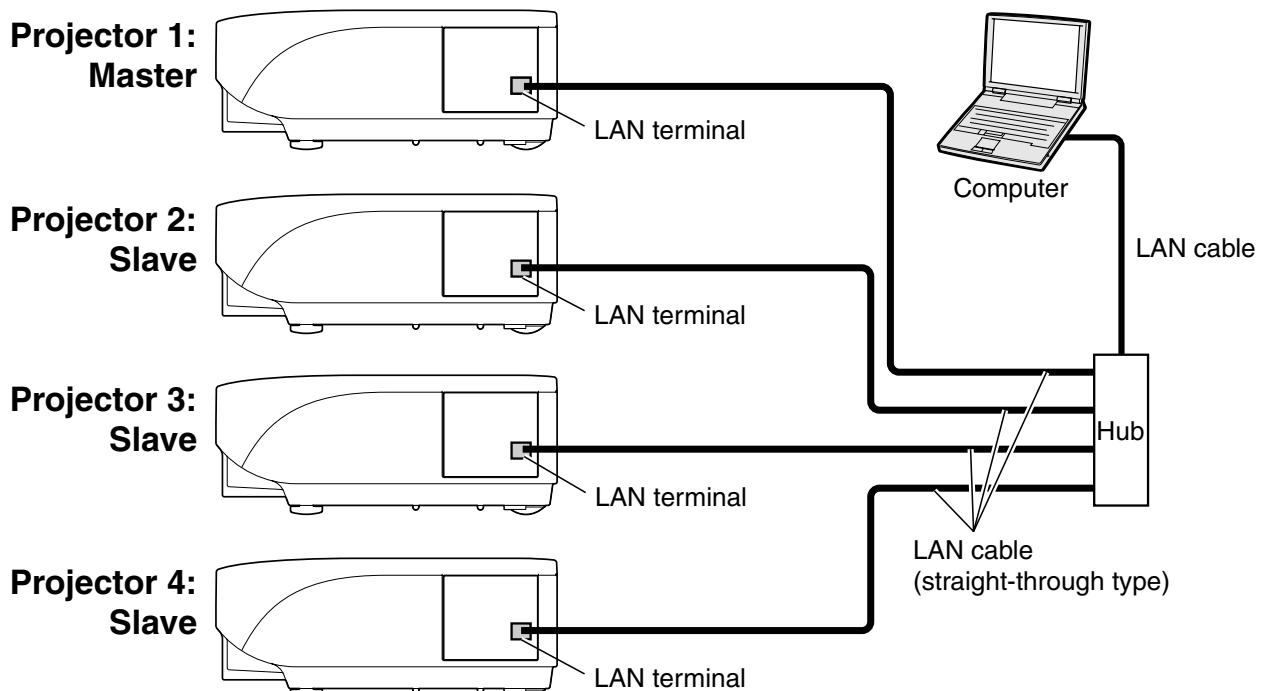

Video Wall Projection

4 Turn on all of the projectors.

5 Access the projector 1 from the computer via Internet Explorer.
(See “Controlling the Projector Using Internet Explorer (Version 5.0 or later)” on page 23 for the details.)

6 Click “Stack” on the menu.

7 Select “Master” on “Stack Setting”.
• “Slave Address” display will appear.

Stack Setting	Master
Slave 1	0 0 0 0 (IP Address)
Slave 2	0 0 0 0 (IP Address)
Slave 3	0 0 0 0 (IP Address)
Slave 4	0 0 0 0 (IP Address)
Slave 5	0 0 0 0 (IP Address)

8 Make the IP address for each projector as shown below.
• Slave 1 : 192.168.150.4
• Slave 2 : 192.168.150.5
• Slave 3 : 192.168.150.6

9 Click the “Apply” button.

10 Access the projector 2 from the computer via Internet Explorer.
(See “Controlling the Projector Using Internet Explorer (Version 5.0 or later)” on page 23 for the details.)

11 Click “Stack” on the menu.

12 Select “Slave” on “Stack Setting”.

13 Repeat the same procedure from the step 10 to 12 for the projector 3 and 4.

14 Select inputs as specified in the table on the right.
(See page 86 on the owner's manual of the projector.)

 **Note**

- Set input terminals you will use to "ON". Set input terminals you will not use to "OFF".

15 Turn off all of the projectors.

16 Make connections following the diagram shown on page 46.

17 Turn on the projectors first, then turn on the computers and the video equipment.

 **Note**

- Image quality may deteriorate when picture signals are input through multiple projectors with an RGB cable or an RCA cable in a daisy chain connection.

Projector 1

Master	
Set Inputs	
INPUT1	ON
INPUT2	ON
INPUT3	OFF
INPUT4	ON
INPUT5	OFF

Projector 2-4

Slave	
Set Inputs	
INPUT1	ON
INPUT2	OFF
INPUT3	OFF
INPUT4	ON
INPUT5	OFF

Communication cannot be established with the projector

When connecting the projector using serial-connection

- ◀ Check that the RS-232C terminal of the projector and a computer or the commercially available controller are connected correctly.
- ◀ Check that the RS-232C cable is a cross-over cable.
- ◀ Check that the RS-232C port setting for the projector corresponds to the setting for the computer or the commercially available controller.

When connecting the projector to a computer using network (LAN)-connection

- ◀ Check that the cable's connector is firmly inserted in the LAN terminal of the projector.
- ◀ Check that the cable is firmly inserted into a LAN port for a computer or a network device such as a hub.
- ◀ Check that the LAN cable is a Category 5 cable.
- ◀ Check that the LAN cable is a cross-over cable when connecting the projector to a computer directly.
- ◀ Check that the LAN cable is a straight-through cable when connecting the projector with a network device such as a hub.
- ◀ Check that the power supply is turned on for the network device such as a hub between the projector and a computer.

Check the network settings for the computer and the projector

- ◀ Check the following network settings for the projector.
 - IP Address
Check that the IP address for the projector is not duplicated on the network.
 - Subnet Mask
When the gateway setting for the projector is "0.0.0.0" (Not Used), or the gateway setting for the projector and the default gateway setting for the computer are the same:
 - The subnet masks for the projector and the computer should be the same.
 - The IP address parts shown by the subnet mask for the projector and the computer should be the same.
(Example)
When the IP address is "192.168.150.2" and the subnet mask is "255.255.255.0" for the projector, the IP address for the computer should be "192.168.150.X" (X=3-254) and the subnet mask should be "255.255.255.0".
 - Gateway
When the gateway setting for the projector is "0.0.0.0" (Not Used), or the gateway setting for the projector and the default gateway setting for the computer are the same:
 - The subnets for the projector and the computer should be the same.
 - The IP address parts shown by the subnet mask for the projector and the computer should be the same.
(Example)
When the IP address is "192.168.150.2" and the subnet mask is "255.255.255.0" for the projector, the IP address for the computer should be "192.168.150.X" (X=3-254) and the subnet mask should be "255.255.255.0".
 - Data Port
Other computers should not use the data port of the projector.
The data port should be used for communication during the stack projection.

Note

- The factory default setting of the network setting for the projector
IP address : 192.168.150.2
Subnet mask : 255.255.255.0
Gateway address : 0.0.0.0 (Not Used)
- For network settings for the projector, refer to page 21.

- ◀ Take the following steps for checking the network settings for the computer.
 1. Open a command prompt (MS-DOS Prompt).
 - In the case of Windows® 98 or 98SE: click “start” → “Programs” → “MS-DOS Prompt” in order.
 - In the case of Windows® Me: click “start” → “Programs” → “Accessories” → “MS-DOS Prompt” in order.
 - In the case of Windows® 2000: click “start” → “Programs” → “Accessories” → “Command Prompt” in order.
 - In the case of Windows® XP: click “start” → “All Programs” → “Accessories” → “Command Prompt” in order.
 2. After launching the command prompt (MS-DOS Prompt), enter the command “ipconfig”, and press the “Enter” key.

Note

- Communication may not be established even after carrying out the network settings for the computer. In such cases, restart your computer.

C:\>ipconfig

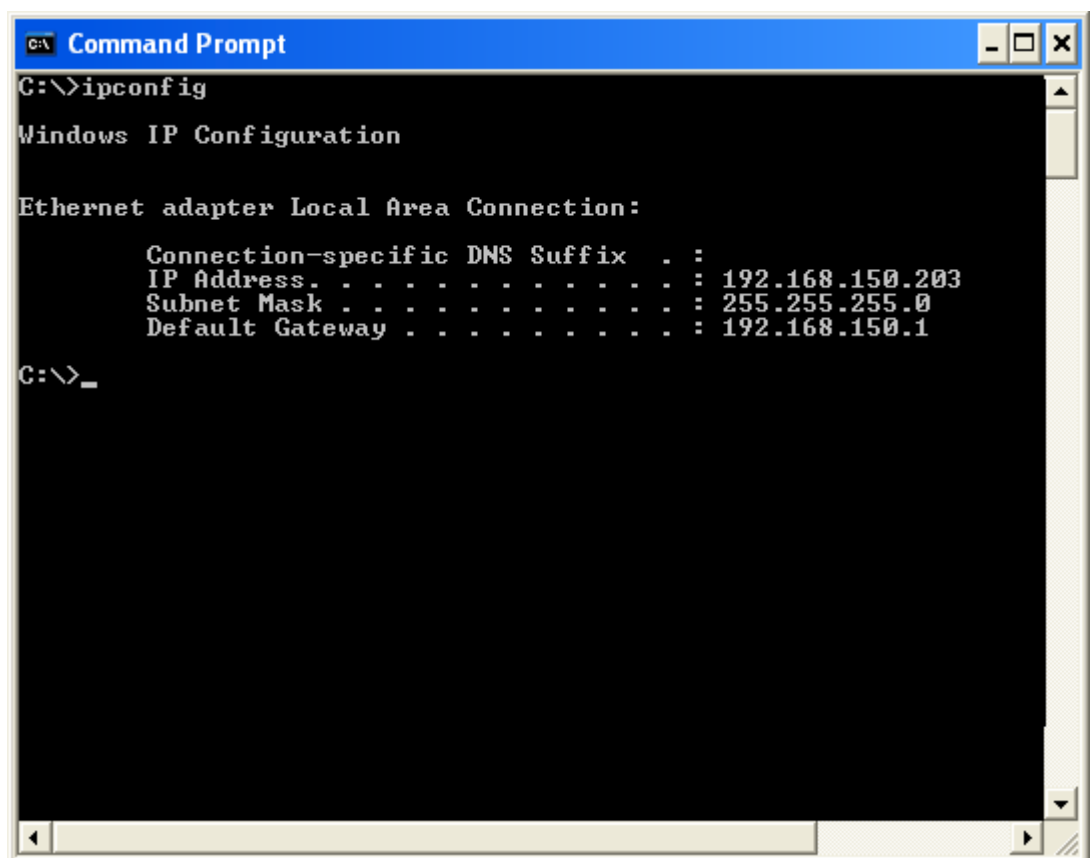

```
C:\>ipconfig

Windows IP Configuration

Ethernet adapter Local Area Connection:

    Connection-specific DNS Suffix  . : 
    IP Address. . . . .               : 192.168.150.203
    Subnet Mask . . . . .             : 255.255.255.0
    Default Gateway . . . . .         : 192.168.150.1

C:\>_
```

Note

- Usage examples of ipconfig
 - C:\>ipconfig /? displays how to use “ipconfig.exe”.
 - C:\>ipconfig displays the set IP address, subnet mask and default gateway.
 - C:\>ipconfig /all displays all the setting information related to TCP/IP.

3. To return to the Windows® screen, enter “exit” and press the “Enter” key.

Troubleshooting

- ◀ Check if the “TCP/IP” protocol is operating correctly using the “PING” command. Also, check if an IP address is set.
 1. Open a command prompt (MS-DOS Prompt).
 - In the case of Windows® 98 or 98SE: click “start” → “Programs” → “MS-DOS Prompt” in order.
 - In the case of Windows® Me: click “start” → “Programs” → “Accessories” → “MS-DOS Prompt” in order.
 - In the case of Windows® 2000: click “start” → “Programs” → “Accessories” → “Command Prompt” in order.
 - In case of Windows® XP: click “start” → “All Programs” → “Accessories” → “Command Prompt” in order.
 2. After launching the command prompt (MS-DOS Prompt) enter a command “PING”.
Entry example C:\>Ping XXX.XXX.XXX.XXX
“XXX.XXX.XXX.XXX” should be entered with an IP address to be connected to, such as the projector.
 3. When connecting normally, the display will be as follows.
(The screen may be slightly different depending on the OS type.)
<Example> when the IP address connected to is “192.168.150.2”

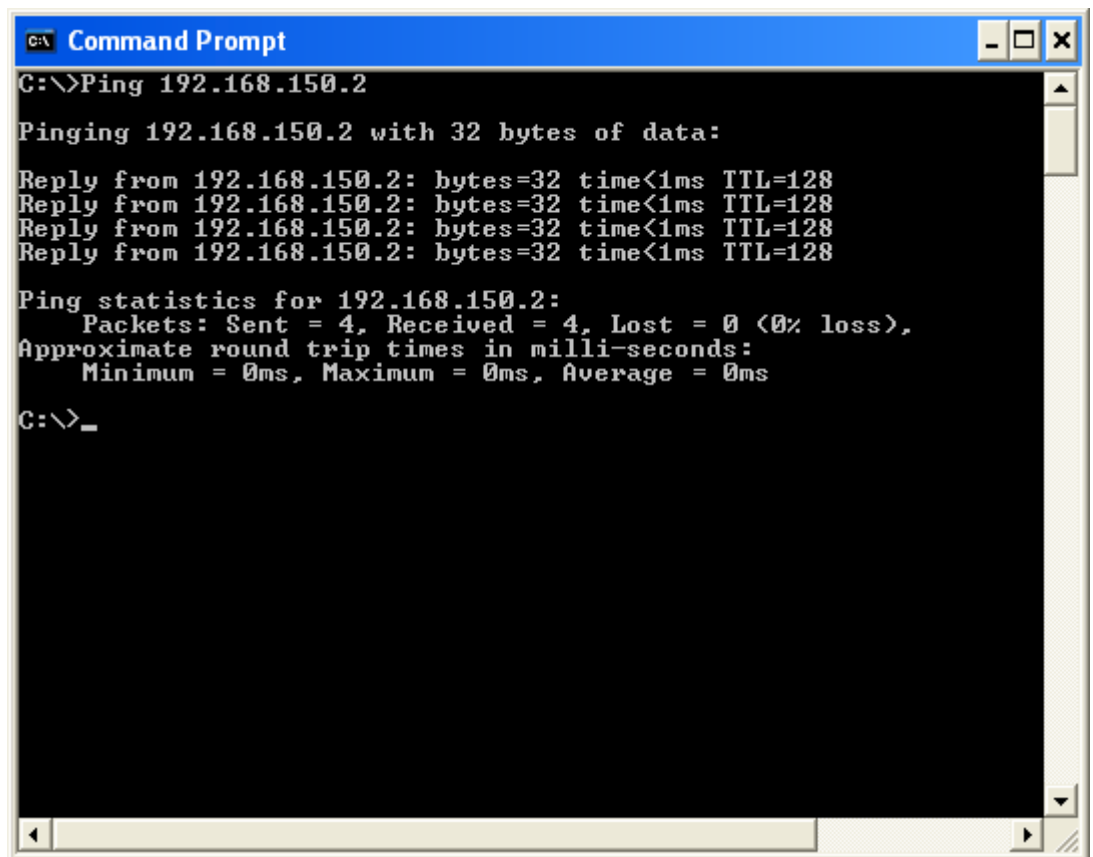

```
C:\> Ping 192.168.150.2

Pinging 192.168.150.2 with 32 bytes of data:

Reply from 192.168.150.2: bytes=32 time<1ms TTL=128
Reply from 192.168.150.2: bytes=32 time<1ms TTL=128
Reply from 192.168.150.2: bytes=32 time<1ms TTL=128
Reply from 192.168.150.2: bytes=32 time<1ms TTL=128

Ping statistics for 192.168.150.2:
    Packets: Sent = 4, Received = 4, Lost = 0 (0% loss),
    Approximate round trip times in milli-seconds:
        Minimum = 0ms, Maximum = 0ms, Average = 0ms

C:\>_
```

4. When a command cannot be sent, “Request time out” will be displayed.
Check the network setting again.
If communication can still not be established properly, contact your network administrator.
5. To return to the Windows® screen, enter “exit” and then press the “Enter” key.

A connection cannot be made because you have forgotten your user name or your password.

- ◀ Initialize the settings. (See page 88 on the owner's manual of the projector.)
- ◀ After the initialization, carry out setting again.

Dimensions

Units: inches (mm)

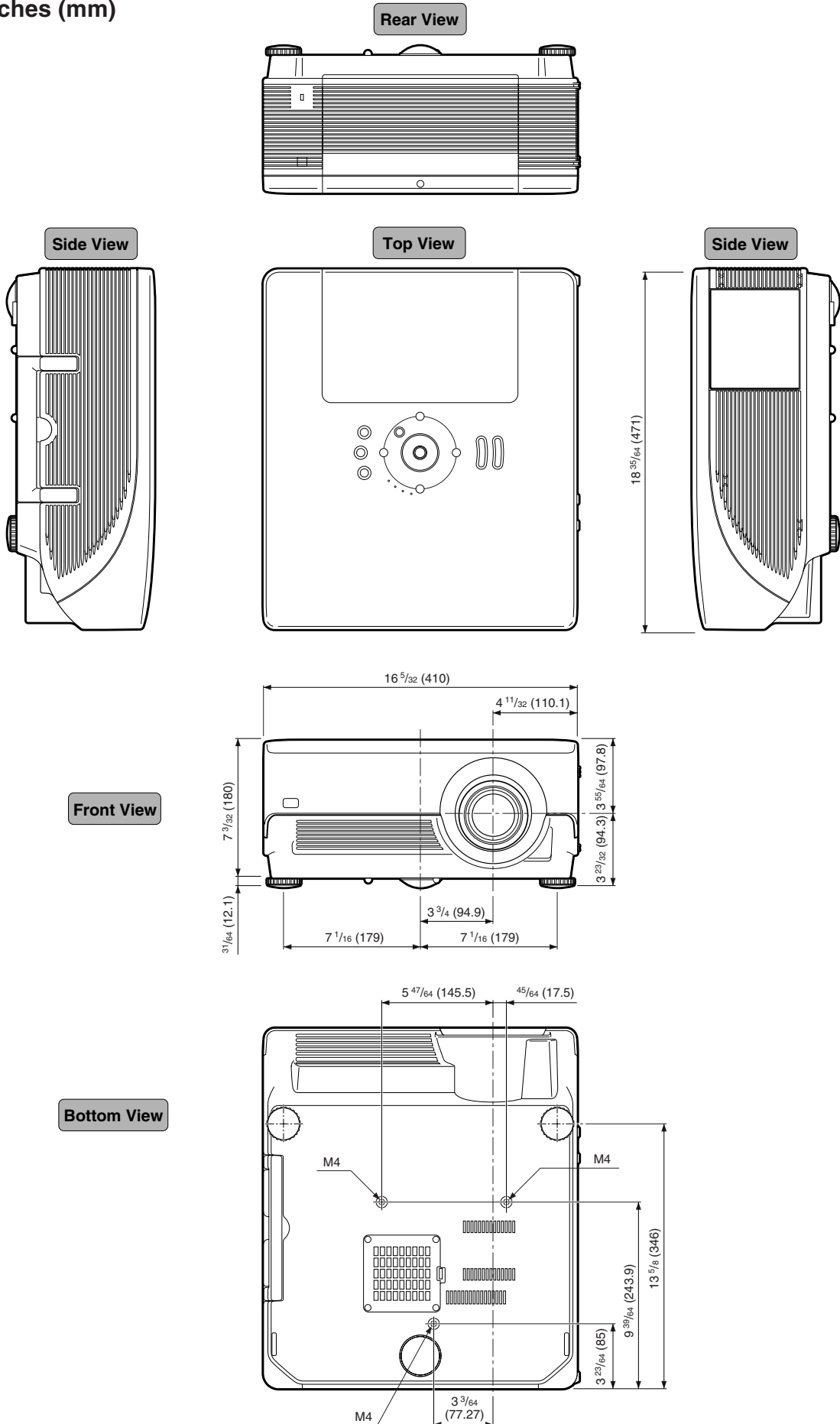

EIKI