

Triacs

Silicon Bidirectional Triode Thyristors

... designed primarily for full-wave ac control applications, such as solid-state relays, motor controls, heating controls and power supplies; or wherever full-wave silicon gate controlled solid-state devices are needed. Triac type thyristors switch from a blocking to a conducting state for either polarity of applied anode voltage with positive or negative gate triggering.

- Blocking Voltage to 800 Volts
- All Diffused and Glass Passivated Junctions for Greater Parameter Uniformity and Stability
- Small, Rugged, Thermowatt Construction for Low Thermal Resistance, High Heat Dissipation and Durability
- Gate Triggering Guaranteed in Three Modes (MAC15 Series) or Four Modes (MAC15A Series)

MAC15 Series
MAC15A Series

TRIACs
15 AMPERES RMS
200 thru 800 VOLTS

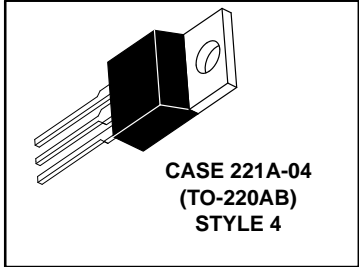
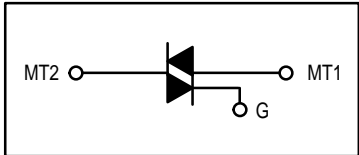

MAXIMUM RATINGS ($T_J = 25^\circ\text{C}$ unless otherwise noted.)

Rating	Symbol	Value	Unit
Peak Repetitive Off-State Voltage ⁽¹⁾ (Gate Open, $T_J = -40$ to $+125^\circ\text{C}$)	V_{DRM}	200 400 600 800	Volts
Peak Gate Voltage	V_{GM}	10	Volts
On-State Current RMS Full Cycle Sine Wave 50 to 60 Hz ($T_C = +90^\circ\text{C}$)	$I_T(\text{RMS})$	15	Amps
Circuit Fusing ($t = 8.3$ ms)	I^2t	93	A^2s
Peak Surge Current (One Full Cycle, 60 Hz, $T_C = +80^\circ\text{C}$) Preceded and followed by rated current	I_{TSM}	150	Amps
Peak Gate Power ($T_C = +80^\circ\text{C}$, Pulse Width = 2 μs)	P_{GM}	20	Watts
Average Gate Power ($T_C = +80^\circ\text{C}$, $t = 8.3$ ms)	$P_{G(AV)}$	0.5	Watt
Peak Gate Current	I_{GM}	2	Amps
Operating Junction Temperature Range	T_J	-40 to +125	$^\circ\text{C}$
Storage Temperature Range	T_{stg}	-40 to +150	$^\circ\text{C}$

THERMAL CHARACTERISTICS

Characteristic	Symbol	Max	Unit
Thermal Resistance, Junction to Case	$R_{\theta JC}$	2	$^\circ\text{C}/\text{W}$

1. V_{DRM} for all types can be applied on a continuous basis. Blocking voltages shall not be tested with a constant current source such that the voltage ratings of the devices are exceeded.

MAC15 Series MAC15A Series

ELECTRICAL CHARACTERISTICS ($T_C = 25^\circ\text{C}$, and either polarity of MT2 to MT1 Voltage, unless otherwise noted.)

Characteristic	Symbol	Min	Typ	Max	Unit
Peak Blocking Current ($V_D = \text{Rated } V_{DRM}$, Gate Open) $T_J = 25^\circ\text{C}$ $T_J = 125^\circ\text{C}$	I_{DRM}	— —	— —	10 2	μA mA
Peak On-State Voltage ($I_{TM} = 21 \text{ A Peak}$; Pulse Width = 1 or 2 ms, Duty Cycle $\leq 2\%$)	V_{TM}	—	1.3	1.6	Volts
Gate Trigger Current (Continuous dc) ($V_D = 12 \text{ Vdc}$, $R_L = 100 \text{ Ohms}$) MT2(+), G(+) MT2(+), G(-) MT2(-), G(-) MT2(-), G(+) "A" SUFFIX ONLY	I_{GT}	— — — —	— — — —	50 50 50 75	mA
Gate Trigger Voltage (Continuous dc) ($V_D = 12 \text{ Vdc}$, $R_L = 100 \text{ Ohms}$) MT2(+), G(+) MT2(+), G(-) MT2(-), G(-) MT2(-), G(+) "A" SUFFIX ONLY ($V_D = \text{Rated } V_{DRM}$, $R_L = 10 \text{ k Ohms}$, $T_J = 110^\circ\text{C}$) MT2(+), G(+); MT2(-), G(-); MT2(+), G(-) MT2(-), G(+) "A" SUFFIX ONLY	V_{GT}	— — — — 0.2 0.2	0.9 0.9 1.1 1.4 — —	2 2 2 2.5 — —	Volts
Holding Current (Either Direction) ($V_D = 12 \text{ Vdc}$, Gate Open) ($I_T = 200 \text{ mA}$)	I_H	—	6	40	mA
Turn-On Time ($V_D = \text{Rated } V_{DRM}$, $I_{TM} = 17 \text{ A}$) ($I_{GT} = 120 \text{ mA}$, Rise Time = $0.1 \mu\text{s}$, Pulse Width = $2 \mu\text{s}$)	t_{gt}	—	1.5	—	μs
Critical Rate of Rise of Commutation Voltage ($V_D = \text{Rated } V_{DRM}$, $I_{TM} = 21 \text{ A}$, Commutating $di/dt = 7.6 \text{ A/ms}$, Gate Unenergized, $T_C = 80^\circ\text{C}$)	$dv/dt(c)$	—	5	—	$\text{V}/\mu\text{s}$

FIGURE 1 – RMS CURRENT DERATING

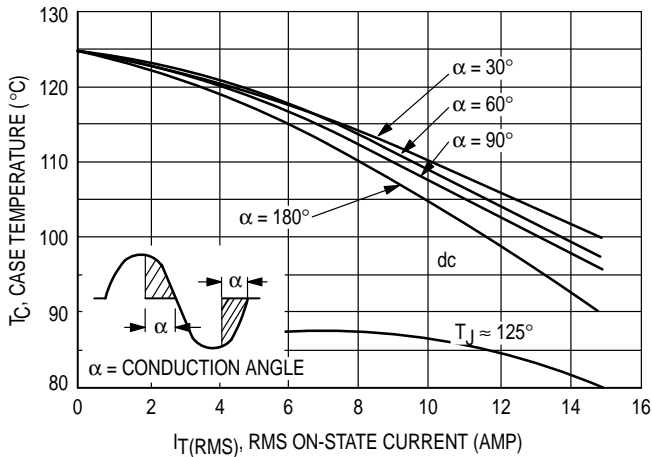

FIGURE 2 – ON-STATE POWER DISSIPATION

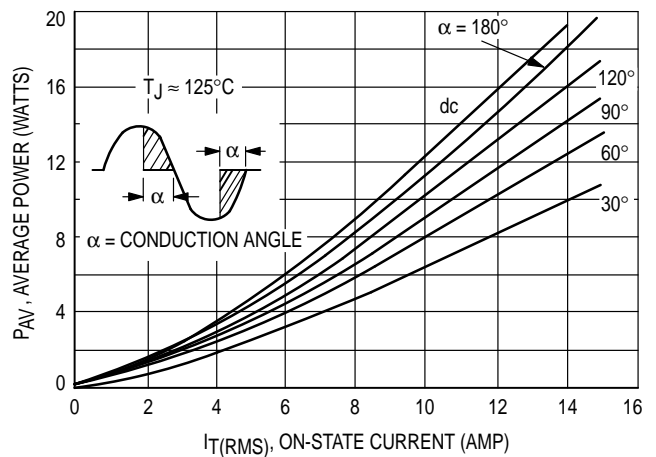

FIGURE 3 – TYPICAL GATE TRIGGER VOLTAGE

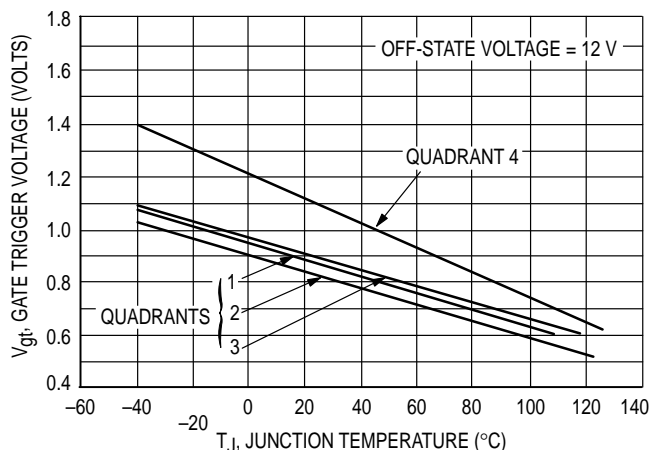

FIGURE 4 – TYPICAL GATE TRIGGER CURRENT

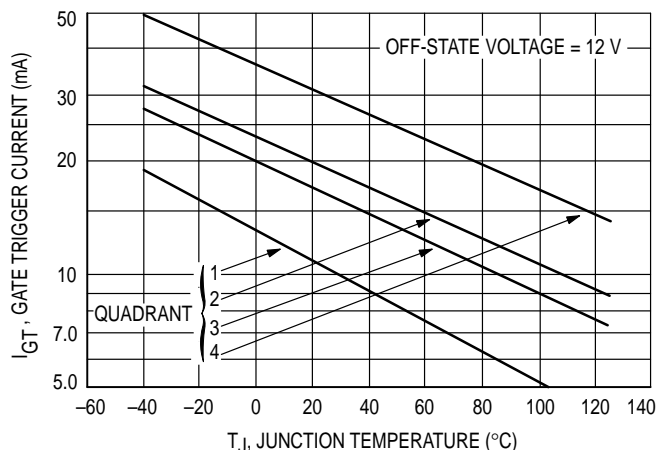

FIGURE 5 – ON-STATE CHARACTERISTICS

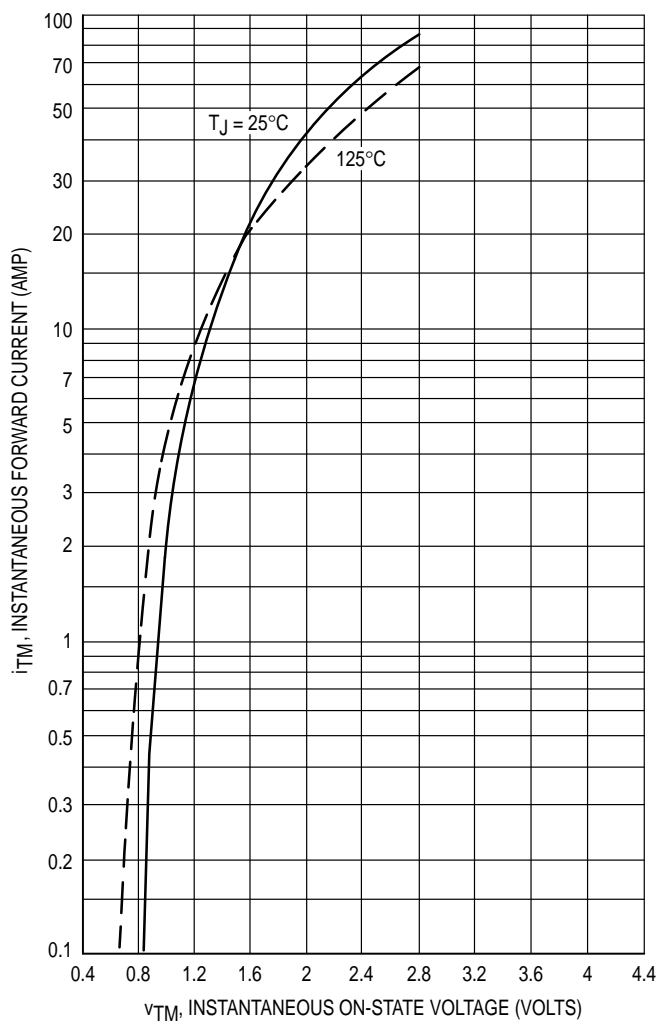

FIGURE 6 – TYPICAL HOLDING CURRENT

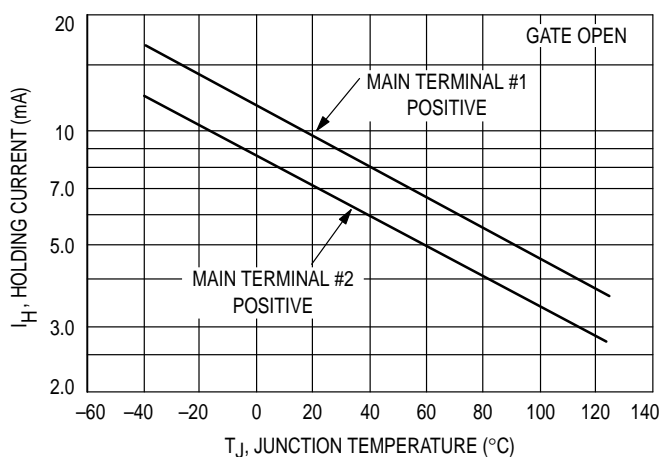

FIGURE 7 – MAXIMUM NON-REPETITIVE SURGE CURRENT

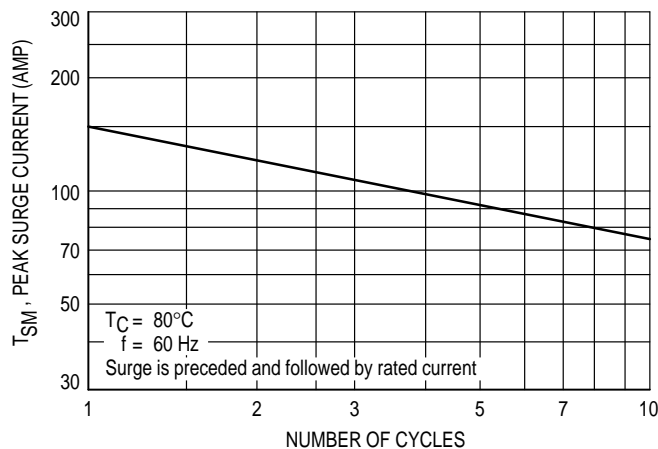

FIGURE 8 – THERMAL RESPONSE

