

Philips FunCam

Instructions for use



PHILIPS

Philips FunCam

DMVC 300K

The Philips FunCam DMVC 300K you have just purchased is manufactured to the highest standards and will give you years of trouble-free use. This new digital camera is the most advanced means of recording high quality movies or still photos quickly and easily on your PC or laptop computer. After installation the camera can be used as a:

- PC camera for video chat and video mail;
- digital camera for taking high quality photos;
- video camera for capturing video clips.

Please read the following instructions carefully. They provide a step-by-step description of the installation process and explain how to use the Philips FunCam.

Contents

Introduction	2
1. Things you should know	5-6
Safety precautions.....	5
Copyright.....	5
Pack contents.....	6
2. Quick start	7-10
3. Functional overview	11-12
4. Installation	13-17
Installing the camera software.....	13-14
Connecting the camera to your PC.....	15
Selecting the required frequency.....	15
Selecting low resolution mode.....	16
Connecting the neck strap / belt clip.....	16
Recharging the battery.....	17
5. Operating the camera	18-23
Turning the camera on and off.....	18
Taking photos.....	18
Setting the self-timer.....	19
Taking three photos in a row.....	19-20
Making a video recording.....	20
Clearing photos and video recordings.....	20-21
Transferring/viewing photos and video clips to your PC.....	22-23
Using the camera as a PC-camera (webcam).....	23
6. Using the applications	24-28
Philips V Lounge.....	24
Video Chat.....	25-26
Microsoft® Netmeeting.....	25-26
Microsoft® MSN Messenger and Yahoo!® Messenger.....	26
Image.....	26-27
Philips Photo Manager.....	26-27
Video.....	27-28
Philips V Record.....	27-28
7. Problem solving	29
8. Technical specifications	30

9. Important information.....31-32
Disclaimer.....31
FCC compliance.....31
End of life directives.....32
System requirement.....32
Disclaimer of warranty.....32
Limitation of damages.....32

10. Helpline.....33

11. Warranty.....34

1. Things you should know

- Please read the following instructions carefully, and retain them for future reference.
- It may be helpful to have the instructions for use for the PC at hand for reference.

Safety precautions

Observe the following guidelines to ensure that the camera will operate safely and to prevent defects.

- Do not use your camera in environments outside the following range: temperature: 0°C to 40°C, relative humidity: 45% ~ 85%.
- Do not use or store your camera in/under:
 - direct sunlight exposure;
 - very humid and dusty environment;
 - near any kind of heat sources;
- If your camera gets wet, dry it with soft cloth as soon as possible.
- Salt seawater may cause severe camera damage.
- If the lens or viewfinder is dirty, please use the lens brush or soft cloth to clean the lens. Do NOT touch the lens with your fingers.
- Clean the outside of the camera with a soft cloth.
- Do NOT use cleaning fluids based on alcohol, methylated spirit, ammonia, etc.
- Do NOT attempt to disassemble or repair your camera by yourself. Do not open the camera. In the event of technical difficulties return it to your Philips retailer.
- Do NOT use your camera outdoors when it is raining or snowing.
- Do NOT use your camera in the water.
- Protect the camera from oil, vapour, steam, moisture, and dust.
- Never point the camera lens at the sun.

Copyright

Copyright© 2003 by Philips Consumer Electronics B.V. All rights reserved. No part of this publication may be reproduced, transmitted, transcribed, stored in a retrieval system or translated into any language or computer language, in any form or by any means, electronic, mechanical, magnetic, optical, chemical, manual or otherwise, without prior written permission from Philips. Brands and product names are trademarks or registered trademarks of their respective companies.

Pack contents

Please check that the following items are packed in the Philips FunCam box. They are provided to help you set up and use your Philips FunCam.

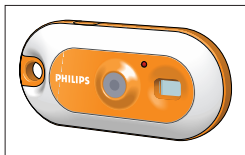

The Philips FunCam DMVC 300K

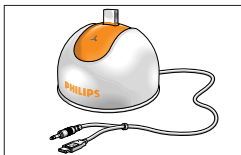

Desktop stand with USB/microphone cable attached



CD-ROM containing the Philips installation software, application software and manual

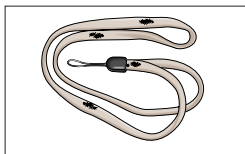

Neckstrap

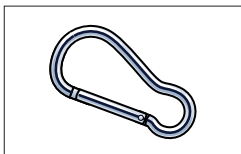

Beltclip



Quick Installation Guide

2. Quick start

Installation

- 1 Unplug all your USB devices (except USB keyboard and USB mouse).
- 2 Place the installation CD-ROM in your computer's CD-ROM-/DVD drive.

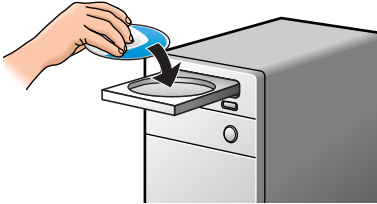

- 3 Select your language.



- 4 Select at least 'FunCam drivers' and 'Philips Photo Manager'.

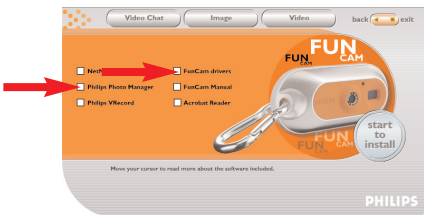

- 5 Click 'Start to install' to start installation.



Note! If the 'Language Selection' screen does not appear automatically, open Windows Explorer and double-click the 'Autorun.exe' icon in the CD-ROM directory.

Charging

- 1 Turn on the PC.
- 2 Be sure to run the installation CD-ROM *first*, before connecting the camera to the PC.
- 3 Connect the USB plug of the USB/Microphone cable to the USB port of the PC.
- 4 Place the camera's USB connector on the USB connector in the desktop stand. Push it down gently until it clicks in position.

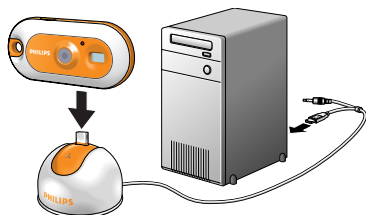

- > You will hear a beeping sound, the display lights up blue and the Charge LED lights up red.
- > (P/L) appears on the display. The battery will now be charged.

Taking photos

- 1 Press and hold the Mode button for 2 seconds to turn on the camera.

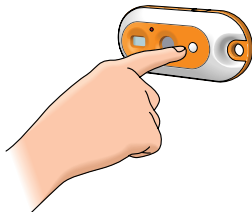

- 2 Frame the subject through the viewfinder.

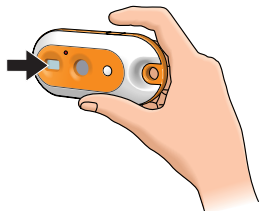

- 3 Press the Shutter button.

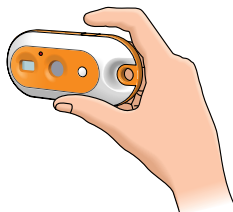

- > You will hear a beep twice when the photo is taken.

Transferring photos/video clips to your PC

- 1 Make sure the PC is turned on and that 'FunCam drivers' and 'Philips Photo Manager' are installed.
- 2 Connect the desktop stand to the PC:
 - Connect the USB plug of the USB/microphone cable to the USB port of the PC.
- 3 Place the camera's USB connector on the USB connector in the desktop stand. Push it down gently until it clicks in position.

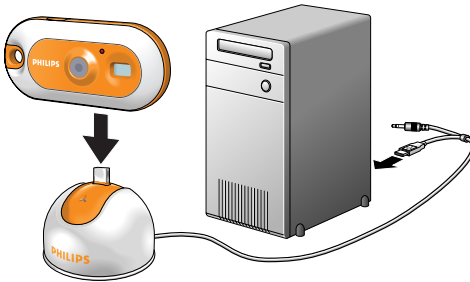

- > You will hear a beeping sound, the display lights up blue and the Charge LED lights up red.
- > The camera turns on automatically and  appears on the display.
- > The following screen will appear:

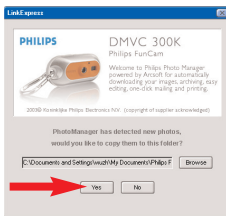

- 4 If you wish to start transferring press 'YES'

> The following screen will appear:

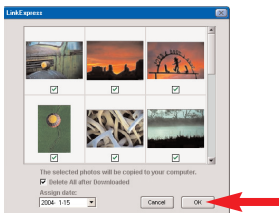

- 5 Select the photos you wish to transfer and press 'OK'

> If the transfer is complete the following screen will appear:

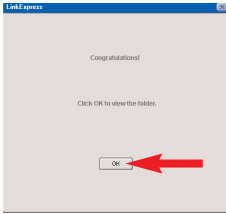

Notes!

- If the 'Philips FunCam' screen does not appear, you can start 'Philips Photo Manager' and click on the 'Get Photo' icon. Select your camera (Philips FunCam) to start the transfer.
- For more information on transferring/viewing photos and video clips see chapter 'Transferring photos/video clips to your PC' under '5. Operating the camera'

3. Functional overview

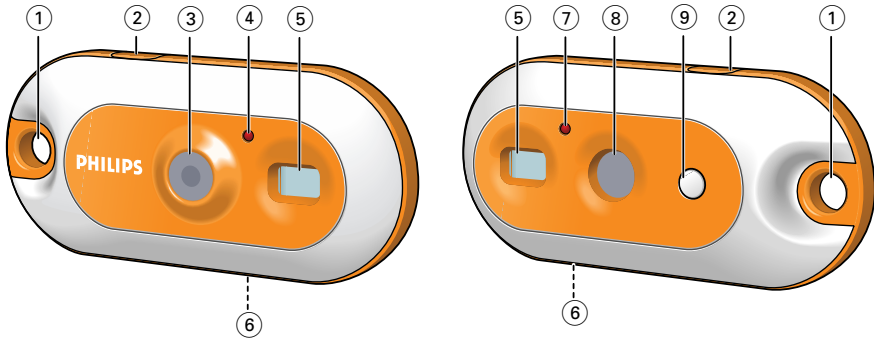

- 1 Strap hole**
for connecting neck strap or belt clip
- 2 Shutter button**
for taking photos and making video recordings
- 3 Lens**
- 4 Timer LED**
blinks red for 10 seconds when the self-timer has been set
- 5 Viewfinder**
for framing your photo subject
- 6 USB port**
for connecting the camera to the USB connector of the desktop stand
- 7 Charge LED**
blinks red when the battery is being recharged
- 8 Display**
 - lights up blue when the camera is turned on
 - informs you about the present status of the camera:

<i>00</i>	number of photos currently taken (capture mode)
<i>5t</i>	self-timer mode
<i>35</i>	three pictures continuous mode
<i>H/L</i>	high/low-resolution mode or battery low
<i>CS</i>	continuous snap mode (video recording)
<i>50/150</i>	frequency selection mode
<i>CL</i>	clear last picture mode
<i>CA</i>	clear all pictures mode
<i>PC</i>	PC camera mode
<i>FU</i>	memory full. (No more photos can be taken.)
<i>On</i>	power on

- 9 Mode button**
 - for turning the camera on and off
 - for changing camera settings

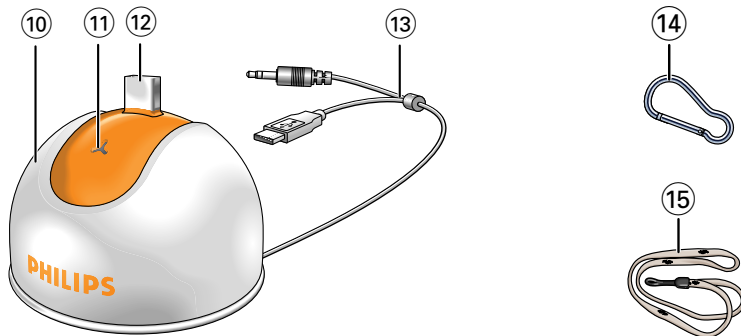

10 Desktop stand

for placing the camera in when:

- (re-)charging the battery
- using the camera as a PC-camera
- transferring/viewing photos and video clips

11 Microphone

12 USB connector

for connecting to the camera's USB port

13 USB/microphone cable

- for connecting to the USB port of the PC
- for connecting to the audio input of the PC

14 Belt clip

15 Neck strap

4. Installation

Installing the camera software

The software supplied only works on PCs with the operating systems Microsoft® Windows® 98SE, ME, 2000 and XP.

Notes!

- Unplug all your USB devices (except USB keyboard and USB mouse) before you start.
- Do not plug in your USB camera yet. Run the Installation CD-ROM first.
- Have your Windows® CD-ROM at hand.

- 1 Insert the installation CD-ROM supplied into the PC's CD-ROM-/DVD drive.
> The 'Language Selection' screen will appear automatically.



- 2 Select your language.

Note! If the 'Language Selection' screen does not appear automatically, open Windows Explorer and double-click the 'Autorun.exe' icon in the CD-ROM directory.

> The software installation screen will now appear.

- 3 Select at least 'FunCam drivers' and 'Philips Photo Manager'.



There are three clusters of application software to install:

- software for video chat (Video Conference);
- software for image applications (Image);
- software for video applications (Video).

> If you move your cursor onto a button or application name, you will see a brief introduction at the bottom of the menu.

- You can add the additional software by selecting the box in front of the software name: Windows® NetMeeting, Philips Photo Manager, Philips VRecord, Acrobat Reader.

4 Click 'Start to install' to start installation.



Note! If your Operating System is Windows XP, continue the installation process when the dialog box below appears on the screen. (In Windows 2000/NT, the same dialog box may also appear. You may then continue the installation process.)

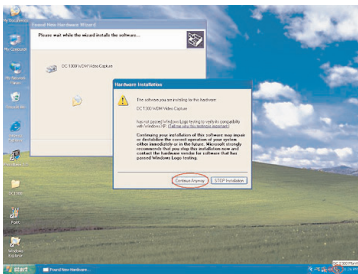

5 Follow the instructions on the screen to complete the installation.

6 Restart your computer when you have finished installing all of the above software.

> The V(ideo)-Lounge desktop shortcut  will be installed after installation.

> Via V Lounge you have access to all camera-related software.

Also see 'Using the applications'.

7 Double click on the icon to initiate the V Lounge application.

> The V Lounge application will now be initiated and the V Lounge selection screen appears.



Connecting the camera to your PC

- 1 Be sure to run the installation CD *first, before* connecting the camera to the PC.
- 2 Turn on the PC.
- 3 Connect the desktop stand to the PC:
 - Connect the USB plug of the USB/Microphone cable to the USB port of the PC.
 - Connect the 3.5 mm jack plug the USB/Microphone cable to the audio input of the PC.
- 4 Place the camera's USB connector on the USB connector in the desktop stand. Push it down gently until it clicks into position.

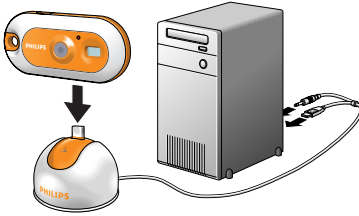

- > You will hear a beeping sound, the display lights up blue and the Charge LED lights up red.
- > The camera turns on automatically and **PL** appears on the display .
- > The camera will now derive its power from the PC.

Selecting the required frequency

Default frequency setting is **50** .

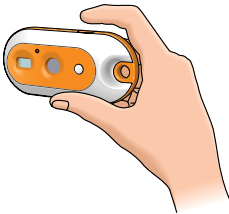

- 1 Press the Mode button until the currently selected frequency range appears on the display: **50** (Europe) or **60** (U.S.A).
- 2 Press the Shutter button if you wish to change the frequency.



- > You will hear a beep. The frequency setting has now been changed.

Selecting low resolution mode

Default setting is VGA (high resolution mode). In  mode, the camera will take CIF (320x240) size photos.

- 1 Press the Mode button until the currently selected resolution mode appears on the display:  or .
- 2 Press the Shutter button if you wish to change the resolution mode.

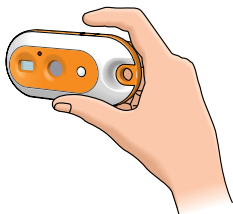

> You will hear a beep. The resolution mode has now been changed.

Connecting the neck strap / belt clip

- Thread the neck strap through the strap hole as indicated below.

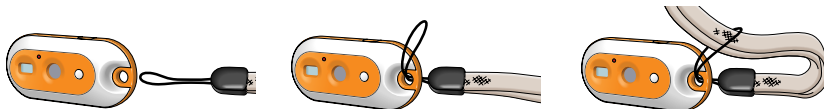

- Press the beltclip open and slide it through the strap hole as indicated below.

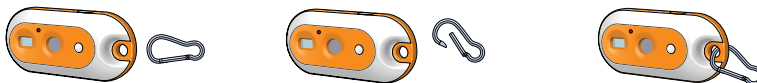

Recharging the battery

- 1 Make sure the camera is turned off.
- 2 Turn on the PC.
- 3 Connect the USB plug of the USB/Microphone cable to the USB port of the PC.
- 4 Place the camera's USB connector on the USB connector in the desktop stand. Push it down gently until it clicks into position.

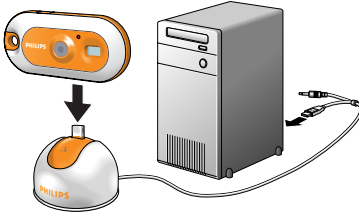

- > You will hear a beeping sound, the display lights up blue and the Charge LED lights up red. The battery will now be recharged.
- > It will take four hours to fully recharge the battery. When the battery is fully recharged the Charge LED will go out.

Notes!

- Charge the camera in time! When the battery is empty all photos in the camera memory will be lost.
- When the battery is almost empty, the camera starts beeping and  appears on the display.

5. Operating the camera

Turning the camera On and Off

- Press and hold the Mode button for two seconds to turn on the camera.

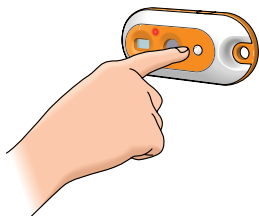

- > You will hear a beeping sound, the display lights up blue and the Charge LED lights up red.
- > 00 appears briefly on the display, followed by the number of photos currently taken 00 .
- Press and hold the Mode button again for two seconds to turn off the camera.
 - > When no buttons are pressed for 60 seconds, the display goes blank, you will hear a beeping sound and the camera will turn off automatically.

Taking photos

- 1 Make sure the camera is turned on.
- 2 Look through the viewfinder to frame the object you wish to take a photo of.

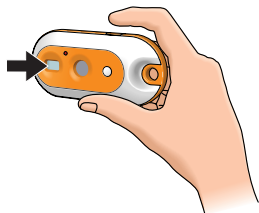

- 3 Press the Shutter button.

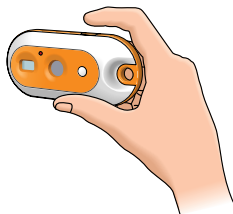

> You will hear a beep twice when the photo was taken successfully.

Setting the self-timer

- 1 Make sure the camera is turned on.
- 2 Press the Mode button until  appears on the display.

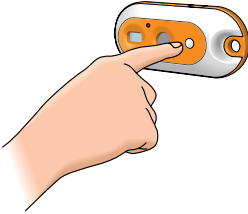

- 3 Press the Shutter button to enter Self-timer mode.

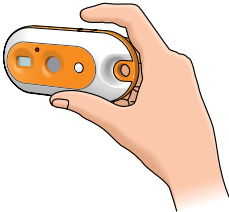

- 4 Press the Shutter button again, *within five seconds*.
 - > You will hear a beep twice.
 - > The Timer LED starts blinking red and you will hear a beep every second.
 - > After 10 seconds the camera will automatically take a photo.

Taking three photos in a row (Three photos continuous mode)

- 1 Make sure the camera is turned on.
- 2 Press the Mode button until  appears on the display.

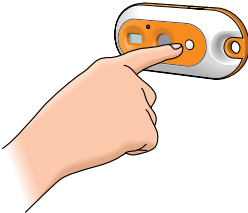

- 3 Press the Shutter button to enter Three photos continuous mode mode.

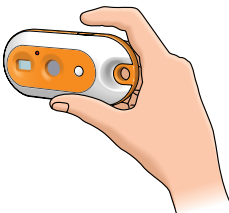

- 4 Press the Shutter button *within five seconds*.
 - > The camera will automatically take three photos in a row.
 - > You will hear a beep each time a photo is taken.

Making a video recording (Continuous Snap mode)

- 1 Make sure the camera is turned on.
- 2 Press the Mode button until  appears on the display.

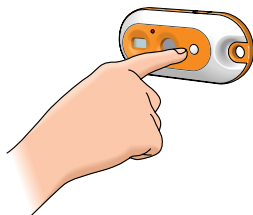

- 3 Press the Shutter button *within 5 seconds* to start video recording.
Keep the Shutter button pressed for as long as you wish the recording to last (maximum recording time is 35 seconds).

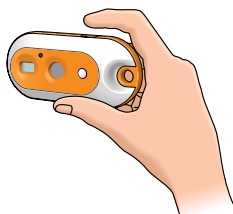

> When the Shutter button is released, recording will stop and Continuous Snap mode is disabled.

Clearing photos and video recordings

Clearing the last stored photo/video recording

- 1 Make sure the camera is turned on.
- 2 Press the Mode button until  appears on the display.

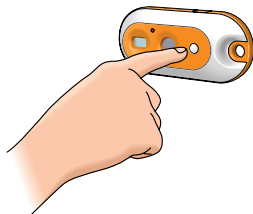

- 3** Press the Shutter button to enter Clear Last mode.

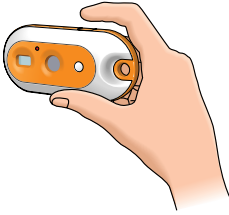

> You will hear a beep. The camera is now in Clear Last mode.

- 4** Press the Shutter button again *within five seconds* to confirm that you wish to clear the last stored photo/video recording.

> You will hear a beep when the last stored photo/video recording has been cleared from the memory.

Clearing all photos/video recordings

- 1** Press the Mode button until  appears on the display.

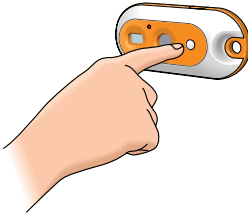

- 2** Press the Shutter button to enter Clear All mode.

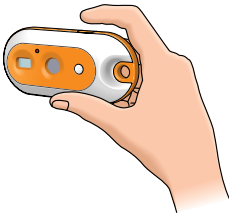

> You will hear an alarm sound, notifying you that the camera is in Clear All mode and that all Photos/video recordings will be cleared.

- 3** Press the Shutter button again *within five seconds* to confirm that you wish to clear all photos/video recordings from the memory.

> You will hear a beep when all photos/video recordings have been cleared from the memory.

Transferring photos/video clips to your PC

- 1 Make sure the PC is turned on and that 'Philips FunCam drivers' and 'Philips Photo Manager' are installed.
- 2 Connect the desktop stand to the PC:
 - Connect the USB plug of the USB/Microphone cable to the USB port of the PC.
- 3 Place the camera's USB connector on the USB connector in the desktop stand. Push it down gently until it clicks into position.

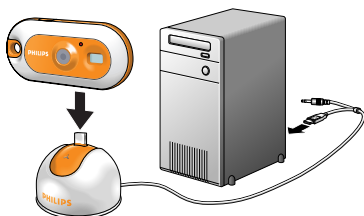

- > You will hear a beeping sound and the Power LED lights up blue.
- > The camera turns on automatically and  appears on the display.
- > The following screen will appear:

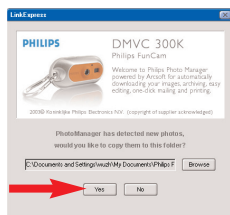

- 4 If you wish to start transferring press 'YES'
 - > The following screen will appear:

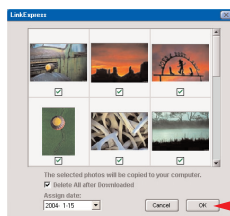

- 5 Select the photos you wish to transfer and press 'OK'

> If the transfer is complete the following screen will appear:

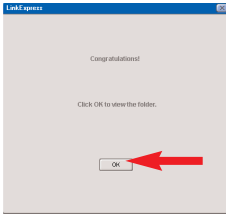

Note! If the 'Philips FunCam' screen does not appear you can start 'Philips Photo Manager' and click on the 'Get Photo' icon. Select your camera (Philips FunCam) to start the transfer.

Using the camera as PC-camera (webcam)

1 Be sure to run the installation CD *first*, before connecting the camera to the PC.

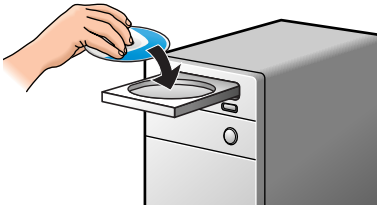

2 Turn on the PC.

3 Connect the desktop stand to the PC:

- Connect the USB plug of the USB/Microphone cable to the USB port of the PC.
- Connect the 3.5 mm jack plug the USB/Microphone cable to the audio input of the PC.

4 Place the camera's USB connector on the USB connector in the desktop stand. Push it down gently until it clicks into position.

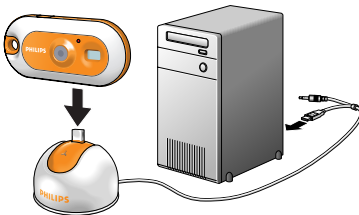

> You will hear a beeping sound and the Power LED lights up blue.

>  appears on the display and the camera turns on automatically.

> The camera can now be used as a PC-camera (webcam) and photos and video clips can be transferred to the PC.

See chapters 'Transferring/viewing photos and video clips', 'NetMeeting' and 'Philips VRecord'.

Note! The Philips FunCam works with Microsoft® MSN Messenger and Yahoo!® Messenger.

6. Using the applications

Philips VLounge

Note! Make sure your PC runs on Microsoft® Windows® 98SE, ME, 2000 or XP and that you have run the Philips FunCam Installation CD-ROM on your PC.

All applications can be accessed via the PhilipsV(ideo)-Lounge application. VLounge is the central application for easy access to your Philips FunCam and all image and video applications installed during setup. You can start VLounge through the Windows QuickLaunch menu in your taskbar, via the program group 'Philips FunCam', or by clicking the VLounge icon  on the desktop. VLounge gives you access to the following Applications (if installed):

- 1 Image - Philips Photo Manager
 - 2 Video - Philips VRecord
 - 3 Video Chat - Windows® NetMeeting
 - Links to Microsoft® MSN Messenger and Yahoo!® Messenger downloads.
- **Move the cursor over the buttons in the screen below to find out more about the specific functions of VLounge.**
 - **Click the buttons to start the applications.**
 - > If a button is greyed out, this means that the application has not been installed. To install the application, see 'Installing the camera software'.



Optional buttons

- 4 FunCam manual

Video Chat

Microsoft® Netmeeting

Microsoft® NetMeeting enables you to communicate with others over the Internet or your local intranet.

To initiate a video chat:

- 1 Start NetMeeting by clicking the NetMeeting button in the V Lounge selection screen.



- 2 Click on 'Help' -> 'About NetMeeting' and find out your local IP address. You can ask your meeting partner to find out his/her IP address in the same way.



- 3 Click the telephone icon.



- 4 In the 'Place A Call' dialogue box, fill in your partner's IP address in 'To:'
- 5 Click on 'Call' and wait for response.

Note! If you or your partner are/is behind a firewall or is using a proxy server (common for office users), please refer to NetMeeting Help about detail solutions.

To respond to an incoming call:

- 1 You can choose 'Automatically Accept Calls' or you can accept manually.
- 2 When the 'Incoming Call' dialogue box appears, click on 'Accept'.

Notes!

- Only two computers in a NetMeeting conference can use audio for communication. All other participants must communicate through other options, like Chat or the shared Whiteboard.
- You can also initiate a video conference with more than one partner. Please read Help in Microsoft® NetMeeting.

Microsoft® MSN Messenger and Yahoo!® Messenger

Philips VLounge contains web links allowing you to download Microsoft® MSN Messenger and Yahoo!® Messenger. These applications enable immediate contact with other persons online. Your messages, as well as the response from the receiving person, will be delivered instantly. Just as if you were having a normal person-to-person conversation. With Microsoft® MSN Messenger and Yahoo!® Messenger you can study online with classmates, play games, work with colleagues, exchange ideas, 'hand over' photos and files, meet new people, surf the web together and much, much more.

- Just click on the desired link and follow the on screen instructions to download and install the applications.



Image

Philips Photo Manager

Philips Photo Manager enables you to transfer, preview, edit, e-mail, print and organise your photos and video recordings.

- 1 Click on the 'Philips Photo Manager' button in the VLounge selection screen.



- 2 If you are using 'Philips Photo Manager' for the first time, click the 'Search' icon in the tool bar if the search for photos and video recordings does not start automatically.
 - > All photos and video clips, located anywhere on your system, will now be searched for.
 - > After the search, all folders containing photos and clips will be shown on your desktop.

- Double-click on a folder to show its content.
- Using the tools in the toolbar you can now edit your photos, create slide shows, add audio, create new albums and much more.
- If you need more information on the possibilities of 'Philips Photo Manager', select 'Help' in the toolbar and then select 'Contents...'.
 - > In the chapters 'Albums/Tree structure', 'Menu commands', 'Tools', 'Editing tools' and 'Advanced features' you will find all the information you need to create customised multimedia collections from files located anywhere on your system.

Video

Philips VRecord

Philips VRecord enables you to record video clips onto your hard disk.

- 1 Click the 'Philips VRecord' button in the 'VLounge selection' screen.

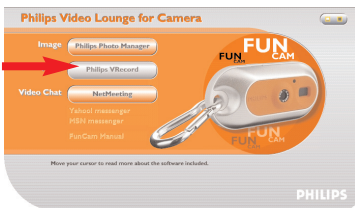

> The 'Philips VRecord' screen appears.

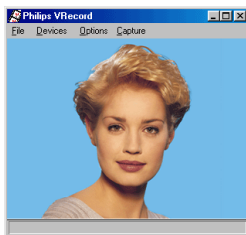

- 2 Select a file name in the File menu using 'Set Capture File'.
- 3 Click 'Devices' to set the video and audio source you want to use.

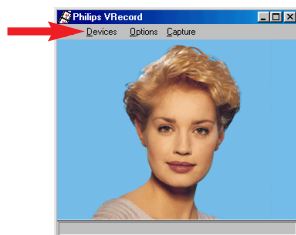

- 4 Enable 'Preview' in the Options menu to see the live Philips USB Web Camera preview, then adjust your audio and video settings if necessary. For instance the 'Frame Rate' setting in the Options - Video Format menu which determines the frame rate the Philips USB Web Camera hardware should deliver to VRecord.

- 5 Use the Capture menu to start or stop capturing a video. Enable 'Capture Audio' if you want to record sound together with the camera photos.(See below for other capture options.)
- 6 You can replay the recording by opening the AVI file you selected for your capture file name in the File - Set Capture File menu. Double click this AVI file in Windows Explorer and Windows Media Player will show you the recording.

Other capture options

The 'Master Stream' option determines the preferred synchronisation between the video stream and the recorded sounds.

- Select 'Audio' if you want to make sure the video rate adapts to the sound recording rate.
- Select 'Video' if you want to make sure the sound recording rate adapts to the video recording rate. If 'None' is enabled, VRecord will adapt both streams to each other whenever necessary.

If 'Use Frame Rate' is enabled in Capture - Set Frame Rate it determines the software frame rate in which VRecord captures the movie independently from the hardware frame rate delivered by the Philips USB Web Camera according to the Frame Rate setting in the Options - VideoFormat menu

7. Problem solving

If a fault occurs, first check the points listed below. If you are unable to remedy a problem by following these hints, contact the helpline (see 'Helpline') or consult your dealer.
Never try to open the camera yourself as this will void the guarantee.

First, check all cables to ensure that they are connected correctly.

Problem	Possible cause / Solution
No photo is taken while the Shutter button is pressed all the way down	<p>Battery exhausted</p> <ul style="list-style-type: none"> • Recharge battery. See 'Recharging the battery.' <p>Memory full</p> <ul style="list-style-type: none"> • Transfer photos/video recordings to your PC or clear photos in order to create memory space. See 'Transferring/viewing photos and video recordings' and/or 'Clearing photos and video recordings'. <p>Camera is still connected to the PC's USB port</p> <ul style="list-style-type: none"> • Disconnect the camera from the PC's USB port or take the camera out of its desktop stand. <p>Poor light conditions</p> <ul style="list-style-type: none"> • Try to improve light conditions. <p>Camera turned off automatically (no button pressed for 60 seconds)</p> <ul style="list-style-type: none"> • Turn the camera back on. See 'Turning the camera on and off'.
No reaction to controls	<p>Battery exhausted</p> <ul style="list-style-type: none"> • Recharge battery. See 'Recharging the battery.'
File transfer not possible	<p>USB cable not properly connected</p> <ul style="list-style-type: none"> • Properly connect USB cable to both desktop stand and PC and make sure the camera is placed on the desktop stand. <p>USB driver not installed</p> <ul style="list-style-type: none"> • Install USB driver and 'Philips Photo Manager' on your PC.
Not all images can be transferred to the PC	<p>The RAM memory installed in your computer may not have sufficient storage space.</p> <ul style="list-style-type: none"> • Close all software programs and proceed to transfer your images. If the problem persists, transfer images in batches and store each batch on your hard drive before proceeding to the next batch. Make sure all the images you want are stored before you clear the camera memory.
Camera connected to PC but the Philips FunCam driver says: 'Device not ready'.	<ul style="list-style-type: none"> • Check if the camera power is turned on. If not, turn it on and then connect the camera to the PC again by placing it on the desktop stand.

8. Technical specifications

Image resolution	VGA (640 × 480)
Sensor	1/4"VGA CMOS
PC camera resolution (connected to PC)	VGA (640 × 480) up to 15 fps or CIF (320 × 240) up to 25 fps
Video resolution (disconnected from PC)	CIF (320 × 240) up to 15 fps
Built-in battery	Li-polymer battery. 150 mAh. Rechargeable via USB.
PC interface	USB 1.1
Internal memory capacity	8 MB
Case material	Metal
Power up time	2 seconds
Auto Power off	60 seconds
Still image format	JPEG
Video file format	AVI

9. Important information

Disclaimer

Philips makes no warranty of any kind with regard to this material, including, but not limited to, the implied warranties of merchantability and fitness for a particular purpose. Philips assumes no responsibility for any error that may appear in this document. Philips makes no commitment to update nor to keep current the information contained in this document.

FCC compliance

This device complies with Part 15 of the FCC Rules. Operation is subject to the following two conditions:

- 1 this device may not cause harmful interference, and
- 2 this device must accept any interference received, including interference that may cause undesired operation.

Note!

This equipment has been tested and found to comply with the limits for a Class B digital device, pursuant to Part 15 of the FCC Rules. These limits are designed to provide reasonable protection against harmful interference in a residential installation. This equipment generates, uses and can radiate radio frequency energy and, if not installed and used in accordance with the instructions, may cause harmful interference to radio communications. However, there is no guarantee that interference will not occur in a particular installation. If this equipment does cause harmful interference to radio or television reception, which can be determined by turning the equipment off and on, the user is encouraged to try to correct the interference by one or more of the following measures:

- Reorient or relocate the receiving antenna.
- Increase the separation between the equipment and receiver.
- Connect the equipment to an outlet on a circuit different from that to which the receiver is connected.
- Consult the dealer or an experienced radio/TV technician for help.

Any unauthorized modification to this equipment could result in the revocation of the authorization to operate the equipment.

End of life directives

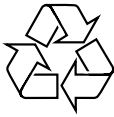

Philips is paying a lot of attention to producing environmentally-friendly in green focal areas. Your new camera contains materials which can be recycled and reused. At the end of its life specialised companies can dismantle the discarded camera to concentrate the reusable materials and to minimise the amount of materials to be disposed of.

Please ensure you dispose of your old camera according to local regulations.

Note! *This product may contain lead and mercury. Disposal of these materials may be regulated due to environmental considerations. For disposal or recycling information, please contact your local authorities or the Electronic Industries Alliance (U.S. specific): www.eiae.org.*

System requirements

- Microsoft® Windows® 98SE/2000/ME or XP;
- Pentium® II or AMS K6-II or above;
- 32MB RAM and 100 MB free hard disk space;
- One free USB port and **CD-ROM-/DVD drive**.

Disclaimer of warranty

The software on the CD-ROM supplied is sold 'as is' and without warranties whether expressed or implied. Because of the various software and hardware environments into which this program may be put, no warranty of fitness for a particular purpose is offered.

Limitations of damages

The vendor will not be liable for any indirect, special, incidental or consequential damages (including damages for loss of business, loss of profits, or the like), whether based on breach of contract, tort (including negligence), product liability or otherwise, even if the vendor or its representatives have been advised of the possibility of such damages and even if a remedy set forth herein is found to have failed its essential purpose.

10. Helpline

Need Help?

If you have any questions about the Philips FunCam, please contact our helpline for assistance! You can find the number in the list below.

Before you call, please read this manual carefully. You will be able to solve most of your problems.

The model number of the camera is DMVC 300K.

Date of purchase: _____ / _____ / _____
 day /month /year

België/ Belgien/ Belgique

02-275-0701

Nederland

053-482-9800

Danmark

35-25-8761

Norge

22-70-82-50

Deutschland

0696-698-4712

Österreich

01-546-575-603

España

09-17-45-62-46

Portugal

0800-831-363

France

03-8717-0033

Schweiz/ Suisse/ Svizzera

02-23-10-21-16

Έλληνας

00800 3122 1223

Suomi

09-2290-1908

Ireland

01-601-1161

Sverige

08-632-0016

Italia

02-48-27-11-53

UK (United Kingdom)

0207-949-0069

Luxemburg/ Luxembourg

408-433-5501

11. Warranty

**Guarantee certificate
Garantiebewijs
Certificado de garantia
Garantibevis**

**Certificat de garantie
Certificado de garantia
Εγγύηση
Garantibevis**

**Garantieschein
Certificato di garanzia
Garanticertifikat
Takuutodistus**

2

year warranty
année garantie
Jahr Garantie
jaar garantie
año garantia
anno garanzia

χρόνος εγγύηση
år garanti
år garanti
år garanti
vuosi takuu
año garantia

Type: **DMVC 300K**

Serial no: _____

Date of purchase - Date de la vente - Verkaufsdatum - Aankoopdatum - Fecha de compra - Date d'acquisto -
Data da aquisição - Ημερομηνία αγοράς - Inköpsdatum - Anskaffelsesdato - Kjøpedato - Oatopäivä -

Dealer's name, address and signature
Nom, adresse et signature du revendeur
Name, Anschrift und Unterschrift des Händlers
Naam, adres en handtekening v.d. handelaar
Nombre, dirección y firma del distribuidor
Nome, indirizzo e firma del fornitore

Όνοματεπώνυμο, διεύθυνση και υπογραφή του εμπ. προμηθευτή
Återförsäljarens namn, adress och signatur
Forhandlerens navn, adresse og underskrift
Forhandlerens navn, adresse og underskrift
Jälleenmyyjän nimi, osoite ja allekirjoitus
Nome, morada e assinatura da loja

6 month guarantee on rechargeable batteries
6 mois de garantie sur les piles rechargeables
6 meses de garantía para las pilas recargables
6 Monate Garantie auf wiederaufladbare Batterien
6 maanden garantie op oplaadbare batterijen
Garanzia di 6 mesi sulle batterie ricaricabili

Pilhas recarregáveis com 6 meses de garantia
Εγγύηση 6 μηνών σε επαναφορτιζόμενες μπαταρίες
6 månaders garanti på laddningsbara batterier
6 månaders garanti på genopladelige batterier
6 månaders garanti på de opladbare batteriene
Ladattavilla akuilla on 6 kuukauden takuu

www.philips.com
Data subject to change without notice

CE 0682 Ⓢ



PHILIPS