

PHILIPS

AC6606, AC6608



ZH-S

用户手册

3

EN

User manual

19



目录

1 重要事项	4	9 保修与服务	18
安全	4	订购部件或附件	18
2 您的空气净化器	6	10 注意事项	18
产品概述	6	电磁场 (EMF)	18
控件概述	7	回收	18
3 使用入门	8		
安装过滤网	8		
4 使用产品	9		
了解空气质量指示灯	9		
启动产品	9		
更改风速	10		
儿童锁	11		
使用灯光开/关功能	11		
5 清洁	12		
清洁计划	12		
清洗产品机身	12		
清洁出风口盖	12		
清洁空气质量传感器	13		
清洁预过滤网	13		
6 更换空气净化滤网	14		
了解健康空气智能锁	14		
更换空气净化滤网	15		
7 重置滤网使用寿命计数器	16		
8 故障排除	17		

1 重要事项

安全

使用本产品之前，请仔细阅读本使用说明书，并保留备用。

危险

- 切勿让水或任何其它液体或易燃性清洁剂进入产品，以免发生触电和 / 或火灾。
- 切勿用水或任何其它液体或（易燃性）清洁剂来清洁产品，以免发生触电和 / 或火灾。
- 切勿在产品周围喷洒杀虫剂或香水等任何可燃材料。

警告

- 在将产品连接电源之前，请先检查产品所标电压与当地的供电电压是否相符。
- 如果电源软线损坏，为避免危险，必须由制造厂或其维修部或类似的专职人员来更换。
- 如果插头、电源线或产品本身受损，请勿再使用本产品。
- 本产品不打算由肢体残障、精神障碍或缺乏相关经验和技能的人（包括儿童）使用，除非有负责安全的人员对他们进行产品使用的相关指导或说明，方可使用本产品。

- 请勿堵塞进风和出风口，例如不要将物体放置在出风口上或进风口前方。
- 确保异物未通过出风口进入产品内部。

注意

- 本产品不能替代正常通风、日常吸尘或者在烹饪时使用的抽油烟机。
- 如果连接产品的电源插座接触不良，则产品的插头可能会变得很热。确保所连接的电源插座接触良好。
- 一定要在干燥、稳固、平整且水平的表面上放置和使用本产品。
- 产品的后侧及两侧均要留出至少 20 厘米的空间，产品上方至少要留出 30 厘米的空间。
- 切勿在本产品上放置任何物品。
- 请勿坐在或站在产品上面。产品配有全向轮。坐在或站在产品上面可能导致潜在的人身伤害。
- 切勿将产品直接放在空调下方，以防冷凝水滴到产品中。
- 打开产品电源之前，务必确保已经正确安装所有过滤网。

- 只能使用飞利浦专门为本产品设计原装过滤网。切勿使用任何其它过滤网。
- 燃烧过滤网可能会导致对人体或其他生物的不可逆伤害。请勿将过滤网用作燃料或类似用途。
- 请勿用硬物敲击本产品（尤其是进风口和出风口）。
- 请务必通过产品两端的手柄提起或移动产品。
- 请勿将手指或物体插入出风口或进风口，以防止产品出现物理损坏或发生故障。
- 当您使用室内喷雾式驱虫剂或在充满油污、易燃气体或化学烟雾的地方时，请勿使用本产品。
- 请勿在气体用具、加热装置或火炉附近使用本产品。
- 使用之后和清洁产品或执行其他维护之前，务必将电源插头拔掉。
- 请勿在温度变化较大的房间内使用本产品，因为这可能导致产品内部的冷凝。
- 为防止产生干扰，产品与使用无线电波的电器（例如电视机、收音机和无线电控制时钟）之间至少应保持 2 米距离。
- 本产品仅限于家用并在正常运行条件下使用。
- 请勿在潮湿环境或高温环境中（例如浴室、卫生间或厨房）使用本产品。
- 本产品不能去除一氧化碳 (CO) 或氡 (Rn)，因此在发生燃烧和危险化学品事故时，不能作为安全设备使用。
- 如果需要移动产品，请先断开产品的电源。产品配有全向轮，便于移动。
- 移动产品时，务必缓慢，不要快速推动。
- 请勿通过拉扯电源线来移动产品。

2 您的空气净化器

感谢您的惠顾，欢迎光临飞利浦！

为了您能充分享受飞利浦提供的支持，请在 www.philips.com/welcome 上注册您的产品。

本产品为过滤式空气净化器。使用本产品之前，请仔细阅读本使用说明书，并保留备用。

产品概述

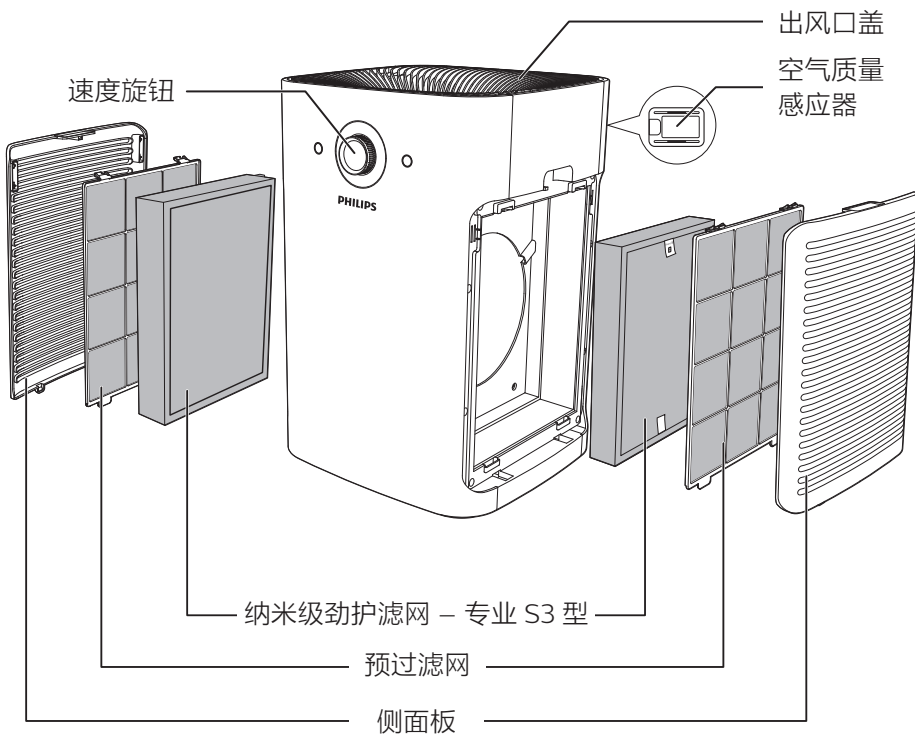

型号	过滤网
FY6177	纳米级劲护滤网 – 专业 S3 型 *

* 在下文统称为“空气净化滤网”。

控件概述

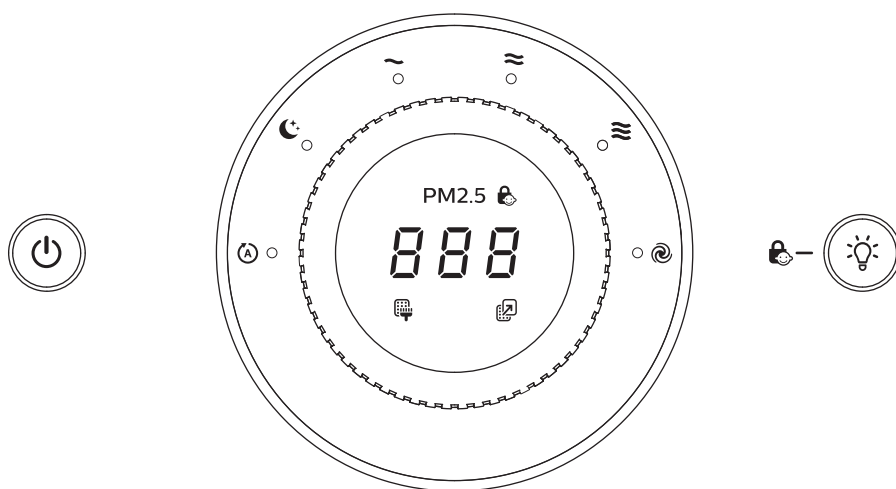

⏻ : 电源开关 / 过滤网重置按钮	≡ : 三档风速
🌀+ : 自动风速	⚙️ : 强力风速 (仅限 AC6608)
🌙+ : 静音风速	🗑️ : 清洁预过滤网提醒
~ : 一档风速	☑️+ : 更换空气净化过滤网提醒
≈ : 二档风速	💡 : 灯光开关 / 儿童锁按钮

3 使用入门

安装过滤网

在使用本产品之前，先拆掉过滤网的所有包装。请按以下所述拆掉过滤网的包装，然后将其放入产品中：

注意

- 产品的两侧各有一组滤网。每侧均配备一块预过滤网和一块空气净化滤网。
- 确保先在产品内放入空气净化滤网，然后再放置预过滤网。
- 确保带拉片的一面朝向您。

- 1 拆掉空气净化滤网的所有包装材料。

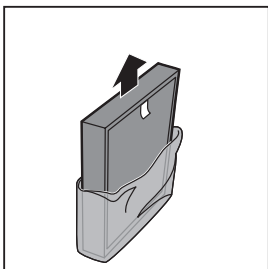

- 2 拉出侧面板的上半部分以将其从产品上卸下。

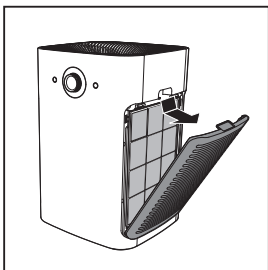

- 3 向下按两个固定夹，然后朝您自己的方向拉动预过滤网。

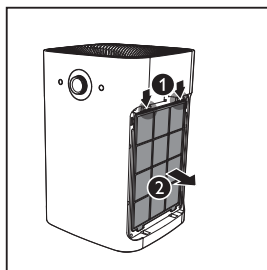

- 4 将拆去包装的空气净化滤网放回产品内。

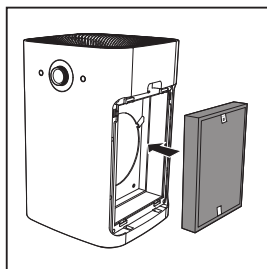

- 5 将预过滤网放回产品内部。

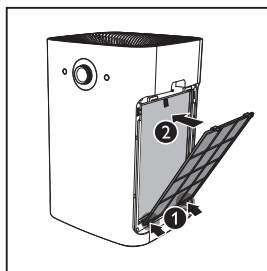

注意

- 确保带两个固定夹的一面朝向您，并确保预过滤网的所有挂钩均已正确连接到净化器上。

- 6 要重新安装侧面板，请先将面板安装到产品的底部 (1)。然后，朝产品机身方向轻推面板 (2)。

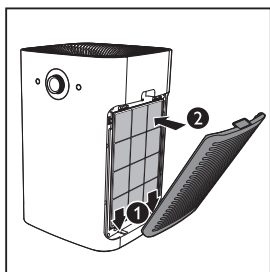

- 7 重复上述步骤，组装产品另一侧的空气净化滤网。

4 使用产品

了解空气质量指示灯

空气质量指示灯的颜色	空气质量级别
蓝色	良好
蓝紫色	一般
紫红色	不健康
红色	非常不健康

在打开本产品时，空气质量指示灯将自动打开，并按顺序亮起所有颜色。

在片刻后，空气质量传感器会选择与环境空气质量相对应的颜色。

启动产品

- 将产品插头插入电源插座。
 - 产品发出蜂鸣音。
 - 所有指示灯均亮起一次，然后再熄灭。
- 按下电源开 / 关按钮  可启动产品。

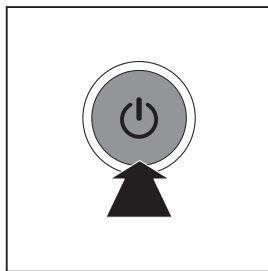

- 默认风速为  (自动)。

- ↳ 测量空气质量片刻后，空气质量传感器会自动选择空气质量指示灯的颜色。
- ↳ 机器测量 PM2.5 数值时，--- 在屏幕上滚动显示，测量完毕后屏幕显示当前 PM2.5 数值。

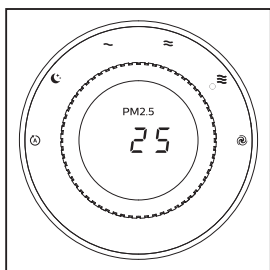



- 3 再次按下电源开 / 关按钮  可关闭产品。

更改风速

(自动)



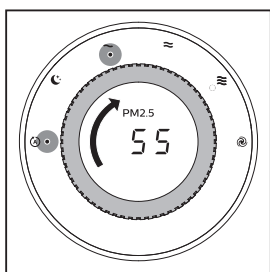

在自动模式下，产品会根据环境空气质量选择风扇速度。

- 1 转动速度旋钮可选择自动速度 。
 - ↳ 自动模式指示灯  以及当前风速档指示灯会亮起。



手动

- 1 转动速度旋钮可选择所需的风速：

-  (静音风速)
-  (一档风速)
-  (二档风速)
-  (三档风速)
-  (强力风速，仅限 AC6608)

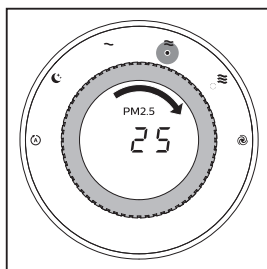

提示

- 如果空气质量指示灯呈蓝色亮起，表明空气质量良好，您可以选择较低的风速。另一方面，如果空气质量指示灯呈紫红或红色亮起，则表明空气质量不健康，您可以选择较高的风速，以便更快地净化空气。

儿童锁

为了防止儿童使用本产品，或者为了避免误操作，您可以激活儿童锁。

1 按住灯光开光按钮 3 秒钟。

↳ 此时儿童锁指示灯将在屏幕上亮起，表明已激活儿童锁。

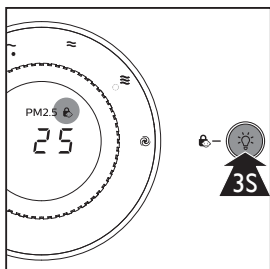

注意

· 激活儿童锁后，速度旋钮和所有按钮都不再对任何操作做出响应。

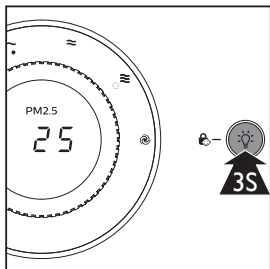

2 要关闭儿童锁，请再次按住灯光开光按钮 3 秒钟。

↳ 此时儿童锁指示灯将熄灭。



使用灯光开 / 关功能

使用灯光开 / 关功能，您可以打开或关闭空气质量指示灯和显示屏（如果需要）。



- 1 轻触灯光开 / 关按钮  一次，空气质量指示灯和显示屏将熄灭。
- 2 再次轻触灯光开 / 关按钮 ，风速指示灯将熄灭。
- 3 第三次轻触灯光开 / 关按钮 ，显示屏和所有指示灯都将重新亮起。

5 清洁

注意

- 清洁产品前，务必先将电源插头拔掉。
- 切勿将本产品浸入水中或任何其它液体中。
- 切勿使用研磨性、腐蚀性或易燃性清洁剂（例如漂白剂或酒精）清洁本产品的任何部件。
- 只有预过滤网可以用水清洗。空气净化器滤网不可水洗，也不可用吸尘器清洁。

清洁计划

频率	清洁方法
必要时	使用干软布清洁产品表面
	清洁出风口盖
每两个月	使用干棉签清洁空气质量传感器
当滤网清洁指示灯  在屏幕上亮起时	清洁预过滤网
当滤网更换指示灯  在屏幕上亮起时	更换空气净化滤网

清洗产品机身

定期清洁产品的内侧和外侧，防止灰尘积聚。

- 1 使用柔软的干布擦去产品机身上的灰尘。

清洁出风口盖

- 1 要打开出风口盖，请握住盖子上的手柄，然后向上拉动。

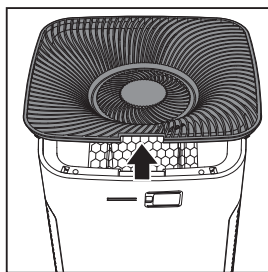

- 2 用刷子清洁出风口盖。

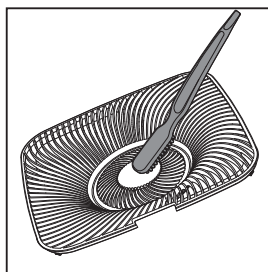

- 3 要重新安装出风口盖，请先将一侧装到产品顶部，然后将手柄一侧向下推动。

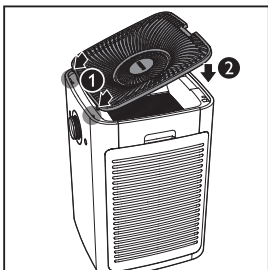

- 3 使用稍微浸湿的棉签清洁传感器、进风口和出风口，最后用干棉签擦干。

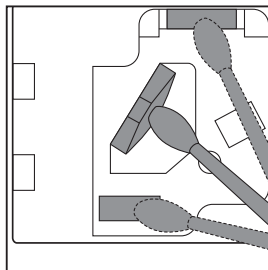

清洁空气质量传感器

每 2 个月清洁一次空气质量传感器，确保产品以最佳性能运行。如果产品用在多尘的环境中，请经常进行清洁。

- 1 使用软刷清洁空气质量传感器的进风口和出风口。

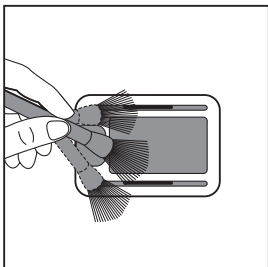

- 2 打开空气质量传感器的盖子。

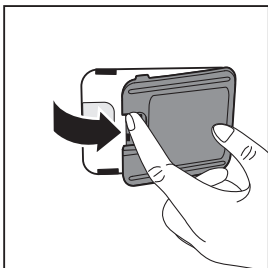

- 4 关闭传感器盖。

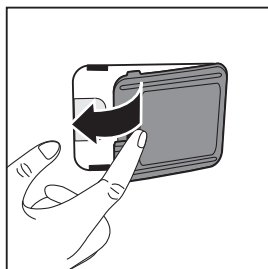

清洁预过滤网

滤网提示灯状态	按此操作
 在屏幕上亮起	清洁预过滤网

注意

- 清洁预过滤网指示灯  大约每 2 周亮起一次。

6 更换空气净化滤网

了解健康空气智能锁

本产品具有健康空气智能锁，旨在确保产品运行过程中，空气净化滤网在最佳条件下工作。当两块滤网使用寿命即将结束时，空气净化滤网更换指示灯()将在屏幕上亮起，这意味着您必须更换两块空气净化滤网。

如果您不及时更换滤网：

- ↳ 空气净化滤网更换指示灯()将一直亮起。
- ↳ 产品将停止运行并且锁定。

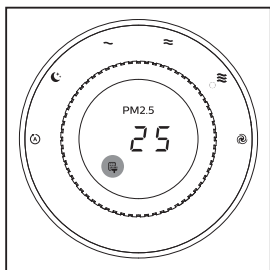
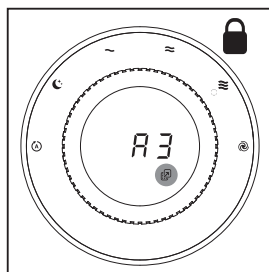

- 1 用自来水冲洗预过滤网。如果预过滤网很脏，请使用真空吸尘器或软毛刷清除灰尘，然后再在水龙头下冲洗。

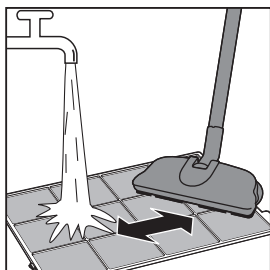

注意

- 确保冲洗产品两侧的预过滤网。

- 2 将预过滤网晾干。

注意

- 确保预过滤网完全干燥后再将其放回产品。如果仍然是湿的，细菌可能会乘虚而入，从而缩短预过滤网的使用寿命。

- 3 将预过滤网正确放回产品后，重置滤网使用寿命计数器。
(请参阅第7章“重置滤网使用寿命计数器”。)

更换空气净化滤网

注意

- 空气净化滤网不可水洗，也不可用水真空吸尘器清洁。
- 本产品的默认空气净化滤网为纳米级劲护滤网 – 专业 S3 型 (A3)。如果您想要尝试使用其他过滤网，请参阅滤网包装内随附的单据，了解如何为本产品应用新过滤网。

滤网提示灯状态	按此操作
 亮起，并且 A3 显示在屏幕上	更换纳米级劲护滤网 – 专业 S3 型

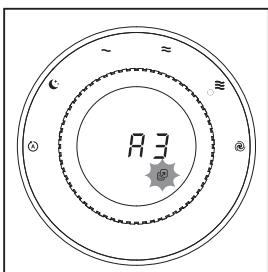

- 1 取出产品两侧的预过滤网。
- 2 取出需要更换的过滤网，然后轻轻将其放入垃圾桶。

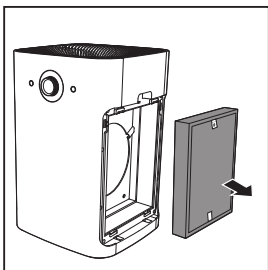

注意

- 请勿接触滤网的褶皱面，或闻滤网的气味，因为其包含从空气中收集的污染物。

- 3 拆掉新滤网上的所有包装材料。

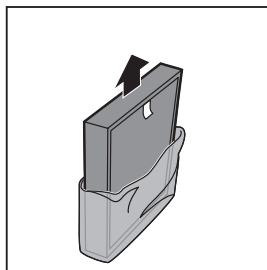

- 4 将拆去包装的空气净化滤网放回产品内。

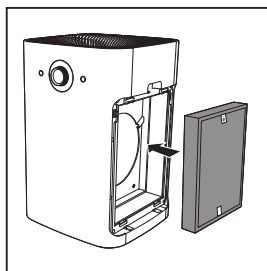

- 5 将预过滤网正确放回产品后，重置滤网使用寿命计数器。（请参阅第 7 章“重置滤网使用寿命计数器”。）

注意

- 更换过滤网完毕后，请清洗双手。

7 重置滤网使用寿命计数器

在清洁预过滤网或更换空气净化滤网后，请务必也重置过滤网使用寿命计数器。这可使产品与过滤网使用寿命同步。

- 1 按住电源开 / 关按钮  3 秒钟。
 - ↳ 滤网指示灯熄灭，产品将自动恢复工作。

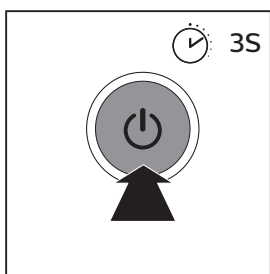

8 故障排除

本章归纳了您在使用产品时最常遇到的问题。如果您无法根据下面的信息解决问题，请与您所在国家 / 地区的客户服务中心联系。

问题	可能的解决方法
产品即使接通电源也无法工作。	过滤网更换指示灯持续亮起，但您尚未更换相应的过滤网，因此产品已被锁定。在此情况下，请更换过滤网并重置过滤网使用寿命计数器。
出风口排出的气流比之前明显减弱。	<ul style="list-style-type: none"> • 预过滤网变脏。清洁预过滤网（请参阅“清洁”一章）。
即使在产品已经运行很长时间以后，空气质量也未见显著改善。	<ul style="list-style-type: none"> • 某一过滤网可能没有放在产品内部。确保按以下顺序正确安装所有过滤网，首先从最里面的过滤网开始：1) 空气净化滤网；2) 预过滤网。 • 空气质量传感器湿度过高。室内湿度过高，因此形成了冷凝水。确保空气质量传感器清洁干燥（请参阅“清洁”一章）。
空气质量指示灯的颜色始终保持不变。	空气质量传感器变脏。清洁空气质量传感器（请参阅“清洁”一章）。
产品散发出一种奇怪的味道。	前几次使用产品时，其可能会产生塑料味。这是正常的。不过，如果产品发出烧焦的气味，请联系飞利浦经销商或经授权的飞利浦服务中心。当滤网很脏时，产品也可能会发出难闻的气味。在这种情况下，请清洁或更换相关的滤网。
产品声音过大。	如果产品声音太大，您可以将风速更改为较低的风速级别。夜晚在卧室内使用时可将风速调为静音模式。
我已经更换过了过滤网，但是产品还是一直指示需要更换滤网。	可能是您未重置滤网使用寿命计数器。启动产品。然后按住电源开 / 关按钮  3 秒钟。
产品停止工作，空气质量指示灯变为蓝色并闪烁。	空气质量传感器出现故障。请联系飞利浦经销商或经授权的飞利浦服务中心。

问题	可能的解决方法
产品停止工作，一档和二档，或者二档和三档风速指示灯闪烁。	产品电机出现故障。请联系飞利浦经销商或经授权的飞利浦服务中心。

9 保修与服务

如果您需要了解信息或有任何疑问，请访问飞利浦网站 www.philips.com 或联系您所在国家 / 地区的飞利浦客户服务中心（可在全球保修卡中找到飞利浦客户服务中心的电话号码）。如果您所在的国家 / 地区没有飞利浦客户服务中心，请向当地的飞利浦经销商求助。

订购部件或附件

如果您必须更换部件或需要购买额外的部件，请转到您的飞利浦经销商或访问 www.philips.com/support。如果获取部件有问题，请与您所在国家 / 地区的飞利浦客户服务中心联系（可在全球保修卡中找到其电话号码）。

10 注意事项

电磁场 (EMF)

本飞利浦产品符合所有有关暴露于电磁场的适用标准和法规。

符合 EMF 标准

Koninklijke Philips N.V. 主要面向广大消费者制造和销售各类产品，包括通常能发射和接收电磁信号的各种电子设备。

飞利浦的主要业务原则之一就是对自己的产品采取各种必要的健康和安全措施，使其符合所有相应的法律要求，并在制造产品时严格遵照适用的 EMF 标准。

飞利浦致力于开发、生产和销售对人体健康无任何危害的产品。飞利浦确认，据目前的科学证明，如果其产品使用得当，则对人体毫无危害。

长期以来，Philips 始终在国际 EMF 和安全标准的制定工作中扮演着积极的角色，这就使 Philips 总能预知标准的发展趋势，并率先应用到其产品中去。

回收

弃置产品时，请不要将它与一般生活垃圾一同丢弃，应将其交给官方指定的回收中心。这样做有利于环保。

Contents

1 Important	20	7 Resetting the filter lifetime counter	35
Safety	20		
2 Your air purifier	23	8 Troubleshooting	36
Product Overview	23		
Controls overview	24	9 Guarantee and service	38
3 Getting started	25	Order parts or accessories	38
Install filters	25	10 Notices	38
4 Using the appliance	26	Electromagnetic fields (EMF)	38
Understand the air quality light	26	Recycling	39
Switch on	26		
Change the fan speed	27		
Child lock	28		
Using the light On/Off function	29		
5 Cleaning	30		
Cleaning schedule	30		
Clean the body of the appliance	30		
Clean the air outlet cover	30		
Clean the air quality sensor	31		
Clean the pre-filter	32		
6 Replacing the air purification filter	33		
Understand the healthy air protect lock	33		
Replace the air purification filter	33		

1 Important

Safety

Read this user manual carefully before you use the appliance, and save it for future reference.

Danger

- Do not let water or any other liquid or flammable detergent enter the appliance to avoid electric shock and/or a fire hazard.
- Do not clean the appliance with water, any other liquid, or a (flammable) detergent to avoid electric shock and/or a fire hazard.
- Do not spray any flammable materials such as insecticides or fragrance around the appliance.

Warning

- Check if the voltage indicated on the appliance corresponds to the local power voltage before you connect the appliance.
- If the power cord is damaged, you must have

it replaced by Philips, a service center authorized by Philips, or similarly qualified persons in order to avoid a hazard.

- Do not use the appliance if the plug, the power cord, or the appliance itself is damaged.
- This appliance can be used by children aged from 8 years and above and persons with reduced physical, sensory or mental capabilities or lack of experience and knowledge if they have been given supervision or instruction concerning use of the appliance in a safe way and understand the hazards involved. Child shall not play with the appliance. Cleaning and maintenance shall not be made by children without supervision.
- Do not block the air inlet and outlet, e.g. by placing items on the air outlet or in front of the air inlet.
- Make sure that foreign objects do not fall into the appliance through the air outlet.

Caution

- This appliance is not a substitute for proper ventilation, regular vacuum cleaning, or use of an extractor hood or fan while cooking.
- If the power socket used to power the appliance has poor connections, the plug of the appliance becomes hot. Make sure that you plug the appliance into a properly connected power socket.
- Always place and use the appliance on a dry, stable, level, and horizontal surface.
- Leave at least 20cm free space behind and on both sides of the appliance and leave at least 30cm free space above the appliance.
- Do not place anything on top of the appliance.
- Do not sit or stand on the appliance. The appliance is equipped with omni wheels. Sitting or standing on the appliance may lead to potential injury.
- Do not place the appliance directly below an air conditioner to prevent condensation from dripping onto the appliance.
- Make sure all filters are properly installed before you switch on the appliance.
- Only use the original Philips filters specially intended for this appliance. Do not use any other filters.
- Combustion of the filter may cause irreversible human hazard and/or jeopardize other lives. Do not use the filter as fuel or for similar purpose.
- Avoid knocking against the appliance (the air inlet and outlet in particular) with hard objects.
- Always lift or move the appliance by both handles at the sides of the appliance.
- Do not insert your fingers or objects into the air outlet or the air inlet to prevent physical injury or malfunctioning of the appliance.

- Do not use this appliance when you have used indoor smoke-type insect repellents or in places with oily residues, burning incense, or chemical fumes.
- Do not use the appliance near gas appliances, heating devices or fireplaces.
- Always unplug the appliance after use and before cleaning or carrying out other maintenance.
- Do not use the appliance in a room with major temperature changes, as this may cause condensation inside the appliance.
- To prevent interference, place the appliance at least 2m away from electrical appliances that use airborne radio waves such as TVs, radios, and radio-controlled clocks.
- The appliance is only intended for household use under normal operating conditions.
- Do not use the appliance in wet surroundings or in surroundings with high ambient temperatures, such as the bathroom, toilet, or kitchen.
- The appliance does not remove carbon monoxide (CO) or radon (Rn). It cannot be used as a safety device in case of accidents with combustion processes and hazardous chemicals.
- If you need to move the appliance, disconnect the appliance from the power supply first. The appliance is equipped with omni wheels and is easy to move.
- When moving the appliance, do it slowly and do not push it rapidly.
- Do not move the appliance by pulling its power cord.

2 Your air purifier

Congratulations on your purchase, and welcome to Philips!

To fully benefit from the support that Philips offers, register your product at www.philips.com/welcome.

This appliance works with an air filtration system. Read this user manual carefully before you use the appliance, and save it for future reference.

Product Overview

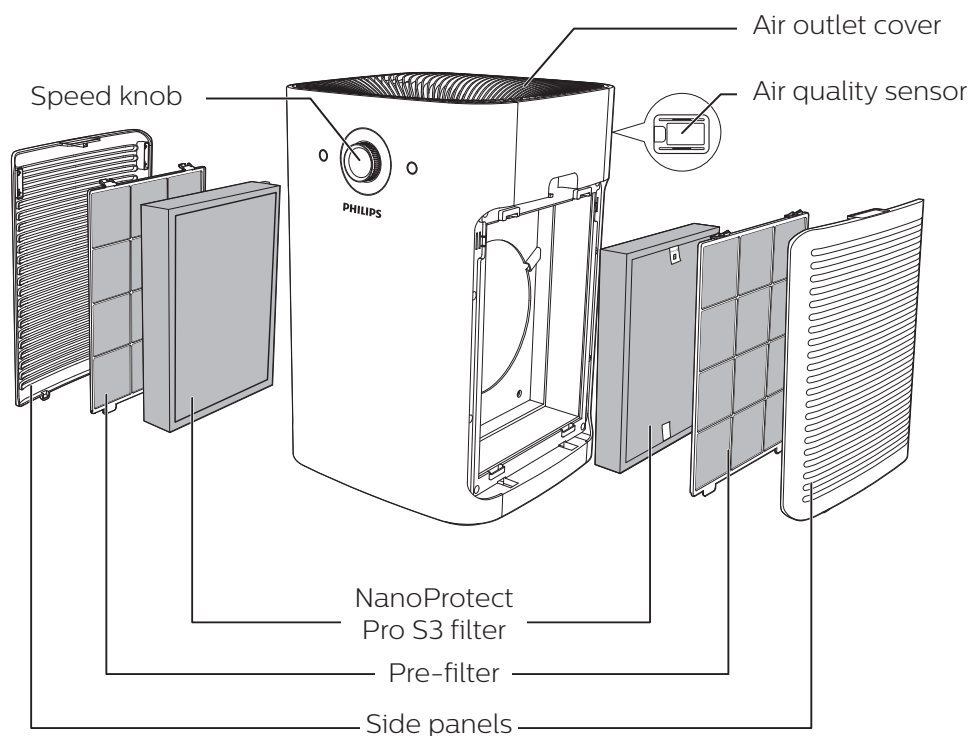

Type number	Filter
FY6177	NanoProtect Pro S3*

*Hereinafter referred to as "air purification filter".

Controls overview

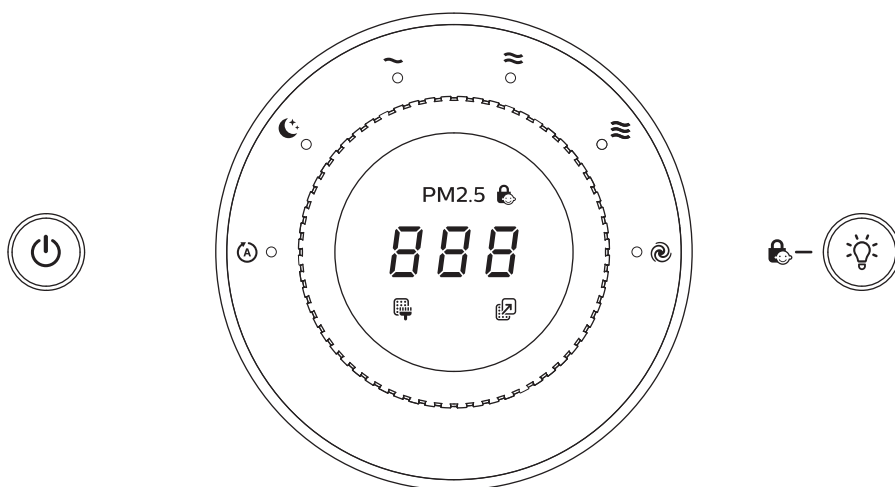

⏻ : Power On/Off (filter reset) button	≡ : Speed 3
Ⓐ : Auto speed	⚡ : Turbo speed (AC6608 only)
🌙 : Silent speed	🧼 : Pre-filter cleaning alert
~ : Speed 1	📄 : Air purification filter replacement alert
≈ : Speed 2	💡 : Light On/Off (child lock) button

3 Getting started

Install filters

Remove all packaging of the filters before using the appliance. Unpack them and place them into the appliance described as follows:

Note

- There is one set of filters on each side of the appliance. Each side is equipped with one pre-filter and one air purification filter.
- Make sure that you place the air purification filter in the appliance first and then the pre-filter.
- Make sure that the side with the tag is pointing towards you.

- 1 Remove all packaging materials of the air purification filters.

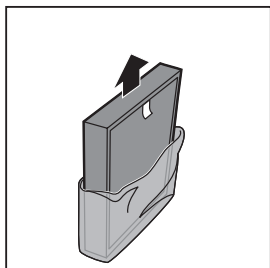

- 2 Pull the top part of the side panel to remove it from the appliance.

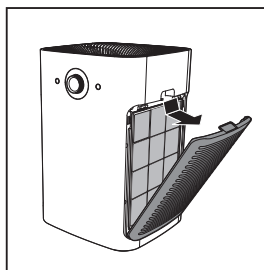

- 3 Press the two clips down and pull the pre-filter towards you.

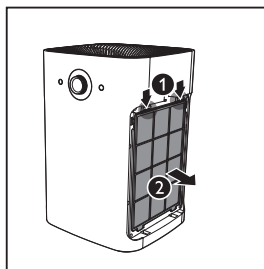

- 4 Put the unpacked air purification filter back into the appliance.

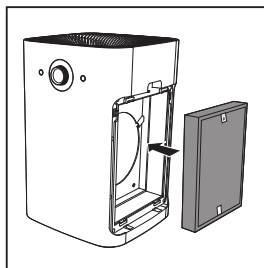

- 5 Put the pre-filter back into the appliance.

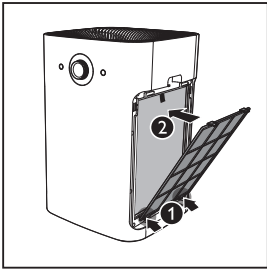

Note

- Make sure that the side with the two clips is pointing towards you, and that all hooks of the pre-filter are properly attached to the purifier.

- 6 To reattach the side panel, mount the panel onto the bottom of the appliance first (1). Then, gently push the panel against the body of the appliance (2).

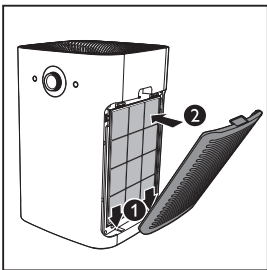

- 7 Repeat the above steps and assemble the air purification filter for the other side of the appliance.

4 Using the appliance

Understand the air quality light

Color of the air quality light	Air quality level
Blue	Good
Blue-violet	Fair
Red-purple	Unhealthy
Red	Very unhealthy

The air quality light automatically goes on when the appliance is switched on, and lights up all colors in sequence.

In a short time the air quality sensors select the color that corresponds to the ambient air quality.

Switch on

- 1 Put the plug of the appliance into the wall socket.
 - ↳ The appliance beeps.
 - ↳ All lights go on once and then go out again.

- 2 Press the power On/Off button  to switch on the appliance.

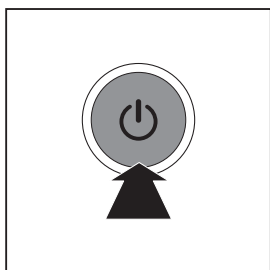

- ↳ The default fan speed is  (AUTO).
- ↳ After measuring the air quality for a short time, the air quality sensor automatically selects the color of the air quality light.
- ↳ The running strips "----" displays on the screen when the appliance is measuring the PM2.5 level. After a short time the actual PM2.5 level will display on the screen.

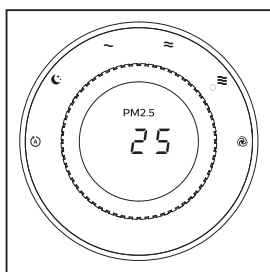



- 3 Press the power On/Off button  again to switch off the appliance.

Change the fan speed

(AUTO)

In auto mode, the appliance selects the fan speed in accordance with the ambient air quality.

- 1 Turn the speed knob to select the auto speed .
- ↳  and the current fan speed indicator lights up.

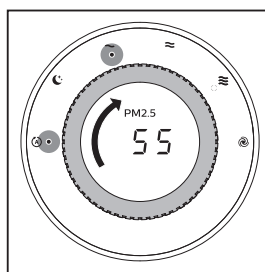

Manual

- 1 Turn the speed knob to select the fan speed you need:

☾ (Silent speed)

~ (Speed 1)

≡ (Speed 2)

≡≡ (Speed 3)

⊙ (Turbo speed, for AC6608 only)

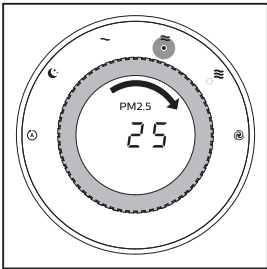

Tip

- If the air quality light lights up blue, it indicates that the air quality is good, and you can select a lower fan speed. On the other hand, if the air quality light lights up red-purple or red, it indicates that the air quality is unhealthy, and you can select a higher fan speed to purify the air more quickly.

Child lock

To keep children from using the appliance, or to avoid any misoperation, you can activate child lock.

- 1 Press and hold the light On/Off button for 3 seconds.

↳ The child lock indicator lights up on the screen to show that the child lock has been activated.

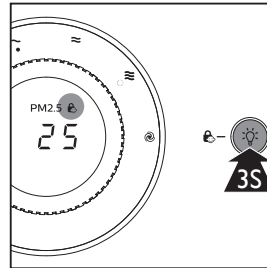

Note

- When the child lock is activated, the speed knob and all buttons will no longer respond to any operation.

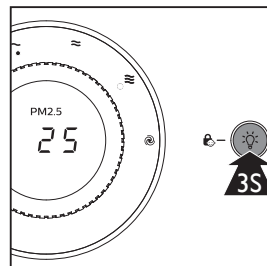

- 2 To deactivate the child lock, press and hold the light On/Off button for 3 seconds again.

↳ The child lock indicator goes off.



Using the light On/Off function

With the light On/Off button, you can switch on or off the air quality light and the display screen if needed.



- 1** Touch the light On/Off button  once, the air quality light and display screen will go out.
- 2** Touch the light On/Off button  again, the fan speed indicator will go out.
- 3** Touch the light On/Off button  for the third time, all lights and the display screen will go on again.

5 Cleaning

Note

- Always unplug the appliance before you clean it.
- Never immerse the appliance in water or any other liquid.
- Never use abrasive, aggressive, or flammable cleaning agents such as bleach or alcohol to clean any part of the appliance.
- Only the pre-filter is washable. The air purifier filter is not washable nor vacuum cleanable.

Cleaning schedule

Frequency	Cleaning method
When necessary	Wipe the surface of the appliance with a soft dry cloth
	Clean the air outlet cover
Every two months	Clean the air quality sensor with a dry cotton swab
When the filter cleaning indicator  lights up on the screen	Clean the pre-filter
When the filter replacement indicator  lights up on the screen	Replace the air purification filters

Clean the body of the appliance

Regularly clean the inside and outside of the appliance to prevent dusts from collecting.

- 1 Wipe away dust with a soft dry cloth from the body of the appliance.

Clean the air outlet cover

- 1 To unlock the air outlet cover, grab the handle on the cover and pull the cover up.

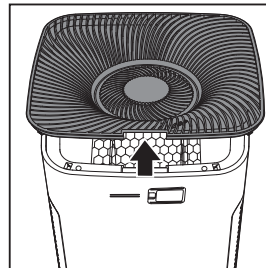

- 2 Clean the cover with a brush.

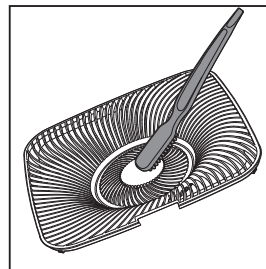

- 3** To reattach the cover, mount it onto the top of the appliance first, and then push the side with the handle towards the appliance.

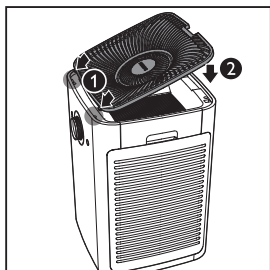

Clean the air quality sensor

Clean the air quality sensor every two months for optimal functioning of the appliance. Clean it more frequently if you use the appliance in a dusty environment.

- 1** Clean the inlet and outlet of the air quality sensor with a soft brush.

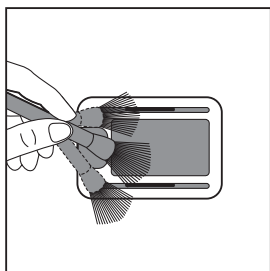

- 2** Open the cover of the air quality sensor.

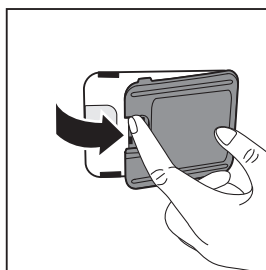

- 3** Clean the sensor, the dust inlet and outlet with a lightly moistened cotton swab, and finish with a dry cotton swab.

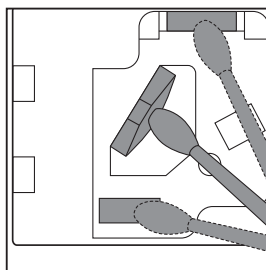

- 4** Close the sensor cover.

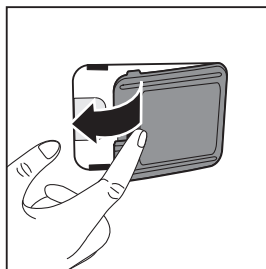

Clean the pre-filter

Filter alert light status	Follow this
 lights up on the screen	Clean the pre-filter

Note

- Filter light  lights up approximately once every two weeks.

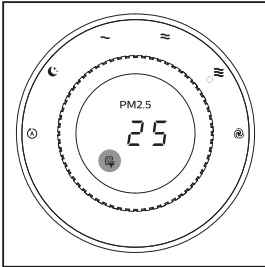

- 1 Rinse the pre-filters under a running tap. If the pre-filters are very dirty, use a vacuum cleaner or soft brush to remove the dust before rinsing under the tap.

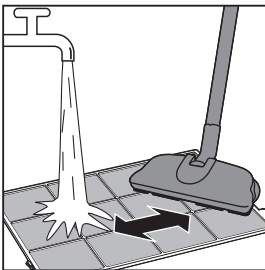

Note

- Make sure to rinse the pre-filters equipped in both sides of the appliance.

- 2 Air dry the pre-filters.

Note

- Make sure that the pre-filters are completely dry before you put them back in the appliance. If they are still wet, bacteria may multiply in them and shorten the lifetime of the pre-filters.

- 3 After the pre-filters are properly put back in the appliance, reset the filter lifetime counter. (Refer to chapter 7 "Resetting the filter lifetime counter".)

6 Replacing the air purification filter

Understand the healthy air protect lock

This appliance is equipped with the healthy air protect lock to make sure that the filters are in optimal condition when the appliance is operating. When the filters are almost expired, the air purification filter replacement light (🔧) lights up on the screen to indicate that the filters have to be replaced.

If you do not replace the filters in time:

- ↳ The air purification filter replacement light (🔧) remains on.
- ↳ The appliance stops operating and is locked.

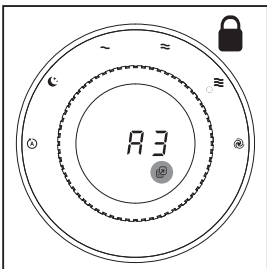

Replace the air purification filter

Note

- The air purification filters are not washable nor vacuum cleanable.
- The default air purification filter for this appliance is NanoProtect Pro S3 (A3). If you want to try and use other filters, refer to the separate leaflet included in the filter packaging on how to apply new filters to this appliance.

Filter alert light status	Follow this
🔧 lights up, and A3 displays on the screen	Replace the NanoProtect Pro S3 filter

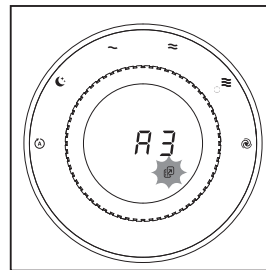

- 1 Take out the pre-filters on both sides of the appliance.
- 2 Take out the expired filters, and gently put them into the trash bin.

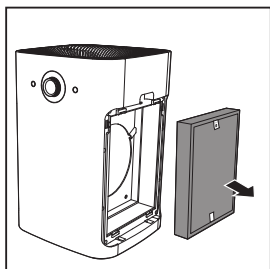

 Note

- Do not touch the pleated filter surface, or smell the filter as it has collected pollutants from the air.

- 3 Remove all packaging material of the new filters.

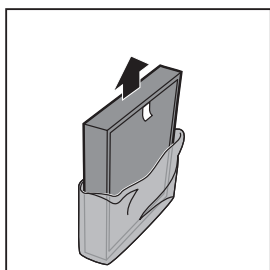

- 4 Put the unpacked air purification filters back into the appliance.

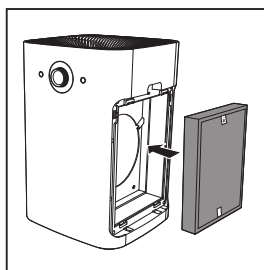

- 5 After the pre-filters are properly put back in the appliance, reset the filter lifetime counter. (Refer to chapter 7 "Resetting the filter lifetime counter".)

 Note

- Cleanse your hands after changing filter.

7 Resetting the filter lifetime counter

After you have cleaned the pre-filter, or replaced the air purification filters, it is important that you also reset the filter lifetime counter afterwards. This allows the appliance to be in sync with the filter lifetime.

- 1 Press and hold the power On/Off button  for 3 seconds.
 - ↳ The filter light goes out, and the appliance resumes working automatically.

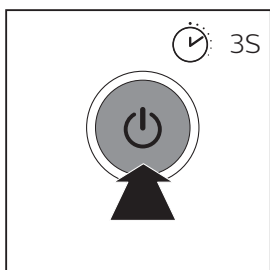

8 Troubleshooting

This chapter summarizes the most common problems you could encounter with the appliance. If you are unable to solve the problem with the information below, contact the Consumer Care Center in your country.

Problem	Possible solution
The appliance does not work even though it is plugged in.	The filter replacement light has been on continuously but you have not replaced the corresponding filter. As a result, the appliance is now locked. In this case, replace the filter and reset the filter lifetime counter.
The airflow that comes out of the air outlet is significantly weaker than before.	The pre-filter is dirty. Clean the pre-filter (see the chapter "Cleaning").
The air quality does not improve, even though the appliance has been operating for a long time.	<ul style="list-style-type: none">• One of the filters has not been placed in the appliance. Make sure that all filters are properly installed in the following order, starting with the innermost filter: 1) air purification filter; 2) pre-filter.• The air quality sensor is wet. The humidity level in your room is high and causes condensation. Make sure that the air quality sensor is clean and dry (see the chapter "Cleaning").
The color of the air quality light always stays the same.	The air quality sensor is dirty. Clean the air quality sensor (see the chapter "Cleaning").

Problem	Possible solution
The appliance produces a strange smell.	The first few times you use the appliance, it may produce a plastic smell. This is normal. However, if the appliance produces a burnt smell, contact your Philips dealer or an authorized Philips service center. The appliance may also produce an unpleasant smell when one of the filters is dirty. In this case, clean or replace the filter concerned.
The appliance is extra loud.	If the appliance is too loud, you can change the fan speed to a lower fan speed level. When using the appliance in a bedroom at night, choose the silent speed.
The appliance still indicates that I need to replace a filter, but I already did.	Perhaps you did not reset the filter lifetime counter. Switch on the appliance. Then press and hold the power On/Off button  for 3 seconds.
The appliance stops working, and the air quality light blinks blue.	The sensor has malfunctions. Contact your Philips dealer or an authorized Philips service center.
The appliance stops working, the fan speed indicators 1 and 2, or 2 and 3 blink.	The motor has malfunctions. Contact your Philips dealer or an authorized Philips service center.

9 Guarantee and service

If you need information or if you have a problem, please visit the Philips website at www.philips.com or contact the Philips Consumer Care Center in your country (you can find its phone number in the worldwide guarantee leaflet). If there is no Consumer Care Center in your country, go to your local Philips dealer.

Order parts or accessories

If you have to replace a part or want to purchase an additional part, go to your Philips dealer or visit www.philips.com/support.

If you have problems obtaining the parts, please contact the Philips Consumer Care Center in your country (you can find its phone number in the worldwide guarantee leaflet).

10 Notices

Electromagnetic fields (EMF)

This Philips appliance complies with all applicable standards and regulations regarding exposure to electromagnetic fields.

Compliance with EMF

Koninklijke Philips N.V. manufactures and sells many products targeted at consumers, which, like any electronic apparatus, in general have the ability to emit and receive electromagnetic signals.

One of Philips' leading Business Principles is to take all necessary health and safety measures for our products, to comply with all applicable legal requirements and to stay well within the EMF standards applicable at the time of producing the products.

Philips is committed to develop, produce and market products that cause no adverse health effects. Philips confirms that if its products are handled properly for their intended use, they are safe to use according to scientific evidence available today.

Philips plays an active role in the development of international EMF and safety standards, enabling Philips to anticipate further developments in standardization for early integration in its products.

Recycling

Do not throw away the product with the normal household waste at the end of its life, but hand it in at an official collection point for recycling. By doing this, you help to preserve the environment.



此保用卡在中国适用
用户请保留此卡

保修及服务：

此产品是一件设计精良，用高品质元件制造之家用电器，在正常使用及保养下应能发挥其优越性能。在购买日期后二年内，若发生任何因制造工艺或元器件造成之损坏，飞利浦中国维修服务中心将为持证用户提供免费门市维修服务，视情况更换零件或整个产品。

无论在保期中或保期后，只要飞利浦正式行销该产品的任何国家皆可获得维修服务。

若飞利浦在当地无行销该项产品，飞利浦同样提供维修服务，但可能因未储备所需零件，维修时间可能较长，敬请谅解。请联络当地飞利浦经销商，或飞利浦服务部门。

若您需洽询相关资讯，或遇困难事项时，请联络当地飞利浦维修服务中心，或向飞利浦服务热线咨询。

中国顾客服务热线：4008 800 008
(用户需承担本地通话费)。

网址：<http://www.philips.com.cn>

网上会员注册与产品注册：

- 1) 登陆 <http://www.philips.com.cn/welcome>
- 2) 点击“创建新账户”，创建您的飞利浦账号
- 3) 点击“注册产品”，通过产品名称或产品型号查找产品，完成产品注册

服务须知

需要此产品的售后服务，
拨打服务热线：4008 800 008
在维修服务过程中有任何意见，
欢迎致函飞利浦优质生活
服务办事处解决疑难。

保修条例：

- * 在购买日期后二年内，凡经本公司特约维修站人员确认为正常使用情况下，因制造工艺或元器件造成之损坏，您都将获得免费维修服务。
 - * 此免费服务不包括需时常更换的易耗零配件（吸尘机纸袋，布袋，空气清新机滤网，滤芯，活性炭，咖啡壶过滤网）及附件（如须刀网膜、刀头，咖啡杯，食品加工机杯/刀具等），辅助装置，运费及维修人员上门服务费。
 - * 用户请保留此联。
 - * 维修时请携同此证及发票正本。
 - * 此证若经涂改即作废。
 - * 此证须连同发票正本使用方为有效。
 - * 以下情况将不能获得免费服务
1. 使用不当引起的人为损坏，例如接入不当电源、使用不当配件、不适当之安装、不依说明书使用、错误使用或疏忽而造成损坏等。因运输及其他意外而造成之损坏。非经本公司认可之维修和改装。其他因不可抗力（如自然灾害、电压异常等）造成的损坏。
 2. 一般家庭以外使用（如工业、商业用）而造成的损坏。
 3. 正常使用引起的产品老化、磨损等，但不影响产品的正常使用。
- * 此证仅在中国境内有效。
 - * 保修证作为在规定期限及条件之内进行免费维修的保证，并不限制消费者的法定权利。

飞利浦（中国）投资有限公司
飞利浦优质生活客户服务部
中国上海市田林路888弄10号
飞利浦创新科技园1号楼
邮政编码：200233 传真：(021) 5445 2663

产品中有害物质的名称及含量

部件名称	有害物质					
	铅(Pb)	汞(Hg)	镉(Cd)	六价铬 (Cr(VI))	多溴联苯 (PBB)	多溴二苯醚 (PBDE)
主电路板组件	×	○	○	○	○	○
电源电路板组件	×	×	×	○	○	○
变压器板组件	×	○	○	○	○	○
<p>本表格依据SJ/T 11364的规定编制。</p> <p>○ 表示该有害物质在该部件所有均质材料中的含量均在GB/T 26572规定的限量要求以下。</p> <p>× 表示该有害物质至少在该部件的某一均质材料中的含量超出GB/T 26572规定的限量要求。</p>						

PHILIPS

产品 : 飞利浦空气净化器AC6606
型号 : KJ600F-F01
额定电压 : 220V ~
额定频率 : 50Hz
额定输入功率: 60W
生产日期 : 请见产品本体
产地 : 韩国



经销单位: 飞利浦(中国)投资有限公司
上海市天目西路218号1602-1605
全国顾客服务热线: 4008 800 008

本产品根据国标GB4706.1-2005, GB4706.45-2008制造

产品性能指标

目标污染物	洁净空气量(CADR)	累计净化量(CCM)	净化能效等级
颗粒物	669 m ³ /h	P4	高效级
甲醛	>400 m ³ /h	F4	高效级
甲苯	>400 m ³ /h	—	高效级
噪声(声功率级)	62 dB(A)	适用面积*	47 - 80 m ²

*适用面积是按照国标GB/T18801-2015根据颗粒物洁净空气量计算得出
以上性能指标数据是在第三方试验室按照国标GB/T18801-2015, 以特定的烟尘
颗粒物或气态污染物为目标污染物测试得出

PHILIPS

产品 : 飞利浦空气净化器AC6608
型号 : KJ650F-F02
额定电压 : 220V ~
额定频率 : 50Hz
额定输入功率: 75W
生产日期 : 请见产品本体
产地 : 韩国



经销单位: 飞利浦(中国)投资有限公司
上海市天目西路218号1602-1605
全国顾客服务热线: 4008 800 008

本产品根据国标GB4706.1-2005, GB4706.45-2008制造

产品性能指标

目标污染物	洁净空气量(CADR)	累计净化量(CCM)	净化能效等级
颗粒物	710 m ³ /h	P4(>50000mg)	高效级
甲醛	>400 m ³ /h	F4	高效级
甲苯	>400 m ³ /h	—	高效级
噪声(声功率级)	65 dB(A)	适用面积*	50 - 85 m ²

*适用面积是按照国标GB/T18801-2015根据颗粒物洁净空气量计算得出
以上性能指标数据是在第三方试验室按照国标GB/T18801-2015, 以特定的烟尘
颗粒物或气态污染物为目标污染物测试得出

保留备用

出版日期: 2016-11-08



© 2016 Koninklijke Philips N.V.
保留所有权利
4241 210 82183

