

JVC

GB

Instruction Manual

40" LED Smart HD TV

LT-40C750(A)



HD TV 1080p

dts
TruSurround

dts
2.0+Digital Out

FreeviewHD

DOLBY
DIGITAL PLUS

HDMI
HIGH-DEFINITION MULTIMEDIA INTERFACE

Contents

1	Safety Warnings	6
2	Preparation	8
	Unpacking the TV	8
	Installing / Removing the Base Stand	9
	– Fitting the Stand to the TV.....	9
	Mounting the TV to a Wall.....	10
	Front / Right Side View and Controls.....	10
	Rear View and Sockets	11
	Installing Batteries in the Remote Control	12
	Remote Control Operation Range.....	12
	Remote Control	13
3	Initial Setup	15
	Turning the TV On for the First Time	15
	– Choose Region (UK only)	17
	– Connecting an Analogue Device.....	18
	– Channel Selection	18
	– Display Channel Information	18
	– Volume Adjustment.....	18
4	Customising TV Settings	19
	Adjusting the Picture Settings	19
	– Aspect Ratio.....	20
	Adjusting the Sound Settings.....	20
	Editing the Channel List	21
	Viewing your Favourite Channel List.....	22
	Saving a Channel/Source to the My Button (★/Ⓞ).....	22
5	Using the Features	23
	Programme Guide	23
	– Switch On / Off Programme Guide	23
	– Select a Programme	23
	Time Shift Recording onto a USB Storage Device	25
	Recording DTV Programmes onto a USB Storage Device	26
	Timer Programming	27
	Recording Settings.....	28
	Playing Recorded Programmes.....	29
	Red Button + (Interactive services)	30
	– Accessing the Information	30
	Listening to the Radio	30
6	Using the Smart Features	31
	Connecting to the Internet (Wired)	31
	Connecting to the Internet using wireless.....	32
	Selecting Smart TV	33
	– Market.....	33
	– Widget	33
	– My Apps.....	34
	– Organising your apps in My Apps	34
	– Deleting an app from My Apps	34
	– Key Apps	34
	– Searching for Apps.....	34
	– Editing the Smart Wallpaper	35
	Using the Internet.....	36
	– Internet Tool Bar.....	36

7 Other Information.....	37
CI (Common Interface) (DTV Mode).....	37
Time Settings.....	38
Accessibility Settings.....	38
Other Settings.....	39
– HDMI ARC (Audio Return Channel).....	40
Language Settings	41
Sources.....	41
Resetting your TV	42
Parental Settings.....	43
8 Entertainment	44
Connecting a USB Storage Device.....	44
Viewing Videos	45
Viewing Photos.....	46
Listening to Music.....	47
9 Technical Information and Help	48
Maintenance.....	48
Hints and Tips.....	48
Product Fiche and Specifications	50
License Information used with JVC Televisions	52
Remote Control Codes.....	52
– Sky Codes	52
– Virgin Media Codes (TiVo box)	52
– BT Vision.....	52

WE KNOWHOW TO HELP YOU WITH YOUR TV



We want you to be able to enjoy your new TV for many years. From getting it home and setting it up, to helping you get the most out of your new purchase. And in the unlikely event your TV lets you down, we can get it working again in no time.

Here are some of our TV services, but if you want to know more look us up at www.knowhow.com or call us on: 0344 561 1234.

TV SET UP & DEMO

We'll assemble the stand and connect your new TV to the existing equipment. We'll tune your TV so it's ready to watch. We'll also give you a demonstration of your new TV's functions.

TV WALLMOUNT & DEMO

We'll fix your TV to a suitable position on the wall and connect to your existing equipment, so it's all ready to go. We'll use neat wire management so you don't have to look at any untidy cabling and, to complete your fuss-free installation, we'll test and demonstrate your TV's functions.

FREESAT INSTALLATION

We'll set up the Freesat receiver and connect it to your existing dish, TV and cabling. We'll then tune in all available channels.

AERIAL INSTALLATION

We'll supply, install and align a new, high quality aerial and connect it to your Freeview receiver and TV. Then we'll scan and tune in all available digital channels.

HOME CINEMA OR SOUNDBAR INSTALLATION

We'll un-box, connect and set up your new and existing equipment. We'll then configure, calibrate and optimise the equipment. To avoid ugly trailing cables we'll clip them to your skirting board if you'd like us to. Then we'll give you a demonstration.

FAULT & FIX SERVICES

With our Fault & Fix services we can repair a wide range of products at our new state-of-the-art repair lab. This service is available for:

- Computer desktops
- Laptops
- Netbooks
- TVs



KNOWHOW[®]

Lifetime support for Currys PC World customers

WE KNOWHOW TO HELP YOU WITH YOUR TV



We want you to be able to enjoy your new TV for many years. From getting it home and setting it up, to helping you get the most out of your new purchase. And in the unlikely event your TV lets you down, we can get it working again in no time.

Here are some of our TV services, but if you want to know more look us up at www.knowhow.ie or call us on: 1 890 818 575.

TV SET UP & DEMO

We'll assemble the stand and connect your new TV to the existing equipment. We'll tune your TV so it's ready to watch. We'll also give you a demonstration of your new TV's functions.

TV WALLMOUNT & DEMO

We'll fix your TV to a suitable position on the wall and connect to your existing equipment, so it's all ready to go. We'll use neat wire management so you don't have to look at any untidy cabling and, to complete your fuss-free installation, we'll test and demonstrate your TV's functions.

TV & HOME CINEMA INSTALLATION

We'll un-box, connect and set up your new and existing equipment. We'll then configure, calibrate and optimise the equipment. To avoid ugly trailing cables we'll clip them to your skirting board if you'd like us to. Then we'll give you a demonstration.

FAULT & FIX SERVICES

With our Fault & Fix services we can repair a wide range of products at our new state-of-the-art repair lab. This service is available for:

- Desktop PCs
- Laptops
- Netbooks
- TVs



KNOWHOW[®]

Lifetime support for Currys PCWorld customers

Safety Warnings

- Read all the instructions carefully before using the unit and keep them for future reference.
- Retain the manual. If you pass the unit onto a third party make sure to include this manual.
- Check that the voltage marked on the rating label matches your mains voltage.

Damage

- Please inspect the unit for damage after unpacking.
- Do not continue to operate the unit if you are in any doubt about it working normally, or if it is damaged in any way - switch off, withdraw the mains plug and consult your dealer.

Location of Unit

- The unit must be placed on a flat stable surface and should not be subjected to vibrations.
- Do not place the unit on sloped or unstable surfaces as the unit may fall off or tip over.
- The mains socket must be located near the unit and should be easily accessible.
- This unit is designed for indoor, domestic use only.

Temperature

- Avoid extreme degrees of temperature, either hot or cold. Place the unit well away from heat sources such as radiators or gas / electric fires.
- Avoid exposure to direct sunlight and other sources of heat.

Naked Flames

- Never place any type of candle or naked flame on the top of or near the unit.

Moisture

- To reduce the risk of fire, electric shock or product damage, do not expose this unit to rain, moisture, dripping or splashing. No objects filled with liquids, such as vases, should be placed on the unit.
- If you spill any liquid into the unit, it can cause serious damage. Switch it off at the mains immediately. Withdraw the mains plug and consult your dealer.

Ventilation

- To prevent the risk of electric shock or fire hazard due to overheating, ensure that curtains and other materials do not obstruct the ventilation vents.
- Do not install or place this unit in a bookcase, built-in cabinet or in another confined space. Ensure the unit is well ventilated.
- Make sure that there is a gap of at least 10 cm on both sides and a gap of 20 cm at the top.

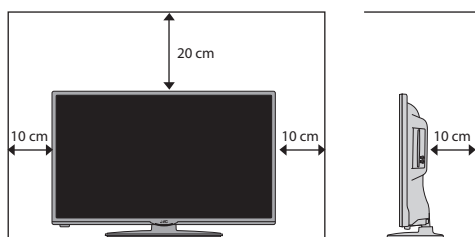

Safety

- Always disconnect the unit from the mains supply before connecting / disconnecting other devices or moving the unit.

- Unplug the unit from the mains socket during a lightning storm.

Mains Cable

- Make sure the unit or unit stand is not resting on top of the mains cable, as the weight of the unit may damage the mains cable and create a safety hazard.
- If the mains cable is damaged it must be replaced by the manufacturer, its service agent, or similarly qualified persons in order to avoid a hazard.

Interference

- Do not place the unit on or near appliances which may cause electromagnetic interference. If you do, it may adversely affect the operating performance of the unit, and cause a distorted picture or sound.

Optimum viewing

- View the unit in moderate light to prevent eye strain. It is recommended to watch the unit from a distance 3-7 times that of the screen height.

LCD screen

- The LCD screen is manufactured using high-precision technology. However, some tiny black points and / or bright points (red, blue or green in colour) may constantly appear on the LCD screen. These points are generated in the manufacturing process and are normal.

Screen Burn

- A characteristic of Plasma and TV Panels is that displaying the same image for a long time may cause a permanent after-image to remain on the screen. This is called screen burn. Most pictures shown on the unit will be constantly moving and fill the screen.
- Examples of images that you need to watch out for are as follows (this is not an all-inclusive list):
 - 1. Black Bars:** If black bars appear at the left / right or top / bottom of the screen, it is recommended to change the format so that the picture fills the entire screen.
 - 2. TV Channel Logos:** e.g. Shopping channel logos and pricing displays - especially if they are bright and stationary. Moving or low-contrast graphics are less likely to cause ageing of the screen.
 - 3. Time Displays**
 - 4. Teletext:** Do not view a stationary page for long periods of time.
 - 5. TV Menus**
 - 6. Pause Mode:** Do not leave the screen in pause mode for long periods of time, e.g. when watching videos.
- To prevent screen burn if viewing any of the above for long periods of time, reduce contrast and brightness when viewing. Once burn-in occurs it will never disappear completely.

Earphones

- Listening to loud sounds for prolonged periods of time may permanently damage your hearing.
- Before putting on earphones, turn the volume down then put the earphones on and slowly increase the volume until you reach a comfortable listening level.

Standby

- The  button on the remote control does not switch off the unit completely. The unit will continue to draw electricity from the mains supply while in standby. In the interests of safety and to avoid unnecessary energy consumption, never leave the unit in standby while unattended for long periods of time, e.g. overnight, while on holiday or while out of the house. Disconnect the mains plug from the mains socket.

Batteries

- Batteries used in the remote control for this unit are easily swallowed by young children and this is dangerous.
- Keep loose batteries away from young children and make sure that the battery holder tray is secure in the remote control. Seek medical advice if you believe a cell has been swallowed.
- Please dispose of batteries correctly by following the guidance in this manual.
- The batteries shall not be exposed to excessive heat such as sunshine, fire or the like.

Supervision

- Children should be supervised to ensure that they do not play with the unit and the remote control.
- Never let anyone especially children push anything into the holes, slots or any other openings in the case - this could result in a fatal electric shock.



The lightning flash with arrowhead symbol, within an equilateral triangle, is intended to alert the user to the presence of uninsulated "dangerous voltage" within the unit's enclosure that may be of sufficient magnitude to constitute a risk of electric shock.



The exclamation point within an equilateral triangle is intended to alert the user to the presence of important operating and maintenance (servicing) instructions in the manual accompanying the unit.

Service

- To reduce the risk of electric shock, do not remove screws. The unit does not contain any user-serviceable parts. Please leave all maintenance work to qualified personnel.
- Do not open any fixed covers as this may expose dangerous voltages.

Maintenance

- Ensure to unplug the unit from the mains socket before cleaning.
- Do not use any type of abrasive pad or abrasive cleaning solutions as these may damage the unit's surface.
- Do not use liquids to clean the unit.
- The wall socket plug is used as a disconnect device, the disconnect device should be readily accessible.
-  This equipment is a Class II or double insulated electrical appliance. It has been designed in such a way that it does not require a safety connection to electrical earth.



To prevent the spread of fire, keep candles or other open flames away from this product at all times.

Thank you for purchasing your new JVC TV.

Your new TV has many features and incorporates the latest technology to enhance your viewing experience. We recommend that you spend some time reading this instruction manual so that you fully understand these features. You will also find some hints and tips to help you resolve any issues.

Read all the safety instructions carefully before use and keep this instruction manual for future reference.

Unpacking the TV

Remove all packaging from the TV. Retain the packaging. If you dispose of it please do so according to local regulations.

The following items are included:

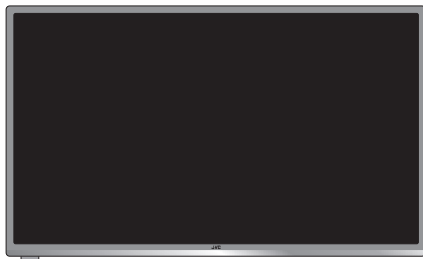

TV



Stand screws x8

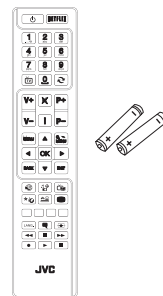

Remote Control /
AAA Batteries x 2

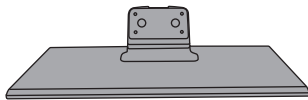

TV Stand



FAV Cable



Instruction Manual

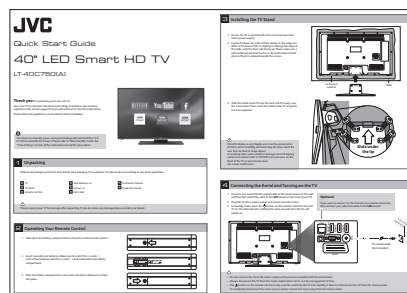

Quick Start Guide

Installing / Removing the Base Stand



The LCD display is very fragile, and must be protected at all times when installing and removing the base stand. Be sure that no hard or sharp object, or anything that could scratch or damage the LCD display, comes into contact with it. DO NOT exert pressure on the front of the TV at any time because the screen could crack.

Fitting the Stand to the TV

1. Ensure the TV is switched off and not connected to the mains power supply.
2. Lay the TV down on a flat surface ideally on the edge of a table so the base of the TV slightly overhangs the edge of the table, with the back side facing up. Please make sure a soft cushioned material (such as a dry bath towel or thick piece of foam) is placed beneath the screen.

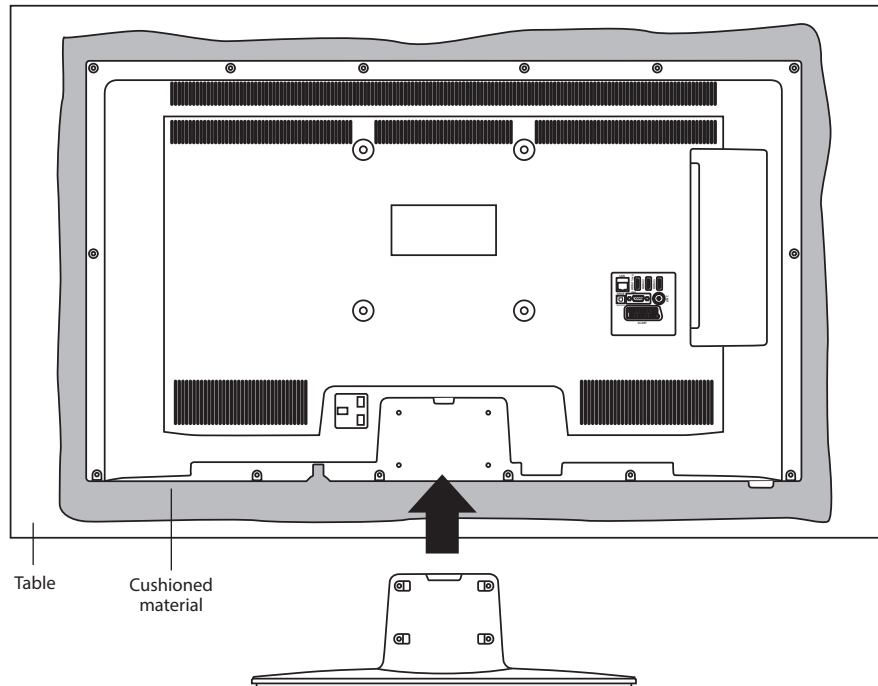

3. Slide the stand under the lip, the neck will fit snugly over the screw holes. Then screw the stand to the TV using the 4 screws supplied.

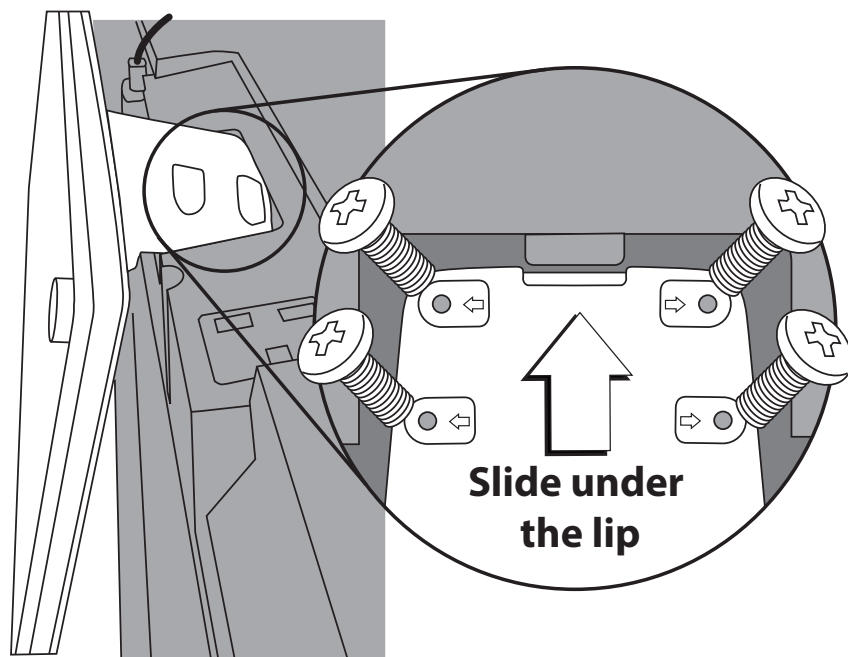

Mounting the TV to a Wall



Remove the stand assembly before mounting the TV onto the wall.

1. Remove the 4 screws from the neck of the stand and detach the stand.

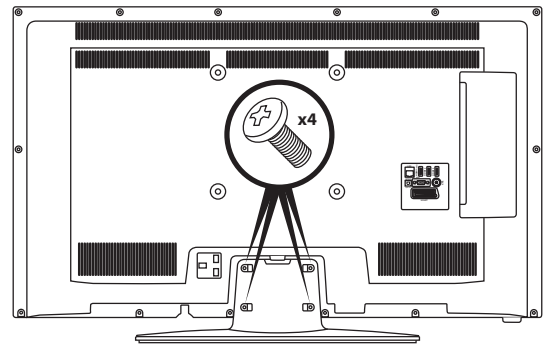

2. This TV is designed to be wall-mounted with a standard 200 mm x 200 mm mounting kit (sold separately) designed for flat-panel TVs. Mount this TV according to the instructions included in the mounting kit. Due to space restrictions, we recommend that you make all connections before mounting on to the wall.

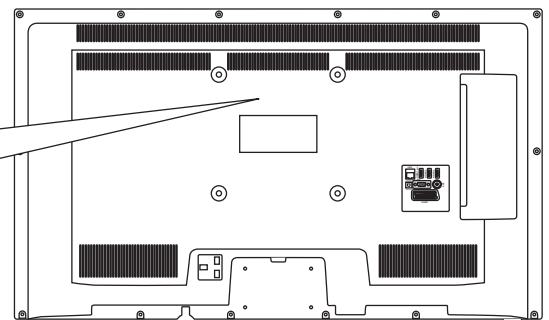
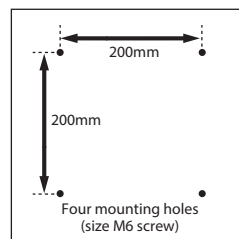

- If you are wall mounting your TV you may wish to buy a 90° HDMI adapter. This will help with your cable management.
- Please read this instruction manual carefully while setting up your TV.
- If you require additional assistance please call our Call Centre on (UK) **0344 561 1234** or (Ireland) **1 890 818 575**. Our Customer Contact Centre is open Monday-Saturday 8am-8pm or Sunday 8am-6pm.

Front / Right Side View and Controls

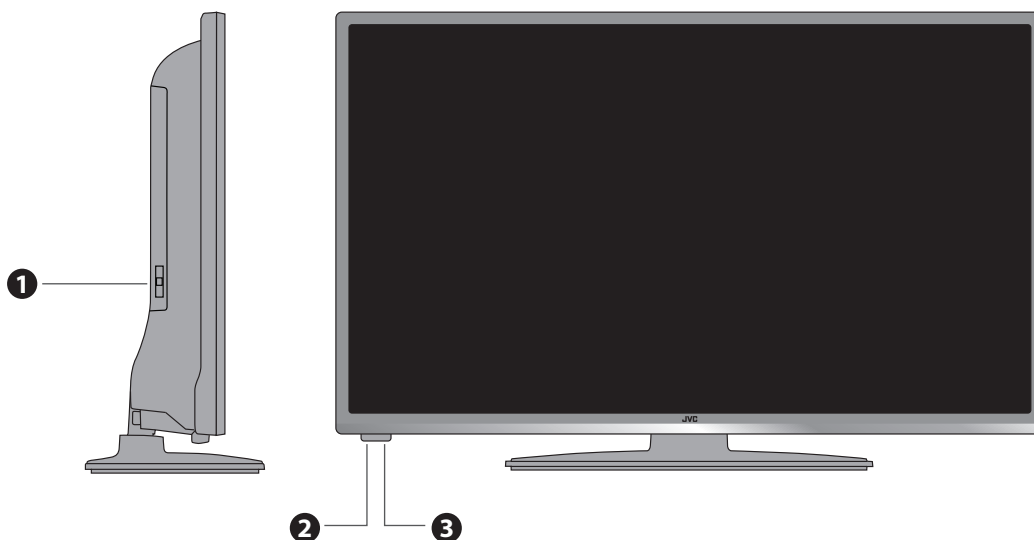

Item	Description
1 MULTI FUNCTION SWITCH	Switches the TV into standby and on. Selects modes (channel,volume, and source).
2 POWER LED	Illuminates when the TV is in standby mode. The LED will blink confirming that a timer recording programme has started in the standby mode.
3 IR (Infrared Receiver)	Receives IR signals from the remote control. Do not put anything near the sensor, as its function may be affected.

Rear View and Sockets

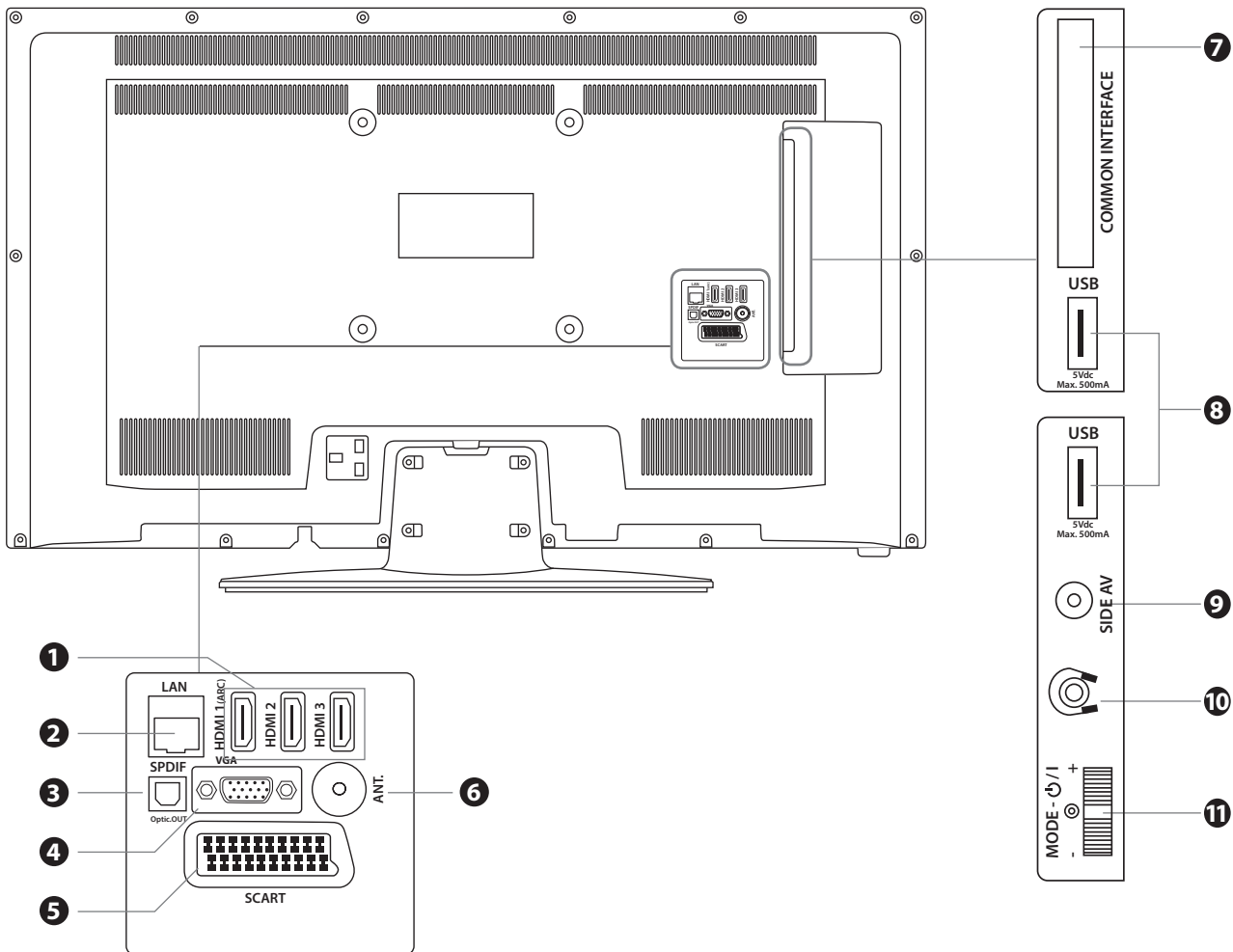

Item	Description
1 HDMI 1 (ARC),2 & 3	Connects to a High-Definition (HD) signal output device, such as a set-top box, blu-ray disc player or AV receiver.
2 LAN	Connects to the an internet router for smart tv features.
3 SPDIF	Optical audio out (Digital) - Connects to an audio device via an optical cable.
4 VGA	Connects to a computer or other devices with a VGA interface.
5 SCART	Connects to a VCR, DVD Player, or other AV device with a SCART output socket. Select SCART 1.
6 ANT	Connects to the aerial socket on the wall with the RF coaxial cable.
7 COMMON INTERFACE	Allows the insertion of a Common Access Module.
8 USB	Allows the insertion of a USB storage device to play video, audio, photo and text files (USB mode) and record DTV programmes on to a USB storage device.
9 SIDE AV	Connects to the Composite VIDEO and AUDIO (L/R) output sockets on external video devices.
10 🎧	Connects to the headphones.
11 MULTI FUNCTION SWITCH	Switches the TV into standby and on. Selects modes (channel,volume, and source).

Installing Batteries in the Remote Control

1. Slide open the battery compartment on the back of the remote control.
2. Insert two AAA size batteries. Make sure to match the (+) and (-) ends of the batteries with the (+) and (-) ends indicated in the battery compartment.
3. Replace the battery compartment cover. Make sure it clicks into place.

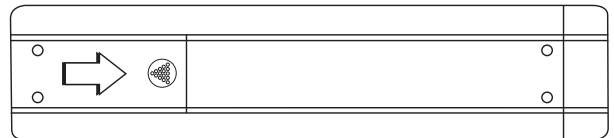
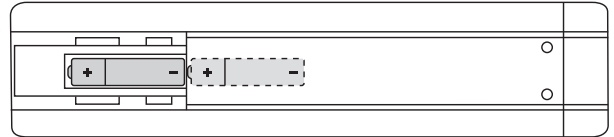
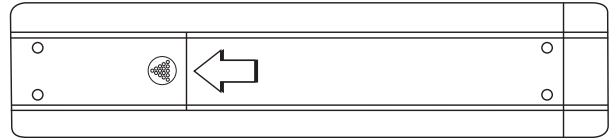

Handling the Batteries

- Improper or incorrect use of batteries may cause corrosion or battery leakage, which could cause fire, personal injury or damage to property.
- Only use the battery type indicated in this manual.
- When the batteries are exhausted, the remote will not function. Replace both batteries at the same time with new ones.
- Do not install new batteries with used ones and do not mix different types of batteries.
- Do not dispose of used batteries as domestic waste. Dispose of them in accordance with local regulations.

Handling the Remote Control





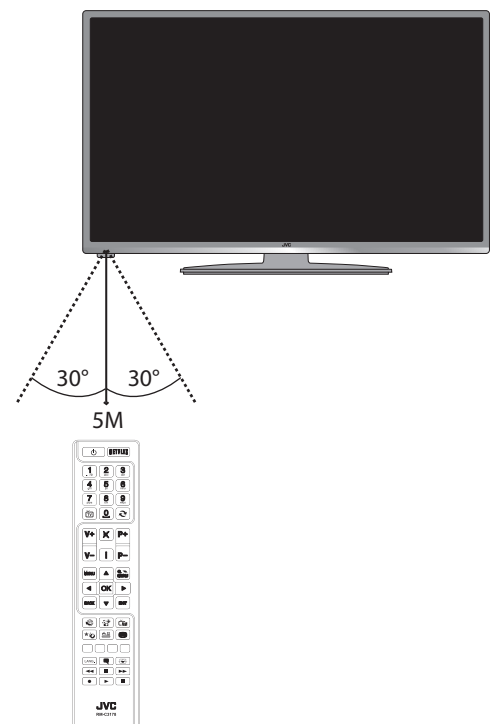

- Take care of your fingernails when you press and hold the battery release tab.
- Do not drop or cause impact to the remote control.
- Do not spill water or any liquid on the remote control.
- Do not place the remote control on a wet object.
- Do not place the remote control under direct sunlight or near sources of excessive heat.
- Remove the battery from the remote control when not in use for a long period of time, as it could cause corrosion or battery leakage and may result in physical injury and/or property damage including fire.

Remote Control Operation Range

Point the remote control at the TV no more than 5 metres from the remote control sensor on the TV and within 60° in front of the TV. The operating distance may vary depending on the brightness of the room.



Remote Control

1.  Switch the TV between on and standby mode.
2. **NETFLIX Button**
Connects to Netflix for viewing online TV shows and films (internet connection required).
3. **0-9 Number Button**
 - Press to select a programme. (TV / RADIO mode)
 - Select numbered items in a menu. (DVD mode)
4.  **(Previous programme/source)**
 - Press to switch between the previous programme or source that was selected.
5. **TV**
 - Press to enter TV mode when viewing other sources.
 - Press to view the channel list when in TV mode.
6. **MUTE**  Mute and restore the sound.
7. **V+ / -**
Adjust the volume.
8. **P+ / P-**
Press to select the next channel up or down the channel list.
9. **i (info)**
Press to see programme information in TV mode.
10. **MENU**
Display the main menu.
11. **Q. MENU**
Press to select the Settings menu.
12. **OK / ◀▶▶▶**
 - Press OK to select or save a setting in menus.
 - Press OK to select the Channel list while watching TV.
 - ◀▶▶▶ Allows you to navigate the OSD menus and adjust the system settings to your preference.
 - ▶▶▶ skip chapters in DVD mode.
13. **BACK**
Press to move backwards through menus.
14. **EXIT**
Press to exit a menu.
15.  Connects to the internet (internet connection required).
16.  **(Media Browser)**
Press to enter the media browser menu, a hard drive will need to be attached to the USB port.
17.  **(Programme Guide)**
Press to view the Programme Guide.

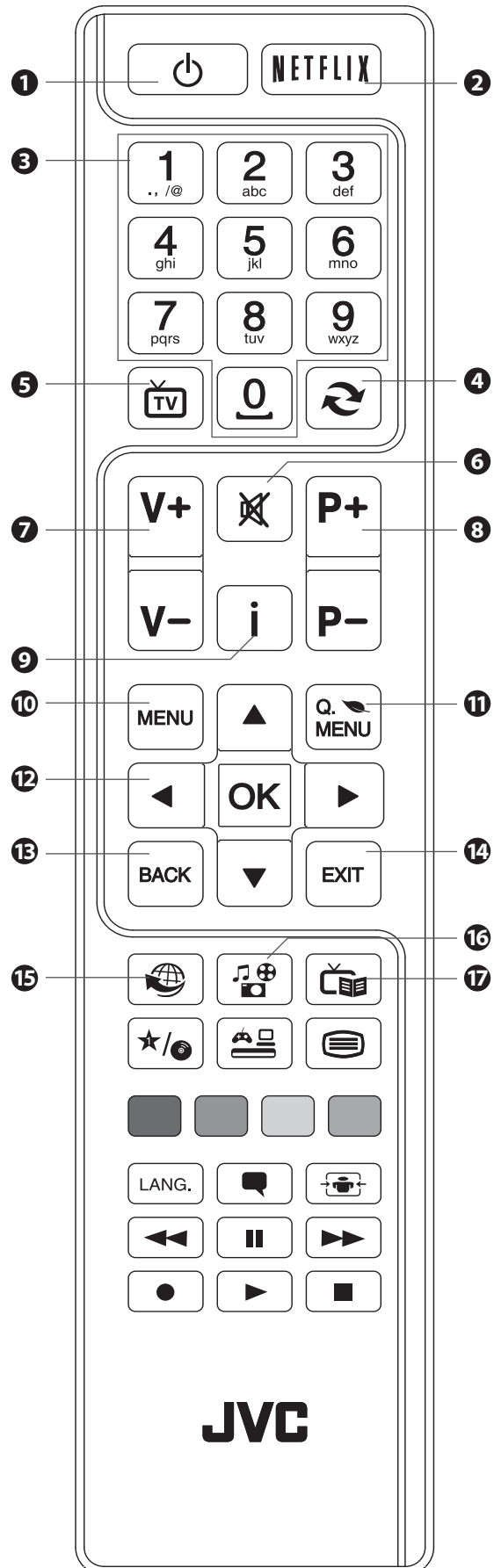

18. ★/📺 (My button 1)

- Press and hold for 5 seconds to set a favourite channel/ source. This button is set to YouTube as a default setting.

19. SOURCE

Press to change the source you are viewing.
TV - SCART - AV - HDMI 1 - HDMI 2 - HDMI 3 - YPbPr - VGA/
PC.

20. 📄

Press to enter teletext if available.

21. COLOURED BUTTONS

Access the TELETEXT items (TV mode) or menu options.

TELETEXT (RED)

Accesses TELETEXT.

22. LANG.

Selects the Current Language menu.

23. 🗨️ (Subtitles)

Press to switch subtitles on and off.

24. 📺 (Aspect ratio)

Press to adjust the aspect ratio of the picture.
AUTO - 16:9 - Subtitle - 14:9 - 14:9 Zoom - 4:3 - Cinema.

25. PLAYBACK and RECORD buttons

- ● starts a recording, continue to press will add more recordings.
- ▶ plays a recording.
▬▬ pauses a recording and starts timeshifting in TV mode if you have a hard drive attached to the USB port.
- ■ stops a recording.
- ◀▶▶▶ searches forwards and backwards when viewing a recording.

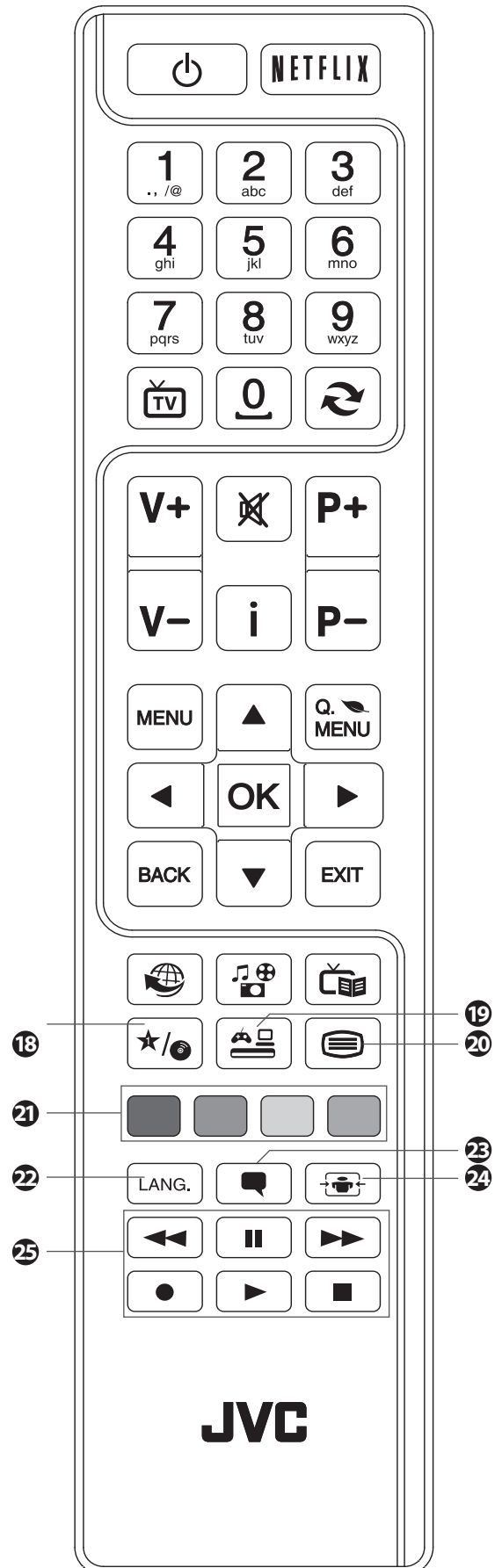

Turning the TV On for the First Time

1. Connect one end of the RF coaxial cable to the aerial socket on the wall and the other end of the cable to the **ANT** socket on the back of your TV.



Do not connect the TV to the mains supply until you have completed all the connections.



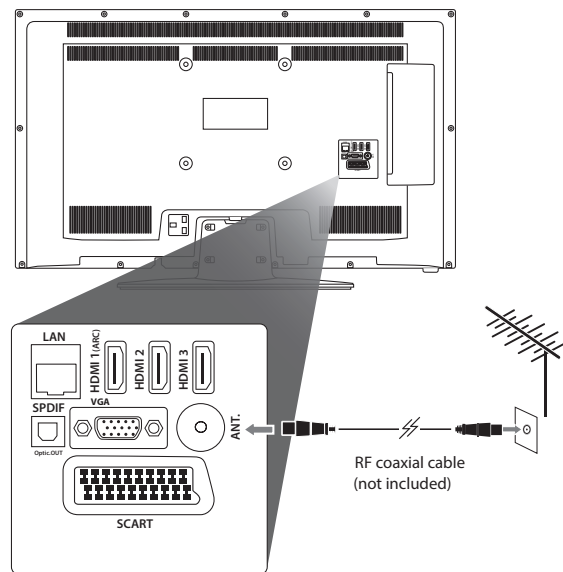



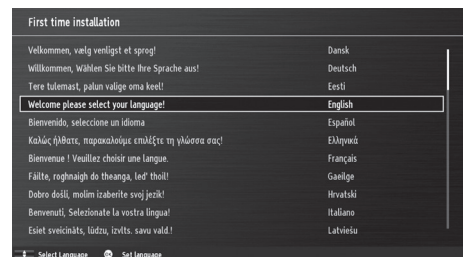

2. Plug the TV into a mains socket and switch on at the mains.
3. In standby mode, press the  button on the remote control to turn the TV on. The LED indicator will flash for a few seconds then the TV will switch on.



- Always disconnect the TV from the mains socket when not in use for a long period of time.
- The  button on the remote control is only used for switching the TV into standby, it does not disconnect the TV from the mains power. To completely disconnect the mains power, please remove the mains plug from the mains socket.

4. The first time you turn the TV on, it will go straight into the **First Time Installation** menu. Please ensure the aerial is plugged in. Press the   buttons to highlight your language then press **OK**.



5. Press the   buttons to select your country.
6. Press the  button to highlight Teletext Language, then press the   buttons to select your language. The majority of people will want this set to West.
7. Press the  button to highlight Scan Encrypted (pay-per-view) Channel, then press the   buttons to select On or Off.









Select Broadcast Type

In this section you can tell your TV what to tune in.

Digital Aerial is TV through your aerial (Freeview) this is automatically set to On for UK customers.

Cable is if you have cable wired directly into your TV NOT through a set top box like Virgin.

Analogue is for analogue devices that you may have connected to your TV e.g. a video recorder.

8. Press the  button to highlight Digital Aerial, then press the   buttons to select On or Off. On will only search for the digital channels.
9. Press the  button to highlight Select favourite network type, then press the   buttons to select Digital Aerial, Digital Cable or Analogue. This can only be chosen if you have selected more than one Broadcast type. Confirm these settings by pressing **OK**.

3 Initial Setup

10. Press the ◀▶ buttons to highlight Home Mode then press **OK**.

To access all the features of your Smart TV you must be connected to the internet. If you do not wish to set up your network connection you can skip this section by pressing ▶▶, however we recommend you set up your network connection now.

WIRED Connection

- If you have connected your ethernet cable to the LAN socket on the back of your TV press the ◀▶ buttons to select WIRED DEVICE. When Network says ENABLED press the OK button.

WIRELESS Connection

You can connect using a wireless connection via your router.

11. Press the ◀▶ buttons to select WIRELESS DEVICE. Wait a few seconds and a list of all wireless networks will be displayed.
12. Press the ▲▼ buttons to select your wireless network then press **OK**.

13. You now need to enter your password, a keyboard will appear. Press the ◀▶ ▲▼ buttons to select a letter/number/symbol and press OK to enter each one. Once you have typed your password highlight OK and press **OK**. The network will now show Connected.

14. Press the **OK** button to continue.

15. Your TV will now start the automatic channel scan.

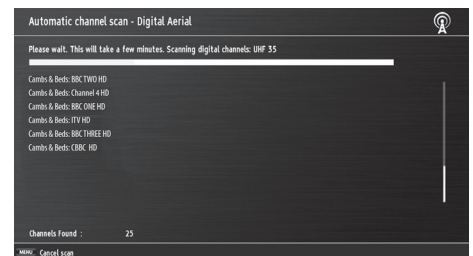
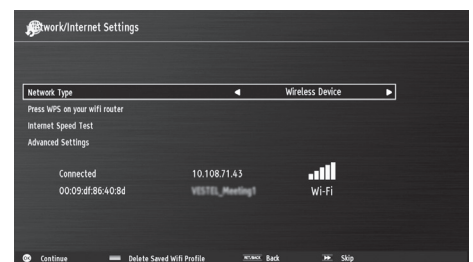
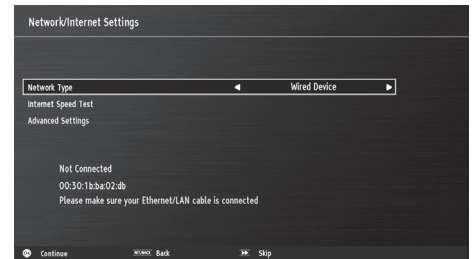
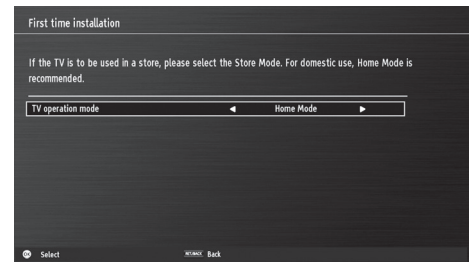

Choose Region (UK only)

During tuning, your TV may have received signals from more than one transmitter. If this has occurred the Choose Region screen will be displayed. This will enable you to select the correct regional transmission for the local news service that you require.

- Press the ▼ button to highlight **Primary region**, then press the ◀▶ buttons to select your Primary Region e.g. England.
- Press the ▼ button to highlight **Secondary region**, then press the ◀▶ buttons to select your Secondary Region e.g. London.
- Press the ▼ button to highlight **Tertiary region**, then press the ◀▶ buttons to select your Tertiary Region e.g. Greater London.
- Press the ▼ button to highlight **Save** then press **OK**.

Your TV is now fully tuned in.

Country Code	This will be shown as UK.
Primary Region	This will show the regional country (England, Wales, Scotland, NI).
Secondary Region	This will allow you to set the region for your local news service on BBC and ITV (London, Beds and Cambs etc).
Tertiary Region	You may receive signals from more than one transmitter within the Secondary Region, (e.g Beds and Cambs may have Luton or Sandy Heath).

16. The Scan statistics screen will now be displayed. This shows the amount of TV and Radio channels that have been tuned in. Press **OK** to exit.

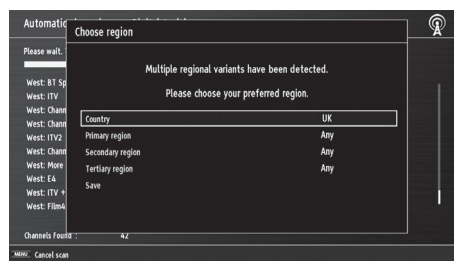

17. The Edit Channel list will appear, press the **EXIT** button to remove this. Your TV is now fully tuned in and ready to use.

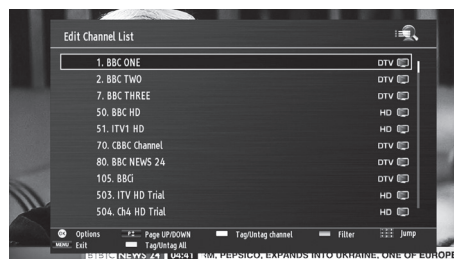

3 Initial Setup

Connecting an Analogue Device

If you have connected an analogue device such as a video recorder via the aerial socket on your TV you will have to tune it in using **Analogue** mode. Ensure the device is switched on before you start the tuning process.

1. Press the **MENU** button, press the ◀▶ buttons to select **INSTALL AND RETUNE** and press **OK**.
2. Select **AUTOMATIC CHANNEL SCAN (RETUNE)** and press **OK**.
3. Press the ▲▼ buttons to select **ANALOGUE** and press **OK**.
4. Press the ◀▶ buttons to select **YES** then press **OK**. The search will automatically start, this will not delete your Digital channels, so don't worry!
5. When the search has finished the **EDIT CHANNEL LIST** will appear. Your analogue channel will be at the end of the channel list.

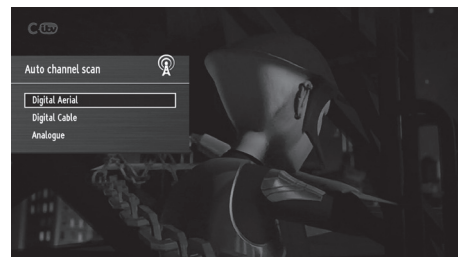

Channel Selection

- Press the **P + / -** buttons on the remote control repeatedly or the **0-9** buttons to select the channel.

Alternative

Press the **OK** button to enter the **Channel List**. Then use the ▲▼ buttons to highlight and select the channel. Press the **OK** button to view the selected channel.

OR

Press the **i** (info) button then the ▲▼ buttons to search for a channel you wish to watch then press **OK**.

- If a locked channel is selected, the password screen will be displayed. Press the **0-9** buttons to enter the password, the channel will then be unlocked (refer to **Locking Channel** for details).
- Press the ↻ button to return to the previously viewed channel.

Display Channel Information

- Press the **INFO** button to view the current information.

Volume Adjustment

- Press the **V +** or **-** button on the remote control or rotate the multi-function switch up or down on the back of the TV.
- If you wish to switch the sound off, press the 🔇 button. You can turn the volume down while your TV is in mute mode. Press the **VOL -** button, you will see the volume level reduce, but you won't hear anything at the moment. To listen to your TV at the new lower level, press the 🔇 button again or **VOL +** button.

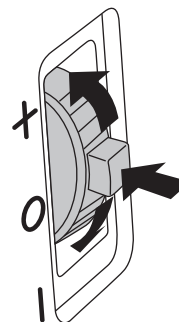

Adjusting the Picture Settings

Allows you to set your preferred picture mode.

1. Press the **MENU** button and then press the ◀▶ buttons to select the **PICTURE** and then press the **OK** button.



2. Press the ▲▼ buttons to select the following picture options and then press the **OK** button.
 - Press the ◀▶ buttons to adjust the levels in the menus.



Picture Mode	Your TV has some pre-set picture modes: Dynamic - Natural - Cinema - Game. The default setting is Standard. You can also manually adjust each mode.	
Contrast	Adjusts the difference between light and dark levels in the picture.	
Brightness	Increases or decreases the picture brightness.	
Sharpness	Adjusts the level of crispness in the edges between light and dark areas of the picture.	
Colour	Controls the colour intensity.	
Energy Saving	The energy saving mode can be adjusted from Custom - OFF - Minimum - Medium - Maximum - Auto - Screen Off. Adjusting this setting will reduce the brightness and power consumption of your TV or turn the screen off altogether.	
Backlight	Adjusts the backlight setting. Only available when Custom Energy Saving is selected above.	
Advanced Picture Settings	Select to have more advanced adjustments to your TV's picture.	
	Dynamic Contrast	Adjusts the contrast to pre-set levels. OFF - LOW - MEDIUM - HIGH
	Noise Reduction	Reduces the noise level of the connected device: Off / Low / Middle / High.
	Colour Temp	Adjusts the colour temperature. NORMAL - WARM - COOL
	Picture Zoom	Adjusts the aspect ratio of the picture. AUTO - 16:9 - SUBTITLE - 14:9 - 14:9 Zoom - 4:3 - CINEMA.
	Film Mode	Film mode can be switched to AUTO or OFF. Auto mode will adjust the frame rate to produce the clearest motion.
	Skin Tone	Adjusts the skin tone from -5 to 5.
	Colour Shift	Adjusts the colour tint from red to green.
	Colour Shift	Select to adjust the picture colour between Red and Green.

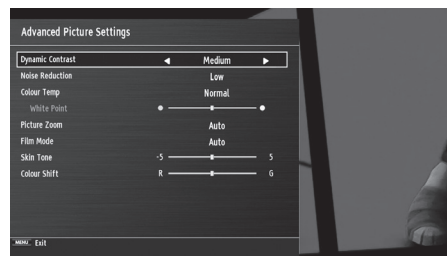

3. Press the **BACK** button to return to the previous menu.
4. Press the **EXIT** button to exit the menu.

4 Customising TV Settings

Aspect Ratio

Allows you to watch the screen in various picture formats: Auto / 16:9 / Subtitle / 14:9 / 14:9 Zoom / 4:3 / Cinema. The default setting is AUTO.

1. Press the  button to scroll through the aspect ratios. The aspect Ratio can also be adjusted in the PICTURE ZOOM section of the Advanced Picture settings menu.

Simply adjust the aspect ratio until you see a picture format you are happy with. This may need to be adjusted when viewing a 4:3 transmission, if you want to fill the screen.

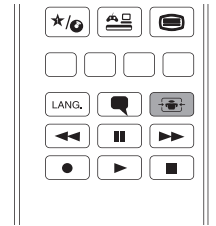



Adjusting the Sound Settings

Allows you to adjust the sound settings on your TV.

1. Press the **MENU** button and then press the  buttons to select **SOUND** and then press the **OK** button.



2. Press the  buttons to select the following sound options and then press the **OK** button to select or press the  buttons to adjust each option's setting.

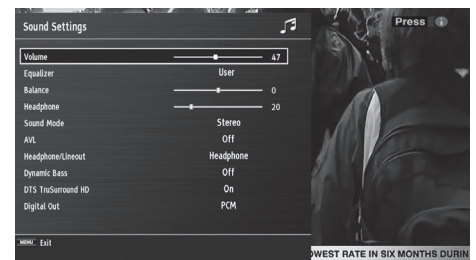

Volume	Adjusts the volume level.
Equalizer	Selects pre-set equalizer modes. Highlight the equalizer mode then press OK to enter the EQUALIZER SETTINGS menu. The equalizer modes are: MOVIE - SPEECH - FLAT - CLASSIC - USER - MUSIC.
Balance	Adjusts the sound level from the left and right speakers.
Headphone	Adjusts the volume level when listening to the TV with headphones. To prevent damaging your hearing set the volume level low and gradually increase the level until you're happy.
Sound Mode	Selects the sound modes. STEREO - DUAL I - DUAL II.
AVL (Automatic volume limiting)	AVL will set the sound level so that its the same across all programmes. So when you change channels the sound level won't change. Set AVL to ON or OFF.
Headphone/lineout	Changes output between Headphone and lineout. Choose 'Headphone' when connecting headphones and 'Lineout' when connecting an audio device to your Headphone socket.
Dynamic Bass	Switches Dynamic bass ON and OFF.
DTS TruSurround HD	Surround Sound can be switched ON or OFF. When switched on you will hear a more spacious sound, to make you feel more immersed in the action on your TV.
Digital Out	Sets the digital audio out type to PCM or COMPRESSED.

3. Press the **BACK** button to return to the previous menu.
4. Press the **EXIT** button to exit the menu.

Editing the Channel List

You can move, delete, edit the name of or lock channels in the EDIT CHANNEL LIST menu.

1. Press the **MENU** button and then press the **▲▼** buttons to select **Edit Channel List** and then press the **OK** button.

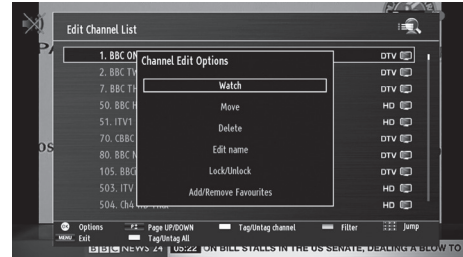

Watch	<ol style="list-style-type: none"> 1. Press the ▲▼ buttons to select the channel that you wish to watch. 2. Press OK, then press the ▲▼ buttons to select WATCH then press OK.
Move	<ol style="list-style-type: none"> 1. Press the ▲▼ buttons to select the channel that you wish to move. 2. Press OK, then press the ▲▼ buttons to select MOVE then press OK. 3. Press the NUMBER buttons to enter the channel number that you want to move the channel to, then press OK. 4. Select YES and press OK. The channel will now have moved positions in the channel list.
Delete	<ol style="list-style-type: none"> 1. Press the ▲▼ buttons to select the channel that you wish to delete. 2. Press OK, then press the ▲▼ buttons to select DELETE then press OK. 3. Select YES and press OK. The channel will be deleted. To get the channel back you will need to tune your TV in again.
Edit name	<ol style="list-style-type: none"> 1. Press the ▲▼ buttons to select the channel that you wish to change the name of. 2. Press OK, then press the ▲▼ buttons to select EDIT NAME then press OK. 3. Press the NUMBER buttons and ◀▶ buttons to enter the new name of the channel, then press OK.
Lock/Unlock	<ol style="list-style-type: none"> 1. Press the ▲▼ buttons to select the channel that you wish to lock. 2. Press OK, then press the ▲▼ buttons to select LOCK/UNLOCK then press OK. 3. Press the NUMBER buttons to enter your PIN number. The lock symbol will appear next to the channel. To view the locked channel you will now have to enter your PIN number.
Add/Remove Favourites	<ol style="list-style-type: none"> 1. Press the ▲▼ buttons to select the channel that you wish to add or remove from your favourites. 2. Press OK, then press the ▲▼ buttons to select ADD/REMOVE FAVOURITES then press OK. 3. Press the ▲▼ buttons to select the list you want to add the channel into. 4. Press the ◀▶ buttons to select YES or NO, then press OK. The list number will now appear next to the channel number to show its been added to your favourites.

Viewing your Favourite Channel List

1. Press the **MENU** button and then press the **▲▼** buttons to select **Channel List** and then press the **OK** button.
2. Press the **BLUE** button to view the CHANNEL LIST FILTER.
3. Press **▲▼** buttons to select FAVOURITES, then press the **◀▶** buttons to select the favourite list 1-4 that you want to view. The channel list will now just show you your favourite channels.

To see the full list of channels again select NONE under Favourites.

Saving a Channel/Source to the My Button (★/Ⓞ)

You can save your favourite TV channel or source to both of the My Buttons.

1. Select the channel or source that you want to save to the My Button.
2. Press and hold **★/Ⓞ** for 5 seconds. The message 'My Button Set' will appear on the screen when the channel/ source is stored.



- If you perform a first time installation at any time the My Buttons will be reset to youtube for button 1.



Programme Guide



This system has a Programme Guide to help you navigate through all the possible viewing options.

The Programme Guide supplies information such as programme listings, start and end times for all available services. In addition, detailed information about the programme is often available in the Programme Guide (the availability and amount of programme information will vary, depending on the particular broadcaster).

This function can be used only when the Programme Guide information is broadcast by broadcasting companies.

The Programme Guide displays the programme details for the next 7 days.

Switch On / Off Programme Guide

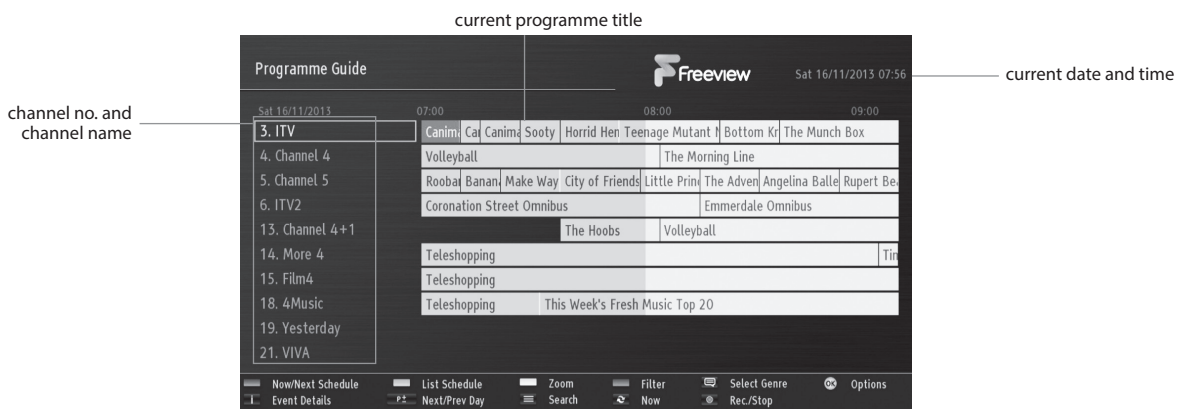

1. Press the  button to view the Programme Guide.
2. Press the  button or the **EXIT** button again to switch off Programme Guide and return to normal TV viewing.



Select a Programme







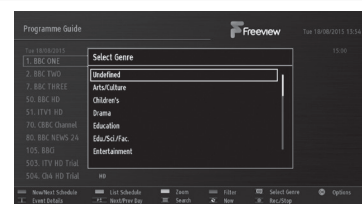
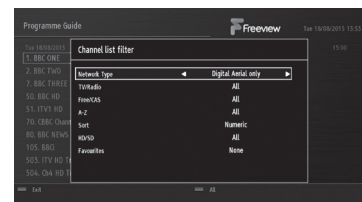

Press the **▲▼** buttons to select the desired channel and then press the **◀▶** buttons to select the desired programme. Press the **OK** button to confirm.

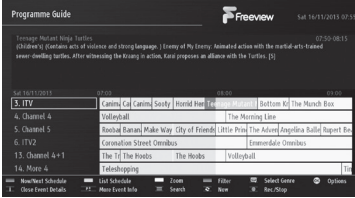
Button Functions in a 7-Days Guide

Remote Control Button	Function
RED (Now/Next Schedule)	Press the RED button to view a list of current programmes and the next programmes. Press the YELLOW button to return back to the Timeline schedule.
GREEN (List Schedule)	<ol style="list-style-type: none"> 1. Press the GREEN button to view the List Schedule. It will list the next programmes that are on the selected channel. 2. Press the RED button to see the previous programmes or press GREEN to see the next programmes in the list.
YELLOW (Zoom)	Press the YELLOW button to condense the programme information so you can see more programmes for your selected day.
BLUE (Filter)	<p>Press the BLUE button to select the CHANNEL LIST FILTER. Here you can filter the Programme Guide to make it easier to find your programmes.</p> <ul style="list-style-type: none"> • Network Type - DIGITAL AERIAL - DIGITAL CABLE • TV/Radio - Filter ALL - TV ONLY - RADIO ONLY - TEXT ONLY. • Free/CAS - Filter ALL - FREE - ENCRYPTED • A-Z - Filter using the first letter of the programme A - B - C... • Sort - Filter NUMERIC or ALPHABETIC • HD/SD - Filter for High Definition or Standard Definition. • Favourites - NONE - FAVOURITES 1 - 2 - 3 - 4
 (Select Genre)	<ul style="list-style-type: none"> • Press the  button to select a Genre. Once a Genre is selected the programmes in that Genre will be highlighted in blue. Press the ▲▼◀▶ until you see the highlighted programmes.

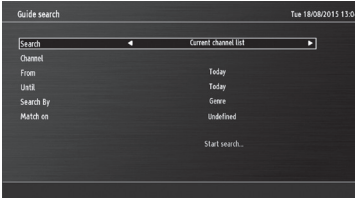

5 Using the Features

<p>i (Event Details)</p>	<p>Press i to see a brief description of the selected programme.</p>	
<p>P+/-</p>	<p>Press the P+ / P- buttons to view the next or previous days programmes.</p>	
<p>OK (Options)</p>	<p>When a programme is highlighted press the OK button to see the EVENT OPTIONS menu.</p> <ul style="list-style-type: none"> • Select Channel - Select this option to view the selected programme. • Record - Select this option to set the selected programme to automatically record. The programme will be highlighted in red to show a recording is set. • Set Timer on Event - Select this option to set the selected programme to switch on when the programme starts. The programme will be highlighted in yellow to show a 'timer on event' is set. <div style="border: 1px solid gray; padding: 5px; text-align: center;">  <p>Not all of the event options may be available, it depends if a programme has started and it a USB storage device is connected.</p> </div>	
<p> (Search)</p>	<p>Press the  button to enter the GUIDE SEARCH menu. Use this menu to search the Programme Guide for a specific programme or type of programme on a particular day.</p> <ul style="list-style-type: none"> • Search - This is the field that you wish to search though. Select ALL CHANNELS - ALL TV CHANNELS - ALL RADIO CHANNELS - CURRENT CHANNEL LIST - SINGLE CHANNEL. • Channel - If you have selected SINGLE CHANNEL you can now select the channel you wish to search. • From - Select the day you want to search from. To select from your current day select TODAY. • Until - Select the day you want to search until. Make sure this day is after the 'FROM' day. • Search By - Select GENRE to search by genre or select NAME MATCH to manually type in the name of the programme you are searching for. • Match on - If you selected GENRE above, press OK to open the SELECT GENRE menu. If you selected NAME MATCH above then press the NUMBER buttons to enter the name of the programme you are searching for. • Start search - Select START SEARCH and then press OK to start searching. A list of search results will appear on screen, this may take a few seconds to generate. 	 <p style="text-align: center;">Search Results</p> 
<p> (Now)</p>	<p>Press the  button to automatically go back to the programme that is on now.</p>	
<p>● (Record/Stop)</p>	<p>Press the ● button to record the selected programme, to show a recording is set it will be highlighted red. To remove the record function, highlight the programme then press ●.</p>	

Time Shift Recording onto a USB Storage Device

This function allows you to pause live TV. The picture will pause and the programme will begin recording so you don't miss any of the programme. You will have to have a USB storage device attached to the USB socket for Time Shift Recording to work.



- Time Shift Mode and Recording functions may not work if the signal strength is weak.
- Stop the time shift function before switching to another input source.



If the transfer rate of the USB storage device is too slow for recording or time shift function, a warning statement will be shown on the screen. If this happens, please upgrade your USB storage device. The minimum transfer speed is 5MB/s.

While watching your TV, you may press the **||** button to pause the live programme if you want to go out for a while (e.g. going to the bathroom / kitchen). "||" will show on the screen.

When you have returned, press the **▶** (PLAY) button to play the missed broadcast programme. "▶" will briefly show on the screen.

The video and sound may have a little bit of delay or be out-of-sync for a few seconds when the unit starts to playback the missed programme. It will soon turn to normal.

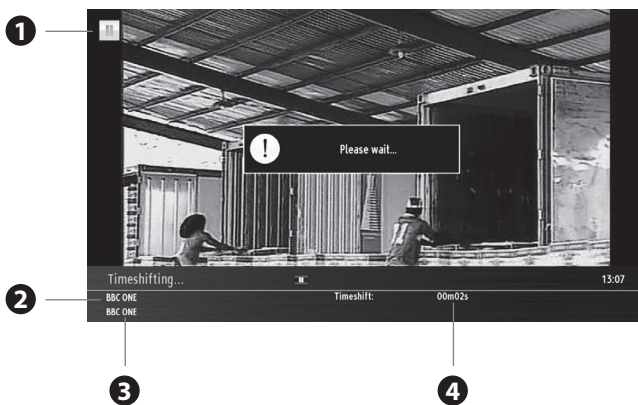

The 'PVR Time Shift Progress Bar'

- 1 Indicates the status of the currently displayed video (▶ / || / ◀ / ▶)
- 2 Channel name being recorded.
- 3 Programme name being recorded.
- 4 Indicates the amount of time recorded.

Using the Remote Control

You can shift playback to any point of the virtually recorded programme.

◀◀ or ▶▶	<p>When playing,</p> <ul style="list-style-type: none"> • Press the ▶▶ button repeatedly to speed up - x 2 / x 4 / x 8 / x 16 / x 32. • During fast forward press the ▶ (PLAY) button to return to normal playback. <p>When paused</p> <ul style="list-style-type: none"> • Press the ▶▶ button repeatedly to view in slow motion - x 1/4 / x 1/2 / x 1 (normal playback).
	<ul style="list-style-type: none"> • During playback, press the button to display a still screen and then press the button again or the ▶ (PLAY) button to resume playback.
OK	When timeshifting press the OK button to play or pause the recording.
■	If you want to exit timeshifting, press the ■ button.

Recording DTV Programmes onto a USB Storage Device

Use this function to record the DTV programme you are watching on the main screen and save it for future viewing.

The recording from timer programme or direct recording may have a little bit of delay when it starts to record the broadcast programme.

Please make sure the USB device is inserted. If not, a warning message will pop up. You can only record the programme that you are currently watching.

1. Press the **●** button to record the programme that you are currently watching.



The recording screen will briefly appear. It will display the channel and programme name and the minutes of that programme left.

2. To stop a recording press the **■** button, then select YES and press **OK**.



Recording will stop automatically when the disk is full.



You can turn off the TV while recording. Press the **⏻** button. The standby indicator light will flash to show the TV is still recording.



Timer Programming

This function is used to perform scheduled recordings or timers (will switch the programme on when it starts).

The recording from timers or direct recording may have a little bit of delay when it starts to record the broadcast programme.

Please make sure the USB device is inserted. If not, a warning message will pop up.

1. Press the **MENU** button then press the ◀▶ buttons to select **SETTINGS** and press **OK**.



2. Press the ▲▼ to highlight **TIMERS** then press **OK**.

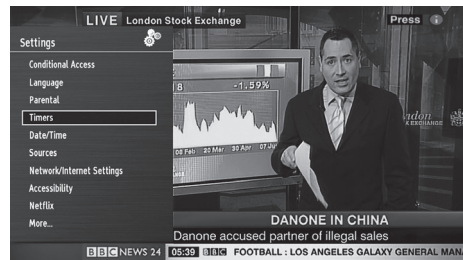

3. Press the **YELLOW** button to add a timer. The **ADD TIMER** menu will be displayed.



4. Adding the timer

Press the ▲▼ to select each setting below.

Timer Type	Press the ◀▶ buttons to select RECORD or TIMER . RECORD - Will record a programme TIMER - Will automatically switch to the selected programme when it starts.
Channel	Press the ◀▶ buttons to select the channel.
Record Type	Not adjustable.
Date	Press the ◀▶ buttons and the NUMBER buttons to set the date.
Start	Press the ◀▶ buttons and the NUMBER buttons to set the start time.
End	Press the ◀▶ buttons and the NUMBER buttons to set the end time.
Duration	Set automatically.
Repeat	Press the ◀▶ buttons to set the recording to record ONCE - DAILY - WEEKLY or just WEEKDAYS .
Change/Delete	Press the ◀▶ buttons to select ALLOWED or DISALLOWED ALLOWED - You allow anyone to change or delete the recording. DISALLOWED - You will have to enter the PIN code to change or delete the recording.
Playback	Press the ◀▶ buttons to select USE PARENTAL SETTINGS , DISALLOWED or ALLOWED . You will need to enter the PIN number if you want to play a recording when you select 'use parental settings and disallowed'.

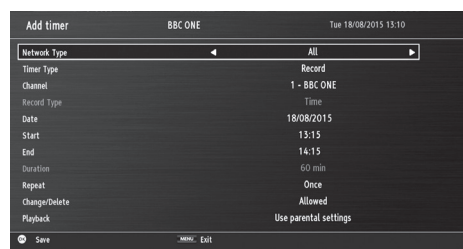

- When the preset time is reached, the TV will start recording automatically.
- If a programme recording starts when the TV is in standby mode, the LED indicator will flash.

Recording Settings

The recording settings menu allows recording adjustment. You can add time to the start and end of each recording and set and maximum recording time for timeshifting.

You can also select how you want your TV to automatically delete your recordings so you won't run out of space on your USB storage device.

1. Press the  button then press the ◀▶ buttons to select SETTINGS and press **OK**.
2. Press the ▲▼ to highlight RECORDING SETTINGS then press **OK**. The Recording settings menu will be displayed.
3. Press the ▲▼ to select each setting below.

Start early	Press the ◀▶ buttons to select an amount of time you would like the recording to start before the programme starts (max 10 mins).
End late	Press the ◀▶ buttons to select an amount of time you would like the recording to end after the programme finishes (max 10 mins).
Max Timeshift	Press the ◀▶ buttons to select a maximum amount of time you would like the timeshift recording to record (from 10 mins to 2 hours).
Auto discard - Discard	Press the ◀▶ buttons to select the recording that you want to automatically delete when the USB storage device is full. NONE - OLDEST - LONGEST - SHORTEST
Auto discard - Unplayed	Press the ◀▶ buttons to select to delete the played or unplayed recordings.
Hard disk information	Select to see the Hard disk information.
Format Disk	Select to format the USB storage device, you will need to enter your PIN number. Any previous recordings will be deleted.



Playing Recorded Programmes

All of your recording are stored in the Media Browser, in the

1. Press the **MENU** button, then press the **▲▼** buttons to select MEDIA BROWSER then press **OK**.



2. Press the **◀▶** buttons to select RECORDINGS then press **OK**.



3. The RECORDING menu will be displayed. Press the **▲▼** buttons to select the recording that the want to watch then press **▶** (PLAY).

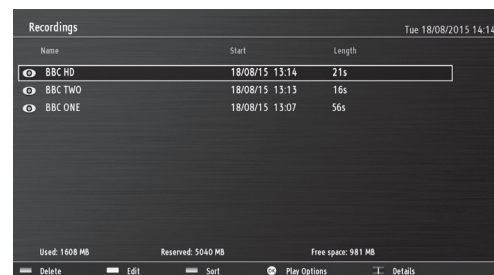

Recordings Library Controls

RED button (Delete)	<ul style="list-style-type: none"> • Press the ▲▼ buttons to select the recording that you wish to delete then press the RED button. You will be asked if you want to delete the recording, select YES then press OK.
GREEN button (Edit)	<ul style="list-style-type: none"> • To edit the recording permissions press the GREEN button. You can allow or disallow the recording to be deleted or played back.
BLUE button (Sort)	<ul style="list-style-type: none"> • Press the BLUE button to see the SORT BY menu. Press the ▲▼ buttons to select your sorting option then press OK. NAME - NAME, REVERSED - START, OLDEST FIRST - START, NEWEST FIRST - LENGTH, SHORTEST FIRST - LENGTH, LONGEST FIRST - UNVIEWED FIRST - VIEWED FIRST.
OK (Play Options)	<ul style="list-style-type: none"> • Press the ▲▼ buttons to select the recording that you wish to play then press OK. The PLAY OPTIONS menu will be displayed. PLAY FROM START - This option will play the recording from the start. RESUME - This option will play the recording from the point you last watched the recording. PLAY FROM OFFSET - This option allows you to select a start point into the recording.
▶ (Play)	Press the ▶ (play) button to play the recording.
i	Press the i button to see information about the recorded programme.

Red Button + (Interactive services)

Red button + services are available on BBC TV and Radio channels. The services are gradually changing to an internet based service rather than the conventional over air (though your aerial). To make the most out of the Red Button + services make sure your TV is connected to the internet. You can also access BBC iPlayer through RED button +.

Accessing the Information

- In DTV mode press the  button to display the main information page. You may see slightly different looking pages depending if your TV is accessing the page over air or via the internet.

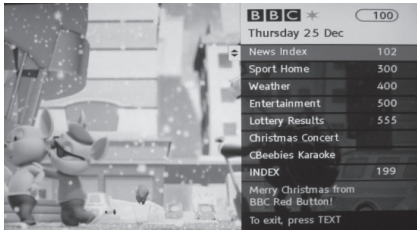

Over Air Red Button + Services



Internet Red Button + Services



iPlayer via the Red Button + Services

- Follow the instructions on the interactive services page and move around the page by pressing , **OK**, **RED**, **GREEN**, **YELLOW**, **BLUE** or **0-9** buttons etc.

To change digital teletext services, you will need to exit the current text service and change channels. Then enter the text service on the newly selected channel.

Alternative

You may press the **RED** button to display the interactive services information when you see a red "press ●" logo in the top right corner of the screen (e.g. BBC services). This will now display the Red Button menu and available information categories.



To access the pages, use navigation buttons to highlight item required and press the **OK** button to select.

Follow on screen prompts for other functions.

- Press  or the **EXIT** button to exit.

Listening to the Radio

You can listen to radio stations through your TV.

- Press the  button to select the PROGRAMME GUIDE.
- Press the **BLUE** button to select the filter.
- Press the  buttons to select RADIO ONLY then press **OK**.
- Press the  buttons to select your desired radio station then press **OK** to listen to it.
- The radio stations are from channel position 700, you can also select them using the **P+ / P-** buttons or the **NUMBER** buttons.

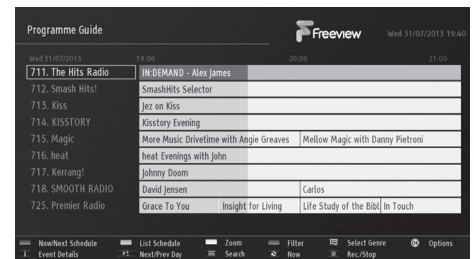

Connecting to the Internet (Wired)

For the fastest and most reliable connection we recommend connecting your TV to the internet using an ethernet cable.

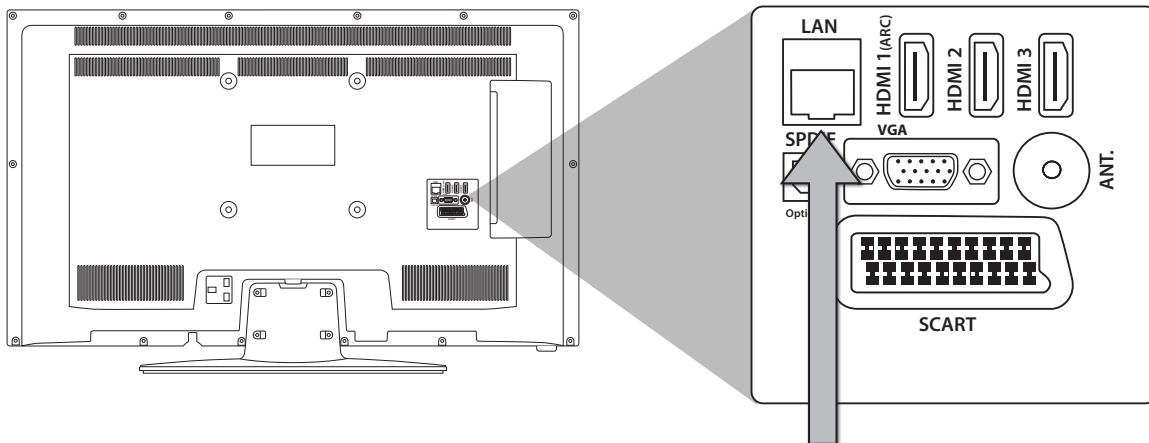

Connect your ethernet cable
to the LAN socket

1. Press the **MENU** button then press ◀▶ to select **SETTINGS** then press **OK**.
2. Press the ▲▼ buttons to select **NETWORK/INTERNET SETTINGS** then press **OK**.
3. Press the ◀▶ buttons to select **wired**. The word **connected** will appear to show you are now connected to the internet.

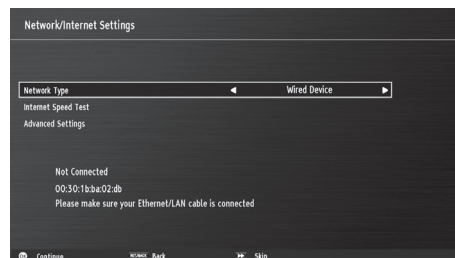
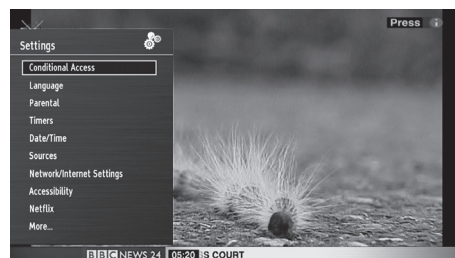

Connecting to the Internet using wireless

You can connect your TV to your router using the built in wireless connection. This may not always give you the fastest connection speed but may be the most convenient connection method.

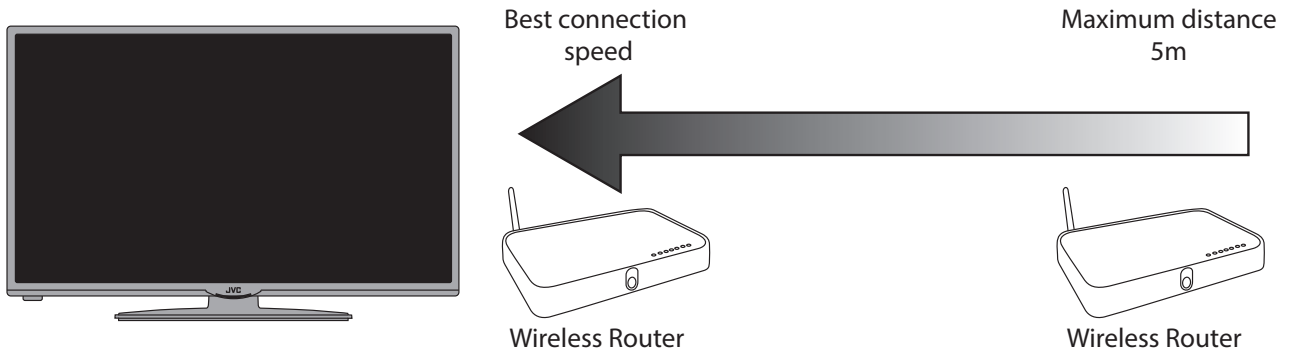

WIRELESS Connection

- If you want to connect using a wireless connection press the ◀▶ buttons to select WIRELESS DEVICE.

You have two options for connecting to your wireless network. By entering your router PASSWORD or using the WPS button.

PASSWORD option

- Press the ◀▶ buttons to select WIRELESS DEVICE.
- Press the **YELLOW** button to scan for your wireless network (router). A message saying 'Please wait' will appear while your TV searches for all the wireless networks in your area.
- Press the ▲▼ buttons to select your wireless network then press **OK**. You now need to enter your password, a keyboard will appear. Press the ◀▶ ▲▼ buttons to select a letter/number/symbol and press **OK** to enter each one. Once you have typed your password highlight **SAVE** and press **OK**. The network will now show **ENABLED**.
- Press the **OK** button to continue.

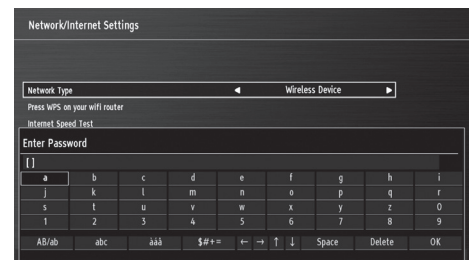
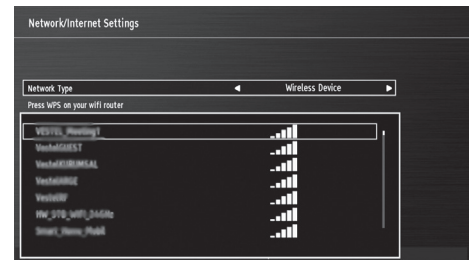
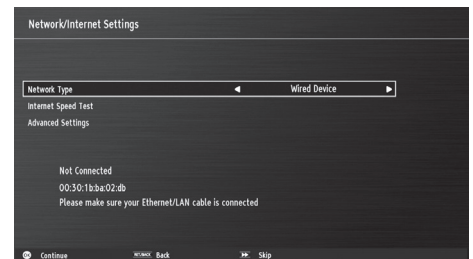

Selecting Smart TV

1. Press the  button to enter smart mode.

The loading symbol  will appear in the top left corner of the screen while smart mode is loading. Please be patient it may take a few seconds to load the smart mode.





Your TV will update automatically, so the amount of apps available may vary from time to time. The app content may also be updated.



The Smart screen is broken up into 4 sections. Market, Widget, My Apps and Key Apps. Each section can be accessed by pressing one of the **COLOURED** buttons.

Market

The Market shows all the Apps that are available on your TV. You can either add them to My Apps section or open the App directly from the Market.

1. Press the **RED** button to open the Market. The TV picture will change to a list of Apps.
2. The Apps can be viewed in 5 different tabs. 1 - New Apps, 2 - Services, 3 - Videos, 4 - TV Apps, 5 - All Apps. Press the **NUMBER** buttons to select these tabs.
3. To select an App press the    to highlight the App then press **OK**.
If the App is already in your My Apps section you will be given the option to GO TO APP or REMOVE. Select GO TO APP to run the App. Select REMOVE if you wish to remove it from your My Apps section.
If the App isn't already in your My Apps section you will be given the ADD option. Select ADD to add the App into your My Apps section.



Widget

The Widget section shows your Facebook and Twitter feeds if you are logged in.

1. Press the **GREEN** button to select the Widget section.
2. Repeatedly press the **GREEN** button to switch between Facebook and Twitter.



My Apps

The My Apps section shows all of your Apps that you have added to this section. They can be arranged into any order, to make it easy for you to find your Apps.

1. Press the **YELLOW** button to Select the My Apps section.
2. Press the ◀▶ ▲▼ buttons to highlight the app that you would like to open, then press **OK**.



Organising your apps in My Apps

You can change the order of the apps to suit your personal use.

1. Press the **YELLOW** button to make sure you are in the My Apps section.
2. Press the ◀▶ ▲▼ buttons to highlight the app that you would like to move.
3. Press the **NUMBER 1** to open the OPTIONS menu. Select MOVE and press **OK**.
4. The App logo will now animate, press the ◀▶ ▲▼ buttons to move the App to its new location, then press **OK**.



Deleting an app from My Apps

1. Press the **YELLOW** button to make sure you are in the My Apps section.
2. Press the ◀▶ ▲▼ buttons to highlight the app that you would like to delete.
3. Press the **NUMBER 1** to open the OPTIONS menu. Select REMOVE and press **OK**. The app will be deleted from the My Apps section, but will remain in the Market section if you want it back in the future.

Key Apps

The Key Apps are the apps that are the most commonly used. These app can't be changed or deleted. You can also access the Market section from Key Apps.

1. Press the **BLUE** button to make sure you are in the Key Apps section.
2. Press the ◀▶ buttons to highlight the app that you would like to use.



Searching for Apps

Rather than scrolling through lists of Apps to find the App you are looking for you can type in a word and a list of apps related to your search will be displayed, e.g. type Weather and all the weather apps will be displayed.



Editing the Smart Wallpaper

You can select different background picture for the smart screen.

1. Press the **NUMBER 2** button, highlight EDIT WALLPAPER and press **OK**.
2. A list of wallpapers will be displayed, press the ◀▶▲▼ buttons to highlight the wallpaper you would like, then press **OK**.
3. The display will say its 'SAVED SUCCESSFULLY' and when the smart screen returns the new wallpaper will be in the background.



Selection of wallpapers

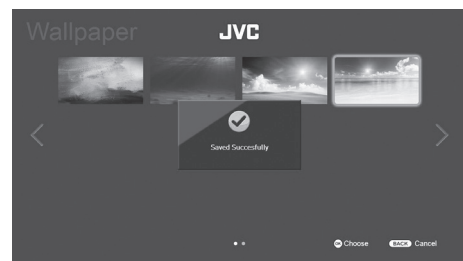

New wallpaper

Using the Internet



You can surf the internet on your TV in just the same way you would on a PC.

1. In smart mode press the ◀▶▲▼ buttons to highlight the Internet app then press **OK**. The internet home screen will appear.

The home screen has a selection of webpages already stored. You can also go directly to a website.

2. To enter a website address or whatever you wish to search for, press the ◀▶▲▼ buttons to move the cursor arrow over the search bar at the top of the screen then press **OK**. A keyboard will appear on screen.
3. Enter the website you wish to find by pressing the ◀▶▲▼ buttons to move the cursor arrow over each letter then press **OK**.

Once you have typed in the website address, you have two options you can go directly to the website or search Google for the site.

- Press  to go directly to the website.
- Press  to search in Google for the website.



The last few websites you visited will be displayed under the search bar on the keyboard.

4. To click on links within a webpage move the cursor around using the ◀▶▲▼ buttons then press **OK**.
5. To scroll up and down the page press the **P+** and **P-** buttons.



Internet Tool Bar



1	Back and Forward button	Press to navigate backwards and forwards through webpages.
2	Refresh button	Press to refresh/reload the page.
3	Home Button	Press to return back to the Home screen.
4	Search bar	Select to enter a new website or to start a new search.
5	Add to Bookmarks button	Press to add a bookmark and save the website so you can quickly access it next time you want to visit the site. You have two options where to save the bookmark. <ul style="list-style-type: none"> • If you select the STAR icon it will be added into your bookmark folder. • If you select the BUTTON icon it will be added to the home screen. You will then see a small version on the home screen, select the location you want to save the bookmark in and press OK.
6	History button	Press to view your internet history. If you would like to clear the history click on CLEAR HISTORY then confirm by clicking on OK. This will also remove the last searched site on the search keyboard.
7	Bookmarks button	Press to select a list of all the bookmarked websites. Click on a bookmark to go to that site. If you want to remove a bookmark click on the red 'X' and then click on OK.
8	Zoom button	Press to zoom in and out of a webpage. <ul style="list-style-type: none"> • Press the magnifying glass with the '+' inside to zoom in to the page. • Press the magnifying glass with the '-' inside to zoom out of the page. • Press the magnifying glass to return to the original size.
9	Settings button	Press to access the Settings menu where you can Clear Cookies or Clear All Browser Data.

CI (Common Interface) (DTV Mode)

The common interface allows the use of a Common Access Module to enable you to view scrambled (pay-per-view) services. These services are provided by TopUp TV (UK only) and others. The Common Access Module and viewing card can be obtained from the service provider.



Do not repeatedly insert or remove the Common Access Module as this may damage the interface and cause a malfunction.

This feature is not available in all countries.

To insert the Common Access Module

1. Before you insert the Common Access Module, ensure that the TV is switched off and the viewing card is inserted **in accordance with the Service Provider's instructions**.
2. Insert the Common Access Module into the slot. Flip it to the other side and try again if you feel resistance.
3. Switch the TV on.

To remove the Common Access Module

1. Before you remove the Common Access Module, ensure that the TV is switched off at the mains.
2. Pull the Common Access Module from the slot.
3. Switch the TV on.

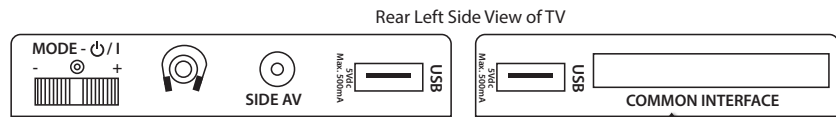

CI (Common Interface)

Allows the Common Access Module to be inserted and access the content that has been encrypted.

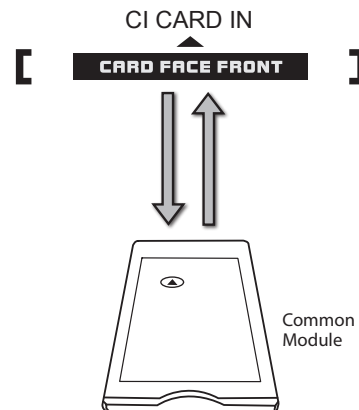

Time Settings

The time and date are set automatically. You can manually change the time zone if required.

1. Press the **MENU** button and then press the ◀▶ buttons to select the **SETTINGS** and then press the **OK** button. The SETTINGS menu will be displayed.
2. Press the ▲▼ buttons to select DATE/TIME and then press the **OK** button.
3. Press the ▲▼ buttons to select TIME SETTING MODE and then press the ◀▶ buttons to select MANUAL.
4. Press the ▲▼ buttons to select TIME ZONE then press the ◀▶ buttons to select your desired time zone.
5. Press the **MENU** button to exit the menu.



Accessibility Settings

This setting allows you to switch the Hard of Hearing mode on and off and switch Audio Description on and off.

1. Press the **MENU** button and then press the ◀▶ buttons to select the **SETTINGS** and then press the **OK** button. The SETTINGS menu will be displayed.
2. Press the ▲▼ buttons to select ACCESSIBILITY SETTINGS and then press the **OK** button.



Hard of Hearing	Hard of Hearing will enhance the dialogue to make it easier to hear. Select ON or OFF.	A screenshot of the 'Accessibility Settings' menu. Both 'Hard of Hearing' and 'Audio Description' are set to 'Off'. The background shows a news anchor on a screen.
Audio Description	Audio description describes the action when people aren't speaking. <ul style="list-style-type: none"> • Select AUDIO DESCRIPTION then press the OK button. • If any available languages are available then press the ◀▶ to select your desired language. • Press the ◀▶ to select your preferred language. • Press the ◀▶ to set your desired volume of the audio description. 	

3. Press the **MENU** button to exit the menu.

Other Settings

The Other Settings menu has more advanced setting that you can adjust, these are not everyday setting.

1. Press the **MENU** button and then press the ◀▶ buttons to select the **SETTINGS** and then press the **OK** button. The SETTINGS menu will be displayed.
2. Press the ▲▼ buttons to select MORE and then press the **OK** button.



Menu Timeout	You can select a time that your TV menus will be displayed. If you select OFF the menu will remain on the screen until you press a button to remove it. OFF - 15 Sec - 30 Sec - 60 Sec.
Software upgrade	<ul style="list-style-type: none"> • Select SOFTWARE UPGRADE then press OK. The Upgrade Options menu will appear. • Press the ◀▶ to enable or disable AUTOMATIC SCANNING. • To manually scan for an upgrade select SCAN FOR UPGRADE then press OK.
Auto TV OFF	Select a time that you would like your TV to switch off if no buttons are pressed for a certain amount of time. OFF - 1 HOUR - 2 HOURS - 3 HOURS - 4 HOURS - 5 HOURS - 6 HOURS - 7 HOURS - 8 HOURS
Store Mode	Press the ◀▶ to select enable or disable store mode. Store mode will brighten the display.
Audio Video Sharing	Press the ◀▶ to select enable or disable audio video sharing.
Power Up Mode	Press the ◀▶ to select STANDBY or LAST STATE. If you choose LAST STATE, and switch your TV off and back on again at the mains it will switch on at its last state. Its best to leave it as STANDBY, otherwise your TV may switch on after a power cut.
Virtual Remote	Press the ◀▶ to select enable or disable virtual remote.
CEC	Press the ◀▶ to select enable or disable virtual remote.
CEC Auto Power On	Press the ◀▶ to select enable or disable virtual remote.
Speaker	Press the ◀▶ to select TV or Amplifier. CEC has to be set to Enabel to access this setting.



When in Smart or Media modes the CEC function will not function. For CEC to function properly your TV must be in TV mode.

HDMI ARC (Audio Return Channel)

The ARC (Audio Return Channel) function allows you to send audio from your ARC-compliant TV to ARC-compliant audio devices (e.g. soundbar) through a single HDMI connection.

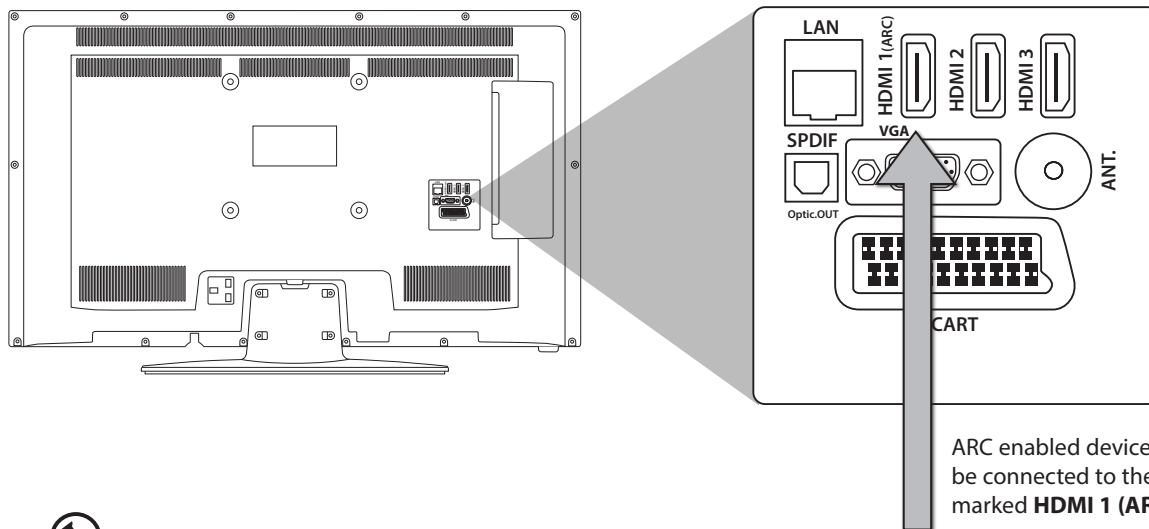

Make sure CEC is enabled when using an ARC-compliant device.

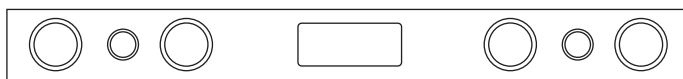

External speaker e.g. Soundbar

HDMI-ARC Connection

To enjoy the ARC function, please ensure your ARC-compliant audio devices are connected by an HDMI cable that support the ARC function to the HDMI 1(ARC) port of your ARC-compliant TV. When correctly set up, you can use your TV remote control to adjust the volume output (VOL +/- and MUTE) of the connected audio device.

1. Make sure your TV and ARC-compliant device are disconnected from the main and switched off.
2. Connect your ARC-compliant device to your TV making sure you use the HDMI1 (ARC) socket on the back of the TV. The plug in and switch on at the mains.
3. Press the **MENU** button and then press the ◀▶ buttons to select the **SETTINGS** and then press the **OK** button.
4. Press the ▲▼ buttons to select MORE then press **OK**.



5. Press the ▲▼ buttons to select **SPEAKERS** then press the ◀▶ buttons to select **AMPLIFIER**. It may take up to 15 seconds before you hear sound from your external speaker, this is normal.

You will now be able to use your TV remote control to adjust the volume of your external speaker and the speaker will also switch into on/standby when you switch your TV on and off.



Language Settings

Allows you to select your desired language settings for your TV.

1. Press the **MENU** button and then press the ◀▶ buttons to select the **SETTINGS** and then press the **OK** button. The SETTINGS menu will be displayed.
2. Press the ▲▼ buttons to select LANGUAGE and then press the **OK** button.

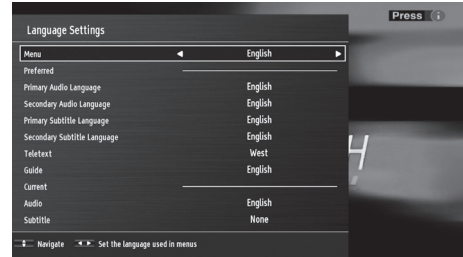

Menu	Press the ◀▶ buttons to select your desired menu language.
Preferred	
Audio	Press the ◀▶ buttons to select your preferred audio language.
Subtitle	Press the ◀▶ buttons to select your preferred subtitle language.
Teletext	Press the ◀▶ buttons to select your preferred teletext language.
Guide	Press the ◀▶ buttons to select your preferred guide language.
Current	
Audio	Shows the current audio language, this may not be able to be changed.
Subtitle	Shows the current subtitle language. Press the ◀▶ buttons to select a different subtitle language.

Sources

In the SOURCE SETTING menu you can decide to switch each input source on or off, by selecting ENABLED or DISABLED.

1. Press the **MENU** button and then press the ◀▶ buttons to select the **SETTINGS** and then press the **OK** button. The SETTINGS menu will be displayed.
2. Press the ▲▼ buttons to select SOURCES and then press the **OK** button.
3. Press the ▲▼ buttons to select a source then press the ◀▶ buttons to select ENABLED or DISABLED.

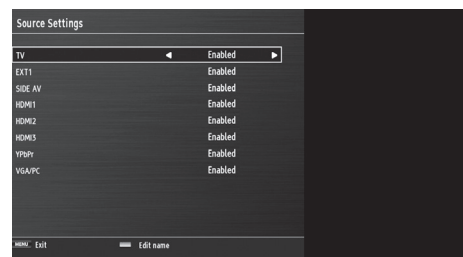

Resetting your TV

Restores all settings to the factory defaults and will delete all channels you currently have stored.

1. Press the **MENU** button and then press the ◀▶ buttons to select the **INSTALL AND RETUNE** and then press the **OK** button. The **INSTALL AND RETUNE** menu will be displayed.
2. Press the ▲▼ buttons to select **FIRST TIME INSTALLATION** and then press the **OK** button.
3. Press the ▲▼ buttons to select **YES** then press **OK**. The screen will turn black and then in a few seconds you will see the **FIRST TIME INSTALLATION MENU**.



All channel and user settings will be lost and the TV will revert to "First Time Installation".

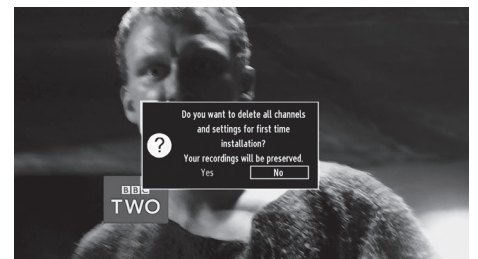
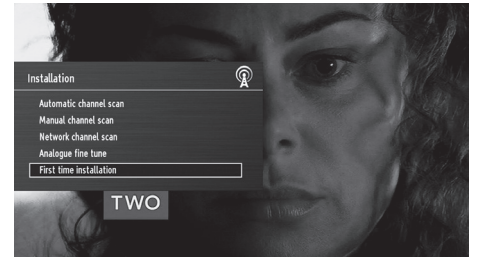
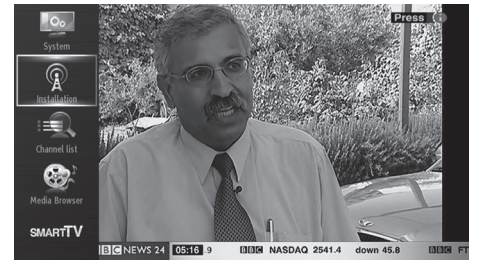

Parental Settings

To access the **PARENTAL SETTINGS** menu options, you must enter the password. Enter the default password “**0000**” for first time use. To change the password, select SET PIN.

1. Press the **MENU** button and then press the ◀▶ buttons to select the **SETTINGS** and then press the **OK** button. The **SETTINGS** menu will be displayed.



2. Press the ▲▼ buttons to select **PARENTAL** and then press the **OK** button.

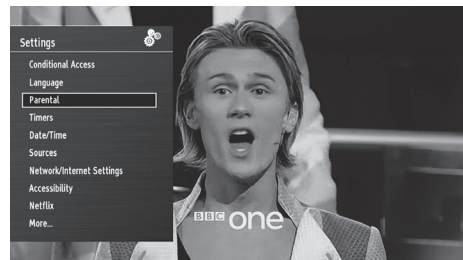

3. Press the **NUMBER** buttons to enter your PIN number. The **PARENTAL SETTINGS** menu will appear on screen.



<p>Menu Lock</p>	<p>You can lock all of the menus or just the installation menus. Press the ◀▶ buttons to select ALL MENU - INSTALLATION MENU - OFF. If you choose to lock the menus you will have to enter your PIN number to enter the selected menu.</p>
<p>Child Lock</p>	<p>The child lock will prevent the buttons working on your TV, to stop children from accidentally changing any of the settings. Press the ◀▶ buttons to set the child lock to ON or OFF.</p>
<p>Set PIN</p>	<ul style="list-style-type: none"> • Press the ▲▼ buttons to select SET PIN. • Press OK. • Press the NUMBER buttons to enter and NEW PIN • Press the NUMBER buttons to CONFIRM the new pin. The words 'PIN CHANGED' will briefly appear on the screen. <p>Don't forget to make a note of your new PIN number.</p>





The default password is “**0000**”.
If you change the password, be sure to remember the new password!

Connecting a USB Storage Device



You must use a USB storage device with a minimum of 2GB of storage space.

1. Switch off the TV before connecting any USB storage device.
2. Connect your USB storage device to the USB port of your TV. If your USB device is powered by the main, plug the connected devices into the mains socket and switch on.
3. Press the  button on the remote control to turn on your TV.
4. Press the  button on the remote control to enter MEDIA BROWSER mode.

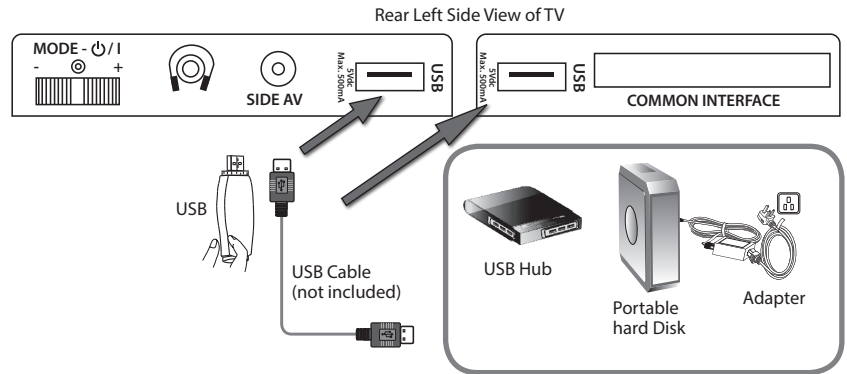

- Some versions of portable hard disk may require more power than the TV USB socket can provide. To ensure correct operation please use the power adapter for that device.
- If a USB hub is used, make sure its mains adapter is connected to the mains supply as the total current consumption may exceed 500mA.
- The file system only supports FAT32 format.
- If you want to store the video streaming of a DTV programme, the transfer rate of the USB storage device must not be less than 5MB/s, otherwise the picture and sound of the programme will be affected and a warning statement will be shown on the screen. If this happens, please upgrade your USB storage device.
- The TV screen will be blank temporarily as it will take time to start up and stabilise the connected hard disk. This is normal and the starting time may vary depending on the brand and the memory size of the connected hard disk.
- Disconnect the USB storage device if it is not in use.

Viewing Videos



1. Press the  button on the remote control. The MEDIA BROWSER will be displayed.









2. Press the   buttons to select **VIDEOS** and then press the **OK** button.

- **NUMBER Buttons** - Jump to a video in the list.
- **OK Button** - Plays the selected video.
- **PLAY button** - Plays the selected video.
- **GREEN button** - Repeats or shuffles your videos.
- **YELLOW button** - Changes the menu style.
- **LANG button** - Plays a preview of the selected video.
- **BLUE button** - Changes to another media.







3. Press the   buttons to select the video you wish to play, then press the **OK** button. The video will start to play.

-   **buttons** - Plays the next or previous video
-  **button** - Stops the video.
- **LANG button** - Shows the Subtitle/Audio menu
-  **button** - Pauses the video, press again to resume playback.
- **BACK button** - Returns back to the video menu.
-    **buttons** - Rewind and fast forward the video 2x - 4x - 8x.
- **GREEN button** - Press to jump to a selected time in your video.
- **YELLOW button** - Press to see the SUBTITLE TIME CORRECTION menu, where you can adjust the time delay of the subtitles to match the action in the video.



- Supported file formats: MPEG1 & 2, VOB, and MKV.

Viewing Photos

- Press the  button on the remote control. The MEDIA BROWSER will be displayed.
- Press the  buttons to select **PHOTOS** and then press the **OK** button.
 - NUMBER Buttons** - Jump to a photo in the list.
 - OK Button** - Press to view the selected photo on the full screen.
 - PLAY button** - Plays a slide show of all the photos in the list.
 - GREEN button** - Shows thumbnail images of the photos in the list.
 - RED button** - Sorts the photos by date.
 - YELLOW button** - Changes the menu style.
 - BLUE button** - Changes to another media.
- Press the  buttons to select the photo you wish to view, then press the **OK** button. The photo will now be displayed on the full screen.
 - PLAY button** - Plays a slide show of all the photos in the list.
 - || button** - Pauses the slide show.
 - BACK button** - Returns back to the photo menu.
 - RED button** - Zooms into the photo 150% - 200% - 300% - 400% - 50%. When zoomed in press the  buttons to move around the photo.
 - ▲▼ button** - Press to rotate the photo.
 - ◀▶ button** - Press to see the next or previous photo in the list.
 - i button** - Press to see the information bar.



- Supported file formats: JPEG and BMP.



Listening to Music

1. Press the  button on the remote control. The MEDIA BROWSER will be displayed.



2. Press the   buttons to select **Music** and then press the **OK** button.

- **NUMBER Buttons** - Jump to a track in the list.
- **OK Button** - Press to play the selected track.
- **PLAY button** - Press to play the selected track.
- **GREEN button** - Press to repeat or shuffle the tracks.
- **RED button** - Sorts the tracks by Title - Artist - Album.
- **YELLOW button** - Changes the menu style.
- **BLUE button** - Changes to another media.
- **|| button** - Pauses the track, press again to resume playback.
- **■ button** - Stops the track.



- Supported file formats: MP3 and WMA /ASF.

Media Browser Settings

1. Press the  button on the remote control. The MEDIA BROWSER will be displayed.

2. Press the   buttons to select **Settings** and then press the **OK** button.



In the SETTINGS menu you can adjust the settings for your slideshows and subtitle settings for when you are watching a video.



Maintenance

Careful and regular cleaning can prolong the life of your TV.



Be sure to press the  button on the remote control and disconnect the mains cable from the mains socket before any cleaning.

1. Use a soft dry cloth to wipe away the dust from the screen and surfaces.
2. If the surfaces are extremely dirty, clean the TV with a damp cloth.
3. Ensure there is no excess water on the screen. Allow any water or dampness to evaporate before switching the TV on.



Never use alcohol, benzene, paint-thinner, cleaning fluid or other chemicals. Do not use compressed air to remove dust.

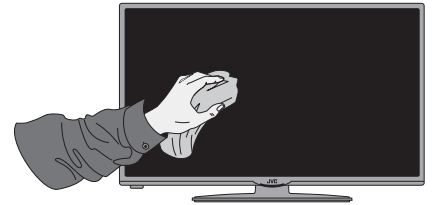

Hints and Tips

The following table contains various hints and tips to get the best performance from your TV. If you require additional assistance please call our Call Centre on (UK) **0344 561 1234** or (Ireland) **1 890 818575**. Our Customer Contact Centre is open Monday-Saturday 8am-8pm or Sunday 8am-6pm.

The TV does not operate properly.

The TV does not respond when pressing any buttons

- The TV may freeze up during use. Switch the TV off at the mains for a few minutes. Switch on again and try to operate it again as usual.

TV cannot be switched on

- Check that the TV is connected to the mains supply and switched on.
- Make sure all connected AV devices are switched off before switching on your TV.

The remote control does not work

- Check to see if there are any objects between the TV and the remote control causing an obstruction. Ensure that you are pointing the remote control directly at the TV.
- Ensure that the batteries are installed with the correct polarity (+ to +, - to -).
- Install new batteries.

Power is suddenly turned off

- Check the TV has power to it. The mains supply maybe interrupted.
- Check if the sleep timer is set.
- Check whether the Auto Standby is activated.

The video function does not work.

No Picture & No Sound

- Check whether the TV is switched on.
- Try another channel. The problem may be caused by the broadcaster.

Picture appears slowly after switching on

- This is normal, the image is muted during the TV startup process. Please contact your service centre, if the picture has not appeared after five minutes.

No or poor colour or poor picture

- Adjust the settings in the **PICTURE** menu.
- Try another channel. The problem may be caused by the broadcaster.
- Check if the video cables are connected properly.

Horizontal / Vertical bar or picture shaking

- Check for local interference such as an electrical appliance or power tool.

Poor reception on some channels

- Station or cable channel may be experiencing problems, tune to another station.
- Station signal is weak, reposition the aerial for better reception.
- Check for sources of possible interference.

Lines or streaks in pictures

- Check aerial (Change the position of the aerial.)

No pictures when connecting HDMI

- Check if the input source is **HDMI 1, 2 or 3**.

Picture appears in wrong ratio

- Adjust the **Aspect Ratio**. Press the  (**ASPECT**) button on the remote control.

The audio function does not work.	
Picture OK but no sound	<ul style="list-style-type: none"> • Press the VOL + / - buttons. • Sound muted? Press the MUTE button. • Try another channel. The problem may be caused by the broadcaster.
No output from one of the speakers	<ul style="list-style-type: none"> • Adjust the Balance settings in the SOUND menu.
Unusual sound from inside the TV	<ul style="list-style-type: none"> • A change in ambient humidity or temperature may result in an unusual noise when the TV is switched on or off and does not indicate a fault with the TV.
No sound when connecting HDMI	<ul style="list-style-type: none"> • Check if the input source is HDMI1, 2 or 3.
Audio noise	<ul style="list-style-type: none"> • Keep the RF coaxial cable away from other connected cables.

Password	
Lost password	<ul style="list-style-type: none"> • Select the Set Password setting in the LOCK menu, then enter the following master password "4725". The master password clears your previous password and allows you to enter a new password.

There is a problem in PC mode.	
The signal is out of range (Invalid format)	<ul style="list-style-type: none"> • Adjust the resolution, horizontal frequency, or vertical frequency.
Vertical bar or stripe on background & horizontal noise & incorrect position	<ul style="list-style-type: none"> • Use Auto configure or adjust clock, phase, or H/V position.
Screen colour is unstable or shows a single colour	<ul style="list-style-type: none"> • Check the signal cable. • Reinstall the PC video card.

Smart TV isn't working	
Can't access Smart TV	<ul style="list-style-type: none"> • Check you are connected to your router and that the router is switch on and working. • Your router may be to far away from your TV, move your router closer to your TV. • Try connecting your TV to your router using an ethernet cable.
Smart TV is very slow to activate	<ul style="list-style-type: none"> • Your internet speed may be very slow, check your speed with your internet provider.
Some of the Apps have disappeared or changed	<ul style="list-style-type: none"> • The Apps on your TV may have been updated or even removed this can happen at any time. Its normal and not a fault of your TV.

FAQs (Frequently Asked Questions)	
Why have I lost some / all of my channels?	<ul style="list-style-type: none"> • It happens sometimes if you have a weak signal. Usually it just means you'll need to re-tune your TV. Don't worry, it is easy to do. And once you've done it, you should get all the Freeview channels available to you. If problems persist you may need to get your aerial checked. Talk to your retailer or contact your local aerial installer.
Why do I get 'blocking' on my digital picture?	<ul style="list-style-type: none"> • In most cases, blocking is caused by a reception problem – either the signal is too weak or there is some kind of interference. Talk to your retailer or contact your local aerial installer. • Blocking can also be caused by a digital signal that is too strong. If you are still experiencing blocking and the signal is strong, consult your local aerial installer for advice.
Can I watch Freeview using a portable set-top aerial?	<ul style="list-style-type: none"> • Some, but only a few, homes may be able to use a set top aerial. However, for a much better reception, we strongly recommend that you use a rooftop aerial. • If you do not have access to a rooftop aerial – for example, if you rent a flat and the aerial is the responsibility of your landlord, or if you're using a second TV in the bedroom and don't want the hassle and expense of using extension cables, a set top aerial may be your only option.
What type of aerial do I need?	<ul style="list-style-type: none"> • If you are installing a new aerial, we recommend a wideband rooftop aerial rather than a loft aerial. Loft aerials generally receive a weaker digital signal and are more likely to get interference from other electrical devices at home. We suggest you have an aerial survey done before getting an aerial upgrade. • Talk to your retailer or contact your local aerial installer.

Product Fiche and Specifications

Brand	JVC
Model	LT-40C750(A)
Energy Efficiency Class	A+
Screen Size (measured diagonally)	40" - 102cm
Power Consumption (In HOME mode)	48W
Average Annual Energy Consumption **	70 kWh / annum
Standby Power Consumption	0.5W
Display Resolution	1920 pixels (horizontal) x 1080 pixels (vertical)
Panel System	40 inch Direct LED Panel
Television System	PAL I / BG / DK SECAM I / BG / DK DVB-T2 (VIDEO: MPEG-4 MP@ML, SOUND: AAC, MPEG-1 LAYER 1/2, MPEG-2 LAYER 2)
Brightness	300 cd/m ²
Contrast Ratio	4000 : 1
Power Source	220-240V ~50Hz
Operating Temperature	0°C – 40°C
Operating Humidity	80% (max)
Mercury Content (mg)	X
Presence of Lead	√*
Reference Period	2010/1062 - 2014
Speaker Power	2 x 8W
Dimension(W x H x D) with base	923(W) x 588(H) x 220(D)
Weight (Net)	9.5kg
Inputs / Output	
SCART	1
HDMI	3
PC-RGB (VGA)	1
SIDE AV (L & R)	1
YPbPr via VGA	1
Common Interface	1
USB	2
ANT. (Aerial socket)	1
SPDIF (Optical)	1
Headphone	1
Ethernet (RJ-45)	1
Built in wireless network	Yes

Features and specifications are subject to change without prior notice.

*This television contains lead in certain parts or components where no technology alternatives exist in accordance with existing exemption clauses under the RoHS Directive.

**Energy consumption 70 kWh per year, based on the power consumption of the television operating 4 hours per day for 365 days. The actual energy consumption will depend on how the television is used.



ENERG
енергия · ενεργεια

Y IJA
IE IA

JVC **LT-40C750(A)**

A+

A

B

C

D

E

F



A+

ENERGIA · ЕНЕРГИЯ
ΕΝΕΡΓΕΙΑ · ENERGIJA
ENERGY · ENERGIE
ENERGI

48
Watt

70
kWh/annum

102
cm



40
inch

2010/1062 - 2014



50321524

License Information used with JVC Televisions

The software pre-installed in the JVC Digital Televisions consists of multiple, independent software components. Each software component is copyrighted by JVC or a third party. The JVC Digital Televisions uses software components that are distributed as freeware under a third-party end-user license agreement or copyright notice (hereinafter referred to as a "EULA"). Some EULAs require that the source code of the applicable component be disclosed as the condition for distributing the software component in executable format. The JVC warranty provided in respect of the Digital TV is the only warranty provided and no additional warranties are provided in respect of the software components subject to EULAs. Some of the software components distributed under EULAs are made available for use by the user on the premise that they are not copyrighted or warranted by JVC or any third party. These software components are licensed to the user free of charge and therefore not covered by any warranty within the scope of the applicable laws. These software components are provided in "as is" condition without any warranty, whether express or implied. "Warranty" here includes, but not limited to, an implied warranty for marketability or fitness for specific uses. All risks associated with the quality or performance of these software components are assumed by the user. JVC shall not be liable whatsoever for any cost of repair or correction or other incidental expense incurred in connection with a defect found in any of these software components. Unless specified under the applicable laws or in a written agreement, a party who changes or redistributes the software with consent from the copyright holders or based on the aforementioned licenses shall not be held liable whatsoever for any loss arising from the use of or inability to use such software components. The same applies even when the copyright holders or relevant third parties have been informed of the possibility of such loss. "Loss" here includes normal, special, incidental and indirect loss (including, but not limited to, the loss of data or its accuracy; loss incurred by the user or any third party; and interface incompatibility with other software).

Please read each EULA for details on the use conditions and items that must be observed regarding these software components. For details of software components covered by "GPL", please visit the following website:

<http://www.currys.co.uk/compliance>

Remote Control Codes

Sky Codes

The code for controlling your TV using a Sky Remote Control is **0065**. For instruction on how to use the code see your Sky instruction manual.

Virgin Media Codes (TiVo box)

The codes for controlling your TV using a Virgin Media Remote Control are **0044, 0049, 0101, 0107, 0125, 0152, 0166, 0379, 0654**. For instruction on how to use the code see your Virgin Media instruction manual.

BT Vision

The codes for controlling your TV using a BT Vision Remote Control are **0000, 0019, 0725, 0669, 0016, 0152, 0184, 0197, 0198, 0225, 0244, 0324, 0325, 0339, 0319**. For instruction on how to use the code see your BT Vision instruction manual.



For general information about this appliance and handy hints and tips, please visit www.knowhow.com/knowledgebank or call (UK) 0344 5611234 or (Ireland) 1 890 818 575.



Visit Partmaster.co.uk today for the easiest way to buy electrical spares and accessories. With over 1 million spares and accessories available we can deliver direct to your door the very next day. Visit www.partmaster.co.uk or call 0344 800 3456 (UK customers only). Calls charged at National Rate.



The symbol on the product or its packaging indicates that this product must not be disposed of with your other household waste. Instead, it is your responsibility to dispose of your waste equipment by handing it over to a designated collection point for the recycling of waste electrical and electronic equipment. The separate collection and recycling of your waste equipment at the time of disposal will help conserve natural resources and ensure that it is recycled in a manner that protects human health and the environment.

For more information about where you can drop off your waste for recycling, please contact your local authority, or where you purchased your product.

MPEG-2 NOTICE

Any use of this product in any matter other than personal use that complies with the MPEG-2 standard for encoding video information for packaged media is expressly prohibited without a license under applicable patents in the MPEG-2 Patent Portfolio, which license is available from MPEG LA, LLC, 6312 S. Fiddlers Green Circle, Suite 400E, Greenwood Village, Colorado, 80111 U.S.A.

Rovi Proprietary Rights

This item incorporates copy protection technology that is protected by U.S. patents and other intellectual property rights of Rovi Corporation. Reverse engineering and disassembly are prohibited.

Restriction on Use & Rovi Trade Mark Rights

Use of the copyright protection technology contained in this product must be authorised by Rovi Corporation and is intended for home and other limited viewing uses only unless otherwise authorised by Rovi Corporation. The names "Rovi Corporation" and "Macrovision" are protected by trademarks.

Dolby Digital

Manufactured under license from Dolby Laboratories. Dolby and the double-D symbol are trademarks of Dolby Laboratories. Confidential unpublished works. ©1992-1997 Dolby Laboratories, Inc. all rights reserved.

Freeview

The Freeview service and channels are subject to coverage and may be changed from time to time. Aerial upgrade and/or receiver may be required. Visit freeview.co.uk/availability.

The FREEVIEW words and logos are trade marks of DTV Services LTD. © DTV Services Ltd.

Notes for battery disposal

The batteries used with this product contain chemicals that are harmful to the environment. To preserve our environment, dispose of used batteries according to your local laws or regulations. Do not dispose of batteries with normal household waste.

For more information, please contact the local authority or your retailer where you purchased the product.

HDMI, the HDMI logo and High-Definition Multimedia Interface are trademarks or registered trademarks of HDMI Licensing LLC.

For DTS patents, see <http://patents.dts.com>. Manufactured under license from DTS Licensing Limited. DTS, the Symbol, & DTS and the Symbol together are registered trademarks, and DTS TruSurround and DTS 2.0+Digital Out are trademarks of DTS, Inc. © DTS, Inc. All Rights Reserved.

All trademarks are the property of their respective owners and all rights are acknowledged.

The wireless LAN hardware in your product conforms to the requirements and provisions set out in European Directive 1999/5/EC (R&TTE). Limitations may apply for details go to www.currys.co.uk/compliance

Dear Customer,

This apparatus is in conformance with the valid European directives compatibility and electrical safety.

European representative of the manufacturer is:
DSG Retail Ltd. (co. no. 504877)
1 Portal Way, London, W3 6RS, UK

For Help and Support Call

UK: 0344 561 1234

Ireland: 1890 818 575



The product is distributed and warranted exclusive by DSG Retail Ltd.
"JVC" is the trademark of JVC KENWOOD Corporation, used by DSG Retail Ltd. under license.