

Nikon

DIGITAL CAMERA

COOLPIX P5000

User's Manual



En

Where to Find It

Find what you're looking for from:



The *Table of Contents*



vi–vii

Find items by function or menu name.



The *Q&A Index*



viii–ix

Know what you want to do but don't know the function name? Find it from the "question and answer" index.



The *Index*



111–114

Search by key word.



Error Messages



97–99

If a warning is displayed in the viewfinder or monitor, find the solution here.



Troubleshooting



100–103

Camera behaving unexpectedly? Find the solution here.

Help

Use the camera's on-board help feature for help on menu items and other topics. See page 7 for details.

Trademark Information

Macintosh, Mac OS, and QuickTime are registered trademarks of Apple Computer, Inc. Microsoft and Windows are registered trademarks of Microsoft Corporation. The SD logo is a trademark of the SD Card Association. Adobe and Acrobat are registered trademarks of Adobe Systems Inc. PictBridge is a trademark. D-Lighting technology is provided by Apical Limited. All other trade names mentioned in this manual or the other documentation provided with your Nikon product are trademarks or registered trademarks of their respective holders.

COOLPIX P5000

Symbols and Conventions

To make it easier to find the information you need, the following symbols and conventions are used:



This icon marks cautions, information that should be read before use to prevent damage to the camera.



This icon marks notes, information that should be read before using the camera.



This icon marks tips, additional information that may be helpful when using the camera.



This icon indicates that more information may be found elsewhere in this manual or in the *Quick Start Guide*.

Introduction

First Steps

Basic Photography and Playback

Scene Mode

P and T Modes

P, S, A, and M Modes

More on Playback

Movies

Voice Recordings

Connecting to Televisions, Computers, and Printers

Menu Guide

Technical Notes

For Your Safety

To prevent damage to the product or injury to yourself or to others, read the following safety precautions in their entirety before using this equipment. Keep these safety instructions where all those who use the product will read them.

The consequences that could result from failure to observe the precautions listed in this section are indicated by the following symbol:



This icon marks warnings, information that should be read before using this Nikon product to prevent possible injury.

WARNINGS

Turn off in the event of malfunction

Should you notice smoke or an unusual smell coming from the camera or optional AC adapter, unplug the AC adapter and/or remove the battery immediately, taking care to avoid burns. Continued operation could result in injury. After removing or disconnecting the power source, take the equipment to a Nikon-authorized service representative for inspection.

Do not disassemble

Touching the internal parts of the camera or AC adapter could result in injury. Repairs should be performed only by qualified technicians. Should the camera or AC adapter break open as the result of a fall or other accident, take the product to a Nikon-authorized service representative for inspection after unplugging the product and removing the battery.

Do not use the camera, battery charger, or AC adapter in the presence of flammable gas

Do not use electronic equipment in the presence of flammable gas, as this could result in explosion or fire.

Handle the camera strap with care

Never place the strap around the neck of an infant or child.

Keep out of reach of children

Particular care should be taken to prevent infants from putting batteries or other small parts into their mouths.

Observe caution when handling batteries

Batteries may leak or explode if improperly handled. Observe the following precautions when handling batteries for use in this product:

- Before replacing the battery, turn the product off. If you are using the AC adapter, be sure it is unplugged.
- Use only rechargeable Nikon EN-EL5 lithium-ion batteries (supplied). Use the supplied MH-61 battery charger to charge the batteries.
- When inserting the battery, do not attempt to insert it upside down or backwards.
- Do not short or disassemble batteries.
- Do not expose to flame or to excessive heat.
- Do not immerse in or expose to water.
- Replace the terminal cover when transporting the battery. Do not transport or store with metal objects such as necklaces or hairpins.
- Batteries are prone to leakage when fully discharged. To avoid damage to the product, be sure to remove the battery when no charge remains.
- Discontinue use immediately should you notice any change in the battery, such as discoloration or deformation.
- If liquid from the damaged batteries comes in contact with clothing or skin, rinse immediately with plenty of water.

⚠ Observe the following precautions when handling the battery charger

- Use only battery chargers designated for use with this product.
- Keep dry. Failure to observe this precaution could result in fire or electric shock.
- Dust on or near the metal parts of the plug should be removed with a dry cloth. Continued use could result in fire.
- Do not handle the power cable or go near the adapter during thunderstorms. Failure to observe this precaution could result in electric shock.
- Do not damage, modify, forcibly tug or bend the power cable, place it under heavy objects, or expose it to heat or flame. Should the insulation be damaged and the wires become exposed, take it to a Nikon-authorized service representative for inspection. Failure to observe these precautions could result in electric shock.

⚠ Do not look at the sun through the viewfinder

Viewing the sun or other strong light source through the viewfinder could cause permanent visual impairment.

⚠ Use appropriate cables

When connecting cables to the input and output jacks, use only the cables sold or provided by Nikon for the purpose, to maintain compliance with product regulations.

⚠ Handle moving parts with care

Be careful that your fingers or other objects are not pinched in the lens or other moving parts.

⚠ CD-ROMs

The CD-ROMs supplied with this device should not be played back on audio CD equipment. Playing CD-ROMs on an audio CD player could cause hearing loss or damage the equipment.

⚠ Observe caution when operating the flash

Using the flash close to your subject's eyes could cause temporary visual impairment. Particular care should be observed when photographing infants, when the flash should be no less than one meter (39 in.) from the subject.

⚠ Do not fire the flash while it is touching a person or object

Such use can result in the person being burned, and/or their clothes igniting from the heat of the flash.

⚠ Avoid contact with liquid crystal

Should the monitor break, care should be taken to avoid injury due to broken glass and to prevent liquid crystal from the monitor touching the skin or entering the eyes or mouth.

Notices

- No part of the manuals included with this product may be reproduced, transmitted, stored in a retrieval system, or translated into any language in any form, by any means, without Nikon's prior written permission.
- Nikon reserves the right to change the specifications of the hardware and software described in these manuals at any time and without prior notice.
- Nikon will not be held liable for any damages resulting from the use of this product.
- While every effort has been made to ensure that the information in these manuals is accurate and complete, we would appreciate it were you to bring any errors or omissions to the attention of the Nikon representative in your area (address provided separately).

Notice for Customers in the U.S.A

Federal Communications Commission (FCC) Radio Frequency Interference Statement

This equipment has been tested and found to comply with the limits for a Class B digital device, pursuant to Part 15 of the FCC rules. These limits are designed to provide reasonable protection against harmful interference in a residential installation. This equipment generates, uses, and can radiate radio frequency energy and, if not installed and used in accordance with the instructions, may cause harmful interference to radio communications. However, there is no guarantee that interference will not occur in a particular installation. If this equipment does cause harmful interference to radio or television reception, which can be determined by turning the equipment off and on, the user is encouraged to try to correct the interference by one or more of the following measures:

- Reorient or relocate the receiving antenna.
- Increase the separation between the equipment and receiver.
- Connect the equipment into an outlet on a circuit different from that to which the receiver is connected.
- Consult the dealer or an experienced radio/television technician for help.

Notice for customers in Canada

CAUTION

This Class B digital apparatus complies with Canadian ICES-003.



CAUTIONS

Modifications

The FCC requires the user be notified that any changes or modifications made to this device that are not expressly approved by Nikon Corporation may void the user's authority to operate the equipment.

Interface Cables

Use the interface cables sold or provided by Nikon for your equipment. Using other interface cables may exceed the limits of Class B Part 15 of the FCC rules.

Notice for Customers in the State of California

WARNING: Handling the cord on this product may expose you to lead, a chemical known to the State of California to cause birth defects or other reproductive harm. *Wash hands after handling.*

Nikon Inc.
1300 Walt Whitman Road, Melville, New York
11747-3064, U.S.A. Tel.: 631-547-4200

ATTENTION

Cet appareil numérique de la classe B est conforme à la norme NMB-003 du Canada.

Symbol for Separate Collection in European Countries

This symbol indicates that this product is to be collected separately.



The following apply only to users in European countries:

- This product is designated for separate collection at an appropriate collection point. Do not dispose of as household waste.
- For more information, contact the retailer or the local authorities in charge of waste management.

Notice Concerning Prohibition of Copying or Reproduction

Note that simply being in possession of material that has been digitally copied or reproduced by means of a scanner, digital camera, or other device may be punishable by law.

• Items prohibited by law from being copied or reproduced

Do not copy or reproduce paper money, coins, securities, government bonds, or local government bonds, even if such copies or reproductions are stamped "Sample."

The copying or reproduction of paper money, coins, or securities which are circulated in a foreign country is prohibited.

Unless the prior permission of the government has been obtained, the copying or reproduction of unused postage stamps or post cards issued by the government is prohibited.

The copying or reproduction of stamps issued by the government and of certified documents stipulated by law is prohibited.

• Cautions on certain copies and reproductions

The government has issued cautions on copies or reproductions of securities issued by private companies (shares, bills, checks, gift certificates, etc.), commuter passes, or coupon tickets, except when a minimum of necessary copies are to be provided for business use by a company. Also, do not copy or reproduce passports issued by the government, licenses issued by public agencies and private groups, ID cards, and tickets, such as passes and meal coupons.

• Comply with copyright notices

The copying or reproduction of copyrighted creative works such as books, music, paintings, woodcuts, prints, maps, drawings, movies, and photographs is governed by national and international copyright laws. Do not use this product for the purpose of making illegal copies or to infringe copyright laws.











































Disposing of Data Storage Devices

Please note that deleting images or formatting data storage devices such as memory cards or built-in camera memory does not completely erase the original image data. Deleted files can sometimes be recovered from discarded storage devices using commercially available software, potentially resulting in the malicious use of personal image data. Ensuring the privacy of such data is the user's responsibility.

Before discarding a data storage device or transferring ownership to another person, erase all data using commercial deletion software, or format the device and then completely refill it with images containing no private information (for example, pictures of empty sky). Be sure to also replace any pictures selected for the welcome screen (84). Care should be taken to avoid injury when physically destroying data storage devices.

Table of Contents

For Your Safety.....	ii
Notices.....	iv
Q&A Index.....	viii
Introduction	1
Parts of the Camera	2
First Steps	9
Charging the Battery.....	9
Inserting the Battery	10
Turning the Camera on and Off.....	12
Basic Setup.....	12
Inserting Memory Cards	14
Basic Photography and Playback	16
📷 Mode.....	16
Viewing Pictures	22
Using the Flash	24
Taking Pictures with the Self-Timer.....	26
Choosing a Focus Mode.....	27
Exposure Compensation.....	28
Scene Mode	29
👋 and ISO Modes.....	36
👋 (Anti-Shake) Mode.....	36
ISO (High Sensitivity) Mode.....	37
P, S, A, and M Modes.....	38
More on Playback.....	43
Viewing Multiple Pictures: Thumbnail Playback.....	43
Taking a Closer Look: Playback Zoom	43
Creating Retouched Copies.....	44
Voice Memos: Recording and Playback.....	46
Movies	47
Recording Movies.....	47
Movie Playback.....	50
Voice Recordings	51
Connecting to Televisions, Computers, and Printers	54
Viewing Pictures on TV.....	55
Viewing Pictures on a Computer	56
Printing Pictures.....	60

Menu Guide	65
Shooting Options: The Shooting Menu	65
 Image Quality	66
 Image Size	66
 Optimize Image	68
 White Balance	70
 ISO Sensitivity	71
 Metering	72
 Continuous	73
 BSS	75
 Auto Bracketing	75
 AF Area Mode	76
 Auto-focus Mode	76
 Flash Exp. Comp.	78
 Flash Control	78
 Fixed Aperture	78
 Noise Reduction	78
 Converter	79
Playback Options: The Playback Menu	80
 D-Lighting	44
 Print Set	64
 Slide Show	81
 Delete	81
 Protect	81
 Transfer Marking	82
 Hide Image	82
 Small Pic	45
 Copy	82
Basic Camera Setup: The Setup Menu	83
 Menus	83
 Quick Startup	83
 Welcome Screen	84
 Date	84
 Brightness	85
 Date Imprint	86
 Vibration Reduction	87
 AF Assist	87
 Digital Zoom	87
 Sound Settings	88
 Auto Off	88
 Format Memory/ Format Card	88
 Language	88
 Interface	89
 FUNC Button	89
 Reset All	89
 Firmware Version	89
Technical Notes	90
Optional Accessories	90
Caring for the Camera	94
Cleaning	96
Storage	96
Error Messages	97
Troubleshooting	100
Appendix	104
Specifications	108
Index	111



Q&A Index

Find what you're looking for using this “question and answer” index.



General Questions

Question	Key phrase	
What do these indicators mean?	Monitor	4
What does this warning mean?	Error messages and displays	97
How do I get more information on a menu?	Help	7
How much charge does the battery have left?	Battery level	16
What does “exposure” mean and how does it work?	Exposure	38
What accessories are available for my camera?	Optional accessories	90
What optional converter lenses can I use?	Optional converter lenses	92
What optional flash units can I use?	Optional Speedlights	93
What memory cards can I use?	Approved memory cards	91
How do I clean the camera?	Cleaning the camera	96

Camera Setup

Question	Key phrase	
How do I keep the monitor from turning off?	Auto off	88
How do I turn the monitor on and off?	The  button	8
How do I adjust monitor brightness?	Brightness	85
How do I set the clock?		
How do I set the clock for daylight saving time?	Date	84
How do I change time zones when I travel?		
How do I restore default settings?	Reset all	89
Can I display the menus in a different language?	Language	88
How do I turn off the light on the front of the camera (AF-assist illuminator)?	AF assist	87
How do I keep the camera from beeping?	Sound settings	88

Taking Photographs

Question	Key phrase	Page
Is there an easy way to take snapshots?	 (auto) mode	16
Is there an easy way to take more creative shots?	SCENE (scene) mode	29
How can I avoid blur with the camera zoomed in?	 (anti-shake) mode	36
How can I avoid blur when lighting is poor?	ISO (high-sensitivity) mode	37
How do I record and play movies?	Movies	47
How do I record and play audio?	Voice recordings	51
How do I use the flash?	Flash mode	24
How do I use the self-timer?	Self-timer	26
Can I focus on nearby or distant objects?	Focus mode	27
Can I make photos brighter or darker?	Exposure compensation	28
How do I adjust exposure?	P, S, A, and M modes	38
How do I improve image quality?		
How do I take bigger photographs?	Image quality and size	66
How can I get more photos on the memory card?		

Viewing, Printing, and Retouching Photographs

Question	Key phrase	Page
Can I view my photographs on the camera?	Camera playback	22
How do I get rid of an unwanted photo?	Deleting individual photos	22
Can I delete several photos at once?	Delete	81
Can I zoom in on pictures to make sure they're in focus?	Playback zoom	43
Can I protect photos from accidental deletion?	Protect	81
Can I hide selected photos?	Hide image	82
How do I bring out details in shadows?	D-lighting	44
Can I crop pictures?	Cropped copies	45
Can I copy pictures at a smaller size?	Small picture	45
Can I record a voice memo about a picture?	Voice memos	46
Can I view my photos on TV?	Television playback	55
How do I copy photos to my computer?	Connecting to a computer	56
Can I print photos without a computer?	PictBridge	60
Can I print the date on my photographs?	Printing the date of recording	60
How do I order professional prints?	Printing photographs; print set	60, 64

Use Only Nikon Brand Electronic Accessories

Nikon COOLPIX cameras are designed to the highest standards and include complex electronic circuitry. Only Nikon brand electronic accessories (including battery chargers, batteries, AC adapters, and flash accessories) certified by Nikon specifically for use with this Nikon digital camera are engineered and proven to operate within the operational and safety requirements of this electronic circuitry.

THE USE OF NON-NIKON ELECTRONIC ACCESSORIES COULD DAMAGE THE CAMERA AND MAY VOID YOUR NIKON WARRANTY. The use of third-party rechargeable Li-ion batteries not bearing the Nikon holographic seal shown below could interfere with normal operation of the camera or result in the batteries overheating, igniting, rupturing, or leaking.

For more information about Nikon brand accessories, contact a local authorized Nikon dealer.

Holographic seal: Identifies this device as an authentic Nikon product.



EN-EL5
rechargeable
battery

Introduction

Thank you for your purchase of a Nikon COOLPIX P5000 digital camera. This manual has been written to help you enjoy taking pictures with your Nikon digital camera. Please be sure to read all instructions thoroughly to get the most from the camera, and keep them where they will be read by all those who use the product.

Before Taking Important Pictures

Before taking pictures on important occasions (such as at weddings or before taking the camera on a trip), take a test shot to ensure that the camera is functioning normally. Nikon will not be held liable for damages or lost profits that may result from product malfunction.

Life-Long Learning

As part of Nikon's "Life-Long Learning" commitment to ongoing product support and education, continually-updated information is available on-line at the following sites:



- **For users in the U.S.A.:** <http://www.nikonusa.com/>
- **For users in Europe and Africa:** <http://www.europe-nikon.com/support>
- **For users in Asia, Oceania, and the Middle East:** <http://www.nikon-asia.com/>

Visit these sites to keep up-to-date with the latest product information, tips, answers to frequently-asked questions (FAQs), and general advice on digital imaging and photography. Additional information may be available from the Nikon representative in your area. See the following URL for contact information: <http://nikonimaging.com/>

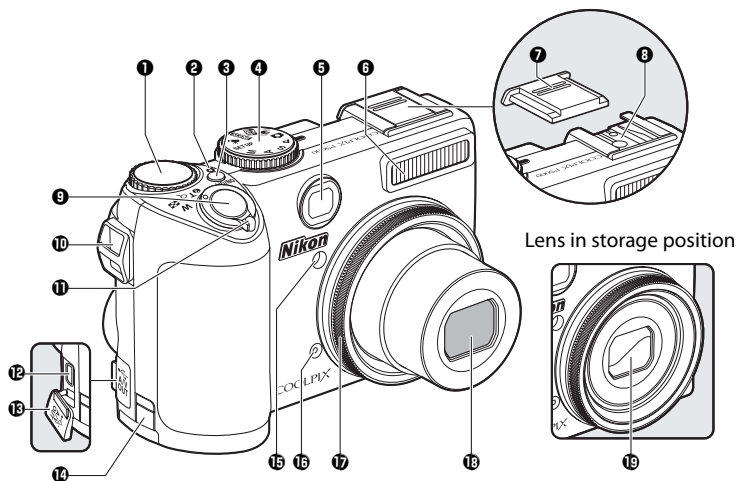
Parts of the Camera



Lens in storage position

1 Command dial.....	23, 29, 43, 48, 50, 52, 89	11 Zoom control.....	19
2 Power-on lamp	16	 (thumbnail playback)	43
3 Power switch	12	 (playback zoom).....	43
4 Mode dial.....	6	 (help).....	7
5 Viewfinder	18	12 Cable connector.....	55, 58, 61
6 Built-in flash.....	24	13 Connector cover	55, 58, 61
7 Accessory shoe cover	93	14 Power connector cover for optional AC adapter kit.....	90
8 Accessory shoe (for optional flash unit).....	93	15 Self-timer lamp.....	26, 94
9 Shutter-release button	20–21	AF-assist illuminator	25, 94
10 Eyelet for camera strap (x2).....	3	16 Microphone	46, 47, 51
		17 Lens ring.....	92
		18 Lens.....	96, 108
		19 Lens cover.....	94

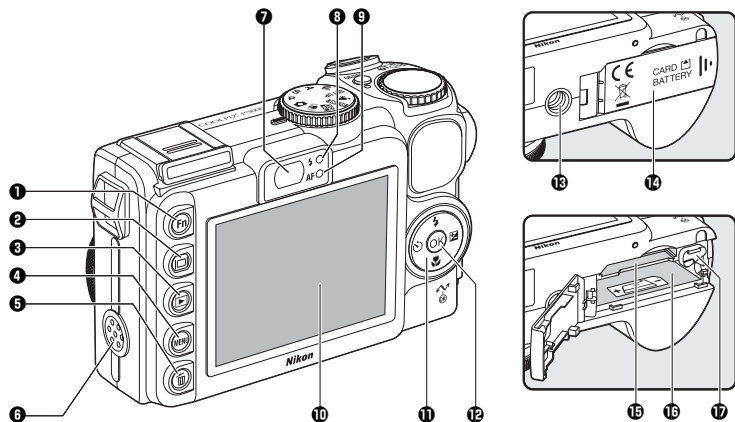

1 Fn (FUNC) button.....	29, 48, 89	11 Multi selector.....	7
2 (monitor) button	8	12 button.....	7
3 (playback) button	22, 23	(transfer) button	58
4 MENU (menu) button.....	29, 48, 53, 65, 80	13 Tripod socket	
5 (delete) button	22, 43, 46, 50, 52	14 Battery-chamber/memory card slot cover	10, 14
6 Speaker		15 Memory card slot	14
7 Viewfinder.....	18	16 Battery chamber	10
8 Flash lamp	24	17 Battery latch.....	10
9 Autofocus (AF) lamp.....	20		
10 Monitor	4-5, 16-17, 18, 85, 96, 108		

Attaching the Camera Strap

Attach the strap as shown at right. Repeat for the second eyelet.

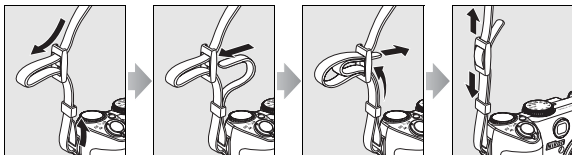

The Monitor

The following indicators may appear in the monitor during shooting and playback (actual display varies with current camera settings).

Shooting

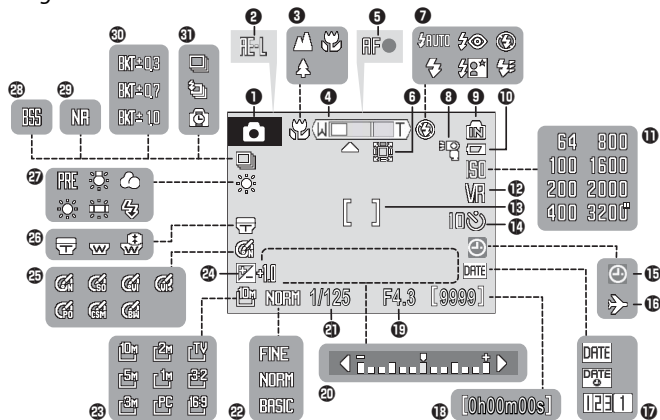

1 Shooting mode.....	17, 29, 36, 37, 38	17 Date imprint/date counter	86
2 Exposure lock	35	18 Number of exposures remaining... 16, 67	
3 Focus mode	27	Movie length	47
4 Zoom indicator	19	19 Aperture	38, 39, 41, 42
5 Focus indicator.....	20	20 Exposure display	42
6 Digital zoom interpolation indicator... 19		21 Shutter speed.....	38, 39, 40, 42
7 Flash mode (built-in flash).....	24	22 Image quality	66
8 Flash mode (optional flash unit)	25	23 Image size	66
9 Internal memory indicator.....	17, 21	24 Exposure compensation	28
10 Battery level indicator.....	16	25 Image optimization *.....	68–69
11 ISO sensitivity	25, 71	26 Converter lens setting *	79
12 Vibration reduction	87	27 White balance *	70
13 Focus area	20, 33, 76	28 Best Shot Selector (BSS) *	75
14 Self-timer indicator	26	29 Noise reduction *	78
15 “Date not set” indicator.....	97	30 Bracketing *	75
16 Time zone indicator.....	85	31 Continuous shooting mode *	73

* Displayed only in **P**, **S**, **A**, **M**, and **ISO** modes.

Playback

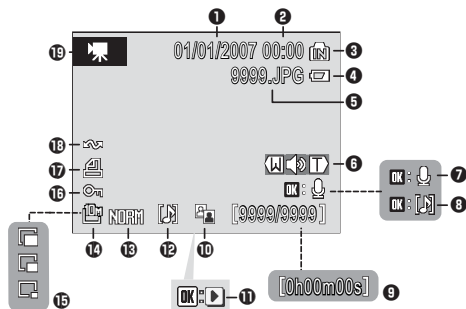

1 Date of recording	12–13, 84	10 D-Lighting icon.....	44
2 Time of recording	12–13, 84	11 Movie playback indicator	50
3 Internal memory indicator	17	12 Voice memo icon.....	46
4 Battery level indicator	16	13 Image quality	66
5 File number and type	106	14 Image size	66
6 Volume indicator	46, 50	15 Small picture indicator	45
7 Voice memo recording guide.....	46	16 Protect icon	81
8 Voice memo playback guide.....	46	17 Print-order icon.....	64
9 Current frame number/ total number of frames.....	22	18 Transfer icon.....	56, 82, 89
Movie length.....	50	19 Movie indicator.....	50

The Mode Dial

To select a mode, align the mode icon with the mark next to the mode dial.

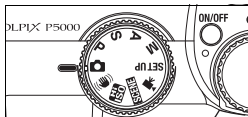

Auto (📷 16): A simple “point-and-shoot” mode recommended for first-time users of digital cameras.

Anti-shake (👉 36): Prevent or reduce blur using vibration reduction and the Best Shot Selector (BSS).

High sensitivity (ISO 37): Choose this mode to reduce blur when the subject is poorly lit.

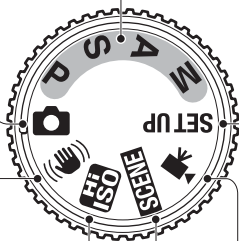

P, S, A, M (📷 38): Choose these modes for greater control over shutter speed and aperture.

SETUP Setup (⚙️ 83): Display the setup menu, where you can perform such tasks as setting the camera clock and adjusting monitor brightness.

Movie (🎬 47): Choose from seven movie modes.

SCENE Scene (🎭 29): Make voice recordings or choose from sixteen “scenes” suited to different subjects or shooting conditions and let the camera do the rest.

The Multi Selector

The multi selector is used to navigate the camera menus and to display the flash mode, self-timer, focus mode, and exposure compensation menus.

Changing Settings (Shooting Mode)

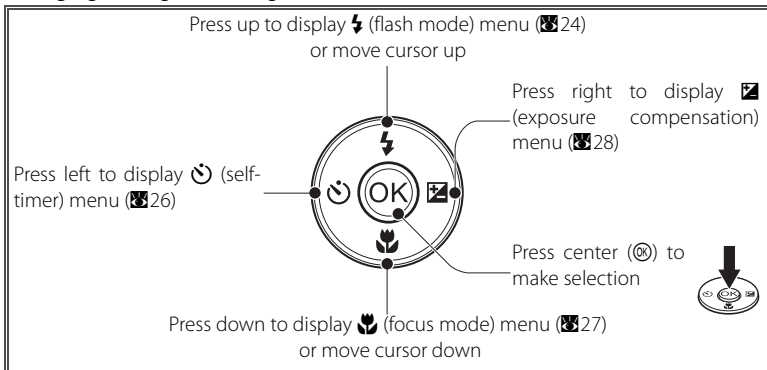

Navigating the Camera Menus (P.65)

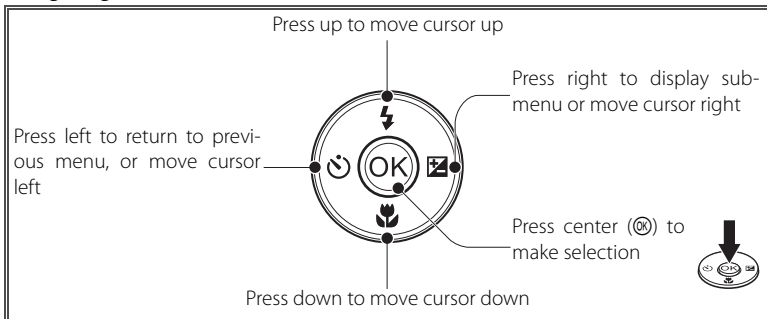

Lost?

If a question mark ("") is displayed in the monitor, help for the current menu item can be displayed by pressing the zoom control to **T** (). To return to the original menu, press the zoom control to **T** () again.

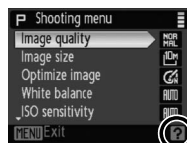

The Button

To hide or display indicators in the monitor, press the  button.



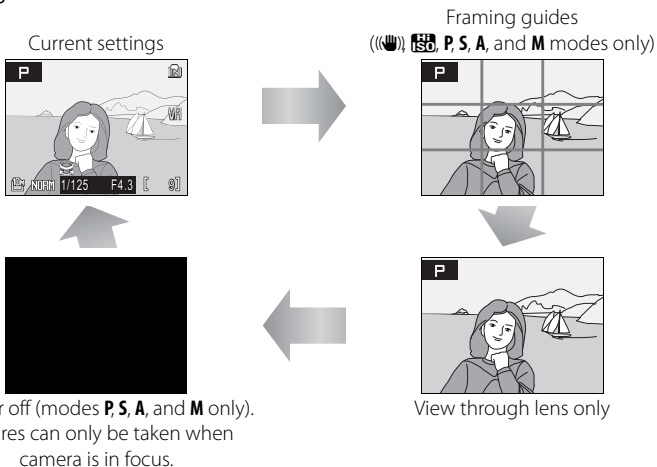

Shooting

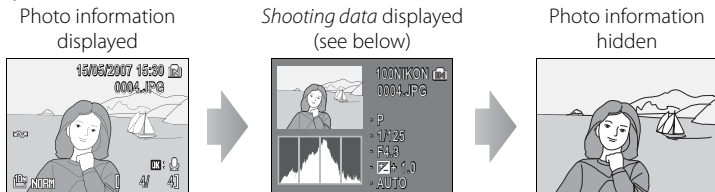

Playback



Shooting data: Shows the folder name, file name, *exposure mode*, shutter speed, aperture, exposure compensation, ISO sensitivity, and *histogram* for the current picture. Shooting data are not displayed if the current picture is a movie.

- **Exposure mode:** **P**, **S**, **A**, or **M** ( 38). **P** is also displayed on pictures taken in  (auto), () (anti-shake),  (high sensitivity), and scene modes.
- **Histogram:** A graph showing tone distribution. The horizontal axis corresponds to pixel brightness, with dark tones to the left and bright tones to the right; the vertical axis shows number of pixels of each brightness in image.

First Steps

Charging the Battery

The camera uses a rechargeable EN-EL5 Li-ion battery (supplied). Charge the battery with the supplied MH-61 battery charger before first use or when the battery is running low.

1 Plug the charger in

Connect the power cable to the charger (①) and then plug it into a power outlet (②). The CHARGE lamp will light (③).

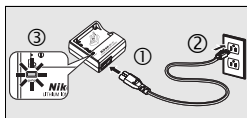

2 Insert the battery

Remove the battery terminal cover and insert the battery as shown, matching the projections on the battery to the indentations in the charger.

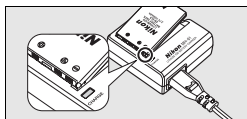

3 Charge the battery

The CHARGE lamp will blink as the battery recharges. (If the lamp flickers rapidly, either the temperature is not in the range of 5–35°C/41–95°F supported by the charger or the battery is faulty. If the battery is faulty, unplug the charger immediately and bring the battery and charger to a Nikon-authorized service representative for inspection.) A fully-exhausted battery will charge in about two hours.

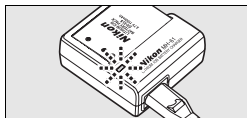

Charging is complete when the CHARGE lamp stops blinking. Remove the battery and unplug the charger.

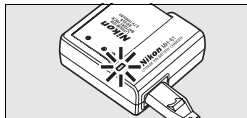

The Battery Charger

Read and follow the warnings on pages ii–iii of this manual. Use with compatible batteries only.

Inserting the Battery

After charging the battery, insert it as described below.

- 1 Open the battery-chamber/memory card slot cover

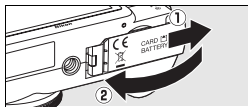

- 2 Insert the battery
- Insert the battery in the orientation shown in the label inside the battery chamber. The orange battery latch is pushed aside as the battery is inserted. The battery is fully inserted when the latch clicks back into place.

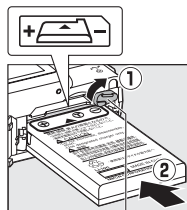

Battery latch

✓ Inserting the Battery

Inserting the battery upside down or backwards could damage the camera. Check to be sure the battery is in the correct orientation.

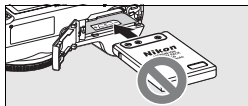

- 3 Close the battery-chamber/memory card slot cover

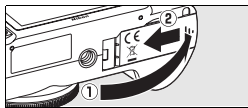

✓ Batteries

Read and follow the warnings and cautions on pages ii–iii and 95 of this manual. The camera can be used with EN-EL5 batteries only; **do not, under any circumstances, attempt to use other types.** If desired, the optional EH-62A AC adapter kit can be used to power the camera for extended periods (Ⓜ 90). **Do not, under any circumstances, use another make or model of AC adapter.** Failure to observe this precaution could result in overheating or in damage to the camera.

Removing the Battery

Turn the camera off before removing or inserting batteries. To eject the battery, open the battery-chamber/memory card slot cover and slide the battery latch in the direction shown. The battery can then be removed by hand. Note that the battery may become hot during use; observe due caution when removing the battery.

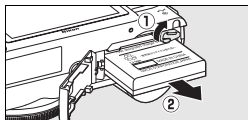

Turning the Camera on and Off

To turn the camera on, press the power switch. The green power-on lamp lights and the monitor turns on. To turn the camera off, press the power switch again.

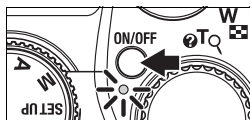

Press and hold the  button to turn the camera on in playback mode ( 22).

Basic Setup

A language-selection dialog is displayed the first time the camera is turned on. Use the multi selector to choose a language and set the time and date as described below (in the steps that follow, the multi selector controls used are highlighted in white).

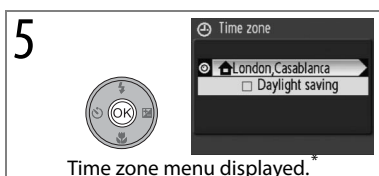
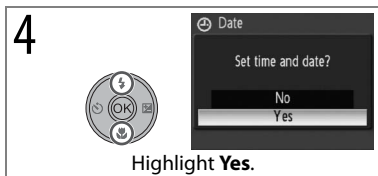
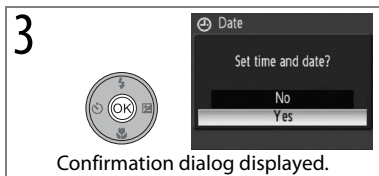
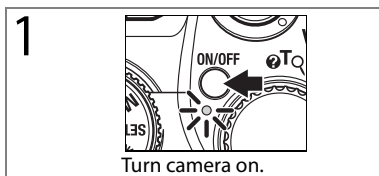

* If daylight saving time is in effect, press multi selector down to highlight **Daylight saving** and press  to select. Press multi selector up to return to Step 5. See page 85 for more information on turning daylight saving time on and off.

7



Select home time zone.



8



Display **Date** menu.

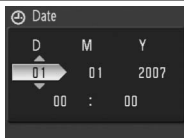

9



Edit **Day** (order of day, month, and year may differ in some areas).

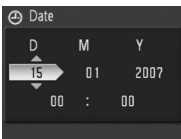

10



Select **Month**. Repeat Steps 9–10 to edit **Month, Year, hour, and minute**.

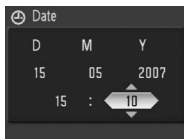

11



Choose date display order.

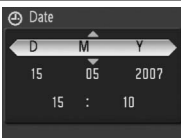

12



Set clock and exit to shooting mode.



Inserting Memory Cards

Pictures are stored in the camera's internal memory (approximately 21 MB) or on removable Secure Digital (SD) memory cards (📷 91). Internal memory is used for recording, playback, and deletion only if no memory card is inserted.

To insert a memory card:

1 Turn the camera off

If the power-on lamp is lit, press the power switch to turn the camera off.

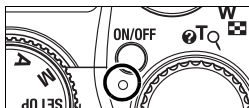

2 Insert the memory card

Open the battery-chamber/memory card slot cover and slide the memory card in until it clicks into place. Close the cover.

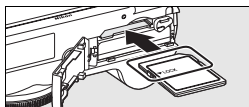

📷 Inserting Memory Cards

Be sure the card is in the correct orientation. Inserting the card upside down or backwards could damage the camera or card.

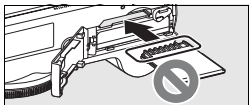

📷 Memory Cards

- Use only Secure Digital (SD) memory cards.
- Memory cards that have been formatted in a computer or other device must be reformatted in the camera before they can be used for recording or playback (📷 15, 88).
- Turn the power off before inserting or removing memory cards. Do not open the battery-chamber/memory card slot cover, turn the camera off, or remove or disconnect the power source during formatting or while data are being recorded, deleted, or copied to a computer. Failure to observe these precautions could result in loss of data or in damage to the camera or card.
- Do not disassemble or modify.
- Do not bend, drop, or subject to strong physical shocks.
- Do not touch the card terminals with your fingers or metal objects.
- Do not affix labels or stickers to memory cards.
- Do not leave in direct sunlight, closed vehicles, or areas exposed to high temperatures.
- Do not expose to high levels of humidity or to corrosive gas.

Removing Memory Cards

Before removing memory cards, **turn the camera off** and confirm that the power-on lamp is off. Open the battery-chamber/memory card slot cover, press the card in to partially eject it, and then remove it by hand.

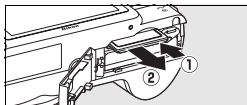

Formatting Memory Cards

If the message shown at right is displayed when the camera is turned on, the memory card must be formatted before use. Note that **formatting permanently deletes all pictures** and other data on the memory card. Be sure to make copies of any pictures you wish to keep before beginning formatting.



To begin formatting, press the multi selector up to highlight **Format** and then press **OK**. **Do not turn the camera off or remove the battery or memory card until formatting is complete.**

The Write Protect Switch

SD cards are equipped with a write protect switch. Pictures can not be recorded or deleted and the memory card can not be formatted when this switch is in the "lock" position.

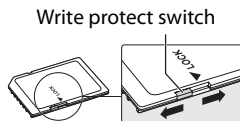

Basic Photography and Playback

Mode

This section describes how to take pictures in  (auto) mode, an automatic, “point-and-shoot” mode recommended for first-time users of digital cameras.

- 1 Select  mode
Rotate the mode dial to .

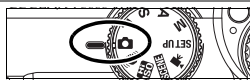

- 2 Turn the camera on

2.1 Turn the camera on

Press the power switch to turn the camera on. The green power-on lamp lights, the monitor turns on, and the lens extends.

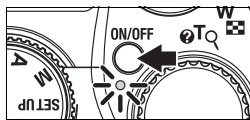



2.2 Check indicators in the monitor



Check the battery level and number of exposures remaining.



Number of exposures remaining*

Battery indicator

	Battery fully charged.
	Low battery; prepare to recharge or change battery.
 Warning! Battery exhausted.	Battery exhausted. Recharge or change battery.

* Depends on capacity of internal memory or memory card ( 14) and on options chosen for image quality ( 66) and size ( 66).

Auto Power off (Stand-by Mode)

In shooting mode, the monitor will dim to reduce the drain on the battery if no operations are performed for about five seconds. The monitor will brighten when camera controls are used. At default settings, the monitor will turn off altogether if no operations are performed for about a minute during shooting and playback (stand-by mode;  88). While the camera is in stand-by mode, the power-on lamp will blink and the monitor can be reactivated by pressing the shutter-release button halfway. The camera will turn off automatically if no operations are performed for another three minutes.

In  (auto) mode, the following indicators are also displayed.

Shooting mode:  is displayed in  (auto) mode.







Internal memory indicator: If  is displayed, pictures will be recorded to internal memory. If memory card is inserted,  icon is no longer displayed and pictures are recorded to memory card.

Image quality and size: Choose image quality ( 66) and size ( 66) according to how picture will be used. Default settings are normal image quality (**NORM**) with an image size of 3,648×2,736 ().



Vibration reduction:  is displayed when vibration reduction is on (see below).

Aperture ( 38)

Shutter speed ( 38)

Vibration Reduction

When vibration reduction is on (the default setting), the camera compensates for slight hand movements that can blur pictures at slow shutter speeds or high zoom ratios.



Image Quality and Size

In  (auto mode), pressing the **MENU** button displays options for adjusting image quality ( 66) and size ( 66).

3 Frame a picture

3.1 Ready the camera

Hold the camera steadily in both hands, keeping your fingers and other objects away from the lens, flash, and microphone. When taking pictures in portrait orientation with the camera rotated 90°, hold the camera with the flash uppermost.

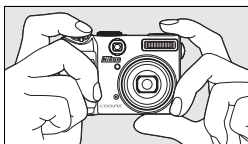

3.2 Frame the picture

Frame the picture with the subject positioned in approximately the center of the monitor or viewfinder.



The Viewfinder

Use the viewfinder to frame pictures when bright light makes it difficult to see the display in the monitor. Note that because the image in the viewfinder may differ from the final picture, the monitor should be used at distances of about 1 m (3ft. 3in.) or less, at image sizes of 3,648×2,432 (32) or 3,584×2,016 (169), or when using converter lenses (available separately; 79, 90) or digital zoom (19).

Zoom



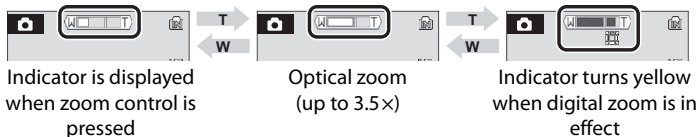



The zoom control can be used to frame subjects in the monitor or viewfinder. Select **W** to zoom out, increasing the area visible in the frame. Select **T** to zoom in up to 3.5× so that the subject fills a larger area of the frame. The amount of zoom is displayed in the monitor.





Holding the control to **T** at 3.5× zoom will trigger *digital zoom*, allowing the subject to be magnified up to 4× more, for a total magnification of 14×.

Digital Zoom

If possible, digital zoom will create a picture by cropping the area visible in the monitor to the current image size (66), increasing magnification without affecting quality. If the crop would be smaller than the current image size, additional pixels are added through a process known as *interpolation*, creating a slightly “grainy” image. The amount of zoom available before interpolation is used depends on the option currently selected for image size, as shown in the following table.

Image size	Max. zoom without interpolation		Image size	Max. zoom without interpolation	
	Digital zoom	Total magnification		Digital zoom	Total magnification
	1.4 ×	4.9 ×		2.8 ×	9.8 ×
	1.6 ×	5.6 ×		3.4 ×	11.9 ×
	2.2 ×	7.7 ×		4.0 ×	14.0 ×

 is displayed when interpolation is in effect. Using digital zoom at sizes of 3,648 × 2,736 () , 3,648 × 2,432 () , or 3,584 × 2,016 () always triggers interpolation.

4 Focus and shoot

4.1 Focus

Lightly press the shutter-release button about halfway, stopping when you feel resistance. In  mode, the camera automatically sets focus and exposure for the subject in the center focus area.

- **If the camera is able to focus**, the focus indicator and focus area will be displayed in green, and the green AF lamp next to the viewfinder will light. Proceed to Step 4.2.
- **If the camera is unable to focus**, the focus indicator and focus area blink red, and the green AF lamp next to the viewfinder will flicker. Change the composition and try again.

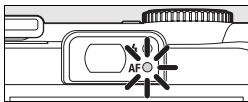
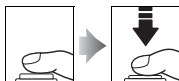

Digital Zoom

The focus area is not displayed when digital zoom is in effect.

Getting Good Results with Autofocus

Autofocus performs best when there is contrast between the subject and the background and the subject is evenly lit. It does not perform well if the subject is very dark or moving rapidly, if there are objects of sharply differing brightness in the scene (e.g., the sun is behind the subject and their features are in deep shadow), or if the focus area contains objects at different distances from the camera (e.g., the subject is inside a cage). If the camera is unable to focus using autofocus, change the composition, press the shutter-release button halfway several times to refocus, or use focus lock () to focus on another subject at the same distance and then recompose the photograph.

4.2 Take the picture

Gently press the shutter-release button the rest of the way down to take the picture (moving the camera while pressing the shutter-release button can result in blurred pictures). The AF-assist illuminator may light or the flash may fire if the subject is poorly lit (📖 24–25).



🔍 During Recording

While pictures are being recorded, a 📷 or 📹 icon will blink in the monitor and a ⌚ (wait) icon may be displayed. Opening the battery-chamber/memory card slot cover or removing memory cards or batteries while the 📷 or 📹 icon is blinking or the ⌚ icon is displayed could affect pictures or damage the camera or card.

📷 The Shutter-Release Button

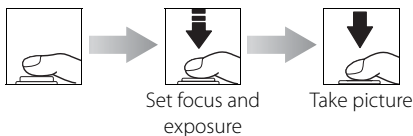

To set focus and exposure, press the shutter-release button about halfway, stopping when you feel resistance. Focus and exposure lock while the shutter-release button is held in this position. To release the shutter and take a picture, press the shutter-release button down the rest of the way. Use a gentle touch; moving the camera while pressing the shutter-release button can result in blurred pictures.

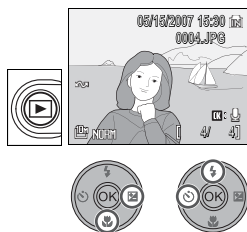

Viewing Pictures

Press the  button to display the most recent picture full-frame in the monitor (*full-frame playback*). Use the multi selector to view additional pictures: press the multi selector down or right to view pictures in the order recorded, up or left to view pictures in reverse order. Keep the multi selector pressed to scroll rapidly to the desired picture. Pictures may be displayed briefly at low resolution while being read from memory.



If no memory card is inserted in the camera, a  icon is displayed and pictures are played back from internal memory. If a memory card is inserted, the  icon will not be displayed and pictures will be played back from the memory card.

Press the  button again or press the shutter-release button to return to shooting mode when playback is complete.

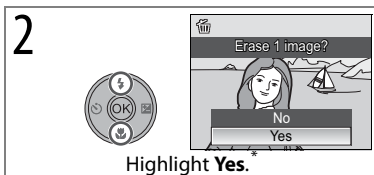
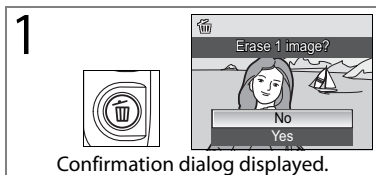

Deleting Unwanted Pictures

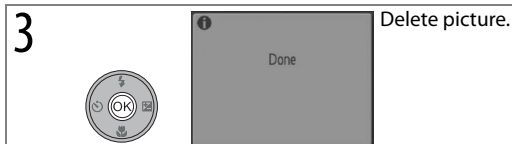

* To exit without deleting picture, highlight **No** and press .











Deleting the Last Shot

To delete the most recent picture, press the  button while the camera is in shooting mode. A confirmation dialog will be displayed; highlight **Yes** and press  to delete the last shot taken.

Full-Frame Playback

The following operations can be performed during full-frame playback:

To	Use	Description	
View other pictures	 or 	Press multi selector to down or right, or rotate command dial right, to view pictures in order recorded. Press multi selector up or left, or rotate command dial left, to view pictures in reverse order.	—
Zoom picture in	T 	Zoom current picture in 3×, with center of picture displayed in monitor (<i>quick playback zoom</i>). Press  to return to full-frame playback.	43
View thumbnails	W 	View multiple pictures.	43
Hide or display photo info		Hide or display photo info in monitor.	8
Record/play voice memo		Record or play voice memos of up to 20s in length.	46
Exit to shooting mode	 or shutter-release button	End playback and return to shooting mode.	—

Turning the Camera on in Playback Mode

To turn the camera on in playback mode, press and hold the  button. The most recent picture will be displayed full-frame in the monitor, but the lens will not extend.

Viewing Pictures in Internal Memory

Pictures can only be played back from internal memory if no memory card is inserted. If an empty memory card is inserted, the message “Memory contains no images” will be displayed. To view the pictures in internal memory, remove the memory card or use the **Copy** option in the playback menu to copy the pictures to the memory card ( 82).

Using the Flash

The flash has a range of 0.3–8m (1–26ft.) when the camera is zoomed all the way out. The range at maximum zoom is 0.3–4m (1–13ft.). The following flash modes are available:

Mode	Description
AUTO Auto	Flash fires automatically when lighting is poor.
Auto with red-eye reduction	Advanced red-eye reduction is used to reduce “red-eye” in portraits (see following page).
Off	Flash will not fire even when lighting is poor.
Fill flash	Flash fires whenever picture is taken. Use to “fill in” (illuminate) back-lit subjects.
Slow sync	Combines auto flash with slow shutter speeds. Flash illuminates main subject; slow shutter speeds capture background at night or under dim light
Rear-curtain sync	Flash fires just before shutter closes, creating effect of a stream of light behind moving subjects.

1



Display options.

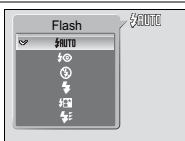

2



Highlight mode.

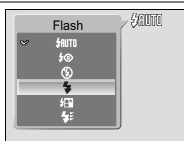

3



Make selection (to exit without changing mode, wait five seconds). Selection is shown by icon in display (if AUTO is selected, AUTO icon is displayed for five seconds only). Except in P, S, A, M, and ISO modes or when picture has been taken with AUTO or (auto with red-eye reduction) selected in mode, flash mode is not stored when camera is turned off.

The Flash Lamp

The flash lamp shows flash status when the shutter-release button is pressed halfway.

- **On:** Flash will fire when picture is taken.
- **Blinks:** Flash charging. Wait a few seconds and try again.
- **Off:** Flash off or not required.

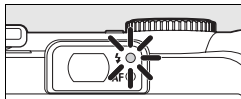

Advanced Red-Eye Reduction

This camera uses advanced red-eye reduction ("In-Camera Red-Eye Fix"). The flash fires repeatedly at low intensity before the main flash, reducing red-eye. The camera then analyzes the picture; if red-eye is detected, the affected area will be processed to further reduce red-eye before the picture is saved. Note that because there is a slight lag between the shutter-release button being pressed and the picture being taken, this mode is not recommended when a quick shutter response is required. The time before the next picture can be taken also increases slightly. Advanced red-eye reduction may not produce the desired results in all situations. In extremely rare instances, areas not subject to red-eye may be affected by advanced red-eye reduction processing; in these cases, choose another mode and try again.

When Lighting Is Poor

When lighting is poor and the flash is off (🔴), shutter speeds may slow and pictures may be blurred. Blur can be reduced by placing the camera on a steady, level surface or by turning **Vibration reduction** (🔴 87) off and using a tripod.

If an **ISO** icon is displayed, sensitivity has been raised to compensate for poor lighting and pictures may be affected by "noise" in the form of randomly-spaced, brightly colored dots (🔴 71).

Dust or Mist

Light from the flash reflected from particles of dust or other matter in the air may appear in pictures as bright specks. If this occurs, turn the flash off and try again.

The AF-Assist Illuminator

If lighting is poor, the AF-assist illuminator may light to assist the focus operation when the shutter-release button is pressed halfway. The illuminator has a maximum range of about 1.8m/5ft. 11in. (W) to 1m/3ft. 3in. (T). The AF-assist illuminator is not available in some modes (🔴 30–33) and can also be turned off manually (🔴 87), although in this case the camera may not focus when lighting is poor.







Optional Flash Units

See page 93 for information on using optional flash units mounted on the camera accessory shoe. The flash modes available with optional flash units are the same as for the built-in flash.



Taking Pictures with the Self-Timer



The camera is equipped with ten- and three-second timers for self-portraits and to reduce blur. When using the self-timer, mount the camera on a tripod or rest it on a flat, level surface. Be sure to turn vibration reduction off when using a tripod (📷 87).



- 

Display self-timer menu.
- 

Highlight option.

 - **10s:** 10s timer. Use for self portraits.
 - **3s:** 3s timer. Use to reduce blur.
- 

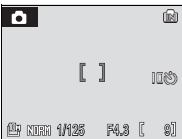
Make selection (to exit without changing mode, wait five seconds). Selection appears next to 📷 icon in display.
- 

Frame picture and press shutter-release button halfway to set focus and exposure.
- 





Start timer; display in monitor shows seconds remaining before shutter is released. To stop timer before picture is taken, press shutter-release button again.

The self-timer lamp will blink until one second before the picture is taken, staying lit during the final second to warn that the shutter is about to be released.



Choosing a Focus Mode

Choose a focus mode according to the subject and composition.

Mode	Description
AF Autofocus	Camera automatically adjusts focus according to distance to subject. Use when subject is 30cm/1ft. or more from lens (70cm/2ft. 4in. or more when camera is zoomed all the way out).
 Infinity	Use when shooting distant scenes through foreground objects such as windows or when shooting landscapes at ranges of 5m/16ft. 5in. or more. Flash turns off automatically.
 Focusing limit	Use for faster focus at ranges of 2m/6ft. 7in. or more.
 Macro close-up	Use for close-ups. If zoomed in or out until  icon in display turns green, camera can focus on objects as close as 4cm/1.6in. to lens. Camera focuses continuously until shutter-release button is pressed halfway.

1

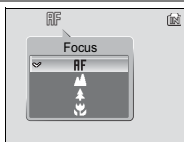

Display options.

2



Highlight mode.

3



Make selection (to exit without changing mode, wait five seconds). Selection is shown by icon in display (if **AF** is selected, **AF** icon is displayed for five seconds only). Option last selected in **P**, **S**, **A**, **M**, or **ISO** mode is stored when camera is turned off.

Exposure Compensation

In modes other than **M**, exposure compensation is used to alter exposure from the value selected by the camera. Choose from values between -2.0 and $+2.0$ EV in increments of $\frac{1}{3}$ EV.

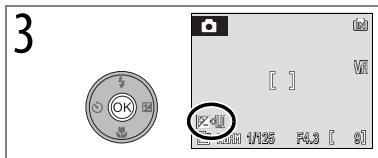
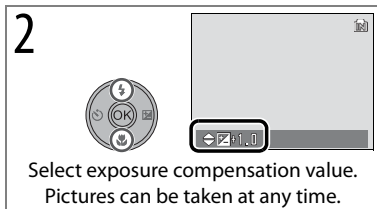
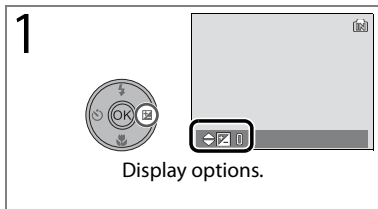

Exposure compensation is not available in mode **M**.

Using Exposure Compensation

The camera tends to lower exposure when the frame is dominated by brightly lit objects and to increase exposure when the frame is mostly dark. *Positive* compensation may therefore be required to capture the brilliancy of very bright objects that fill the frame (for example, sunlit expanses of water, sand, or snow) or when the background is much brighter than the main subject. *Negative* compensation may be called for when large areas of the frame contain very dark objects (for example, a swath of dark green leaves) or when the background is much darker than the main subject.

Scene Mode

The camera offers a choice of sixteen scenes. Camera settings are automatically optimized for the selected subject type. Scene mode can also be used to make voice recordings (51).

Face-priority AF	Portrait	Landscape	Sports
Night portrait	Party/Indoor	Beach/Snow	Sunset
Dusk/Dawn	Night landscape	Close up	Museum
Fireworks show	Copy	Back light	Panorama assist
Voice recording (51)	Image quality (66)	Image size (66)	

To take pictures in scene mode:

1

Display last selected scene.*

2

Display scene menu.

* To skip Steps 2–4, press **Fn** button and rotate command dial until desired scene is displayed in monitor.



3

Highlight option.†

4





































Exit to selected scene.

† To exit without changing scene selection, press **MENU**.

5









































Take pictures.

The following scenes are available:

 Face-Priority AF	
Frame portrait shots of from one to three subjects from the waist up (34). The camera automatically detects and focuses on the faces of the subjects. • Digital zoom is not available.	
   OFF*  AF  0*	
 Portrait	
Use for smooth, natural-looking portraits. The focus area can be selected using the multi selector (33). • Digital zoom is not available.	
   OFF*  AF  0*	
 Landscape	
Create vivid landscape shots that enhance outlines, colors, and contrast in such subjects as skies and forests. • Camera focuses at infinity; AF lamp lights and focus indicator is displayed in green whenever shutter-release button is pressed halfway. AF-assist illuminator will not light even if lighting is poor.	
   OFF*    0*	
 Sports	
Freeze action with fast shutter speeds. The camera focuses continuously on the subject in center of frame until the shutter-release button is pressed halfway to lock focus. While the shutter-release button fully pressed, the camera shoots up to eight pictures at about 0.8fps (image quality Normal , image size 3,648×2,736 (10)); frame rate may vary with image quality and size and make of memory card). • Focus, exposure, and white balance are determined by first shot in each series. • AF-assist illuminator will not light even when lighting is poor.	
   OFF  AF  0*	
 Night Portrait  NR	
Capture background lighting in portraits taken at night or under low light. The focus area can be selected using the multi selector (33). • Digital zoom is not available.	
   OFF*  AF  0*	











* Other options can be selected.

† Slow-sync fill-flash with red-eye reduction.



<p> Party/Indoor</p> <p>Use for shots that include details of the background, or to capture the effects of candlelight and other indoor background lighting.</p> <ul style="list-style-type: none"> • Camera focuses on subject in center of frame. • Hold camera steadily in both hands to prevent blur. <p>  or   OFF*  AF  0*</p>	
<p> Beach/Snow</p> <p>Capture the brightness of such subjects as snowfields, beaches, or sunlit expanses of water.</p> <ul style="list-style-type: none"> • Camera focuses on subject in center of frame. <p>  AUTO*  OFF*  AF  0*</p>	
<p> Sunset </p> <p>Preserve the deep hues seen in sunsets and sunrises.</p> <ul style="list-style-type: none"> • Camera focuses on subject in center of frame. <p>  *  OFF*  AF  0*</p>	
<p> Dusk/Dawn  NR</p> <p>Preserve colors in the weak natural light before sunrise or after sunset.</p> <ul style="list-style-type: none"> • Camera focuses at infinity; AF lamp lights and focus indicator is displayed in green whenever shutter-release button is pressed halfway. AF-assist illuminator will not light even if lighting is poor. <p>  *  OFF*    0*</p>	
<p> Night Landscape  NR</p> <p>Slow shutter speeds produce stunning night landscapes.</p> <ul style="list-style-type: none"> • Camera focuses at infinity; AF lamp lights and focus indicator is displayed in green whenever shutter-release button is pressed halfway. AF-assist illuminator will not light even if lighting is poor. <p>  *  OFF*    0*</p>	

* Other options can be selected.

Setting Icons

The default flash (;  24), self-timer (;  26), focus (;  27), and exposure compensation (;  28) settings for each mode are shown below the scene description. A  icon to the right of the scene name indicates that a tripod is recommended to avoid blur at slow shutter speeds. Be sure to turn vibration reduction off when using a tripod. A  icon indicates that pictures may be processed to reduce noise, resulting in increased recording times.

Close Up

Take close-ups of flowers, insects, and other small objects, with the background artistically blurred. The camera zooms to the macro close-up position and the macro close-up icon () turns green, indicating that the camera can focus as close as 4cm (1.6in.) to the lens (minimum focus distance varies with zoom position). The focus area can be selected using the multi selector ( 33). The camera focuses continuously until the shutter-release button is pressed halfway to lock focus.



- Hold camera steadily in both hands to prevent blur.



Museum

Use indoors where flash photography is prohibited (for example, in museums or art galleries) or in other settings in which you do not wish to use the flash. The AF-assist illuminator turns off and the camera takes up to ten shots while the shutter-release button is pressed, using the Best Shot Selector (BSS;  75) to select the clearest picture.



- Photography may be prohibited altogether in some settings. Be sure to obtain permission first.
- Hold camera steadily in both hands to prevent blur.



Fireworks Show

Slow shutter speeds are used to capture the expanding burst of light from a firework.

- Camera focuses at infinity; AF lamp lights and focus indicator is displayed in green whenever shutter-release button is pressed halfway. AF-assist illuminator will not light even if lighting is poor.



Copy

Provides clear pictures of text or drawings in printed matter or on a white board. Use macro close-up ( 27) to focus at short ranges.

- Colored text and drawings may not show up well.
- Camera focuses on subject in center of frame.

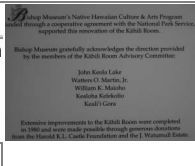

* Other options can be selected.

†  (macro close-up) can be selected.

Back Light

Use when light is coming from behind a portrait subject, throwing their features into shadow. The built-in flash fires automatically to “fill in” (illuminate) shadows.

- Camera focuses on subject in center of frame.



Panorama Assist







Use when taking a series of pictures that will later be joined together in PictureProject to form a panorama ( 35).



* Other options can be selected.

Focus Area Selection

In  (portrait),  (night portrait), and  (close up) modes, the focus area can be selected by pressing the  button. Press the multi selector up, down, left, or right to select from 99 focus areas, then press the  button again to return to shooting mode.

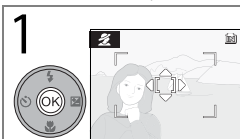

Display focus area.

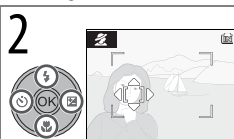

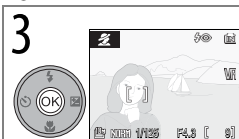

Select focus area.*





Exit to shooting mode.

* To end focus area selection and adjust flash, focus, self-timer, and exposure compensation settings, press .

Taking Pictures in Face-Priority AF Mode

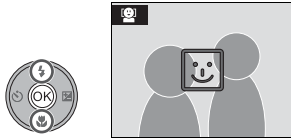
When  (face-priority AF) is selected in the scene menu ( 29), a  icon is displayed in the center of the monitor. Take pictures as described below.

- 

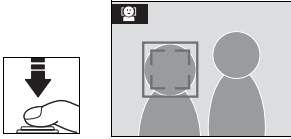
Frame picture using  icon as guide. When camera detects face,  will change to double yellow border. If camera detects multiple faces, it will focus on closest subject; other subjects are indicated by single border. If camera can no longer detect subject (for example, because subject has looked away from camera), borders will no longer be displayed; recompose picture.
- 

Set focus and exposure. Double border turns green.
- 



Take picture.

Face-Priority AF

The camera's ability to detect faces depends on a variety of factors, including whether or not the subject is facing the camera. The camera may be unable to detect faces that are hidden by sunglasses or other obstructions or that occupy too much or too little of the frame. If no face is detected when the shutter-release button is pressed halfway, the camera will focus on the subject in the center of the frame.

The camera will focus continuously until a face is detected. If the double border flashes yellow when the shutter-release button is pressed halfway, the camera is unable to focus; release the button and try again.

Taking Pictures for a Panorama

Selecting  (panorama assist) in the scene menu ( 29) displays the default pan direction as shown at right. Take pictures as described below. Use a tripod for better results.



1

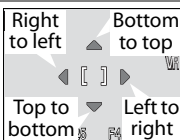

Select how pictures will be joined together in completed panorama. This is the direction in which camera will be panned after each shot.

2



Make selection (to return to Step 1, press  again). Pan direction displayed in white. Complete any changes to flash, self-timer, focus, or exposure compensation settings *before* proceeding to next step.

3



Take first shot; camera will focus on subject in center of frame. About one third of picture is superimposed on view through lens. **AE-L** icon turns white to show that white balance and exposure settings for this picture apply to all shots in series.

4



Compose next shot to overlap with previous picture.

5



Take next shot. Repeat steps 4–5 until all shots in series have been taken.

6



End series. Shooting will also end if new mode is selected or camera enters standby mode ( 16).

Panorama Assist

Flash, self-timer, focus, and exposure compensation can not be adjusted after the first picture is taken. Pictures can not be deleted or zoom, image quality, or image size adjusted until shooting is complete. See page 106 for information on how panoramas are stored.

(((Hand))) and ISO Modes

(((Hand))) (Anti-Shake) Mode

If the camera or the subject moves while the shutter is open, pictures can be blurred. In **(((Hand)))** (anti-shake) mode, vibration reduction (🔍 87) and BSS (Best Shot Selector; 🔍 75) turn on and ISO sensitivity (🔍 71) is raised to a maximum of ISO 1600, reducing blur caused by camera shake when the flash is off or the camera is zoomed in. Use this mode to capture natural lighting or when shooting subjects at a distance from the camera, for example when taking pictures of animals or when trying to capture natural expressions on a portrait subject.

To take pictures in anti-shake mode:

1

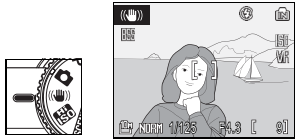

Rotate mode dial to **(((Hand)))**.

2

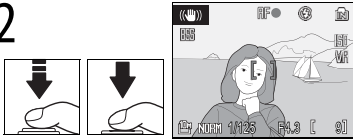

Focus (camera focuses on subject in center focus area) and shoot. Camera takes up to ten shots while shutter-release button is pressed and selects clearest picture (🔍 75).

🔍 **(((Hand))) (Anti-Shake) Mode**

Pictures taken in anti-shake mode may be affected by “noise” in the form of bright, randomly-spaced bright dots. The flash turns off automatically and the self-timer can not be used. Slower shutter speeds are not available, and consequently **ISO** (high sensitivity) mode is recommended to reduce blur when the subject is dark. Date imprint (🔍 86) is not available in anti-shake mode.

🔍 **Image Quality and Size**

Pressing the **MENU** button in **(((Hand)))** mode brings up a menu that contains options for adjusting image quality (🔍 66) and size (🔍 66).

Hi ISO (High Sensitivity) Mode

In **Hi ISO** (high sensitivity) mode, the camera automatically raises ISO sensitivity to a maximum of 1600, reducing blur when the subject is moving or poorly lit (87). To take pictures in **Hi ISO** mode:

1

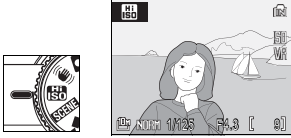

Rotate mode dial to **Hi ISO**.

2

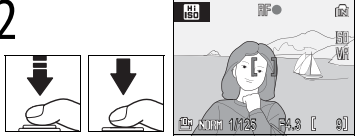

Take pictures. Camera automatically compares distances to subjects in nine focus areas and sets focus and exposure for closest subject.

Hi ISO (High Sensitivity) Mode

Pictures taken in **Hi ISO** mode may be affected by “noise” in the form of randomly-spaced, brightly-colored dots.

If the subject is poorly lit, shutter speeds will slow and pictures may be blurred. Turn vibration reduction (87) off and use a tripod for best results. The camera may be unable to focus if the subject is very dark.

The Shooting Menu

Pressing the **MENU** button in **Hi ISO** mode brings up a menu of shooting options (65). The **ISO sensitivity** option in the shooting menu is not available in **Hi ISO** mode.

Hi ISO (High Sensitivity) Versus (Anti-Shake)

Hi ISO (high sensitivity) mode is recommended when shooting indoors or under low light, (anti-shake) mode when the flash is off or the camera is zoomed in.

P, S, A, and M Modes

P, S, A, and **M** modes offer control over a variety of advanced settings, including shutter speed, aperture, and white balance.

Mode	Description
P Programmed auto (39)	Camera sets shutter speed and aperture for optimal exposure. Recommended for snapshots and in other situations in which there is little time to adjust camera settings.
S Shutter-priority auto (40)	User chooses shutter speed; camera selects aperture for best results. Use to freeze or blur motion.
A Aperture-priority auto (41)	User chooses aperture; camera selects shutter speed for best results. Use to blur background or bring both foreground and background into focus.
M Manual (42)	User controls both shutter speed and aperture.

Shutter Speed and Aperture

The same exposure can be achieved with different combinations of shutter speed and aperture, allowing you to freeze or blur motion and control depth of field. The following figure shows how shutter speed and aperture affect exposure.

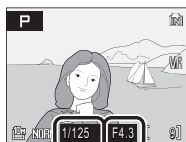

Shutter speed — Aperture



Fast shutter speed: $1/1,000$ S



Small aperture (large f-number): $f/7.6$



Slow shutter speed: $1/30$ S



Large aperture (small f-number): $f/2.7$

P: Programmed Auto

In this mode, the camera automatically adjusts shutter speed and aperture for optimal exposure. To take pictures in programmed auto:

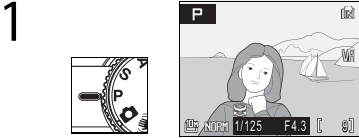
- 

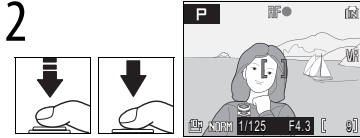
1 Rotate mode dial to **P**.
- 

2 Take pictures. Camera automatically compares distances to subjects in nine focus areas and sets focus and exposure for closest subject (76).

Flexible Program

In mode **P**, different combinations of shutter speed and aperture can be selected by rotating the command dial (“flexible program”). Rotate the command dial to the right for large apertures (small f-numbers) that blur background details or fast shutter speeds that “freeze” motion. Rotate the command dial to the left for small apertures (large f-numbers) that increase depth of field or slow shutter speeds that blur motion. All combinations produce the same exposure. While flexible program is in effect, an asterisk (“*”) appears next to the mode indicator (**P**) in the monitor. To restore default shutter speed and aperture settings, rotate the command dial until the indicator is no longer displayed, choose another mode, or turn the camera off.

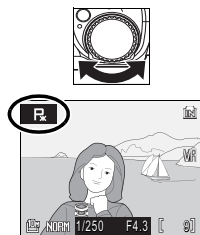

S: Shutter-Priority Auto

In shutter-priority auto, you choose the shutter speed from values between 8s and $1/2,000$ s and the camera sets aperture for optimum exposure.

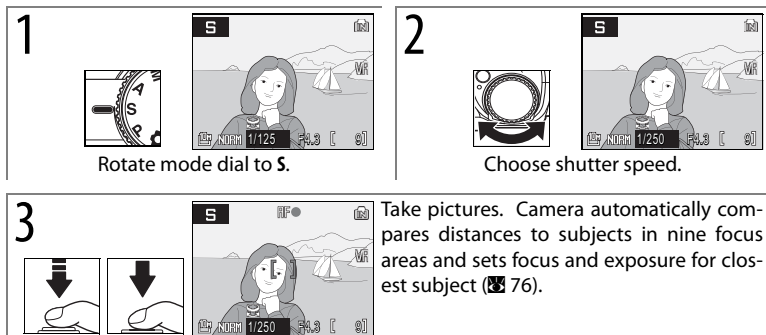

If the selected shutter speed would result in the picture being over- or underexposed, the shutter-speed display will flash when the shutter-release button is pressed halfway. Choose another shutter speed and try again. At speeds slower than $1/4$ s, the shutter speed indicator will turn red to show that noise reduction (78) is recommended to reduce "noise" in the form of randomly-spaced, brightly colored dots.

Shutter Speed

A shutter speed of $1/2,000$ s is only available when the camera is zoomed all the way out. Aperture is restricted to f/7.6.

A: Aperture-Priority Auto

In aperture-priority auto, you choose the aperture and the camera sets shutter speed for optimum exposure. When the camera is zoomed all the way out, aperture can be set to values between $f/2.7$ and $f/7.6$; at maximum zoom, aperture can be set to values between $f/5.3$ and $f/7.3$.

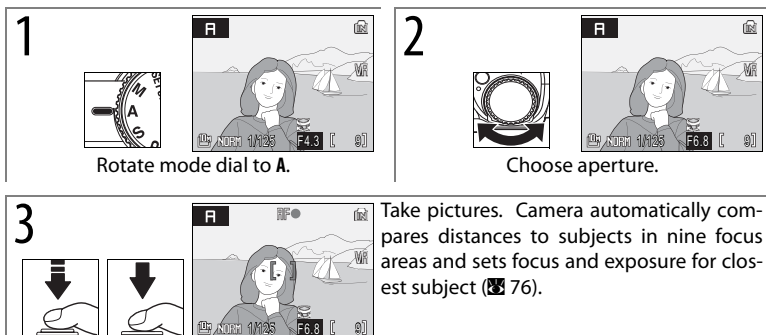

If the selected aperture would result in the picture being over- or underexposed, the aperture display will flash when the shutter-release button is pressed halfway. Choose another aperture and try again.







Aperture and Zoom

Aperture is expressed as an f-number, which is the ratio of the focal length of the lens to the effective diameter of the opening (aperture) through which light enters the camera. Large apertures (expressed by small f-numbers) let more light into the camera, small apertures (large f-numbers) less. When the camera is zoomed out, the focal length of the lens diminishes and the f-number decreases. When the camera is zoomed in, the focal length and f-number increase. In modes **A** and **M**, this effect can be minimized by selecting **On** for **Fixed aperture** (78).

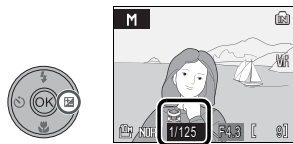
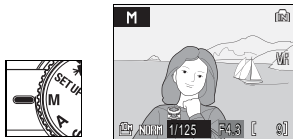
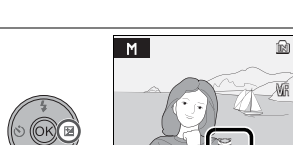
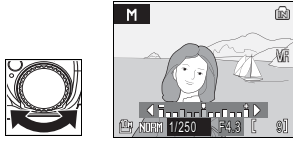
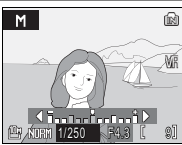
The COOLPIX P5000 has a lens with a focal length of 7.5–26.3 mm and an aperture of $f/2.7$ to $f/5.3$.

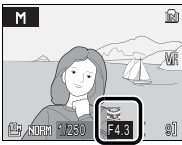
M: Manual

In mode **M**, the user controls both shutter speed and aperture.

-  Rotate mode dial to **M**.
-  Select shutter speed or aperture. Selected item changes each time multi selector is pressed to right.
-  Set selected item. Exposure display shows amount pictures will over- or underexposed at current settings (see below). Shutter speeds slower than $1/4s$ are displayed in red (⚠ 40). Shutter speed of $1/2,000s$ is only available if camera is zoomed all the way out and aperture is set to $f/7.6$.
-  Select remaining item (aperture or shutter speed). Repeat steps 3–4 until desired exposure is achieved.
-  Take pictures. Camera automatically compares distances to subjects in nine focus areas and sets focus and exposure for closest subject (⚠ 76).

The Exposure Display

The exposure display, which is displayed for a few seconds each time aperture or shutter speed is adjusted, shows the amount exposure deviates from the value selected by the camera in EVs (-2 to +2EV in increments of $1/3EV$). The display at right indicates that the picture will be underexposed by -1EV.

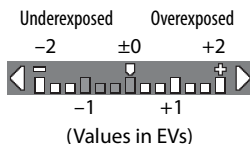

More on Playback

Viewing Multiple Pictures: Thumbnail Playback

Pressing the zoom control to **W** (📐) in full-frame playback (📺 22) displays pictures in “contact sheets” of four, nine, or sixteen thumbnail images. The following operations can be performed while thumbnails are displayed:



To	Use	📺	To	Use	📺
Page through pictures	⏪	—	Delete highlighted picture	🗑️	—
Highlight picture	📁	7	Exit to full-frame playback	⏹️	22
Change number of pictures displayed	W (📐) / T (🔍)	—	Exit to shooting mode	▶/	—

In displays of four or nine thumbnails, protected pictures are identified by a **T**, pictures selected for transfer by a **▶**. Movies are identified by a movie frame.

T: Protected
▶: Selected for transfer



Movie

Taking a Closer Look: Playback Zoom

Pressing the zoom control to **T** (🔍) during full-frame playback (📺 22) zooms the current picture in 3x, with the center of the picture displayed in the monitor (*quick playback zoom*). The following operations can be performed while pictures are zoomed in:

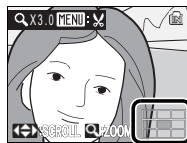

To	Use	📺	To	Use	📺
Zoom picture in or out	⏪	—	Exit to full-frame playback	⏹️	22
Zoom in (up to 10x)	T (🔍)	—	Create cropped copy	MENU	45
Zoom out	W (📐)	—	Exit to shooting mode	▶/	—
View other areas of picture. Area currently displayed is shown in bottom right corner of monitor.	📁	—		Shutter button	—

Creating Retouched Copies

The following options can be used to create retouched copies of the pictures in internal memory or on the memory card.

Option	Description
D-Lighting	Create copies with enhanced contrast and brightness in shadows.
Crop	Create cropped copies.
Small picture	Create small copies.

Enhancing Contrast: D-Lighting

Copies created using D-Lighting are processed to enhance contrast and brightness in dark areas of the picture, brightening dark and backlit subjects.



Before



After

After selecting a picture in full-frame or thumbnail playback, press the **MENU** button and select **D-Lighting** from the playback menu (80). A confirmation dialog will be displayed; highlight **OK** and press (OK) to create an enhanced copy of the selected picture. During playback, pictures created with D-Lighting are indicated by an icon (5).

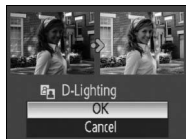

Copies

Copies are independent of the originals: deleting the copy has no effect on the original, deleting the original no effect on the copy. Copies are created with the same transfer marking and date and time of recording as the original, but any subsequent changes to transfer marking or to protect and print attributes must be made separately.

Copies can not be created from pictures with a size of 3,648 × 2,432 (82) or 3,584 × 2,016 (89). The camera may be unable to make copies of pictures that were created with other types of camera or that have been modified on a computer. Copies may not display or transfer correctly when viewed on other types of camera.

The crop and small picture options can not be used with copies created with crop or small picture; D-Lighting is not available with copies created with crop, D-Lighting, or small picture. D-Lighting can be applied before using crop or small picture to create additional copies; note, however, that each option can only be applied once.

See the Appendix for information on how copies are stored (106).

Creating a Cropped Copy

If a **MENU** icon is displayed in the monitor during playback zoom (43), the portion of the picture currently visible in the monitor can be saved to a separate file. Pressing the **MENU** button displays the dialog shown at right; highlight **Yes** and press **OK** to create a new picture containing only the area visible in the monitor.



Cropped copies are stored as JPEG files with a compression ratio of 1:8. Depending on the size of the original and the zoom ratio at the time the copy was created, copies will be 2,592×1,944 (5M), 2,272×1,704 (4M), 2,048×1,536 (3M), 1,600×1,200 (2M), 1,280×960 (1M), 1,024×768 (PC), 640×480 (TV), 320×240 (□), or 160×120 (□) pixels in size. Sizes of 320×240 and 160×120 are indicated by a gray border during playback.

Creating Small Copies: Small Pic.

To create small copy of the picture currently selected in full-frame or thumbnail playback, press the **MENU** button and select **Small pic.** from the playback menu (80). The following options will be displayed; highlight a size and press **OK**.

Option	Description
640×480	Suited to television playback.
320×240	Suited to display on web pages.
160×120	Suitable for e-mail.

A confirmation dialog will be displayed; highlight **Yes** and press **OK**. Copies are stored as JPEG files with a compression ratio of 1:16. Copies are indicated by a gray border and in full-frame playback by a □, □, or □ icon (5).

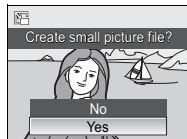

Voice Memos: Recording and Playback

The built-in microphone (📷 2) can be used to record voice memos for pictures marked with a 🗣️ icon in full-frame playback (📷 22).



Recording Voice Memos

To record a voice memo, press and hold the Ⓞ button. **REC** and 🗣️ icons will flash. Recording ends after about 20 seconds or when the button is released. Do not touch the microphone during recording. Note that if a voice memo already exists for the current picture, it must be deleted before a new voice memo can be recorded.

Playing Voice Memos

During playback, pictures to which a voice memo has been appended are indicated by 🗣️ and 🗣️ icons. Press Ⓞ to start and stop playback. Use the zoom control to adjust volume: select **W** to lower volume, **T** to increase.

Deleting Voice Memos

To delete the voice memo for the current picture, press the 🗑️ button. The dialog shown at right will be displayed; press the multi selector up or down to highlight an option and press Ⓞ to select.

- **No**: Exit without deleting the picture or voice memo.
- **[🗣️]**: Delete voice memo only.
- **Yes**: Delete both picture and voice memo.



🗣️ Voice Memos



Voice memos can not be added to movies or to pictures created with other types of camera. Voice memos recorded using other types of camera can not be played back on the COOLPIX P5000. See the Appendix for more information on voice memos (📷 106).

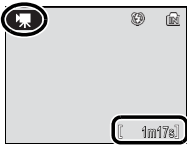
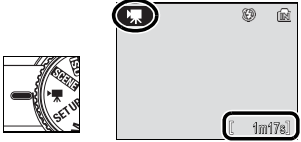

Movies

Recording Movies

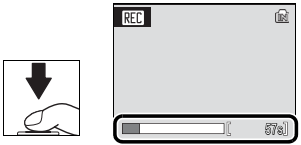
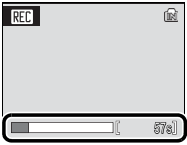
Follow the steps below to shoot movies with sound recorded via the built-in microphone (for information on recording time-lapse movies, see page 49).

- 

1 Rotate mode dial to  and select desired movie option ( 48). Exposure count display shows length of movie that can be recorded.
- 

2 Press shutter-release button all the way down to start recording (camera will focus on subject in center of frame). Progress bar shows amount of memory remaining. Avoid touching microphone during recording.
- 

3 Press shutter-release button all the way down a second time to end recording. Recording will end automatically when memory is full or movie reaches file size of 2GB.

Movies

See the Appendix for information on movie menu defaults ( 104) and on how movie files are stored ( 106).

The self-timer is not available in movie mode. In all modes except **Time-lapse movie** , the flash will turn off and exposure compensation can not be used. Optical zoom can not be adjusted during recording; digital zoom is available to a maximum of 2x.

If the camera is pointed at the sun or other bright light source during recording, vertical comet-like streaks (“smear”) may appear in the movie. Avoid pointing the camera at bright light sources while filming movies.

The Movie Menu

Pressing the **MENU** button in movie mode displays the movie menu.

Option	Description
Movie options	<p>Choose type of movie that will be recorded from:</p> <ul style="list-style-type: none"> TV movie 640★: Movie will be recorded at 30 frames per second (fps); each frame is 640×480 pixels in size. TV movie 640: 15 fps; frame size 640×480. Small size 320: 15 fps; frame size 320×240. Smaller size 160: 15 fps; frame size 160×120. Time-lapse movie★: Camera takes up to 1,800 stills at specified intervals and joins them into silent movie up to 60s long. Use for time-lapse movies of such subjects as flowers opening or butterflies emerging from cocoons (49). Sepia movie 320: Record sepia movies at 15 fps; frame size 320×240. B&W movie 320: Record black-and-white movies at 15 fps; frame size 320×240.
Auto-focus mode	<p>Choose from:</p> <ul style="list-style-type: none"> Single AF: Camera focuses on subject in center of frame when shutter-release button is pressed halfway and locks at this position during shooting, preventing sound of camera focusing from interfering with recording. Full-time AF: Camera constantly adjusts focus for subject in center of frame, even when shutter-release button is not pressed.



To choose a movie option without displaying the movie menu, press the **Fn** button and rotate the command dial until the desired setting is displayed in the monitor.



The following table lists the approximate maximum length of movies that can be recorded to internal memory or to a 256MB memory card.

Movie option	Internal memory (21 MB)	256 MB memory card*
TV movie 640★	19s	3 min. 40s
TV movie 640	39s	7 min. 20s
Small size 320	1 min. 17s	14 min. 30s
Smaller size 160	4 min. 16s	48 min.
Time-lapse movie★	233 frames	1800 frames
Sepia movie 320	1 min. 17s	14 min. 30s
B&W movie 320	1 min. 17s	14 min. 30s

* All figures are approximate. Actual length may vary with make of memory card and type of scene recorded. If more than 2GB of memory are available, camera shows recording time available for 2GB file.

Recording Time-Lapse Movies

Selecting **Time-lapse movie** ★ from the movie options menu (48) displays the menu shown in Step 1, below.

- 

1

Choose interval between shots.
- 

2

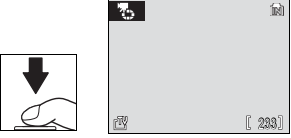
Select and exit to movie options menu.
Press MENU button to exit menu.
- 

3

Press shutter-release button all the way down to start recording. Camera will take pictures at specified interval until shutter-release button is pressed again, memory is full, or 1,800 frames have been recorded. Monitor turns off and power-on lamp blinks between shots.

Time-Lapse Movies

Adjust flash mode, focus mode, and exposure compensation before shooting begins. To prevent loss of power during recording, use a fully-charged battery or optional EH-62A AC adapter kit. Do not rotate the mode dial to a different setting during recording.





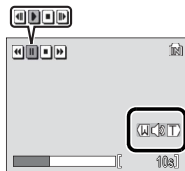

Movie Playback

In full-frame playback (22), movies are indicated by a  icon.



To play a movie, display it in full-frame playback and press **OK**. Playback controls appear at the top of the display; press the multi selector left or right to highlight a control, then press **OK** to perform the selected operation.



	Rewind recording. Playback resumes when OK button is released.
	Advance recording. Playback resumes when OK button is released.
	Pause playback.
	Go ahead one frame. Advance continues while OK button is pressed.
	Go back one frame. Rewind continues while OK button is pressed.
	Resume playback.
	End movie and return to full frame playback.

Volume is displayed when the zoom control is pressed. Select **W** to lower volume, **T** to increase. To fast forward or rewind, rotate the command dial.



To delete a movie, display it in full-frame playback or select it in the thumbnail list and press the  button. A confirmation dialog will be displayed; highlight **Yes** and press **OK** to delete, or highlight **No** and press **OK** to exit without deleting the movie.



Voice Recordings

Audio voice recordings can be recorded over the built-in microphone and played back over the built-in speaker.

Making a Voice Recording

To make a voice recording, rotate the mode dial to **SCENE** and select  in the scene menu ( 29). The length of the recording that can be made will be displayed as shown at right.





1



- 1 Pause icon
- 2 File number
- 3 Length of recording
- 4 Date of recording
- 5 Time remaining

- 6 Index number[†]
- 7 Progress indicator

Press shutter-release button all the way down to start recording.*

* AF lamp lights while recording is in progress. Camera will enter stand-by mode ( 16) after about 30s; press  to reactivate display. To pause recording, press ; AF lamp will blink. Press again to resume.

[†] To create index, press multi-selector up, down, left, or right during recording. Camera can skip to any index during playback. Start of recording is index number 01; other numbers are assigned in ascending order, to maximum of 98.

2





Press shutter-release button all the way down a second time to end recording. Recording will end automatically after five hours or when no more memory is available.

Voice Recordings

See the Appendix for information on how voice recordings are stored ( 106).

The COOLPIX P5000 may be unable to play or copy sound files created with other devices.

Playing Voice Recordings

To play voice recordings, select  in the scene menu ( 29) and press the  button. A list of recordings will be displayed as shown at right.

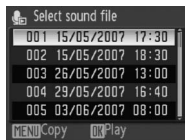

1



Select recording.









2



1	Control icons*	6	Date of recording
2	File number	7	Length of recording
3	Playback time	8	Index
4	Index number	9	Volume†
5	Progress indicator		

Play recording. To delete recording, press .

* Press multi selector left or right to highlight control, press  to select.

	Pause playback.
	Resume playback.
	Advance recording. Playback resumes when  button is released.
	Rewind recording. Playback resumes when  button is released.
	Go back to previous index.
	Skip to next index.
	End playback and return to voice recording list.

Recordings can also be advanced or rewound by rotating command dial.

† Zoom control controls volume. Select **W** to lower volume, **T** to increase.

"No Sound File"

If the memory card contains no voice recordings, the message "No sound file" will be displayed when the  button is pressed. To copy voice recordings from internal memory to the memory card, press the **MENU** button and follow the instructions on page 53.

Copying Voice Recordings

If a memory card is inserted, voice recordings can be copied between internal memory and the memory card by pressing the **MENU** button while the recording list is displayed (see previous page).

1



Highlight option.

- **Internal to card**: Copy recordings from internal memory to memory card.
- **Card to internal**: Copy recordings from memory card to internal memory.

2

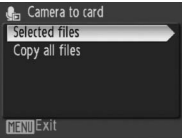

Display menu of copy options.

3

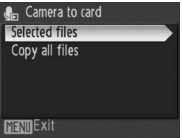

Highlight **Selected files**.*

* To copy all voice recordings, highlight **Copy all files** and press **OK**. Confirmation dialog will be displayed; highlight **Yes** and press **OK**.

4



Display list of voice recording files.

5



Highlight file.

6



Selected files shown by **✓**. Repeat steps 5–6 to select additional files.†

† To deselect file, highlight and press multi selector right.

7

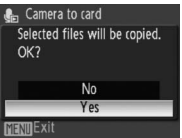

Confirmation dialog displayed. To copy files, highlight **Yes** and press **OK**.

Copying Voice Recordings to a Computer

PictureProject can not be used to transfer or play voice recordings. Select **Interface > Mass storage for USB** in the camera setup menu, copy the files manually, and play them back using QuickTime or another WAV-compatible audio player. Note that index points can not be used when voice recordings are played back on another device.

Connecting to Televisions, Computers, and Printers

In addition to viewing pictures on the camera, you can:

- View pictures on TV (📖 55)
- Copy pictures to a computer for storage and editing (📖 56–59)
- Print pictures on a home printer (📖 60–63) or order prints from a photofinisher

Before connecting the camera to another device, it may be necessary to change the interface settings in the setup menu (📖 89). To prevent the camera from turning off unexpectedly, use a fully-charged battery or an optional EH-62A AC adapter kit.

Viewing Pictures on TV

- 1 Check that the option selected for **Interface** > **Video mode** matches the video device (📺 89), and then turn the camera off.

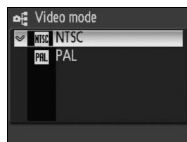

- 2 Connect the camera to the TV using the supplied EG-CP14 A/V cable. Connect the black plug to the camera, the yellow plug to the video-in jack on the TV, and the white plug to the audio-in jack.

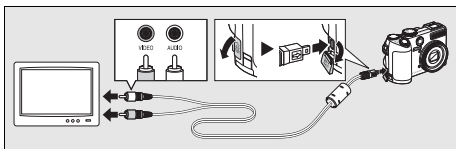

- 3 Tune the television to the video channel. If in doubt, consult the documentation for the TV.
- 4 Press and hold the  button to turn the camera on. The camera monitor will remain off and the television will show the image normally displayed in the monitor.

Connecting Cables

Do not use force or attempt to insert or remove the connectors at an angle.

Viewing Pictures on a Computer

The camera can be connected to a computer using the supplied USB cable. The supplied PictureProject software can then be used to copy pictures to the computer, where they can be organized, retouched, and printed.

Before Connecting the Camera

Install PictureProject from the supplied installer CD. For more information on installing and using PictureProject, see the *Quick Start Guide* and reference CD.

The appropriate USB option must be selected in the camera setup menu before the camera can be connected a computer or printer (Ⓝ 57). When connecting to a computer, select a USB option according to the computer operating system and how pictures will be transferred.

Computer operating system	Pictures transferred using	
	Camera Ⓝ button *	PictureProject "Transfer" button
Windows Vista (32-bit Home Basic/Home Premium/Business/Enterprise/Ultimate editions)	Choose Mass storage .	Choose MTP/PTP or Mass storage .
Windows XP (Home Edition/Professional)	Choose MTP/PTP or Mass storage .	
Windows 2000 Professional	Choose Mass storage . †	
Mac OS 10.3.9 or 10.4.x	Choose MTP/PTP .	Choose MTP/PTP or Mass storage .

* Can not be used to transfer pictures if memory card is locked (Ⓝ 15) or if **Mass storage** is selected for **Interface > USB** and no memory card is inserted. Use PictureProject **Transfer** button.

† Do NOT select **MTP/PTP**. If **MTP/PTP** is selected when camera is connected, wait until Windows hardware wizard is displayed, then click **Cancel** and disconnect camera. Select **Mass storage** in camera **USB** menu before reconnecting camera.

When connecting to a printer (Ⓝ 61), set **USB** to **MTP/PTP**.

Marking Pictures for Transfer

Pictures marked for transfer are shown by a Ⓝ icon during playback. By default, all pictures are automatically marked for transfer. Two options control transfer marking:

- **Interface > Auto transfer** (setup menu): Choose **On** to mark all new pictures for transfer (Ⓝ 89).
- **Transfer marking** (playback menu): Change marking for existing pictures (Ⓝ 82).





Follow the steps below to choose a USB option.

- 

1 Rotate mode dial to **SETUP**.
- 

2 Highlight **Interface**.
- 

3 Display options.
- 

4 Highlight **USB**.
- 

5 Display USB options.
- 

6 Highlight desired option.
- 

7 Select option. Rotate mode dial to different setting to exit setup menu.

Transferring Pictures to a Computer

- 1 Start a computer to which PictureProject has been installed.
- 2 Turn the camera off.
- 3 Connect the camera to the computer using the supplied USB cable.

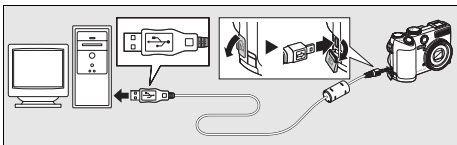

- 4 Turn the camera on. PictureProject will start.



- 5 Press **OK** to transfer all marked pictures to the computer.* The following messages will be displayed:

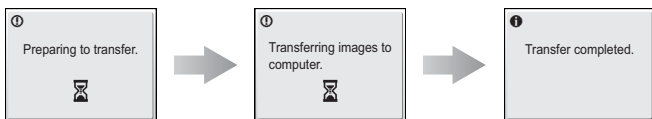

* Note that the **OK** button can not be used to transfer pictures if the memory card is locked (**15**) or if **Mass storage** is selected for **Interface > USB** and no memory card is inserted. Transfer pictures using the PictureProject **Transfer** button (see below).

- 6 The pictures will be displayed in PictureProject when transfer is complete. Disconnect the camera as described on the following page.

The PictureProject Transfer Button

To copy both marked and unmarked pictures to the computer, click the PictureProject **Transfer** button instead of pressing **OK** in Step 5. See the *Quick Start Guide* or the PictureProject reference manual (on CD) for details.

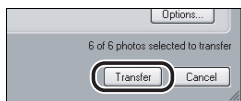

Disconnecting the Camera

If **MTP/PTP** is selected for **USB**, turn the camera off and disconnect the USB cable.

If **Mass storage** is selected for **USB**, remove the camera from the system as described below before turning the camera off and disconnecting the USB cable.

- **Windows Vista/Windows XP:** Click the “Safely Remove Hardware” icon (🗑️) in the taskbar and select **Safely remove USB Mass Storage Device**.
- **Windows 2000 Professional:** Click the “Unplug or Eject Hardware” icon (🗑️) in the taskbar and select **Stop USB Mass Storage Device**.
- **Macintosh:** Drag the untitled camera volume (“NO NAME”) into the Trash.

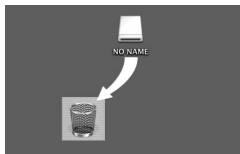

Printing Pictures

Users of PictBridge-compatible printers can connect the camera directly to the printer and print pictures without using a computer.

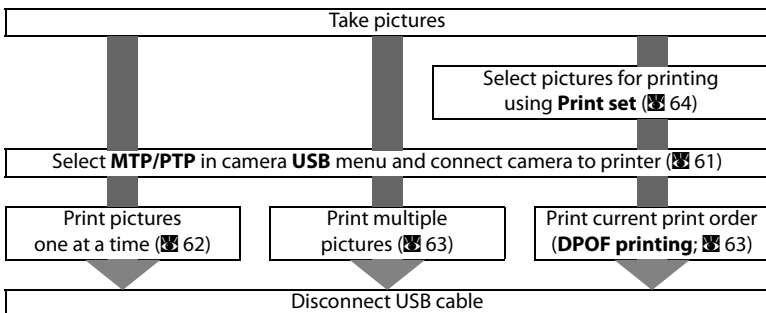

Other Ways to Print Pictures

Pictures can also be printed by:

- **Inserting a memory card in the printer:** If the printer is equipped with a card slot, a memory card can be inserted in the printer and pictures printed directly from the card. If the printer supports DPOF, the camera **Print set** option can be used to select pictures for printing (64). See the printer manual for details.
- **Taking memory cards to a digital print service:** If the service supports DPOF, the camera **Print set** option can be used to select pictures for printing (64).
- **Transferring pictures to a computer:** Once transferred to a computer (56–59), pictures can be printed using imaging software or uploaded to a digital print service. See the application and printer manuals for details.

Printing the Date of Recording on Pictures

Two options are available for printing the date of recording on pictures: **Date imprint** (86) and **Print set > Date** (64).

Date imprint	Print set > Date
Must be set before picture is taken.	Set after picture is taken.
Date permanently imprinted on picture.	Date stored separately.
Date appears whenever picture is printed.	Date only appears when picture is printed on DPOF-compatible printer.

The date only appears once; **Print set > Date** can not be used to print two dates on pictures with a date imprint.

Connecting the Printer

1 Turn the camera off.



MTP/PTP (the default option) must be selected for **Interface > USB** in the camera setup menu before the camera can be connected to a printer (p. 57).

2 Turn the printer on.

3 Connect the camera to the printer using the supplied USB cable.

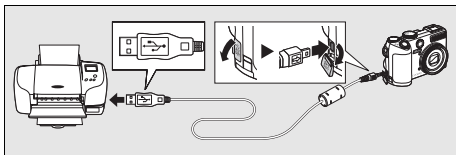

4 Turn the camera on. A PictBridge start-up screen will be displayed, followed by the PictBridge playback screen.

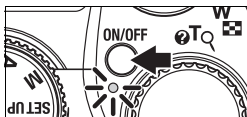

Printing Pictures One at a Time

1



Highlight picture (command dial can be used in place of multi selector).*

2

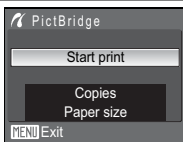

Display PictBridge menu.

* Press zoom control to **T** (Q) to display highlighted picture full frame. Press zoom control to **W** (R) to return to thumbnail list.

3

Highlight option and press OK.

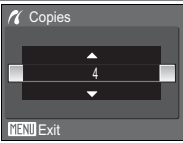
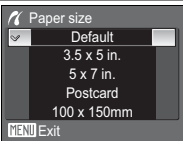
Option	Description
Start print	Start printing. To cancel before all copies have been printed, press OK. Camera returns to PictBridge playback display when printing is complete; repeat from Step 1 to print additional pictures.
Copies	Choose number of copies (up to 9). 
Paper size	Choose from Default (default page size for current printer), 3.5×5 in. , 5×7 in. , Postcard , 100×150mm , 4×6 in. , 8×10 in. , Letter , A4 , and A3 . Only sizes supported by the current printer will be displayed. 

Paper Size

Paper size can not be selected from the camera if the printer does not support the page sizes used by the camera or if the printer automatically selects the page size. Use the printer to select the page size.

Printing Multiple Pictures

To print multiple pictures, press the **MENU** button while the PictBridge playback screen is displayed (61). The menu shown at right will be displayed; highlight an option and press **OK**.

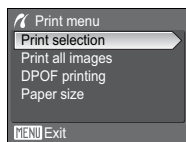

Option	Description
Print selection	Print selected pictures (see below).
Print all images	Print one copy of all pictures.
DPOF printing	<p>Menu shown at right will be displayed. Highlight option and press OK.</p> <ul style="list-style-type: none"> • Start print: Print current print order (64). • View images: View print order. Press OK to start printing (See Step 4, below). • Cancel: Return to print menu.
Paper size	Choose page size (62, Step 3).

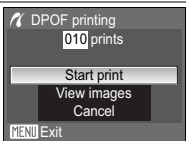

Choosing **Print selection** displays the menu shown in Step 1, below.

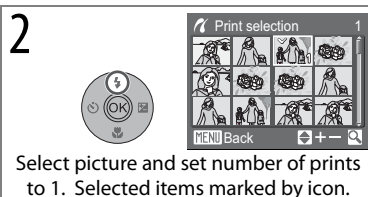
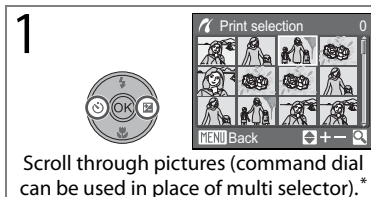

* Press zoom control to **T** (Q) to display selected picture full frame. Press zoom control to **Q** (T) to return to thumbnail list.

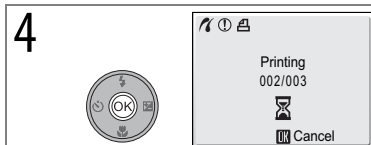
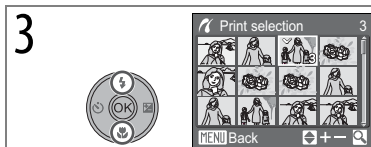

Creating a DPOF Print Order: Print Set

The **Print set** option in the playback menu (Ⓜ 80) is used to create digital “print orders” for printing on DPOF-compatible devices (Ⓜ 60). Selecting **Print set** displays the menu shown in Step 1, below.

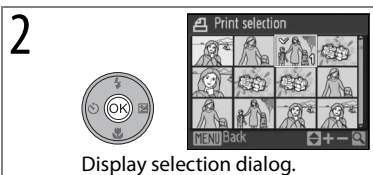
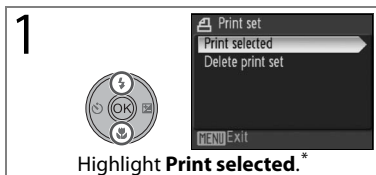

* To delete current print order, highlight **Delete print set** and press Ⓜ.

3 Select pictures as described in steps 1–3 on page 63.

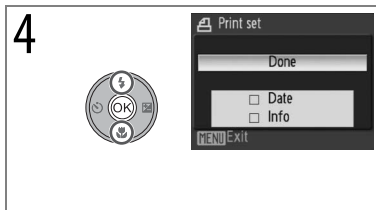

Highlight option and press Ⓜ:

- **Date**: Print date of recording on all pictures in print order.
- **Info**: Print shutter speed and aperture on all pictures in print order.
- **Done**: Complete print order and exit. Pictures in print order are shown by icon during playback (Ⓜ 5).

















Print Set

Date and **Info** are reset each time the menu shown in Step 4 is displayed. Shutter speed and aperture are not printed when the camera is connected directly to the printer.

Menu Guide

Shooting Options: The Shooting Menu

To display the shooting menu, select **P**, **S**, **A**, **M**, or **ISO** mode and press the **MENU** button. After using the multi selector to adjust settings (🔍 7), press the shutter-release button or **MENU** button to return to shooting mode. Unless **Reset all** (🔍 89) is used to restore default settings, changes to settings will be recalled the next time **P**, **S**, **A**, **M**, or **ISO** mode is selected. See the Appendix for information on default settings (🔍 104) and on settings that can not be used together (🔍 105).

Option	Description	🔍
 Image quality	Choose how pictures are stored.	66
 Image size	Choose a size according to how pictures will be used.	66
 Optimize image	Control contrast, sharpness, and saturation.	68–69
 White balance	Match white balance to the light source.	70
 ISO sensitivity	Control the camera's sensitivity to light (not available in ISO mode).	71
 Metering	Choose how the camera meters exposure.	72
 Continuous	Take pictures one at a time or in a sequence.	73–74
 BSS	Use BSS to choose the sharpest picture.	75
 Auto bracketing	Vary exposure over a sequence of pictures.	75
 AF area mode	Choose where the camera focuses.	76
 Auto-focus mode	Choose how the camera focuses.	76
 Flash exp. comp.	Adjust flash level.	78
 Flash control	Control built-in and optional flash units.	78
 Fixed aperture	Choose whether aperture changes with zoom position.	78
 Noise reduction	Reduce noise in pictures taken at slow shutter speeds.	78
 Converter	Adjust settings for optional converter lenses.	79

The shooting menu is shown below:

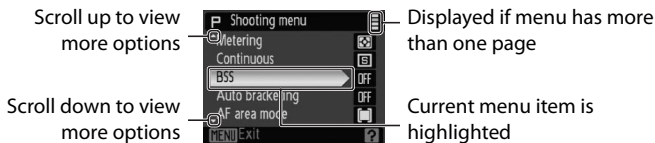

Using the Command Dial

The command dial can be used in place of the multi selector to scroll up and down through menus.



Image Quality

Pictures are stored in compressed JPEG format. The more pictures are compressed, the less memory they require ( 67). Compression also however selectively reduces image quality, and the more pictures are compressed the more noticeable this loss of quality is likely to be.





Option	Description
 Fine	Fine quality images (compression ratio of 1:4), suitable for enlargement or high-quality prints.
 Normal (default)	Normal image quality (compression of 1:8), suited to most applications.
 Basic	Basic image quality (compression of 1:16), suitable for pictures that will be distributed by e-mail or used in web pages.

Image quality is shown by an icon in the monitor ( 4–5).

Image Size

Image size is measured in pixels. Pictures taken at smaller sizes require less memory ( 67), making them suited to distribution by e-mail or the web. Conversely, the larger the image, the larger the size at which it can be printed or displayed without becoming noticeably “grainy.”



















Option	Description (print sizes assume printer resolution of 300 dpi)
 3648 × 2736 (default)	Will print at size of about 31 × 23 cm (12 × 9 in.)
 2592 × 1944	Will print at size of about 22 × 16 cm (8½ × 6½ in.)
 2048 × 1536	Will print at size of about 17 × 13 cm (7 × 5 in.)
 1600 × 1200	Will print at size of about 14 × 10 cm (5½ × 3 in.)
 1280 × 960	Will print at size of about 11 × 8 cm (4 × 3 in.)
 1024 × 768	Suited to display on a computer; will print at size of about 9 × 7 cm (3½ × 2½ in.)
 640 × 480	Suited to e-mail; will print at size of about 5 × 4 cm (2 × 1½ in.)
 3648 × 2432	Picture has same proportions as pictures taken on 35-mm film; will print at size of about 31 × 21 cm (12 × 8 in.)
 3584 × 2016	Picture has same proportions as wide-screen television display; will print at size of about 30 × 17 cm (12 × 7 in.)

Image size is shown by an icon in the monitor ( 4–5).

Memory Capacity, Image Quality, and Image Size









The following table lists the number of pictures that can be recorded to internal memory and to a 256MB memory card.

Image size	Image quality	Internal memory (21 MB)*	256MB memory card*
 3648 × 2736 (default)	Fine	4	50
	Normal	9	100
	Basic	17	195
 2592 × 1944	Fine	8	95
	Normal	17	195
	Basic	34	380
 2048 × 1536	Fine	14	155
	Normal	27	305
	Basic	51	575
 1600 × 1200	Fine	22	255
	Normal	43	485
	Basic	77	865
 1280 × 960	Fine	35	390
	Normal	63	705
	Basic	116	1300
 1024 × 768	Fine	51	575
	Normal	93	1040
	Basic	155	1730
 640 × 480	Fine	116	1300
	Normal	175	1950
	Basic	280	3120
 3648 × 2432	Fine	5	55
	Normal	10	110
	Basic	19	215
 3584 × 2016	Fine	6	65
	Normal	12	135
	Basic	24	265

* All figures are approximate. Actual capacity varies with make of memory card and type of scene recorded. If memory remains for more than 9999 pictures, exposure count display will show 9999.

Optimize Image

Optimize contrast, sharpening, and other settings according to how pictures will be used or the type of scene.

Option	Description
 Normal (default)	Recommended in most situations.
 Softer	Softens outlines, producing natural results suitable for portraits or retouching on a computer.
 Vivid	Enhances saturation, contrast, and sharpness to produce vivid images with vibrant reds, greens, and blues.
 More vivid	Maximizes saturation, contrast, and sharpness to produce crisp images with sharp outlines.
 Portrait	Lowers contrast while lending natural texture and rounded feel to skin of portrait subjects.
 Custom	Customize image optimization settings (see below).
 Black-and-white	Take photos in black-and-white ( 69).

Customizing Image Enhancement Options: Custom

Select **Custom** to make separate adjustments to the following options. The default setting for all three options is **Auto**.

- **Contrast:** Control contrast. Lower settings prevent loss of detail in highlights under harsh lighting or in direct sunlight. Higher settings preserve detail in misty landscapes and other low-contrast subjects.
- **Image sharpening:** Choose how much outlines are sharpened during shooting. Choose high settings for sharp outlines, low settings for softer outlines. Note that the effects of sharpening can not be previewed in the monitor during shooting.
- **Saturation:** Control the vividness of colors. Choose **Moderate** for less saturated colors, **Enhanced** for more vivid colors.

Optimize Image

At settings other than **Custom** and **Black-and-white** > **Custom**, results are optimized for current shooting conditions and vary with exposure and the position of the subject in the frame. For consistent results over a series of photographs, select **Custom** and choose a setting other than **Auto** for contrast, sharpening, and saturation.

*Taking Pictures in Black-and-White: **Black-and-White***

Select this option to take pictures in black and white. Choose **Standard** to take standard black-and-white pictures, or **Custom** to adjust contrast and sharpening as described on the preceding page. **Custom** also offers a **Monochrome filter** option for the following color filter effects:

Option	Description
None	No color filter effect.
Yellow	Enhances contrast. Can be used to tone down the brightness of the sky in landscape photographs.
Orange	Orange produces more contrast than yellow, red more contrast than orange.
Red	
Green	Softens skin tones. Can be used for portraits.

WB White Balance

Process pictures to produce natural colors under different types of light.

Option	Description
Auto (default)	Best choice in most situations.
PRE White bal. preset	Neutral-colored object used as a reference to set white balance under unusual lighting conditions (see below).*
Daylight	White balance adjusted for direct sunlight.*
Incandescent	Use under incandescent lighting.*
Fluorescent	Use under most types of fluorescent lighting.*
Cloudy	Use when taking pictures under overcast skies.*
Flash	Use with the flash.

* For best results, turn the flash off (🔇) when using this option.

White balance is shown in the display at settings other than **Auto** (🔍 4).

PRE Preset White Balance

Preset white balance is used with mixed lighting or to compensate for light sources with a strong color cast (for example, to make pictures taken under a lamp with a red shade look as though they had been taken under white light).

1 Place white or gray reference object under lighting that will be used during shooting. Note that preset white balance can not be measured with flash.

2



Highlight **White bal. preset**.

3



Camera zooms in.

4



Highlight **Measure**.*

* To restore most recent value for preset white balance, highlight **Cancel** and press **OK**.

5

Frame
reference
object here



Frame reference object.

6



Set preset white balance to new value and return to shooting menu.

ISO ISO Sensitivity

Sensitivity is a measure of how quickly the camera reacts to light. The higher the sensitivity, the less light needed to make an exposure. Much as film with a high ISO rating tends to produce “grainy” images, high sensitivities may however be associated with “noise”—randomly-spaced, brightly-colored pixels concentrated in dark parts of the image. Choose from values between ISO 64 and ISO 3,200. **Auto** is equivalent to ISO 64 under normal conditions; when lighting is poor and the flash is off, the camera compensates by raising ISO sensitivity to a maximum of ISO 800 (note that ISO sensitivity is fixed at 64 in mode **M**).

The current ISO sensitivity is displayed in the monitor at settings other than **Auto** (📷 4). If **Auto** is selected, an **ISO** icon will be displayed when sensitivity is raised above ISO 64.







📷 ISO 3200

Image sizes over 2,592×1,944 (📷) are not available at ISO 3200 (📷 66). If 3,648×2,736 (📷), 3,648×2,432 (📷), or 3,584×2,016 (📷) is selected for **Image size** when ISO sensitivity is set to 3200, **Image size** will automatically be set to 2,592×1,944 (📷). The original image size will be restored when a lower ISO sensitivity is selected.

When **3200** is selected for ISO sensitivity, image size is displayed in red and the slowest shutter speed available is 2s.

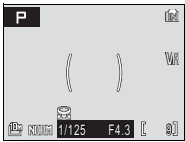
Metering

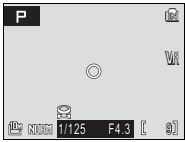
Choose how the camera meters exposure.





Option	Description
 Matrix (default)	Camera sets exposure for entire frame. Recommended in most situations.
 Center-weighted	Camera meters entire frame but assigns greatest weight to subject in center of monitor (see right). Classic meter for portraits; preserves background details while letting lighting conditions at center of frame determine exposure. Can be used with focus lock ( 77) to meter off-center subjects. 
 Spot	Camera meters area shown by circle in center of monitor (see right). Ensures that subject in metering target is correctly exposed even if background is much lighter or darker. Can be used with focus lock ( 77) to meter off-center subjects. 
 Spot AF area	Camera meters selected focus area ( 76). Not available when Center is selected for AF-area mode (if Center is selected for AF-area mode when spot AF-area metering is in effect, Metering will be set to Matrix).



Digital Zoom

When digital zoom is in effect, the camera focuses on the subject in the center focus area and center-weighted metering is used. At magnifications of 2.0x or higher, the camera meters the center focus area only. The metered area is not shown in the monitor.

Continuous

Capture a fleeting expression on a portrait subject, photograph subjects that are moving unpredictably, or capture motion in a series of pictures.

Option	Description
 Single (default)	One shot is taken each time shutter-release button is pressed.
 Continuous	While shutter-release button is pressed, camera takes up to eight pictures at up to 0.8 frames per second (fps).*
 Continuous flash	While shutter-release button is pressed, camera takes 3 shots at up to 0.8 fps* using flash. Once shooting ends, no additional pictures can be taken until flash has charged. Pictures may be affected by “noise” (randomly-spaced, brightly-colored dots).
 Intvl timer shooting	Camera takes pictures automatically at specified interval ( 74).



* Image quality **Normal**, image size 3,648×2,736 (). Actual frame rate varies with image quality and size ( 66) and make of memory card.

At settings other than **Single**, the current continuous setting is shown by an icon in the display ( 4).



Continuous Flash

Continuous will be set to **Single** if an option other than **None** is selected for **Converter** when **Continuous flash** is in effect ( 79). The original **Continuous** setting is not be restored when **None** is selected for **Converter**.

Interval Timer Photography



To display the interval timer menu, highlight **Intvl timer shooting** in the **Continuous** menu ( 73) and press . To prevent unexpected loss of power, use a fully-charged battery or an optional EH-62A AC adapter kit. Do not rotate the mode dial to a different setting during recording.

1



Choose interval between shots. Press  to make selection, then press **MENU** to return to shooting mode.

2



Press shutter-release button all the way down to start recording. Camera will take pictures at specified interval until shutter-release button is pressed again, memory is full, or 1,800 frames have been recorded. Monitor turns off and power-on lamp blinks between shots.

See the Appendix for information on how pictures taken using interval timer photography are stored ( 106).

BSS BSS

BSS is recommended for situations in which inadvertent camera movement can produce blurred pictures. It may not produce the desired results if the subject moves or the composition is changed while the shutter-release button is pressed.

Option	Description
On	Camera takes up to ten shots while shutter-release button is pressed. These images are compared and sharpest picture (picture with highest level of detail) is saved. Flash turns off automatically and focus, exposure, and white balance for all photos are determined by first picture in series.
Off (default)	BSS off.

When **On** is selected, a **BSS** icon appears in the display (📷 4).

BKT Auto Bracketing







Auto bracketing is used to vary exposure by a selected amount over a series of pictures, "bracketing" the exposure value selected by the camera or with exposure compensation (📷 28). Use in situations in which it is difficult to guess the correct exposure.

Option	Description
±0.3	Camera varies exposure by 0 EV, +0.3EV, and -0.3EV over next three shots. Keep shutter-release button pressed to take all three shots in sequence.
±0.7	Camera varies exposure by 0 EV, +0.7EV, and -0.7EV over next three shots. Keep shutter-release button pressed to take all three shots in sequence.
±1.0	Camera varies exposure by 0 EV, +1.0EV, and -1.0EV over next three shots. Keep shutter-release button pressed to take all three shots in sequence.
Off (default)	Bracketing is not performed.

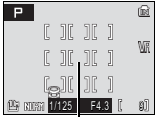
Auto bracketing is not available when the mode dial is rotated to **M**. At settings other than **Off**, auto bracketing is shown by an icon in the display (📷 4). The flash turns off automatically when auto bracketing is on.

[+] AF Area Mode

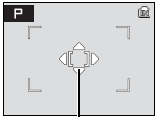

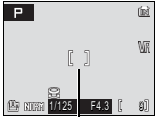
Choose where the camera focuses.

Option	Description	
 Auto (default)	Use for snapshots. Camera automatically compares distances to subjects in nine focus areas shown at right and selects focus area containing closest subject. Selected focus area is highlighted when shutter-release button is pressed halfway.	 Focus areas
 Manual	Use to focus on relatively stationary subjects not in center of frame. Press multi selector up, down, left, or right to select from 99 focus areas in large frame shown at right. Pictures can be taken while focus area selection screen is displayed. To end focus area selection and adjust flash, focus, self-timer, and exposure compensation settings, press  . Press  again to change focus area.	 Focus area
 Center	Camera focuses on subject in center focus area. Focus lock ( 77) can be used to focus on off-center subject.	 Center focus area

The focus area is displayed in green when the camera is able to focus. If the focus area blinks red, the camera is unable to focus. In **Auto** mode, the focus area is not displayed until the shutter-release button is pressed halfway.

Auto-focus Mode

Choose how the camera focuses.

Option	Description
 Single AF (default)	Camera focuses when shutter-release button is pressed halfway.
 Full-time AF	Camera adjusts focus continuously until shutter-release button is pressed halfway. Use with moving subjects.

Focus Lock

Focus locks while the shutter-release button is pressed halfway. Focus lock can be used to photograph subjects that will not be in the selected focus area in the final composition or in situations in which the camera is unable to focus (see 20).

1



Position subject in focus area.

2

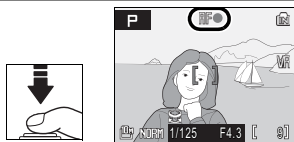

Press shutter-release button halfway and check focus.

3

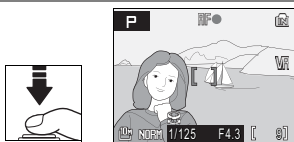

Recompose picture, keeping shutter-release button pressed halfway.

4

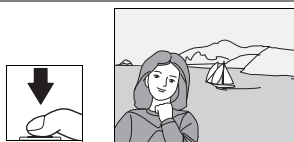

Take picture.

Flash Exp. Comp.

Flash compensation is used to alter flash output by $\pm 2.0\text{EV}$ in increments of $\frac{1}{3}\text{EV}$, changing the brightness of the main subject relative to the background. Flash output can be increased to make the main subject appear brighter, or reduced to prevent unwanted highlights or reflections. Flash compensation is available with the built-in flash and with optional SB-400, SB-600, and SB-800 flash units ( 93).

Flash Control

Choose **Auto** (the default option) to use the built-in flash when no optional flash unit is mounted on the camera accessory shoe ( 93), or choose **Built-in off** to disable the built-in flash altogether.

Fixed Aperture

Choose whether aperture varies with zoom position.

Option	Description
On	In A and M modes, aperture is kept as close as possible to selected f-number. To prevent selected f-number from exceeding exposure range at new zoom position, set aperture to around f/5.1–f/7.3.
Off (default)	Aperture varies with zoom position.

NR Noise Reduction



At slow shutter speeds, pictures may be affected by “noise” in the form of randomly-spaced, brightly-colored dots concentrated in dark parts of the image. Use this option to reduce noise at slow shutter speeds.

Option	Description
On	Noise reduction takes effect at slow shutter speeds, increasing time needed to record pictures after shooting.
Off (default)	No noise reduction performed.

When noise reduction is on, a **NR** icon is displayed in the monitor.

Converter

This option is for use with the optional converter lenses listed below. Note that these accessories require a lens adapter ring (available separately); for more information, see page 92 of this manual or the documentation provided with the converter lens.

Option	Description
 None (default)	No modifications made to camera settings. Use when no converter lens is attached (be sure to remove lens adapter ring).
 Wide-angle converter	<p>Use with WC-E67 wide-angle converter. Camera zooms to widest angle; menu shown at right is displayed. Choose from:</p> <ul style="list-style-type: none">• Distortion control on (default): Correct for pin-cushion and barrel distortion. Continuous set to Single (73); BSS and bracketing can not be used (75). <p>Note: Distortion control reduces the area visible in the final picture.</p> <ul style="list-style-type: none">• Distortion control off: No distortion correction performed. <p>Zoom can be adjusted manually while Wide-angle converter is in effect; note, however, that best results will be achieved with camera zoomed out. Focal length at widest angle is 24mm (35-mm format equivalent, distortion control off).</p>
 Telephoto converter	Use with TC-E3ED telephoto converter. Camera will zoom all the way in; optical zoom is restricted to positions near maximum zoom. Focal length at maximum zoom is 378mm (35-mm format equivalent). Focus mode can not be adjusted.

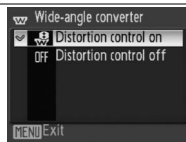













At settings other than **None**, a converter icon appears in the display.

Converter





Be sure to select the appropriate option when using a converter lens. Select **None** when no converter lens is attached. At settings other than **None**, the built-in flash and AF-assist illuminator turn off, **Continuous flash** (73) can not be used. Optional flash units can still be used, although the converter may cast shadows in pictures taken with the SB-400, SB-600, or SB-800 (93; a wide panel is recommended when shooting with the SB-600 or SB-800). Check pictures in the monitor after shooting.

Playback Options: The Playback Menu

To display the playback menu, press the  button to select playback mode and press the **MENU** button. Use the multi selector to navigate the menu ( 7) and then press the **MENU** button again to return to playback mode.

Option	Description	
 D-Lighting	Copy current picture with enhanced details in shadows.	44
 Print set	Select pictures for printing.	64
 Slide show	View pictures in an automatic slide show.	81
 Delete	Delete all or selected pictures.	81
 Protect	Protect selected pictures from accidental deletion.	81
 Transfer marking	Change transfer marking for existing pictures.	82
 Hide image	Hide selected pictures during playback.	82
 Small pic.	Create small copy of current picture.	45
 Copy	Copy files between memory card and internal memory.	82

To select multiple pictures for **Delete**, **Protect**, **Transfer marking**, **Hide image**, and **Copy**:

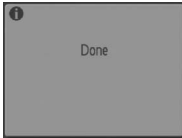
- 
Scroll through pictures (command dial can be used in place of multi selector).

- 
Select current picture. Selection shown by icon.

- Repeat steps 1–2 to select additional pictures. To deselect picture, highlight and press multi selector down.
- 
Complete operation. Confirmation message may be displayed.

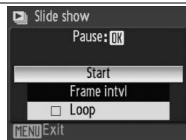
Slide Show

Selecting **Slide show** displays the options shown at right. Press the multi selector up or down to highlight an option and press **OK** to select.



Option	Description
Frame intvl	Choose length of time each slide will be displayed.
Loop	If this option is checked, slide show will repeat until OK button is pressed.
Start	Start slide show.

While the slide show is in progress, press the multi selector to the right to skip ahead, left to rewind. Press **OK** to pause the slide show.

When the slide show ends or is paused, the menu shown at right will be displayed. Highlight **Restart** and press **OK** to restart the show, or select **End** to end the show and return to the playback menu.

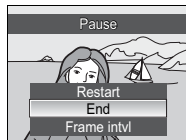

Slide Show

Movies (**X** 47) appear as still images showing the first frame. The camera will turn off automatically if no operations are performed for 30 minutes during the show, even if **Loop** is selected (**X** 88).

Delete

Choose **Erase all images** to delete all pictures, or **Erase selected images** to select pictures for deletion (**X** 80). Pictures marked with a **On** icon will not be deleted.



Protect

Protect selected pictures from accidental deletion (**X** 80). Protected pictures are marked with a **On** icon (**X** 5) and can not be deleted using the  button or **Delete**. Note, however, that formatting *will* delete protected files (**X** 88).



Transfer Marking

Mark existing pictures for transfer to a computer ( 56–59).

Option	Description
All on (default)	Mark all images for transfer.
All off	Remove transfer marking from all images.
Selected image(s)	Mark selected images for transfer ( 80).





Pictures selected for transfer are marked by a  icon ( 5, 43).

Hide Image

Hide or reveal selected pictures ( 80). Hidden pictures are visible only in the **Hide image** menu and can not be deleted using **Delete**. Note, however, that formatting *will* delete hidden pictures ( 88).

Copy

Copy pictures between internal memory and a memory card. This option is only available when a memory card is inserted.

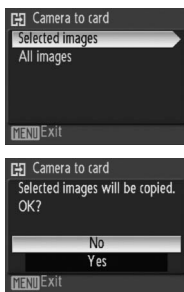

Option	Description
 	Copy pictures from internal memory to memory card.
 	Copy pictures from memory card to internal memory.

Selecting either of the above options displays the menu shown at right. Choose **Selected images** to select the pictures that will be copied ( 80) or **All images** to copy all pictures.



















A confirmation dialog will be displayed; highlight **Yes** and press .

Copy

Voice memos ( 46) will be copied with the associated picture, but voice recordings ( 51) will not. Copies created using **Copy** have the same protection marking as the original but are not marked for printing or transfer. Hidden pictures can not be copied. The camera may be unable to copy pictures that were created with another make of camera or that have been modified on a computer. See page 106 for information on how copies are stored.

Basic Camera Setup: The Setup Menu

To make changes to the items in the setup menu, rotate the mode dial to **SETUP** and use the multi selector (🔍 7). To exit the setup menu, rotate the mode dial to a different setting. Settings remain in effect until reset (🔍 89). See the Appendix for setup menu defaults (🔍 104).

Option	Description	🔍
 Menus	Choose how menus are displayed.	83
 Quick startup	Enable or disable welcome screen and start-up sound.	83
 Welcome screen	Select screen displayed when camera is turned on.	84
 Date	Set clock and choose home and destination time zones.	84–85
 Brightness	Adjust monitor brightness.	85
 Date imprint	Imprint date or birthday counter on pictures.	86
 Vibration reduction	Reduce blur caused by camera shake.	87
 AF assist	Enable or disable AF assist illumination.	87
 Digital zoom	Enable or disable digital zoom.	87
 Sound settings	Adjust sound and volume settings.	88
 Auto off	Choose when monitor will turn off to save power.	88
 Format memory/ Format card	Format internal memory or memory card.	88
 Language	Choose language for camera menus and messages.	88
 Interface	Adjust settings for connection to TV, computer, or printer.	89
 FUNC button	Choose function performed by Fn button.	89
 Reset all	Restore camera settings to default values.	89
 Firmware version	Display camera firmware version.	89

Menus

Choose how menus are displayed.



Text

Icon

Quick Startup

Choose **On** (the default setting) to disable the welcome screen (🔍 84) and start-up sound. The camera will be ready for use immediately after being turned on.

Welcome Screen

Choose the welcome screen displayed when the camera is turned on. This option is only available when **Off** is selected for **Quick startup**.

Option	Description
Nikon	COOLPIX logo is displayed at start-up.
Animation (default)	Animation displayed at start-up.
Select an image	Select picture from internal memory or memory card. Copy of selected image is created for use in welcome screen and remains when original is deleted or memory card is removed.

Date

Set the camera clock and choose home and travel destination time zones.

Option	Description
Date	Set camera clock to current date and time (see below).
Time zone	Choose home or travel destination time zone ( 85); turn daylight saving time on or off.

Selecting **Date** displays the menu shown in Step 1. Follow the steps below to set the camera clock.

1

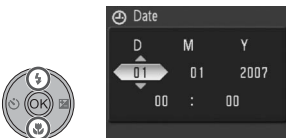



Edit **Day** (order of **Day**, **Month**, and **Year** may differ).

2

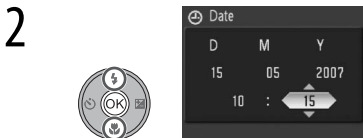



Select **Month**. Repeat steps 1–2 to edit **Month**, **Year**, hour and minute.

3

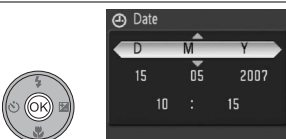



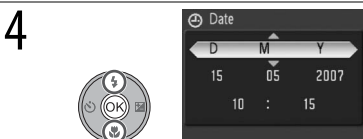

Select **D M Y**.

4





Choose date display order.
Press  to return to setup menu.

Selecting **Time zone** from the **Date** menu displays the dialog shown in Step 1. Follow the steps below to set the clock to the time in a new time zone.

1



Select **→** (travel destination time zone) or **↑** (home time zone).

2

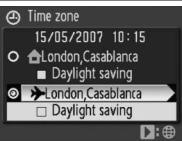

Set clock to time in selected time zone.*

* If **→** is selected, **→** will be displayed when camera is in shooting mode. To turn daylight saving time in selected zone on or off, highlight **Daylight saving** and press **OK**. Clock will automatically be adjusted one hour. Press **MENU** button to skip steps 3–6.

3



To change selected time zone, press multi selector right. Map of world time zones displayed.

4



Highlight time zone.

5

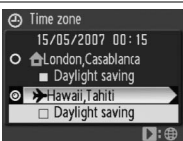

Set clock to time in new time zone.

6

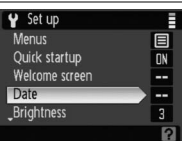

Return to setup menu.

The Clock Battery

The clock battery charges when the main battery is installed or an AC adapter is connected and can provide several days of backup power after about 10 hours of charging.

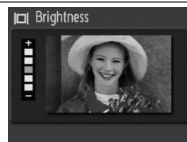

Brightness

Choose from five settings for monitor brightness (the default setting is 3).



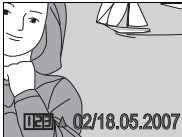

Date Imprint

Imprint date information on pictures as they are taken.



Option	Description
Off (default)	Time and date do not appear on pictures.
Date	Date or date and time are imprinted on pictures taken while this option is in effect.
Date and time	Time stamp shows number of days remaining until or elapsed since selected date (see below). Use to track growth of a child or count down days to a birthday or wedding.
Date counter	<div style="display: flex; justify-content: space-around; align-items: center;"><div style="text-align: center;"><p>Future date (days remaining)</p></div><div style="text-align: center;"><p>Past date (days elapsed)</p></div></div>

At settings other than **Off**, the selected option is shown in the monitor ( 4).

Date Counter

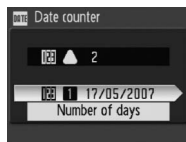

Selecting **Date counter** displays the dialog shown at right. To change the date, highlight the current date and press . The camera can store up to three dates; to enter a new date, highlight date 1, 2, or 3, press the multi selector right, and enter a date as described on page 84. To choose one of the existing dates, highlight the date and press .



Date stamps created with the date counter option can show the number of days, years and days, or years, months and days remaining until or elapsed since the selected date. To change how dates are displayed, highlight the current display option in the date counter dialog and press . Press the multi selector up or down to highlight an option and press .

Date Imprint

The date is recorded in the order selected in the **Date** menu ( 84). Date imprints do not appear on pictures taken at the settings listed on page 100 and can not be added to existing pictures. See page 60 for a comparison of date imprint and **Print set > Date**.

Data imprinted at an image size of 640×480 () may be difficult to read. Choose sizes of 1,024×768 () or larger when using date imprint.

Vibration Reduction

Vibration reduction (VR) compensates for slight hand movements that can blur pictures or cause shake in the monitor when the camera is zoomed in or when shooting in the dark without a flash. Vibration reduction can also be used when shooting movies. When vibration reduction is on, the camera detects and factors out panning movements. If the camera is panned horizontally, for example, vibration reduction reduces only vertical shake. If the camera is panned vertically, vibration reduction affects only horizontal shake.

Vibration reduction is on by default. Choose **Off** when using a tripod. The current setting is displayed in the monitor ( 4).

Vibration Reduction

Vibration reduction may take a few seconds to activate after the camera is turned on. Wait until the display stabilizes before shooting. There may also be a slight lag after a picture is taken. Vibration reduction may not produce the desired results in all cases.







AF Assist

If **Auto** is selected, AF-assist illumination will be used to assist the focus operation when the subject is poorly lit (AF-assist illumination is unavailable in some modes;  30–33). Choose **Off** to disable AF-assist illumination (note that the camera may be unable to focus if lighting is poor).

Digital Zoom

When **On** (the default setting) is selected, digital zoom functions as described on page 19: cropping is used when possible to increase magnification without affecting image quality. Select **Crop** to limit digital zoom to magnifications at which cropping can be used ( 19), or **Off** to turn digital zoom off altogether.

Digital Zoom

Digital zoom is not available when  (face-priority AF),  (portrait), or  (night portrait) is selected in scene mode or when **Wide-angle converter** is selected for **Converter. Crop** is not available at an image size of 3,648×2,736 ()¹, 3,648×2,432 ()², or 3,584×2,016 ()³. When digital zoom is in effect, the camera focuses on the subject in the center focus area and center-weighted metering is used. At magnifications of 2.0× or higher, the camera meters the center focus area only. The option selected for **Digital zoom** has no effect in movie mode, as interpolation is not used when recording movies.

Sound Settings

Adjust the following sound settings:

Option	Description
Button sound	When On (default) is selected, a beep will sound once when operations are completed successfully, three times when errors are detected.
Shutter sound	Choose sound played when shutter is released. Default setting is 1 .
Volume	Choose volume for shutter and start-up sounds from Loud, Normal, and Off .

Auto Off

Choose from 30 seconds, 1 minute (the default setting), 5 minutes, or 30 minutes. If no operations are performed for the selected length of time, the camera will enter stand-by mode to reduce the drain on the battery. The monitor will turn off and the power-on lamp will blink. If no operations are performed for about another 3 minutes, the camera will turn off automatically. Regardless of the setting chosen, the camera will remain active for 3 minutes when menus are displayed, and for 30 minutes when the camera is powered by an optional EH-62A AC adapter kit or when **Loop** is selected in slide show playback.

Format Memory/ Format Card

Format the current storage medium (internal memory or memory card). **Note that formatting permanently deletes all pictures and other data.** Be sure to make copies as required before formatting.

Format

Do not turn the camera off or remove memory cards during formatting.





Language

Choose a language for camera menus and messages from the following options:

Čeština	Czech	Italiano	Italian	Svenska	Swedish
Dansk	Danish	Nederlands	Dutch	中文简体	Simplified Chinese
Deutsch	German	Norsk	Norwegian	中文繁體	Traditional Chinese
English	English	Polski	Polish	日本語	Japanese
Español	Spanish	Português	Portuguese	한국어	Korean
Français	French	Русский	Russian	ภาษาไทย	Thai
Indonesia	Indonesian	Suomi	Finnish		

Interface





Adjust settings for connection to a computer or video device.

Option	Description
USB	Select USB option for connection to computer ( 56) or printer ( 61).
Video mode	Choose from NTSC and PAL ( 55).
Auto transfer	Choose On to mark all new pictures for transfer to computer ( 56).

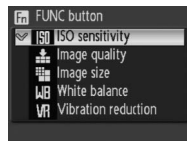
FUNC Button

Choose the function performed by the **Fn** button in **P**, **S**, **A**, and **M** modes.



Option	Description
ISO sensitivity (default)	Pressing Fn button displays ISO sensitivity options ( 71). Rotate command dial to highlight desired option and release Fn button.
Image quality	Pressing Fn button displays image quality options ( 66). Rotate command dial to highlight desired option and release Fn button.
Image size	Pressing Fn button displays image size options ( 66). Rotate command dial to highlight desired option and release Fn button.
White balance	Pressing Fn button displays white balance options ( 70). Rotate command dial to highlight desired option and release Fn button. If White bal. preset is selected, dialog shown in Step 3 on page 70 will be displayed.
Vibration reduction	Pressing Fn button displays vibration reduction options ( 87). Rotate command dial to highlight desired option and release Fn button.

Reset All

Select **Reset** to restore camera settings to default values ( 104).

Ver. Firmware Version

View the current camera firmware version.

Technical Notes

Optional Accessories

At the time of writing, the following items were available for this camera. Contact your local retailer or Nikon representative for details.

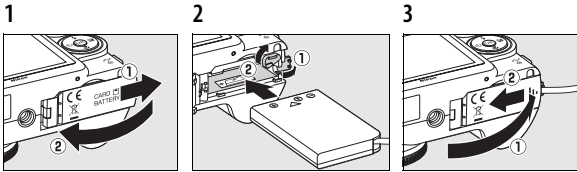
Rechargeable battery	Rechargeable EN-EL5 Li-ion batteries
Battery charger	MH-61 battery charger
AC adapter	EH-62A AC adapter kit (connects as shown)
	 <p>1 2 3</p>
	Open the power connector cover and ensure that the power connector cord passes through the opening before closing the battery-chamber/memory card slot cover. Failure to observe this precaution could cause damage to the battery-chamber/memory card slot cover.
USB cable	UC-E6 USB cable
A/V cable	EG-CP14 audio/video cable
Converter lenses (require UR-E20 lens adapter ring)	<ul style="list-style-type: none">• WC-E67 wide-angle converter (0.67×)• TC-E3ED telephoto converter (3×)
Lens adapter ring	UR-E20 step-down ring adapter
Optional Speedlights	SB-series 400, 600, 800
Strap	AN-CP16 strap

Approved Memory Cards

The following memory cards have been tested and approved for use in the COOLPIX P5000:

	High speed (10 MB/s)	High speed (20 MB/s)	Other
Panasonic	256MB	512MB, 1GB, 2GB*	64MB, 128MB, 256MB, 512MB, 1GB, 2GB*, 4GB*, †
SanDisk	512MB, 1GB, 2GB*	1GB, 2GB*	64MB, 128MB, 256MB, 512MB, 1GB, 2GB*, 4GB*, †
Toshiba	128MB, 256MB, 512MB, 1GB	—	64MB, 128MB, 256MB, 512MB, 1GB, 2GB*, 4GB*, †

* When using card reader or other device, check that device supports 2 GB cards. Pictures can still be copied to computer if camera is connected using supplied USB cable.

† SDHC () compliant.

Other cards have not been tested. For more details on the above cards, please contact the manufacturer.

Attaching Converter Lenses

The optional WC-E67 wide-angle and TC-E3ED telephoto converter lenses attach as described below (the illustrations show the WC-E67). See the converter instruction manual for details.

1 Remove the lens ring

Turn the camera off and remove the lens ring as shown at right.

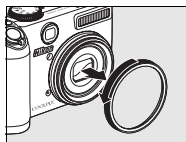

2 Remove the rear cap from the converter lens

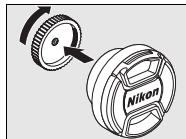

3 Attach the UR-E20 adapter ring

Attach the UR-E20 to the camera lens as shown at right.

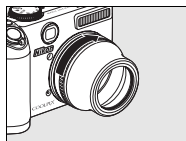

4 Attach the converter lens

Screw the converter lens into the UR-E20 as shown at right.



5 Choose a **Converter** option

Rotate the mode dial to **P**, **S**, **A**, **M**, or **ISO** and select the appropriate setting for the **Converter** option in the camera shooting menu (79).

6 Remove the lens cap

Remove the front cap from the converter lens.

Rotate the mode dial to **P**, **S**, **A**, **M**, or **ISO** when using optional converter lenses. To remove the converter, turn the camera off and perform steps 1–4 in reverse order. Set the **Converter** option in the camera shooting menu (79) to **None** when no converter is attached.

Using Optional Speedlights

The camera is equipped with an accessory shoe with a safety lock, allowing optional SB-400, SB-600, and SB-800 Speedlights to be mounted directly on the camera without a sync cable. Remove the accessory shoe cover before attaching a Speedlight and replace it when the Speedlight is not in use.

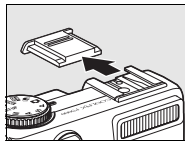

Use optional Speedlights for indirect lighting or when additional lighting is required. The built-in flash turns off automatically and a  icon appears in the display. Before using an optional Speedlight, set the Speedlight flash control mode to TTL for i-TTL flash control, which uses monitor pre-flashes to adjust flash output automatically in response to lighting conditions. Flash mode can be set as described on page 24. Power zoom can be used with SB-800 and SB-600 Speedlights, although a wide panel may be needed to illuminate the edges of the picture at ranges under 2m (2ft. 7in.) when the camera is zoomed out. Refer to the Speedlight manual for detailed instructions.

When set to STBY (stand-by), the optional Speedlight will power on and off at the same time as the camera. The camera does not support Advanced Wireless Lighting, Flash Color Information Communication, Auto FP High-Speed Sync, FV lock, or AF-assist for multi-area AF.

Use Only Nikon Flash Accessories

Use only Nikon Speedlights. Negative voltages or voltages over 250V applied to the accessory shoe could not only prevent normal operation, but damage the sync circuitry of the camera or flash. Before using a Nikon Speedlight not listed in this section, contact a Nikon-authorized service representative for more information.

Caring for the Camera

To ensure continued enjoyment of this Nikon product, observe the following precautions when storing or using the device.

- ✔ **Handle the lens and all moving parts with care**
Do not apply force to the lens or monitor or to the lens cover, connector cover, or battery-chamber/memory card slot cover. Should the monitor break, care should be taken to avoid injury due to broken glass and to prevent the liquid crystal from the display from touching the skin or entering the eyes or mouth.
- ✔ **Do not point the lens at strong light sources for extended periods**
Avoid framing the sun or other strong light sources for extended periods when using or storing the camera. Intense light may cause deterioration in the image sensor, producing a white blur effect in photographs.
- ✔ **Turn the product off before removing or disconnecting the power source**
Do not unplug the product or remove the battery while the product is on, or while images are being recorded or deleted. Forcibly cutting power could result in loss of data or in damage to product memory or circuitry. To prevent an accidental interruption of power, do not move the product while the AC adapter is connected.
- ✔ **Keep dry**
The device will be damaged if immersed in water or subjected to high levels of moisture.
- ✔ **Do not drop**
The product may malfunction if subjected to strong shocks or vibration.
- ✔ **Keep away from strong magnetic fields**
Do not use or store this device in the vicinity of equipment that generates strong electromagnetic radiation or magnetic fields. Strong static charges or the magnetic fields produced by equipment such as radio transmitters could interfere with the monitor, damage stored data, or affect the product's internal circuitry.
- ✔ **Avoid sudden changes in temperature**
Sudden changes in temperature, such as occur when entering or leaving a heated building on a cold day, can cause condensation inside the device. To prevent condensation, place the device in a carrying case or plastic bag before exposing it to sudden changes in temperature.
- ✔ **The AF-assist illuminator/self-timer lamp LED**
The light-emitting diode (LED) used in the AF-assist illuminator/self-timer lamp (2, 25) conforms to the following IEC standard.

CLASS 1 LED PRODUCT

IEC60825-1 Edition 1.2⁻²⁰⁰¹

Notes on the Monitor

- The monitor may contain a few pixels that are always lit or that do not light. This is characteristic of all TFT LCD displays and does not indicate a malfunction. Images recorded using the product will not be affected.
- When you frame bright subjects, vertical, red, comet-like streaks that brighten toward either end may appear in the display. This phenomenon, known as “smear,” does not appear in the final photograph and does not indicate a malfunction. Some smear may appear in movies.
- Images in the monitor may be difficult to see in a bright light.
- The monitor is lit by an LED backlight. Should the monitor begin to dim or flicker, contact a Nikon-authorized service representative.

Batteries

- Check the battery level when taking the camera out and charge the battery if necessary ( 16). Do not continue charging once the battery is fully charged, as this will result in reduced battery performance. If possible, carry a fully-charged spare battery when taking pictures on important occasions.
- Do not use the battery at ambient temperatures below 0°C (32°F) or above 40°C (104°F). During charging, the temperature should be in the vicinity of 5–35°C (41–95°F). Note that the battery may become hot during use; wait for the battery to cool before charging. Failure to observe these precautions could damage the battery, impair its performance, or prevent it from charging normally.
- On cold days, the capacity of batteries tends to decrease. Be sure that the battery is fully charged before heading outside to take pictures in cold weather. Keep spare batteries in a warm place and exchange as necessary. Once warmed, a cold battery may recover some of its charge.
- Dirt on the battery terminals can prevent the camera from functioning.
- When the battery is not in use, remove it from the camera or battery charger and replace the terminal cover. The camera and battery charger draw minute amounts of current even when off; if left in place, the battery could be drained to the point that it no longer functions. Turning the camera on or off while the battery is exhausted can result in reduced battery life. If the battery will not be used for an extended period, store it in a cool (15°C–25°C/59°F–77°F), dry place. Recharge it at least once a year and run it flat before returning it to storage.
- Replace the battery when it no longer holds a charge. Used batteries are a valuable resource. Please recycle used batteries in accordance with local regulations.

Cleaning

Lens/ viewfinder	Avoid touching glass parts with your fingers. Remove dust or lint with a <i>blower</i> (typically a small device with a rubber bulb attached to one end that is pumped to produce a stream of air out the other). To remove fingerprints or other stains that can not be removed with a blower, wipe with a soft cloth, using a spiral motion that starts in the center of the lens and works outwards to the edges. If this fails, clean using a cloth lightly dampened with commercial lens cleaner.
Monitor	Remove dust or lint with a blower. To remove fingerprints and other stains, clean the monitor with a soft, dry cloth, being careful not to apply pressure.
Body	Use a blower to remove dust, dirt, or sand and then wipe gently with a soft, dry cloth. After using the camera at the beach or seaside, wipe off any sand or salt with a dry cloth lightly dampened with fresh water, then dry thoroughly. Note that foreign matter inside the camera could cause damage not covered under warranty.

Do not use alcohol, thinner, or other volatile chemicals.

Storage



Turn the camera off when not in use. Check that the power-on lamp is off before putting the camera away and remove the battery if the camera will not be used for an extended period. Do not store the camera with naphtha or camphor moth balls or in locations that:



















- are next to equipment that produces strong electromagnetic fields, such as televisions or radios
- are exposed to temperatures below -10°C (14°F) or above 50°C (122°F)
- are poorly ventilated or subject to humidities of over 60%















To prevent mold or mildew, take the camera out of storage at least once a month. Turn the camera on and release the shutter a few times before putting it away again.

Error Messages

The following table lists the error messages and other warnings that appear in the monitor and how to deal with them.

Display	Problem	Solution	
 (blinks)	Clock not set.	Set clock.	84–85
	Battery running low.	Prepare to charge or change battery.	9, 10
i Warning! Battery exhausted.	Battery exhausted.	Charge or exchange battery.	9, 10
RF (● blinks red)	Camera can not focus.	Use focus lock to focus on another subject at same distance, then recompose picture.	20, 77
! Warning!! Please wait for the camera to finish recording. 	Other operations can not be performed until recording is complete.	Message clears from display automatically when recording is complete.	—
i Memory card is write protected.	Write-protect switch is in “lock” position.	Slide write-protect switch to “write” position.	15
! This card cannot be used.	Error accessing memory card.	<ul style="list-style-type: none"> • Use approved card. • Check that connectors are clean. • Confirm that memory card is correctly inserted. 	91
! Warning! This card cannot be read.			14
! Card is not formatted. No Format	Memory card has not been formatted for use in camera.	Highlight Format and press  to format card, or turn camera off and replace card.	15
i Out of memory.	Internal memory or memory card is full.	<ul style="list-style-type: none"> • Lower image quality or size. • Delete files. • Insert new memory card. • Remove memory card and use internal memory 	66
			52, 81
			14
			15
	Error occurred while recording picture.	Format internal memory or memory card.	88
	Camera has run out of file numbers.	<ul style="list-style-type: none"> • Insert new memory card. • Select Reset all after either inserting memory card or formatting internal memory or memory card. 	14
! Image cannot be saved.	Cannot create cropped, D-lighting, or small copy.	Select picture that supports crop, D-lighting, or small picture.	88, 89
	Picture can not be used for welcome screen.	Minimum size is 640×480. Pictures taken at  or  can not be used.	44
	Cannot copy picture.	Delete pictures from destination.	—
			81
! Sound file can not be saved.	Camera has run out of file numbers.	Select Reset all after either inserting memory card or formatting internal memory or memory card.	14, 88, 89

Display	Problem	Solution	
 Cannot record movie.	Time out error while recording movie.	Choose memory card with faster write speed.	91
 Memory contains no images.	No pictures available for playback.	<ul style="list-style-type: none"> • Insert card containing pictures. • Copy pictures to card. 	14 82
 No sound file.	No sound file available for playback.	<ul style="list-style-type: none"> • Insert card containing sound files. • Copy voice recordings to card. 	14 53
 There are no more index points.	Sound recording contains no indices.	Insert index before using  or  .	51
 File contains no image data.	File not created with COOLPIX P5000.	View or play file on computer or other device.	—
 This file cannot be played back.			
 All images are hidden.	All pictures in internal memory or on memory card are hidden.	Use Hide image to change hidden status of pictures.	82
 This image cannot be deleted.	Picture is protected.	Remove protection.	81
 Image has already been modified. D-Lighting can not be used.	Original does not support D-lighting.	D-lighting can not be used with copies.	44
 New city is in the current time zone.	Destination is in same time zone as home.	No need to change time zone.	85
 WARNING! Mode dial is not in the proper position.	Mode dial is between two modes.	Rotate mode dial to select desired mode.	6
 Lens error	Lens error.	Turn camera off and then on again. If error persists, contact retailer or Nikon representative.	12
 Communications error	USB cable disconnected during transfer or printing.	If PictureProject displays error, click OK to exit. Resume operation after turning camera off and reconnecting cable.	58
	USB option is incorrect.	Choose correct USB option.	56–57
	PictureProject did not start.	See the PictureProject reference manual (on CD) for more information.	—
 No images are marked for transfer.	No pictures selected for transfer.	Select pictures for transfer and try again.	82
 Transfer error	Transfer error.	• Check battery level.	16
		• Check that USB cable is connected.	58
 System error	Error has occurred in camera's internal circuitry.	Turn camera off, remove and reinsert batteries, and turn camera on. If error persists, contact retailer or Nikon representative.	12, 10–11

Display	Problem	Solution	
 Printer error. Check printer status.	Printer error.	Check printer. To resume, highlight Resume (if available) and press  .	—*
 Printer error: check paper	Paper in printer is not of selected size.	Insert paper of correct size, then highlight Resume and press  .	62*
 Printer error: paper jam	Paper is jammed in printer.	Clear jam, then highlight Resume and press  .	—*
 Printer error: out of paper	Printer is out of paper.	Insert paper of selected size, then highlight Resume and press  .	62*
 Printer error: check ink	Ink error.	Check ink. To resume, highlight Resume and press  .	—*
 Printer error: out of ink	Printer is out of ink.	Replace ink, then highlight Resume and press  .	—*
 Printer error: file corrupt	File is corrupt; image can not be printed.	Highlight Cancel and press  to end printing.	—*

* See printer manual for more information.

Electronically Controlled Cameras

In extremely rare instances, unusual characters may appear in the monitor and the camera may stop functioning. In most cases, this phenomenon is caused by a strong external static charge. Turn the camera off, remove and replace the batteries, and then turn the camera on again. In the event of continued malfunction, contact your retailer or Nikon representative. Note that disconnecting the power source as described above may result in the loss of any data not recorded to internal memory or the memory card at the time the problem occurred. Data already recorded will not be affected.













Troubleshooting

If the camera fails to function as expected, check the list of common problems below before consulting your retailer or Nikon representative. Refer to the page numbers in the right-most column for more information.









Display and Setup

Problem	Solution	Page
Monitor is blank.	• Camera is off.	12
	• Battery is exhausted.	16
	• Monitor is off: press  button.	8
	• Stand-by mode: press shutter-release button.	16
	• Flash lamp blinks red: wait until flash has charged.	24
	• USB cable is connected.	58
	• A/V cable is connected.	55
	• Time lapse or interval timer photography in progress: monitor turns off automatically between shots.	49, 74
Monitor is hard to read.	• Ambient lighting too bright: use viewfinder or move to darker location.	18
	• Monitor has dimmed to saved power: press shutter-release button halfway.	16
	• Adjust monitor brightness.	85
	• Monitor is dirty: clean monitor.	96
Camera turns off without warning.	• Battery is low.	16
	• Camera has turned off automatically to save power.	16
	• Battery is cold.	95
Camera clock is not correct.	Check camera clock regularly against more accurate time-pieces and reset as required.	84–85
No indicators appear in monitor.	• Press  button until indicators are displayed.	8
	• Slide show is in progress.	81
Date imprint not available.	Camera clock has not been set.	84–85
Date not appearing on pictures taken with Date imprint .	Date does not appear on movies or on pictures taken in  ,  ,  , or  mode, with Continuous or Continuous flash selected for Continuous , or while BSS or bracketing is on.	30, 32, 33, 36, 47, 73, 75
Camera settings reset.	Clock battery exhausted: recharge clock battery. Pictures recorded before clock has been set will have time stamp of "00.00.0000 00:00"; movies will be dated "01.01.2007 00:00."	85





Shooting

Problem	Solution	
No picture taken when shutter-release button is pressed.	<ul style="list-style-type: none"> Battery is exhausted. Flash lamp blinks: flash is charging. 	16 24
Camera can not focus using autofocus.	<ul style="list-style-type: none"> Subject is low in contrast, dominated by repeating geometric patterns, occupies too little of the frame, or contains many fine details, objects of sharply differing brightness, or objects at different distances from camera. Use focus lock to focus on another subject at same distance, then recompose picture. Off is selected for AF-assist option in setup menu. AF lamp flickers: subject not in focus area when shutter-release button pressed halfway. Focus error: turn camera off and then on again. 	77 87 20 12
Pictures are blurred.	<ul style="list-style-type: none"> Rotate mode dial to . Use flash or BSS. Turn on vibration reduction or use tripod and self-timer. Incorrect option selected in converter menu. 	36 24, 75 26, 87 79
Bright specks in pictures taken with flash.	Flash is reflecting from particles in air. Turn flash off.	24
Built-in flash does not fire.	Flash is off. Note that flash turns off automatically in  mode (Time lapse movie  excepted) and some scene modes, when Continuous is selected for Continuous , when BSS or bracketing is on, when an option other than None is selected for Converter , when Built-in off is selected for Flash control , or when optional flash unit is attached.	24, 30–33, 47, 73, 75, 78, 79, 93
Optical zoom can not be used.	Optical zoom can not be used while shooting movies.	47
Digital zoom can not be used.	 ,  , or  selected in scene mode, Wide angle converter selected for Converter , or Off selected for Digital zoom .	30, 79, 87
Image size options not available.	Settings of 3,648×2,736 () , 3,648×2,432 () , and 3,584×2,016 () are not available when 3200 is selected for ISO sensitivity .	71
No sound when shutter is released.	Sound is not played in  ,  , () , or  mode or when Off is selected for Sound settings > Shutter sound , BSS or bracketing is on, or option other than Single is selected for Continuous .	30, 32, 36, 47, 73, 75, 88
AF-assist illuminator does not light.	<ul style="list-style-type: none"> Off selected for AF-assist option in setup menu. AF assist illumination turns off automatically in some modes. 	87 30–33

Shooting (Continued)

Problem	Solution	
Pictures are smeared.	Lens is dirty. Clean lens.	96
Colors are unnatural.	White balance does not match light source.	70
Randomly-spaced bright pixels (“noise”) appear in image.	Shutter speed too slow or ISO sensitivity too high. Noise can be reduced by: <ul style="list-style-type: none"> • Using flash • Choosing P, S, A, or M mode and setting ISO sensitivity to 64 • Choosing scene mode with noise reduction or turning Noise reduction on 	24 71 30–33, 78
Pictures are too dark (underexposed).	<ul style="list-style-type: none"> • Rotate mode dial to  or choose higher ISO sensitivity. • Flash is off. • Flash window is blocked. • Subject is outside of range of flash. • Exposure compensation is too low. • Subject is backlit: select  (scene mode) or use fill flash. 	37, 71 24 18 24 28 24, 33
Pictures are too bright (overexposed).	Exposure compensation is too high.	28
Unexpected results when flash set to  (auto with red-eye reduction).	Advanced red-eye reduction may, in very rare cases, be applied to areas not affected by red-eye. Set flash to  or  and try again. Note that red-eye reduction is default flash setting for  ,  , and  modes.	24–25, 30

Playback

Problem	Solution	
Pictures can not be played back.	<ul style="list-style-type: none"> • Time lapse or interval timer photography in progress: pictures can not be played back until recording is complete. • File has been overwritten or renamed by computer or other make of camera. 	49, 74 —
Can not zoom in on picture.	Playback zoom can not be used with movies, small pictures, or pictures cropped below 320×240.	—
Can not record voice memo.	Voice memos can not be appended to movies.	50
Can not use crop, D-lighting, or small picture options.	These options can not be used with movies or with pictures recorded at image sizes of 3,648×2,432 () or 3,584×2,016 (), and may not be available with pictures created with other cameras. Select picture that supports crop, D-lighting, or small picture.	44
Pictures not displayed on television	<ul style="list-style-type: none"> • Choose correct video mode. • Memory card contains no pictures. Insert memory card containing pictures, or remove card to view pictures in internal memory. 	89 14–15
PictureProject does not start when camera is connected.	<ul style="list-style-type: none"> • Camera is off. • Battery is exhausted. • USB cable is not correctly connected. • Appropriate USB option is not selected. • Computer can not detect camera. • PictureProject auto-launch disabled. See PictureProject reference manual (on CD) for details.	12 16 58 56 — —
Can not mark pictures for transfer.	No more than 999 pictures can be marked for transfer. Use PictureProject Transfer button to transfer pictures.	58
Transfer marking does not appear.	Pictures were marked for transfer using another model of camera. Mark pictures for transfer using COOLPIX P5000.	82
Can not transfer pictures.	 button can not be used to transfer pictures if memory card is locked, or if no memory card is inserted and Mass storage is selected for USB . Use PictureProject Transfer button.	58

Appendix

Defaults

Choosing **Reset** for **Reset all** (🔑 89) restores the following default settings:





Option	Default
Shooting mode (🔑 24–28)	
Flash mode	Auto
Self-timer	Off
Focus mode	Autofocus
Exposure compensation	0
Scene mode (🔑 29–35)	Face-priority AF
Movie mode (🔑 47–50)	
Movie options	Small size 320
Set interval time	30s
Auto-focus mode	Single AF
Shooting menu (🔑 65–79)	
Image quality	Normal
Image size	3648×2736 (10M)
Optimize image	Normal
Custom	
Contrast	Auto
Image sharpening	Auto
Saturation	Auto
Black-and-white	Standard
Custom	
Contrast	Auto
Image sharpening	Auto
Monochrome filter	None
White balance	Auto
ISO sensitivity	Auto
Metering	Matrix
Continuous	Single
Interval timer shooting	30s
BSS	Off
Auto bracketing	Off

Option	Default
Shooting menu (continued)	
AF-area mode	Auto
Auto-focus mode	Single AF
Flash exp. comp.	0
Flash control	Auto
Fixed aperture	Off
Noise reduction	Off
Converter	None
Wide-angle converter	Distortion control on
Playback menu (🔑 80–82)	
Slide show	
Frame intvl	3s
Setup menu (🔑 83–89)	
Menus	Text
Quick startup	On
Welcome screen	Animation
Brightness	3
Date imprint	Off
Vibration reduction	On
AF assist	Auto
Digital zoom	On
Sound settings	
Button sound	On
Shutter sound	1
Volume	Normal
Auto off	1 m
Interface	
Auto transfer	On
FUNC button	ISO sensitivity
Miscellaneous	
Paper size (🔑 62)	Default

Choosing **Reset** also clears the current file number (🔑 106) from memory. Numbering will continue from the lowest number available (to reset file numbering to 0001, delete all pictures before selecting **Reset**). All other settings are unaffected, including **Date** (🔑 84), **Date counter** (🔑 86), **Language** (🔑 88), **USB** (🔑 89), and **Video mode** (🔑 89).

Restrictions on Camera Settings

Restrictions apply to the following settings in **P, S, A, M,** and **HS** modes:

Self-timer ( 26)	If self-timer is on, only one shot will be taken each time shutter is released, regardless of settings chosen for Continuous , BSS , and Auto bracketing . Original Continuous , BSS , and Auto bracketing settings are restored when picture is taken or self-timer is turned off.
Continuous ( 73)	Selecting option other than Single for Continuous turns BSS and Auto bracketing off.
BSS ( 75)	When BSS is on, Continuous is set to Single and Auto bracketing turns off.
Auto bracketing ( 75)	When Auto bracketing is on, Continuous is set to Single and BSS turns off.

Auto Noise Reduction

Noise reduction will only turn on automatically if **Continuous** is set to **Single** and **BSS** and **Auto bracketing** are off.





Using a Flash in Continuous Mode (73)

The built-in flash turns off automatically when **Continuous** is selected for **Continuous**; optional flash units mounted on the camera accessory shoe can still be used.

Image File and Folder Names

Pictures, movies, and voice memos are assigned file names with three parts: a four letter identifier, a four-digit file number assigned automatically by the camera in ascending order, and a three-letter extension (e.g., "DSCN0001.JPG").

Originals	Identifier	Extension	Copies	Identifier	Extension
Still picture	DSCN	.JPG	Cropped copy	RSCN	.JPG
Movie	DSCN	.AVI	Small copy	SSCN	
Time-lapse	INTN		D-lighting copy	FSCN	
Voice recording	DSCN	.WAV			
Voice memo	Same as picture				

Pictures and sound files are stored in folders named with a three-digit folder number followed by a five-character identifier: "P_" plus a three-digit sequence number for pictures taken using panorama assist (e.g., "101P_001";  35), "INTVL" for interval timer photography (e.g., "101INTVL";  74), "SOUND" for voice recordings (e.g., "101SOUND";  51), and "NIKON" for all other pictures (e.g., "101NIKON"). Folders can hold up to 200 pictures; if a picture is taken when the current folder contains 200 pictures, a new folder will be created by adding one to the current folder number. If a picture is taken when the current folder is numbered 999 and contains 200 pictures or a picture numbered 9999, no further pictures can be taken until the medium is formatted ( 88) or a new memory card is inserted.

Files copied using **Copy>Selected images** or COPY SOUND FILES>**Selected files** are copied to the current folder, where they are assigned new file numbers in ascending order starting from the largest file number in memory. **Copy>All images** and COPY SOUND FILES>**Copy all files** copy all folders from the source device; file names do not change but new folder numbers are assigned in ascending order starting from the largest folder number on the destination device ( 53, 82).

Time Zones (85 12, 85)

The camera supports the time zones listed below. Increments of less than one hour are not supported; when travelling to or from destinations at half- or quarter-hour increments from Greenwich Mean Time (GMT), such as Afghanistan, Central Australia, India, Iran, Nepal, or Newfoundland, set the camera clock to local time (85 84).

GMT +/-	Location	GMT +/-	Location
-11	Midway, Samoa	+1	Madrid, Paris, Berlin
-10	Hawaii, Tahiti	+2	Athens, Helsinki
-9	Alaska, Anchorage	+3	Moscow, Nairobi
-8	PST: Los Angeles, Seattle, Vancouver	+4	Abu Dhabi, Dubai
-7	MST: Denver, Phoenix, La Paz	+5	Islamabad, Karachi
-6	CST: Chicago, Houston, Mexico City	+6	Colombo, Dhaka
-5	EST: New York, Toronto, Lima	+7	Bangkok, Jakarta
-4	Caracas, Manaus	+8	Beijing, Hong Kong (HK), Singapore
-3	Buenos Aires, São Paulo	+9	Tokyo, Seoul
-2	Fernando de Noronha	+10	Sydney, Guam
-1	Azores	+11	New Caledonia
±0	London, Casablanca	+12	Auckland, Fiji

Specifications

Nikon COOLPIX P5000 Digital Camera

Type	Compact digital camera
Effective pixels	10.0 million
Image sensor	1/1.8-in. CCD; total pixels: approx. 10.37 million
Lens	3.5× Zoom-Nikkor lens
Focal length	7.5 to 26.3 mm (35 mm [135] picture angle equivalent approx. 36–126 mm)
f-number	f/2.7 to 5.3
Construction	7 elements in 6 groups
Digital zoom	Up to 4× (35 mm [135] picture angle equivalent approx. 504 mm)
Vibration reduction (VR)	Lens shift
Autofocus (AF)	Contrast-detect AF
Focus range (from lens)	30 cm/1 ft to ∞ (W); 70 cm/2 ft. 4 in. to ∞ (T) Macro close-up mode: 4 cm/1.6 in. to ∞ (W); 40 cm/1 ft. 4 in. to ∞ (T)
Focus-area selection	Auto (9 focus areas), manual (99 focus areas), center
AF-assist illumination	Class 1 LED product (IEC 60825-1 Edition 1.2-2001); max. output: 1,500 μW
Viewfinder	Real-image optical viewfinder with LED indication
Frame coverage	Approx. 80% vertical and 80% horizontal
Monitor	2.5-in., 230,000-dot, wide viewing angle TFT LCD with anti-reflection coating and 5-level brightness adjustment
Frame coverage	Shooting mode: approx. 97% vertical and 97% horizontal Playback mode: approx. 100% vertical and 100% horizontal
Storage	
Media	Internal memory (approx. 21 MB); SD (Secure Digital) memory cards
File system	DCF, Exif 2.2, and DPOF compliant
File formats	Compressed: JPEG-Baseline-compliant (Fine 1:4, Normal 1:8, Basic 1:16) Movies: AVI Sound files: WAV
Image size (pixels)	<ul style="list-style-type: none">• 3,648 × 2,736 (10M)• 2,048 × 1,536 (3M)• 1,280 × 960 (1M)• 640 × 480 (1/4M)• 3,584 × 2,016 (16.9M)• 2,592 × 1,944 (5M)• 1,600 × 1,200 (2M)• 1,024 × 768 (1M)• 3,648 × 2,432 (16.2M)
ISO sensitivity	ISO 64, 100, 200, 400, 800, 1600, 2000, 3200; Auto (auto gain from ISO 64 to ISO 800)

Specifications

Nikon will not be held liable for any errors this manual may contain. The appearance of this product and its specifications are subject to change without notice.

Exposure	
Metering	256-segment matrix, center-weighted, spot, spot AF area (with support for 99 AF areas)
Exposure control	Programmed auto exposure with flexible program, shutter-priority auto, aperture-priority auto, manual, exposure compensation (-2.0–+2.0EV in steps of 1/3EV), auto bracketing
Range (ISO 100)	[W]: -1.0 to +17.5EV [T]: +0.9 to +16.4EV
Shutter	
Speed	1/2,000s to 8s
Aperture	
Number of stops	10 stops of 1/3EV
Self-timer	
Can be selected from 10 and 3 seconds duration	
Built-in flash	
Range (approx.)	[W]: 0.3 to 8m/1 to 26ft. [T]: 0.3 to 4m/1 to 13ft.
Flash control	Sensor flash system
Accessory shoe	
ISO 518 hot-shoe contact with safety lock	
Sync contact	X-contact only
Interface	
USB	
Video output	
Can be selected from NTSC and PAL	
I/O terminals	
Audio/video out; digital I/O (USB)	
Supported languages	
Chinese (Simplified and Traditional), Czech, Danish, Dutch, English, Finnish, French, German, Indonesian, Italian, Japanese, Korean, Polish, Portuguese, Norwegian, Russian, Spanish, Swedish, Thai	
Power sources	
<ul style="list-style-type: none"> • One EN-EL5 rechargeable Li-ion battery (supplied) • EH-62A AC adapter kit (available separately) 	
Battery life*	Approx. 250 shots (EN-EL5)
Dimensions (W×H×D)	Approx. 98×64.5×41 mm/3.9×2.5×1.6in. (excluding projections)
Weight	Approx. 200g/7.1 oz. (without battery or memory card)
Operating environment	
Temperature	0 to 40°C/32 to 104°F
Humidity	Less than 85% (no condensation)

* Based on Camera and Imaging Products Association (CIPA) standards for measuring life of camera batteries. Measured at 23°C (77°F); zoom adjusted with each shot, flash fired with every other shot, image quality set to **Normal** and image size set to 3,648×2,736 (L).

Unless otherwise stated, all figures are for a camera with a fully-charged EN-EL5 battery operated at an ambient temperature of 25°C (77°F).

MH-61 Battery Charger

Rated input	100 to 240V AC, 50/60Hz, 0.12 to 0.08A
Rated capacity	11 to 16VA
Rated output	DC 4.2V/950mA
Supported batteries	EN-EL5 rechargeable Li-ion batteries (supplied)
Charging time	Approximately 2 hours when battery is fully discharged
Operating temperature	0 to 40°C/32 to 104°F
Dimensions (W×H×D)	Approx. 67×26×67 mm/2.6×1.0×2.6 in. (excluding projections)
Weight	Approx. 70g/2.5 oz. (excluding power cable)

EN-EL5 Rechargeable Li-ion Battery









Type	Rechargeable Li-ion battery
Rated capacity	3.7V/1100mAh
Operating temperature	0 to 40°C /32 to 104°F
Dimensions (W×H×D)	Approx. 36×54×8mm/1.4×2.1×0.3 in. (excluding projections)
Weight	Approx. 30g/1.1 oz. (excluding terminal cover)

Supported Standards

- **DCF:** Design Rule for Camera File System (DCF) is a standard widely used in the digital camera industry to ensure compatibility among different makes of camera.
- **DPOF:** Digital Print Order Format (DPOF) is an industry-wide standard that allows pictures to be printed from print orders stored on a memory card.
- **Exif version 2.2:** This camera supports Exif (**EX**changeable Image File Format for Digital Still Cameras) version 2.2, a standard that allows information stored with photographs to be used for optimal color reproduction when images are output on Exif-compliant printers.
- **PictBridge:** A standard developed in cooperation with the digital camera and printer industries, allowing photographs to be output directly to a printer without connecting the camera to a computer.

Index

Symbols

-  (anti-shake) mode 6, 36
-  (auto) mode 6, 16–21
-  (delete) button 3, 22
-  (monitor) button 3, 8
-  (movie) mode 6, 47–49
-  (playback) button 3, 12, 22, 23
- . *See* Scene mode 6, 29–35
-  (transfer) button 3
-  (wait) icon 21

A

- A*. *See* Aperture-priority auto 38, 41
- A/V cable 55
- AC adapter 2, 10, 49, 54, 85, 88, 90, 94, 109
- Accessories x, 90–93

AE-L 4, 35

RF . *See* Focus, indicator 4, 20, 97

AF area mode 76

AF assist 87

AF lamp 3, 20

AF-assist illuminator 2, 25, 87, 94, 101, 108

Aperture 4, 17, 38, 39, 41, 42, 78

Aperture-priority auto 38, 41

Audio. *See* Movies; Sound; Voice memo;
Voice recording 47, 88, 46, 51

Auto bracketing 75, 105

Auto off 16, 88

Auto off 88

Auto-focus mode 76

AVI 106

B

- Backlit subjects 24, 33, 44
- Batteries ii, x, 9–11, 90, 95, 109, 110
 - charging 9
 - inserting 10
 - removing 11
- Battery chamber 3, 10
- Battery charger iii, 9, 90, 110
- Battery level indicator 4, 5, 16
- Best Shot Selector. *See* **BSS** 75, 105

Black-and-white. *See* Movies; **Optimize image** 68–69

Blur 21, 25, 26, 87, 101. *See also*  (anti-shake) mode 6, 36

Bracketing. *See* **Auto bracketing** 75, 105

Brightness 85

BSS 75, 105

Burst. *See* **Continuous**; Scene mode, Sports  73–74, 30

C

Cleaning 96

Clock. *See* **Date** 12–13, 84–85

Close-ups. *See* Focus, mode; Scene mode,
Close-up  7, 27, 32

Color 68, 70, 102

Command dial 2, 23, 65, 89

Computer 56, 58, 60

copying pictures to 56–59, 60, 103

Continuous 73–74, 105

Contrast 44, 68

Converter 79

Converter lens 79, 90, 92. *See also* Accessories; **Converter** 90, 79, 92

Copies 44–45, 106. *See also* **Copy** (playback menu); Cropping pictures; **D-Lighting**; **Small pic.** 82, 44–45

Copy (playback menu) 82, 106

Cropping pictures 43, 45, 103

D

Date 12–13, 84–85

Date and time 12–13, 84. *See also* **Date** 12–13, 84–85
printing 60, 64, 86

Date counter 86

Date imprint 60, 86, 100

Daylight saving time. *See* **Date** 12–13, 84–85

DCF. *See* Design Rule for Camera File System 110

Defaults 104

restoring. *See* **Reset all** 89, 104

Delete 81

Deleting 22, 81

- all pictures 81. *See also* Formatting 15, 88
- individual pictures 22, 43
- last picture 22
- movies 50
- selected pictures 81
- voice memos 46
- voice recordings 52

Design Rule for Camera File System 110

Digital Print Order Format 60, 64, 110

Digital zoom 87

Digital zoom. *See* Zoom, digital 19, 47, 72, 87, 101, 108

Direct Print. *See* PictBridge 60–63, 110

Distortion 79

Distortion control off. *See* Converter 79

Distortion control on. *See* Converter 79

D-Lighting 44, 103

DPOF. *See* Digital Print Order Format 60, 64, 110

E

E-mail 45, 66

Energy saving. *See* Auto off 16, 88

Error messages 97–99

Exif 2.2 110

Exif Print. *See* Exif 2.2 110

Exposure 38, 42, 75, 102

- bracketing 75

- compensation 4, 7, 28, 75, 102

Extension 106

F

File names 8, 106

Fill flash 24, 33

Firmware 89

Firmware version 89

Fixed aperture 41, 78

Flash iii, 24–25, 73, 78

- built-in 2, 24, 78, 105, 109

- compensation 78

- mode 7, 24, 102

- optional 25, 73, 78, 90, 93, 105

Flash control 78

Flash exp. comp. 78

Flash lamp 3, 24

Fn (FUNC) button 3, 29, 48, 89. *See also*

FUNC button 89

Focus 20, 27, 76, 101, 108

- area 4, 20, 33, 76

- face-priority 34

- indicator 4, 20, 97

- lock 77

- mode 7, 27

Folders 8, 106

Format card 88

Format memory 88

Formatting 81, 82, 88, 89, 7

- internal memory. *See* **Format memory** 88

- memory cards. *See* **Format card** 88

FUNC button 89

H

Help 7

Hide image 82

Hiding images 82

HiISO (high sensitivity) mode 6, 37

Histogram 8

I

Image quality 66

Image quality and size 17, 29, 36, 66–67, 89, 101

Image size 66

Indoor photography 31, 32, 37

Interface 55, 57, 61, 89

Internal memory v, 14, 17, 22, 23

- capacity of 14, 48, 67

- formatting 88

Interval timer. *See* **Continuous**; Movies,

- time-lapse 73–74, 106, 49

ISO sensitivity 25, 71, 89

ISO sensitivity 71

J

JPEG ("*.JPG") 45, 66, 106, 108

L

Landscapes 27, 30, 31

Language 88

Language, choosing 12, 88

Lens 2, 96, 108

- adapter ring 90, 92

Lens cover 2

M

M. See Manual 38, 42

Manual 38, 42

Memory card slot 3, 14–15

Memory cards v, 14–15, 17, 22, 60, 91

approved 91

capacity of 48, 67

formatting 15

inserting 14

removing 15

MENU button 3, 65, 80

Menus 29, 37, 48, 65–89

text or icons 83

Menus 83

Metering 72

Metering 72

Microphone 2, 46, 47, 51

Mode dial 2, 6

Monitor 3, 4–5, 8, 95, 96, 108

brightness 85

indicators in 4–5, 8, 16–17, 100

Movie menu 48

Movies 43, 47–50, 106

deleting 50

recording 47–49

time-lapse 49

viewing 50

Moving subjects 30, 37

Multi selector 3, 7, 22

N

Night photography 24, 30, 31

Noise reduction 31, 40, 78, 102

Noise reduction 78, 105

NTSC. See Video mode 55, 89

Number of exposures remaining 4, 16

O

 button 3, 7

On/off. See Power switch 2, 12

Optimize image 68–69

P

P. See Programmed auto 38, 39

PAL. See Video mode 55, 89

Panorama 33, 35

PictBridge 60–63, 110

PictureProject 53, 56, 58, 103

Playback 5, 22–23, 43–46

full-frame 22–23

menu 44, 45, 64, 80–82

movies 50

thumbnail 23, 43

voice memos 46

voice recording 52

zoom 23, 43

Portraits 24, 26, 30, 33, 34, 72

Power saving. See Auto off 16, 88

Power switch 2, 12

Power-on lamp 2, 12

Print set 60, 64

Print size 66

Printing 60–63. See also Date and time, printing; **Date imprint**; Digital Print Order Format; PictBridge; **Print set** 12–13, 84, 60–63, 86, 110, 64

Programmed auto 38, 39

Protect 81

Protected pictures 43, 81

Q

Quick startup 83

QuickTime 53

R

Rear-curtain sync. See Flash, mode 7, 24

Red-eye reduction. See Flash, mode 7, 24, 102

Reset all 89, 104

Retouching pictures 44–45

S

S. See Shutter-priority auto 38, 40

SCENE. See Scene mode 6, 29–35

Scene mode 6, 29–35

Back light () 33

Beach/Snow () 31

Close-up () 32

Copy () 32

Dusk/Dawn () 31

Face-priority AF () 30, 34

Fireworks show () 32

Landscape () 30

Museum () 32

Night landscape () 31

Night portrait () 30

Panorama assist (📷) 33, 35
Party/Indoor (👤) 31
Portrait (👤) 30
Sports (🏃) 30
Sunset (🌅) 31
Voice recording (🎤). *See* Voice recording 51–53, 106

SD (Secure Digital). *See* Memory cards 14, 91
Secure Digital (SD). *See* Memory cards 14, 91
Self-timer 7, 26, 105
Self-timer lamp 2, 26, 94
Sensitivity. *See* ISO sensitivity 71
Sepia 48
SETUP. *See* Setup mode 6, 83
Setup menu 83–89
Setup mode 6, 83
Sharpening 68
Shooting menu 65–79
Shutter speed 4, 17, 38, 39, 40, 42, 78
Shutter-priority auto 38, 40
Shutter-release button 2, 20–21
Slide show 81
Slide shows 81
Slow sync. *See* Flash, mode 7, 24
Small pic. 45, 103
Smear 47, 95
Sound 88, 101. *See also* Volume 46, 50, 52, 88
Sound settings 88
Speaker 3
Speedlight. *See* Flash, optional 93
Stand-by. *See* Auto off 16, 88
Startup 83, 84
Strap, camera 3
Support information 1

T
T. *See* Zoom control 2, 7, 19, 43
Telephoto. *See* Accessories; **Converter**;
Zoom 90, 79, 92, 19
Television 55, 103
 connecting to 55
Thumbnail playback 43
Time lapse. *See* **Continuous**; Movies, time-lapse 73–74, 106, 49
Time zone 12–13, 85, 107. *See also* **Date** 12–13, 84–85

Time. *See* **Date** 12–13, 84–85
Timer. *See* Self-timer 2, 26, 105
Transfer
 mark 43, 56, 103
 marking pictures for 56, 82, 89, 103

Transfer marking 82
Tripod 3, 25, 26, 31, 35

U

USB 56–57, 59, 60, 61, 89. *See also* **Interface** 57, 89
 cable 56, 58, 59

V

Vibration reduction 17, 87, 89, 108

Vibration reduction 87

Video mode 55, 89

Viewfinder iii, 2, 3, 18, 96, 108

Voice memo 23, 46, 82, 103, 106

 deleting 46

 playback 46

 recording 46

Voice recording 51–53, 82, 106

 copying 53

 deleting 52

 playback 52

 recording 51

Volume 46, 50, 52, 88

VR. *See* Vibration reduction 17, 87, 89, 108

W

W. *See* Zoom control 2, 19, 43

WAV 106

Welcome screen 84

White balance 70, 89, 102

 preset 70

White balance 70

Wide angle. *See* Accessories; **Converter**;

Zoom 90, 79, 92, 19

Z

Zoom 19, 36, 41, 78

 digital 19, 47, 72, 87, 101, 108

 indicator 4, 19

 optical 19, 47, 101

 playback 23, 43, 103

Zoom control 2, 7, 19, 43

Nikon

No reproduction in any form of this manual, in whole or in part (except for brief quotation in critical articles or reviews), may be made without written authorization from NIKON CORPORATION.

NIKON CORPORATION

Fuji Bldg., 2-3 Marunouchi 3-chome,
Chiyoda-ku, Tokyo 100-8331, Japan



Printed in Japan

SB7B02(11)

6MA28511--