

# FUJIFILM

DIGITAL CAMERA

# *FinePix A610*

DIGITAL CAMERA

# *FinePix A800*

## OWNER'S MANUAL

This manual will show you how to use your FUJIFILM DIGITAL CAMERA FinePix A610/FinePix A800 correctly. Please follow the instructions carefully.

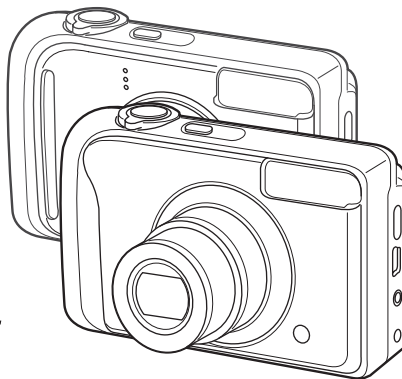

**digital**  
Tools for the Imagination.

**Exif Print**

**xD**  
xD-Picture Card™

**S**  
SD™

**PictBridge**



Getting Ready

Using the Camera

Advanced Features • Photography

• Playback

• Movie

Settings

Camera Connection

Software  
Installation

Appendices

Troubleshooting

BL00593-201(1) **E**

# Warning

To prevent fire or shock hazard, do not expose the unit to rain or moisture.

## For customers in the U.S.A.

*Tested To Comply  
With FCC Standards  
FOR HOME OR OFFICE USE*

### FCC Statement

This device complies with Part 15 of the FCC Rules. Operation is subject to the following two conditions: (1) This device may not cause harmful interference, and (2) this device must accept any interference received, including interference that may cause undesired operation.

### CAUTION

This equipment has been tested and found to comply with the limits for a Class B digital device, pursuant to Part 15 of the FCC Rules. These limits are designed to provide reasonable protection against harmful interference in a residential installation. This equipment generates, uses, and can radiate radio frequency energy and, if not installed and used in accordance with the instructions, may cause harmful interference to radio communications. However, there is no guarantee that interference will not occur in a particular installation. If this equipment does cause harmful interference to radio or television reception, which can be determined by turning the equipment off and on, the user is encouraged to try to correct the interference by one or more of the following measures:

- Reorient or relocate the receiving antenna.
- Increase the separation between the equipment and receiver.
- Connect the equipment into an outlet on a circuit different from that to which the receiver is connected.
- Consult the dealer or an experienced radio/TV technician for help.

You are cautioned that any changes or modifications not expressly approved in this manual could void the user's authority to operate the equipment.

### Notes on the Grant:

To comply with Part 15 of the FCC Rules, this product must be used with a Fujifilm-specified ferrite-core A/V cable, USB cable, and DC supply cord.

## For customers in Canada

### CAUTION

This Class B digital apparatus complies with Canadian ICES-003.

**Please read the Safety Notes (→p.158) and make sure you understand them before using the camera.**

## NOTICE

**BEFORE OPENING THE CD-ROM PROVIDED BY FUJIFILM CORPORATION, PLEASE READ THIS END USER LICENSE AGREEMENT CAREFULLY. ONLY IF YOU AGREE WITH THIS AGREEMENT, SHOULD YOU USE THE SOFTWARE RECORDED ON THE CD-ROM. BY OPENING THE PACKAGE, YOU ACCEPT AND AGREE TO BE BOUND BY THIS AGREEMENT.**

## End User License Agreement

This End User License Agreement ("Agreement") is an agreement between FUJIFILM Corporation ("FUJIFILM") and you, which sets forth the terms and conditions of the license granted for you to use the software provided by FUJIFILM.

The CD-ROM contains third party software. In case a separate agreement is provided by a third party supplier for its software, the provisions of such separate agreement shall apply to the use of such third party software, prevailing over those of this Agreement.

### 1. Definitions.

- (a) "Media" means the CD-ROM titled "Software for FinePix KA" - which is provided to you together with this Agreement.
- (b) "Software" means the software which is recorded on Media.
- (c) "Documentation" means the operation manuals of Software and other related written materials which are provided to you together with Media.
- (d) "Product" means Media (including Software) and Documentation collectively.

### 2. Use of Software.

FUJIFILM grants to you a nontransferable, nonexclusive license:

- (a) to install one copy of Software onto one computer in binary machine executable form;
- (b) to use Software on the computer onto which Software is installed; and
- (c) to make one backup copy of Software.

### 3. Restrictions.

- 3.1 You shall not distribute, rent, lease or otherwise transfer all or any part of Software, Media or Documentation to any third party without FUJIFILM's prior written consent. You also shall not sublicense, assign or otherwise transfer all or any part of the rights granted to you by FUJIFILM under this Agreement without FUJIFILM's prior written consent.
- 3.2 Except as expressly granted by FUJIFILM hereunder, you shall not copy or reproduce all or any part of Software or Documentation.
- 3.3 You shall not modify, adapt or translate Software or Documentation. You also shall not alter or remove copyright and other proprietary notices that appear on or in Software or Documentation.
- 3.4 You shall not, or shall not have any third party, reverse-engineer, decompile, or disassemble Software.

### 4. Ownership.

All copyrights and other proprietary rights to Software and Documentation are owned and retained by FUJIFILM or the third party suppliers as indicated on or in Software or Documentation. Nothing contained herein shall be construed, expressly or implicitly, as transferring or granting any right, license, or title to you other than those explicitly granted under this Agreement.

### 5. Limited Warranty.

FUJIFILM warrants to you that Media is free from any defect in material and workmanship under normal use for ninety (90) days from the date of your receipt of Media. Should Media not meet the foregoing warranty, FUJIFILM shall replace such defective Media with other Media bearing no defect. FUJIFILM's entire liability and your sole and exclusive remedy with regard to any defect in Media shall be expressly limited to such FUJIFILM's replacement of Media as provided herein

### 6. DISCLAIMER OF WARRANTY.

EXCEPT AS PROVIDED IN SECTION 5 HEREIN, FUJIFILM PROVIDES PRODUCT "AS IS" AND WITHOUT WARRANTIES OF ANY KIND, EXPRESS OR IMPLIED. FUJIFILM SHALL MAKE NO WARRANTY, EXPRESS, IMPLIED OR STATUTORY, AS TO ANY OTHER MATTERS, INCLUDING, BUT NOT LIMITED TO NON-INFRINGEMENT OF ANY COPYRIGHT, PATENT, TRADE SECRET, OR ANY OTHER PROPRIETARY RIGHTS OF ANY THIRD PARTY, MERCHANTABILITY, OR FITNESS FOR ANY PARTICULAR PURPOSE.

### 7. LIMITATION OF LIABILITY.

IN NO EVENT SHALL FUJIFILM HAVE ANY LIABILITY FOR ANY GENERAL, SPECIAL, DIRECT, INDIRECT, CONSEQUENTIAL, INCIDENTAL, OR OTHER DAMAGES (INCLUDING DAMAGES FOR LOSS OF PROFITS OR LOST SAVINGS) INCURRED FROM THE USE OF OR INABILITY TO USE PRODUCT EVEN IF FUJIFILM HAS BEEN ADVISED OF THE POSSIBILITY OF SUCH DAMAGES.

### 8. No export.

You acknowledge that neither Software nor any part thereof, will be transferred, or exported to any country or used in any manner in violation of any export control laws and regulations to which Software is subject.

### 9. Termination.

In case you breach any of the terms and conditions hereof, FUJIFILM may immediately terminate this Agreement without any notice.

### 10. Term.

This Agreement is effective until the date when you cease to use Software, unless earlier terminated in accordance with Section 9 hereof.

### 11. Obligation upon termination.

Upon termination or expiration of this Agreement, you shall, at your own responsibility and expense, delete or destroy immediately all Software (including its copies), Media and Documentation.

### 12. Governing Law.

This Agreement shall be governed by and construed in accordance with laws of Japan.

# EC Declaration of Conformity

We

Name: FUJIFILM Europe GmbH  
Address: Heesenstrasse 31  
40549 Dusseldorf, Germany

declare that the product

Product Name: FUJIFILM DIGITAL CAMERA FinePix A610/FinePix A800  
Manufacturer's Name: FUJIFILM Corporation  
Manufacturer's Address: MIDTOWN WEST, 7-3, AKASAKA 9-CHOME, MINATO-KU,  
TOKYO 107-0052, JAPAN

conforms to the following Standards:

Safety: EN60065  
EMC: EN55022: 1998 Classe B  
EN55024: 1998  
EN61000-3-2: 1995 + A1: 1998 + A2: 1998

following the provision of the EMC Directive (89/336/EEC, 92/31/EEC and  
93/68/EEC) and Low Voltage Directive (73/23/EEC).



Dusseldorf, Germany

February 1, 2007

Place

Date

Signature/Managing Director



This product comes with batteries. When these are empty, you shouldn't throw them away but deliver them as domestic chemical refuse.

# Disposal of Electric and Electronic Equipment in Private Households

## Disposal of used Electrical & Electronic Equipment (Applicable in the European Union and other European countries with separate collection systems)



This symbol on the product, or in the manual and in the warranty, and/or on its packaging indicates that this product shall not be treated as household waste.

Instead it should be taken to an applicable collection point for the recycling of electrical and electronic equipment.

By ensuring this product is disposed of correctly, you will help prevent potential negative consequences to the environment and human health, which could otherwise be caused by inappropriate waste handling of this product.

If your equipment contains easy removable batteries or accumulators please dispose these separately according to your local requirements.

The recycling of materials will help to conserve natural resources. For more detailed information about recycling of this product, please contact your local city office, your household waste disposal service or the shop where you have purchased the product.

### **In Countries outside the EU:**

If you wish to discard this product, please contact your local authorities and ask for the correct way of disposal.



# Contents

Warning.....	2
IMPORTANT .....	3
EC Declaration of Conformity.....	4
Disposal of Electric and Electronic Equipment in Private Households.....	5
Contents.....	6
Preface.....	8
About this Manual .....	10
Accessories Included .....	12
Camera Parts and Features (FinePix A610).....	13
Camera Parts and Features (FinePix A800).....	14
Example of LCD Monitor Text Display .....	15









## Getting Ready

Loading the Batteries .....	16
Loading the Memory Card.....	19
Turning On and Off .....	22
Setting the language, date, and time .....	23
Correcting the Date and Time.....	25
Selecting the Language .....	26



## Using the Camera

Taking Pictures (AUTO Mode).....	27
Taking pictures with the focus and exposure locked.....	31
Adjusting the shot composition .....	33
Viewing the Images.....	34
 Erasing the Images/Movies .....	38
Using the erase button (  /  ).....	38
Erasing the images using Playback menu.....	38

## Advanced Features — Photography

Using the Photography Functions — Procedure of Setting.....	41
Setting the Shooting Mode (FinePix A610) .....	43
Setting the Shooting Mode (FinePix A800) .....	44
Shooting Mode .....	46
 Macro (Close-up).....	51
 Setting the Flash (Intelligent Flash).....	52
 Self-Timer .....	54
 Increasing Monitor Brightness .....	56
Using SHOOTING MENU .....	57
Setting the SHOOTING MENU .....	57
SHOOTING MENU.....	60
Changing the sensitivity setting (  ) ISO) .....	60
Changing the quality setting (  ) QUALITY).....	61
Adjusting exposure compensation (  ) EXP. COMPENSATION).....	63
Adjusting color balance (  ) WHITE BALANCE).....	64

## Advanced Features — Playback

Using PLAYBACK MENU.....	66
Setting the PLAYBACK MENU .....	66
PLAYBACK MENU .....	67
Setting automatic playback (  ) SLIDE SHOW).....	67
DPOF set frame (  ) PRINT ORDER (DPOF)) .....	67

Protecting the images (🔒 PROTECT).....	71
Copying the images (📄 COPY).....	72
Rotating the images (🔄 IMAGE ROTATE).....	75
Trimming the images (✂️ TRIMMING) (FinePix A800 only) .....	76

## Advanced Features — Movie

📹 Recording Movies .....	78
Set the camera to 📹 Movie mode (FinePix A610) .....	78
Set the camera to 📹 Movie mode (FinePix A800) .....	78
Record movies .....	79
▶️ Playing Back Movies .....	81

## Settings

⚙️ SET-UP .....	83
Using the SET-UP menu.....	83
SET-UP menu option.....	84

## Camera Connection

Connecting to a TV (FinePix A610).....	93
Connecting to a TV (FinePix A800).....	94
Connecting Camera Directly to Printer — PictBridge Function.....	95

## Software Installation

Installation on a Windows PC .....	100
Installation on a Mac OS X .....	103
Connecting to a PC .....	106
Using FinePixViewer.....	110

## Appendices

System Expansion Option .....	113
Accessories Guide .....	114
Using Your Camera Correctly .....	116
Power Supply and Batteries .....	117
Discharging rechargeable batteries .....	119
Notes on the <b>xD-Picture Card™</b> , the SD Memory Card and the Internal Memory .....	122
Warning Displays .....	124

## Troubleshooting

Troubleshooting.....	129
----------------------	-----

Specifications (FinePix A610) .....	135
Specifications (FinePix A800) .....	140
Explanation of Terms .....	148
FUJIFILM Digital Camera Worldwide Network.....	149
Safety Notes.....	158

## Usable Memory Cards

You can use the **xD-Picture Card** and the SD Memory Card with the FinePix A610 and FinePix A800. In this Owner's Manual, these cards are expressed as "Memory Card".

# Preface

## ■ Test Shots Prior to Photography

For important photographs (such as weddings and overseas trips), always take a test shot and view the image to make sure that the camera is working normally.

- FUJIFILM Corporation cannot accept liability for any incidental losses (such as the costs of photography or the loss of income from photography) incurred as a result of faults with this product.

## ■ Notes on Copyright

Images recorded using your digital camera system cannot be used in ways that infringe copyright laws without the consent of the owner, unless intended only for personal use. Note that some restrictions apply to the photographing of stage performances, entertainments and exhibits, even when intended purely for personal use. Users are also asked to note that the transfer of Memory Card containing images or data protected under copyright laws is only permissible within the restrictions imposed by those copyright laws.

## ■ Handling Your Digital Camera

This camera contains precision electronic components. To ensure that images are recorded correctly, do not subject the camera to impact or shock while an image is being recorded.

## ■ Liquid Crystal

If the LCD monitor is damaged, take particular care with the liquid crystal in the monitor. If any of the following situations arise, take the urgent action indicated.

- If liquid crystal comes in contact with your skin  
Wipe the area with a cloth and then wash thoroughly with soap and running water.
- If liquid crystal gets into your eye  
Flush the affected eye with clean water for at least 15 minutes and then seek medical assistance.
- If liquid crystal is swallowed  
Flush your mouth thoroughly with water. Drink large quantities of water and induce vomiting. Then seek medical assistance.

## ■ Trademark Information

-  and **xD-Picture Card™** are trademarks of FUJIFILM Corporation.
- IBM PC/AT is a registered trademark of International Business Machines Corp. of the U.S.A.
- Macintosh, Power Macintosh, iMac, PowerBook, iBook and Mac OS are trademarks of Apple Computer, Inc., registered in the U.S. and other countries.
- Microsoft, Windows, the Windows logo, Windows Vista and the Windows Vista logo are trademarks or registered trademarks of Microsoft Corporation in the United States and/or other countries.  
Windows is an abbreviated term referring to the Microsoft® Windows® Operating System.
- \* The "Designed for Microsoft® Windows® XP" logo refers to the camera and the driver only.
- SD logo is a trademark.
- Other company or product names are trademarks or registered trademarks of the respective companies.



---

### ■ Notes on Electrical Interference

If the camera is to be used in hospitals or aircrafts, please note that this camera may cause interference to other equipment in the hospital or aircraft. For details, please check with the applicable regulations.

### ■ Explanation of Color Television System

NTSC: National Television System Committee, color television telecasting specifications adopted mainly in the U.S.A., Canada and Japan.

PAL: Phase Alternation by Line, a color television system adopted mainly by European countries and China.

### ■ Exif Print (Exif ver. 2.2)

Exif Print Format is a newly revised digital camera file format that contains a variety of shooting information for optimal printing.

\* See "Using Your Camera Correctly" (→p.116) for more information.



## ■ About each model's functions

This Owner's Manual shows the description of 2 models: FinePix A610 and FinePix A800. Some functions are available only on one model. The main differences between the 2 models are shown in the table below.

Check the table to confirm which functions your camera has.

	FinePix A610	FinePix A800
Mode dial (→p.14)	Not available	Available
Shooting Mode (//, , , ) (→p.46, 48)	Not available	Available
Number of recorded pixels (→p.61)	<b>6M F / 6M N / 3:2 / 3M / 2M / 0.8M</b>	<b>8M F / 8M N / 3:2 / 4M / 2M / 0.8M</b>
Trimming (→p.76)	Not available	Available
Sound during movie shooting (→p.80)	Not available	Available

The description of functions available only on certain models has a title as below.

Indicating the model has this function.

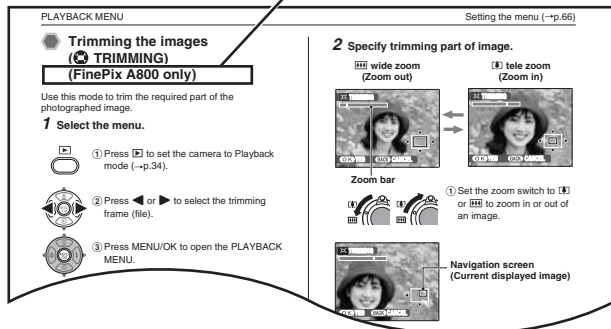

# Accessories Included

Make sure that all the below accessories are included.  
Note that accessories may vary depending on model.

- **AA-size Alkaline Batteries (LR6) (2)**

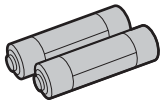

- **Strap (1)**

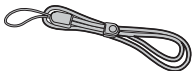

- **Video cable (1) (FinePix A610 only)**



- **A/V cable (1) (FinePix A800 only)**

Including plug to pin-plug x2



- **USB cable (mini-B) (1)**

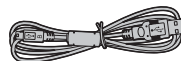

- **CD-ROM (1)**

Software for FinePix KA



- **Owner's Manual (this manual) (1)**



## Attaching the strap

Attach the strap as shown in 1 and 2.

When attaching the strap, move the fastener to adjust the length and slightly away from the end of the strap, as shown in figure 1.

1

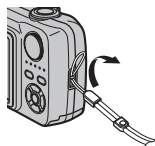

2

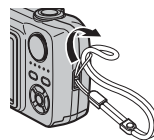

# Camera Parts and Features (FinePix A610)

- Refer to the pages in parentheses for information on using the camera parts or features.

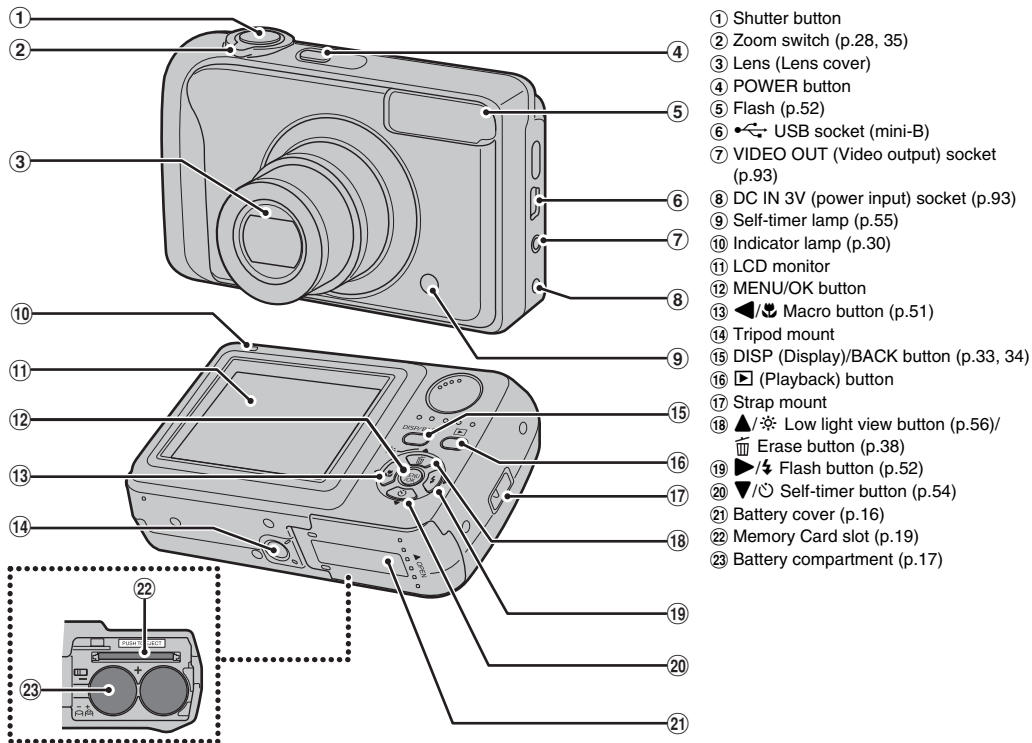

# Camera Parts and Features (FinePix A800)

- Refer to the pages in parentheses for information on using the camera parts or features.

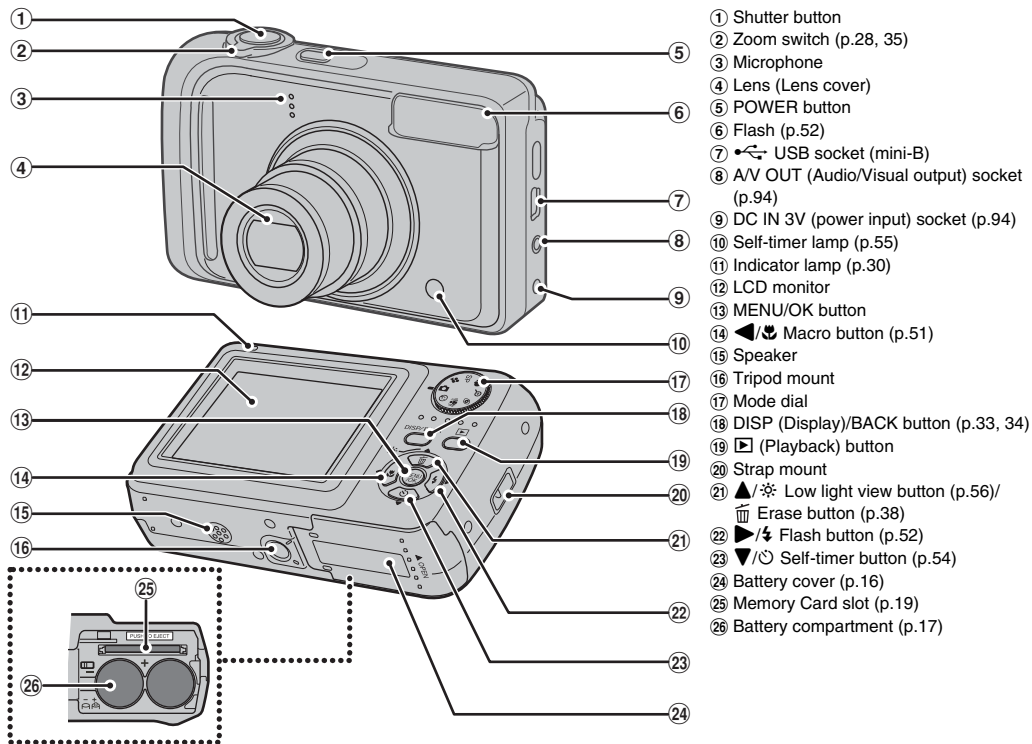

# Example of LCD Monitor Text Display

\*FinePix A800

## Photography mode

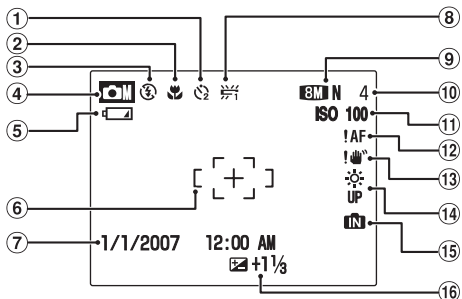

- ① Self-timer (p.54)
- ② Macro (close-up) (p.51)
- ③ Flash (p.52)
- ④ Photography mode (p.43, 44)
- ⑤ Battery level indicator (p.18)
- ⑥ AF frame (p.29)
- ⑦ Date/Time (p.23)
- ⑧ White balance (p.64)
- ⑨ **EMN** Quality mode (p.61)
- ⑩ Number of available frames (p.139, 144)

- ⑪ ISO 100 Sensitivity (p.60)
- ⑫ **!AF** AF warning (p.124)
- ⑬ **!** Camera shake warning (p.124)
- ⑭ Increasing monitor brightness (p.56)
- ⑮ **IM** Internal memory (p.21)
- ⑯ Exposure compensation (p.63)

## Playback mode

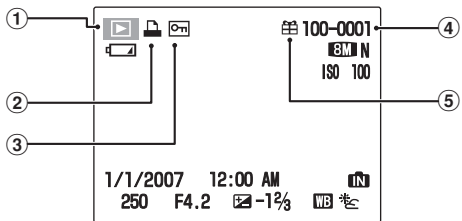

- ① Playback mode (p.34)
- ② DPOF (p.67)
- ③ Protection (p.71)
- ④ Frame number (p.86)
- ⑤ Present (p.34)

FinePix A610/FinePix A800 has internal memory that can store images without Memory Card. **IM** appears on the LCD monitor when the internal memory is active.

# Loading the Batteries

Batteries are required to operate the digital camera. At first, load the batteries in the camera.

## Compatible batteries

AA-size alkaline batteries (2) or AA-size Ni-MH rechargeable batteries (2) (sold separately)

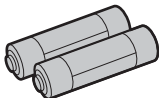

## CAUTION

- Never use the following types of batteries, as they could cause serious problems such as battery fluid leakage or overheating:
  1. Batteries with split or peeling outer casings
  2. Combinations of different types of batteries or new and used batteries together
- Do not use manganese, Ni-Cd or lithium batteries.
- Use the same brand and grade AA-size alkaline batteries as those supplied with the camera.

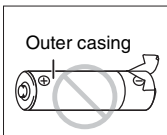

## 1 Open the battery cover.

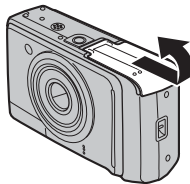

## CHECK

Check that the camera is turned off before opening the battery cover.

## CAUTION

- Do not open the battery cover while the camera is on. This could damage the Memory Card or ruin the image files on the Memory Card.
- Do not apply force to the battery cover.



- 2 Load the batteries correctly as indicated by the polarity icons.

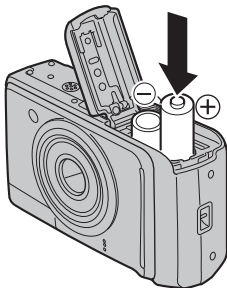

! **CAUTION**

Match the polarity icons (+ and -) of the batteries to those on the inside of the battery cover.

- 3 Close the battery cover.

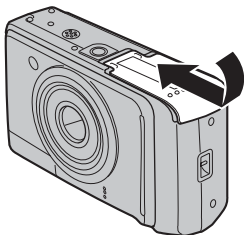

## Checking the battery charge

Turn the camera on and check the battery level indicator on the LCD monitor.

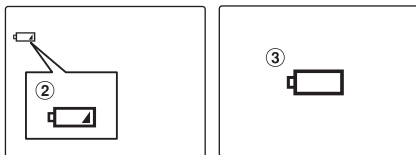

- ① There is ample battery charge. (Not displayed)
- ② There is insufficient charge left in the batteries. The batteries will soon run out. Have a new set of batteries ready. (Lit red)
- ③ The batteries are depleted. The display will shortly go blank and the camera will stop working. Replace or recharge the batteries. (Blinking red)

### ! CAUTION

- Soil, such as fingerprints on the poles of the batteries, can shorten time for which the batteries can be used.
- The time for which AA-size alkaline batteries (referred to hereafter simply as alkaline batteries) can be used varies depending on the brand. Some brands of alkaline batteries may stop providing power more quickly than those supplied with the camera. Note also that due to their nature, the time for which alkaline batteries can be used decreases in cold conditions (0°C to +10°C/+32°F to +50°F). For this reason, it is better to use AA-size Ni-MH batteries.
- Due to the nature of the battery, the battery level indicator (☐, or ☐) may appear early when the camera is used in cold locations. Try warming the battery in your pocket or a similar location before use.
- Depending on the battery type and the level of charge in the batteries, the camera may run out of power without first displaying a battery level warning. This is particularly likely to happen when batteries that have run out of charge once are re-used.
- Depending on the camera mode, the transition from ☐ to ☐ may occur more quickly.
- See p.117-118 for information on the batteries.
- When first purchased or if left unused for a long period, the amount of time which AA-size Ni-MH batteries can be used may be short. See p.118 for more information.
- Battery power consumption varies greatly depending on use. When you change to Playback mode from Photography mode, ☐ may not occur, however, ☐ may suddenly blink red and the camera may stop operation.

# Loading the Memory Card

Although you can store pictures in the camera's internal memory, you can store many more images on the Memory Card (sold separately). You can use the **xD-Picture Card** and the SD Memory Card with the FinePix A610 and FinePix A800. In this Owner's Manual, these cards are expressed as "Memory Card".

## SD Memory Cards

Use of the SD Memory Cards listed below is recommended. They are operation-checked at FUJIFILM Corporation.

Maker: SanDisk

Model: Extreme III -1GB/Ultra II -512MB, 1GB, 2GB

## MEMO

- Compatible Memory Cards will be updated in our website:  
<http://www.fujifilm.com/products/digital/>
- Depending on the SD Memory Card, recording of movies may be interrupted.  
Use of above mentioned SD Memory Cards are recommended.
- The camera is not compatible with multimedia cards.

## 1 Open the battery cover.

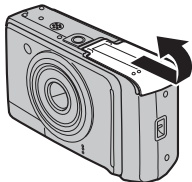

## 2 Insert a Memory Card.

(xD-Picture Card)

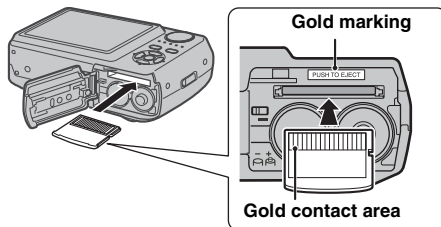

Align the gold marking with the gold contact area, then insert an **xD-Picture Card** completely.

(SD Memory Card)

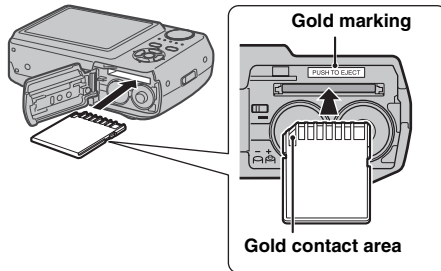

Align the gold marking with the gold contact area, then insert an SD Memory Card completely.

**Continued** ➔

**!** CAUTION

Be sure to unlock the protection of the SD Memory Card before inserting it. If it is locked, recording/deleting images, as well as formatting are not available. To unlock the protection, slide the switch back, and the SD Memory Card will work normally.

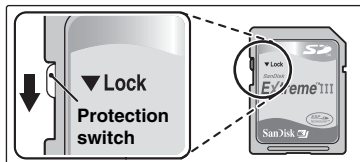

**!** CAUTION

- A new SD Memory Card or a card previously used on a PC or any device other than the camera should be formatted (→p.89) on the camera before use.
- Do not use a miniSD adaptor or a microSD adaptor which have exposed contact areas on the back. Use of these adaptors may cause a malfunction or damage due to the improper contacts.

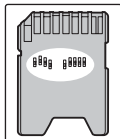

**3** Close the battery cover.

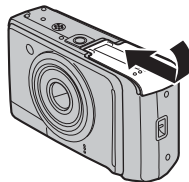

*How to replace the Memory Card*

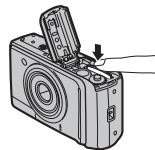

Push the Memory Card into the slot and then slowly remove your finger. The lock is released and the Memory Card is pushed out.

**! CAUTION**

- When storing Memory Cards, make sure that they are kept out of the reach of children. A Memory Card could be swallowed and cause suffocation. If a child swallows a Memory Card, seek medical attention or call emergency number right away.
- If the Memory Card is oriented incorrectly, it will not go all the way into the slot. Do not apply force when inserting a Memory Card.
- Note that the Memory Card may spring out if you release your finger quickly from the card immediately after the lock is released.
- Operation of this camera is only guaranteed when it is used with FUJIFILM **xD-Picture Card** and operation-checked SD Memory Card (→p.19).
- See p.122 for information on the **xD-Picture Card**, SD Memory Card and the internal memory.

**📄 MEMO**

- The size of an image file varies depending on the subject. For this reason, the number recorded may not represent the actual number of frames.
- See p.139, 144 for information on the standard number of available frames.

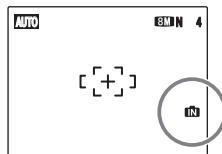
**■ About internal memory**

FinePix A610/FinePix A800 has internal memory that can store images without Memory Card. **IN** appears on the LCD monitor when internal memory is active.

**When a Memory Card (sold separately) is inserted**

[Record images]: Record images to a Memory Card.

[Playback images]: Playback images in a Memory Card.

**When a Memory Card (sold separately) is not inserted**

[Record images]: Record images to internal memory.

[Playback images]: Playback images in internal memory.

**■ About images in the internal memory**

Images held in the camera's internal memory may be corrupted or erased due to problems such as camera faults. Save your important data to another media (i.e., DVD-R, CD-R, CD-RW, hard disk, etc.). It is possible to transfer saved images on the internal memory to a Memory Card (→p.72).

# Turning On and Off

## Turning the camera on in Photography mode

Press **POWER** down fully to turn the camera on. Press **POWER** again to turn the camera off.

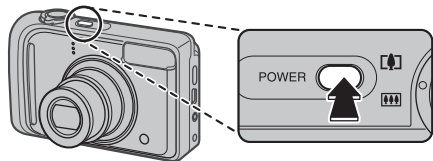

### **MEMO** **Changes between Photography mode and Playback mode**

Press **DISP/BACK** during shooting to change to Playback mode. Press the shutter button down halfway to return to Photography mode.

### **CAUTION**

- The lens moves and the lens cover opens when turning the camera on in Photography mode. Take care not to obstruct the lens.
- Take care not to get fingerprints on the camera lens as this will result in impaired image quality in your shots.

## Turning the camera on in Playback mode

Press **DISP/BACK** for about 1 second to turn the camera on in Playback mode.

Press **DISP/BACK** during playback to turn the camera off.

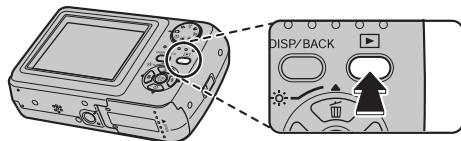

### **MEMO**

To change to Photography mode, press the shutter button down halfway.

## Setting the language, date, and time

When using the camera for the first time after purchasing, the language, date, and time are cleared. Set the language, date, and time.

### 1 言語/LANG. screen appears when turning the camera on.



① Press ▲, ▼, ◀, or ▶ to select the language.



② Press MENU/OK to confirm the setting.

### 2 Set the date and time.

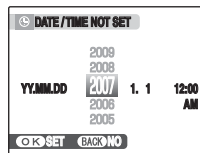

① Press ◀ or ▶ to select Year, Month, Day, Hour, or Minute.



② Press ▲ or ▼ to correct the setting.



#### MEMO

- Holding down ▲ or ▼ changes the numbers continuously.
- When the time displayed passes "12", the AM/PM setting changes.

**Continued** ➔

### 3 Change the date format.



① Press ◀ or ▶ to select the date format.



② Press ▲ or ▼ to set the format.



③ Always press MENU/OK after the settings are completed.

#### **Date format**

ex. February 24, 2007  
 YY.MM.DD: 2007.2.24  
 MM/DD/YY: 2/24/2007  
 DD.MM.YY: 24.2.2007

#### MEMO

START MENU screen also appears when the batteries have been removed and the camera has been left for a long period. Once the AC power adapter has been connected or the batteries have been installed for 2 hours or more, the camera settings will be retained for roughly 6 hours even if both sources of power are removed.

#### **Auto power off function**

When the Auto power off function is active, if the camera is left unused for 2 or 5 minutes, this function turns the camera off (→p.90). To turn the camera back on, press POWER. To play back images, hold down  for about 1 second.



# Correcting the Date and Time

## 1 Open the SET-UP menu.

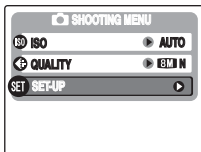

\* FinePix A800



① Press MENU/OK to open the menu.



② Press ▲ or ▼ to select SET SET-UP.



③ Press ►.

## 2 Display the DATE/TIME screen.



\* FinePix A800



① Press ◀ or ▶ to select 1.



② Press ▼ to move to menu item.



③ Press ▲ or ▼ to select DATE/TIME.



④ Press ►.  
See "2 Set the date and time." (→p.23).

# Selecting the Language

## 1 Open the SET-UP menu.

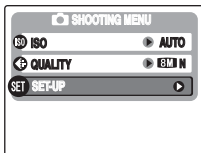

① Press MENU/OK to open the menu.



② Press ▲ or ▼ to select SET SET-UP.



③ Press ►.

## 2 Display the 言語/LANG. screen.

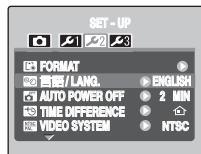

\* FinePix A800



① Press ◀ or ▶ to select 2 (Select 1 on the FinePix A610).



② Press ▼ to move to menu item.



③ Press ▲ or ▼ to select 言語/LANG..



④ Press ►.

See “1 言語/LANG. screen appears when turning the camera on.” (→p.23).

# Taking Pictures (AUTO Mode)

This section describes the basic operations.

## 1 Turn the camera on.

- ① Press POWER down fully to turn the camera on.

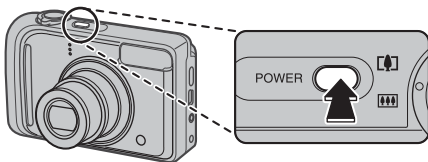

- ② Set the Mode dial to  (FinePix A800 only).

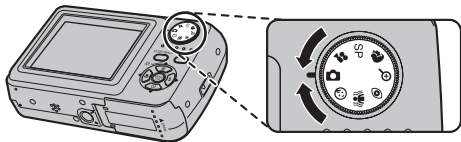

### ! CAUTION

Step ② is only for FinePix A800. Since there is no mode dial on FinePix A610, ignore step ② when using that model.

## Holding the camera correctly

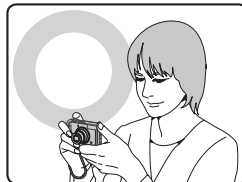

Brace your elbows against your sides and hold the camera with both hands.

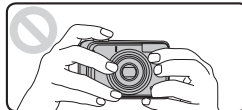

Do not cover the lens or flash with your fingers.

### ! CAUTION

- Moving the camera while shooting gives a blurred picture (camera shake). Hold the camera steadily with both hands.
- If the lens or flash is obscured by your fingers or the strap, subjects may be out of focus or the brightness (exposure) of your shot may be incorrect.
- Check that the lens is clean. If it is dirty (getting fingerprints on the lens etc.), clean the lens as informed on p.116.

**Continued** ➔

## 2 Check the composition on the LCD monitor. To adjust zoom scale using the Zoom switch:

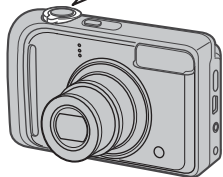
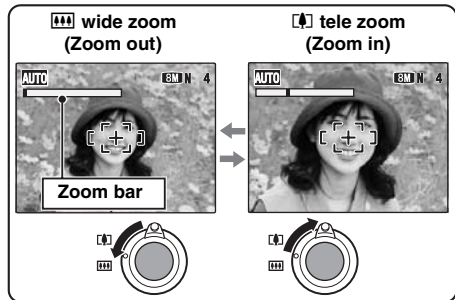

### (FinePix A610)

- **Focal range**  
Approx. 60 cm (2.0 ft.) to infinity
- **Optical zoom focal length (35 mm camera equivalent)**  
Approx. 39 mm to 117 mm
- **Max. zoom scale**  
3x

### (FinePix A800)

- **Focal range**  
Approx. 50 cm (1.6 ft.) to infinity
- **Optical zoom focal length (35 mm camera equivalent)**  
Approx. 36 mm to 108 mm
- **Max. zoom scale**  
3x

### MEMO

- Select  Macro mode to take close-up shots (→p.51).
- Use digital zoom when you want to shoot the subject closer (→p.46, 87).

### 3 Focus on the main subject in the AF frame and press the shutter button halfway.

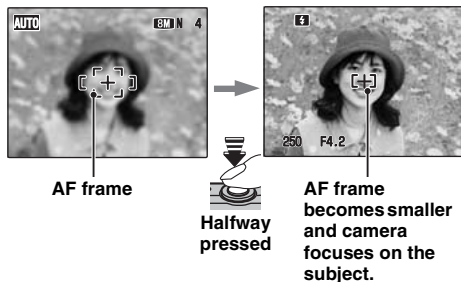

#### ✓ CHECK

- **Focus on the subject**  
Double beep is heard  
Indicator lamp lit green
- **Not focus on the subject**  
No sound  
**!**AF indicated  
Indicator lamp blinking green

#### 📄 MEMO

The shutter button has a halfway point at which focus and exposure are automatically optimized before taking the picture by pressing fully down.

#### ⚠ CAUTION

When pressing the shutter button halfway, a lens operation sound may be heard.

### 4 Press the shutter button fully.

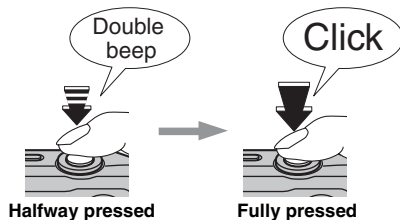

#### ⚠ CAUTION

When taking a picture using the flash, the image may disappear and go dark briefly due to flash charging. The indicator lamp blinks orange during charging.

#### ✓ CHECK

When using FinePix A610, the camera makes a beep sound and takes the picture when you press the shutter button down fully.

#### 📄 MEMO

- When the subject is not in the AF frame, use AF/AE lock to take the picture (→p.31).
- When pressing the shutter button down fully in one motion, the camera takes the picture without the AF frame changing.

**Continued** ➔

### Flash



When pressing the shutter button down halfway,  appears on the LCD monitor before the flash fires.

Change the flash mode when you want to take pictures without flash. See p.52 for information on flash.

### ! CAUTION

- The image shown on the LCD monitor before the picture is taken may differ in brightness, color, etc. from the image actually recorded. Play back the recorded image to check it (→p.34).
- When selecting a slow shutter speed that will cause camera shake,  appears on the LCD monitor. Use flash or a tripod.
- See p.124-127 for information on Warning displays. See "Troubleshooting" (→p.129-134) for more information.

### Indicator lamp display

The indicator lamp lights or blinks when pressing the shutter button, etc. The indicator lamp shows the camera status.

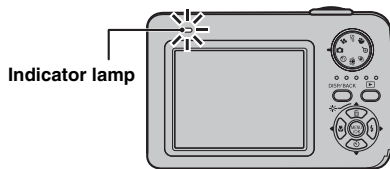

Display	Status
Lit green	Locking the focus
Blinking green	Camera shake warning, AF warning, or AE warning (ready to shoot)
Blinking green and orange alternately	Recording to Memory Card or internal memory (ready to shoot)
Lit orange	Recording to Memory Card or internal memory (not ready)
Blinking orange	Charging flash (flash will not fire)
Blinking red	<ul style="list-style-type: none"> <li>• Warnings for Memory Card and internal memory</li> <li>• Card not formatted, incorrect format, memory full, Memory Card or internal memory error</li> <li>• Lens operation error</li> </ul>

### MEMO

Detailed warning messages appear on the LCD monitor (→p.124-127).

## Taking pictures with the focus and exposure locked

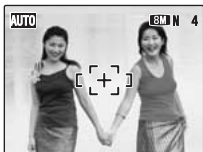

In the above composition, the subjects (two people in this case) are not in the AF frame. Pressing the shutter button halfway at this point will result in the subjects being out of focus.

### AF/AE lock is useful:

Use AF/AE lock to guarantee best result when shooting a subject that is not suited to autofocusing (→p.32).

## Using AF/AE lock

- 1 Move the camera slightly so that one of the subjects is in the AF frame.

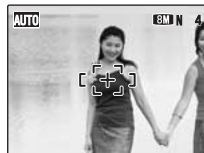

- 2 Press the shutter button down halfway to focus on the subject.

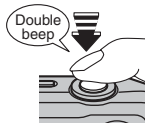

*Continued* ➔

- 3 Continue to hold the shutter button down halfway. Move the camera back to the original image and press the shutter button fully.**



Fully pressed

**CHECK**

When using FinePix A610, the camera makes a beep sound and takes the picture when you press the shutter button down fully.

**MEMO**

- AF/AE lock can be applied repeatedly before the shutter is released.
- Use AF/AE lock in all Photography modes to guarantee excellent results.
- On FinePix A610/FinePix A800, pressing the shutter button down halfway locks the focus and exposure settings (AF and AE lock).

**Subjects not suitable for autofocus**

FinePix A610/FinePix A800 uses a high-precision autofocus mechanism. However, it may have difficulty focusing on the following:



Very shiny subjects such as a mirror or car body

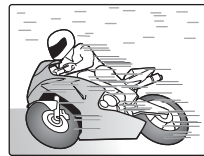

Fast moving subjects

- Subjects photographed through glass
- Subjects that do not reflect well, such as hair or fur
- Subjects with no substance, such as smoke or flames
- Dark subjects
- Subjects with little or no contrast between the subject and the background (such as subjects dressed in the same color as the background)
- Shots where another high-contrast object (not the subject) is close to the AF frame and is either closer or further away than your subject (such as a shot of someone against a background with strongly contrasting elements)

For such subjects use AF/AE lock (→p.31).



## Adjusting the shot composition

### Select the LCD monitor display.

Press DISP/BACK to change the LCD monitor display.

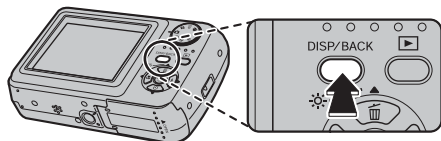

Text displayed

No text displayed



Framing guideline  
displayed

## Best framing

Position the main subject at the intersection of two lines in this frame or align one of the horizontal lines with the horizon. Use this frame as a guide to the subject's size and the balance of the shot while composing a shot.



### MEMO

Always use AF/AE lock when composing a shot. The image may be out of focus if AF/AE lock is not used.

# Viewing the Images

Play back your images to check them. For important photographs, always take a test shot and view the image to make sure that the camera is working normally.

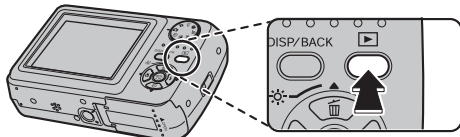

## Setting the camera to Playback mode

Press  during shooting to change to Playback mode.



When the camera is off, press  for about 1 second to turn the camera on in Playback mode.

### MEMO

- When pressing , the last image shot appears on the LCD monitor.
- When playing back images shot with a camera other than FinePix A610/FinePix A800,  a present icon appears on the LCD monitor.

### CAUTION Still images viewable on FinePix A610/FinePix A800

This camera will display still images recorded on FinePix A610/FinePix A800 or still images (excluding some uncompressed images) recorded on any FUJIFILM digital camera that supports **xD-Picture Cards** or SD Memory Cards. Clear playback or playback zooming may not be possible for still images shot on cameras other than FinePix A610/FinePix A800.

## Select the LCD monitor display.

Press DISP/BACK during Playback mode to change the LCD monitor display.

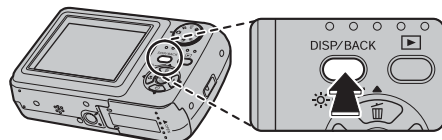

Text displayed

No text displayed



Sorting by date

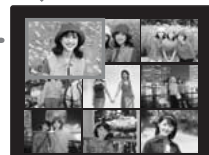

Multi-frame playback

## Single-frame playback



To select the required image:

Press ◀: last image

Press ▶: next image

## Selecting images



To select images on the thumbnail lists screen, hold down ◀ or ▶ for 1 second during playback. When releasing ◀ or ▶, camera returns to single-frame playback.

## Playback zoom

### 1 Zoom in / Zoom out.

To zoom in an image during single-frame playback:

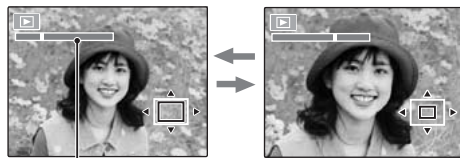

wide zoom  
(Zoom out)

tele zoom  
(Zoom in)



Zoom bar



Move the zoom switch to  or  to zoom in or out of an image.

### 2 Display another part of the image.



Navigation screen  
(Current displayed image)



Press ▲, ▼, ◀, or ▶ to display another part of the image.

### Zoom scales (FinePix A610)

Quality mode	Max. zoom scale
<b>6M</b> (2848 × 2136 pixels)	Approx. 4.5x
<b>3:2</b> (3024 × 2016 pixels)	Approx. 4.7x
<b>3M</b> (2048 × 1536 pixels)	Approx. 3.2x
<b>2M</b> (1600 × 1200 pixels)	Approx. 2.5x

### Zoom scales (FinePix A800)

Quality mode	Max. zoom scale
<b>6M</b> (3296 × 2472 pixels)	Approx. 5.2x
<b>3:2</b> (3504 × 2336 pixels)	Approx. 5.5x
<b>4M</b> (2304 × 1728 pixels)	Approx. 3.6x
<b>2M</b> (1600 × 1200 pixels)	Approx. 2.5x

#### MEMO

Pressing DISP/BACK cancels playback zoom.

### Multi-frame playback

Multi-frame playback screen (9 frames) appears on the LCD monitor. Select required frame from the 9 frames.

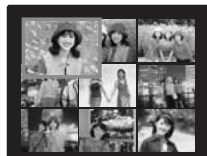

- Press ▲, ▼, ◀, or ▶ to move the cursor (colored frame) to the selecting frame. Press ▲ or ▼ repeatedly to jump to the next page.



- Press MENU/OK to enlarge the image.

## Sorting by date

In sorting by date mode, you can view all images taken on the same day.



- 1 Press ▲, ▼, ◀, or ▶ to move the cursor (colored frame) to the selecting frame.



- 2 Press MENU/OK to enlarge the image.

## Selecting the date



- 1 Press ▲, ▼, ◀, or ▶ to move the cursor (colored frame) to ◀ on the upper left frame.



- 2 Press ◀ to display the selecting date.



- 3 Press ▲ or ▼ to move the cursor (colored frame) to select the date. Press ▲ or ▼ repeatedly to jump to the next page.



- 4 Press ▶.



## Erasing the Images/Movies

Setting the camera to Playback mode (→p.34)

Use this mode to erase unnecessary images or movies to have ample free space on the Memory Card or internal memory. Your camera calls images "frames".

### Using the erase button (/▲)

Pressing (▲) erases images easily.

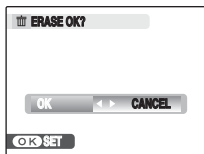

- ① Press ◀ or ▶ to select the erasing image.
- ② Press (▲).
- ③ Press ◀ or ▶ to select OK.
- ④ Press MENU/OK to erase the displayed image.



### Erasing the images using Playback menu

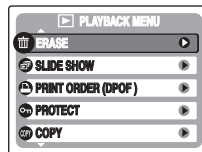

- ① Press MENU/OK to open the PLAYBACK MENU.



- ② Press ▲ or ▼ to select ERASE.



- ③ Press ▶.

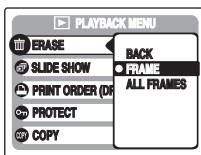

- ④ Press ▲ or ▼ to select FRAME or ALL FRAMES.



- ⑤ Press MENU/OK to confirm the setting.

## Erasing one frame at a time (FRAME)

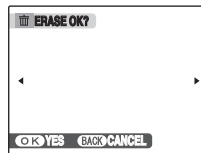

- ① Press ◀ or ▶ to select the erasing frame (file).



- ② Press MENU/OK to erase the currently displayed frame (file).



### MEMO

To erase another frame (file), repeat above steps.  
When erasing frames (files) is completed, press DISP/BACK.



### CAUTION

Pressing MENU/OK repeatedly erases consecutive frames (files). Take care not to erase a frame (file) by mistake.

**Continued** ➔

## Erasing all frames (ALL FRAMES)

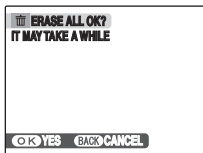

Press MENU/OK to erase all the frames (files).

### MEMO

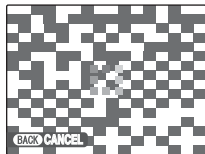

Press DISP/BACK to cancel erasing of all the frames (files). Some unprotected frames (files) will be left unerased.

### MEMO

- When using a Memory Card, the images in the Memory Card are erased. When not using a Memory Card, the images in the internal memory are erased.
- Selecting BACK returns to single-frame playback without erasing any frames (files).
- Protected frames (files) cannot be erased. Unprotect the frames (files) before erasing them (→p.71).
- If “DPOF SPECIFIED. ERASE OK?” or “DPOF SPECIFIED. ERASE ALL OK?” appears, press MENU/OK again to erase the frames (files).

### CAUTION

Erased frames (files) cannot be recovered. Back up important frames (files) onto your PC or another media.



# Using the Photography Functions — Procedure of Setting

Specify the camera settings for taking pictures to get the best result. A general guide is given below.

## 1 Select the Photography mode.

Set the Photography mode.

The camera settings are tailored to the scene being shot.

Note that the availability of a shooting mode and its setting method may vary depending on the mode you wish to use.

<FinePix A610>



Set the photography mode in the shooting menu. See p.43 for information on setting shooting mode.

	This mode provides detailed settings that are impossible to set in AUTO mode (→p.50).
AUTO	This is the easiest mode for taking pictures (→p.46).

## 2 Specify the photography settings.





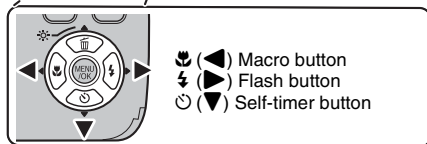
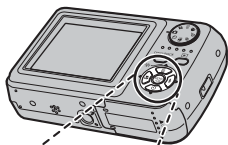

Pressing buttons or selecting menu allows you to specify photography functions. You can obtain the best result for shooting.

### ■ Specifying functions using buttons

 Macro	Used for close-up shots (→p.51).
 Flash	Used for shots in dark locations or for backlit subjects, etc. (→p.52).
 Self-timer	Used in situations such as group shots where the photographer is included in the shot (→p.54).



### ■ Specifying functions using SHOOTING MENU (MENU/OK button)

 ISO	Use to specify required sensitivity setting (→p.60).
 QUALITY	Use to specify required image size (→p.61).
 EXP. COMPENSATION	Use this setting to obtain the correct exposure (only  ) (→p.63).
 WHITE BALANCE	Use to adjust the color tone (only  ) (→p.64).

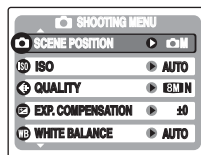
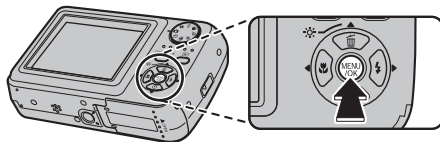

\* FinePix A800

# Setting the Shooting Mode (FinePix A610)

You can select the most suitable setting according to the subject by selecting one of the Shooting modes.

See p.41 for information on available shooting mode.

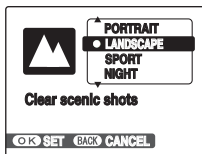

① Press MENU/OK to open the menu.



② Press ▲ or ▼ to select the  SHOOTING MODE.



③ Press ►.





④ Press ▲ or ▼ to select the setting.



⑤ Press MENU/OK to confirm the setting.

## CHECK

- See p.53 for information on the available flash modes.
- When anything other than  in the  SHOOTING MODE is selected, only AUTO can be selected for the  ISO (sensitivity) setting.



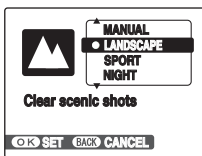

② Press MENU/OK to open the menu.



③ Press ▲ or ▼ to select **SCENE POSITION**.



④ Press ►.



⑤ Press ▲ or ▼ to select the setting.



⑥ Press MENU/OK to confirm the setting.

This section describes the available shooting modes. Note that the availability of a shooting mode and its setting method may vary depending on the mode you wish to use. (→p.43, 44)

## AUTO

This is the easiest mode for providing crisp and clear shots.

Use this mode for ordinary photography. Camera specifies EXP. COMPENSATION and WHITE BALANCE settings automatically.

## BABY MODE

This function is suitable for taking pictures of young children. This mode suppresses the flash so that you can take their picture with a natural ambience.

## CHECK

Flash cannot be used in the Baby mode.

## PICTURE STABILIZATION (FinePix A800 only)

This function is suitable for taking a pictures of moving subjects such as children or pets.

Use this mode to select a fast shutter speed that reduces camera shake and moving-subject blurring.

## RED EYE REDUCTION (FinePix A800 only)

This mode is suitable for shooting portraits in low-light conditions.

Use this mode to minimize red-eye (eyes appear in red in the finished photo).



## CAUTION

Flash fires automatically. Do not use this mode at situations where the flash cannot be used.

## MEMO

When using the flash to take a picture of people in low-light conditions, eyes may sometimes appear red in the picture. This is caused by the light of the flash reflecting off the inside of the eye.

## DIGITAL ZOOM (FinePix A800 only)

Using this mode allows you to enlarge your subject automatically 3x and to shoot an enlarged image quickly. Further zoom is available by adjusting the zoom switch to activate optical zoom.

## ■ Zoom bar display



## CAUTION

- Using the DIGITAL ZOOM allows you to enlarge your subject and shoot it. However, it will lower your image quality. Set the DIGITAL ZOOM when requiring it.
- When using DIGITAL ZOOM, an increasing 'speckling' effect might be observed in the LCD monitor.
- DIGITAL ZOOM is different from DIGITAL ZOOM (→p.87) selected in SET-UP menu. With DIGITAL ZOOM, optical zoom adjustment is available but digital zoom adjustment is not available.

## PORTRAIT

Use this mode for photography to get beautiful skin tones and soft overall tone.



## LANDSCAPE

Use this mode for shooting scenery in daylight and provides crisp, clear shots of scenery such as buildings and mountains.



### CHECK

Flash cannot be used in the Landscape mode.

## SPORT

Use this mode to take pictures of a moving subject. It gives priority to faster shutter speeds.



## NIGHT

Use this mode for shooting evening and night scenes.

A picture is taken with a slow shutter of up to 3 seconds.



### CHECK

Use a tripod to prevent camera shake, because a picture is taken with a slow shutter.

**Continued** ➔

## NATURAL LIGHT (FinePix A800 only)

This mode produces beautiful images that retain the natural ambience when shots are taken in low-light conditions.

This mode is also ideal for shooting indoor or situations where the flash cannot be used.



Camera sets the high-sensitivity setting when selecting the Natural light mode. This mode is effective for reducing camera shake and moving-subject blurring when taking pictures in low-light conditions.

### CHECK

Flash cannot be used in the Natural light mode.

## BEACH

Use this mode to prevent darkening images and provide crisp, clear shots, when shooting at beach under strong sunlight.



## SNOW

Use this mode to prevent darkening images and provide crisp, clear shots, when shooting at snowy scene where the whole screen appears white.



## FIREWORKS

Use this mode to shoot fireworks.

It is effective for taking more vivid shots of fireworks with a slow shutter.



### CHECK

- Flash cannot be used in the Fireworks mode.
- Shutter speed setting: 1/2 sec. to 4 sec.
- Use a tripod to prevent camera shake in the Fireworks mode.

### ■ Selecting the exposure time setting

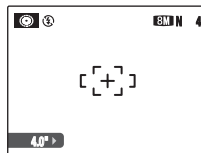

Press ◀ or ▶ to select the exposure time.



**SUNSET**

Use this mode to shoot sunset, making the colors more vivid.

**UNDERWATER**

Use this mode for shooting with a waterproof case. It is effective for taking more vivid shots of ocean blue.

**\* FLOWER**

Use this mode to take clear close-up shots when zooming up a flower. It is effective for taking more vivid shots of flower petal.

**✓ CHECK**

- Flash cannot be used in the Flower mode.
- Focal range  
Wide angle:  
Approx. 10 cm to 2 m (3.9 in. to 6.6 ft.)  
Telephoto:  
Approx. 35 cm to 2 m (13.8 in. to 6.6 ft.)

**▽ PARTY**

Use this mode for shooting at indoor wedding and party. This mode produces beautiful images that retain the natural ambience when shots are taken in low-light conditions.



**Continued** ➔

**MUSEUM**

Use this mode for taking pictures in places such as museum where the use of flash and making an operation sound and a shutter sound are restricted.

Flash mode is forcibly set to Suppressed flash and operation sound, shutter sound and the self-timer lamp are off.



**MEMO**

Check whether photography is permitted before using this mode.

**TEXT**

Use this mode to shoot documents and white board.

It is effective for taking clearer shots of letters.



**CHECK**

Focal range

Wide angle:

Approx. 10 cm to 2 m (3.9 in. to 6.6 ft.)

Telephoto:

Approx. 35 cm to 2 m (13.8 in. to 6.6 ft.)

**MANUAL**







Set the Photography functions to manual to easily control yourself.

Photography functions:

-  EXP. COMPENSATION (→p.63)
-  WHITE BALANCE (→p.64)

## Macro (Close-up)

Use this mode to take close-up shots.

**Available Photography modes:** , AUTO, , , , , , OFF (→p.46, 48, 49, 50)

Press  (◀) to select Macro mode.

Press  (◀) again to cancel Macro mode.

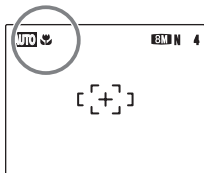
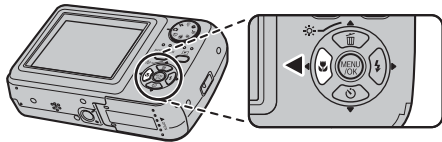

 appears on the LCD monitor indicating that you can take close-up shots.



### CAUTION

,  and  are not available on the FinePix A610.

### CHECK

- Focal range
  - Wide angle:  
Approx. 10 cm to 80 cm (3.9 in. to 2.6 ft.)
  - Telephoto:  
Approx. 35 cm to 80 cm (1.1 ft. to 2.6 ft.)
- Effective flash range  
Approx. 30 cm to 80 cm (1.0 ft. to 2.6 ft.)

### MEMO

- When setting  or  mode, the camera sets to  Macro mode automatically.
- Use a tripod to prevent camera shake in Macro mode.
- Any of the following cancels Macro mode:
  - Changing the Shooting mode setting
  - Turning the camera off

## ⚡ Setting the Flash (Intelligent Flash)

Flash photography is useful for taking pictures at night or indoor dark locations. Choose from 6 flash modes according to the type of shot. See p.53 for information on the available Photography modes.

### MEMO

By calculating subject distance and brightness, the camera automatically adjusts the flash amount to suit shooting conditions. This maintains consistent balance of bright/dark areas across the image in low-light conditions (dimly-lit room, etc). The Intelligent Flash feature guarantees consistent results when using the flash.

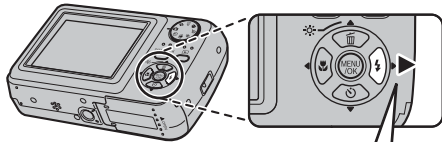

The flash setting changes each time you press **⚡** (▶).

### MEMO

When pressing the shutter button down halfway, **⚡** appears on the LCD monitor before the flash fires.

### AUTO AUTO FLASH (not displayed)

Use this mode for ordinary photography.  
The flash fires as required by the shooting conditions.

### 👁️ RED EYE REDUCTION

This mode is suitable for shooting portraits in low-light conditions. Use this mode to minimize red-eye (eyes appear in red in the finished photo). On the FinePix A800, you can set this mode as a shooting mode (p.46).



### 📄 MEMO Red-eye effect

When using the flash to take a picture of people in low-light conditions, eyes may sometimes appear red in the picture. This is caused by the light of the flash reflecting off the inside of the eye.

### ⚡ FORCED FLASH

Use this mode in backlit scenes, or to get the correct colors when taking a picture under bright lighting. In this mode, the flash fires in bright as well as dark conditions.

### 🚫 SUPPRESSED FLASH

This mode is suitable for situations where the flash cannot be used.

Use a tripod to prevent camera shake when shooting in Suppressed flash mode in the dark condition. Any time, flash does not fire.

### ⚡ SLOW SYNCHRO, 👁️ RED EYE & SLOW

This mode allows you to take pictures of people at night that clearly show both your subjects and the night time backdrop. To prevent camera shake, always use a tripod. Using **👁️** synchronizes Red-eye reduction mode. Using **⌚** selects slow shutter speeds of up to 3 seconds.

**! CAUTION**

In bright scenes, overexposure may occur.

**✓ CHECK**

Effective flash range (⊕ : AUTO)

**<FinePix A610>**

Wide-angle:

Approx. 60 cm to 3.5 m (2.0 ft. to 11.5 ft.)

Telephoto:

Approx. 60 cm to 1.9 m (2.0 ft. to 6.2 ft.)

**<FinePix A800>**

Wide-angle:

Approx. 50 cm to 3.8 m (1.6 ft. to 12.5 ft.)

Telephoto:





Approx. 60 cm to 2.0 m (2.0 ft. to 6.6 ft.)

























If you take pictures outside of the effective flash range, the image may appear dark even if the flash is used.

**! CAUTION Notes on using flash**

- If pressing the shutter button while the flash is charging (indicator lamp blinking orange), the picture will be taken without the flash (when using AUTO and .
- The flash charging time may increase when the batteries are low on charge.
- When taking a picture using the flash, the image may disappear and go dark briefly due to flash charging. The indicator lamp blinks orange during charging.
- The flash fires several times (pre-flashes and the main flash). Do not move the camera until the picture is taken.

**✓ CHECK**

List of available flash modes in each Photography mode (, ,  and  are not available on the FinePix A610).

	AUTO					
	✓	✓	✓	✓	✓	✓
AUTO	✓	✓	✓	✓		
				✓		
	✓	✓	✓	✓		
		✓				✓
	✓	✓	✓	✓		
	✓	✓	✓	✓	✓	✓
				✓		
	✓		✓	✓		
				✓	✓	✓
				✓		
	✓	✓	✓	✓		
	✓	✓	✓	✓		
				✓		
		✓		✓		
	✓	✓	✓	✓		
				✓		
		✓				
				✓		
			✓	✓		

## Self-Timer

The self-timer is used in situations where the photographer is included in the shot. When photographer is away from the camera, use a tripod to prevent camera fall.



**Available Photography modes:** All (→p.46 – 50)

### Setting self-timer

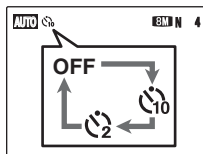
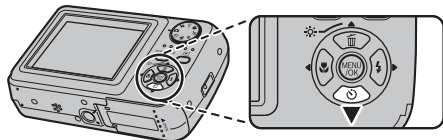
The self-timer setting changes each time you press  (▼).



The last displayed setting is the selected mode.

- : The picture is taken after 10 seconds.
- : The picture is taken after 2 seconds.

### Taking pictures using self-timer

- 1 Press the shutter button down halfway to focus on the subject and press the shutter button fully.

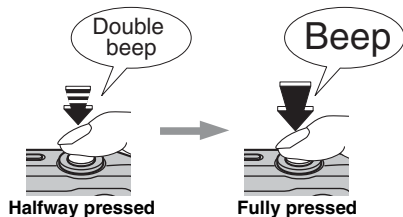

Pressing the shutter button down halfway that focuses on the subject. Without releasing the shutter button, press the button all the way down (fully pressed) to start the self-timer.

## 2 Take pictures in selected time.

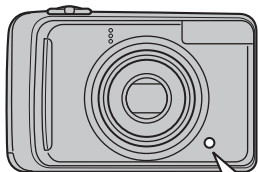

A picture is taken after the self-timer lamp changes from lit to blinking (only blinks with the 2-second self-timer).

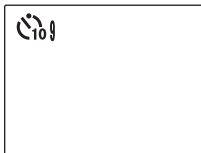
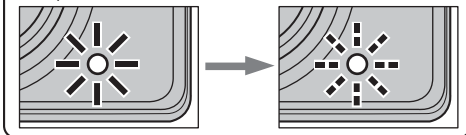

A countdown appears on the LCD monitor indicating the time remaining until the picture is taken.

### *Using the 2-second self-timer*

This is useful when you worry about camera shake even if attaching the camera on a tripod.

#### MEMO

- To stop the self-timer, once it has started running, press DISP/BACK.
- Any of the following cancels the self-timer setting:
  - Completing the shooting
  - Changing the Photography mode setting
  - Setting the camera to Playback mode
  - Turning the camera off
- Take care not to stand in front of the lens when pressing the shutter button as this can prevent the correct focus or brightness (exposure) from being achieved.

# ☀ Increasing Monitor Brightness

Use this function to increase the brightness of the LCD monitor temporarily when you have difficulty seeing the monitor in low-light conditions or in daylight.

## ☒ Increasing the LCD monitor brightness

Press ☀ (▲) to display the LCD monitor brightly.  
Press ☀ (▲) again to return to normal LCD monitor brightness.

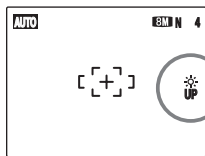
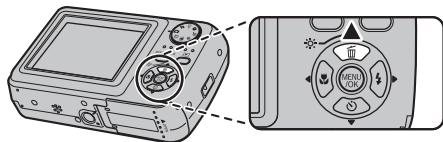

☀ UP blinks on the LCD monitor when the function is on.

### MEMO

- This function is automatically canceled after each shot.
- When this function is active, it will increase the amount of speckling in images on the LCD monitor. This is normal and does not affect the photographed image.
- This function is purely for checking the composition of your shot. It does not increase the brightness of the image.
- Even if you increase the brightness in low-light conditions, you cannot check the subject.
- The color tones may vary depending on the subjects.



# Using SHOOTING MENU

Use the SHOOTING MENU to adjust image quality. You can take pictures in a wide range of conditions.

## Setting the SHOOTING MENU

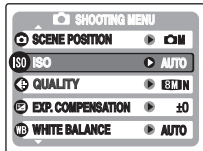

\* FinePix A800



- ① Press MENU/OK to open the SHOOTING MENU.



- ② Press ▲ or ▼ to select the menu.

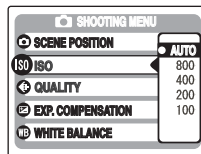

\* FinePix A800



- ③ Press ►.



- ④ Press ▲ or ▼ to change the setting.



- ⑤ Press MENU/OK to confirm the setting.

### List of SHOOTING MENU options (FinePix A610)

Menu	Functions	Settings	Factory default
SHOOTINGMODE (→p.43)	Use this setting to provide the best photography menu setting for the scene being shot.	/ AUTO /  /  /  /  /  / OFF / TEXT	AUTO
ISO (→p.60)	Specifies required sensitivity setting of the ambient light around the subject. The larger value of the sensitivity, the higher sensitivity is obtained. The higher sensitivity settings will allow you to take pictures in darker locations.	AUTO/400/200/100	AUTO
QUALITY (→p.61)	Specifies the image size. The larger image size, the better image quality is obtained. The smaller image size, the larger number of images are recorded.	6M F / 6M N / 3:2 / 3M / 2M / 03M	6M N
EXP. COMPENSATION (→p.63)	This setting can be used when the SHOOTING MODE is set to . Use this setting to obtain the correct exposure.	-2 EV to +2 EV (1/3 EV increments)	±0
WHITE BALANCE (→p.64)	This setting can be used when the SHOOTING MODE is set to . Use this setting to adjust the color balance to suit the color of the ambient light around the subject.	AUTO / * /  /  /  /  /  /	AUTO

### MEMO

Note that the shooting menu will vary depending on the selected shooting mode.

- When shooting mode is set to other than .
- When shooting mode is set to .

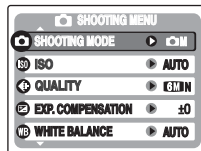
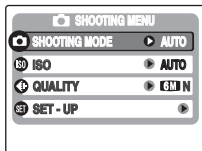

## ■ List of SHOOTING MENU options (FinePix A800)

Menu	Functions	Settings	Factory default
SCENE POSITION (→p.44)	This setting can be used when the Mode dial is set to SP. Use this setting to provide the best photography menu setting for the scene being shot.		
ISO (→p.60)	Specifies required sensitivity setting of the ambient light around the subject. The larger value of the sensitivity, the higher sensitivity is obtained. The higher sensitivity settings will allow you to take pictures in darker locations.	AUTO/800/400/200/100	AUTO
QUALITY (→p.61)	Specifies the image size. The larger image size, the better image quality is obtained. The smaller image size, the larger number of images are recorded.	8M F/8M N/8:2 4M/ 2M / 03M	8M N
EXP. COMPENSATION (→p.63)	This setting can be used when the SHOOTING MODE is set to . Use this setting to obtain the correct exposure.	-2 EV to +2 EV (1/3 EV increments)	±0
WHITE BALANCE (→p.64)	This setting can be used when the SHOOTING MODE is set to . Use this setting to adjust the color balance to suit the color of the ambient light around the subject.	AUTO /  /  /  /  /  /	AUTO

### MEMO

Note that the shooting menu will vary depending on the selected shooting mode.

- When shooting mode is set to , , , , , , , , , , , , , , .
- When shooting mode is set to , , , , , , , , , , , , , (mode dial set to SP).
- When shooting mode is set to (mode dial set to SP).

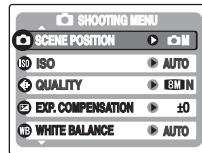
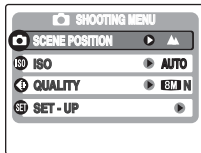
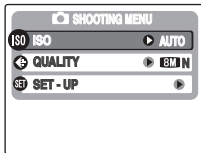

## Changing the sensitivity setting (ISO ISO)

Use this menu to specify required sensitivity setting of the ambient light around the subject.  
The larger value of the sensitivity, the higher sensitivity is obtained. The higher sensitivity settings will allow you to take pictures in darker locations.

### CHECK

#### Settings

<FinePix A610>

AUTO/400/200/100

<FinePix A800>

AUTO/800/400/200/100

Selecting AUTO as the sensitivity setting, the camera selects the best sensitivity setting for the subject's brightness.

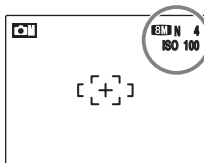

The selected sensitivity setting appears on the LCD monitor when the sensitivity setting is set to another setting excluding AUTO.

### MEMO

When anything other than **M** MANUAL in the Photography mode is selected, only AUTO can be selected for the ISO (sensitivity) setting.

### CAUTION

Although higher sensitivity settings will allow you to take pictures in darker locations, they will also increase the amount of speckling in your images. Choose the sensitivity setting that best suits the conditions.

## Changing the quality setting (QUALITY)

Use this menu to specify the image size (number of recorded pixels).

Select the quality setting for the scene being shot.

### Quality settings in Photography mode (FinePix A610)

Quality mode	Sample uses
<b>6M</b> F (2848 × 2136) <b>6M</b> N (2848 × 2136)	Printing at up to 10R (25.4 × 30.5 cm/ 10 × 12 in.) / A4 size
<b>3:2</b> (3024 × 2016)	For better quality, select <b>6M</b> F
<b>3M</b> (2048 × 1536)	Printing at up to 6R (15.2 × 20.3 cm/ 6 × 8 in.) / A5 size
<b>2M</b> (1600 × 1200)	Printing at up to 4R (10.2 × 15.2 cm/ 4 × 6 in.) / A6 size
<b>0M</b> (640 × 480)	To use for e-mail or web site

### Quality settings in Photography mode (FinePix A800)

Quality mode	Sample uses
<b>6M</b> F (3296 × 2472) <b>6M</b> N (3296 × 2472)	Printing at up to 10R (25.4 × 30.5 cm/ 10 × 12 in.) / A4 size / A3 size
<b>3:2</b> (3504 × 2336)	For better quality, select <b>6M</b> F
<b>4M</b> (2304 × 1728)	Printing at up to 6R (15.2 × 20.3 cm/ 6 × 8 in.) / A5 size
<b>2M</b> (1600 × 1200)	Printing at up to 4R (10.2 × 15.2 cm/ 4 × 6 in.) / A6 size
<b>0M</b> (640 × 480)	To use for e-mail or web site

*Continued* ➔

**Area shot and quality setting****Area shot excluding 3:2****Area shot with 3:2**

Normal shooting provides an aspect ratio of 4:3 and **3:2** shooting provides an aspect ratio of 3:2 (same aspect ratio as 35 mm film and post card).

 **MEMO**

- The bigger the number of recorded pixels, the better the image quality becomes. As the number of recorded pixels becomes smaller, you will be able to record more frames to a Memory Card.
- The quality setting is retained even when the camera is turned off or the mode setting is changed.
- When changing the quality setting, the number of available frames also changes (→p.139, 144). The numbers to the right of setting show the number of available frames.

## Adjusting exposure compensation ( EXP. COMPENSATION)

Available Photography mode:  (→p.50)

Use this menu for shots to get the correct brightness (exposure), such as shots with extremely high contrast between the subject and the background.

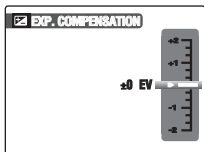

positive (+) compensation



negative (-) compensation



### CHECK

- Compensation range: -2 EV to +2 EV (13 steps in 1/3 EV increments)
- Explanation of Terms "EV" (→p.148)
- The LCD monitor brightness will increase or decrease depending on the exposure compensation setting.

### Guide to compensation

- Backlit portraits: +2/3 EV to +1 2/3 EV





- Very bright scenes (such as snowfields) and highly reflective subjects: +1 EV



- Shots made up predominantly of sky: +1 EV
- Spotlight subjects, particularly against dark backgrounds: -2/3 EV
- Scenes with low reflectivity, such as shots of pine trees or dark foliage: -2/3 EV

### MEMO

- This setting is retained when the camera is turned off ( icon appears). Set the exposure compensation to "±0 EV" unless compensation is required.
- Any of the following disables exposure compensation:
  - Using the flash in AUTO or  mode
  - Shooting dark scenes in  mode

## Adjusting color balance (WB WHITE BALANCE)

Available Photography mode: (→p.50)

Adjust the color balance based on white to suit the color of the ambient light around the subject.

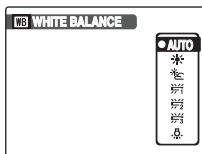

AUTO: Automatic adjustment

☀: Shooting outdoors in good weather

☁: Shooting in shade

☀: Shooting under Daylight fluorescent lamps

☀: Shooting under Warm White fluorescent lamps

☀: Shooting under Cool White fluorescent lamps

💡: Shooting in incandescent light

### MEMO

- In AUTO mode, the correct white balance may not be achieved for subjects such as close-ups of people's faces and pictures taken under a special light source. Select the correct white balance for the light source.
- When the flash fires, the white balance setting for the flash is used. Consequently, to achieve a particular effect, the flash mode should be set to SUPPRESSED FLASH (→p.52).
- The color tones may vary depending on the shooting conditions (light source, etc.).
- After taking the picture, check the image color (white balance).
- Explanation of Terms "White Balance" (→p.148)





# Using PLAYBACK MENU

Use this menu to play back photographed images.

## Setting the PLAYBACK MENU



- 1 Press to set the camera to Playback mode (→p.34).

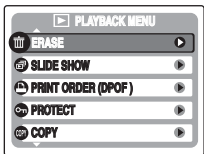

- 2 Press MENU/OK to open the PLAYBACK MENU.



- 3 Press or to select the menu.



- 4 Press .

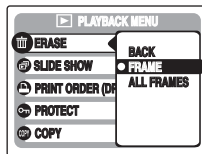

- 5 Press or to change the setting.



- 6 Press MENU/OK to confirm the setting.

### ! CAUTION



Menu listing will vary depending on model.

## Setting automatic playback ( SLIDE SHOW)

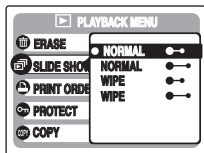
Use this mode to play back photographed images continuously. You can select playback interval and type of image transition.





### MEMO

- To interrupt  SLIDE SHOW, press MENU/OK.
- Press  or  to advance or go back through the images.
- The Auto power off function (→p.90) does not operate during slide show.
- Movie starts automatically. When the movie ends, the playback function moves it on.
- Press DISP/BACK once during playback to display on-screen help.

## DPOF set frame ( PRINT ORDER (DPOF))

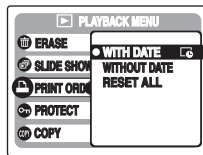

You can specify the image, number of prints, with or without date of printing with a DPOF-compatible printer.



- WITH DATE  : The date will be imprinted on your prints.
- WITHOUT DATE : The date will not be imprinted on your prints.
- RESET ALL : All DPOF settings will be canceled.

**Continued** 

## WITH DATE / WITHOUT DATE

Selecting WITH DATE ,  appears on the LCD monitor and the date will be imprinted on your prints.

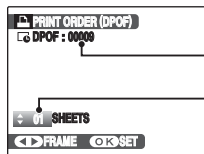

Total number of prints

Setting for that frame



- 1 Press ◀ or ▶ to display the frame (file) for specifying DPOF setting.



- 2 Press ▲ or ▼ to set a value.  
Up to 99 sheets are printed.  
For frames (files) that you do not want printed, set the number of prints to 0 (zero).

To specify more DPOF settings, repeat steps ① and ②.





- 3 Always press MENU/OK after the settings are completed.  
Pressing DISP/BACK cancels those settings.



- 4 Press MENU/OK again.  
The total number of prints appears on the LCD monitor.

## MEMO Canceling DPOF setting

- 1 Press MENU/OK to open the PLAYBACK MENU and press ▲ or ▼ to select  PRINT ORDER (DPOF).
- 2 Press ▶.
- 3 Press ▲ or ▼ to select WITH DATE  or WITHOUT DATE and press MENU/OK to display the print order screen.
- 4 Press ◀ or ▶ to select the frame (file) with the DPOF setting you want to cancel.
- 5 Press ▼ to set the number of prints to 0 (zero).

To cancel the DPOF setting for another frame (file), repeat steps ④ and ⑤.

Always press MENU/OK to complete the settings.

- RESET ALL (→p.69)

## MEMO

- When DPOF settings were specified on another camera.

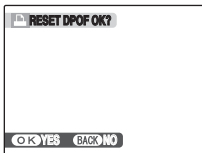

When the data includes a frame (file) with DPOF settings that were specified on another camera, "RESET DPOF OK?" appears.

Pressing MENU/OK erases all of the DPOF settings already specified for each frame (file). Specify the DPOF setting for each frame (file) again.

- Prints of up to 999 frames (files) can be ordered on the same Memory Card.
- DPOF settings cannot be specified for movies.

## CAUTION

- Pressing DISP/BACK while choosing settings will cancel all current settings. If there were previous DPOF settings, only the modifications are canceled.
- When selecting the WITH DATE  setting, the date is imprinted on your shots using the Print Service or a DPOF-compatible printer (depending on the printer specifications, the date may not be printed in some cases).
- Images photographed with a camera other than FinePix A610/FinePix A800 may not be specified DPOF settings.

## RESET ALL

To cancel all DPOF settings:

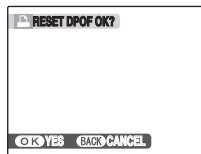



Select RESET ALL in the PLAYBACK MENU (→p.67).

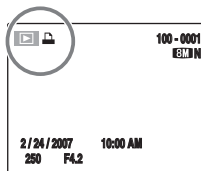

Press MENU/OK.

## MEMO



 appears on the LCD monitor during playback when the image has specified DPOF settings.

**PRINT ORDER (DPOF)**

DPOF stands for Digital Print Order Format and refers to a format that is used for recording printing specifications for images shot using a digital camera on media such as a Memory Card. The recorded specifications include information on which frames are to be printed.

This section gives a detailed description of how to order your prints with FinePix A610/FinePix A800.

\*Some printers do not support date and time imprinting or specification of the number of prints.

\*The warnings shown below may appear while specifying the prints.

"DPOF SPECIFIED. ERASE OK ?"

"DPOF SPECIFIED. ERASE ALL OK ?" (→p.40)

When erasing the image, the DPOF setting for that image is deleted at the same time.

"RESET DPOF OK ?" (→p.69)

When inserting a Memory Card that contains images specified for printing by another camera, those print specifications are all reset and replaced by the new print specifications.

[DPOF FILE ERROR] (→p.126)

Up to 999 images can be specified on the same Memory Card.

## Protecting the images ( PROTECT)

Use this mode to prevent frames (files) from being accidentally erased. Your camera calls images “frames”.

### FRAME SET / RESET

To protect or unprotect only the selected frame (file):

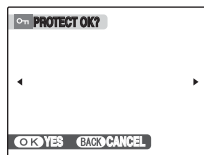

Unprotected

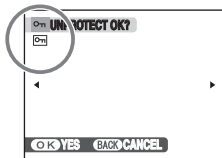

Protected ( appears)



- 1 Press ◀ or ▶ to select the protecting/unprotecting frame (file).



- 2 Press MENU/OK to protect/unprotect the currently displayed frame (file).  
Unprotected: protecting frame (file)  
Protected: reset frame (file)

To protect another frame (file), repeat steps ① and ②.  
When protecting frames (files) is completed, press DISP/BACK.

### SET ALL

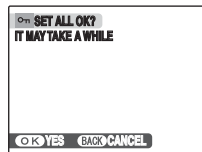

Press MENU/OK to protect all the frames (files).

### RESET ALL

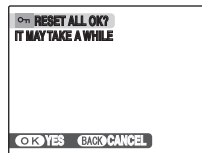

Press MENU/OK to unprotect all the frames (files).

 **MEMO** To stop the procedure midway

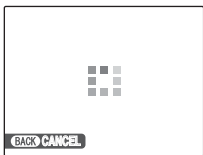

If the images are very large, protecting or unprotecting all the frames (files) may take some time.  
If you want to take a picture or record a movie during the procedure, press DISP/BACK.

 **CAUTION**





The Format function erases all the frames (files), including protected frames (files) (→p.89).

 **Copying the images**  
(COPY COPY)

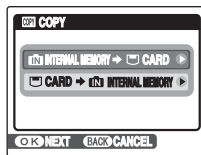
It is possible to transfer saved images between the internal memory and a Memory Card. Your camera calls images "frames".

■ **Selecting COPY**



- ① Press ▲ or ▼ to select  INTERNAL MEMORY →  CARD or  CARD →  INTERNAL MEMORY.



- ② Press ►.



## Copying one frame at a time (FRAME)

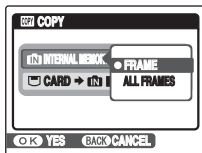

① Press ▲ or ▼ to select FRAME.



② Press MENU/OK.

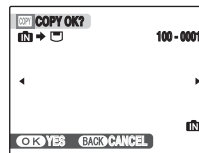

③ Press ◀ or ▶ to select the copying frame (file).



④ Press MENU/OK to copy the currently displayed frame (file).



### MEMO

To copy another frame (file), repeat steps ③ and ④.  
When copying frames (files) is completed, press DISP/BACK.

## Copying all frames (ALL FRAMES)

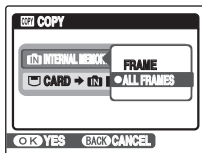

① Press ▲ or ▼ to select ALL FRAMES.



② Press MENU/OK.

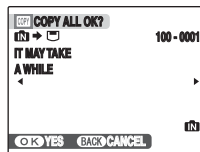

③ Press MENU/OK to copy all the frames (files).

### ! CAUTION

- When [MEMORY FULL] or [MEMORY FULL] appears on the LCD monitor, copying the data stops on the way.
- When copying the image that has specified DPOF setting, the DPOF setting is not copied.

## Rotating the images

### Ⓢ IMAGE ROTATE

When shooting in the vertical position, the image appears horizontal on the LCD monitor. Use this mode to rotate an image and to display correct direction.

#### ! CAUTION

Protected frames (files) cannot be rotated. Unprotect the frames (files) before rotating them (→p.71).

#### MEMO

An image can be rotated only when playing back using FinePix A610/FinePix A800. You may not be able to rotate images that were shot with a camera other than FinePix A610/FinePix A800.

- ① Press ◀ or ▶ to select the rotating frame (file).
- ② Press MENU/OK to open the PLAYBACK MENU.
- ③ Press ▲ or ▼ to select Ⓢ IMAGE ROTATE.
- ④ Press MENU/OK.

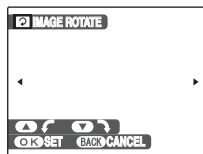

- ⑤ Press ▲ or ▼ to rotate the image.
  - ▼: Rotates the image clockwise at a 90 degree angle.
  - ▲: Rotates the image counterclockwise at a 90 degree angle.















- ⑥ Press MENU/OK to confirm the setting. Next time the image is played back, it will be automatically rotated. Press DISP/BACK to cancel rotating the image.











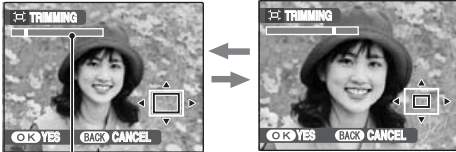

## Trimming the images (TRIMMING) (FinePix A800 only)

Use this mode to trim the required part of the photographed image.

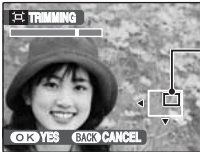
### 1 Select the menu.

- ① Press  to set the camera to Playback mode (→p.34).  

- ② Press  or  to select the trimming frame (file).  

- ③ Press MENU/OK to open the PLAYBACK MENU.  

- ④ Press  or  to select  TRIMMING.  

- ⑤ Press .  

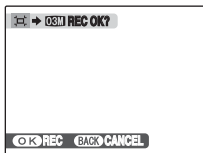
### 2 Specify trimming part of image.

-  wide zoom  
(Zoom out)
-  tele zoom  
(Zoom in)
- 
- Zoom bar**
- ① Set the zoom switch to  or  to zoom in or out of an image.
- 
- Navigation screen  
(Current displayed image)**
- 
- ② Press , , , or  to display another part of the image.
- 



③ Press MENU/OK.



### 3 Record the image.

Check the saved image size and press MENU/OK.



The trimmed image is added as a separate file in the final frame.



#### MEMO

- Press DISP/BACK to return to single-frame playback.
- A saved image size varies depending on the zoom scale of step 2. For 0.3 M, **OK** YES option appears in yellow.
- Image sizes

<b>4M</b>	Printing at up to 6R (15.2 × 20.3 cm/6 × 8 in.) / A5 size
<b>2M</b>	Printing at up to 4R (10.2 × 15.2 cm/4 × 6 in.) / A6 size
<b>03M</b>	To use for e-mail or web site

- When **S2** quality setting is selected, the image is trimmed to normal size (4:3 aspect ratio).



#### CAUTION





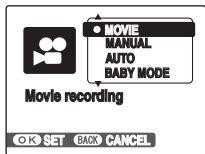

-  trimming is not available on the FinePix A610.
- You may not be able to trim images that were shot with a camera other than FinePix A800.

## Recording Movies

Use this mode to record movies.  
Note that the way to set the Movie mode vary depending on model. See the instructions below and follow the one which applies to your camera.

### Set the camera to Movie mode (FinePix A610)



-  ① Press MENU/OK to open the menu.
-  ② Press ▲ or ▼ to select  SHOOTING MODE.
-  ③ Press ►.
-  ④ Press ▲ or ▼ to select  MOVIE.
-  ⑤ Press MENU/OK to confirm the setting.

### Set the camera to Movie mode (FinePix A800)

Set the Mode dial to .

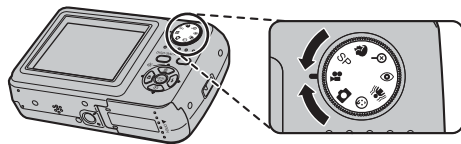

#### CHECK

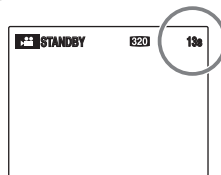



The available recording time appears on the LCD monitor.

## Zooming the image

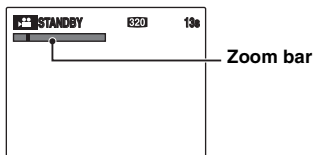
You must zoom beforehand as you cannot zoom during recording.



Set the zoom switch to  or  to zoom in or out of an image.

## CHECK

### (FinePix A610)

- Optical zoom focal length  
Approx. 39 mm to 117 mm (35 mm camera equivalent)  
Max. zoom scale: 3x
- Focal range  
Approx. 60 cm (2.0 ft.) to infinity

### (FinePix A800)

- Optical zoom focal length  
Approx. 36 mm to 108 mm (35 mm camera equivalent)  
Max. zoom scale: 3x
- Focal range  
Approx. 50 cm (1.6 ft.) to infinity

## Record movies



Fully pressed

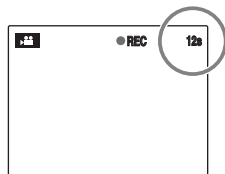

Press the shutter button down fully to start recording. During recording,  REC and a counter that shows the remaining time appear on the LCD monitor.



Halfway pressed

Recording ends when pressing the shutter button down halfway during recording or the remaining time runs out.



## MEMO

There is no need to hold down the shutter button during recording.

**Continued** ➔

 **CHECK Recording movies**

- Specifications: Motion JPEG (→p.148).  
<FinePix A610> without sound  
<FinePix A800> Monaural sound
- Quality selection method: **920** (320 × 240 pixels)
- Frame rate (→p.148): 30 frames per second (fixed)

 **MEMO**

- The brightness and color of the LCD monitor shown during movie recording may differ from those shown before recording begins.
- Pressing the shutter button down fully fixes the focus, however the exposure and white balance are adjusted to the scene being shot.
- If recording is stopped immediately after it begins, 1 second of the movie is recorded onto the Memory Card or internal memory.
- See p.139, 144 for information on recording times per Memory Card or internal memory.

 **CAUTION**

- You may not be able to record a movie with sound when using FinePix A610. Check the “Specifications” in the “CHECK Recording movies” in the left column.
- Because a movie is recorded onto the Memory Card or internal memory as it is saved, it cannot be recorded correctly if the camera suddenly loses power (if the batteries run out or the AC power adapter is disconnected).
- A movie file taken by FinePix A610/FinePix A800 may not be playable on other cameras.
- When using FinePix A800, sound is recorded concurrently with the images. So make sure not to cover the microphone with your finger when recording (→p.14).
- When using FinePix A800, camera operation noises may be recorded during movie shooting.
- If you shoot using the **xD-Picture Cards** with model numbers containing “M” such as DPC-M1GB, movie recording time may be reduced if you repeatedly record and erase (frame erase) image files.  
In such a case, erase all frames or format the **xD-Picture Card** before use. Back up important frames (files) onto your PC or another media.



# ▶ Playing Back Movies

Setting the camera to ▶  
Playback mode (→p.34)

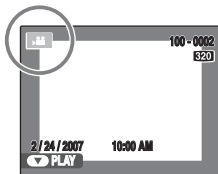

- ① Press ◀ or ▶ to select the movie file. ▶ appears on the LCD monitor.



- ② Press ▼ to begin playing back movie.

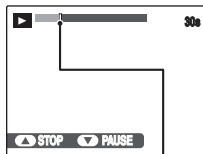

Progress bar

The playback time appears on the LCD monitor along with a progress bar.

## ■ Playing back movies

	Control	Description
Playback		Playback begins. Playback stops when the end of the movie is reached.
Pause / Resume		Pauses the movie during playback. Press ▼ again to resume playback.
Stop		Stops playback. Press ◀ or ▶ while playback is stopped to go back to the previous file or advance to the next file respectively.
Fast forward / Rewind		Press ◀ or ▶ during playback to skip forwards or backwards through the movie.
Skip playback		Press ◀ or ▶ when the movie is paused, the movie advances or goes back one frame. Hold down ◀ or ▶ to move through the frames quickly.

 **MEMO**

If the subject of the shot is very bright, white vertical streaks or black horizontal streaks may appear in the image during playback. This is normal.

 **CAUTION**

- You may not be able to record movie with sound when using FinePix A610. Check the "Specifications" in the "CHECK Recording movies" on p.80.
- You may not be able to play back some movie files recorded on other cameras.
- To play back movie files on a PC, save the movie file on the Memory Card or internal memory to the PC's hard disk and then play back the saved file.
- When using FinePix A800, make sure not to cover the speaker. The sound is difficult to hear.

### Adjusting volume of movies (Only for the FinePix A800)

You can adjust the volume of the movie with the FinePix A800.

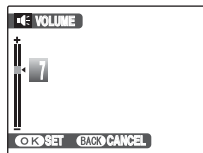

- ① Press MENU/OK while playing back movie.

The movie is paused during playback.



- ② Press ▲ or ▼ to adjust the volume.



- ③ Press MENU/OK to confirm the setting.  
Camera starts to play back the movie.

## Using the SET-UP menu

### 1 Open the SET-UP menu.



① Press MENU/OK to open the menu.



② Press ▲ or ▼ to select SET-UP.



③ Press ►.

### 2 Change the page.

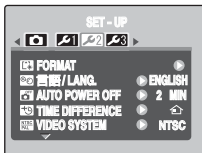

\* FinePix A800



① Press ◀ or ▶ to select the page.



② Press ▼ to move to menu item.

### 3 Change the setting.

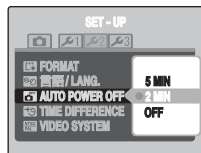

\* FinePix A800



① Press ▲ or ▼ to select the menu.



② Press ►.  
Different type of screen appears depending on selected item.



③ Press ▲ or ▼ to change the setting.





④ Press MENU/OK to confirm the setting.















### ! CAUTION













Some functions may not be available when using FinePix A610. Check the "SET-UP menu option" on p.84 for more information.

## SET-UP menu option

### CAUTION

Note that the SET-UP menu will vary depending on the camera model. The table below shows the SET-UP menu of the FinePix A800. Note that the SET-UP menu on the FinePix A610 is displayed only on page , , and .

	Setting	Display	Factory default	Explanation	Page
	 IMAGE DISP.	3 SEC/1.5 SEC	1.5 SEC	Sets the way for displaying the check image screen (photograph result) after taking a picture. The image is displayed for 3 or 1.5 seconds and then recorded. The color tones in images recorded may differ from actual color. Play back the recorded images to check them.	–
	 FRAME NO.	CONT./RENEW	CONT.	Specifies whether frame numbers are assigned consecutively from previous numbers or begin again.	86
	 DIGITAL ZOOM	ON/OFF	OFF	Specifies whether digital zoom is used together.	87
	 LCD POWER SAVE	ON/OFF	ON	Darkens the LCD monitor when camera is not used.	88
	 DATE/TIME	–	–	Corrects the date or time.	25
	 BEEP VOLUME	 /1/2/3/4/OFF		Sets the volume of the tone emitted when the camera controls are used.	–
	 SHUTTER VOLUME (FinePix A800 only)	 /1/2/3/4/OFF		Sets the volume of the sound emitted when the shutter operates.	–
	 PLAYBACK VOLUME (FinePix A800 only)	–	7	Sets the volume of playing back movie.	88
	 LCD BRIGHTNESS	–	0	Sets the LCD monitor brightness.	89

	Setting	Display	Factory default	Explanation	Page
2	 FORMAT	–	–	Initializes a Memory Card or internal memory. Select this menu to erase all the frames (files).	89
	 言語/LANG.	日本語/ENGLISH/ FRANCAIS/DEUTSCH/ ESPAÑOL/ITALIANO/ 中文簡/繁體/한글/ РУССКИЙ/PORTUGUÊS/ NEDERLANDS/TÜRKÇE/ ČESKY/MAGYAR/ POLSKI/SVENSKA	ENGLISH	Specifies the language used for LCD monitor display.	26
	 AUTO POWER OFF	5MIN/2MIN/OFF	2 MIN	Sets the time of turning camera off when camera is not used.	90
	 TIME DIFFERENCE			Specifies the time difference settings.	90
	 VIDEO SYSTEM	NTSC/PAL	–	Specifies whether video output is set to NTSC or PAL.	–
3	 DISCHARGE	–	–	Discharges Ni-MH batteries.	119
	 RESET	–	–	Resets all the camera settings (other than the DATE/TIME, TIME DIFFERENCE, and VIDEO SYSTEM) to the factory default values set at shipment. A confirmation message appears when you press  . To reset the camera settings, press  or  to select OK and press MENU/OK.	–

**FRAME NO.**

Use this function to specify whether frame numbers are assigned consecutively from previous numbers or begin again.

	<CONT.>	<RENEW>
<b>A</b>	0001 ⋮ 0005	0001 ⋮ 0005
↓		
<b>B</b>	0006 ⋮ 0010	0001 ⋮ 0005

\* Formatted Memory Card or internal memory used for both A and B.

**CONT.** : Pictures are stored beginning from the highest file number stored on the last Memory Card or internal memory used.

**RENEW**: Pictures are stored on each Memory Card beginning with a file number 0001. Each image will be numbered consecutively from the last number used. So when recorded images in the Memory Card are erased, the number of the erased frame will not be used again. Even erasing all frames in the Memory Card will not return the number to 0001.

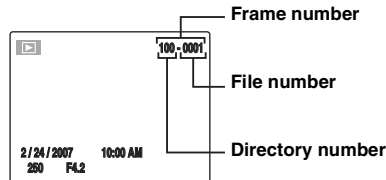
**CHECK**

The last 4 digits of the 7-digit number in the top right corner of the LCD monitor are the file numbers, while the first 3 digits show the directory number.

**MEMO**

- Setting this function to **CONT.** makes file management easier as it makes sure that file names are not duplicated when images are downloaded to a PC.
- When the camera settings are **RESET** (→p.85), the frame number setting (**CONT.** or **RENEW**) is changed to **CONT.** and the frame number itself does not return to 0001.
- In **CONT.** setting, images are stored beginning from the highest file number on the current Memory Card when the Memory Card already contains image files with file numbers higher than the highest file number on the last Memory Card.
- The displayed frame number may differ for images photographed on other cameras.

## DIGITAL ZOOM

Use this function to shoot enlarged images than maximum optical zoom scale.

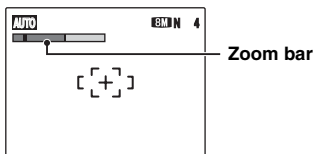

### Zoom bar display

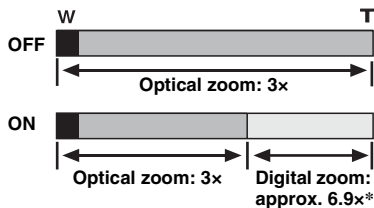

The above description is based on using the FinePix A800.

On the FinePix A610, Digital zoom scale is approximately 6.2x.

### CAUTION

Using the DIGITAL ZOOM allows you to enlarge your subject and shoot it. However, it will lower your image quality. Set the DIGITAL ZOOM when requiring it.

### CHECK

#### FinePix A610

- Optical zoom focal length\*  
Approx. 39 mm to 117 mm
- Digital zoom focal length\*  
Approx. 117 mm to 721 mm  
Max. zoom scale: approx. 6.2x
- Digital zoom focal length (8:2)\*  
Approx. 120 mm to 741 mm  
Max. zoom scale: approx. 6.2x  
\* 35 mm camera equivalents

#### FinePix A800

- Optical zoom focal length\*  
Approx. 36 mm to 108 mm
- Digital zoom focal length\*  
Approx. 108 mm to 746 mm  
Max. zoom scale: approx. 6.9x
- Digital zoom focal length (8:2)\*  
Approx. 111 mm to 766 mm  
Max. zoom scale: approx. 6.9x  
\* 35 mm camera equivalents

### MEMO

When zooming changes between optical and digital, the position of the "■" indicator stops. Turn the Zoom switch to the same direction again to start the "■" indicator moving again.

## LCD POWER SAVE

The LCD monitor darkens when camera is not used for 8 seconds.

When this function is active, you can save power and get the maximum possible running time from your batteries.

### MEMO

Pressing any button wakes the camera up.

### CAUTION

The LCD power save function is disabled during Playback mode and Movie mode.

## PLAYBACK VOLUME (FinePix A800 only)

Use this function to adjust volume while playing back movie.

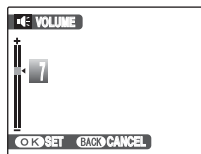

- 1 Press ▲ or ▼ to adjust the volume. The larger the number, the larger the volume is emitted. 0 indicates a sound deadening.



- 2 Press MENU/OK to confirm the setting.

### CAUTION

You can not adjust the playback volume of a movie with the FinePix A610.



## LCD BRIGHTNESS

Use this function to adjust the LCD monitor brightness.

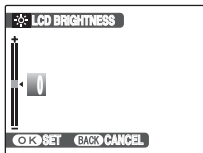

- ① Press ▲ or ▼ to adjust the LCD monitor brightness.



The indicator moves to the + to display the LCD monitor brightly or to the – to darken the LCD monitor.



- ② Press MENU/OK to confirm the setting.

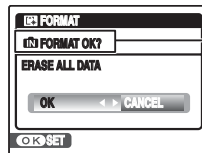

## FORMAT

Initialize (format) the Memory Card or internal memory for use with the camera.



Place of initialize  
 **FORMAT:**  
 Internal memory  
 **FORMAT:**  
 Memory Card



- ① Press ◀ or ▶ to select OK.



- ② Pressing MENU/OK initializes the Memory Card or internal memory.

### ! CAUTION

- The Format function erases all the frames (files), including protected frames (files). Back up important frames (files) onto your PC or another media.
- Do not open the battery cover or expose the camera to shock during formatting, as formatting will be interrupted.

## AUTO POWER OFF

When this function is active and the camera remains unused for 2 or 5 minutes, it turns camera off. Use this function when you want to get the maximum possible running time from your batteries.

### ! CAUTION

The Auto power off function is disabled during slide show (→p.67), discharging rechargeable batteries (→p.119) and when a printer or a PC connection (→p.95, 106) is being used.

### MEMO To restore power to the camera

Refer to "Turning On and Off" (→p.22).

## TIME DIFFERENCE

Use this function when traveling to destinations in different time zones. This function sets a time difference relative to the date and time currently set. When this setting is enabled, the specified time difference is applied when pictures are taken.

### 1 Use Time difference function.

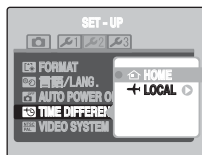

\* FinePix A800



Press ▲ or ▼ to change between HOME and LOCAL.

To set the time difference, select LOCAL.

HOME: Your home time zone

LOCAL: Your destination time zone

## 2 Move to TIME DIFFERENCE screen.

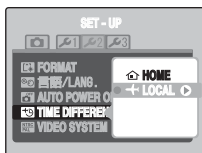

\* FinePix A800



Press ►.

## 3 Set time difference.

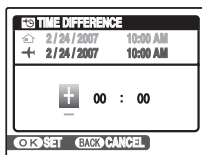

① Press ◀ or ▶ to select +/-, hour, and minute.



② Press ▲ or ▼ to change the setting.



③ Always press MENU/OK after the settings are completed.

### ✓ CHECK

#### Available time setting

-23:45 to +23:45 (in 15-minute increments)

### 📄 MEMO

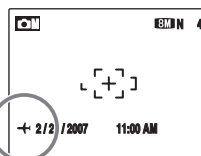

In the time difference setting, when you change to the Photography mode, + and the date is displayed for 3 seconds, the date display turns yellow.

### ✓ CHECK

Upon returning from a trip, always change the time difference setting back to HOME and then check the date and time again.



## Connecting to a TV (FinePix A610)

When connecting to a TV, images can be displayed on wider screen. Using slide show function (→p.67) together, you can have fun with folks.

Plug the Video cable (included) into the VIDEO OUT (Video output) socket of the camera.

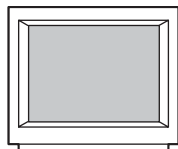

To video (yellow) input socket

Plug the other end of the cable into the Video input socket on the TV.

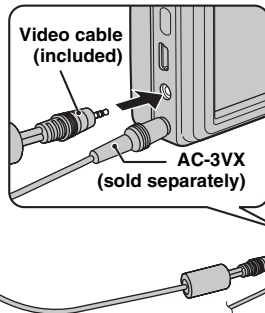

### ! CAUTION

- Plug the Video cable (included) and the AC power adapter (sold separately) correctly and push them in each terminal.
- See p.119 for the information of the AC power adapter (sold separately).

### MEMO

- When connecting the Video cable (included) to TV, the LCD monitor is turned off.
- The image quality for movie playback is lower than for still images.
- Refer to the instructions provided with your TV for more information on video input for your TV.
- Use the AC-3VX (sold separately) when FinePix A610 is connected to a TV for long periods.

# Connecting to a TV (FinePix A800)

When connecting to a TV, images can be displayed on wider screen. Using slide show function (→p.67) together, you can have fun with folks.

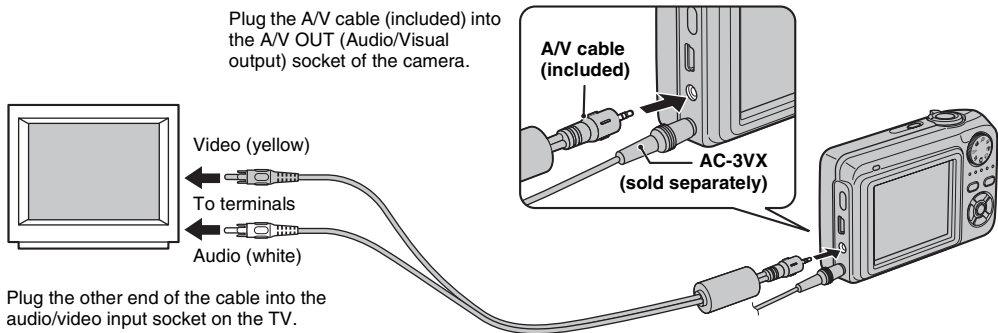

## ! CAUTION

- Plug the A/V cable (included) and the AC power adapter (sold separately) correctly and push them in each terminal.
- See p.119 for the information of the AC power adapter (sold separately).

## MEMO

- When connecting the A/V cable (included) to TV, the LCD monitor is turned off.
- The image quality for movie playback is lower than for still images.
- When connecting to a TV, even if you adjust the volume from the **[M]** PLAYBACK VOLUME, the TV volume cannot be changed. Refer to the instructions provided with your TV for more information on audio/video input for your TV.
- Use the AC-3VX (sold separately) when FinePix A800 is connected to a TV for long periods.

# Connecting Camera Directly to Printer — PictBridge Function



When a printer that supports PictBridge is available, images can be printed by connecting the camera directly to the PictBridge-compatible printer without a PC.

## Connecting to a printer

- 1 Connect the camera to your printer using the USB cable (mini-B).

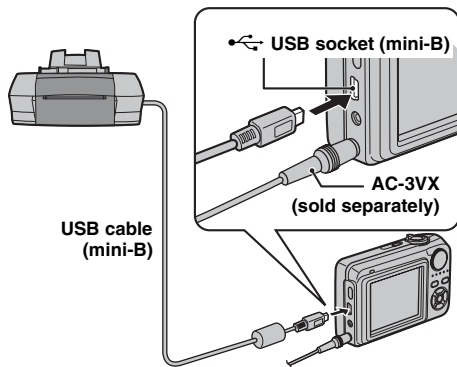

### MEMO

Use the AC-3VX (sold separately) when FinePix A610/ FinePix A800 is connected to a printer.

- 2 Connect the camera to a printer and turn the printer on. Press for about 1 second to turn the camera on.

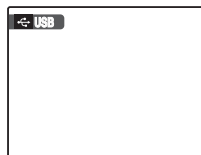

"USB" appears on the LCD monitor.

- 3 The following screen appears on the LCD monitor after a moment.

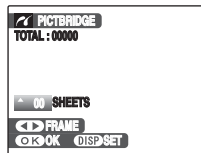

"Specifying images for printing"

→p.96

"Printing with DPOF setting"

→p.97

### MEMO

Depending on the printer, some functions are disabled.

**Continued** ➔

## Specifying images for printing (PRINT WITH DATE / PRINT WITHOUT DATE)

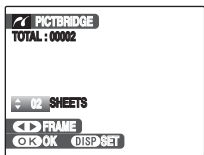

- ① Press ◀ or ▶ to display the frame (file) for specifying PRINT setting.



- ② Press ▲ or ▼ to set a value. Up to 99 sheets are printed.

To specify more PRINT settings, repeat steps ① and ②.



- ③ Press MENU/OK to display the confirm setting.

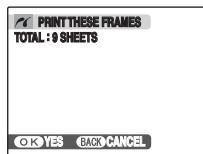

- ④ Press MENU/OK again to download the data to the printer and start printing the specified number of prints.



### MEMO

Even if MENU/OK is pressed with total number of images set at 0 (zero), the screen printing once appears on the LCD monitor. Press MENU/OK again and printing starts.



### MEMO Printing with date

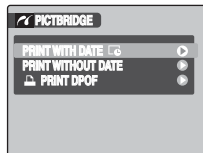

- Press DISP/BACK to display the setting display.
- Press ▲ or ▼ to select PRINT WITH DATE.
- Press MENU/OK.



### CAUTION

PRINT WITH DATE is not available when the camera is connected to a printer that does not support date printing.



## Printing with DPOF setting (PRINT DPOF)

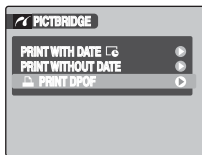

DISP/BACK



- ① Press DISP/BACK to open the menu.



- ② Press ▲ or ▼ to select PRINT DPOF.



- ③ Press MENU/OK to display the confirm setting.

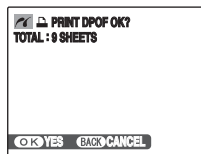

- ④ Press MENU/OK again to download the data to the printer and start printing the specified frames (files) continuously.



### CHECK

To select PRINT DPOF, the DPOF settings must be specified on FinePix A610/FinePix A800 beforehand (→p.67).



### CAUTION

Even when WITH DATE is specified in the DPOF settings (→p.67), the date is not inserted on printers that do not support date printing.

**Continued** ➔

 **MEMO**

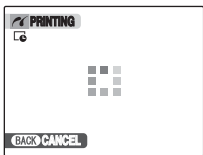

Press DISP/BACK to cancel the printing. Depending on the printer, the printing may not be canceled immediately or printing may stop midway through. When printing stops midway, briefly turn the camera off and then on again.

---

***Disconnecting the printer***

- ① Check that "PRINTING" is not displayed on the camera's LCD monitor.
  - ② Turn the camera off. Unplug the USB cable (mini-B).
- 

 **MEMO**

DPOF setting can be specified for images on internal memory.

 **CAUTION**

- In PictBridge function, images photographed on other than a camera may not be printed.
- The camera cannot be used to specify printer settings such as the paper size and print quality.
- Use internal memory or a Memory Card that was formatted on FinePix A610/FinePix A800.
- Movies cannot be printed.
- Images photographed with a camera other than FinePix A610/FinePix A800 may not be printed.



# Installation on a Windows PC

## Pre-installation checklist

### Hardware and software requirements

To run this software, you must have the hardware and software described below. Check your system before you begin the installation.

<b>Operating System</b> *1	Windows 98 SE Windows Millennium Edition (Windows Me) Windows 2000 Professional*2 Windows XP Home Edition*2 Windows XP Professional*2 Windows Vista*2
<b>CPU</b>	200 MHz Pentium minimum (Windows XP/Vista users: 800MHz Pentium 4 or better recommended)
<b>RAM</b>	128 MB minimum (512 MB minimum for Windows Vista)
<b>Hard disk space</b>	Amount required for installation: 450 MB minimum Amount required for operation: 800 MB minimum
<b>Display</b>	1024 × 768 pixels or better, 16-bit color or better
<b>Internet connection</b> *3	<ul style="list-style-type: none"><li>• To use the FinePix Internet Service or mail attachment function: An Internet connection or e-mail transmission software is needed</li><li>• Connection speed: 56 kbps or better recommended</li></ul>

\*1 Models with one of the above operating systems pre-installed.

\*2 When you install the software, login using a system administrator account (e.g. "Administrator").

\*3 Required to use the FinePix Internet Service. The software can still be installed even if you do not have an Internet connection.

### CAUTION

Note that the software to be installed is different depending on the OS. (Windows 98SE/Me: FinePixViewer, Windows 2000 Professional/XP/Vista: FinePixViewer S)

## ■ Recommended system

Operating System	Windows XP
CPU	2 GHz Pentium 4 or better recommended
RAM	512 MB or better recommended
Hard disk space	2 GB or better
Display	1024 × 768 pixels or better, Highest (32 bit)
Internet connection	Broadband (ADSL, FTTH, CATV, etc.)

## MEMO

- Connect the camera directly to the PC using the USB cable (mini-B). The software may not operate correctly when you use an extension cable or connect the camera via a USB hub.
- When your PC has more than one USB port, the camera can be connected to either port.
- Push the USB connector fully into the socket to ensure that it is securely connected. The software may not operate correctly if the connection is faulty.
- Additional USB interface board is not guaranteed.
- Windows 95, Windows NT and Windows 98 cannot be used.
- Operation is not guaranteed on home-built PCs or on PCs running updated operating system software.
- When you reinstall or remove FinePixViewer, the Internet menu and your user ID and password for the FinePix Internet Service are deleted from your PC. Enter your registered user ID and password and download the menu again.

## ■ For Windows 2000 Professional or Windows XP users

You cannot transfer images to your camera with “FinePixViewer S” installed on the above OS.

You need to use “FinePixViewer” to transfer images.

Install “FinePixViewer” as instructed below.

For information on the transfer function, refer to “How to use FinePixViewer” in the “Help” menu for details.

1. Load the bundled CD-ROM into the CD-ROM drive of your PC.
2. Double-click the “My Computer” icon. (Windows XP users should click the “My Computer” in the “Start” menu.)
3. Right-click “FINEPIX” (CD-ROM drive) in the “My Computer” window and select “Open”.
4. Double-click the folders or files in the following order: “VIEWER” → “FVIEWER” → “SETUP.EXE”
5. Double-click the folders or files in the following order: “VIEWER” → “RESOURCE” → “30000” → “SETUP.EXE”

**Do not connect the camera to your PC until the software installation is completed.**

**1 Install FinePixViewer as instructed in the Quick start guide.**

**Launching the installer manually**

- ① Double-click the "My Computer" icon.
  - \* Windows XP users should click "My Computer" in the "Start" menu.  
Windows Vista users should click "Computer" in the "Start" menu.
- ② Right-click "FINEPIX" (CD-ROM drive) in the "My Computer" window (Windows Vista users: in the "Computer" window) and select "Open".
- ③ Double-click "SETUP" or "SETUP.exe" in the CD-ROM window.



- \* The way file names are displayed differs as described below depending on your PC settings.
  - File extensions (3-letter suffixes indicating the file type) may be shown or hidden. (e.g. Setup.exe or Setup)
  - Text may be shown normally or all in uppercase (e.g. Setup or SETUP).

**✓ CHECK**

For Windows Vista users:  
When loading the bundled CD-ROM on your PC, the "AutoPlay" window may appear. In this case, click "SETUP.exe".  
When "User Account Control" window appears, click "Allow".

**Installing other applications**

You may see messages for installing Windows Media Player. Install this application as directed by the on-screen instructions.

**2 Install DirectX as directed by the on-screen instructions and then restart your PC. If the latest version of DirectX is already installed on your PC, this installation is not performed.**

**! CAUTION**

- If the latest version is already installed, this window does not appear.
- Do not remove the CD-ROM during this procedure.

**3 After restarting the PC, a message appears stating "Installation of the FinePixViewer has been completed".**

# Installation on a Mac OS X

## Pre-installation checklist

### Hardware and software requirements

To run this software, you must have the hardware and software described below. Check your system before you begin the installation.

<b>Compatible Mac</b> *1	Power Macintosh G3*2, PowerBook G3*2, Power Macintosh G4, iMac, iBook, Power Macintosh G4 Cube, PowerBook G4, Power Macintosh G5, MacBook, MacBook Pro or Mac Mini
<b>Operating System</b>	Mac OS X (compatible with version 10.3.9 to 10.4.8)
<b>RAM</b>	256 MB or better recommended
<b>Hard disk space</b>	Amount required for installation: 200 MB minimum Amount required for operation: 400 MB minimum
<b>Display</b>	800 × 600 pixels or better, at least 32,000 colors
<b>Internet connection</b> *3	<ul style="list-style-type: none"><li>• To use the FinePix Internet Service or mail attachment function: An Internet connection or e-mail transmission software is needed</li><li>• Connection speed: 56 kbps or better recommended</li></ul>

\*1 PowerPC, Intel processor loaded

\*2 Models with a USB port as a standard feature

\*3 Required to use the FinePix Internet Service. The software can still be installed even if you do not have an Internet connection.

### CAUTION

- Connect the camera directly to the Macintosh using the USB cable (mini-B). The software may not operate correctly if you use an extension cable or connect the camera via a USB hub.
- Push the USB connector fully into the socket to ensure that it is securely connected. The software may not operate correctly if the connection is faulty.
- Additional USB interface board is not guaranteed.

**Continued** ➔

- 1 Turn your Macintosh on and start up Mac OS X. Do not launch any other applications.**
- 2 When the bundled CD-ROM is loaded into the CD-ROM drive, the “FinePix” icon appears. Double-click the “FinePix” icon to open the “FinePix” volume window.**
- 3 Double-click on “Installer for MacOSX”.**
- 4 The Installer setup dialog appears. Click the [Installing FinePixViewer] button.**

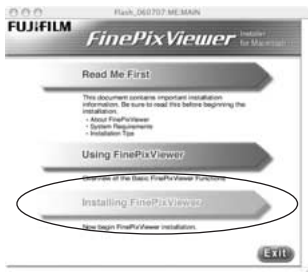

**!** **CAUTION**  
For more information on what is installed, click the [Read Me First] button and [Using FinePixViewer] button.

- 5 The “Authenticate” dialog appears. Enter the name and password for the administrator account and then click the [OK] button.\***

\* The administrator account is the user account used for Mac OS X installation and you can confirm the user account in the Accounts dialog in the System Preferences.

- 6 The “License” dialog appears. Read the agreement carefully and then, if you agree to the terms of the Agreement, click the [Accept] button.**

- 7 The “Read me” dialog appears. Click the [Continue] button.**

- 8 The “FinePixInstallOSX” window appears. Click the [Install] button to install FinePixViewer.**

- 9 The “FinePixViewer installation completed” message dialog appears. Then click exit button and close it.**

**!** **CAUTION**  
When Safari is used as the Web browser, a message may be displayed and the CD-ROM may not be removed. If this happens, click the Safari icon in the Dock to make Safari the active application and then select “Quit Safari” in the “Safari” menu to shut down Safari.



**10** Launch “Image Capture” from the “Applications” folder.

**11** Change the Image Capture settings. Select “Preferences...” from the “Image Capture” menu.



**12** Select “Other...” from “When a camera is connected, open”.

**13** Select “FPVBridge” from “FinePixViewer” folder in the “Applications” folder and click the [Open] button.



**14** Select “Quit Image Capture” menu in the “Image Capture” menu.

# Connecting to a PC

By connecting the camera to a PC, your system can be expanded to fill a wide range of uses. Using "FinePixViewer" performs images saving, browsing and file management etc.

## MEMO

If the power cuts out during data transmission, the data will not be transmitted correctly. Always use the AC power adapter when connecting the camera to a PC.

## Refer to Software Installation (→p.100, 103) the first time you connect the camera to your PC.

Install the software first. Do not connect the camera to the PC before installing all the software.



CD-ROM  
(Software for FinePix)

- 1 Insert the Memory Card with images into the camera (→p.19).

You can use the **xD-Picture Card** and the SD Memory Card with the FinePix A610 and FinePix A800. In this Owner's Manual, these cards are expressed as "Memory Card".

## CAUTION

- Do not format the Memory Card in the camera on the PC.
  - Use the Memory Card with images taken by a FUJIFILM Digital camera.
  - When connecting to a PC, if the Memory Card contains large image or movie files, connection or transmission may take time or images may not be stored. In these cases, use the Image Memory Card Reader (sold separately), etc. Note that the Image Memory Card Reader DPC-R1 is not compatible with the SD Memory Card.
- 2 Connect the camera to your PC using the USB cable (mini-B).

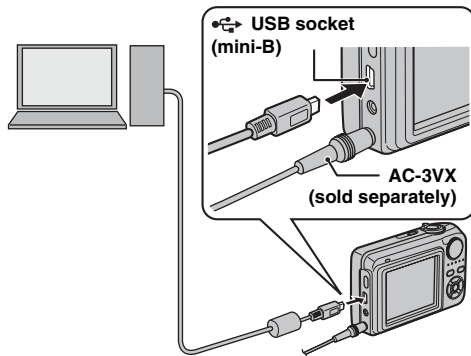

- 3 Press  for about 1 second to turn the camera on in Playback mode.

## ! CAUTION

- FinePix A610/FinePix A800 is compatible with PTP (Picture Transfer Protocol)/MTP (Media Transfer Protocol). A PTP/MTP-compatible camera is a camera which can recognize the PC and printer automatically when connected.
- Always use the FUJIFILM AC Power Adapter AC-3VX (sold separately). If the camera suddenly loses power during data exchange, the Memory Card or internal memory could be damaged.
- Do not disconnect the USB cable (mini-B) when the camera is communicating with a PC. If disconnecting the USB cable (mini-B) during communication, the files on the Memory Card or internal memory may cause damage.
- In Mac OS X, you must set the automatic setup when the first time you connect the camera to your PC.
- Make sure that USB cable (mini-B) is connected correctly and pushed in.
- Perform pre-arranged steps to disconnect and turn off the camera (→p.109).
- When the camera and PC are exchanging data, the indicator lamp blinks alternately green and orange.
- Auto power off is disabled during PC connection.
- Before replacing the Memory Card, always disconnect the camera from the PC. See p.109 for information on the disconnection procedure.
- The camera and PC may be exchanging data even when "Copying" disappears on your PC screen. Before disconnecting the USB cable (mini-B), always check that the indicator lamp is off.

## ④ Set a PC.

### Windows 98 SE / Me / Macintosh

## ! CAUTION

The Windows CD-ROM may also be required during installation. In this event, change CD-ROMs as directed by the on-screen instructions.

- FinePixViewer automatically starts up and the Save Image Wizard window (Save Image dialog box) appears. Follow the instructions provided on screen to save the images. To proceed without saving the images, click the [Cancel] button.



## 📄 MEMO

- You can only see images saved on a PC. Save images on a PC.
- If you cancel saving by clicking the [Cancel] button, press POWER to turn off the camera and then disconnect it from the PC.

## Windows 2000 Professional

### ! CAUTION

The Windows CD-ROM may also be required during installation. In this event, change CD-ROMs as directed by the on-screen instructions.



FinePixViewer S automatically starts up and the Load Photos window appears. Follow the instructions provided on screen to save the images. To proceed without saving the images, click the [Cancel] button.

### MEMO

- You can only see images saved on a PC. Save images on a PC.
- If you cancel saving by clicking the [Cancel] button, press POWER to turn off the camera and then disconnect it from the PC.

## Windows XP / Vista

- ① The help message appears in the bottom-right corner of your screen. This message will close when the settings are completed. No action is required.

### ! CAUTION

This step is not required for subsequent connections.



- ② FinePixViewer S automatically starts up and the Load Photos window appears. Follow the instructions provided on screen to save the images. To proceed without saving the images, click the [Cancel] button.

### MEMO

- You can only see images saved on a PC. Save images on a PC.
- If you cancel saving by clicking the [Cancel] button, press POWER to turn off the camera and then disconnect it from the PC.

Proceed to "Using FinePixViewer" (→p.110).

## Disconnecting the camera

### 1 Windows 98 SE / Me

Once the image has been saved, the window below appears (Save Image Wizard window). To disconnect the camera, click the [Remove] button.



### Windows 2000 Professional / XP / Vista

Once the image has been saved, the window below appears.



### Macintosh

Once the image has been saved, the window below appears. To disconnect the camera, click the [OK] button.

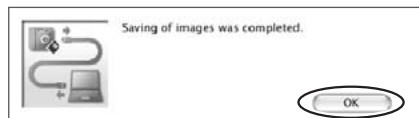

**Continued** →

- 2 ① Press POWER to turn the camera off.

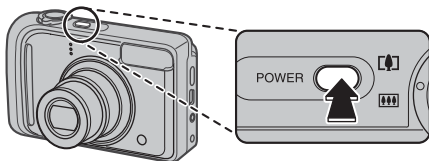

- ② Unplug the USB cable (mini-B) from the camera.

## Using FinePixViewer

### Mastering FinePixViewer

For all information on FinePixViewer functions, refer to “How to Use FinePixViewer” in the Help menu for details.

- **What is explained in “How to Use FinePixViewer”...** “How to Use FinePixViewer” covers a range of topics, including batch processing and ordering prints.

## Uninstalling the software

Only perform this operation when you no longer require the installed software or when the software was not installed correctly.

### Windows

- ① Check that the camera is not connected to the PC.
- ② Quit all currently running applications.
- ③ Open the "My Computer" (Windows XP/Vista users should click "Control Panel" in the "Start" menu.) window. Then open the "Control Panel" (Windows Vista users: open the "Programs") and double-click on "Add/Remove Programs" (Windows Vista users: "Programs and Features").



- ④ The "Add or Remove Programs" (Windows Vista users: "Programs and Features") window appears. Select the software to be uninstalled (FinePixViewer S, FinePixViewer or the driver) and then click the [Change/Remove] button (Windows Vista users: [Uninstall/Change] button).

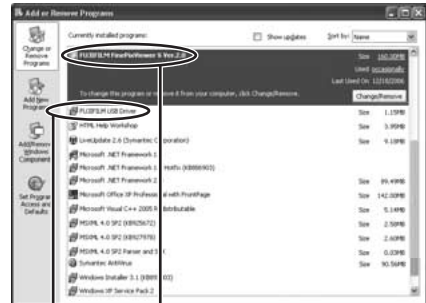

To remove FinePixViewer

 FUJIFILM FinePixViewer S Ver.2.0

To remove the driver software

 FUJIFILM USB Driver

**Continued** →

- ⑤ When the message appears, click the [OK] button.  
Check your selection carefully since the process cannot be canceled once you click the [OK] button.



- ⑥ Automatic uninstallation begins.  
When uninstallation ends, click the [OK] button.

### **Macintosh**

Quit FinePixViewer. Then drag the installed FinePixViewer folder to the Trash and select "Empty Trash" in the "Finder" menu.



# System Expansion Option

By using FinePix A610/FinePix A800 together with other optional FUJIFILM products, your system can be expanded to fill a wide range of uses.

Accessory availability may vary by country. Please check with your local Fujifilm representative to confirm product availability.

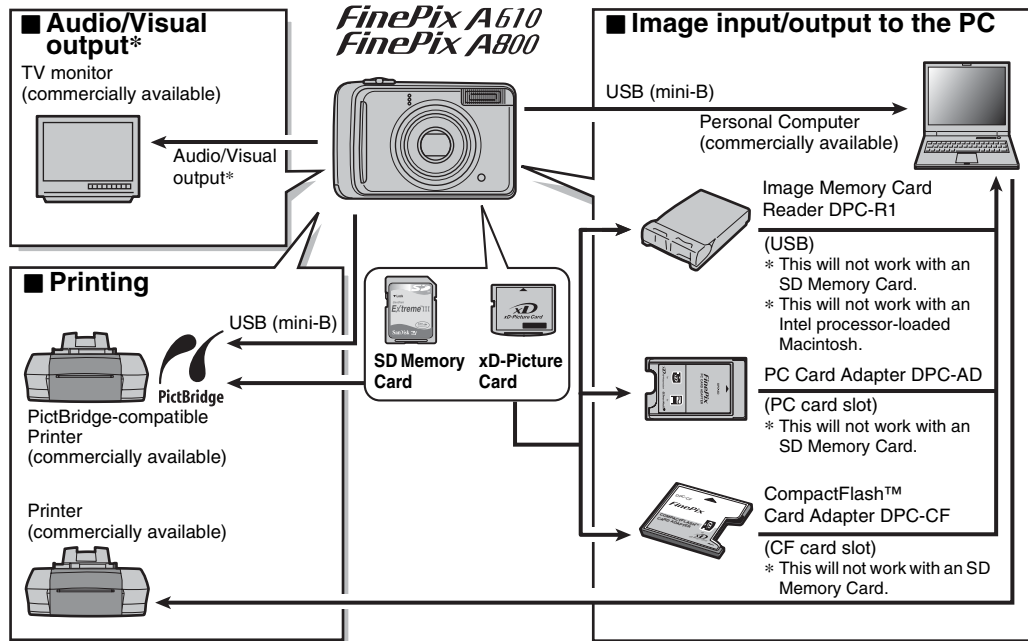

# Accessories Guide

Visit the FUJIFILM web site for the latest information on camera accessories.

<http://www.fujifilm.com/products/digital/index.html>

Accessory availability may vary by country. Please check with your local Fujifilm representative to confirm product availability.

## • **xD-Picture Card**

Use the following **xD-Picture Cards**:

16MB/32MB/64MB/128MB/256MB/512MB/1GB/2GB

There are two types of **xD-Picture Card**: standard type and Type M (containing "M" in the model number, such as DPC-M2GB).

FinePix A610/FinePix A800 is compatible with Type M, however they may not be compatible depending on the device used (Image Memory Card Reader, etc.).



## • **AC Power Adapter AC-3VX**

Use the AC-3VX when taking pictures or play back images for long periods or when FinePix A610/FinePix A800 is connected to a PC.

\* The shape of the AC power adapter, the plug, and power outlet depend on the country.

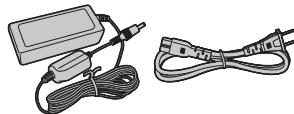

## • **Soft Case SC-FXA04**

This is a special case made of polyurethane that protects the camera against soil, dust, and minor impacts when it is being carried.

- **Image Memory Card Reader DPC-R1**

The DPC-R1 provides a quick and easy way to transfer images back and forth between your PC and an image memory card (**xD-Picture Card** and SmartMedia). The DPC-R1 uses the USB interface for high-speed file transfer.

\*This will not work with an Intel processor-loaded Macintosh.

-Compatible with **xD-Picture Card** of 16 MB to 512 MB, and SmartMedia of 3.3 V, 4 MB to 128 MB.



- **PC Card Adapter DPC-AD**

The PC Card Adapter allows the **xD-Picture Card** and SmartMedia to be used as a PC Card Standard ATA-compliant (PCMCIA 2.1) PC card (Type II).

-Compatible with **xD-Picture Card** of 16 MB to 512 MB, and SmartMedia of 3.3 V, 2 MB to 128 MB.



- **CompactFlash™ Card Adapter DPC-CF**

Loading an **xD-Picture Card** into this adapter allows you to use the card as a CompactFlash card (Type I).



- **Waterproof Case WP-FXA800**

This waterproof case protects your FinePix A610/FinePix A800 from water damage yet allows you to make camera adjustments and use the flash.

Dive up to 3 meters (9.8 feet) underwater with your FinePix A610/FinePix A800 digital camera.

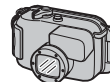

# Using Your Camera Correctly

Read this information and the “Safety Notes” (→p.158), to make sure you use your camera correctly.

## ■ Places to Avoid

Do not store or use the camera in the following types of locations:

- In the rain or in very humid, dirty, or dusty places
- In direct sunlight or in places subject to extreme temperature rises, such as in a closed car in summer
- Extremely cold places
- Places with strong vibration
- Places with smoke or steam
- Places subject to strong magnetic fields (such as near motors, transformers, or magnets)
- In contact with chemicals such as pesticides
- Next to rubber or vinyl products

## ■ Damaged by Water or Sand

FinePix A610/FinePix A800 can be damaged on the inside and outside by water and sand. When you are at the beach or close to water, make sure that the camera is not damaged by water or sand. Take care not to place the camera on a wet surface.

## ■ Damaged by Condensation

If the camera is carried from a cold location into a warm place, water droplets (condensation) may form on the inside of the camera or on the lens. When this occurs, turn the camera off and wait an hour before using the camera. Condensation may also form on the Memory Card. In this event, remove the Memory Card and wait a short time.

## ■ When the Camera is Not Used or is stored Periods of Time

If you do not intend to use the camera for a long period of time, remove the batteries and the Memory Card.

## ■ Cleaning Your Camera

- Use a blower brush to remove any dust on the lens or LCD monitor, and then gently wipe the camera with a soft, dry cloth. If any soil remains, apply a small amount of lens cleaning liquid to a piece of FUJIFILM lens cleaning paper and wipe gently.
- Do not scratch hard objects against the lens or LCD monitor.
- Clean the body of the camera with a soft, dry cloth. Do not use volatile substances or cleaning products these items can cause damage.

## ■ Using the Camera When Traveling

When traveling overseas, do not place your camera in the check-in baggage. Baggage can be subjected to violent shocks, and the camera may be damaged inside or outside.

# Power Supply and Batteries

## Applicable Batteries

- In the camera, use AA-size alkaline or Ni-MH (nickel-metal hydride) rechargeable batteries. Do not use AA-size manganese, nickel-cadmium (Ni-Cd) or lithium batteries in your FinePix A610/FinePix A800 because the heat created by the batteries could damage the camera or cause it not to work.
- The life of alkaline batteries varies between brands. The life of batteries you purchase may be shorter than those provided with the camera.

## Notes on the Batteries

Incorrect use of the batteries could cause them to leak, become hot, ignite, or burst. Always observe the precautions given below.

- Do not heat the batteries or throw them into a fire.
- Do not carry or store batteries with metal objects such as necklaces or hairpins.
- Do not expose the batteries to water, and keep batteries from getting wet or stored in moist locations.
- Do not attempt to take apart or change the batteries, including battery casings.
- Do not subject the batteries to strong impacts.
- Do not use batteries that are leaking, deformed, discolored.
- Do not store batteries in warm or humid places.
- Keep the batteries out of reach of babies and small children.
- Make sure that the battery polarity ( $\oplus$  and  $\ominus$ ) is correct.
- Do not use new with used batteries. Do not use charged and discharged batteries together.
- Do not use different types or brands of batteries at the same time.

- If you do not intend to use the camera for a long period of time, remove the batteries from the camera. Note if the camera is left with the batteries removed, the time and date settings are cleared.
- The batteries feel warm right after being used. Before removing the batteries, turn the camera off and wait for the batteries to cool down.
- Since batteries do not work well in cold weather or locations, warm the batteries by placing them inside your garments before use. Batteries do not work well when cold. They will work again when the temperature returns to normal.
- Soil (such as fingerprints) on the battery terminals makes the batteries charge less reducing the number of images. Carefully wipe the battery terminals with a soft dry cloth before loading.



If any liquid at all leaks from the batteries, wipe the battery compartment thoroughly and then load new batteries.



If any battery fluid comes into contact with your hands or clothing, flush the area thoroughly with water. Note that battery fluid can cause loss of eyesight if it gets into your eyes. If this occurs, do not rub your eyes. Flush the fluid out with clean water and contact your physician for treatment.

**Continued** ➔

### Using the AA-size Ni-MH batteries correctly

- As a power source in digital cameras, AA-size Ni-MH batteries (referred to hereafter as Ni-MH batteries) are superior to alkaline batteries in several ways, such as allowing more shots to be taken with the camera. However, care must be taken with the way Ni-MH batteries are used if their original performance is to be maintained.
- Ni-MH batteries left unused in storage for long periods can become “deactivated”. Also, repeatedly charging Ni-MH batteries that are only partially discharged can cause them to suffer from the “memory effect”. Ni-MH batteries that are “deactivated” or affected by “memory” suffer from the problem of only providing power for a short time after being charged. To prevent this problem, discharge and recharge them several times using the camera’s “Discharging rechargeable batteries” function. By repeating this cycle several times, the temporary reduction in performance caused by “memory” or “deactivation” can be remedied and the batteries can be restored to their original performance levels.

Deactivation and memory are specific to Ni-MH batteries and are not in fact battery faults. See p.119-121 for the procedure for “Discharging rechargeable batteries”.

#### CAUTION

Do not use the “Discharging rechargeable batteries” function when alkaline batteries being used.

- To charge Ni-MH batteries, use the quick battery charger (sold separately). Refer to the instructions supplied with the charger to make sure that the charger is used correctly.
- Do not use the battery charger to charge other batteries.
- Note that the batteries feel warm after being charged.
- Due to the way the camera is constructed, a small amount of current is used even when the camera is turned off. Note in particular that leaving Ni-MH batteries in the camera for a long period will overdischarge the batteries and may render them unusable even after recharging.
- Ni-MH batteries will self-discharge even when not used, and the time for which they can be used may be shortened as a result.
- Ni-MH batteries will deteriorate rapidly if overdischarged (e.g. by discharging the batteries in a flashlight). Use the “Discharging rechargeable batteries” function provided in the camera to discharge the batteries.
- Ni-MH batteries have a limited service life. If a battery can only be used for a short time even after repeated discharge-charge cycles, it may have reached the end of its service life.

#### Disposing of Batteries

When disposing of batteries, do so in accordance with your local waste disposal regulations.

## AC Power Adapter

Always use the AC Power Adapter AC-3VX with the camera.

The use of an AC power adapter other than AC-3VX can be damaged to your digital camera.

- Use the AC power adapter for indoor use only.
- Plug the connection cord plug securely into the DC input terminal of the FUJIFILM Digital camera.
- Turn off the FUJIFILM Digital camera before disconnecting the cord from the FUJIFILM Digital camera's DC input terminal. To disconnect, pull out the plug gently. Do not pull on the cord.
- Do not use the AC power adapter with any device other than your camera.
- During use, the AC power adapter will become hot to the touch. This is normal.
- Do not take apart the AC power adapter. Doing so could be dangerous.
- Do not use the AC power adapter in a hot and humid place.
- Do not subject the AC power adapter to strong shocks.
- The AC power adapter may emit a humming. This is normal.
- If used near a radio, the AC power adapter may cause static. If this happens, move the camera away from the radio.
- Do not connect the AC power adapter to charge the AA-size Ni-MH (nickel-metal hydride) batteries. Use the optional charger to charge the Ni-MH batteries.



## Discharging rechargeable batteries

The Discharging rechargeable batteries function can only be used with Ni-MH batteries.

The Discharging rechargeable batteries function should not be used with alkaline batteries as it will completely drain the battery charge.

Use the Discharging rechargeable batteries function in the following situations:

- When the batteries only last for a short time after being charged normally
- When the batteries have not been used for a long period
- When you purchase new Ni-MH batteries

Do not use the Discharging rechargeable batteries function while using the AC power adapter. In these situations, the Ni-MH batteries will not be discharged due to the external power supply.

**Continued** ➔



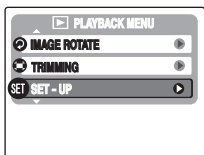

To discharge rechargeable batteries:

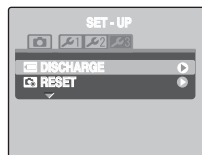









\* FinePix A800



\* FinePix A800

- 1 Press  for about 1 second to turn the camera on.
- 2 Press MENU/OK to open the menu.
- 3 Press  or  to select  SET-UP.
- 4 Press  to open the SET-UP menu.

- 5 Press  or  to select  3 (Select  2 on the FinePix A610.).
- 6 Press  or  to select  DISCHARGE.
- 7 Press .

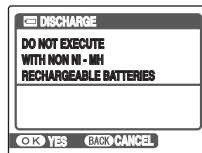

- 8 Press MENU/OK.



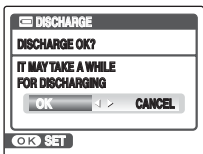

9 Press ◀ or ▶ to select OK.



10 The screen changes and discharging begins.  
When the battery level indicator blinks red and discharging ends, the camera turns off.

**!** **CAUTION**

To cancel discharging, press DISP/BACK.

# Notes on the xD-Picture Card™, the SD Memory Card and the Internal Memory

## ■ Handling Memory Card

- When inserting the Memory Card into the camera, hold the Memory Card straight as you push it in.
- Never remove the Memory Card or turn the camera off during data recording or erasing (Memory Card formatting) as this could be damaged to the Memory Card.
- The use of **xD-Picture Cards** is recommended with FinePix A610/FinePix A800. The recording quality cannot be guaranteed when **xD-Picture Cards** other than those manufactured by FUJIFILM are used.
- The Memory Card may feel warm when it is removed from the camera after taking pictures. This is normal.
- Do not put labels on the Memory Card. Peeling labels can cause the camera not to work properly.



## MEMO Type M and H of xD-Picture Card

- Type M  
There are two types of **xD-Picture Card**: standard type and Type M (containing “M” in the model number, such as DPC-M2GB).  
FinePix A610/FinePix A800 is compatible with Type M.
- Type H  
While Type H and M share the same compatibility.
- Usable USB drive  
Type H cannot be used with **xD-Picture Card** USB drive DPC-UD1, while Type M can.

## ■ Internal Memory

- Images held in the camera's internal memory may be corrupted or erased due to problems such as camera faults. Save your important data to another media (i.e., DVD-R, CD-R, CD-RW, hard disk, etc.).
- Data stored in the camera's internal memory cannot be guaranteed in the event that the camera is submitted for repairs.
- When the camera is repaired, any data stored in the camera's internal memory is subject to checking by the repairer.





## ■ Using Memory Card or Internal Memory with a PC





- When taking pictures using a Memory Card or internal memory that has been used on a PC, reformat the Memory Card using your camera.
- When formatting, a directory (folder) is created. Image data is then recorded in this directory.
- Do not change or delete the directory (folder) or file names on the Memory Card or internal memory because this will make it impossible to use the Memory Card or internal memory in your camera.
- Always use the camera to erase image data.
- To edit image data, copy or transfer the image data to the PC and edit the copied or transferred data.



# Warning Displays





The table below lists the warnings that are displayed on the LCD monitor.

Warning Displayed	Explanation	Remedy
 (Lit red)  (Blinking red)	The batteries are low or completely out of charge.	Load new or fully charged batteries.
	There is a strong likelihood of camera shake because the shutter speed is slow.	Use flash photography. A tripod may be recommended, depending on the scene and mode.
	The AF (autofocus) cannot work effectively.	<ul style="list-style-type: none"> <li>• If the image is too dark, take the picture at a distance of around 2 m (6.6 ft.) from the subject.</li> <li>• Use AF lock to take the picture (→p.31).</li> <li>• Select Macro mode when taking close-up shots.</li> </ul>
	The camera cannot shoot the picture at the correct brightness due to too bright or dark shooting condition.	The picture can be taken, but the correct brightness (exposure) will not be obtained.
<b>FOCUS ERROR</b>  <b>ZOOM ERROR</b>	Camera malfunction or fault.	<ul style="list-style-type: none"> <li>• Turn the camera on again, taking care not to touch the lens.</li> <li>• Turn the camera off and on again. If the message still appears, contact your FUJIFILM dealer.</li> </ul>
<b>NO CARD</b>	Memory Card is not inserted when transferring images.	Insert a Memory Card.
<b>CARD NOT INITIALIZED</b>	<ul style="list-style-type: none"> <li>• The Memory Card or internal memory is not formatted.</li> <li>• The Memory Card was formatted on a PC.</li> <li>• The Memory Card contact area is soiled.</li> </ul> <ul style="list-style-type: none"> <li>• Camera fault.</li> </ul>	<ul style="list-style-type: none"> <li>• Format the Memory Card or internal memory on the camera (→p.89).</li> <li>• Format the Memory Card on the camera.</li> <li>• Wipe the contact area on the Memory Card with a soft, dry cloth. It may be necessary to format the Memory Card (→p.89). If the message still appears, replace the Memory Card.</li> <li>• Contact your FUJIFILM dealer.</li> </ul>

Warning Displayed	Explanation	Remedy
<b>CARD ERROR</b>	<ul style="list-style-type: none"> <li>• The Memory Card contact area is soiled.</li> <li>• The Memory Card format is incorrect.</li> <li>• Camera fault.</li> <li>• The Memory Card is damaged.</li> <li>• Inserted Memory Card is not compatible with your camera.</li> </ul>	<ul style="list-style-type: none"> <li>• Wipe the contact area on the Memory Card with a soft, dry cloth. It may be necessary to format the Memory Card (→p.89). If the message still appears, replace the Memory Card.</li> <li>• Contact your FUJIFILM dealer.</li> <li>• Insert a compatible Memory Card that is operation-checked at FUJIFILM Corporation (→p.19).</li> </ul>
 <b>MEMORY FULL</b>  <b>MEMORY FULL</b>	The internal memory or Memory Card is full.	Erase some images in internal memory or Memory Card (→p.38), or use a Memory Card that has ample free space.
<b>WRITE ERROR</b>	<ul style="list-style-type: none"> <li>• The data could not be recorded due to a Memory Card error or a connection error between the Memory Card and camera.</li> <li>• The image cannot be recorded as it is too large to fit in the available space on the Memory Card.</li> <li>• The Memory Card or internal memory is not formatted.</li> </ul>	<ul style="list-style-type: none"> <li>• Re-insert the Memory Card or turn the camera off and then on again. If the message still appears, contact your FUJIFILM dealer.</li> <li>• Use a new Memory Card.</li> <li>• Format the Memory Card or internal memory on the camera (→p.89).</li> </ul>
<b>PROTECTED CARD</b>	The SD Memory Card switch is slide to the “Lock” side.	Unlock the protection by sliding it back (→p.20).
<b>INTERNAL MEMORY IS FULL</b> <b>INSERT A NEW CARD</b>	The data could not be recorded or copied since the internal memory is full.	Erase some images from the internal memory (→p.38), or use a Memory Card that has ample free space.
<b>BUSY</b>	The timing for recording was incorrect because the Memory Card was formatted on a PC.	Use a Memory Card that was formatted on the camera.
<b>FRAME NO. FULL</b>	The frame number has reached 999-9999.	<ol style="list-style-type: none"> <li>① Insert a formatted Memory Card into the camera.</li> <li>② Set RENEW as the FRAME NO. setting in the  SET-UP menu (→p.86).</li> <li>③ Start taking pictures (The frame number starts from “100-0001”).</li> <li>④ Set CONT. as the FRAME NO. setting in the  SET-UP menu.</li> </ol>

Continued ➔

## Warning Displays

Warning Displayed	Explanation	Remedy
<b>READ ERROR</b>	<ul style="list-style-type: none"> <li>• The played back file was not recorded correctly.</li> <li>• The Memory Card contact area is soiled.</li> <li>• Camera fault.</li> <li>• An attempt was made to play back the image or the movie that was not recorded on this camera.</li> </ul>	<ul style="list-style-type: none"> <li>• This file cannot be played back.</li> <li>• Wipe the contact area on the Memory Card with a soft, dry cloth. It may be necessary to format the Memory Card (→p.89). If the message still appears, replace the Memory Card.</li> <li>• Contact your FUJIFILM dealer.</li> <li>• The movie and image cannot be played back.</li> </ul>
<b>TOO MANY FRAMES</b>	An attempt was made to show 5,000 or more image by date sorting.	No more than 4,999 images can be shown by date sorting.
<b>PROTECTED FRAME</b>	<ul style="list-style-type: none"> <li>• An attempt was made to erase a protected file.</li> <li>• An attempt was made to rotate a protected file.</li> </ul>	<ul style="list-style-type: none"> <li>• Protected files cannot be erased. Remove the protection (→p.71).</li> <li>• Protected files cannot be rotated. Remove the protection (→p.71).</li> </ul>
 <b>NO IMAGE</b>  <b>NO IMAGE</b>	An attempt was made to transfer images from the Memory Card or internal memory that memory was empty.	It is impossible to copy.
 <b>CAN NOT TRIM (FinePix A800 only)</b>	An attempt was made to trim a 0.3M image.	The image cannot be trimmed.
<b>CAN NOT TRIM (FinePix A800 only)</b>	<ul style="list-style-type: none"> <li>• An attempt was made to trim an image shot using a camera other than FinePix A800.</li> <li>• The image is damaged.</li> </ul>	The image cannot be trimmed.
<b>DPOF FILE ERROR</b>	Prints were specified for 1000 or more frames in the DPOF frame settings.	The maximum number of frames for which prints can be specified on the same Memory Card is 999. Copy the images for which you want to order prints onto another Memory Card and then specify the DPOF settings.
 <b>CAN NOT SET DPOF</b>  <b>CAN NOT SET DPOF</b>	An attempt was made to specify DPOF settings for a movie or an image that is not supported by DPOF.	DPOF printing cannot be used with this image format.

Warning Displayed	Explanation	Remedy
<b>CAN NOT ROTATE</b>  <b>CAN NOT ROTATE</b>	An attempt was made to rotate a movie or an image shot using a camera other than FinePix A610/ FinePix A800.	These images cannot be rotated by image formats.
<b>COMMUNICATION ERROR</b>	The camera is not connected to a PC or printer.	<ul style="list-style-type: none"> <li>• Check that the USB cable (mini-B) is connected correctly.</li> <li>• Check that your PC or printer is turned on.</li> </ul>
<b>PRINTER ERROR</b>	Displayed for PictBridge.	<ul style="list-style-type: none"> <li>• Check that the printer is not out of paper or out of ink.</li> <li>• Turn the printer off briefly and then turn it back on.</li> <li>• Refer to the user manual supplied with your printer.</li> </ul>
<b>PRINTER ERROR RESUME?</b>	Displayed for PictBridge.	Check that the printer is not out of paper or out of ink. Printing automatically restarts when the error is cleared. If the message still appears after checking, press MENU/OK to restart printing.
<b>CANNOT BE PRINTED</b>	Displayed for PictBridge.	<ul style="list-style-type: none"> <li>• Refer to the user manual for the printer being used and check whether the printer supports the JFIF-JPEG or Exif-JPEG image format. If not, the printer cannot print the images.</li> <li>• Movie images cannot be printed.</li> <li>• Was the image data photographed using FinePix A610/FinePix A800? You may not be able to print some images photographed on other cameras.</li> </ul>





# Troubleshooting

## ■ Getting ready











Matters	Problems	Possible causes	Solutions	Page
Batteries and power supply	Nothing happens when pressing POWER.	The batteries have run out.	Load new or fully charged batteries.	16, 18, 117
		The batteries are loaded backward.	Load the batteries in the correct direction.	17
		The battery cover is not closed securely.	Close the battery cover securely.	17
	Batteries run out quickly.	The camera and AC power adapter are not connected correctly.	Connect the camera and AC power adapter correctly.	93, 94, 119
		Camera is used in extremely cold conditions.	Put the batteries in your pocket or another warm place to heat it and then load it into the camera just before you take a picture.	16, 18, 117
		The battery terminals are soiled.	Wipe the battery terminals with a clean, dry cloth.	18, 117
		Same batteries have been used for a long period.	The batteries can no longer be recharged. Load new batteries.	16, 18, 117
	Power cuts out during operation.	The rechargeable batteries (if used) have become deactivated, or the battery capacity has diminished due to the memory effect.	Use the rechargeable battery discharging function to restore the rechargeable batteries to full capacity.	119
		The batteries have run out.	Load new or fully charged batteries.	16, 18, 117
		The AC power adapter plug has come out of the power outlet.	Plug the adapter back in.	93, 94, 119





















## ■ Setting menu etc.

Matters	Problems	Possible causes	Solutions	Page
LCD monitor display	Screens are not displayed in English.	A language other than English is selected in the 言語/LANG. setting in the SET-UP menu.	Select ENGLISH.	26

Continued ➔

**■ Shooting**

Matters	Problems	Possible causes	Solutions	Page
Basic operations	No photograph is taken when pressing the shutter button.	The Memory Card or internal memory is full.	Insert a new Memory Card or erase some unnecessary frames.	19, 38
		The Memory Card or internal memory is not formatted.	Format the Memory Card or internal memory on the camera.	83, 89
		The Memory Card contact area is soiled.	Wipe the Memory Card contact area with a soft, dry cloth.	19
		The Memory Card is damaged.	Insert a new Memory Card.	19
		The batteries have run out.	Load new or fully charged batteries.	16, 18, 117
		The Auto power off function has turned the camera off.	Turn the camera on.	22, 90
	The LCD monitor darkens after taking a picture.	You took pictures with flash.	The LCD monitor may darken for charging flash. Wait a short time.	53
Focusing	Camera has difficulty in focusing on the subject.	You took a close-up shot without selecting Macro mode.	Select Macro mode.	51
		You photographed scenery with Macro mode selected.	Cancel Macro mode.	51
		You are shooting a subject that is not suited to autofocus (→p.32).	Use AF/AE lock to take the picture.	31
Macro	Cannot set the camera to Macro (close-up) mode.	The Shooting mode is set to  ,  ,  ,  ,  ,  ,  ,  ,  , or  .	Change the Shooting mode.	43, 44

Matters	Problems	Possible causes	Solutions	Page
Flash	Cannot use the flash.	The shutter button was pressed while the flash was charging.	Wait until the charging is completed before pressing the shutter button.	53
		The Shooting mode is set to  ,  ,  ,  ,  , or  .	Change the Shooting mode.	43, 44
		The batteries have run out.	Load new or fully charged batteries.	16, 18, 117
		The flash is set to  SUPPRESSED FLASH mode.	Set to another flash mode excluding the  SUPPRESSED FLASH mode.	52
	The flash settings are restricted and cannot be selected.	The Shooting mode is set to AUTO,  ,  ,  ,  ,  ,  ,  ,  ,  ,  ,  or  .	The flash settings are restricted because the camera settings are tailored to the scene being shot. Change the Shooting mode for a wider range of flash settings.	43, 44, 53
	The playback image is dark even though the flash was used.	The subject is too far away. Your finger was covering the flash.	Move to within the effective flash range before taking the picture. Hold the camera correctly.	51, 53 27
Photographed images	The image is blurred.	The lens is dirty.	Clean the lens.	116
		<b>!AF</b> appeared when taking pictures.	Check the focus on the subject and take pictures.	29, 31, 124
		<b>!👉</b> appeared when taking pictures.	It may cause camera shake. Hold the camera steadily.	30, 124
	There is speckling on the image.	The picture was taken with a slow shutter speed (long exposure) in a high-temperature environment.	This is a characteristic of CCDs and does not indicate a camera fault.	-

Continued ➡

■ Shooting

Matters	Problems	Possible causes	Solutions	Page
Recording images	Photographed images or movies are not recorded.	AC power adapter was connected or disconnected during turning the camera on.	Connect or disconnect the AC power adapter only when the camera is off. Failing to turn the camera off first can result in damage to the Memory Card or malfunctions during PC connection.	93, 94, 119

■ Playing back

Matters	Problems	Possible causes	Solutions	Page
Playing back movie	The camera does not emit any sound.	The camera volume is set too low.	Adjust the volume.	82, 83, 88
		The microphone was blocked during shooting/recording.	Take care not to block the microphone during shooting/recording.	14, 80
		There is something covering the speaker during playback.	Make sure that the speaker is uncovered.	14, 82
Erasing	Erasing FRAME does not erase the frame.	Some frames may be protected.	Unprotect frames using the camera on which the protection was first applied.	71
	Erasing ALL FRAMES does not erase all the frames.			
Frame No.	CONT. in the frame number setting does not function.	You opened the battery cover without turning the camera off when replacing the batteries or Memory Card.	Always turn the camera off when replacing the batteries or Memory Card. Opening the battery cover without turning the camera off may cause the frame number memory to not function.	22

## ■ Connecting

Matters	Problems	Possible causes	Solutions	Page
Connecting to TV	There is no image or sound on the TV.	The camera is not connected to the TV correctly.	Connect the camera and TV correctly.	93, 94
		The included video cable or A/V cable was connected during movie playback.	After the movie playback mode is stopped, connect the camera and TV correctly.	81, 93, 94
		"TV" is selected as the TV input.	Set the TV input to "VIDEO".	–
		The video output setting is incorrect.	Change the setting to NTSC or PAL.	83, 85
		The TV volume is turned down.	Adjust the volume.	–
	The TV image is black and white.	The video output setting is incorrect.	Change the setting to NTSC or PAL.	83, 85
Connecting to PC	PC does not recognize the camera.	The USB cable (mini-B) is not correctly connected to the PC or camera.	Set up the camera, and connect the USB cable (mini-B) correctly.	106
Connecting to printer	Cannot print with PictBridge.	<ul style="list-style-type: none"><li>• The USB cable (mini-B) is not correctly connected to the printer or camera.</li><li>• The printer is not turned on.</li></ul>	<ul style="list-style-type: none"><li>• Set up the camera, and connect the USB cable (mini-B) correctly.</li><li>• Turn the printer on.</li></ul>	95

**Continued** ➔

■ Others

Matters	Problems	Possible causes	Solutions	Page
Camera operation etc.	Nothing happens when pressing the buttons on the camera.	Camera malfunction may be caused temporarily.	Briefly remove the batteries or disconnect the AC power adapter. Then reload the batteries or reconnect the AC power adapter and try again.	16, 17, 18, 119
		The batteries have run out.	Load new or fully charged batteries.	16, 18, 117
	The camera no longer works correctly.	Camera malfunction may be caused temporarily.	Briefly remove the batteries or disconnect the AC power adapter. Then reload the batteries or reconnect the AC power adapter and try again. If you think the camera is faulty, contact your FUJIFILM dealer.	16, 17, 18, 119

# Specifications (FinePix A610)

System	
<b>Model</b>	Digital camera FinePix A610
<b>Effective pixels</b>	6.3 million pixels
<b>CCD</b>	1/2.5-inch Super CCD HR
<b>Storage media</b>	Internal memory (approx. 10 MB)/ <b>xD-Picture Card</b> (16/32/64/128/256/512 MB/1 GB/2 GB) /SD Memory Card (FUJIFILM recommendation (→p.19))
<b>File format</b>	Still image: DCF-compliant Compressed: Exif ver.2.2 JPEG, DPOF-compatible *Design rule for Camera File System compliant/DPOF compatible Movie: AVI format, Motion JPEG
<b>Number of recorded pixels</b>	Still image: 2848 × 2136 pixels/3024 × 2016 pixels/2048 × 1536 pixels/ 1600 × 1200 pixels/640 × 480 pixels (6M/3.2M/3M/2M/0.8M)
<b>File size</b>	See the table on the p.139
<b>Lens</b>	Fujinon 3x optical zoom lens F3.0-F5.4
<b>Focal length</b>	f=6.6 mm-19.8 mm (Equivalent to approx. 39 mm-117 mm on a 35 mm camera)
<b>Digital zoom</b>	Approx. 6.2x (3x optical zoom lens is used together: Max. zoom scale: approx. 18.6x)
<b>Aperture (Wide-angle)</b>	F3.0/F8
<b>Focal range</b>	Normal: approx. 60 cm (2.0 ft.) to infinity Macro: wide-angle: approx. 10 cm (3.9 in.) to 80 cm (2.6 ft.) telephoto: approx. 35 cm (1.1 ft.) to 80 cm (2.6 ft.)

**Continued** ➔

System	
<b>Sensitivity</b>	AUTO/Equivalent to ISO 100/200/400 (Standard output sensitivity)
<b>Photometry</b>	TTL 256-zones metering
<b>Exposure control</b>	Program AE
<b>Scene position</b>	(BABY MODE)/ (PORTRAIT)/ (LANDSCAPE)/ (SPORT)/ (NIGHT)/ (BEACH)/ (SNOW)/ (FIREWORKS)/ (SUNSET)/ (UNDERWATER)/ (FLOWER)/ (PARTY)/ (MUSEUM)/ (TEXT)
<b>Exposure compensation</b>	-2 EV to +2 EV in 1/3 EV-step increments ()
<b>Shutter speed</b>	4 sec. to 1/1500 sec. (depend on Exposure mode)
<b>Focus</b>	Mode: Single-AF AF system: TTL contrast-type AF frame selection: AF (CENTER)



<b>System</b>	
<b>White balance</b>	Automatic scene recognition/Preset (Fine, Shade, Fluorescent (Daylight), Fluorescent (Warm White), Fluorescent (Cool White), Incandescent)
<b>Self-timer</b>	Approx. 2 sec./10 sec.
<b>Flash type</b>	Auto flash Effective range: (☉): AUTO Wide-angle: approx. 60 cm-3.5 m (2.0 ft.-11.5 ft.) Telephoto: approx. 60 cm-1.9 m (2.0 ft.-6.2 ft.) Macro: approx. 30 cm-80 cm (1.0 ft.-2.6 ft.)
<b>Flash mode</b>	Auto, Red-eye Reduction, Forced Flash, Suppressed Flash, Slow Synchro, Red-eye Reduction + Slow Synchro
<b>LCD monitor</b>	2.5 inches, Aspect ratio: 4:3; approx. 115,000 pixels Amorphous silicon TFT color LCD monitor, Approx. 100% coverage
<b>Movie</b>	320 × 240 pixels (320) (30 frames per second no sound) A series of continuous image can be recorded depending on the available space on a Memory Card or internal memory. Zoom cannot be used during movie recording.
<b>Photography functions</b>	Best framing, Frame NO. memory
<b>Playback functions</b>	Slide show, Multi-frame playback, Sorting by date, Image rotate
<b>Other functions</b>	PictBridge, Exif print, Language (日本語, English, Francais, Deutsch, Español, Italiano, 中文簡, 繁體, 한글, Русский, Português, Nederlands, Türkçe, Český, Magyar, Polski, Svenska), Time difference, Discharging rechargeable batteries
<b>Input/Output Terminal</b>	
<b>VIDEO OUT (Visual output)</b>	NTSC/PAL-type
<b>Digital input/output</b>	USB 2.0 High-Speed, PTP (Picture Transfer Protocol)/MTP (Media Transfer Protocol)
<b>DC input socket</b>	AC Power Adapter AC-3VX (sold separately)

**Continued** ➔

**Power Supply and Others****Power supply**

Use one of the following:

- 2×AA-size alkaline batteries
- 2×AA-size Ni-MH (Nickel-Metal Hydride) batteries (sold separately)
- AC power adapter AC-3VX (sold separately)

**Guide to the number of available frames for battery operation**

Battery Type	Number of frames
Alkaline batteries	Approx. 100 frames
Ni-MH batteries 2500 mAh	Approx. 350 frames

According to the CIPA (Camera & Imaging Products Association) standard procedure for measuring digital still camera battery consumption (extract):

When using alkaline batteries, use the batteries supplied with the camera. You can use Ni-MH batteries also. The storage media should be **xD-Picture Card**.

Pictures should be taken at a temperature of +23°C (+73°F), with the LCD monitor turned on, the optical zoom moved from full wide-angle to full telephoto (or vice-versa) and back again to its original position every 30 seconds, the flash used at full power every second shot and the camera turned off and then on again once every 10 shots.

- Note: Because the number of available shots varies depending on the capacity of alkaline batteries or the level of charge in Ni-MH batteries, the figures shown here for the number of available shots using batteries are not guaranteed.

The number of available shots will also decline at low temperatures.

**Camera dimensions (W/H/D)** 97.5 mm × 61.9 mm × 31.0 mm/3.8 in. × 2.4 in. × 1.2 in. (not including accessories and attachments)

**Camera mass (weight)** Approx. 145 g/5.1 oz. (not including accessories, batteries and Memory Card)

**Weight for photography** Approx. 193 g/6.8 oz. (including batteries and Memory Card)

**Operating Conditions** Temperature: 0°C to +40°C (+32°F to +104°F)  
80% humidity or less (no condensation)

■ **Standard number of available frames/recording time per xD-Picture Card , SD Memory Card and internal memory**

The number of available frames, recording time or file size varies slightly depending on the subjects photographed. Note also that the divergence between standard number of frames and the actual number of frames is greater for Memory Cards with higher capacities.

Quality setting	6M F	6M N	3:2	3M	2M	03M	320 (30 fps)	
Number of recorded pixels	2848 × 2136		3024 × 2016	2048 × 1536	1600 × 1200	640 × 480	320 × 240	
Image data size	3.0 MB	1.5 MB	1.5 MB	780 KB	630 KB	130 KB	–	
Internal memory (approx.10 MB)	2	6	6	12	15	75	16 sec.	
xD-Picture Card	16 MB	5	10	10	19	25	122	27 sec.
	32 MB	10	20	20	40	50	247	55 sec.
	64 MB	21	42	42	81	101	497	110 sec.
	128 MB	42	84	84	162	204	997	222 sec.
	256 MB	85	169	169	325	409	1997	7.4 min.
	512 MB	170	339	339	651	818	3993	14.9 min.
	1 GB	341	680	680	1305	1639	7995	29.7 min.
	2 GB	680	1360	1360	2558	3198	15992	59.5 min.
SD Memory Card	512 MB	165	328	328	631	793	3867	14.4 min.
	1 GB	331	658	658	1264	1588	7745	28.8 min.
	2 GB	659	1319	1319	2480	3100	15501	57.7 min.

# Specifications (FinePix A800)

System	
<b>Model</b>	Digital camera FinePix A800
<b>Effective pixels</b>	8.3 million pixels
<b>CCD</b>	1/1.6-inch Super CCD HR
<b>Storage media</b>	Internal memory (approx. 10 MB)/ <b>xD-Picture Card</b> (16/32/64/128/256/512 MB/1 GB/2 GB) /SD Memory Card (FUJIFILM recommendation (→p.19))
<b>File format</b>	Still image: DCF-compliant Compressed: Exif ver.2.2 JPEG, DPOF-compatible *Design rule for Camera File System compliant/DPOF compatible Movie: AVI format, Motion JPEG Audio: Monaural sound
<b>Number of recorded pixels</b>	Still image: 3296 × 2472 pixels/3504 × 2336 pixels/2304 × 1728 pixels/ 1600 × 1200 pixels/640 × 480 pixels ( <b>6M/6.2M/4M/2M/0M</b> )
<b>File size</b>	See the table on the p.144
<b>Lens</b>	Fujinon 3× optical zoom lens F2.8-F5.2
<b>Focal length</b>	f=8.0 mm-24.0 mm (Equivalent to approx. 36 mm-108 mm on a 35 mm camera)
<b>Digital zoom</b>	Approx. 6.9× (3× optical zoom lens is used together: Max. zoom scale: approx. 20.7×)
<b>Aperture (Wide-angle)</b>	F2.8/F8
<b>Focal range</b>	Normal: approx. 50 cm (1.6 ft.) to infinity Macro: wide-angle: approx. 10 cm (3.9 in.) to 80 cm (2.6 ft.) telephoto: approx. 35 cm (1.1 ft.) to 80 cm (2.6 ft.)

System	
<b>Sensitivity</b>	AUTO/Equivalent to ISO 100/200/400/800 (Standard output sensitivity)
<b>Photometry</b>	TTL 256-zones metering
<b>Exposure control</b>	Program AE
<b>Scene position</b>	(BABY MODE)/  (PORTRAIT)/  (LANDSCAPE)/  (SPORT)/  (NIGHT)/  (NATURAL LIGHT)/  (BEACH)/  (SNOW)/  (FIREWORKS)/  (SUNSET)/  (UNDERWATER)/  (FLOWER)/  (PARTY)/  (MUSEUM)/  (TEXT)
<b>Exposure compensation</b>	-2 EV to +2 EV in 1/3 EV-step increments ()
<b>Shutter speed</b>	4 sec. to 1/1600 sec. (depend on Exposure mode)
<b>Focus</b>	Mode: Single-AF AF system: TTL contrast-type AF frame selection: AF (CENTER)

**Continued** ➔

System	
<b>White balance</b>	Automatic scene recognition/Preset (Fine, Shade, Fluorescent (Daylight), Fluorescent (Warm White), Fluorescent (Cool White), Incandescent)
<b>Self-timer</b>	Approx. 2 sec./10 sec.
<b>Flash type</b>	Auto flash Effective range: (☉): AUTO Wide-angle: approx. 50 cm-3.8 m (1.6 ft.-12.5 ft.) Telephoto: approx. 60 cm-2.0 m (2.0 ft.-6.6 ft.) Macro: approx. 30 cm-80 cm (1.0 ft.-2.6 ft.)
<b>Flash mode</b>	Auto, Red-eye Reduction, Forced Flash, Suppressed Flash, Slow Synchro, Red-eye Reduction + Slow Synchro
<b>LCD monitor</b>	2.5 inches, Aspect ratio: 4:3; approx. 115,000 pixels Amorphous silicon TFT color LCD monitor, Approx. 100% coverage
<b>Movie</b>	320 × 240 pixels (320) (30 frames per second with monaural sound) A series of continuous image can be recorded depending on the available space on a Memory Card or internal memory. Zoom cannot be used during movie recording.
<b>Photography functions</b>	Best framing, Frame NO. memory
<b>Playback functions</b>	Trimming, Slide show, Multi-frame playback, Sorting by date, Image rotate
<b>Other functions</b>	PictBridge, Exif print, Language (日本語, English, Francais, Deutsch, Español, Italiano, 中文簡, 繁體, 한글, Русский, Português, Nederlands, Türkçe, Česky, Magyar, Polski, Svenska), Time difference, Discharging rechargeable batteries
Input/Output Terminal	
<b>A/V OUT (Audio/Visual output)</b>	NTSC/PAL-type (with monaural sound)
<b>Digital input/output</b>	USB 2.0 High-Speed, PTP (Picture Transfer Protocol)/MTP (Media Transfer Protocol)
<b>DC input socket</b>	AC Power Adapter AC-3VX (sold separately)

## Power Supply and Others

### Power supply

Use one of the following:

- 2×AA-size alkaline batteries
- 2×AA-size Ni-MH (Nickel-Metal Hydride) batteries (sold separately)
- AC power adapter AC-3VX (sold separately)

### Guide to the number of available frames for battery operation

Battery Type	Number of frames
Alkaline batteries	Approx. 100 frames
Ni-MH batteries 2500 mAh	Approx. 350 frames

According to the CIPA (Camera & Imaging Products Association) standard procedure for measuring digital still camera battery consumption (extract):

When using alkaline batteries, use the batteries supplied with the camera. You can use Ni-MH batteries also. The storage media should be **xD-Picture Card**.

Pictures should be taken at a temperature of +23°C (+73°F), with the LCD monitor turned on, the optical zoom moved from full wide-angle to full telephoto (or vice-versa) and back again to its original position every 30 seconds, the flash used at full power every second shot and the camera turned off and then on again once every 10 shots.

- Note: Because the number of available shots varies depending on the capacity of alkaline batteries or the level of charge in Ni-MH batteries, the figures shown here for the number of available shots using batteries are not guaranteed.

The number of available shots will also decline at low temperatures.

**Camera dimensions (W/H/D)** 97.5 mm × 61.9 mm × 31.0 mm/3.8 in. × 2.4 in. × 1.2 in. (not including accessories and attachments)

**Camera mass (weight)** Approx. 151 g/5.3 oz. (not including accessories, batteries and Memory Card)

**Weight for photography** Approx. 199 g/7.0 oz. (including batteries and Memory Card)

**Operating Conditions** Temperature: 0°C to +40°C (+32°F to +104°F)  
80% humidity or less (no condensation)

**Continued** ➔

**■ Standard number of available frames/recording time per xD-Picture Card , SD Memory Card and internal memory**

The number of available frames, recording time or file size varies slightly depending on the subjects photographed. Note also that the divergence between standard number of frames and the actual number of frames is greater for Memory Cards with higher capacities.

Quality setting	8M F	8M N	3:2	4M	2M	03M	320 (30 fps)	
Number of recorded pixels	3296 × 2472		3504 × 2336	2304 × 1728	1600 × 1200	640 × 480	320 × 240	
Image data size	4.0 MB	2.0 MB	2.0 MB	980 KB	630 KB	130 KB	–	
Internal memory (approx.10 MB)	2	4	4	9	15	75	16 sec.	
xD-Picture Card	16 MB	3	7	7	15	25	122	27 sec.
	32 MB	7	15	15	31	50	247	54 sec.
	64 MB	15	31	31	64	101	497	110 sec.
	128 MB	31	63	63	128	204	997	221 sec.
	256 MB	63	126	126	257	409	1997	7.4 min.
	512 MB	127	253	253	515	818	3993	14.8 min.
	1 GB	255	507	507	1031	1639	7995	29.6 min.
	2 GB	511	1015	1015	2063	3198	15992	59.2 min.
SD Memory Card	512 MB	123	245	245	498	793	3867	14.3 min.
	1 GB	247	491	491	999	1588	7745	28.7 min.
	2 GB	495	983	983	1999	3100	15501	57.4 min.



---

If you shoot using the **xD-Picture Cards** with model numbers containing "M" such as DPC-M2GB, movie recording time may be reduced if you repeatedly record and erase (frame erase) image files. In such a case, erase all frames or format the **xD-Picture Card** before use. Back up important frames (files) onto your PC or another media.

- \* These specifications are subject to change without notice. FUJIFILM shall not be held liable for damages resulting from errors in this Owner's Manual.
- \* The LCD monitor on your digital camera is manufactured using advanced high-precision technology. Even so, small bright points and anomalous colors (particularly around text) may appear on the monitor. These are normal display characteristics and do not indicate a fault with the monitor. This phenomenon will not appear on the recorded image.
- \* The operation error may be caused in a digital camera by the strong radio interference (i. e. electric fields, static electricity, line noise, etc.).
- \* Due to the nature of the lens, the edges of images may appear distorted. This is normal.





# Explanation of Terms

## **Deactivated batteries**

Leaving an Ni-MH battery unused in storage for a long period may cause a rise in the level of substances that inhibit current flow inside the battery and result in a dormant battery. A battery in this state is referred to as deactivated.

Because current flow is inhibited in a deactivated Ni-MH battery, the battery's original level of performance cannot be achieved.

## **EV**

A number denotes Exposure Value. The EV is determined by the brightness of the subject and sensitivity (speed) of the film or CCD. The number is larger for bright subjects and smaller for dark subjects. As the brightness of the subject changes, a digital camera maintains the amount of light hitting the CCD at a constant level by adjusting the aperture and shutter speed.

When the amount of light striking the CCD doubles, the EV increases by 1. Likewise, when the light is halved, the EV decreases by 1.

## **Frame rate (fps)**

The frame rate refers to the number of images (frames) that are photographed or played back per second. For example, when 10 frames are continuously photographed in a 1-second interval, the frame rate is expressed as 10 fps.

For reference, TV images are displayed at 30 fps (NTSC).

## **JPEG**

Joint Photographic Experts Group

A file format used for compressing and saving color images. The higher the compression rate, the greater the loss of quality in the decompressed (restored) image.

## **Memory effect**

If an Ni-MH battery is repeatedly charged without first being fully discharged, its performance may drop below its original level. This is referred to as the "memory effect".

## **Motion JPEG**

A type of AVI (Audio Video Interleave) file format that handles images and sound as a single file. Images in the file are recorded in JPEG format. Motion JPEG can be played back by QuickTime 3.0 or later.

## **Smear**

A phenomenon specific to CCDs whereby white streaks appear on the image when there is a very strong light source, such as the sun or reflected sunlight, in the photography screen.

## **White Balance**

Whatever the kind of the light, the human eye adapts to it so that a white object still looks white. On the other hand, devices such as digital cameras see a white subject as white by first adjusting the color balance to suit the color of the ambient light around the subject. This adjustment is called matching the white balance.



Exif Print Format is a newly revised digital camera file format that contains a variety of shooting information for optimal printing.

# FUJIFILM Digital Camera Worldwide Network

If you have technical questions or if you need repair service, ask the following local distributor.

Please present the warranty card and your purchase receipt when you ask for repairs. Refer to the warranty card for conditions of the warranty.

There is a case that repair and Technical support cannot be accepted for some models which your local distributor does not deal with.

These lists are subject to change without notice.

## NORTH AMERICA

Canada	<b>FUJIFILM Canada Inc.</b> Technical support Repair service	600 Suffolk Court Mississauga Ontario, L5R 4G4 TEL 1-866-818-FUJI (3854) <a href="http://www.fujihelp.ca">http://www.fujihelp.ca</a> 600 Suffolk Court Mississauga Ontario, L5R 4G4 TEL 1-800-263-5018 FAX 1-905-755-2993 <a href="http://www.fujihelp.ca">http://www.fujihelp.ca</a>
U.S.A.	<b>FUJIFILM U.S.A., Inc.</b> Technical support Repair service	1100 King George Post Rd., Edison, NJ 08837 TEL 800-800-3854 FAX 732-857-3487 <a href="mailto:digitalinfo@fujifilm.com">digitalinfo@fujifilm.com</a> 1100 King George Post Rd., Edison, NJ 08837 TEL 732-857-3000 FAX 732-857-3471 <a href="mailto:njcamerarepair@fujifilm.com">njcamerarepair@fujifilm.com</a>
Hawaii	<b>FUJIFILM Hawaii, Inc.</b> Technical support & Repair service	94-468 Akoki Street, Waipahu, HI. 96797 TEL 1-808-677-3854, ext. 209 FAX 1-808-677-1443 <a href="mailto:kurt_kmett@fujifilmhawaii.com">kurt_kmett@fujifilmhawaii.com</a>

## CENTRAL & SOUTH AMERICA

Argentina	<b>Imagen e informacion S.A.</b> Technical support & Repair service	Fondo de la Legua 936 San Isidro Pcia. de Buenos Aires TEL +54-11-4836-1000 FAX +54-11-4836-1144 <a href="mailto:servtec@imageneinformacion.com.ar">servtec@imageneinformacion.com.ar</a>
Bolivia	<b>Reifschneider Bolivia Ltda.</b> Technical support & Repair service	Calle H N.º 5 - Equipetrol Norte - Santa Cruz TEL +591 33 44 1129 FAX +591 33 45 2919 <a href="mailto:gciagral@bibosi.scz.entelnet.bo">gciagral@bibosi.scz.entelnet.bo</a>
Brazil	<b>FUJIFILM do Brasil Ltda.</b> Technical support & Repair service	Av. Vereador José Diniz, 3400 - Campo Belo, São Paulo/SP TEL 0800-12-8600 FAX +55 11 5091-4150 <a href="mailto:camarasdigitais@fujifilm.com.br">camarasdigitais@fujifilm.com.br</a>
Chile	<b>Reifschneider SA</b> Technical support & Repair service	Av. El Conquistador del Monte 5024, Huechuraba, Santiago, Chile TEL 02-4431500 FAX 02-4431596 <a href="mailto:ceciliacalvo@reifschneider.cl">ceciliacalvo@reifschneider.cl</a>
Colombia	<b>Animex de Colombia Ltda.</b> Technical support & Repair service	Calle 44 N.º 13-43 Piso 2 Apartado 18001 - Bogotá TEL +57 1 338-0299 FAX +57 1 288-2208 <a href="mailto:animex@etb.net.co">animex@etb.net.co</a>
Ecuador	<b>Espacri Cia Ltda</b> Technical support & Repair service	Bolivar 5-69 y Hermano Miguel TEL 593-72-835526 FAX 593-72-833157

## FUJIFILM Digital Camera Worldwide Network

Ecuador	<b>Importaciones Espacri Cia. Ltda.</b> Technical support & Repair service	Simón Bolívar 5-69 y Hno. Miguel - Cuenca TEL +593 783 5526 FAX +593 783 3157 portiz@fujifilm.com.ec
Mexico	<b>Fujifilm de Mexico, S.A. de C.V.</b> Technical support Repair service	Av. Ejercito Nacional 351, Col. Granada 11520 Mexico, D.F. TEL (52-55) 5263-5566 / 68 FAX (52-55) 5254-1508 jlgiraud1@fujifilm.com.mx Av. Presidente Juarez 2007, Col. Tepetlalcaltco, 54090 Tlalnepanltla, Edo. de Mexico TEL (52-55) 5263-5500 FAX (52-55) 5254-1508 jlgiraud1@fujifilm.com.mx
Paraguay	<b>Errece S.R.L.</b> Technical support & Repair service	Edificio Unitas 15 de Agosto 1035, Asunción TEL +595 21 444256 FAX +595 21 444651 jmarbulo@fujifilm.com.py
Peru	<b>Procesos de Color S.A.</b> Technical support & Repair service	Pablo Bermudez 111 Apartado 3794 - Esq. Arequipa - Lima 11 TEL +51 14 33 5563 FAX +51 14 33 7177 jalvarado@fujifilm.com.pe
Uruguay	<b>Fotocamara S.R.L.</b> Technical support & Repair service	Cuareim 1439, montevideo, Uruguay TEL +598-2-9002004 FAX +598-2-9008430 fotocam@adinet.com.uy
Uruguay	<b>Kiel S.A.</b> Technical support & Repair service	Maldonado 1787 Montevideo- Uruguay TEL (05982) 419 4542 FAX (05982) 412 0046 kiel@fujifilm.com.uy
Venezuela	<b>C. Hellmund &amp; Cia Sa</b> Technical support & Repair service	Av. Ppal Diego Cisneros Caracas Venezuela Edf Oficentro TEL 0212-2022300 FAX 0212-2399796 hellmund@hellmund.com

### EUROPE

Austria	<b>Fuji Film Oesterreich</b> Technical support & Repair service	Traviatagasse/Pfarrgasse, 1230 Vienna, Austria TEL 0043 1 6162606/51 or 52 FAX 0043 1 6162606/58 kamera.service@fujifilm.at
Belgium	<b>Belgian Fuji Agency</b> Technical support & Repair service	20, Avenue Lavoisier, Wavre, 1300, Belgium TEL 3210242090 FAX 3210238562 info@fuji.be
Croatia	<b>I&amp;I d.o.o.</b> Technical support Repair service	Hondlova 2, Zagreb, Croatia TEL 38512319060 FAX 2310240 dsaravanja@fujifilm.hr Hondlova 2, Zagreb, Croatia TEL 38512316228 FAX 2310240 info@fujifilm.hr
Cyprus	<b>PMS IMAGING LTD</b> Technical support & Repair service	11, Dighenis Akritas Avenue, P.O.BOX 22315, 1586 Nicosia TEL 35722746746 FAX 35722438209 mariosashiotis@fujifilm.com.cy

Cyprus	<b>Doros Neophytou CAMERA REPAIRS</b> Technical support & Repair service	28B, Agiou Demetriou, Acropoli, Nicosia TEL 35722314719 FAX 35722515562 dorosn@logosnet.cy.net
Czech Republic	<b>Fujifilm Cz., s.r.o.</b> Technical support	U nakladoveho nadrazi 2/1949, 130 00 Praha 3 TEL 00420 234 703 411 FAX 00420 234 703 489 fricman@fujifilm.cz
Czech Republic	<b>AWH servis</b> Repair service	Milesovska 1, 130 00 Praha 3, Czech republic TEL 00420 222 721 525 FAX 00420 222 720 122 awh@awh.cz
Denmark	<b>Fujifilm Denmark A/S</b> Technical support & Repair service	Stubbeled 2, 2950 Vedbæk Denmark TEL 0045 45662244 FAX 0045 45662214 fujifilm@fujifilm.dk
Finland	<b>Fuji Finland Oy</b> Technical support & Repair service	Martinkyläntie 41, 01720 Vantaa, Finland TEL +358 9 825951 FAX +358 9 870 3818 fuji@fuji.fi
France	<b>FUJIFILM France</b> Technical support & Repair service	2, Avenue Franklin, 78186 Saint-Quentin en Yvelines, France FAX 33 1 01 30 58 58 65 direction.technique@fujifilm.fr
Germany	<b>FUJIFILM Europe GmbH</b> Technical support & Repair service	Heesenstr. 70, 40549 Düsseldorf International call TEL +49 211 50890 FAX +49 211 5089668 service@fujifilm.de National call* TEL 0180 5898980 FAX 0180 5898982 *12 Cent/Min aus dem deutschen Festnetz
Greece	<b>FUJIFILM HELLAS S.A.</b> Technical support & Repair service	1, Ihou & Ag. Anargiron str., 175 64 P.Phaliro, Athens, Greece TEL 0030 210 9404100 FAX 0030 210 9404397 fujifilm@fujifilm.gr
Hungary	<b>Fujifilm Hungary Ltd.</b> Technical support	Váci ut 19. Budapest, 1134, Hungary TEL 3612389410 FAX 3612389401 fujifilm@fujifilm.hu
Iceland	<b>Icephoto (Ljosmyndavörur)</b> Technical support & Repair service	Skipholt 31, 105 Reykjavik, Iceland TEL 354 568 0450 FAX 354 568 0455 framkollun@fujifilm.is
Italy	<b>FujiFilm Italia S.p.A.</b> Technical support Repair service	Via Dell'Unione Europea, 4 - 20097 San Donato Milanese (MI), Italy TEL 039-02895821 FAX 039-0289582912 info@fujifilm.it Fujifilm On Line - Call center TEL 039-026695272 info@fujifilm.it
Lithuania	<b>Fujifilm Lithuania</b> Technical support & Repair service	Gerosios Vilties str. 38, LT-03143 Vilnius, Lithuania TEL 370-5-2130121 FAX 3705-5-2134066 info@fujifilm.lt

## FUJIFILM Digital Camera Worldwide Network

Malta	<b>Ciancio (1913) Co.Ltd.</b> Technical support & Repair service	Fuji Tech Centre, Ciancio House, Cannon Road, Qormi, QRM05 TEL 0356-21-480500 FAX 0356-21-488328 info@fujifilm.com.mt
Netherlands	<b>Fujifilm Nederland BV</b> Technical support Repair service	Hoogstraat 39, 3011 PE, Rotterdam, The Netherlands TEL 010-2812345 FAX 010-2812334 fuji@fujifilm.nl Hoefenseweg 43, 4877 LA, Etten-Leur, The Netherlands TEL 010-2812345 FAX 076-7502641 reparatie@fujifilm.nl
Norway	<b>Fujifilm Norge AS</b> Technical support Repair service	Lilleakerveien 10, 0283 Oslo, Norway TEL 0047-22736000 FAX 0047-22736020 http://www.fujifilm.no/ mailto:post@fujifilm.no Liaveien 1, 5132 Nyborg, Norway TEL 0047-55393880 FAX 0047-55195201 http://www.camera.no/ mailto:service@camera.no
Poland	<b>Fujifilm Polska Distribution Sp. z o.o.</b> Technical support Repair service	Poland Al...Jerozolimskie 178; 02-486 Warszawa TEL +48-22-517-66-00 FAX +48-22-517-66-02 fujifilm@fujifilm.pl Poland, Muszkieterow 15, 02-273 Warszawa TEL +48-22-886-94-40 FAX +48-22-886-94-42 serwis@fujifilm.pl
Portugal	<b>Fujifilm Portugal, Lda</b> Technical support Repair service	Av. Fontes Pereira de Melo, 342, 4100-259 Porto, Portugal TEL (351) 226194200 FAX (351) 226194213 finepix@fujifilm.pt Av. Fontes Pereira de Melo, 342, 4100-259 Porto, Portugal TEL (351) 226194200 FAX (351) 225194662 cameras@fujifilm.pt
Romania	<b>CTS-Cardinal Top Systems Ltd</b> Technical support & Repair service	112, Calea Dorobanti street, 4 flat, 1sector, Bucharest, Romania TEL 4021-230-09-82 FAX 4021-230-09-82 cts_tirla@hotmail.com
Russia	<b>ZAO "Fujifilm RU"</b> Technical support Repair service	Bld. 1, 10, Rozanova str., Moscow, 123007, Russia TEL +7-095-956-9858 FAX +7-095-230-6217 info@fujifilm.ru 18, Shelepikhinskaya Naberezhnaya str., Moscow, 123290, Russia TEL +7-095-797-3434 FAX +7-095-797-3434
Slovakia	<b>Fujifilm Slovakia</b> Technical support Repair service	Pribylinska 2, 831 04 Bratislava, Slovakia TEL 00421 2 44 888 077 FAX 00421 2 44 889 300 fujifilm@fujifilm.sk FIS Tatracentrum, Hodzovo nam. 4 - Tatracentrum, 811 06 Bratislava, Slovakia TEL 00421 2 54 647 347 fis.tatracentrum@stonline.sk
Spain	<b>Fujifilm España S.A.</b> Technical support Repair service	Aragón 180, 08011 Barcelona (España) TEL 902012535 FAX 934515900 / 933230330 info@fujifilm.es Aragón 180, 08011 Barcelona (España) TEL 934511515 FAX 934515900 / 933230330 tallersat@fujifilm.es



Sweden	<b>Fujifilm Sverige AB</b> Technical support Repair service	Sveavägen 167 104 35 Stockholm TEL 46 8 506 141 70 FAX 46 8 506 142 09 kamera@fujifilm.se Sveavägen 167 104 35 Stockholm TEL 46 8 506 513 54 FAX 46 8 506513 54 kameraverkstaden@fujifilm.se
Switzerland / Lichtenstein	<b>Fujifilm (Switzerland) AG</b> Technical support & Repair service	Niederhaslistrasse 12, 8157 Dietlikon, Switzerland TEL +41 44 855 5154 FAX +41 44 855 5329 RepairCenter@fujifilm.ch
Turkey	<b>Fujifilm Türkiye Sinfo A.S.</b> Technical support Repair service	Fujifilm Plaza, Dereboyu Cad. 39 34660 Halkali, Istanbul, Turkey TEL +90 212 696 5090 FAX +90 212 696 5009 csarp@fujifilm.com.tr Fujifilm Plaza, Dereboyu Cad. 39 34660 Halkali, Istanbul, Turkey TEL +90 212 696 5090 FAX +90 212 696 5010 servis@fujifilm.com.tr
U.K.	<b>FUJIFILM UK Ltd.</b> Technical support Repair service	St Martins Way St Martins Business Centre Bedford MK42 0LF TEL +44 (0)123 424 5383 FAX +44 (0)123 424 5285 fujitec@fuji.co.uk St Martins Way St Martins Business Centre Bedford MK42 0LF TEL +44 (0)123 421 8388 FAX +44 (0)123 424 5285 fujitec@fuji.co.uk
Ukraine	<b>Image Ukraine CJSC</b> Technical support & Repair service	12, Kontraktova ploscha, Kyiv 04070, Ukraine TEL +380-44-4909075 FAX +380-44-4909076 d@fujifilm.ua
<b>MIDDLE EAST</b>		
Iran	<b>Tehran Fuka Co.</b> Technical support & Repair service	229, "Fuji" Bldg., Mirdamad Blvd., Tehran 19189, Iran TEL (+98-21)2254810-19 FAX (+98-21)2221002 fuka@neda.net
Israel	<b>Shimone Group Ltd.</b> Technical support Repair service	Efal 33 keyriat Arie Petah Tikva 49130, Israel TEL (+) 972 3 9250666 digital@fujifilm.co.il Efal 33 keyriat Arie Petah Tikva 49130, Israel TEL (+) 972 3 9250666 FAX 972 3 9250699 khaim@shimone.com
Jordan	<b>Grand Stores</b> Technical support & Repair service	Al- Abdali, Amman / Jordan TEL 009626-4646387 FAX 009626-4647542 gstores@go.com.jo
Qatar	<b>Techno Blue</b> Technical support	Blue Salon Bldg, 3rd Floor, Suhaim bin Hamad st, Al- Saad, Doha TEL 00974 44 66 175 FAX 00974 44 79 053 prabu@techno-blue.com
Saudi Arabia	<b>Emam Distribution Co. Ltd.</b> Technical support	P.O. Box 1716, Jeddah 21441, Saudi Arabia TEL 96626978756 FAX 96626917036 service@fujifilm.com.sa

## FUJIFILM Digital Camera Worldwide Network

Syria	<b>Film Trading Company</b> Technical support Repair service	Al-Shahbandar P.O. Box:31180 Damascus SYRIA TEL + 963 11 2218049 FAX + 963 11 44673456 f.t.c@Net.SY Al-cheikh Taha P.O. Box: 6171 Aleppo SYRIA TEL + 963 21 4641903 FAX + 963 21 4641907 filmtradin@Net.SY
U.A.E.	<b>Grand Stores</b> Technical support & Repair service	P. O. Box 2144, Saleh Bin Lahej Building, Al Garhoud, Deira, Dubai TEL + 971-4-2823700 FAX + 971-4-2828382 photography@grandstores.ae
Yemen	<b>Al-Haidary Trading</b> Technical support Repair service	P.O.Box-2942 Haddah St. HTC, Sana'a, Yemen TEL 00967-1-503980 FAX 00967-1-503983 P.O.Box-2942 Haddah St. HTC, Sana'a, Yemen TEL 00967-1-503977 FAX 00967-1-503983
<b>AFRICA</b>		
Egypt	<b>Foto Express Egypt</b> Technical support & Repair service	426 Pyramids St., Giza, Egypt TEL (202) 7762062 FAX (202) 7760169 fotoegypt@access.com.eg
Kenya	<b>Fuji Kenya Ltd</b> Repair service	P.O.Box 41669-00100, Fuji Plaza, Chiromo Road, Nairobi, Kenya. TEL (254-20)4446265-8 FAX (254-20)4448515 / 7 info@fujifilm.co.ke
<b>OCEANIA</b>		
Australia	<b>FUJIFILM Australia Pty Ltd</b> Technical support & Repair service	Locked Bag 5100, Brookvale, NSW, 2100 TEL 1800 226 355 FAX +61 (2) 9466 2854 digital@fujifilm.com.au
Fiji	<b>Brijlal &amp; Co. Ltd</b> Technical support & Repair service	70-72 Cumming Street, Suva, Fiji TEL (679)3304133 FAX (679)3302777 kapadia@connect.com.fj
New Caledonia	<b>Phocidis SARL</b> Technical support & Repair service	58, rue Higginson - B.P.661 - 98845 TEL (00 687) 25-46-35 FAX (00 687) 28-66-70 phocidis@phocidis.nc
New Zealand	<b>Fujifilm NZ Ltd</b> Technical support & Repair service	Cnr William Pickering & Bush Road Albany, Auckland TEL +64-9-4140400 FAX +64-9-4140410 glenn.beaumont@fujifilm.co.nz
Papua New Guinea	<b>Oceania PNG Limited</b> Technical support	Section 15, Allotment 1, Reke St, Boroko NCD. PNG. Mail: PO Box 2167, Boroko NCD. PNG. TEL +675 3256411 FAX +675 3250311 oceania@daltron.com.pg
<b>ASIA</b>		
Hong Kong	<b>Fuji Photo Products Co., Ltd.</b> Technical support & Repair service	8/F., TSUEN WAN IND. CENTRE, 220 TEXACO RD., TSUEN WAN, HONG KONG TEL (852)2406 3287 FAX (852)2408 3130 rsd@chinahkphoto.com.hk

Indonesia	<b>PT Modern Photo Tbk</b> Technical support & Repair service	Jl.Matraman Raya 12, Jakarta Timur 13150 TEL +62 021 2801000 FAX +62 021 8581620+62 021 2801012 assd_kmr@modernphoto.co.id
Malaysia	<b>FUJIFILM (Malaysia) Sdn. Bhd.</b> Technical support Repair service	Letter Box 1, Level 10, 11 & 12, Menara Axis, No 2, Jalan 51A/223, 46100 Petaling Jaya, Selangor Darul Ehsan, Malaysia TEL 603-79584700 FAX 603-79584110 digital@fujifilm.com.my Letter Box 1, Level 10, 11 & 12, Menara Axis, No 2, Jalan 51A/223, 46100 Petaling Jaya, Selangor Darul Ehsan, Malaysia TEL 603-79584700 FAX 603-79584110 technical@fujifilm.com.my
Philippines	<b>YKL Development &amp; Trdg. Corp.</b> Technical support Repair service	24 Sto. Domingo St., Quezon City 1100, Philippines TEL 632-7436601~06 FAX 632-7324661 digital@yklcolor.com 24 Sto. Domingo St., Quezon City 1100, Philippines TEL 632-7436601~06 FAX 632-7324661 tech_services@yklcolor.com
Singapore	<b>FUJIFILM (Singapore) Pte Ltd</b> Technical support & Repair service	10 New Industrial Road Fujifilm Building Singapore 536201 TEL 65-6380 5557 FAX 65-6281 3594 service@fujifilm.com.sg
South Korea	<b>Korea Fujifilm Co., Ltd.</b> Technical support	30-1, Mukjeung-dong, Jung-gu, Seoul, Korea TEL +82-2-3282-7363 FAX +82-2-2269-7435 photo@fujifilm.co.kr
South Korea	<b>Yonsan AS Center (Fujidigital)</b> Repair service	#301, 3F, Jeonjaland, 16-9, Hangangro3-ga, Yongsan-gu, Seoul, Korea TEL +82-2-701-1472 FAX +82-2-718-1331 1bowl@hanmail.net
South Korea	<b>Kangnam AS Center (Digitalgallery)</b> Repair service	2F, Hyeongin Tower, 23-2, Bangyi-dong, Songpa-gu, Seoul, Korea TEL +82-2-2203-1472 FAX +82-2-418-5572 nurijili@hanmail.net
South Korea	<b>Busan AS Center (Digital-Sewon)</b> Repair service	241-4, Bujeon-dong, Busanjin-gu, Busan, Korea TEL +82-51-806-1472 FAX +82-51-817-0083 merahan@yahoo.co.kr
Taiwan	<b>Hung Chong Corp.</b> Technical support & Repair service	No. 38, Min-Chuan E. Rd. Sec. 6, Taipei (114), Taiwan, R.O.C. TEL 886-2-6602-8988 FAX 886-2-2791-8647 dah@mail.hungchong.com.tw
Thailand	<b>FUJIFILM (Thailand) Ltd.</b> Technical support Repair service	388 SP Building, 8th Floor, Phayathai, Bangkok 10400 TEL +662-2730029 ext. 755 FAX +662-2730239 supaleark@fujifilm.co.th 388 SP Building, 8th Floor, Phayathai, Bangkok 10400 TEL +662-2730029 ext.761,762 FAX +662-2730239 warin@fujifilm.co.th





# Safety Notes

- Make sure that you use your FinePix A610 / FinePix A800 camera correctly. Read these Safety Notes and your Owner's Manual carefully before use.
- After reading these Safety Notes, store them in a safe place.

## About the Icons

The icons shown below are used in this document to indicate the severity of the injury or damage that can result if the information indicated by the icon is ignored and the product is used incorrectly as a result.



### WARNING

**This icon indicates that death or serious injury can result if the information is ignored.**



### CAUTION

**This icon indicates that personal injury or material damage can result if the information is ignored.**

The icons shown below are used to indicate the nature of the information which is to be observed.



Triangular icons tell you that this information requires attention ("important").



Circular icons with a diagonal bar tell you that the action indicated is prohibited ("Prohibited").



Filled circles with an exclamation mark tell you an action that must be performed ("Required").



## WARNING

**If a problem arises, turn the camera off, remove the batteries, disconnect and unplug the AC power adapter.**

Continued use of the camera when it is emitting smoke, is emitting any unusual odor, or is in any other abnormal state can cause a fire or electric shock.

- Contact your FUJIFILM dealer.



Unplug from power socket.

**Do not allow water or foreign objects to enter the camera.**

If water or foreign objects get inside the camera, turn the camera off, remove the batteries and disconnect and unplug the AC power adapter.

Continued use of the camera can cause a fire or electric shock.

- Contact your FUJIFILM dealer.



**Do not use the camera in the bathroom or shower.**

This can cause a fire or electric shock.



Do not use in the bathroom or shower.

**Never attempt to change or take apart the camera. (Never open the casing.)**

**Do not use the camera when it has been dropped or the casing is damaged.**

This can cause a fire or electric shock.

- Contact your FUJIFILM dealer.



Do not disassemble.



## WARNING

**Do not change, heat or unduly twist or pull the connection cord and do not place heavy objects on the connection cord.**

These actions could damage the cord and cause a fire or electric shock.

- If the cord is damaged, contact your FUJIFILM dealer.



**Do not place the camera on an unstable surface.**

This can cause the camera to fall or tip over and cause injury.



**Never attempt to take pictures while in motion.**

Do not use the camera while you are walking or driving a vehicle. This can result in you falling down or being involved in a traffic accident.



**Do not touch any metal parts of the camera during a thunderstorm.**

This can cause an electric shock due to induced current from the lightning discharge.



**Do not use the batteries except as specified.**

Load the batteries with the ⊕ and ⊖ marks.



## WARNING

**Do not heat, change or take apart the batteries.**

**Do not drop or subject the batteries to impacts.**

**Do not attempt to recharge lithium or alkaline batteries.**

**Do not store the batteries with metallic products.**

**Do not use chargers other than the specified model to charge the batteries.**

Any of these actions can cause the batteries to burst or leak and cause fire or injury as a result.



**Use only the batteries or AC power adapters specified for use with this camera.**

**Do not use voltages other than the power supply voltage shown.**

The use of other power sources can cause a fire.





**If the battery leaks and fluid gets in contact with your eyes, skin or clothing. Flush the affected area with clean water and seek medical attention or call an emergency number right away.**











**Do not use the charger to charge batteries other than those specified here.**

The charger is designed for Fujifilm HR-AA Ni-MH batteries. Using the charger to charge conventional batteries or other types of rechargeable batteries can cause the battery to leak fluid, overheat or burst.



 <b>WARNING</b>	
<p><b>When discarding or storing batteries, cover the battery terminals with insulation tape.</b></p> <p>Contact with other metallic objects or batteries could cause the batteries to ignite or burst.</p>	
<p><b>Keep Memory Cards out of the reach of small children.</b></p> <p>Because Memory Cards are small, they can be swallowed by children. Be sure to store Memory Cards out of the reach of small children. If a child swallows a Memory Card, seek medical attention or call an emergency number.</p>	

 <b>CAUTION</b>	
<p><b>Do not use this camera in locations affected by oil fumes, steam, humidity or dust.</b></p> <p>This can cause a fire or electric shock.</p>	
<p><b>Do not leave this camera in places subject to extremely high temperatures.</b></p> <p>Do not leave the camera in locations such as a sealed vehicle or in direct sunlight. This can cause a fire.</p>	
<p><b>Keep out of the reach of small children.</b></p> <p>This product could cause injury in the hands of a child.</p>	
<p><b>Do not place heavy objects on the camera.</b></p> <p>This can cause the heavy object to tip over or fall and cause injury.</p>	
<p><b>Do not move the camera while the AC power adapter is still connected. Do not pull on the connection cord to disconnect the AC power adapter.</b></p> <p>This can damage the power cord or cables and cause a fire or electric shock.</p>	
<p><b>Do not use the AC power adapter when the plug is damaged or the plug socket connection is loose.</b></p> <p>This could cause a fire or electric shock.</p>	
<p><b>Do not cover or wrap the camera or the AC power adapter in a cloth or blanket.</b></p> <p>This can cause heat to build up and distort the casing or cause a fire.</p>	





## CAUTION

**When you are cleaning the camera or you do not plan to use the camera for an extended period, remove the batteries and disconnect and unplug the AC power adapter.**

Failure to do so can cause a fire or electric shock.



**When charging ends, unplug the charger from the power socket.**

Leaving the charger plugged into the power socket can cause a fire.



**Using a flash too close to a person's eyes may temporarily affect the eyesight.**

Take particular care when photographing infants and young children.



**When a Memory Card is removed, the card could come out of the slot too quickly. Use your finger to hold it and gently release the card.**



**Request regular internal testing and cleaning for your camera.**

Build-up of dust in your camera can cause a fire or electric shock.

- Contact your FUJIFILM dealer to request internal cleaning every 2 years.
- Please note this is not a free of charge service.







# FUJIFILM

---

## **FUJIFILM Corporation**

MIDTOWN WEST, 7-3, AKASAKA 9-CHOME, MINATO-KU, TOKYO 107-0052, JAPAN

<http://www.fujifilm.com/products/digital/>