

## Setup Guide

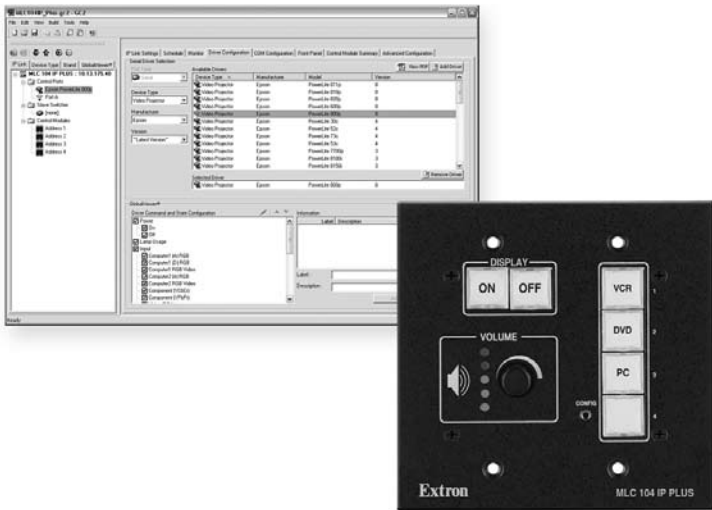

## MLC 104 Plus Series MediaLink™ Controllers

# Precautions

## Safety Instructions • English



This symbol is intended to alert the user of important operating and maintenance (servicing) instructions in the literature provided with the equipment.



This symbol is intended to alert the user of the presence of uninsulated dangerous voltage within the product's enclosure that may present a risk of electric shock.

### Caution

**Read Instructions** • Read and understand all safety and operating instructions before using the equipment.

**Retain Instructions** • The safety instructions should be kept for future reference.

**Follow Warnings** • Follow all warnings and instructions marked on the equipment or in the user information.

**Avoid Attachments** • Do not use tools or attachments that are not recommended by the equipment manufacturer because they may be hazardous.

## Consignes de Sécurité • Français



Ce symbole sert à avertir l'utilisateur que la documentation fournie avec le matériel contient des instructions importantes concernant l'exploitation et la maintenance (réparation).



Ce symbole sert à avertir l'utilisateur de la présence dans le boîtier de l'appareil de tensions dangereuses non isolées posant des risques d'électrocution.

### Attention

**Lire les instructions** • Prendre connaissance de toutes les consignes de sécurité et d'exploitation avant d'utiliser le matériel.

**Conservé les instructions** • Ranger les consignes de sécurité afin de pouvoir les consulter à l'avenir.

**Respecter les avertissements** • Observer tous les avertissements et consignes marqués sur le matériel ou présents dans la documentation utilisateur.

**Éviter les pièces de fixation** • Ne pas utiliser de pièces de fixation ni d'outils non recommandés par le fabricant du matériel car cela risquerait de poser certains dangers.

## Sicherheitsanleitungen • Deutsch



Dieses Symbol soll dem Benutzer in der im Lieferumfang enthaltenen Dokumentation besonders wichtige Hinweise zur Bedienung und Wartung (Instandhaltung) geben.



Dieses Symbol soll den Benutzer darauf aufmerksam machen, daß im Inneren des Gehäuses dieses Produktes gefährliche Spannungen, die nicht isoliert sind und die einen elektrischen Schock verursachen können, herrschen.

### Achtung

**Lesen der Anleitungen** • Bevor Sie das Gerät zum ersten Mal verwenden, sollten Sie alle Sicherheits- und Bedienungsanleitungen genau durchlesen und verstehen.

**Aufbewahren der Anleitungen** • Die Hinweise zur elektrischen Sicherheit des Produktes sollten Sie aufbewahren, damit Sie im Bedarfsfall darauf zurückgreifen können.

**Befolgen der Warnhinweise** • Befolgen Sie alle Warnhinweise und Anleitungen auf dem Gerät oder in der Benutzerdokumentation.

**Keine Zusatzgeräte** • Verwenden Sie keine Werkzeuge oder Zusatzgeräte, die nicht ausdrücklich vom Hersteller empfohlen wurden, da diese eine Gefahrenquelle darstellen können.

## Instrucciones de seguridad • Español



Este símbolo se utiliza para advertir al usuario sobre instrucciones importantes de operación y mantenimiento (o cambio de partes) que se desean destacar en el contenido de la documentación suministrada con los equipos.



Este símbolo se utiliza para advertir al usuario sobre la presencia de elementos con voltaje peligroso sin protección aislante, que puedan encontrarse dentro de la caja o alojamiento del producto, y que puedan representar riesgo de electrocución.

### Precaución

**Leer las instrucciones** • Leer y analizar todas las instrucciones de operación y seguridad, antes de usar el equipo.

**Conservar las instrucciones** • Conservar las instrucciones de seguridad para futura consulta.

**Obedecer las advertencias** • Todas las advertencias e instrucciones maradas en el equipo o en la documentación del usuario, deben ser obedecidas.

**Evitar el uso de accesorios** • No usar herramientas o accesorios que no sean específicamente recomendados por el fabricante, ya que podrían implicar riesgos.

## Warning

**Power sources** • This equipment should be operated only from the power source indicated on the product. This equipment is intended to be used with a main power system with a grounded (neutral) conductor. The third (grounding) pin is a safety feature, do not attempt to bypass or disable it.

**Power disconnection** • To remove power from the equipment safely, remove all power cords from the rear of the equipment, or the desktop power module (if detachable), or from the power source receptacle (wall plug).

**Power cord protection** • Power cords should be routed so that they are not likely to be stepped on or pinched by items placed upon or against them.

**Servicing** • Refer all servicing to qualified service personnel. There are no user-serviceable parts inside. To prevent the risk of shock, do not attempt to service this equipment yourself because opening or removing covers may expose you to dangerous voltage or other hazards.

**Slots and openings** • If the equipment has slots or holes in the enclosure, these are provided to prevent overheating of sensitive components inside. These openings must never be blocked by other objects.

**Lithium battery** • There is a danger of explosion if battery is incorrectly replaced. Replace it only with the same or equivalent type recommended by the manufacturer. Dispose of used batteries according to the manufacturer's instructions.

## Avvertimento

**Alimentazione** • Non fare funzionare ce matériel qu'avec la source d'alimentation indiquée sur l'appareil. Ce matériel doit être utilisé avec une alimentation principale comportant un fil de terre (neutre). Le troisième contact (de mise à la terre) constitue un dispositif de sécurité: n'essayez pas de la contourner ni de la désactiver.

**Déconnexion de l'alimentation** • Pour mettre le matériel hors tension sans danger, déconnectez tous les cordons d'alimentation de l'arrière de l'appareil ou du module d'alimentation de bureau (s'il est amovible) ou encore de la prise secteur.

**Protection du cordon d'alimentation** • Achémener les cordons d'alimentation de manière à ce que personne ne risque de marcher dessus et à ce qu'ils ne soient pas écrasés ou pincés par des objets.

**Réparation-maintenance** • Faire exécuter toutes les interventions de réparation-maintenance par un technicien qualifié. Aucun des éléments internes ne peut être réparé par l'utilisateur. Afin d'éviter tout danger d'électrocution, l'utilisateur ne doit pas essayer de procéder lui-même à ces opérations car l'ouverture ou le retrait des couvercles risquent de l'exposer à de hautes tensions et autres dangers.

**Fentes et orifices** • Si le boîtier de l'appareil comporte des fentes ou des orifices, ceux-ci servent à empêcher les composants internes sensibles de surchauffer. Ces ouvertures ne doivent jamais être bloquées par des objets.

**Lithium Batterie** • Il a danger d'explosion s'il y a un remplacement incorrect de la batterie. Remplacer uniquement avec une batterie du même type ou d'un équivalent recommandé par le constructeur. Mettre au rebut les batteries usagées conformément aux instructions du fabricant.

## Vorsicht

**Stromquellen** • Dieses Gerät sollte nur über die auf dem Produkt angegebene Stromquelle betrieben werden. Dieses Gerät wurde für eine Verwendung mit einer Hauptstromleitung mit einem geerdeten (neutralen) Leiter konzipiert. Der dritte Kontakt ist für einen Erdschluß, und stellt eine Sicherheitsfunktion dar. Diese sollte nicht umgangen oder außer Betrieb gesetzt werden.

**Stromunterbrechung** • Um das Gerät auf sichere Weise vom Netz zu trennen, sollten Sie alle Netzkabel aus der Rückseite des Gerätes, aus der externen Stromversorgung (falls dies möglich ist) oder aus der Wandsteckdose ziehen.

**Schutz des Netzkabels** • Netzkabel sollten stets so verlegt werden, daß sie nicht im Weg liegen und niemand darauf treten kann oder unmittelbar dagegen gestellt werden können.

**Wartung** • Alle Wartungsmaßnahmen sollten nur von qualifiziertem Servicepersonal durchgeführt werden. Die internen Komponenten des Gerätes sind wartungsfrei. Zur Vermeidung eines elektrischen Schocks versuchen Sie in keinem Fall, dieses Gerät selbst öffnen, da beim Entfernen der Abdeckungen die Gefahr eines elektrischen Schlags und/oder andere Gefahren bestehen.

**Schlitze und Öffnungen** • Wenn das Gerät Schlitze oder Löcher im Gehäuse aufweist, dienen diese zur Vermeidung einer Überhitzung der empfindlichen Teile im Inneren. Diese Öffnungen dürfen niemals von anderen Objekten blockiert werden.

**Lithium-Batterie** • Explosionsgefahr, falls die Batterie nicht richtig ersetzt wird. Ersetzen Sie verbrauchte Batterien nur durch den gleichen oder einen vergleichbaren Batterietyp, der auch vom Hersteller empfohlen wird. Entsorgen Sie verbrauchte Batterien bitte gemäß den Herstelleranweisungen.

## Advertencia

**Alimentación eléctrica** • Este equipo debe conectarse únicamente a la fuente/tipo de alimentación eléctrica indicada en el mismo. La alimentación eléctrica de este equipo debe provenir de un sistema de distribución con conductor neutro a tierra. La tercera pata (puesta a tierra) es una medida de seguridad, no puentearla ni eliminarla.

**Desconexión de alimentación eléctrica** • Para desconectar con seguridad la conectada de alimentación eléctrica al equipo, desenchufar todos los cables de alimentación en el panel trasero del equipo, o desenchufar el módulo de alimentación (si fuera independiente), o desenchufar el cable del receptáculo de la pared.

**Protección del cables de alimentación** • Los cables de alimentación eléctrica se deben instalar en lugares donde no sean pisados ni apretados por objetos que se puedan apoyar sobre ellos.

**Reparaciones/mantenimiento** • Solicitar siempre los servicios técnicos de personal calificado. En el interior no hay partes a las que el usuario debe acceder. Para evitar riesgo de electrocución, no intentar personalmente la reparación/mantenimiento de este equipo, ya que al abrir o extraer las tapas puede quedar expuesto a voltajes peligrosos u otros riesgos.

**Ranuras y aberturas** • Si el equipo posee ranuras o aberturas en su caja/alojamiento, es para evitar el sobrecalentamiento de componentes internos sensibles. Estas aberturas nunca se deben obstruir con otros objetos.

**Batería de litio** • Existe riesgo de explosión si esta batería se coloca en la posición incorrecta. Cambiar esta batería únicamente con el mismo tipo (o su equivalente) recomendado por el fabricante. Desachar las baterías usadas siguiendo las instrucciones del fabricante.

## 安全须知 • 中文



这个符号提示用户该设备用户手册中有重要的操作和维护说明。



这个符号警告用户该设备机壳内有暴露的危险电压，有触电危险。

### 注意

**阅读说明书** • 用户使用该设备前必须阅读并理解所有安全和使用说明。

**保存说明书** • 用户应保存安全说明书以备将来使用。

**遵守警告** • 用户应遵守产品和用户指南上的所有安全和操作说明。

**避免追加** • 不要使用该产品厂商没有推荐的工具或追加设备，以避免危险。

### 警告

**电源** • 该设备只能使用产品上标明的电源。设备必须使用有地线的供电系统供电。第三条线（地线）是安全设施，不能不用或跳过。

**拔掉电源** • 为安全地从设备拔掉电源，请拔掉所有设备后或桌面电源的电源线，或任何接到市电系统的电源线。

**电源线保护** • 妥善布线，避免被踩踏，或重物挤压。

**维护** • 所有维修必须由认证的维修人员进行。设备内部没有用户可以更换的零件。为避免出现触电危险不要自己试图打开设备盖子维修该设备。

**通风孔** • 有些设备机壳上有通风槽或孔，它们是用来防止机内敏感元件过热。不要用任何东西挡住通风孔。

**锂电池** • 不正确的更换电池会有爆炸的危险。必须使用与厂家推荐的相同或相近型号的电池。按照生产厂的建议处理废弃电池。

## 声明

所使用电源为 A 级产品，在生活环境中，该产品可能会造成无线电干扰。在这种情况下，可能需要用户对干扰采取切实可行的措施。

## FCC Class A Notice

This equipment has been tested and found to comply with the limits for a Class A digital device, pursuant to part 15 of the FCC Rules. Operation is subject to the following two conditions: (1) this device may not cause harmful interference, and (2) this device must accept any interference received, including interference that may cause undesired operation. The Class A limits are designed to provide reasonable protection against harmful interference when the equipment is operated in a commercial environment. This equipment generates, uses, and can radiate radio frequency energy and, if not installed and used in accordance with the instruction manual, may cause harmful interference to radio communications. Operation of this equipment in a residential area is likely to cause harmful interference, in which case the user will be required to correct the interference at his own expense.

**NOTE** *This unit was tested with shielded cables on the peripheral devices. Shielded cables must be used with the unit to ensure compliance with FCC emissions limits.*



# Table of Contents

---

<b>Chapter One • Introduction</b> .....	1-1
About this Manual .....	1-2
<b>The MLC 104 Plus Series MediaLink™ Controllers</b> .....	1-2
Differences between models .....	1-2
<b>About Global Configurator</b> .....	1-4
System Requirements .....	1-5
Installing Global Configurator .....	1-5
<b>Global Configurator Online Training</b> .....	1-6
<b>Chapter Two • Hardware Setup</b> .....	2-1
Front Panel.....	2-2
Right Side Panel .....	2-3
Left Side Panel and Top Panel .....	2-4
Power Connection .....	2-5
LAN Connection (IP Models Only).....	2-6
Front Panel Host Configuration Port.....	2-7
<b>Device Connections</b> .....	2-8
Display connection.....	2-8
Infrared (IR) connection .....	2-8
Digital I/O connection.....	2-8
Comm Link connection .....	2-9
MLS connection.....	2-9
<b>Chapter Three • Software Setup</b> .....	3-1
<b>Creating a Global Configurator Project File</b> .....	3-2
Step one: download device drivers .....	3-2
Step two: create a new project.....	3-4
For IP models .....	3-4
For an MLC 104 Plus (non-IP model).....	3-5
Step three: add a device and set up its connection .....	3-6
For IP models .....	3-6
For an MLC 104 Plus (non-IP model).....	3-8
Step four: define the location of the new device (IP models only).....	3-9
Step five: save the new Global Configurator file.....	3-10
<b>Configuring a New Device</b> .....	3-11
Step six: configure e-mail server (IP models only) .....	3-11
Step seven: configure e-mail messages (IP models only) .	3-12
Step eight: configure contacts (IP models only) .....	3-13

# Table of Contents, cont'd

---

Step nine: assign serial device drivers.....	3-14
Step ten: assign IR drivers.....	3-15
Step eleven: configure the front panel.....	3-16
Button caption .....	3-16
Button tool tip.....	3-16
Button repeat rate.....	3-17
Button modes.....	3-18
Switcher input.....	3-19
Button operations.....	3-20
Clear, reset, and auto fill captions.....	3-24
Step twelve: configure associated control modules.....	3-25
Step thirteen: create a shutdown schedule.....	3-27
Step fourteen: create a lamp hour notification (IP models only).....	3-29
Step fifteen: create a disconnect notification (IP models only).....	3-31
Step sixteen: build the Global Configurator file.....	3-33
Step seventeen: upload the Global Configurator file.....	3-34
Step eighteen: launch GlobalViewer (IP models only).....	3-35
Testing the GlobalViewer pages.....	3-36

*All trademarks mentioned in this manual are the properties of their respective owners.*

68-1289-01 Rev. D  
11 08



## MLC 104 Plus Series

# 1

## Chapter One

### Introduction

About this Manual

The MLC 104 Plus MediaLink® Controllers

About Global Configurator

Global Configurator Online Training

# Introduction

---

## About this Manual

This setup guide describes the

- MLC 104 Plus Series MediaLink® Controllers
- Global Configurator application
- MLC 104 Plus Series hardware installation
- MLC 104 Plus Series device connections
- MLC 104 Plus Series software configuration

## The MLC 104 Plus Series MediaLink Controllers

The Extron MLC 104 Plus Series MediaLink Controller is an easy-to-use control panel for any small classroom or meeting room. It is designed to control a wide range of smaller A/V systems. The MLC 104 Plus Series controllers standardize the control interface for all systems, making display systems simple to use. Standardization also makes setup and maintenance easier to support.

A MLC 104 Plus Series Controller acts as an extended remote control panel. It is not a switcher; instead, as a controller, it tells the display when to switch between its various inputs. Presenters with little or no training can walk into any multimedia classroom equipped with an MLC 104 IP Plus or MLC 104 Plus and operate the A/V system.

The MLC includes universal display control for a display's power, input switching, and volume control. For one-button functionality, the MLC features backlit buttons that can be custom-labeled for easy identification. Because the buttons are illuminated, they are helpful for presenters in low-light environments.

The MLC can also "learn" IR commands for centralized control of external source devices, such as DVD players and VCRs, when used with an optional Extron IRCM Infrared Control Module.

Vital for high traffic areas, the MLC is housed in a secure two-gang enclosure. It has the same look and functionality regardless of where it is mounted: a lectern, desk, wall, rack, or wall box.

## Differences between models

The MLC 104 IP Plus models are the same as the MLC 104 Plus, but with the addition of built-in IP Link® Ethernet Control. IP Link enables Web-based remote diagnostics, asset management, and support.



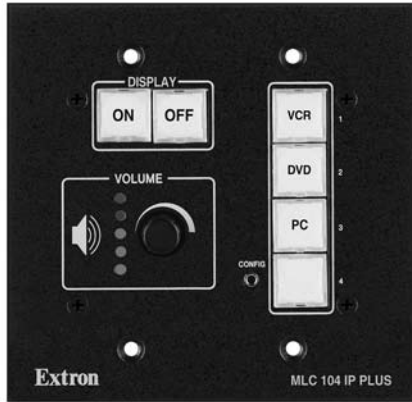

**MLC 104 IP Plus MediaLink Controller**

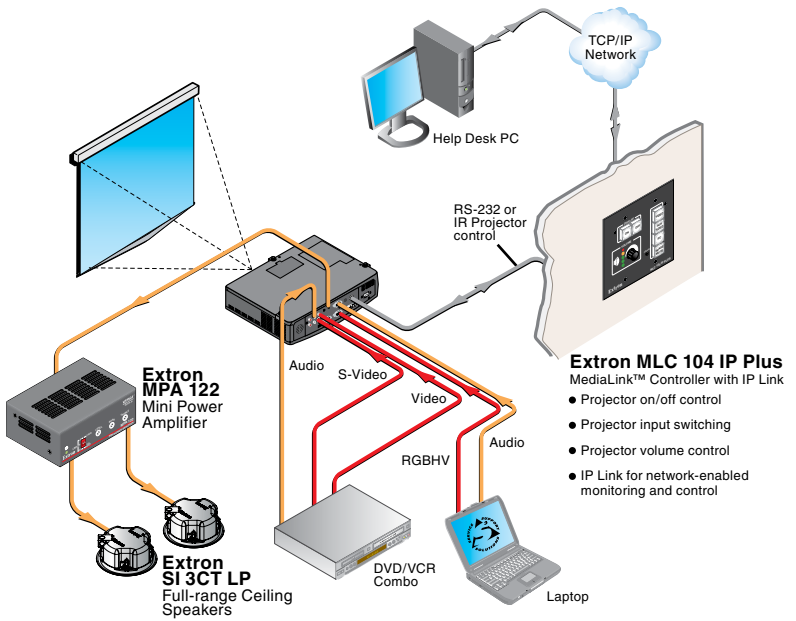

**A typical MLC 104 IP Plus installation**

## About Global Configurator

Global Configurator (GC) is a software application that gives users the ability to create a single configuration file of all of the controlled devices on their audio/video (A/V) network.

There are two types of devices in an A/V system:

**Controllers** - Control devices that have serial, relay, I/O, and infrared (IR) ports for A/V device connectivity; and, for MLC 104 IP Plus models, an IP Link enabled Ethernet port for network connectivity.

**Controlled devices** - Audio/video products, such as video projectors, displays, VCRs, DVD players, document cameras, projector screens, room lighting systems: all of the equipment that is used to generate an audio/video presentation.

Once a “global” configuration file is built, GC then generates a graphical user interface called GlobalViewer® that allows users to monitor and control all of the A/V devices contained within the GC configuration file.

When the configuration file is created, one or more of the IP Link-enabled controllers on the network can be designated as a GlobalViewer host device. The completed configuration file is uploaded to the host device(s). The GlobalViewer interface can then be launched by opening an Internet browser on a local PC and entering the host device’s IP address in the browser address field.

**NOTE** Both MLC 104 Plus and MLC 104 IP Plus models can be configured with Global Configurator, but only IP models can act as a GlobalViewer host on a network or send e-mail notifications.

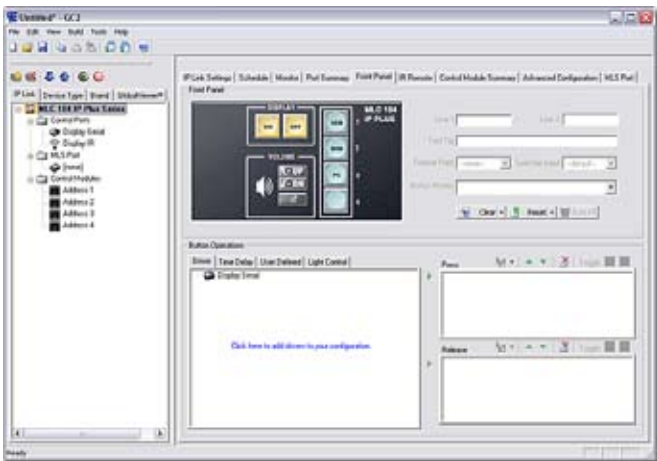

**Global Configurator application screen**

---

Using GC you can configure a single room controller, or create a web-based remote monitoring system for hundreds of A/V devices in multiple locations.

You may configure an MLC using GC without having the device physically connected to the A/V network.

**NOTE** *For MLC 104 IP Plus models, use Global Configurator version 2.2 or later. For MLC 104 Plus models, use version 2.5 or later. Update all PCs and devices running earlier versions of GC.*

## System Requirements

The minimum system requirements for the PC on which you install Global Configurator include:

- Intel® Pentium® III 1 GHz processor
- Microsoft® Windows® NT SP4, Windows 2000 SP2, or Windows XP SP2
- Microsoft Internet Explorer® 6.0 with ActiveX® enabled

**NOTE** *If ActiveX is not enabled, you may get a prompt from the browser, or you will see the “Please wait while the files are loading...” message in the GlobalViewer control page.*

- Microsoft Windows Script 5.6
- 512 MB of RAM
- 50 MB of available hard disk space
- A network connection with a minimum data transfer rate of 10 Mbps; however, 100 Mbps is recommended.

## Installing Global Configurator

Global Configurator software is available free from Extron.

To download and install Global Configurator on your PC:

1. Go to **www.extron.com**
2. Click the **Download** tab.
3. Click the **IP Link® Software** icon.
4. Click the **Global Configurator** icon.
5. Click the **Download Now** button.
6. Complete the personal information form.
7. Click the **Download GCSWxxxx.exe** button.
8. Follow the remaining system prompts.

## Introduction, cont'd

---

To install Global Configurator from an Extron Software Products CD if Autorun is enabled on your PC:

1. Insert the Extron Software Products CD into your drive.
2. Wait for the Extron Software Products page to load.
3. Click on the **Software** icon.



4. Scroll down to the Global Configurator description and click the **Install** link in the far right column.
5. Follow the remaining system prompts.

To install Global Configurator from an Extron Software Products CD if Autorun is *not* enabled on your PC:

1. Insert the Extron Software Products CD into your drive.
2. From the Windows desktop, open **My Computer** and select the **CD-ROM** drive.
3. Double click **launch.exe**.
4. Wait for the Extron Software Products page to load.
5. Click on the **Software** icon.



6. Scroll down to the Global Configurator description and click the **Install** link in the far right column.
7. Follow the remaining system prompts.

## Global Configurator Online Training

Online training for the Global Configurator application is available at [www.extron.com](http://www.extron.com).

1. Go to [www.extron.com](http://www.extron.com).
2. Log in using your e-mail address and Extron password.
3. Click the **Reseller-only** tab.
4. Click **Training and Education**.
5. Click **On-Demand Training**.
6. Click the **Global Configurator** icon.



## MLC 104 Plus Series

# Chapter Two

## Hardware Setup

Front Panel

Right Side Panel

Left Side Panel and Top Panel

Power Connection

LAN Connection

Front Host Configuration Port

Device Connection

# Hardware Setup

## Front Panel

Front panel controls must be configured using the Global Configurator application (described in chapter 3) before they become functional.

- ① **Display On/Off buttons** — Use to turn the connected display device on and off.
- ② **Input selection buttons** — Use to select the desired audio and video input to the display device. Buttons light and remain lit when selected.
- ③ **Volume knob and LEDs** — Use this knob to adjust the audio volume. LEDs provide a visual indication of the current volume level.
- ④ **Front panel Config port** — A 2.5 mm mini stereo jack provides an RS-232 connection for configuration and control. Use Extron configuration cable part #70-335-01 (9-pin D female to 2.5 mm TRS) to connect a control PC to this port.

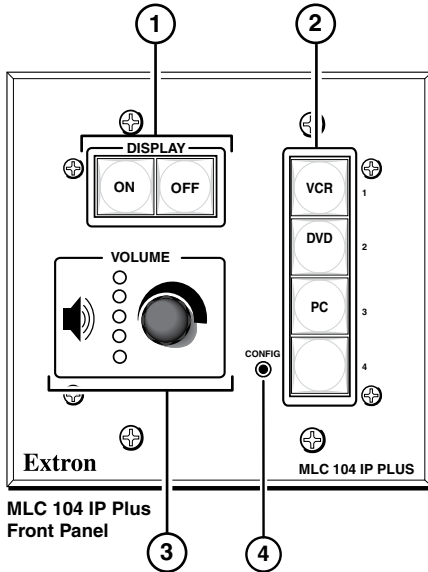

## Right Side Panel

Connectors on the unit's right side panel are described below.

- ① **Display RS-232 / IR port** — Dedicated bidirectional port for communication to a projector or display via RS-232 and/or infrared control.
- ② **Comm Link** — This port can be used to connect
  - up to four control modules (IRCMs, ACMs, RCMs, CMs)
  - one Extron IR signal repeater (IRL 20 or IR Link)
  - two SCP 104 control panels
- ③ **Digital I/O** — Configurable as a digital input or digital output to connect to devices such as sensors, switches, LEDs, and relays.
- ④ **MLS RS-232** — Use to control an optional Extron switcher, or other RS-232 device.
- ⑤ **PWR** — Use to connect the supplied 12 VDC power supply.
- ⑥ **LAN (IP models only)** — Use to connect to a local area network.

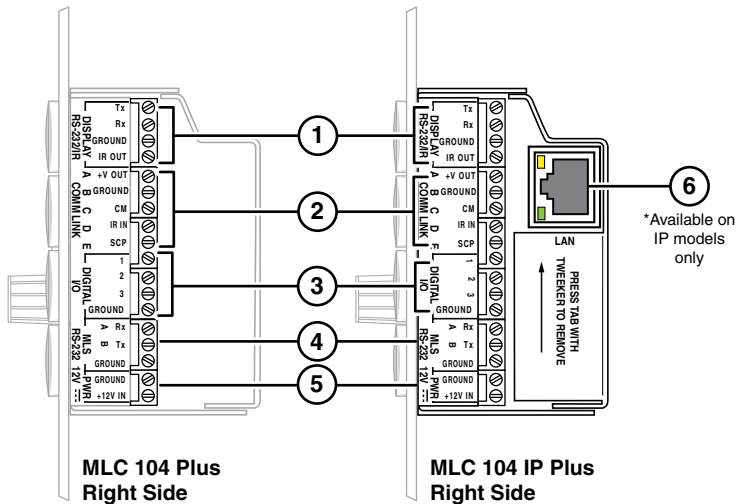

# Hardware Setup, cont'd

## Left Side Panel and Top Panel

Controls on the left side panel and top panel are described below.

- ① **Reset Button** — Recessed button used to reset the device. See the *MLC 104 Plus Series Reference Manual* for available reset modes.
- ② **Reset LED** — Green LED that flashes to indicate reset mode.
- ③ **IR Learning Sensor** — Receives and “learns” infrared commands from other devices’ remote controls to create an IR driver. Accepts infrared signals from 30 kHz to 62 kHz.

**NOTE** Download IR Learner software from [www.extron.com](http://www.extron.com). The MLC 104 Plus requires IR Learner version 1.23 or higher.

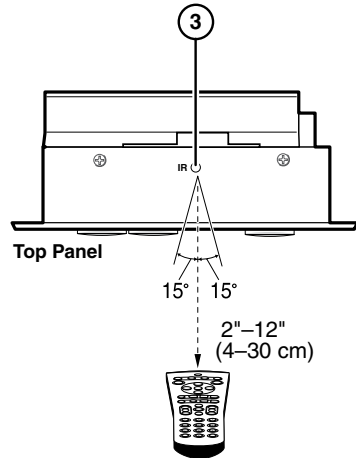
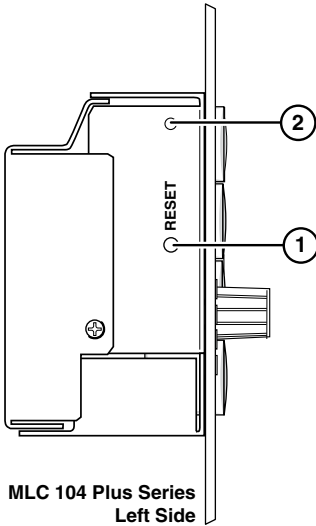



## Power Connection

To connect the external 12 VDC power supply:

1. Strip the ends of the power supply wires as shown in the diagram below.
2. Connect the stripped wires to the MLC's PWR port as shown in the diagram below.

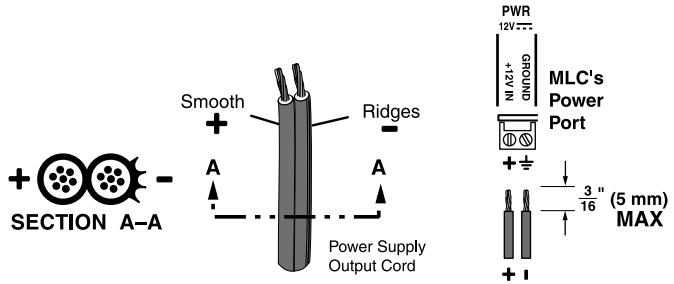

3. Connect the AC power cord between the power supply and an AC power outlet.

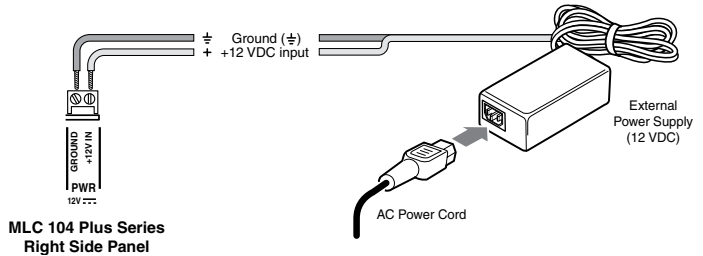

# Hardware Setup, cont'd

## LAN Connection (IP Models Only)

Connect a straight-through Ethernet cable to the LAN connector if you are connecting to a switch, hub, or router on your network.

Connect a crossover Ethernet cable to the LAN connector if you are connecting directly to a PC.

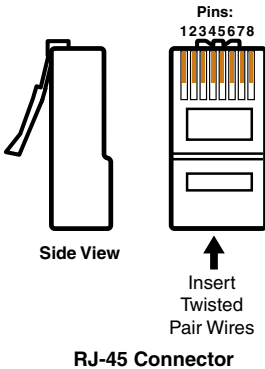
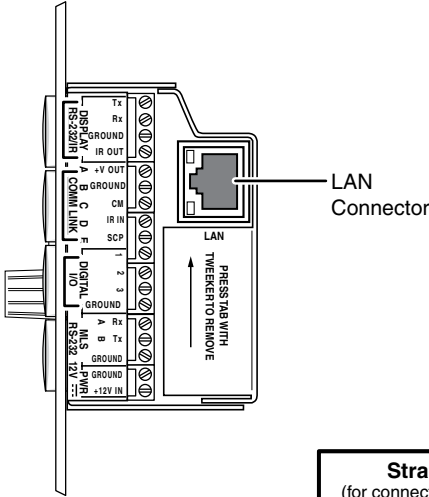

Straight-through Cable			
(for connection to a switch, hub, or router)			
Pin	End 1 Wire Color	Pin	End 2 Wire Color
1	white-orange	1	white-orange
2	orange	2	orange
3	white-green	3	white-green
4	blue	4	blue
5	white-blue	5	white-blue
6	green	6	green
7	white-brown	7	white-brown
8	brown	8	brown

Crossover Cable			
(for direct connection to a PC)			
Pin	End 1 Wire Color	Pin	End 2 Wire Color
1	white-orange	1	white-green
2	orange	2	green
3	white-green	3	white-orange
4	blue	4	blue
5	white-blue	5	white-blue
6	green	6	orange
7	white-brown	7	white-brown
8	brown	8	brown

---

## Front Panel Host Configuration Port

A 2.5 mm mini stereo jack that provides an RS-232 connection for configuration and control.

Use Extron configuration cable part #70-335-01 (9-pin D female to 2.5 mm TRS) to connect a control PC to this port.

**NOTE** *The MLC 104 Plus (units without a LAN connection) can be configured only by this method.*

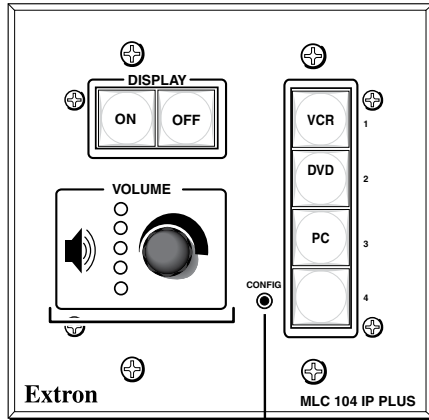

Front Panel

Front Panel Host Configuration Port

# Hardware Setup, cont'd

## Device Connections

The following illustrations show examples of A/V and control device connections for all models.

### Display connection

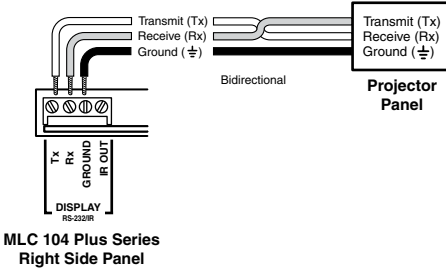

### Infrared (IR) connection

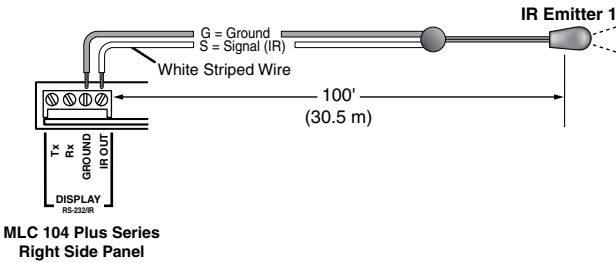

### Digital I/O connection

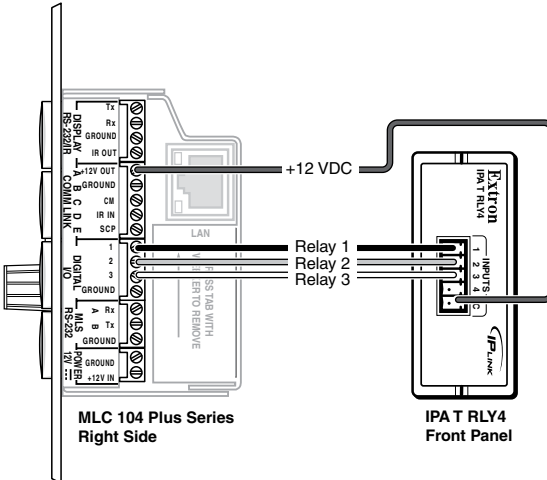

# Comm Link connection

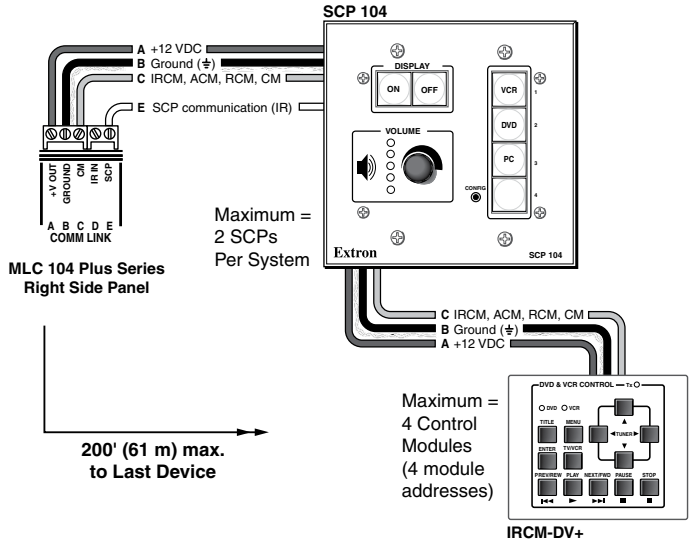

### Extron CTLP Cable Color Code:

- A +12 VDC = Red
- B Ground (⊕) & Drain Wire = Black & Drain Wire
- C Control Module Communication = Violet
- E SCP Communication = White

**NOTE** When an SCP 104 is connected to one of these controllers, the SCP's DIP switch #4 must be in the ON (up) position.

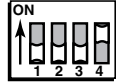

# MLS connection

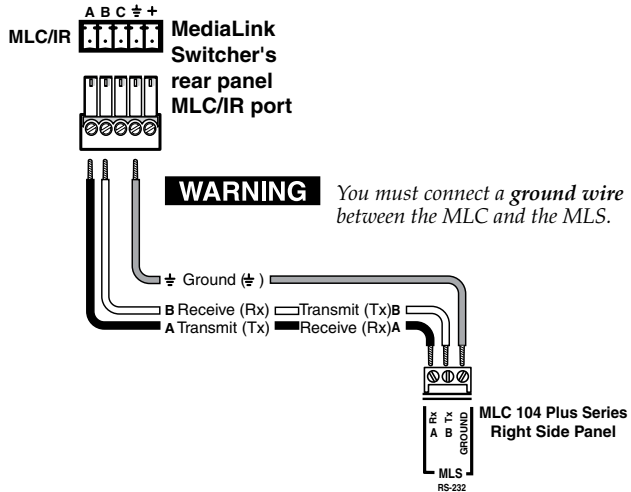





**MLC 104 Plus Series**

# 3

## **Chapter Three**

### **Software Setup**

Creating a Global Configurator Project File

Configuring a New Device

Testing the GlobalViewer™ Pages

# Software Setup

## Creating a Global Configurator Project File

After you have installed Global Configurator (GC) software on your PC, follow the steps in this chapter to configure your devices.

**NOTE** For MLC 104 IP Plus models, use Global Configurator version 2.2 or later. For MLC 104 Plus models, use version 2.5 or later.

### Step one: download device drivers

Software drivers for your audio/video devices are available free from the Extron web site at [www.extron.com](http://www.extron.com).

To download device drivers:

1. Click **Start > Programs > Extron Electronics > GC2.X.X** or double-click the **GC 2** icon on your desktop to launch the Global Configurator application.



2. Click the **Add Driver Subscriptions** button.

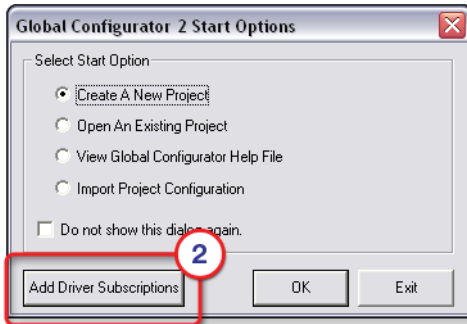

3. Select a **Manufacturer**.
4. Select a **Device Type**.

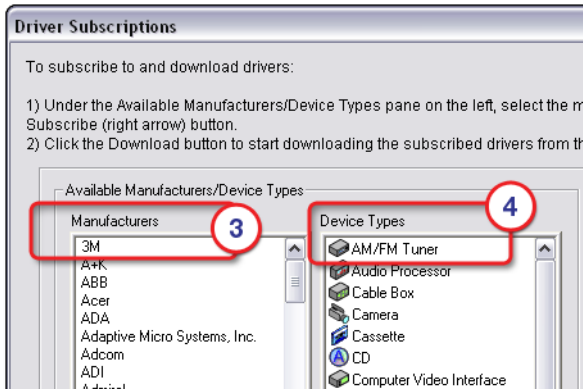



- Click the **Right Arrow (Subscribe)** button.

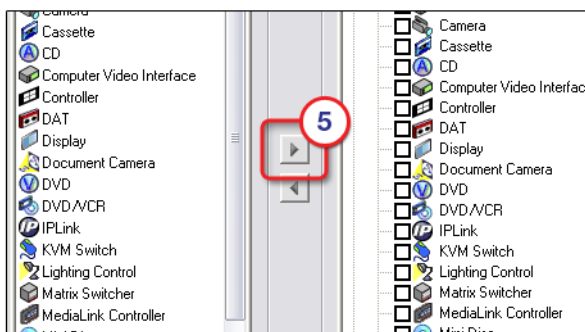

- Repeat steps 3 through 5 for each type of device you plan to add to your audio/video network.
- Click the **Download** button.

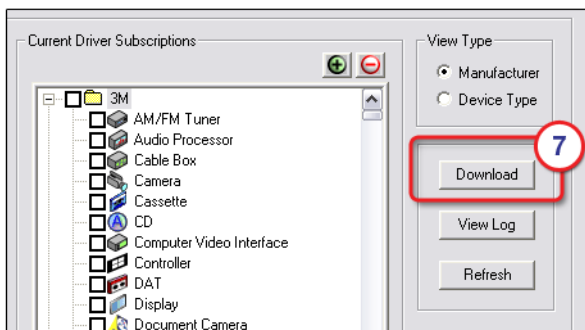

The **Download Complete** dialog box opens.

- Click the **Close** button.

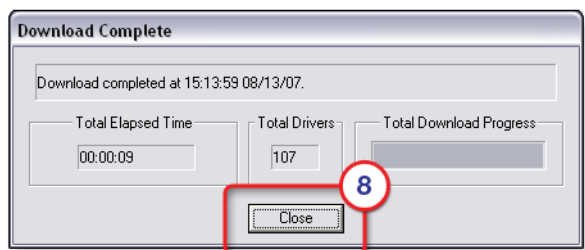

- Click **OK** to return to the Start Options dialog box.

## Software Setup, cont'd

---

### Step two: create a new project

To create a new Global Configurator project file:

1. Select **Create a New Project**.
2. Click **OK**.

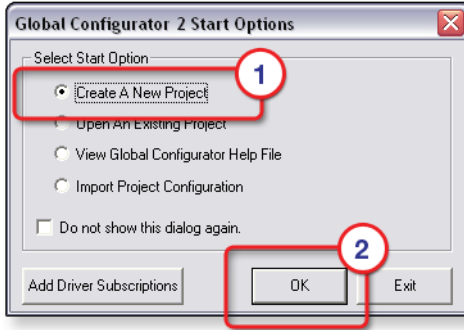

The Project Settings dialog box opens.

#### For IP models

3. For IP models, enter the IP address of the first device you will add to your GC project file in the Next Assigned IP Address field.
4. Make the desired Date/Time selections.

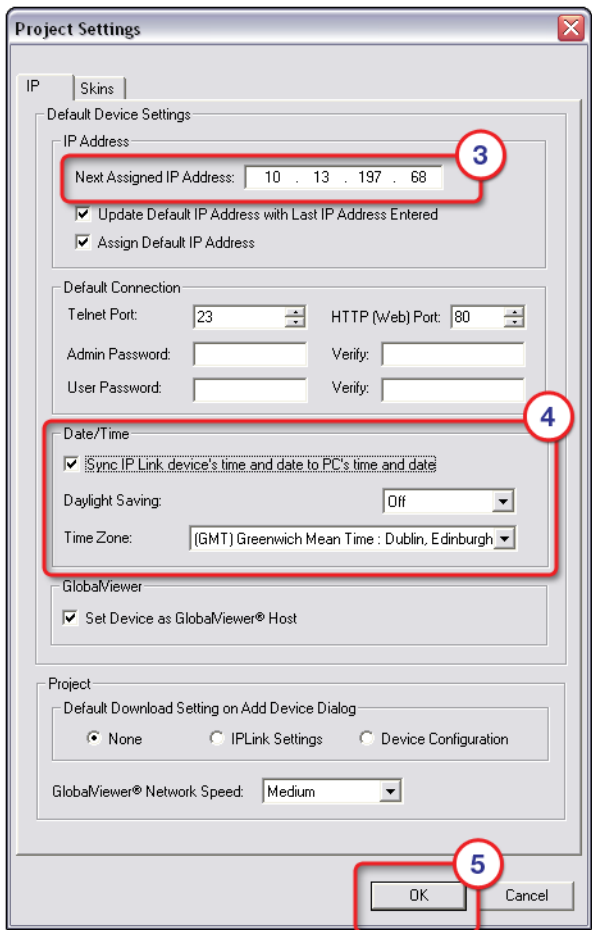

5. Click **OK**. The Add Device dialog box opens.

**For an MLC 104 Plus (non-IP model)**

3. Click **Cancel**. The Add Device dialog box opens.

### Step three: add a device and set up its connection

#### For IP models

For IP models, obtain the following information from your network administrator:

- IP address / hostname
- gateway IP
- subnet
- Telnet port
- web port
- passwords

1. Select **MLC 104 IP Plus Series** from the IP Link Device drop-down list.
2. Enter an **IP Address** in the Name/IP Address field (or leave the default address).
3. Enter a unique **Display Name**.
4. Click **Make this device a GlobalViewer Host** (if desired).
5. Click the **Advanced** button. This opens additional Add Device screen options and changes the **Advanced** button to read **Basic**. If you wish to return to the basic screen options, click the **Basic** button.

The screenshot shows the 'Add Device' configuration window. It features a title bar 'Add Device' and a dropdown menu for 'IP Link Device' set to 'MLC 104 IP Plus Series'. Below this is a 'Select Connection Method' section with radio buttons for 'TCP' (selected) and 'Serial'. Under the 'TCP' section, there are three input fields: 'Name/IP Address' with the value '10.13.197.68', 'Display Name' with the value 'MLC 104 IP Plus Series', and a checked checkbox for 'Make this device a GlobalViewer® Host'. To the right of these fields is an 'Advanced >>>' button. Red boxes and numbered circles (1-5) highlight these elements: 1 points to the IP Link Device dropdown, 2 points to the Name/IP Address field, 3 points to the Display Name field, 4 points to the checkbox, and 5 points to the Advanced button.

6. If the device you are adding is password protected, enter the appropriate **Admin** and **User** passwords. The default condition is no Admin or User password.
7. Click **Auto Configure IP Address**.
8. Enter the device's MAC address (found on a label on the rear of the device).
9. Click **Set**. The Auto Configure Successful dialog box is displayed.

The screenshot shows the 'Add Device' dialog box. At the top, 'IP Link Device' is set to 'MLC 104 IP Plus Series'. Under 'Select Connection Method', 'TCP' is selected. In the 'TCP' section, 'Name/IP Address' is '10.13.197.68', 'Display Name' is 'MLC 104 IP Plus Series', and 'Make this device a GlobalViewer® Host' is checked. 'Telnet Port' is 23 and 'Web Port' is 80. 'Admin Password' and 'User Password' fields are empty. Under 'Download Settings', 'None' is selected. 'Auto Configure IP Address' is checked. The 'MAC Address' field contains '00-05-A6-01-6B-E0'. A 'Basic <<<' button is at the top right, and a 'Set' button is at the bottom right. Red circles with numbers 5 through 9 highlight these elements: 5 (Basic <<< button), 6 (Admin and User Password fields), 7 (Auto Configure IP Address checkbox), 8 (MAC Address field), and 9 (Set button).

10. Click **OK**.



# Software Setup, cont'd

---

## For an MLC 104 Plus (non-IP model)

1. Select **MLC 104 Plus Series** from the IP Link Device drop-down list.

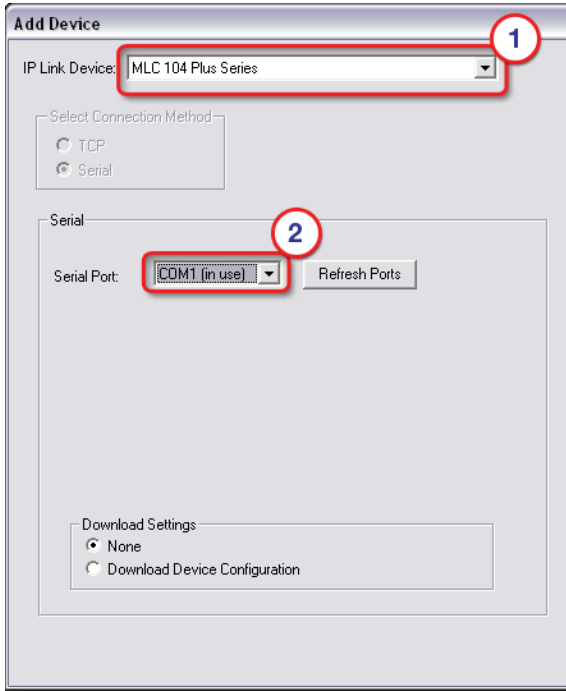

2. Click **OK**.

---

## Step four: define the location of the new device (IP models only)

Global Configurator allows you to keep track of the devices on your audio/video network by creating a custom tree of folders in which you can place and organize your audio/video devices. This GlobalViewer Tree can be up to eight levels deep and have multiple folders in each level.

To move your newly added device to a location folder, with the Add Device dialog box still open:

1. Click the **New Location** folder icon in the GlobalViewer Tree window. You can create up to eight levels of location folders.
2. Enter a unique location name for the new folder and keep the new location folder selected.
3. Click **OK**. The new device is added to the selected location folder and the Add Device dialog box closes.

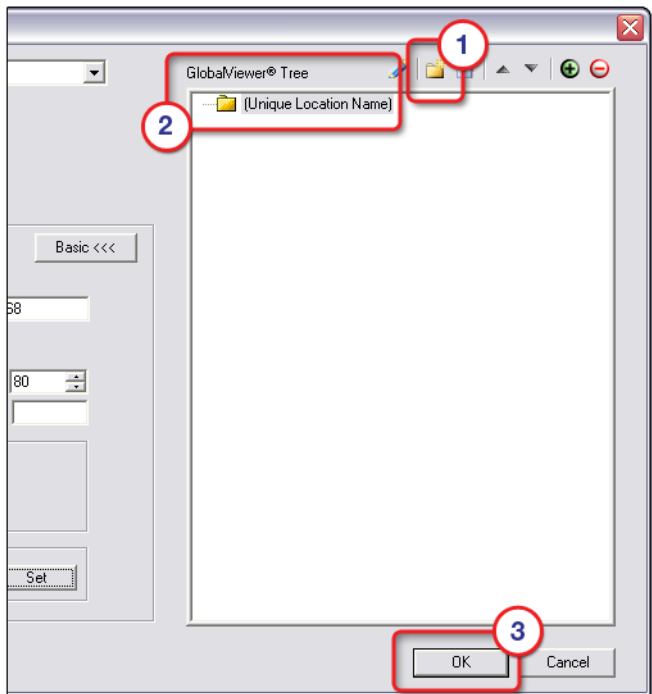

## Software Setup, cont'd

### Step five: save the new Global Configurator file

To save the new GC project file:

1. Click **File > Save** - or - click the **Save** icon.

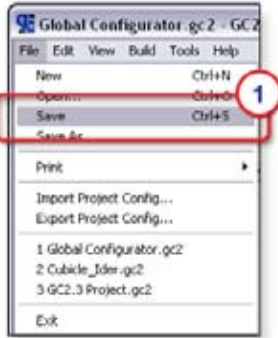

If the file has not previously been saved, the Save As dialog box opens.

2. Enter a unique name in the Project Name field.
3. Click the browse button to browse to the desired file location.
4. Click **OK**.

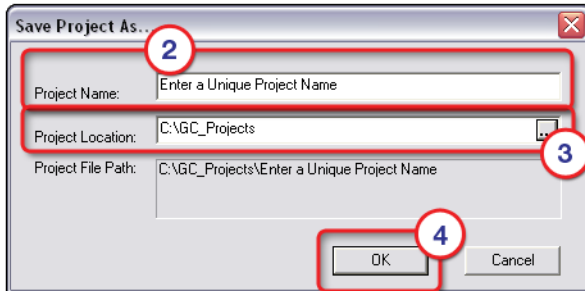



---

## Configuring a New Device

### Step six: configure e-mail server (IP models only)

Obtain the following from your network administrator:

- Mail server IP
- Mail server domain
- SMTP username and password

**NOTE** *Device must be online to change device settings.*

To set the e-mail server configuration:

1. Click **Tools > Change Device Settings...**

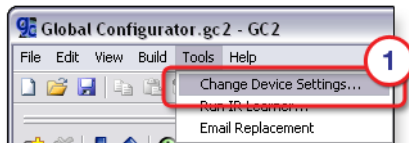

The Device Settings window opens.

2. Select a device.

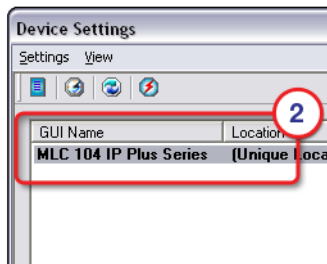

3. Click **Settings > Set Mail Server...**

The Mail Server dialog box opens.

4. Enter the network's mail server IP information.
5. Click **OK**.

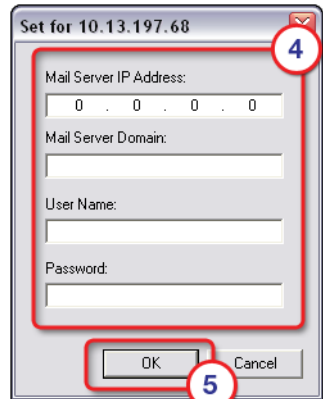

## Software Setup, cont'd

### Step seven: configure e-mail messages (IP models only)

The Email Manager dialog box is used to create custom e-mails that are delivered as directed by the settings in the GC Schedule and Monitor dialog boxes. To create custom e-mails:

1. Click **Edit > Email Manager...**

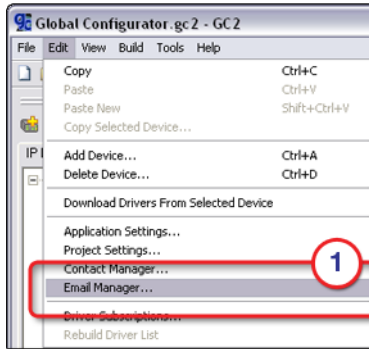

2. Complete the Name, Subject, and Body fields.
3. Click **Add**.
4. Repeat steps 2 and 3 for each new e-mail message.
5. Click **Done**.

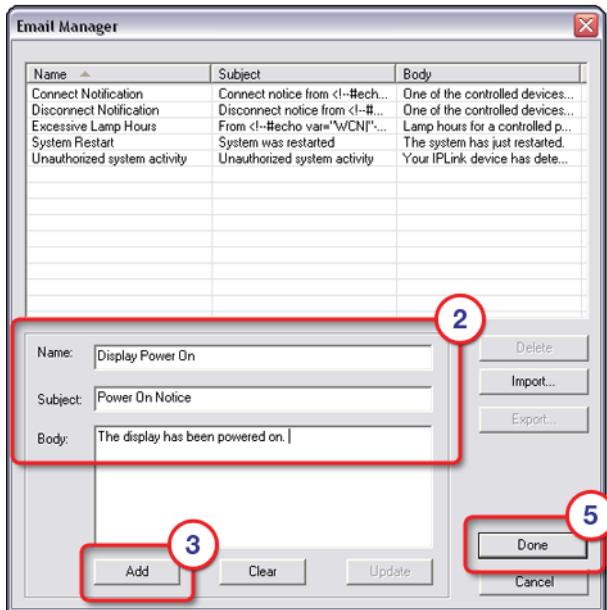

---

## Step eight: configure contacts (IP models only)

The Contact Manager dialog box is used to enter the name, e-mail address, and company name of the network's contacts.

To configure contacts:

1. Click **Edit > Contact Manager...**

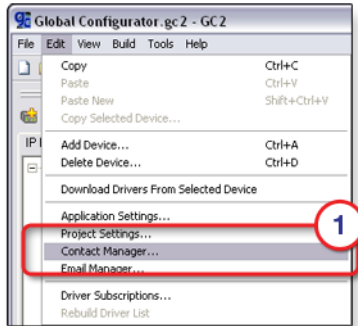

2. Complete the Name, Email, and Company fields.
3. Click **Add**. The contact information is added.

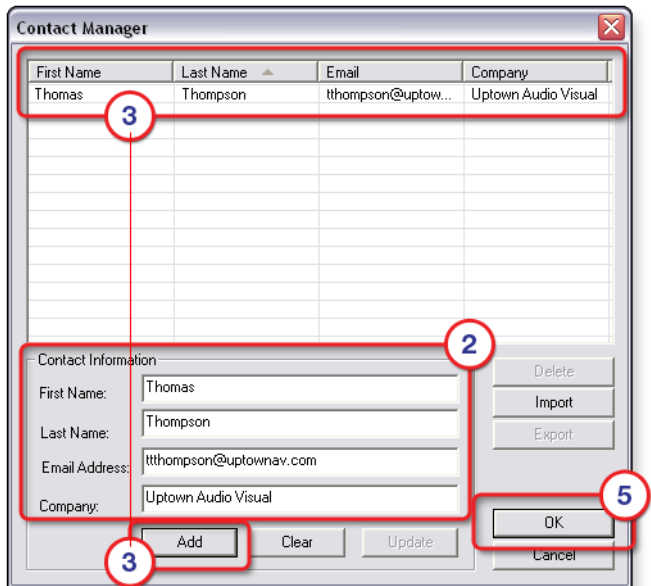

4. Repeat steps 2 and 3 for each additional contact.
5. Click **OK**.

## Software Setup, cont'd

### Step nine: assign serial device drivers

The Serial Configuration tab of Global Configurator allows you to assign a device driver to each serial port of the device.

To assign a device driver:

1. Select a serial port in the IP Link Tree window.



The Serial Configuration tab opens.

2. Select **Serial** in the Port Type field.
3. Select a device type, manufacturer, and version.
4. Select an available driver.
5. Click **Add Driver**.

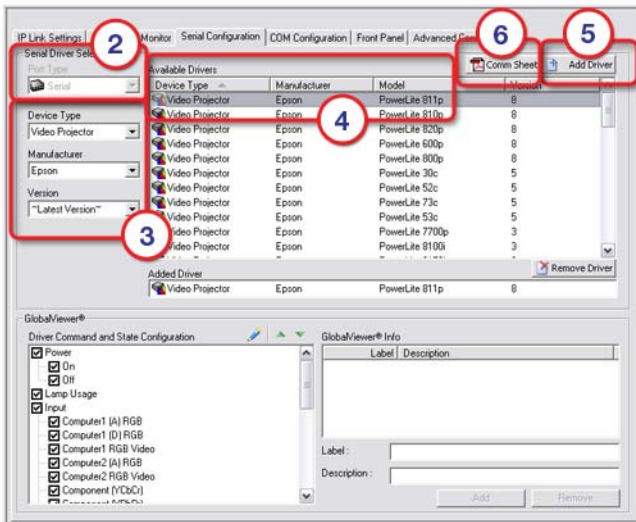

6. If desired, click **Comm Sheet** to open an file with information about the selected driver.

## Step ten: assign IR drivers

The IR Configuration tab of Global Configurator allows you to assign a device driver to each IR port of the device.

To assign an IR device driver:

1. Select an IR port in the IP Link Tree window.

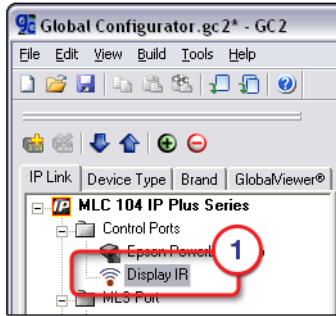

The IR Configuration tab opens.

2. Select **IR** in the Port Type field.
3. Select a device type, manufacturer, and version.
4. Select an available driver.
5. Click **Add Driver**.

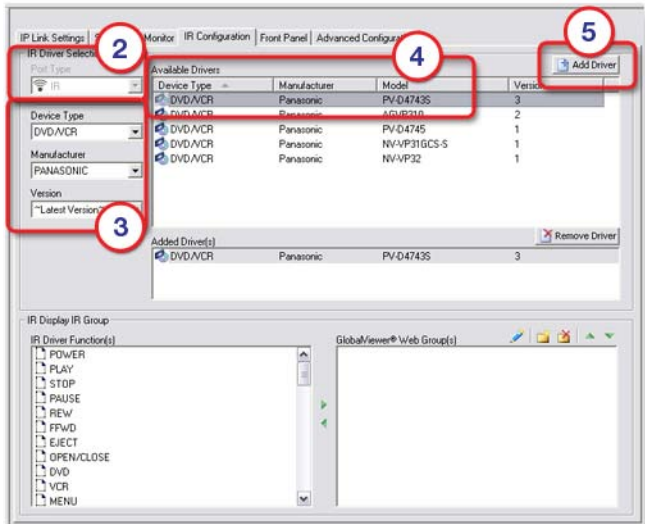

## Step eleven: configure the front panel

The Front Panel tab provides a graphical representation of the MLC's front control panel. It gives you the ability to:

- Configure the operations of the front control panel buttons
- Configure the captions and functions of the control buttons that are displayed in the GlobalViewer interface.

### Button caption

A caption can be set for each button in the front panel display. To set a button caption:

1. Select a control button.
2. Enter the top caption text in Line 1 (if desired).
3. Enter the bottom caption text in Line 2 (if desired).

In the example below Line 1: **Power**, and Line 2: **On**, are displayed in the top and bottom fields of the selected button.



### Button tool tip

A tool tip is a descriptive line of text that is displayed in the GlobalViewer interface when the cursor is positioned over a button.

To set a tool tip:

1. Select a control button.
2. Enter the desired text in the Tool Tip field.

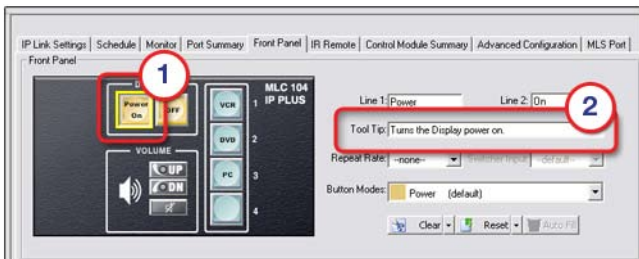

## Button repeat rate

The repeat rate is how quickly a button will repeat its function if the button is held down.

Example: If you have configured a button as an increment volume button, and given it a repeat rate of 1.00 second, as long as you keep this button pressed (the front panel button *or* the GlobalViewer button) the “increment volume” command will be sent every 1.00 second.

To set a repeat rate:

1. Select a control button.
2. Select a rate from the Repeat Rate drop-down list.

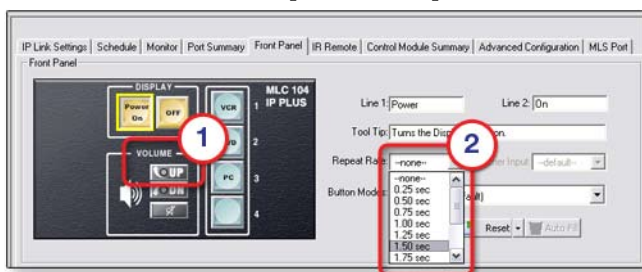

# Software Setup, cont'd

## Button modes

The Set Button Modes options allow the user to apply three different modes of operation for all buttons on the MLC's front panel.

Button modes of operation are:

- **Single Switch** — the pushbutton switch performs the same function each time it is pressed.
- **Toggle** — you can assign two different actions to subsequent depressions of the same pushbutton.
- **Input** — when this button is activated, the audio or video input signal that has been associated with this pushbutton is sent to the display device.
- **Group (X)** — when multiple pushbuttons are assigned to a group, only one can be active at a time. When one button is activated, it deactivates any other currently active button.

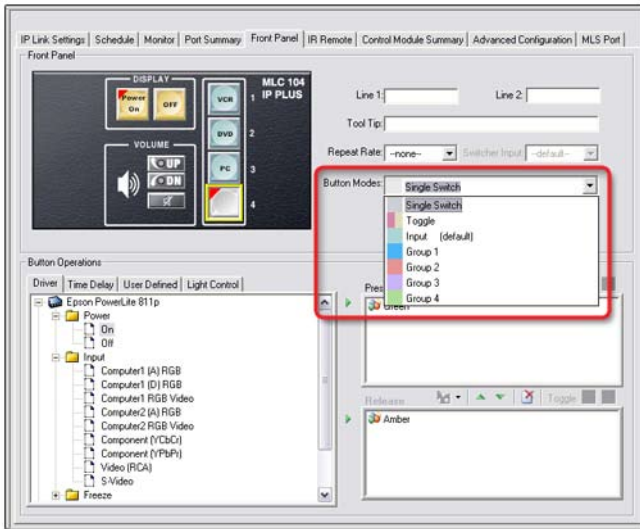



## Switcher input

The Switcher Input field allows you to assign a specific input from an attached MediaLink Switcher (MLS) to a specific input button on the MLC's front panel (only applies to a button in input mode).

To assign a switcher input:

1. Select one of the four input buttons.
2. Select a switcher input number from the drop-down list.

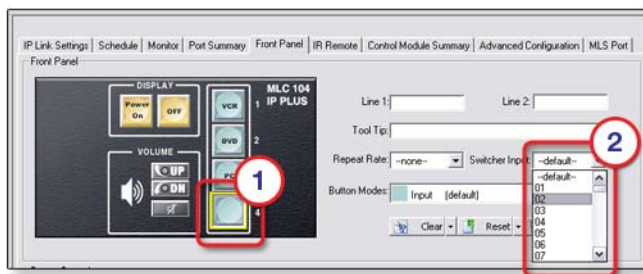

# Software Setup, cont'd

## Button operations

Selected functions in the Button Operations area of the window are moved to the Press, or Release windows to be assigned to the press or release action of the selected button.

Tabs in the Button Operations area include:

- Driver
- Time Delay
- User Defined
- Light Control

To assign a **driver function** to a button:

1. Select a button.
2. Click the Button Operations **Driver** tab.
3. Select a device and expand its folder (click the + sign).
4. Expand the desired operation.
5. Select the desired function.
6. Drag the selected function to either the Press or Release window.

- or -

Use one of the green right arrow buttons (▶) to move the selected function to either the Press or Release window.

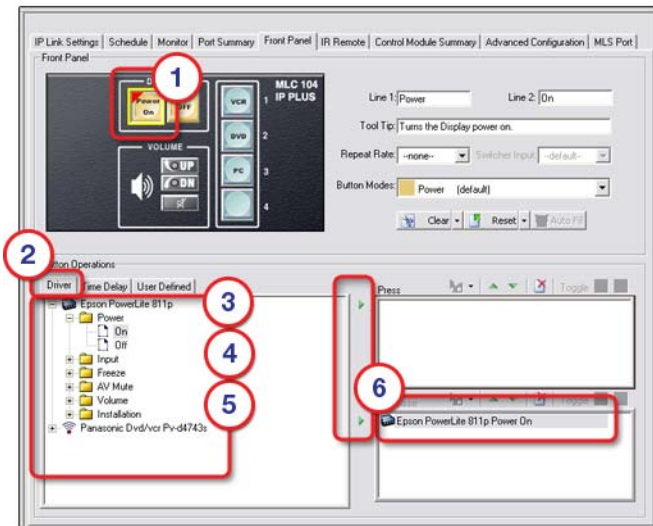

When you add multiple functions to a front panel button, you may want to insert a time delay between the functions. The Button Operations **Time Delay** tab provides the capability to add a delay of from 1 second to 180 seconds to the press or release action of a button.

To add a **time delay**:

1. Select a front panel button.
2. Click the Button Operations **Time Delay** tab.
3. Expand the Time Delay function (click the + sign).
4. Enter the desired number of seconds (1 - 180) in the Wait field.
5. Drag the Wait icon to either the Press window or the Release window.

- or -

Click one of the green right arrows (▶) to move the Wait function to the Press window or the Release window.

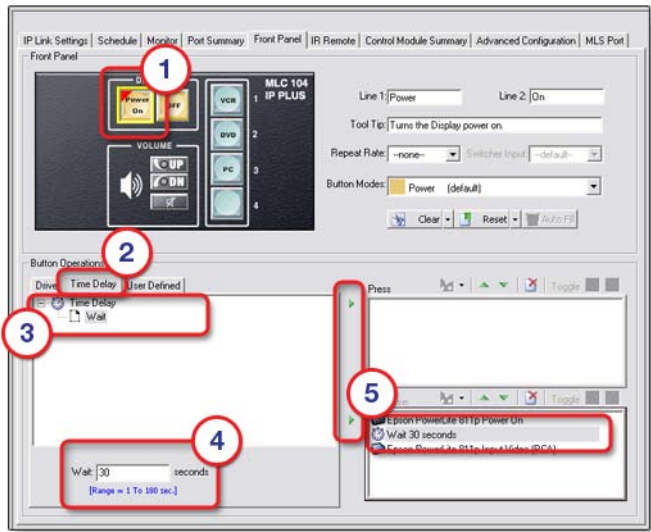

## Software Setup, cont'd

The Button Operations **User Defined** tab allows users to add button functionality that is not predefined by entering ASCII strings or Extron Simple Instruction Set (SIS™) commands in the Command field and moving those commands to the Press window or the Release window. The User Defined tab is only functional with serial ports.

For a listing of ASCII codes, click **View > View ASCII Chart**.

To add a **user defined** command:

1. Select a front panel button.
2. Click the Button Operations **User Defined** tab.
3. Expand a serial port.
4. Click **User Defined Command**.
5. Enter your desired ASCII command string in the Command window.
6. Drag the user defined command to the Press window or the Release window.

- or -

Use the green right arrow buttons (▶) to move the user defined command to the Press window or the Release window.

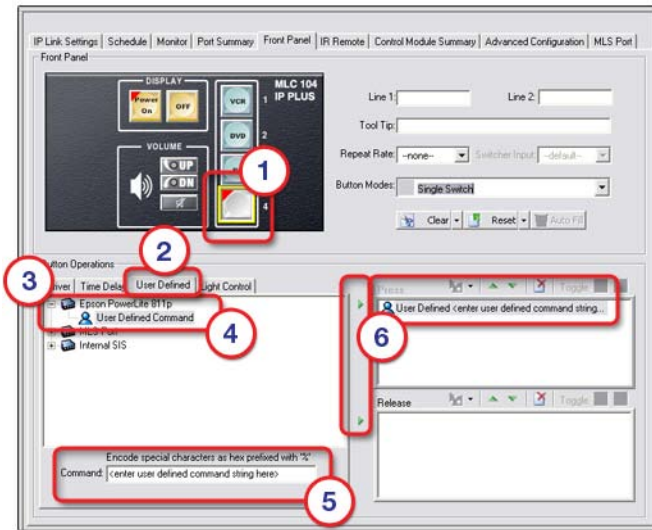

The Button Operations **Light Control** tab allows users to assign an indicator color to the Press and Release actions of selected buttons. Color changes are reflected on both the physical front panel button and the virtual front panel button in the GlobalViewer® interface (only applies to buttons in single switch or group mode).

Indicator color options are:

- Off
- Green
- Red
- Amber

Indicator blink options are:

- No Blink
- Slow Blink
- Fast Blink

To assign an **indicator color** to a button:

1. Select a button.
2. Click the Button Operations **Light Control** tab.
3. Expand a No Blink, Slow Blink, or Fast Blink folder.
4. Drag the desired color icon (Off, Green, Red, Amber) to either the Press or Release window.

- or -

Use the green right arrows (▶) to move the desired color to the Press window or the Release window.

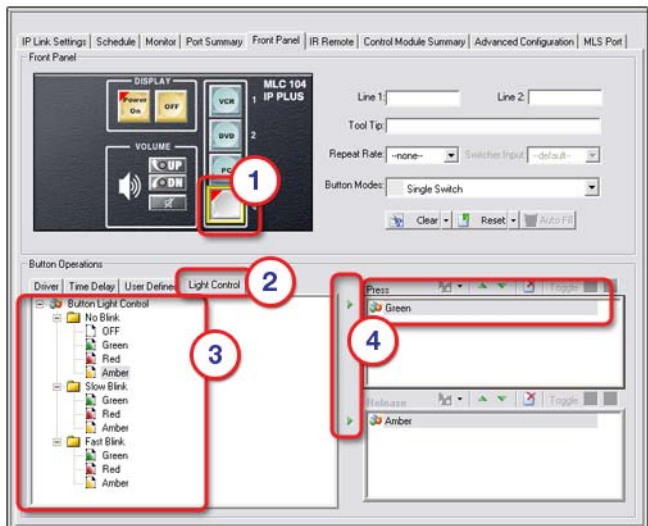

# Software Setup, cont'd

## Clear, reset, and auto fill captions

Use the Clear button to clear all front panel button caption text.

Use the Reset button to delete all operations on the front panel buttons and reset the captions to their factory default text.

The Auto Fill button is not active on the front panel tab. It is active on the Address tab when a control module is selected in the IP Link Tree window.

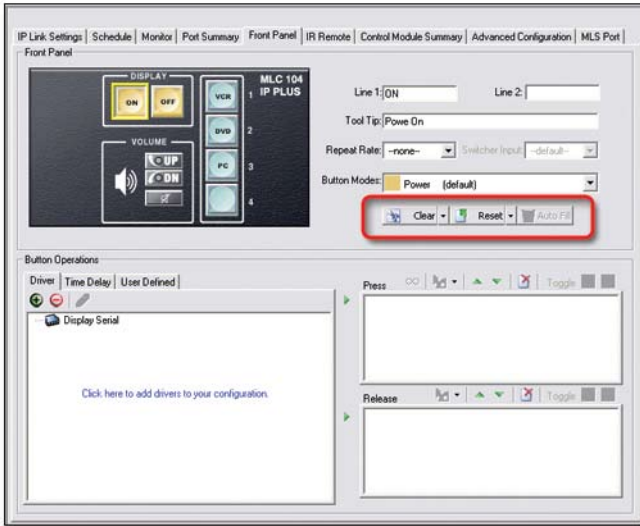

---

## Step twelve: configure associated control modules

A control module is a faceplate with buttons that can be associated with the MLC.

The buttons on a control module can be configured to perform specific device operations, such as power on a device or raise/lower audio volume.

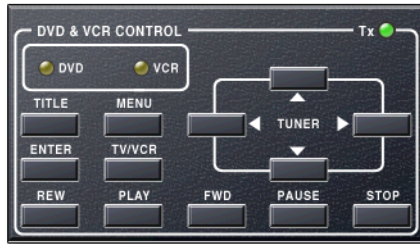

The Control Module Summary tab is used to configure the button operations of a control module.

To configure a control module:

1. Select a control module address in the IP Link Tree window.

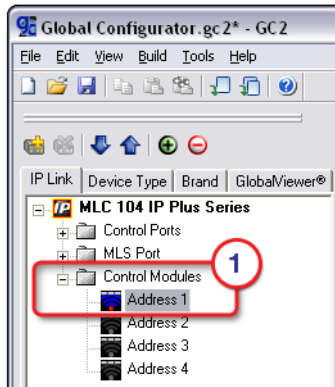

## Software Setup, cont'd

2. Select an available control module.
3. Click the **Add** (right arrow, ►) button.

The new control module is displayed in the Control Module Summary field and in the IP Link Tree window.

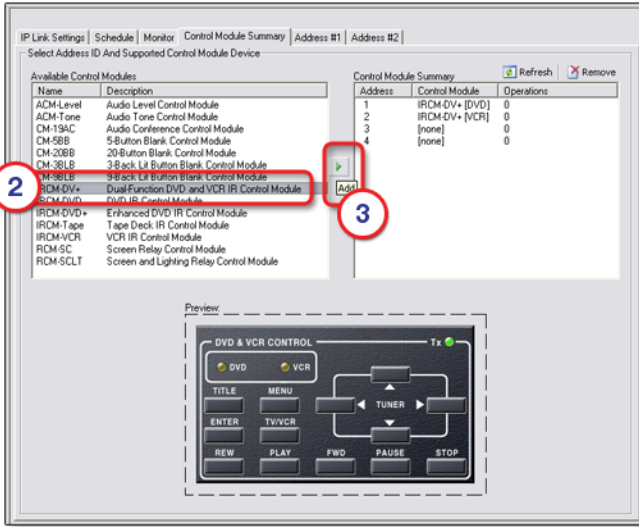

4. Select the newly assigned control module's Address in the IP Link Tree window.

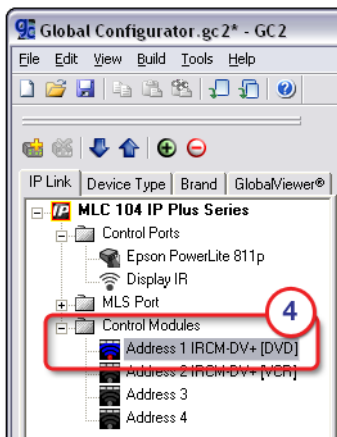

5. Select the desired button on the control module and add button operations as described in “Step eleven: configure the front panel.”



---

## Step thirteen: create a shutdown schedule

Global Configurator's scheduling feature enables you to schedule specific actions to occur for a selected device. As an example, scheduling is useful to set network projectors to power off at the end of the day to prevent idle lamp usage.

To set a display shutdown schedule:

1. Click the **Schedule** tab.
2. Click the **Add Schedule** button.

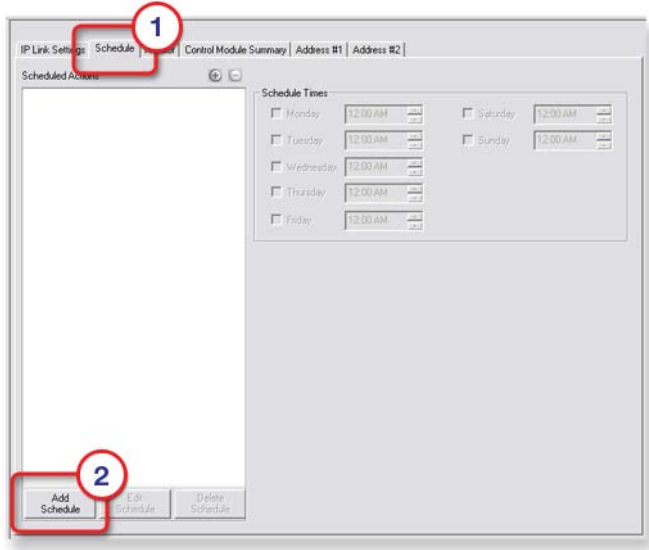

## Software Setup, cont'd

3. Enter a unique name in the Schedule Action Name field.
4. Set the desired schedule times.
5. Click **Next**.

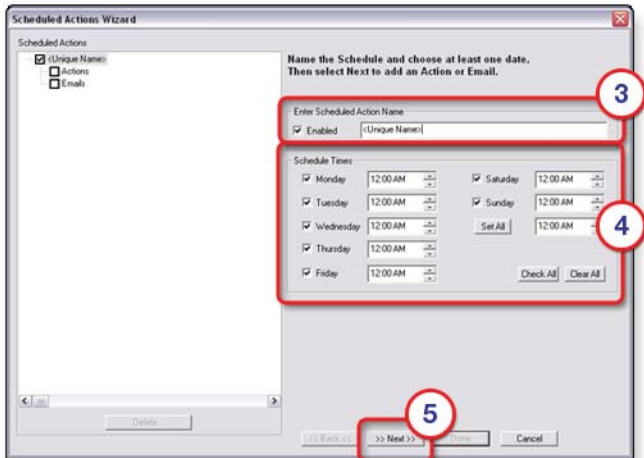

6. Select the desired Subject Port (device).
7. Select the Available Option **Power Control - Off**.
8. Click **Apply Action**.

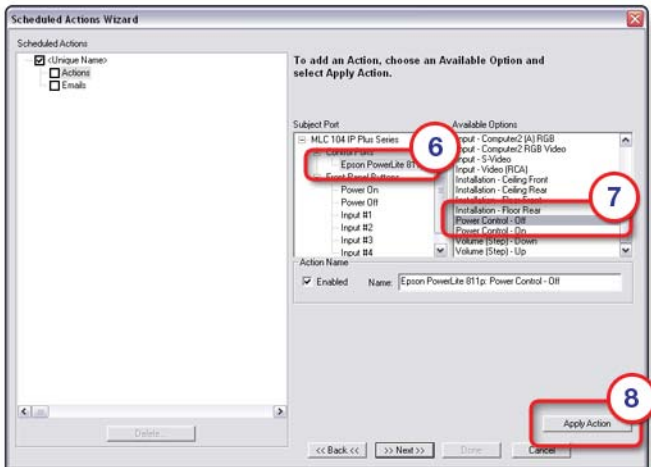

9. Click **Done**.

---

## Step fourteen: create a lamp hour notification (IP models only)

Global Configurator's monitoring feature enables you to configure IP Link devices to monitor many parameters of their connected audio/visual devices. This feature can be used to monitor lamp usage hours and send an e-mail alert to the network administrator if a display's lamp is nearing expiration.

To create a display (projector) lamp hour warning e-mail:

1. Click the **Monitor** tab.
2. Click the **Add Monitor** button.

The Monitored Conditions Wizard dialog box opens.

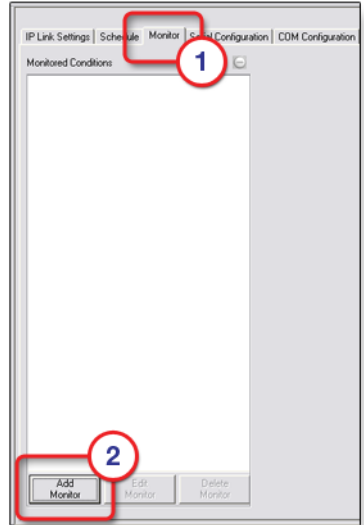

3. Enter a unique name in the Monitored Condition Name field.
4. Click **Next**.

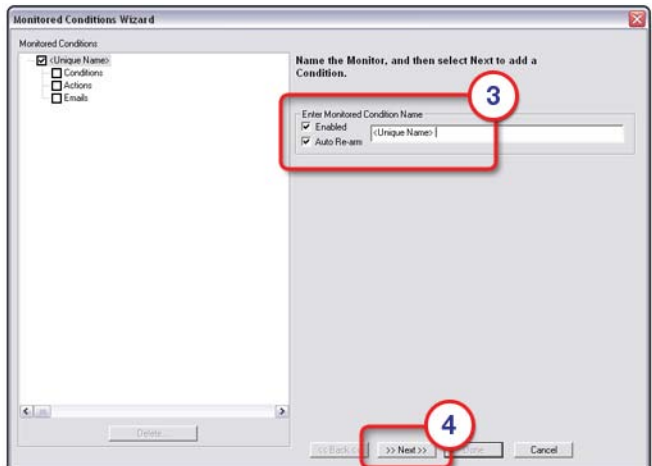

## Software Setup, cont'd

5. Select a subject port or device.
6. Select Available Options **Lamp Usage: Value**.
7. Select **Is Greater or Equal** in the Display: Lamp Usage Value field.
8. Enter a number (hours) that is less than the lamp's anticipated burn-out spec in the Lamp Usage Value field.
9. Click **Apply Condition**.
10. Click **Next**.
11. Click **Next** a second time to add an e-mail notification.

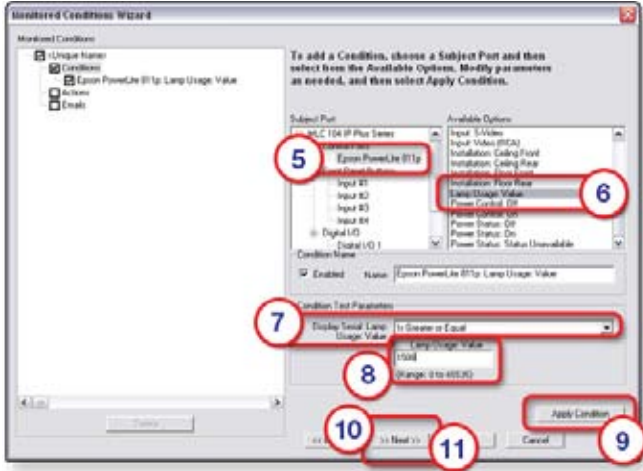

12. Select Email Messages **Excessive Lamp Hours**.
13. Select the desired contacts.
14. Click **Apply Email/Contacts**.
15. Click **Done**.

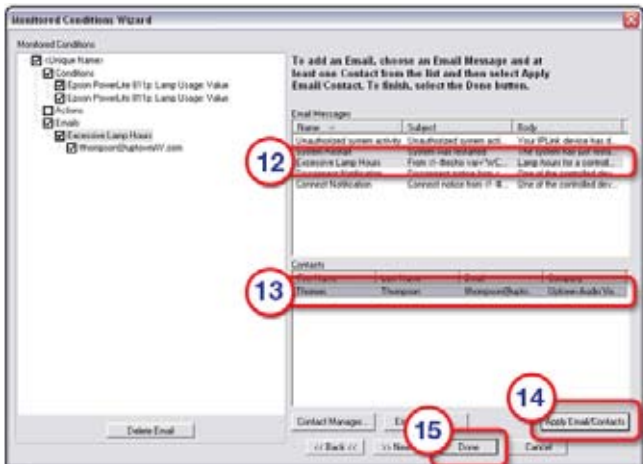

---

## Step fifteen: create a disconnect notification (IP models only)

Global Configurator's monitoring feature enables you to configure IP Link devices such as an MLC 104 IP Plus to monitor many parameters of their connected audio/visual devices. This feature can be used to monitor a display connection and send an alert e-mail to the administrator if a display is unexpectedly disconnected from the network.

To create a display disconnection e-mail alert:

1. Click the **Monitor** tab.
2. Click the **Add Monitor** button.

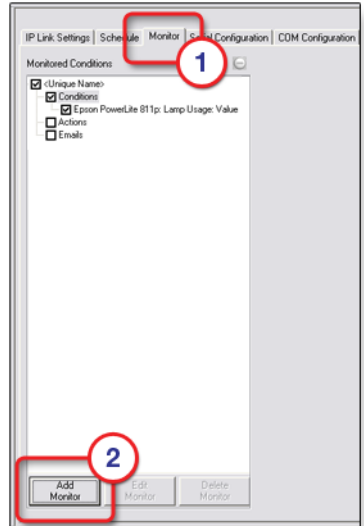

3. Enter a unique name in the Monitored Condition Name field.
4. Click **Next**.

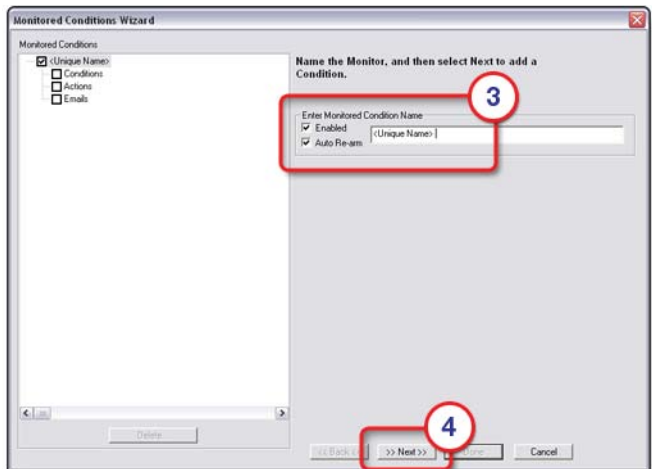

## Software Setup, cont'd

5. Select a subject port or device.
6. Select Available Options **Connection Status: Disconnected**.
7. Click **Apply Condition**.
8. Click **Next**.
9. Click **Next** a second time to add an e-mail notification.

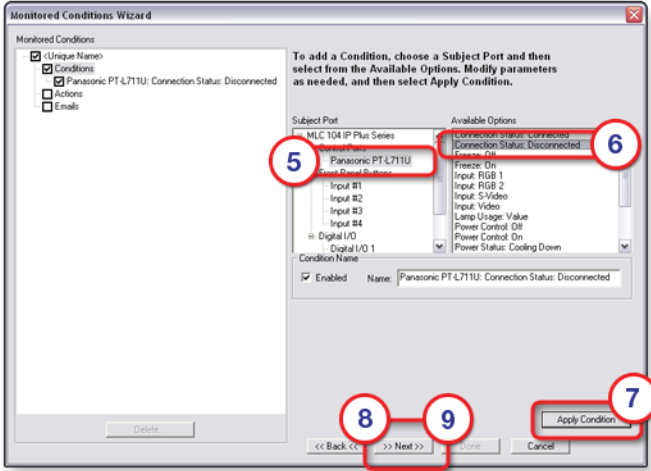

10. Select Email Messages **Disconnect Notification**.
11. Select the desired contacts.
12. Click **Apply Email/Contacts**.
13. Click **Done**.

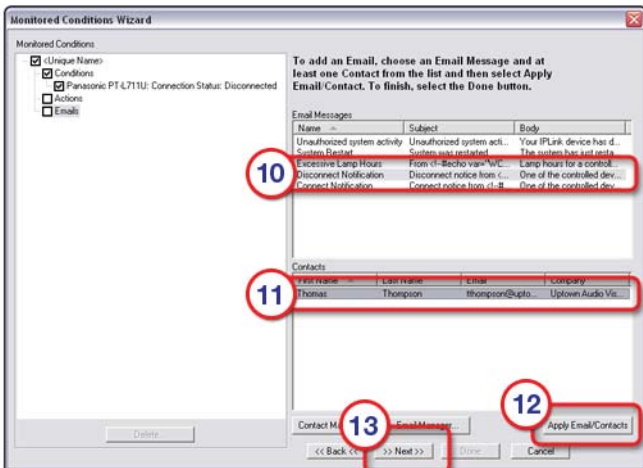

---

## Step sixteen: build the Global Configurator file

Before a Global Configurator (GC) file is active in the GlobalViewer interface, the GC file must be “built” and uploaded to a GlobalViewer host device.

The “build” process compiles all of the configuration data you have entered into the GC file for each A/V network device.

The upload process delivers the built (compiled) file to the GlobalViewer host device.

To initiate a “Build (all)” process:

1. Click **Build > Build All Configurations...** or click the **Build All Configurations** icon.

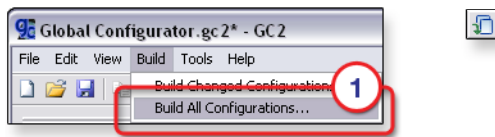

A Please Wait. Building Configuration(s)... dialog box opens and displays a progress bar while the GC file is being built.

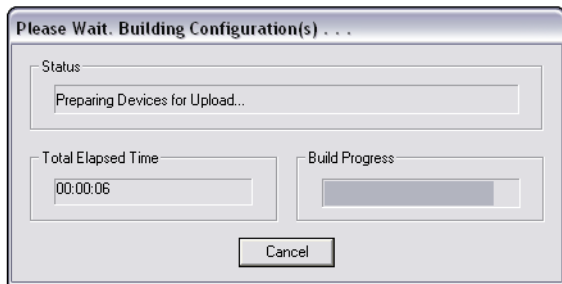

## Software Setup, cont'd

### Step seventeen: upload the Global Configurator file

When the build process completes, the Upload dialog box opens.

1. Click the **Begin** button. When the upload process completes, the Progress and Status fields are updated to indicate completion.
2. *For IP models only*, click the **Test GV System** button to view the GlobalViewer host interface.

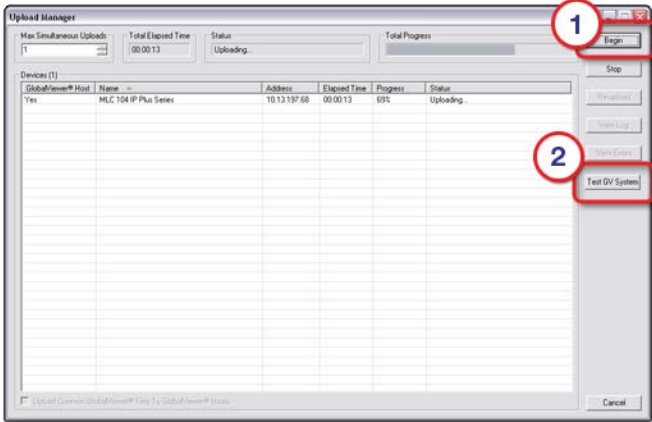



---

## Step eighteen: launch GlobalViewer (IP models only)

GlobalViewer is a graphical user interface that is generated by Global Configurator (GC). When a GC file is built and uploaded to a GlobalViewer host device, you can launch the GlobalViewer interface by opening an Internet browser and entering the host device's IP address in the browser's address field.

Once the GlobalViewer interface is launched, you can monitor and control all of the devices on your audio/video network from the GlobalViewer host device.

To launch GlobalViewer:

1. Open an Internet browser.

**NOTE** *Internet Explorer 6.0 or later with Active X enabled is required.*

2. Enter the IP address of a GlobalViewer host device in the Address field, and press the keyboard's **Enter** key.

**NOTE** *You may also launch the GlobalViewer interface from the Global Configurator Upload Manager screen by clicking the **Test GV System** button.*

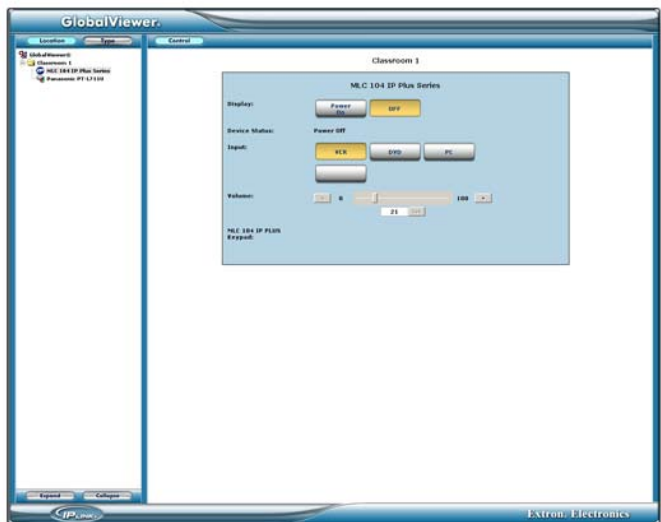

### Testing the GlobalViewer pages

Use the GlobalViewer graphical user interface (IP models only), the MLC's front panel, and, if present, the buttons on an associated control module to test for proper operation of the MLC and any connected devices.

More information on operation and testing of the MLC and its connected devices can found in the *MLC 104 Plus Series User's Manual*, part number 68-1443-01, which can be downloaded from [www.extron.com](http://www.extron.com).

## Extron's Warranty

Extron Electronics warrants this product against defects in materials and workmanship for a period of three years from the date of purchase. In the event of malfunction during the warranty period attributable directly to faulty workmanship and/or materials, Extron Electronics will, at its option, repair or replace said products or components, to whatever extent it shall deem necessary to restore said product to proper operating condition, provided that it is returned within the warranty period, with proof of purchase and description of malfunction to:

**USA, Canada, South America,  
and Central America:**

Extron USA  
1001 East Ball Road  
Anaheim, CA 92805  
U.S.A.

**Europe, Africa, and the Middle East:**

Extron Europe  
Hanzeboulevard 10  
3825 PH Amersfoort  
The Netherlands

**Asia:**

Extron Asia  
135 Joo Seng Road #04-01  
PM Industrial Bldg.  
Singapore 368363  
Singapore

**Japan:**

Extron Japan  
Kyodo Building, 16 Ichibancho  
Chiyoda-ku, Tokyo 102-0082  
Japan

**China:**

Extron China  
686 Ronghua Road  
Songjiang District  
Shanghai 201611  
China

**Middle East:**

Extron Middle East  
Dubai Airport Free Zone  
F12, PO Box 293666  
United Arab Emirates, Dubai

This Limited Warranty does not apply if the fault has been caused by misuse, improper handling care, electrical or mechanical abuse, abnormal operating conditions or non-Extron authorized modification to the product.

*If it has been determined that the product is defective, please call Extron and ask for an Applications Engineer at (714) 491-1500 (USA), 31.33.453.4040 (Europe), 65.6383.4400 (Asia), or 81.3.3511.7655 (Japan) to receive an RA# (Return Authorization number). This will begin the repair process as quickly as possible.*

Units must be returned insured, with shipping charges prepaid. If not insured, you assume the risk of loss or damage during shipment. Returned units must include the serial number and a description of the problem, as well as the name of the person to contact in case there are any questions.

Extron Electronics makes no further warranties either expressed or implied with respect to the product and its quality, performance, merchantability, or fitness for any particular use. In no event will Extron Electronics be liable for direct, indirect, or consequential damages resulting from any defect in this product even if Extron Electronics has been advised of such damage.

Please note that laws vary from state to state and country to country, and that some provisions of this warranty may not apply to you.

# Setup Guide Checklist

- Chapter 1:** Install Global Configurator
  - Download from [www.extron.com](http://www.extron.com), or
  - Install from Extron Software Products CD
- Chapter 2:** Make the MLC cable connections.
  1.  Power
  2.  Local Area Network (LAN) – *IP models only*
  3.  Devices
- Chapter 3:** Configure MLC 104 Plus Series using Global Configurator.
  1.  Download device drivers.
  2.  Create a new Global Configurator project file.
  3.  Add a device and (for IP models) set its IP address.
  4.  Define the location of the new device.
  5.  Save the new Global Configurator file.
  6.  Configure e-mail server. (*IP models only*)
  7.  Configure e-mail messages. (*IP models only*)
  8.  Configure contacts. (*IP models only*)
  9.  Assign serial device drivers.
  10.  Assign IR drivers.
  11.  Configure the front panel.
  12.  Configure associated control modules.
  13.  Create a shutdown schedule.
  14.  Create a lamp hour notification. (*IP models only*)
  15.  Create a disconnect notice. (*IP models only*)
  16.  Build the Global Configurator file.
  17.  Upload the Global Configurator file.
  18.  Launch GlobalViewer. (*IP models only*)
  19.  Test the MLC's setup.

**Extron USA - West**  
Headquarters  
+800.633.9976  
Inside USA / Canada Only  
+1.714.491.1500  
+1.714.491.1517 FAX

**Extron USA - East**  
+800.633.9876  
Inside USA / Canada Only  
+1.919.863.1794  
+1.919.863.1797 FAX

**Extron Europe**  
+800.3987.6673  
Inside Europe Only  
+31.33.453.4040  
+31.33.453.4050 FAX

**Extron Asia**  
+800.7339.8766  
Inside Asia Only  
+65.6383.4400  
+65.6383.4664 FAX

**Extron Japan**  
+81.3.3511.7655  
+81.3.3511.7656 FAX

**Extron China**  
+400.883.1568  
Inside China Only  
+86.21.3760.1568  
+86.21.3760.1566 FAX

**Extron Middle East**  
+971.4.2991800  
+971.4.2991880 FAX