

# CET CEA6200 Transistor Datasheet

<http://www.manuallib.com/cet/cea6200-transistor-datasheet.html>

## FEATURES

60V, 1.8A, RDS(ON) = 250mW @VGS = 10V.

RDS(ON) = 330mW @VGS = 4.5V.

High dense cell design for extremely low RDS(ON).

Rugged and reliable.

SOT-89 package.

ManualLib.com collects and classifies the global product instruction manuals to help users access anytime and anywhere, helping users make better use of products.

<http://www.manuallib.com>

## N-Channel Enhancement Mode Field Effect Transistor

PRELIMINARY

### FEATURES

- 60V, 1.8A,  $R_{DS(ON)} = 250m\Omega$  @ $V_{GS} = 10V$ .  
 $R_{DS(ON)} = 330m\Omega$  @ $V_{GS} = 4.5V$ .
- High dense cell design for extremely low  $R_{DS(ON)}$ .
- Rugged and reliable.
- Lead free product is acquired.
- SOT-89 package.

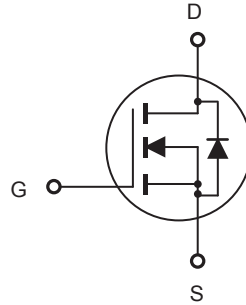
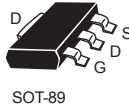

### ABSOLUTE MAXIMUM RATINGS $T_A = 25^\circ C$ unless otherwise noted

Parameter	Symbol	Limit	Units
Drain-Source Voltage	$V_{DS}$	60	V
Gate-Source Voltage	$V_{GS}$	$\pm 20$	V
Drain Current-Continuous	$I_D$	1.8	A
Drain Current-Pulsed <sup>a</sup>	$I_{DM}$	7.2	A
Maximum Power Dissipation	$P_D$	1.3	W
Operating and Store Temperature Range	$T_J, T_{stg}$	-55 to 150	$^\circ C$

### Thermal Characteristics

Parameter	Symbol	Limit	Units
Thermal Resistance, Junction-to-Ambient <sup>b</sup>	$R_{\theta JA}$	100	$^\circ C/W$

This is preliminary information on a new product in development now .  
Details are subject to change without notice .

Rev 1. 2007.June  
<http://www.cetsemi.com>



# CEA6200

## Electrical Characteristics $T_A = 25^\circ\text{C}$ unless otherwise noted

Parameter	Symbol	Test Condition	Min	Typ	Max	Units
<b>Off Characteristics</b>						
Drain-Source Breakdown Voltage	$BV_{DSS}$	$V_{GS} = 0V, I_D = 250\mu A$	60			V
Zero Gate Voltage Drain Current	$I_{DSS}$	$V_{DS} = 60V, V_{GS} = 0V$			1	$\mu A$
Gate Body Leakage Current, Forward	$I_{GSSF}$	$V_{GS} = 20V, V_{DS} = 0V$			100	nA
Gate Body Leakage Current, Reverse	$I_{GSSR}$	$V_{GS} = -20V, V_{DS} = 0V$			-100	nA
<b>On Characteristics</b>						
Gate Threshold Voltage	$V_{GS(th)}$	$V_{GS} = V_{DS}, I_D = 250\mu A$	1		3	V
Static Drain-Source On-Resistance	$R_{DS(on)}$	$V_{GS} = 10V, I_D = 1.8A$		190	250	$m\Omega$
		$V_{GS} = 4.5V, I_D = 1.4A$		250	330	$m\Omega$
<b>Dynamic Characteristics <sup>d</sup></b>						
Input Capacitance	$C_{iss}$	$V_{DS} = 25V, V_{GS} = 0V, f = 1.0\text{ MHz}$		230		pF
Output Capacitance	$C_{oss}$			45		pF
Reverse Transfer Capacitance	$C_{rss}$			25		pF
<b>Switching Characteristics <sup>d</sup></b>						
Turn-On Delay Time	$t_{d(on)}$	$V_{DD} = 27.5V, I_D = 1.8A, V_{GS} = 10V, R_{GEN} = 3\Omega$		8	16	ns
Turn-On Rise Time	$t_r$			2.4	4.8	ns
Turn-Off Delay Time	$t_{d(off)}$			16.7	33.4	ns
Turn-Off Fall Time	$t_f$			1.6	3.2	ns
Total Gate Charge	$Q_g$	$V_{DS} = 27.5V, I_D = 1.8A, V_{GS} = 4.5V$		2.4	3.2	nC
Gate-Source Charge	$Q_{gs}$			0.8		nC
Gate-Drain Charge	$Q_{gd}$			1.1		nC
<b>Drain-Source Diode Characteristics and Maximum Ratings</b>						
Drain-Source Diode Forward Current <sup>b</sup>	$I_S$				1.8	A
Drain-Source Diode Forward Voltage <sup>c</sup>	$V_{SD}$	$V_{GS} = 0V, I_S = 1.8A$			1.2	V
<b>Notes :</b> <input type="checkbox"/> a. Repetitive Rating : Pulse width limited by maximum junction temperature. <input type="checkbox"/> b. Surface Mounted on FR4 Board, $t \leq 10\text{ sec}$ . <input type="checkbox"/> c. Pulse Test : Pulse Width $\leq 300\mu s$ , Duty Cycle $\leq 2\%$ . <input type="checkbox"/> d. Guaranteed by design, not subject to production testing. <input type="checkbox"/> <input type="checkbox"/>						



# CEA6200

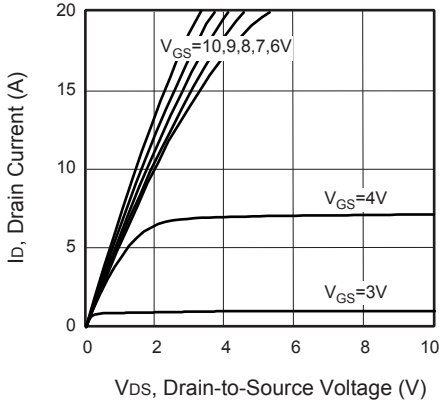

**Figure 1. Output Characteristics**

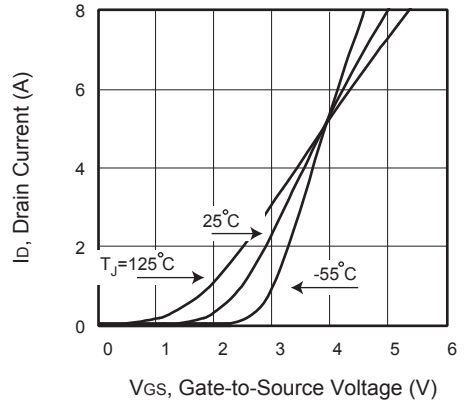

**Figure 2. Transfer Characteristics**

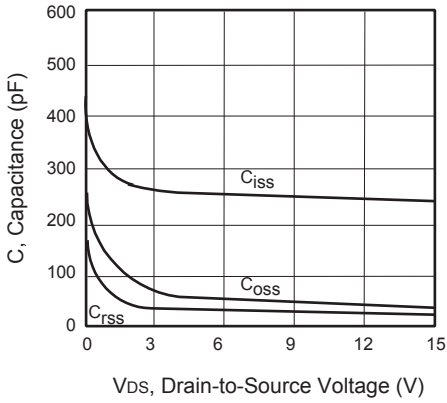

**Figure 3. Capacitance**

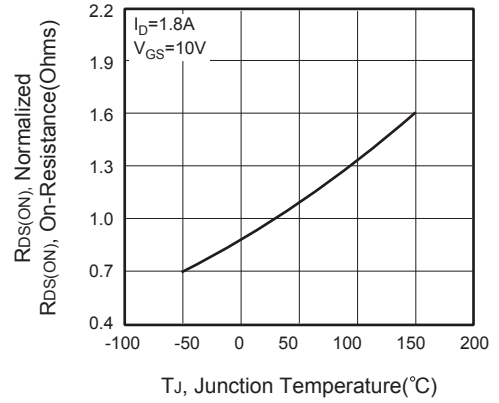

**Figure 4. On-Resistance Variation with Temperature**

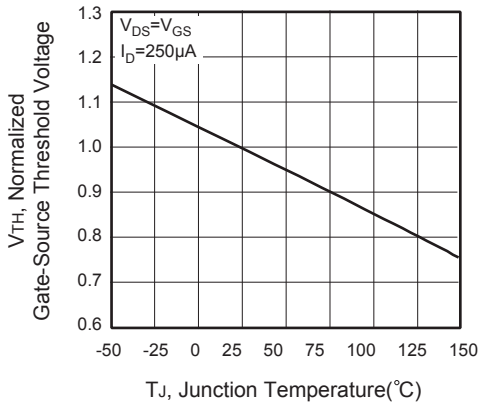

**Figure 5. Gate Threshold Variation with Temperature**

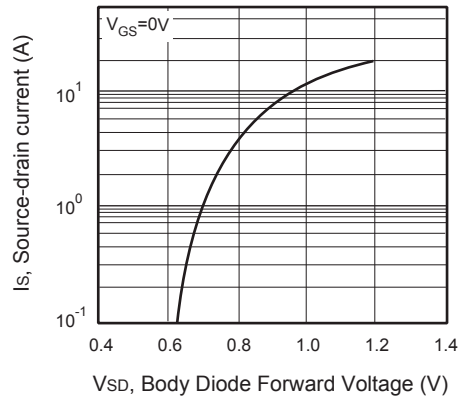

**Figure 6. Body Diode Forward Voltage Variation with Source Current**

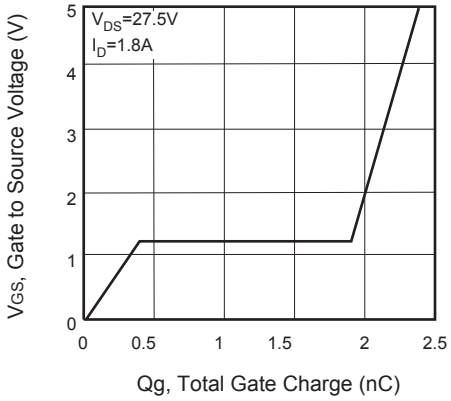

Figure 7. Gate Charge

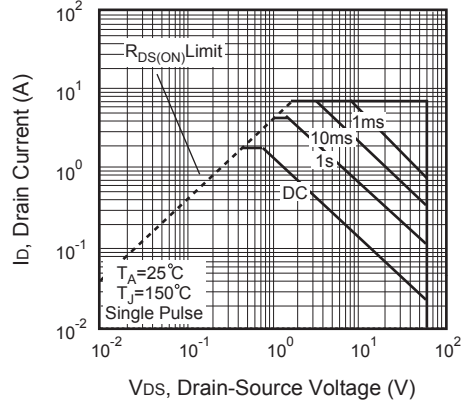

Figure 8. Maximum Safe Operating Area

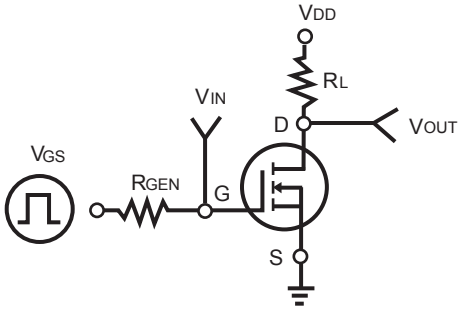

Figure 9. Switching Test Circuit

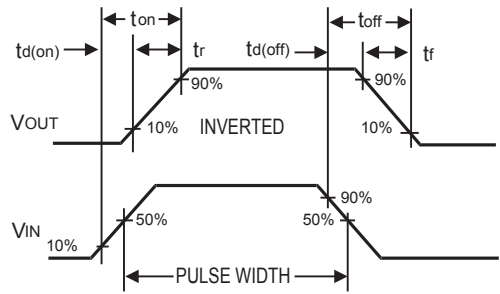

Figure 10. Switching Waveforms

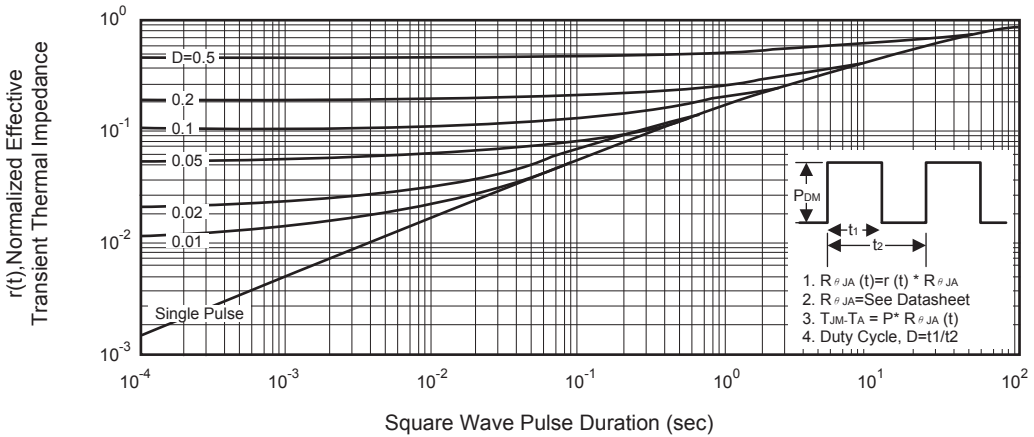

Figure 11. Normalized Thermal Transient Impedance Curve