

# ARCH ANCN Power Datasheet

<http://www.manuallib.com/arch/ancn-power-datasheet.html>

## KEY FEATURES

Switching Power Module for PCB Mountable

Fully Encapsulated Plastic Case

Universal Input Range 90-264VAC

<0.3W No Load Input Power

High Average Efficiency (25%, 50%, 75%, 100% Load Points)

Screw Terminal For Optional

Isolation Class II

Isolation 4KV AC

CE, UL, Approval

3-Years Product Warranty

ManualLib.com collects and classifies the global product instruction manuals to help users access anytime and anywhere, helping users make better use of products.

<http://www.manuallib.com>

## KEY FEATURES

- Switching Power Module for PCB Mountable
- Fully Encapsulated Plastic Case
- Universal Input Range 90-264VAC
- <0.3W No Load Input Power
- High Average Efficiency (25%, 50%, 75%, 100% Load Points)
- Screw Terminal For Optional
- Isolation Class II
- Isolation 4KV AC
- CE, UL, Approval
- 3-Years Product Warranty



## ELECTRICAL SPECIFICATIONS

Model No. ( Single Output )	ANCN-5S	ANCN-12S	ANCN-15S	ANCN-24S	
Max Output Wattage (W)	15W				
Input	Voltage	90-264 VAC or 120-370 VDC			
	Frequency (Hz)	50 / 60 Hz			
	Current (Full load)	315 mA max. (115 VAC) / 195 mA max. (230 VAC)			
	Inrush Current	15 A max. (115 VAC) / 30 A max. (230 VAC) (cold start)			
	Leakage Current	0.25 mA max. (at <240 VAC)			
	External Fuse (recommend)	1.5 A slow blow type			
Output	Voltage (V.DC.)	5V	12V	15V	24V
	Voltage Accuracy	±2%			
	Current (mA) max	3000	1250	1000	625
	Line Regulation (LL-HL) (typ.)	±0.5%			
	Load Regulation (10-100%) (typ.)	±1%			
	Maximum Capacitive Load (at 100-240 VAC)	1100uF	200uF	200uF	47uF
	Ripple & Noise (typ.)	100mV (Vp-p)	120mV (Vp-p)	200mV (Vp-p)	240mV (Vp-p)
	Efficiency (at 230 VAC)	78%	82%	81%	82%
Protection	Over Power Protection	Hiccup technique, auto-recovery			
	Over Voltage Protection	Zener diode clamp			
	Short Circuit Protection	Hiccup mode, indefinite (automatic recovery)			
Isolation	Input-Output (V.AC)	4000V			
Environment	Operating Temperature	-40°C...+70°C (with derating)			
	Storage Temperature	-40°C...+85°C			
	Temperature Coefficient	±0.02%/°C			
	Humidity	95% RH			
	MTBF	>300,000 h @ 25°C (MIL-HDBK-217F)			
Physical	Dimension (L x W x H)	2.91 x 2.13 x 0.87 Inches ( 74.0 x 54.0 x 22.0 mm ) Tolerance ±0.5 mm			
	Case Material	Plastic resin with Fiberglass (flammability to UL 94V-0)			
	Weight	114 g			
	Cooling Method	Free air convection			
Safety	Agency Approvals	UL/cUL, CE			
EMC	EMI (Conducted & Radiated Emission)	EN 55022 class B			
	EMS (Noise Immunity)	EN 55024			

1.All specifications valid at normal input voltage, full load and +25°C after warm-up time unless otherwise stated.

2.Ripple & Noise are measured at 20MHz of bandwidth with 0.1UF & 47UF parallel capacitor.

**MECHANICAL DIMENSION ( Top View )**

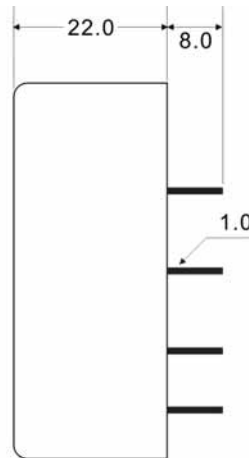
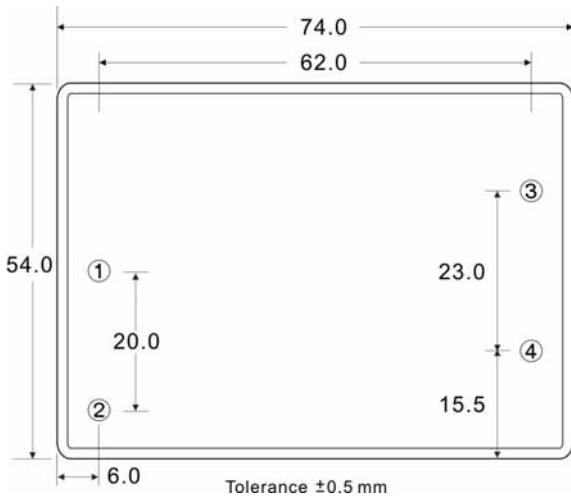

PIN#	SINGLE
1	AC IN (N)
2	AC IN (L)
3	-DC OUT
4	+DC OUT

**DERATING**

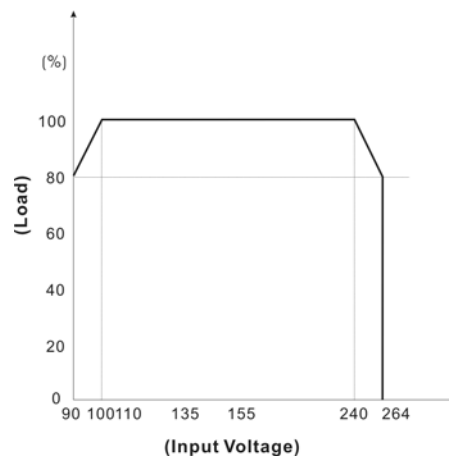
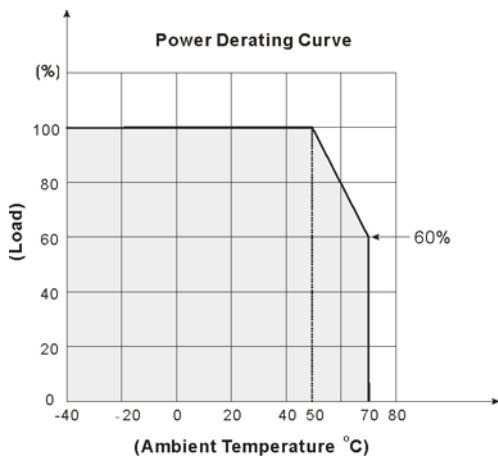

**BLOCK DIAGRAM**

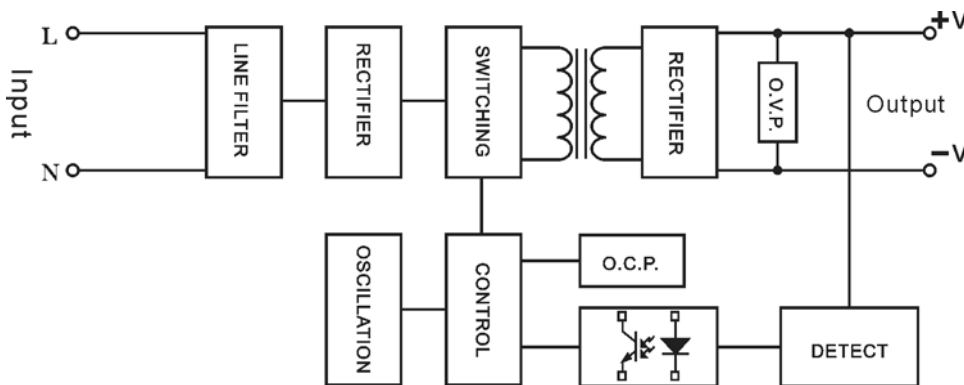

## SCREW TERMINAL

## ANCN-A2



PIN#	Single
1	NO CONNECT
2	AC IN (N)
3	AC IN (L)
4	NO CONNECT
5	-DC OUT
6	NO CONNECT
7	+DC OUT
8	NO CONNECT

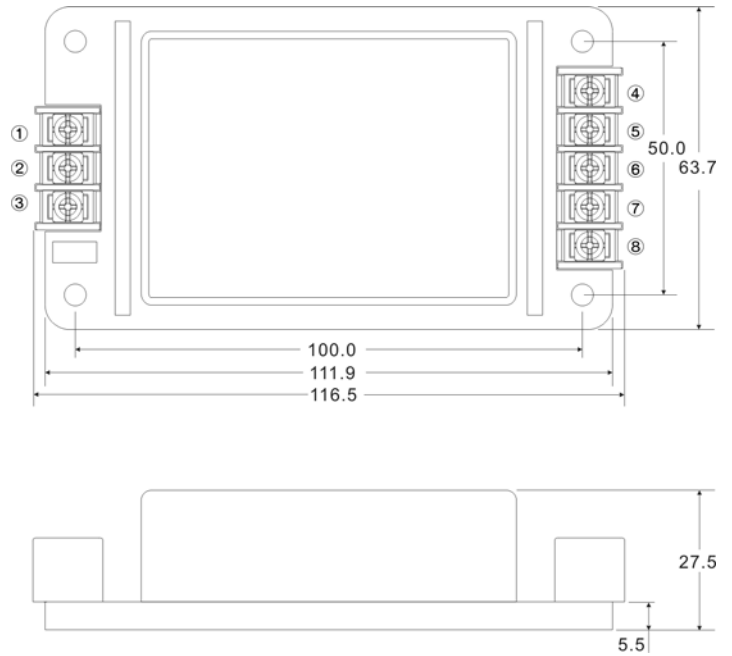

## ANCN-A5



PIN#	Single
1	NO CONNECT
2	AC IN (N)
3	AC IN (L)
4	NO CONNECT
5	-DC OUT
6	NO CONNECT
7	+DC OUT
8	NO CONNECT

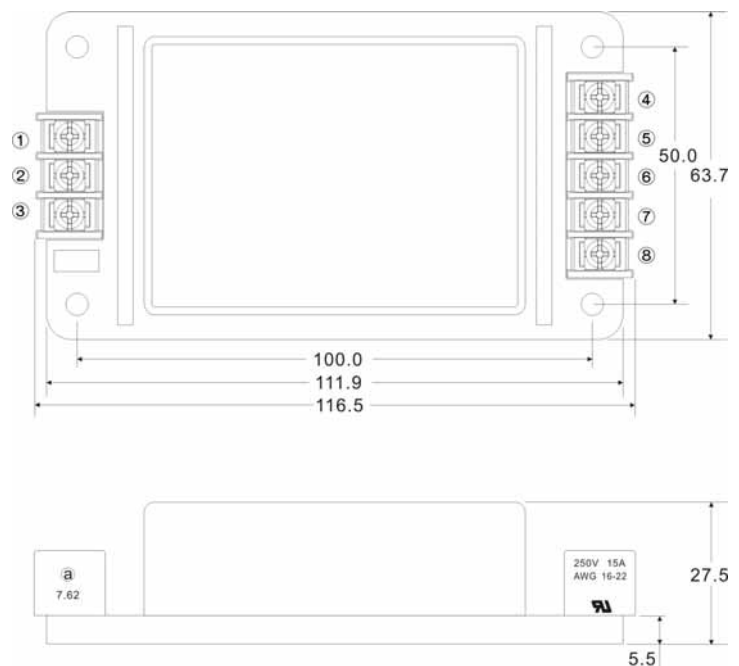

**EFFICIENCY VERSUS LOAD**
**ANCN-5S**
**VIN VS Efficiency**

Input Voltage (V)	90	115	180	230	264
Efficiency (%)	77.0	79.8	80.8	80.1	79.8

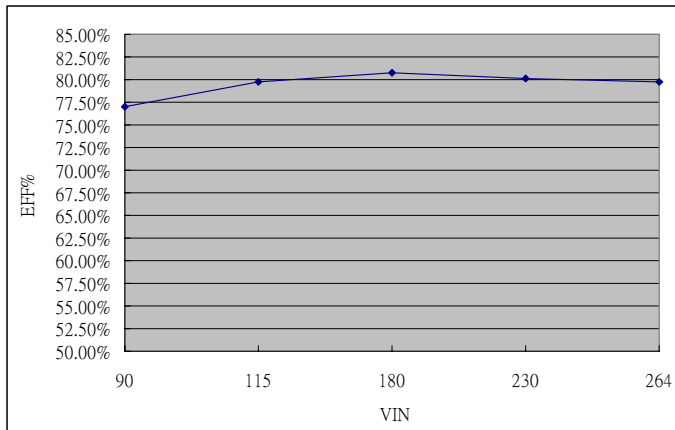
**LOAD VS Efficiency**

Load (%)	10	20	30	40	50
115V (%)	80.0	84.2	81.9	81.4	82.7
230V (%)	75.1	78.8	79.6	79.9	80.8
Load (%)	60	70	80	90	100
115V (%)	82.1	80.9	80.3	80.2	79.4
230V (%)	81.1	79.7	81.4	80.1	79.3

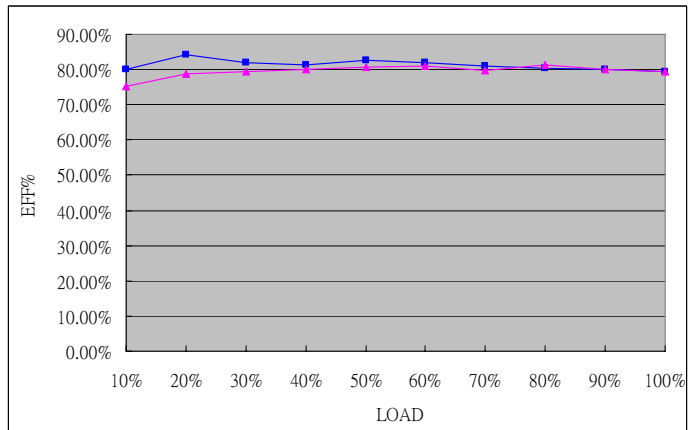
**ANCN-12S**
**VIN VS Efficiency**

Input Voltage (V)	90	115	180	230	264
Efficiency (%)	80.5	82.4	83.7	84.6	83.3

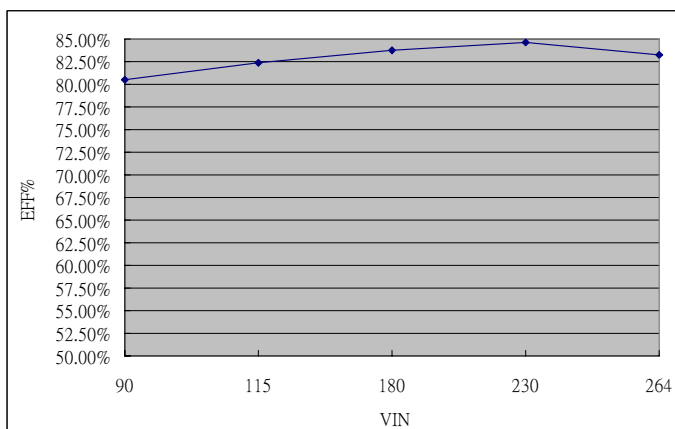

**LOAD VS Efficiency**

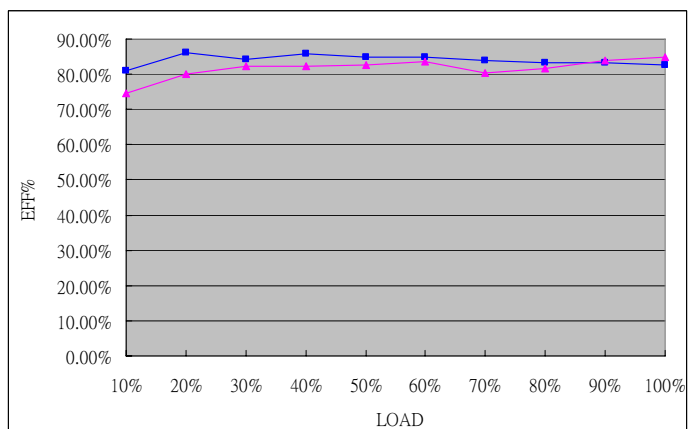
Load (%)	10	20	30	40	50
115V (%)	81.1	86.1	84.2	85.9	85.0
230V (%)	74.5	80.0	82.4	82.3	82.6
Load (%)	60	70	80	90	100
115V (%)	85.0	83.9	83.1	83.3	82.6
230V (%)	83.6	80.2	81.7	83.8	84.8

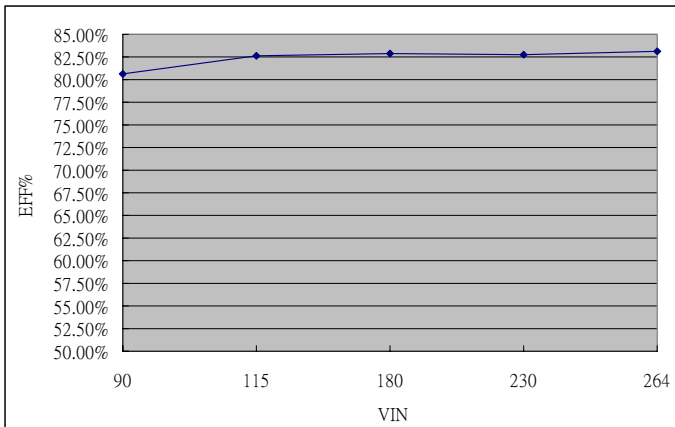

**EFFICIENCY VERSUS LOAD**
**ANCN-15S**
**VIN VS Efficiency**

Input Voltage (V)	90	115	180	230	264
Efficiency (%)	80.6	82.6	82.9	82.7	83.1

**LOAD VS Efficiency**

Load (%)	10	20	30	40	50
115V (%)	85.9	83.3	85.7	84.7	85.4
230V (%)	74.0	78.5	79.9	81.7	82.3
Load (%)	60	70	80	90	100
115V (%)	83.4	84.5	85.1	84.6	83.2
230V (%)	81.7	84.0	84.3	84.0	82.6

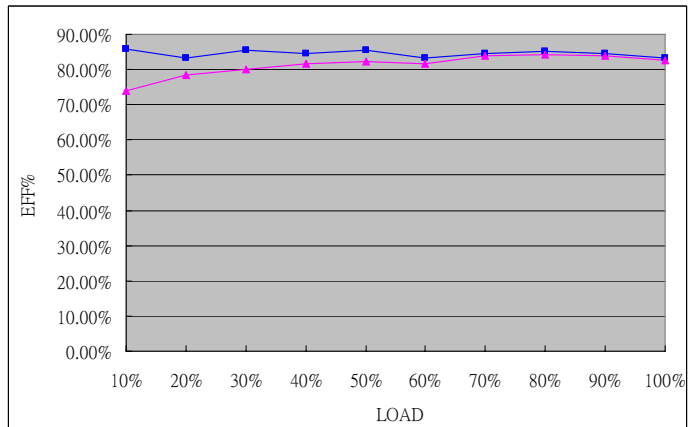
**ANCN-24S**
**VIN VS Efficiency**

Input Voltage (V)	90	115	180	230	264
Efficiency (%)	79.9	82.3	84.9	85.8	84.2

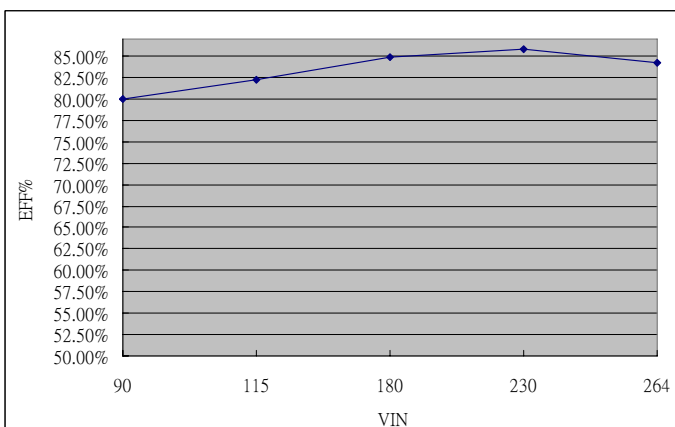
**LOAD VS Efficiency**

Load (%)	10	20	30	40	50
115V (%)	79.5	86.3	84.6	86.5	85.4
230V (%)	70.1	80.0	79.5	80.7	81.7
Load (%)	60	70	80	90	100
115V (%)	87.3	84.6	83.8	83.0	82.7
230V (%)	83.2	80.0	81.6	83.7	86.3

